

# Panasonic®

## Basic Owner's Manual

Digital Camera/  
Lens Kit/Body

Model No. **DMC-GF5X/DMC-GF5K**  
**DMC-GF5**



Before connecting, operating or adjusting this product, please read the instructions completely.



More detailed instructions on the operation of this camera are contained in "Owner's Manual for advanced features (PDF format)" in the supplied CD-ROM. Install it on your PC to read it.



For USA and Puerto Rico assistance, please call: 1-800-211-PANA(7262) or, contact us via the web at: <http://www.panasonic.com/contactinfo>

**Dear Customer,**

**Thank you for choosing Panasonic!**

You have purchased one of the most sophisticated and reliable products on the market today. Used properly, we're sure it will bring you and your family years of enjoyment. Please take time to fill in the information on the below. The serial number is on the tag located on the underside of your camera. Be sure to **retain this manual** as your convenient camera information source.

Date of Purchase	Dealer Phone No.
Dealer Purchased From	Model No.
Dealer Address	Serial No.

Please note that the actual controls and components, menu items, etc. of your Digital Camera may look somewhat different from those shown in the illustrations in this Owner's Manual.

**Carefully observe copyright laws.**

- Recording of pre-recorded tapes or discs or other published or broadcast material for purposes other than your own private use may infringe copyright laws. Even for the purpose of private use, recording of certain material may be restricted.



A lithium ion battery that is recyclable powers the product you have purchased. Please call 1-800-8-BATTERY for information on how to recycle this battery.

## Information for Your Safety

### **WARNING:**

To reduce the risk of fire, electric shock or product damage,

- Do not expose this unit to rain, moisture, dripping or splashing.
- Use only the recommended accessories.
- Do not remove covers.
- Do not repair this unit by yourself. Refer servicing to qualified service personnel.

The socket outlet shall be installed near the equipment and shall be easily accessible.

## ■ Product identification marking

Product	Location
Digital Camera	Bottom
Battery charger	Bottom

### THE FOLLOWING APPLIES ONLY IN THE U.S.A.

#### **FCC Note:**

This equipment has been tested and found to comply with the limits for a Class B digital device, pursuant to Part 15 of the FCC Rules. These limits are designed to provide reasonable protection against harmful interference in a residential installation. This equipment generates, uses, and can radiate radio frequency energy and, if not installed and used in accordance with the instructions, may cause harmful interference to radio communications. However, there is no guarantee that interference will not occur in a particular installation. If this equipment does cause harmful interference to radio or television reception, which can be determined by turning the equipment off and on, the user is encouraged to try to correct the interference by one or more of the following measures:

- Reorient or relocate the receiving antenna.
- Increase the separation between the equipment and receiver.
- Connect the equipment into an outlet on a circuit different from that to which the receiver is connected.
- Consult the dealer or an experienced radio/TV technician for help.

**FCC Caution:** To assure continued compliance, follow the attached installation instructions and use only shielded interface cables with ferrite core when connecting to computer or peripheral devices.

Any changes or modifications not expressly approved by the party responsible for compliance could void the user's authority to operate this equipment.

#### **Declaration of Conformity**

Trade Name: Panasonic

Model No.: DMC-GF5

Responsible party: Panasonic Corporation of North America

One Panasonic Way, Secaucus, NJ 07094

Support Contact: Panasonic Consumer Marketing Company of North America  
1-800-211-PANA (7262)

This device complies with Part 15 of the FCC Rules. Operation is subject to the following two conditions: (1) This device may not cause harmful interference, and (2) this device must accept any interference received, including interference that may cause undesired operation.



## ■ About the battery pack

### CAUTION

Battery pack (Lithium ion battery pack)

- Use the specified unit to recharge the battery pack.
- Do not use the battery pack with equipment other than the specified unit.
- Do not get dirt, sand, liquids, or other foreign matter on the terminals.
- Do not touch the plug terminals (+ and -) with metal objects.
- Do not disassemble, remodel, heat or throw into fire.

If any electrolyte should come into contact with your hands or clothes, wash it off thoroughly with water.

If any electrolyte should come into contact with your eyes, never rub the eyes. Rinse eyes thoroughly with water, and then consult a doctor.

### CAUTION

- Danger of explosion if battery is incorrectly replaced. Replace only with the type recommended by the manufacturer.
- When disposing the batteries, please contact your local authorities or dealer and ask for the correct method of disposal.

- Do not heat or expose to flame.
- Do not leave the battery(ies) in a car exposed to direct sunlight for a long period of time with doors and windows closed.

### Warning

Risk of fire, explosion and burns. Do not disassemble, heat above 60 °C (140 °F) or incinerate.

## ■ About the battery charger

### CAUTION!

To reduce the risk of fire, electric shock or product damage,

- Do not install or place this unit in a bookcase, built-in cabinet or in another confined space. Ensure this unit is well ventilated.

### Battery charger

This battery charger operates on AC between 110 V and 240 V.

But

- In the U.S.A. and Canada, the battery charger must be connected to a 120 V AC power supply only.
- When connecting to an AC supply outside of the U.S.A. or Canada, use a plug adaptor to suit the AC outlet configuration.

## ■ Cautions for Use

- Do not use any other USB connection cables except the supplied one.
- Always use a genuine Panasonic HDMI mini cable (RP-CDHM15, RP-CDHM30: optional).  
Part numbers: RP-CDHM15 (1.5 m) (5 feet), RP-CDHM30 (3.0 m) (10 feet)
- Always use a genuine Panasonic AV cable (DMW-AVC1: optional).

### **Keep this unit as far away as possible from electromagnetic equipment (such as microwave ovens, TVs, video games etc.).**

- If you use this unit on top of or near a TV, the pictures and/or sound on this unit may be disrupted by electromagnetic wave radiation.
- Do not use this unit near cell phones because doing so may result in noise adversely affecting the pictures and/or sound.
- Recorded data may be damaged, or pictures may be distorted, by strong magnetic fields created by speakers or large motors.
- Electromagnetic wave radiation generated by microprocessors may adversely affect this unit, disturbing the pictures and/or sound.
- If this unit is adversely affected by electromagnetic equipment and stops functioning properly, turn this unit off and remove the battery or disconnect AC adaptor (DMW-AC8PP: optional). Then reinsert the battery or reconnect AC adaptor and turn this unit on.

### **Do not use this unit near radio transmitters or high-voltage lines.**

- If you record near radio transmitters or high-voltage lines, the recorded pictures and/or sound may be adversely affected.

Information about the software used by this product can be viewed by pressing [MENU/SET], selecting [Setup] → [Version Disp.], and then pressing [MENU/SET].

## **-If you see this symbol-**

### **Information on Disposal in other Countries outside the European Union**

This symbol is only valid in the European Union.

If you wish to discard this product, please contact your local authorities or dealer and ask for the correct method of disposal.



# Contents

Information for Your Safety .....	2
Care of the camera .....	7
Standard Accessories .....	8
Names and Functions of Components .....	10
Changing the Lens .....	13
Attaching the Shoulder Strap .....	14
Charging the Battery .....	15
• Charging .....	15
Inserting and Removing the Card (optional)/the Battery .....	16
About the Card .....	17
• About cards that can be used with this unit .....	17
Setting Date/Time (Clock Set) .....	18
• Changing the Clock Setting .....	18
Selecting the Recording Mode .....	19
Taking a Still picture .....	20
• Taking pictures using the Touch Shutter function .....	20
Taking Pictures using the Automatic Function (Intelligent Auto Mode) .....	21
Easily adjust and record (Intelligent Auto Plus Mode) .....	22
Taking Pictures with Defocus Control Function .....	23
Recording Motion Picture .....	24
• Recording still pictures while recording motion pictures .....	24
Compensating the Exposure .....	25
Using the function button .....	26
Taking Pictures that match the Scene being recorded (Scene Guide Mode) .....	27
Taking Pictures with different image effects (Creative Control Mode) .....	28
Playing Back Pictures/Motion Pictures .....	29
• Playing Back Pictures .....	29
• Playing Back Motion Pictures .....	30
Deleting Pictures .....	31
Switching the display of the LCD Monitor .....	32
Setting the Menu .....	33
Setting the Quick Menu .....	34
Types of menus .....	35
Reading the Owner's Manual (PDF format) .....	40
About the supplied software .....	41
• Installing supplied software .....	42
Specifications .....	43
Digital Camera Accessory System .....	49
Digital Camera Accessory Order Form (For USA and Puerto Rico Customers) .....	51
Limited Warranty (ONLY FOR U.S.A. AND PUERTO RICO) .....	52
Useful Information .....	55

## Care of the camera

### **Do not subject to strong vibration, shock, or pressure.**

- The lens, LCD monitor, or external case may be damaged if used in the following conditions.

It may also malfunction or image may not record if you:

- Drop or hit the camera.
- Press hard on the lens or the LCD monitor.

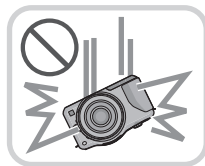

### **This camera is not dust/drip/water proof.**

#### **Avoid using the camera in places with a lot of dust, water, sand, etc.**

- Liquid, sand and other foreign material may get into the space around the lens, buttons, etc. Be particularly careful since it may not just cause malfunctions, but it may also become irreparable.
  - Places with a lot of sand or dust.
  - Places where water can come into contact with this unit, such as when using it on a rainy day or at the beach.



#### **Do not place your hands inside the mount of the digital camera body. Since the sensor unit is a precision apparatus, it may cause a malfunction or damage.**



### **■ About Condensation (When the lens or the LCD monitor is fogged up)**

- Condensation occurs when the ambient temperature or humidity changes. Be careful of condensation since it causes lens and LCD monitor stains, fungus and camera malfunction.
- If condensation occurs, turn the camera off and leave it for about 2 hours. The fog will disappear naturally when the temperature of the camera becomes close to the ambient temperature.

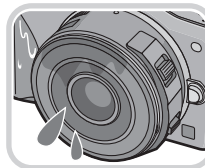

## Standard Accessories

Check that all the accessories are supplied before using the camera.  
Product numbers correct as of April 2012. These may be subject to change.

- 1 Digital Camera Body  
(This is referred to as **camera body** in this Owner's Manual.)
- 2 Interchangeable Lens  
"LUMIX G X VARIO PZ 14–42 mm/F3.5–5.6 ASPH./POWER O.I.S."  
(This is referred to as **lens** in this Owner's Manual. This is attached to the camera body at the time of purchase.)
- 3 Lens Cap  
(This is attached to the interchangeable lens at the time of purchase.)
- 4 Interchangeable Lens  
"LUMIX G VARIO 14–42 mm/F3.5–5.6 ASPH./MEGA O.I.S."  
(This is referred to as **lens** in this Owner's Manual.)
- 5 Lens Hood
- 6 Lens Cap  
(This is attached to the interchangeable lens at the time of purchase.)
- 7 Lens Rear Cap  
(This is attached to the interchangeable lens at the time of purchase.)
- 8 Body Cap  
(This is attached to the camera body at the time of purchase.)
- 9 Battery Pack  
(Indicated as **battery pack** or **battery** in the text)  
Charge the battery before use.
- 10 Battery Charger  
(Indicated as **battery charger** or **charger** in the text)
- 11 USB Connection Cable
- 12 CD-ROM
  - Software:  
Use it to install the software to your PC.
- 13 CD-ROM
  - Owner's Manual for advanced features:  
Use it to install to your PC.
- 14 Shoulder Strap

- SD Memory Card, SDHC Memory Card and SDXC Memory Card are indicated as **card** in the text.
- **The card is optional.**
- Description in this owner's manual is based on the interchangeable lens (H-PS14042).
- If any accessories are lost, customers in the USA and Puerto Rico should contact Panasonic's parts department at 1-800-833-9626 for further information about obtaining replacement parts.



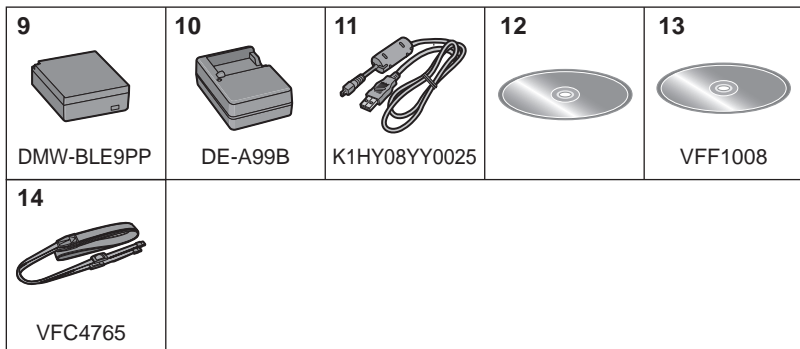
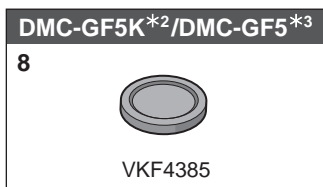
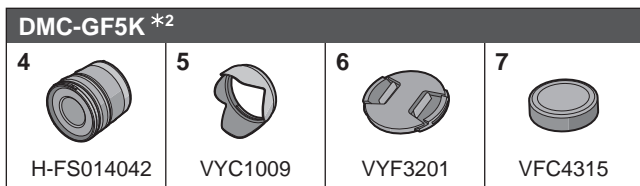
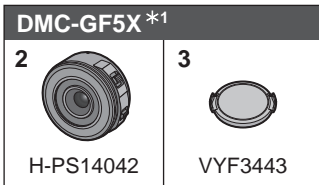
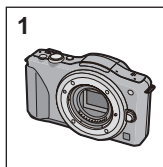

\*1 Supplied in DMC-GF5X only

\*2 Supplied in DMC-GF5K only

\*3 Supplied in DMC-GF5 only

# Names and Functions of Components

## ■ Camera body

- 1 Sensor
- 2 Flash
- 3 Self-timer indicator/  
AF Assist Lamp
- 4 Lens fitting mark
- 5 Mount
- 6 Lens lock pin
- 7 Lens release button

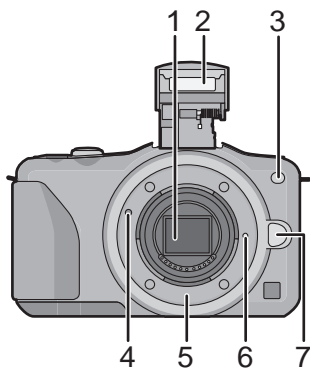

- 8 Flash open button
- 9 Touch screen/LCD monitor
- 10 Playback button
- 11 [Q.MENU/Fn1] button/  
Delete/Return button
- 12 [MENU/SET] button
- 13 Control dial
- 14 Cursor buttons

▲/Exposure Compensation button

▶/WB (White Balance)

◀/AF Mode button

▼/[Drive Mode] button

This button in picture record mode will allow the user to select between the following options.

Single/Burst/Auto bracket/Self-timer

- 15 [DISP.] button

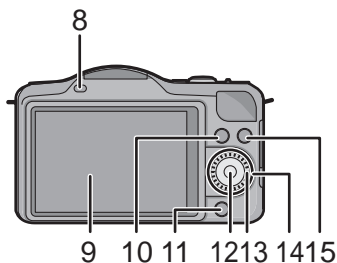

- 16 Shoulder strap eyelet
- Be sure to attach the shoulder strap when using the camera to ensure that you will not drop it.
- 17 [HDMI] socket
- 18 [AV OUT/DIGITAL] socket

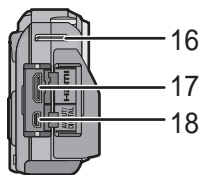

- 19 Stereo microphone
- Be careful not to cover the microphone with your finger. Doing so may make it difficult to record sound.
- 20 Shutter button
- 21 Motion picture button
- 22 Speaker
- Be careful not to cover the speaker with your finger. Doing so may make it difficult to hear sound.
- 23 Focus distance reference mark

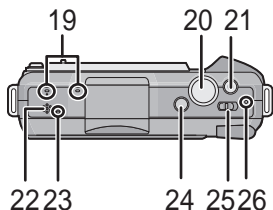

- 24 Intelligent Auto button
- 25 Camera ON/OFF switch
- 26 Status indicator
- 27 Tripod receptacle
- 28 Card/Battery door
- 29 DC coupler cover

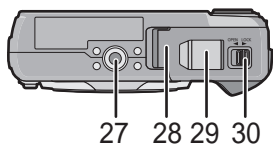

- When using an AC adaptor, ensure that the Panasonic DC coupler (DMW-DCC11: optional) and AC adaptor (DMW-AC8PP: optional) are used. Do not attempt to use the AC adaptor in other devices.
  - Always use a genuine Panasonic AC adaptor (DMW-AC8PP: optional).
  - It is recommended to use a fully charged battery or AC adaptor when recording motion pictures.
  - If while recording motion pictures using the AC adaptor and the power supply is cut off due to a power outage or if the AC adaptor is disconnected etc., the motion picture being recorded will not be recorded.
- 30 Release lever

## ■ Lens

**H-PS14042**  
(LUMIX G X VARIO PZ 14–42 mm/  
F3.5–5.6 ASPH./POWER O.I.S.)

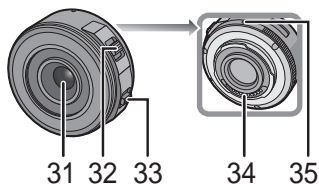

**H-FS014042**  
(LUMIX G VARIO 14–42 mm/F3.5–5.6  
ASPH./MEGA O.I.S.)

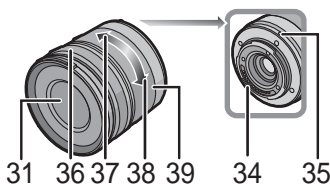

- 31 Lens surface
- 32 Zoom lever
- 33 Focus lever
- 34 Contact point
- 35 Lens fitting mark
- 36 Focus ring
- 37 Tele
- 38 Wide
- 39 Zoom ring

## Touch screen

This touch screen is a type that detects pressure.

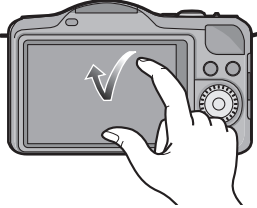
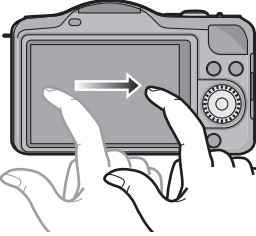
<b>Touch the screen</b>	<b>Drag</b>
To touch and release the touch screen.	A movement without releasing the touch screen.
	
Use this to perform tasks such as selecting icons or images displayed on the touch screen. • When selecting features using the touch screen, be sure to touch the center of the desired icon.	This is used to move the AF area, operate the slide bar, etc. This can also be used to move to the next image during playback, etc.

## Changing the Lens

By changing the lens, you will increase your picture taking-options and further your enjoyment of the camera. Change the lens using the following procedure.

- Check that the camera is turned off.

### Detaching the lens

Preparations: Attach the lens cap.

**While pressing on the lens release button (A), rotate the lens toward the arrow until it stops and then remove.**

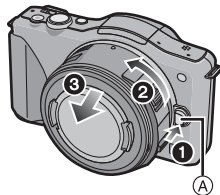

### Attaching the lens

Preparations: Remove the rear lens cap from the lens.

- If the body cap is fitted to the camera, remove it.

**Align the lens fitting marks (A) (red marks) and then rotate the lens in the direction of the arrow until it clicks.**

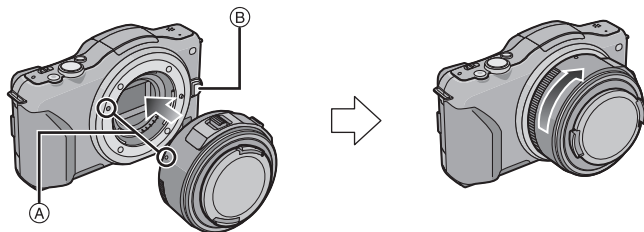

- Do not press the lens release button (B) when you attach a lens.

## Attaching the Shoulder Strap

- We recommend attaching the shoulder strap when using the camera to prevent it from dropping.

- 1** Pass the shoulder strap through the shoulder strap eyelet on the camera body.

(A): Shoulder strap eyelet

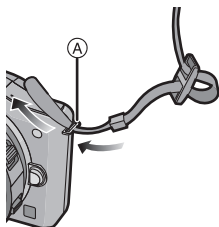

- 2** Pass the end of the shoulder strap through the ring in the direction of the arrow and then pass it through the stopper.

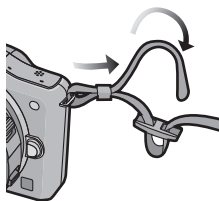

- 3** Pass the end of the shoulder strap through the hole on the other side of the stopper.

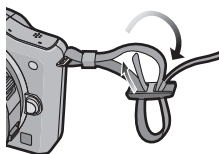

- 4** Pull the other side of the shoulder strap and then check that it will not come out.

- Perform steps 1 to 4 and then attach the other side of the shoulder strap.

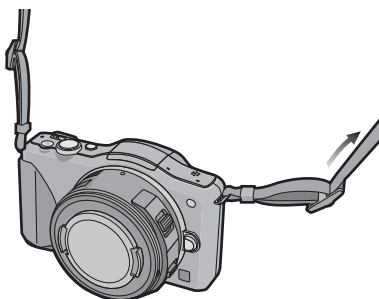

# Charging the Battery

## ■ About batteries that you can use with this unit

The battery that can be used with this unit is DMW-BLE9PP.

## Charging

- The battery is not charged when the camera is shipped. Charge the battery before use.
- Charge the battery with the charger indoors.

- 1** Attach the battery paying attention to the direction of the battery.

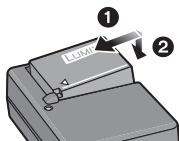

- 2** Connect the charger to the electrical outlet.

- The [CHARGE] indicator (A) lights up and charging begins.

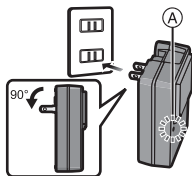

## ■ About the [CHARGE] indicator

The [CHARGE] indicator turns on:

The [CHARGE] indicator is turned on during charging.

The [CHARGE] indicator turns off:

The [CHARGE] indicator will turn off once the charging has completed without any problem. (Disconnect the charger from the electrical socket and detach the battery after charging is completed.)

## ■ Charging time

Charging time

Approx. 180 min

- The indicated charging time is for when the battery has been discharged completely. The charging time may vary depending on how the battery has been used. The charging time for the battery in hot/cold environments or a battery that has not been used for a long time may be longer than normal.

## Inserting and Removing the Card (optional)/ the Battery

- Check that this unit is turned off.
- We recommend using a Panasonic card.

**1** Slide the release lever in the direction of the arrow and open the card/battery door.

- Always use genuine Panasonic batteries (DMW-BLE9PP).
- If you use other batteries, we cannot guarantee the quality of this product.

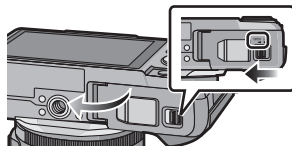

**2** **Battery:** Being careful about the battery orientation, insert all the way until you hear a locking sound and then check that it is locked by lever **(A)**. Pull the lever **(A)** in the direction of the arrow to remove the battery.

**Card:** Push it securely all the way until you hear a “click” while being careful about the direction in which you insert it. To remove the card, push the card until it clicks, then pull the card out upright.

**(B):** Do not touch the connection terminals of the card.

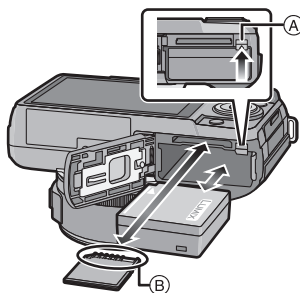

**3** **1:** Close the card/battery door.

**2:** Slide the release lever in the direction of the arrow.

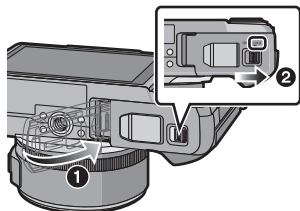



## About the Card

### About cards that can be used with this unit

The following cards which conform to the SD video standard can be used with this unit. (These cards are indicated as **card** in the text.)

	Remarks
<b>SD Memory Card (8 MB to 2 GB)</b>	<ul style="list-style-type: none"><li>• Use a card with SD Speed Class* with “Class 4” or higher when recording motion pictures.</li><li>• SDHC Memory Card can be used with SDHC Memory Card or SDXC Memory Card compatible equipment.</li><li>• SDXC Memory Card can only be used with SDXC Memory Card compatible equipment.</li><li>• Check that the PC and other equipment are compatible when using the SDXC Memory Cards. <a href="http://panasonic.net/avc/sdcard/information/SDXC.html">http://panasonic.net/avc/sdcard/information/SDXC.html</a></li><li>• This unit is compatible with UHS-I standard SDHC/SDXC memory cards.</li><li>• Only the cards with capacity listed left can be used.</li></ul>
<b>SDHC Memory Card (4 GB to 32 GB)</b>	
<b>SDXC Memory Card (48 GB, 64 GB)</b>	

\* SD Speed Class is the speed standard regarding continuous writing. Check via the label on the card, etc.

e.g.:



• Please confirm the latest information on the following website.

<http://panasonic.jp/support/global/cs/dsc/>

(This Site is English only.)

#### Note

• Keep the Memory Card out of reach of children to prevent swallowing.

# Setting Date/Time (Clock Set)

- The clock is not set when the camera is shipped.

## 1 Turn the camera on.

- The status indicator ① lights when you turn this unit on.

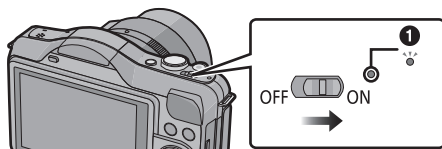

## 2 Touch [Clock Set].



## 3 Touch the items you wish to set (Year/Month/Day/Hours/Minutes), and set using [^]/[v].

- You can continue to switch the settings by continuously touching [^]/[v].
- Touch [S] to cancel the date and time settings without setting a date and time.



### To set the display order and the time display format.

- Touch [Style] to display the settings screen for setting display order/time display format.



## 4 Touch [Set] to set.

## 5 Touch [Set] in the confirmation screen.

## Changing the Clock Setting

### Select [Clock Set] in the [Setup] menu.

- The clock can be reset as shown in steps 3 and 4.

# Selecting the Recording Mode

**1** Press [MENU/SET].

**2** Touch [Rec Mode].

- A screen listing the Recording Mode is displayed.
- It is also possible to display the screen listing the Recording Mode by touching the Recording Mode icon in Recording Mode.



**3** Touch the Recording Mode to select.

- The explanation (A) for the touched Recording Mode is displayed.
- If you release your finger, the mode will be selected. If you hold your finger on the screen, move it to an area with no icons and then release, the mode will not be selected.

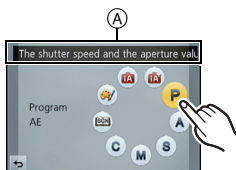

## **iA** Intelligent Auto Mode

The subjects are recorded using settings automatically selected by the camera.

## **iA+** Intelligent Auto Plus Mode

Easily match settings selected by the camera to your preferences and record.

## **P** Program AE Mode

The subjects are recorded using your own settings.

## **A** Aperture-Priority AE Mode

The shutter speed is automatically determined by the aperture value you set.

## **S** Shutter-Priority AE Mode

The aperture value is automatically determined by the shutter speed you set.

## **M** Manual Exposure Mode

The exposure is adjusted by the aperture value and the shutter speed which are manually adjusted.

## **C** Custom Mode

Use this mode to take pictures with previously registered settings.

## **SCN** Scene Guide Mode

This allows you to take pictures that match the scene being recorded.

## **CC** Creative Control Mode

Record while checking the image effect.

## Taking a Still picture

### 1 Selecting the Recording Mode.

### 2 Press the shutter button halfway to focus.

- (A) Aperture value
- (B) Shutter speed

- Aperture value and shutter speed are displayed. (It will flash in red if the correct exposure is not achieved, except when set to flash.)
- **When the image is correctly focused, the picture will be taken, since the [Focus Priority] is set initially to [ON].**



### 3 Press the shutter button fully (push it in further), and take the picture.



## Taking pictures using the Touch Shutter function

Just by touching the subject to focus, it will focus on the subject and take the picture automatically.

### 1 Touch .



### 2 Touch .

- Icon will change to , and taking a picture with the Touch Shutter function becomes possible.



### 3 Touch the subject you wish to focus on, and then take a picture.

- AF area with same function as in AF mode is displayed at the position you touch, and picture is taken when it is focused when the AF mode is set to , , or .

### ■ To cancel the Touch Shutter function

Touch .



Recording Mode: 

## Taking Pictures using the Automatic Function (Intelligent Auto Mode)

In this mode, the camera makes the optimal settings for the subject and scene, so we recommend it when you wish to leave the settings to the camera and record without thinking about them.

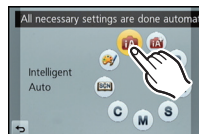

### Set Recording Mode to .



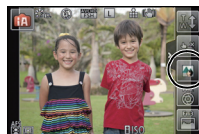

- Defocus control can be set by touching  on the recording screen and then touching .
- When the subject is touched, AF Tracking function works. It is also possible by pressing the cursor button towards , and then pressing the shutter button halfway.



### ■ About button

By pressing the  button, you can switch between the Intelligent Auto ( or ) Mode of the Recording Mode and other modes.

- When the Recording Mode is  or , the  button lights up. (Light turns off during recording)

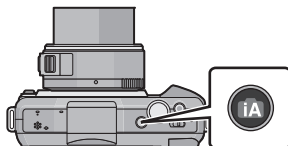

### ■ Scene Detection

When the camera identifies the optimum scene, the icon of the scene concerned is displayed in blue for 2 seconds, after which its color changes to the usual red.

Depending on the identified scene, the camera may display , which allows you to select the camera-recommended effects.

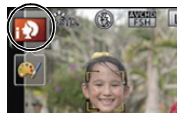

## Easily adjust and record (Intelligent Auto Plus Mode)

The brightness and color optimally set by the camera can be easily matched to your preferences. This mode is useful if you do not like dealing with detailed settings but like the settings made automatically by the camera to match your preferences.

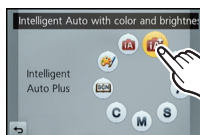

### Set Recording Mode to [IA+].

#### ■ Setting brightness

1 Touch .



2 Touch  to display the setting screen.



3 Drag the slide bar to set.

- This will adjust the brightness of the image.
- Setting can also be performed by rotating the control dial.
- Touch  again to return to the recording screen. You can also return to the recording screen by pressing the cursor button ▲.



#### ■ Setting color

1 Touch .

2 Touch  to display the setting screen.



3 Drag the slide bar to set.

- This will adjust the color of the image from a reddish color to a bluish color.
- Setting can also be performed by rotating the control dial.
- Touch  again to return to the recording screen. You can also return to the recording screen by pressing the cursor button ►.



## Taking Pictures with Defocus Control Function

You can easily set the blurriness of the background while checking the screen.

**1** Touch .



**2** Touch  to display the setting screen.



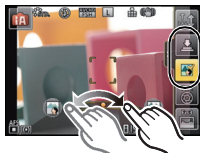

**3** Drag the slide bar to set.

- Setting can also be performed by rotating the control dial.



**4** Recording of pictures or motion pictures.

- Defocus Control operation can be ended by touching .
- It is also possible to record a picture by touching .

Applicable modes:   **P** **A** **S** **M** **C**  

## Recording Motion Picture

- Screen here is an example of when the Recording Mode is set to [**P**] (Program AE Mode).

### 1 Start recording by pressing the motion picture button.

- (A) Elapsed recording time
- (B) Available recording time

- Recording of motion picture appropriate for each mode is possible.
- The recording state indicator (red) (C) will flash while recording motion pictures.

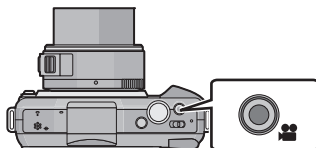

### 2 Stop the recording by pressing the motion picture button again.

## Recording still pictures while recording motion pictures

Still pictures can be recorded even while recording a motion picture. (Simultaneous recording)

**During motion picture recording, press the shutter button fully to record a still picture.**

- Simultaneous recording indicator (A) is displayed while recording still pictures.
- You can also take pictures using the Touch Shutter function.





## Compensating the Exposure

Use this function when you cannot achieve appropriate exposure due to the difference in brightness between the subject and the background. Look at the following examples.

- 1 Press to switch to Exposure Compensation operation.



- 2 Rotate the control dial to compensate the exposure.

- (A) Exposure Compensation value
- (B) [Expo.Meter]

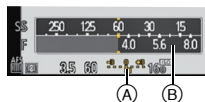

Underexposed	Properly exposed	Overexposed
<p>Rotate the control dial to the right to correct the exposure in the plus direction.</p>		<p>Rotate the control dial to the left to correct the exposure in the minus direction.</p>

- Select [0] to return to the original exposure.
- Rotate the control dial to display the [Expo.Meter].

## Using the function button

The recording functions etc. registered in the [Fn Button Set] of the [Custom] menu can be assigned to the [Fn1] (function) buttons, [Fn2] and [Fn3] icon.

You can use the assigned functions by pressing the buttons for [Fn1] and by touching the icons for [Fn2] and [Fn3].

- To use [Fn1], set the [Q.MENU/Fn1] of the [Custom] menu to [Fn1].

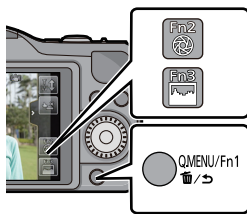

**1** Touch [Fn1], [Fn2] or [Fn3] from the [Fn Button Set] in the [Custom] menu.

**2** Touch the function you want to assign.

- Assign your favorite function to [Fn1], [Fn2], and [Fn3].
- Exit the menu after it is set.

## Taking Pictures that match the Scene being recorded (Scene Guide Mode)

If you select a scene to suit the subject and recording conditions with reference to the example images, the camera will set optimal exposure, color, and focus, allowing you to record in a manner appropriate to the scene.

**1** Set Recording Mode to [].

**2** Drag the example images to select a screen.

- You can also switch between items by dragging the slide bar .

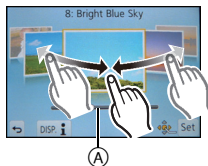



**3** Touch [Set].

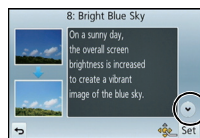

### ■ To enjoy a variety of picture effects

Touch [] on the scene selection screen to display explanations etc. for picture effects to suit the scene. To take full advantage of the picture effects, we recommend that you read the explanations and try recording pictures.





- The page can be changed by touching []/[].

## Taking Pictures with different image effects (Creative Control Mode)

This mode records with additional image effects. You can set the effects to add by selecting example images and checking them on the screen.

### 1 Set Recording Mode to .

### 2 Select an image effect (filter) with reference to the example images, and touch.

- The image effect of the selected example image will be applied in a preview display (A).
- The image effect can be switched by touching []/[].
- Touch [] to display the explanation for the selected image effect.

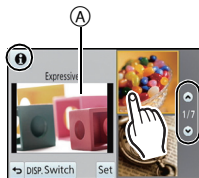

### 3 Touch [Set].

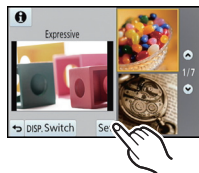

# Playing Back Pictures/Motion Pictures

## Playing Back Pictures

**1** Press [▶].



**2** Forward or rewind the image by dragging the screen horizontally.

Forward: drag from right to left

Rewind: drag from left to right



## Using the Playback Zoom

**Touch the part to enlarge firmly.**

1×→2×→4×→8×→16×

- You can also enlarge/reduce the picture by rotating the control dial.
- When you change the magnification, the zoom position indication (A) appears for about 1 second.
- The more a picture is enlarged, the more its quality deteriorates.
- You can move the enlarged part by dragging the screen.
- Picture will return to the original size (1×) by touching [🔍<sub>x1.0</sub>].
- When you touch [🔍], the magnification becomes lower.



## Playing Back Motion Pictures

The motion picture file formats that can be played back on this unit are AVCHD (excluding AVCHD Progressive) recorded on a Panasonic Digital Camera (LUMIX), MP4, and QuickTime Motion JPEG.

**1** Press **[▶]**.

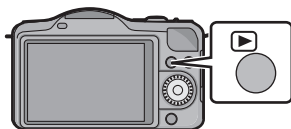

**2** Select a picture with a Motion Picture icon ([👤]) and then touch **[▶]** to play back.

- (A) Motion picture icon
- (B) The motion picture recording time

- After playback starts, the elapsed playback time is displayed on the screen.

For example, 8 minutes and 30 seconds is displayed as [8m30s].

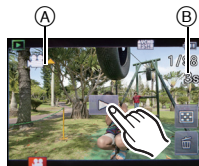

### ■ Operations performed during Motion Picture Playback

	Play/Pause		Stop
	Fast rewind		Fast forward
	Frame-by-frame rewind (while pausing)		Frame-by-frame forward (while pausing)
	Reduce volume level		Increase volume level

# Deleting Pictures

Once deleted, pictures cannot be recovered.

## To delete a single picture

- 1 Select the picture to be deleted, and then touch [  ].



- 2 Touch [Delete Single].

- Confirmation screen is displayed.  
Pictures are deleted by selecting [Yes].

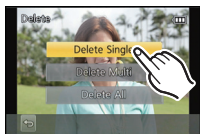

## To delete multiple pictures (up to 100) or all the pictures

- 1 Touch [  ].

- 2 Touch [Delete Multi] or [Delete All].

- [Delete All] → Confirmation screen is displayed.  
Pictures are deleted by selecting [Yes].
- It is possible to delete all pictures except the ones set as favorite when [All Delete Except Favorite] is selected with the [Delete All] set.

- 3 (When [Delete Multi] is selected) Touch the picture to be deleted.  
(repeat this step)

- [  ] appears on the selected pictures. Touching again cancels the setting.



- 4 (When [Delete Multi] is selected) Touch [OK].

- Confirmation screen is displayed.  
Pictures are deleted by selecting [Yes].

# Switching the display of the LCD Monitor

Press [DISP.] to change.



## (In Recording Mode)

• Screen will switch as follows:

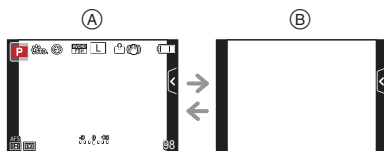

- (A) With information\*
- (B) Without information\*

## (In Playback Mode)

• Screen will switch as follows:

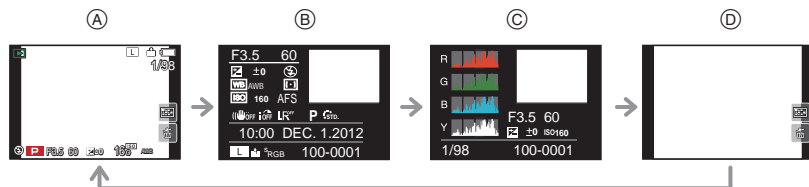

- (A) With information\*
- (B) Detailed information display
- (C) Histogram display
- (D) Without information

\* If approximately 1 minute elapses without an operation being performed, part of the display will disappear. Press [DISP.] or touch the LCD monitor to make the display reappear.



# Setting the Menu

## 1 Press [MENU/SET].

- The top menu screen is displayed.

## 2 Touch the menu icon.

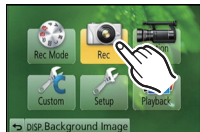

## 3 Touch the menu item.

- The explanation (A) for the touched menu item is displayed.
- The page can be changed by touching [⏪]/[⏩].

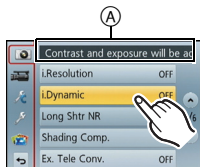

## 4 Touch the Setting to set.

- The explanation for the content of the touched setting is displayed.
- The figure on the right is an example of setting [i.Dynamic] from [OFF] to [HIGH].
- Depending on the menu item, its setting may not appear or it may be displayed in a different way.

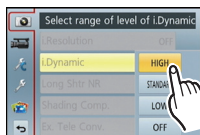

Description of the icon is displayed by touching the icon for menu item/setting in steps 3 and 4.

- It will be set when you release your finger.
- It will not be set when you move your finger to the position where there is no icon, and then release your finger.

### ■ Close the menu

Touch [⏪] or press the shutter button halfway.

### ■ Switching to other menus

e.g.: Switching to the [Setup] menu from [Rec] menu

Touch [🔑] or another of the menu toggle icons (A).

- Select a menu item next and set it.



# Setting the Quick Menu

By using the Quick Menu, some of the menu settings can be easily found.

**1** Press [Q.MENU/Fn1] to display the Quick Menu.

**2** Touch the menu item.

- Menu item can be switched by touching [◀]/[▶].

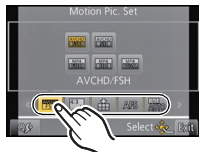

**3** Select and touch the setting.



**4** Touch [Exit] to exit menu once the setting is completed.

## ■ Change the Quick Menu to your preferred item

Up to 10 items to be used can be setup as Quick Menus. Set the menu items depending on the recording conditions, etc.

**1** Touch [Q.MENU].



**2** Select the menu in the top row and drag it to the bottom row.

- (A) Items that can be setup as Quick Menus.
- (B) Items that can be displayed in the Quick Menu screen.

- If there is no empty space in the bottom row, drag it into the menu item to be replaced.  
New item can be set replacing the old item.
- When the item is dragged from the bottom row to the top row, the setting will be canceled and that space will become empty.

**3** Touch [Exit].

- It will return to screen of above step 1. Touch [Exit] to switch to the recording screen.

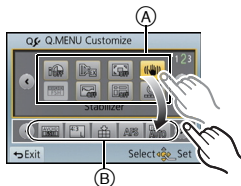



## Types of menus

### ■ [Rec] Mode Menu

This menu lets you set the aspect ratio, number of pixels and other aspects of the pictures you are recording.

- [Photo Style], [Focus Mode], [Metering Mode], [i.Resolution], [i.Dynamic] and [Digital Zoom] are common to both the [Rec] Mode menu and [Motion Picture] Mode menu. Changing these settings in one of these menus is reflected in other menu.

[Photo Style]	You can select effects to match the type of image you wish to record. You can adjust the color and image quality of the effects.
[Aspect Ratio]	Sets the aspect ratio of the image.
[Picture Size]	Set the number of pixels.
[Quality]	Set the compression rate at which the pictures are to be stored.
[Sensitivity]	This allows the sensitivity to light (ISO sensitivity) to be set.
[ISO Limit Set]	When the ISO sensitivity is set to [AUTO] or [ISO], an optimal ISO sensitivity is set with the selected value as an upper limit.
[ISO Increments]	The ISO sensitivity settings values changes in steps of 1/3 EV or 1 EV.
[Extended ISO]	It will be possible to set ISO sensitivity up to [ISO12800].
[Face Recog.]	Sets the focus and exposure automatically prioritising registered faces.
[Profile Setup]	If you set the name and birthday of your baby or pet in advance, you can record their name and age in months and years in the images.
[Focus Mode]	Sets [Focus Mode] according to the movement of the subject and the scene you are recording.
[Quick AF]	Speeds up the focusing that takes place when you press the shutter button.
[Metering Mode]	Sets the light metering method for measuring brightness.
[Flash]	Sets the manner in which the flash works.
[Red-Eye Removal]	Automatically detects red-eye caused by the flash and corrects the image data accordingly.
[i.Resolution]	Records pictures with more defined outlines and sense of clarity.
[i.Dynamic] (Intelligent dynamic range control)	Automatically corrects contrast and exposure.

[Long Shtr NR]	You can eliminate the generated noise by recording with a slower shutter speed.
[Shading Comp.]	If the screen periphery darkens as a result of lens characteristics, the brightness in this region will be corrected.
[Ex. Tele Conv.]	When the number of pixels is set to anything other than [L], the Tele effect is increased without degradation in image quality.
[Digital Zoom]	Increases the Tele effect. The higher the level of magnification, the greater the degradation in image quality.
[Burst Rate]	Sets the burst speed for burst recording.
[Auto Bracket]	Sets single/burst recording, correction width and recording sequence for Auto Bracket recording.
[Self Timer]	Sets the time until recording for self-timer recording.
[Color Space]	Set this when you want to correct the color reproduction of the recorded pictures on a PC, printer etc.
[Stabilizer]	When camera shake is sensed during recording, the camera corrects it automatically.
[Recommended Filter]	This sets whether to display the camera-recommended effects in Intelligent Auto (  or  ) Mode.

### ■ [Motion Picture] Mode Menu

This menu lets you set the [Rec Mode], [Rec Quality], and other aspects for motion picture recording.

- [Photo Style], [Focus Mode], [Metering Mode], [i.Resolution], [i.Dynamic] and [Digital Zoom] are common to both the [Rec] Mode menu and [Motion Picture] Mode menu. Changing these settings in one of these menus is reflected in other menu.  
– For details, refer to the explanation for the corresponding setting in [Rec] Mode menu.

[Rec Mode]	Sets the file format for the motion pictures you record.
[Rec Quality]	This sets up the picture quality of motion pictures.
[Continuous AF]	Continues to focus on the subject for which focus has been achieved.
[Ex. Tele Conv.]	If the [Rec Quality] is set to other than [FSH] and [FHD], the Tele effect is increased.
[Wind Cut]	This prevents the recording of wind-noise automatically.
[Mic Level Disp.]	Set whether or not the mic levels are displayed on the screen.
[Mic Level Adj.]	Adjust the sound input level to 4 different levels.
[Flikr Decrease]	The shutter speed can be fixed to reduce the flicker or striping in the motion picture.

## ■ [Custom] Menu

Operation of the unit, such as displaying of the screen and button operations, can be set up according to your preferences. Also, it is possible to register the modified settings.

[Cust.Set Mem.]	Registers the current camera settings as custom set.
[Q.MENU/Fn1]	This allocates either [Q.MENU] (Quick Menu) or [Fn1] (Function Button) to the [Q.MENU/Fn1] button.
[Fn Button Set]	You can assign various recording and other functions to the function button.
[Histogram]	This allows you to set either to display or not display the histogram.
[Guide Line]	This will set the pattern of guide lines displayed when taking a picture.
[Highlight]	When the Auto Review function is activated or when playing back, white saturated areas appear blinking in black and white.
[Expo.Meter]	Set whether or not to display the exposure meter.
[AF/AE Lock]	Sets the fixed content for focusing and exposure when the AF/AE lock is on.
[Focus Priority]	It will set so no picture can be taken when it is out of focus.
[Pinpoint AF Time]	Sets the time for which the screen is enlarged when the shutter button is pressed halfway with Auto Focus Mode set to <b>[+]</b> .
[AF Assist Lamp]	AF assist lamp will illuminate the subject when the shutter button is pressed half-way making it easier for the camera to focus when recording in low light conditions.
[AF+MF]	You can set the focus manually after the automatic focus has finished.
[MF Assist]	When you set the focus manually, the display is enlarged.
[MF Guide]	When you set the focus manually, an MF guide that allows you to check the direction to achieve focus is displayed.
[Power Zoom Lens]	Sets the screen display and lens operations when using an interchangeable lens that is compatible with power zoom (electrically operated zoom).
[iA Button Switch]	It is possible to set how the <b>[iA]</b> button to toggle to Intelligent Auto Mode will operate.
[Video Button]	Enables/disables the motion picture button.
[Rec Area]	This changes the angle of view during motion picture recording and still picture recording.
[Remaining Disp.]	This will switch display between the number of recordable pictures and available recording time.
[Touch Settings]	Enables/disables the Touch operation.

<b>[Touch Scroll]</b>	This allows you to set the speed of continuously forwarding or rewinding pictures using touch operation.
<b>[Menu Resume]</b>	Stores the location of the last-used menu item for each menu.
<b>[Pixel Refresh]</b>	It will perform optimization of imaging device and image processing.
<b>[Sensor Cleaning]</b>	Dust reduction to blow off the debris and dust that have affixed to the front of the imaging device is performed.
<b>[Shoot w/o Lens]</b>	Sets whether or not the shutter can be released when no lens is attached to the main body.

## ■ Setup Menu

This menu lets you perform the clock settings, select the operating beep tone settings and set other settings which make it easier for you to operate the camera.

<b>[Clock Set]</b>	Setting Date/Time.
<b>[World Time]</b>	Sets the times for the region where you live and your holiday destination.
<b>[Travel Date]</b>	Departure date and return date of the travel as well as the name of the travel destination can be set.
<b>[Beep]</b>	Set the volume of the focus confirmation beep, the self-timer beep and the alarm beep.
<b>[Volume]</b>	Adjust the volume of the speaker to any of 7 levels.
<b>[LCD Display]</b>	Brightness, color, or red or blue tint of the LCD monitor is adjusted.
<b>[LCD Mode]</b>	The brightness of the LCD monitor can be adjusted depending on how bright it is around the camera.
<b>[Economy]</b>	Suppresses the unit power consumption to prevent the battery being run down.
<b>[Auto Review]</b>	Set the length of time that the picture is displayed after taking the still picture.
<b>[USB Mode]</b>	Sets the communication method when connecting using the USB connection cable (supplied).
<b>[Output]</b>	This sets how the unit connects to a television etc.
<b>[VIERA Link]</b>	Equipment that supports the VIERA Link will connect automatically.
<b>[3D Playback]</b>	Setup the output method for 3D pictures.

[Rotate Disp.]	This mode allows you to display pictures vertically if they were recorded holding the camera vertically.
[Menu Background]	Set the background color for the menu screen.
[Language]	Set the language displayed on the screen.
[Version Disp.]	This enables the firmware versions of the camera and lens to be checked.
[No.Reset]	Returns the image file number to 0001.
[Reset]	The [Rec] or [Setup]/[Custom] menu settings are reset to the initial settings.
[Format]	The card is formatted.

### ■ [Playback] Mode Menu

This menu lets you set the Protection, Cropping or Print Settings, etc. of recorded pictures.

[2D/3D Settings]	Switches the playback method for 3D images.
[Slide Show]	Selects the type etc. of the images and plays back in order.
[Playback Mode]	Selects the type etc. of the images and plays back only particular images.
[Title Edit]	Input texts (comments) on the recorded pictures.
[Text Stamp]	Stamps the recorded pictures with recording date and time, names, travel destination, travel date etc.
[Video Divide]	Splits the recorded motion picture in two.
[Resize]	Reduces the image size (number of pixels).
[Cropping]	Crops the recorded image.
[Rotate]	Rotate pictures manually in 90° steps.
[Favorite]	Marks can be added to images, and images can be set as favorites.
[Print Set]	Sets the images for printing and the number of prints.
[Protect]	Protects images to prevent deletion by mistake.
[Face Rec Edit]	Removes or changes information relating to personal identity.

## Reading the Owner's Manual (PDF format)

More detailed instructions on the operation of this camera are contained in "Owner's Manual for advanced features (PDF format)" in the supplied CD-ROM. Install it on your PC to read it.

### ■ For Windows

- 1** Turn the PC on and insert the CD-ROM containing the Owner's Manual (supplied).
- 2** Select the desired language and then click [Owner's Manual] to install.
- 3** Double click the "Owner's Manual" shortcut icon on the desktop.

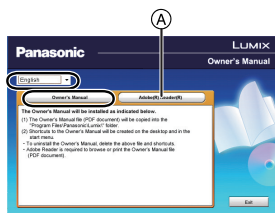

### ■ When the Owner's Manual (PDF format) will not open

You will need Adobe Acrobat Reader 5.0 or later or Adobe Reader 7.0 or later to browse or print the Owner's Manual (PDF format).

Insert the CD-ROM containing the Owner's Manual (supplied), click (A) and then follow the messages on the screen to install.

(Compatible OS: Windows XP SP3/Windows Vista SP2/Windows 7)

- You can download and install a version of Adobe Reader that you can use with your OS from the following Web Site.

<http://get.adobe.com/reader/otherversions>

### ■ To uninstall the Owner's Manual (PDF format)

Delete the PDF file from the "Program Files\Panasonic\Lumix" folder.

### ■ For Mac

- 1** Turn the PC on and insert the CD-ROM containing the Owner's Manual (supplied).
- 2** Open the "Manual" folder in the CD-ROM and then copy the PDF file with the desired language inside the folder.
- 3** Double click the PDF file to open it.



## About the supplied software

The supplied CD-ROM includes the following software.  
Install the software on to your computer before use.

### • **PHOTOfunSTUDIO 8.2 AE (Windows XP/Vista/7)**

This software allows you to acquire pictures to the PC, and also categorize these acquired pictures by their recording date or the model name of the camera used. You can resize pictures and add effects to the pictures. Various printing functions, such as layout printing, and writing function to CD-R\* are supported too. If you forgot to set the date on the digital camera, you can add the date of recording to pictures with this software.

Also, [AVCHD] motion pictures can be loaded and written to DVD.

\* This can be used only if the [Recording] tab is displayed on the [Properties] of the CD/DVD drive on the PC.

### • **SILKYPIX Developer Studio (Windows XP/Vista/7, Mac OS X v10.4/v10.5/v10.6/v10.7)**

This is software to edit RAW format images.

Using RAW files recorded on this camera allows images to be edited with a higher quality. Edited images can be saved in a format (JPEG, TIFF, etc.) that can be displayed on a personal computer.

**For details on how to use the SILKYPIX Developer Studio, refer to the "Help" or the Ichikawa Soft Laboratory's support website:  
<http://www.isl.co.jp/SILKYPIX/english/p/support/>**

### • **LoiLoScope 30 day full trial version (Windows XP/Vista/7)**

LoiLoScope is a video editing software where that draws out the full power of your PC. Creating videos is as easy as organizing cards on top of a desk. Use your music, picture and video files to create videos to share with your friends and family by burning it to a DVD, uploading it to websites, or simply share your videos with your friends via e-mail.

– This will only install a shortcut to the trial version download site.

**For more information on how to use LoiLoScope, read the LoiLoScope manual available for download at the link below.  
Manual URL: <http://loilo.tv/product/20>**

- Before inserting the CD-ROM, close all running applications.

### 1 Check the environment of your PC.

- **Operating environment of “PHOTOfunSTUDIO 8.2 AE”**

– OS:

Windows® XP (32bit) SP3,  
Windows Vista® (32bit) SP2,  
Windows® 7 (32bit/64bit) or SP1

– CPU:

Pentium® III 500 MHz or higher (Windows® XP),  
Pentium® III 800 MHz or higher (Windows Vista®),  
Pentium® III 1 GHz or higher (Windows® 7)

– Display:

1024×768 pixels or more (1920×1080 pixels or more recommended)

– RAM:

512 MB or more (Windows® XP/Windows Vista®),  
1 GB or more (Windows® 7 32bit),  
2 GB or more (Windows® 7 64bit)

– Free hard disk space:

450 MB or more for installing software

- Refer to the operating instructions of “PHOTOfunSTUDIO” (PDF) for further operating environment.
- For details on SILKYPIX Developer Studio 3.1 SE, please read the details on the support site given on P41.

### 2 Insert the CD-ROM with the supplied software.

- When you insert the supplied CD-ROM, the install menu will start.

### 3 Click on the [Recommended Installation].

- Proceed with installation according to messages appearing on the screen.

#### Note

- The software compatible with your PC will be installed.
- “PHOTOfunSTUDIO” is not compatible with Mac.
- On the Mac, SILKYPIX can be installed manually.

- 1 Insert the CD-ROM with the supplied software.
- 2 Double-click on the automatically displayed folder.
- 3 Double-click the icon in the application folder.

## Specifications

### Digital Camera Body (DMC-GF5):

Information for your safety

<b>Power Source:</b>	DC 8.4 V
<b>Power Consumption:</b>	2.2 W (When recording) [When the Interchangeable lens (H-PS14042) is used] 2.3 W (When recording) [When the Interchangeable lens (H-FS014042) is used] 1.7 W (When playing back) [When the Interchangeable lens (H-PS14042) is used] 1.8 W (When playing back) [When the Interchangeable lens (H-FS014042) is used]

<b>Camera effective pixels</b>	12,100,000 pixels
<b>Image sensor</b>	4/3" Live MOS sensor, total pixel number 13,060,000 pixels, Primary color filter
<b>Digital Zoom</b>	Max. 4×
<b>Extended Tele Conversion</b> (Except for the maximum picture size for each aspect ratio)	ON/OFF simple enlargement (compatible with lenses from other manufacturers)
<b>Focus</b>	Auto Focus/Manual Focus, Face Detection/AF Tracking/23-area-focusing/ 1-area-focusing/Pinpoint (Touch focus area selection possible)
<b>Shutter system</b>	Focal-plane shutter
<b>Burst recording</b>	
<b>Burst speed</b>	4 pictures/second (High speed), 3 pictures/second (Middle speed), 2 pictures/second (Low speed)
<b>Number of recordable pictures</b>	Max. 5 pictures (when there are RAW files) Depends on the capacity of the card (when there are no RAW files)

<b>ISO sensitivity (Standard Output Sensitivity)</b>	AUTO/[ISO/160/200/400/800/1600/3200/6400/12800*] (1/3 EV step change possible) * Only available when [Extended ISO] is set.
<b>Minimum Illumination</b>	Approx. 11 lx (when i-Low light is used, the shutter speed is 1/30th of a second) [When the Interchangeable lens (H-PS14042) is used] Approx. 11 lx (when i-Low light is used, the shutter speed is 1/30th of a second) [When the Interchangeable lens (H-FS014042) is used]
<b>Shutter speed</b>	60 seconds to 1/4000th of a second Taking still pictures during motion picture recording: 1/30th of a second to 1/16000th of a second
<b>Metering range</b>	EV 0 to EV 18
<b>White Balance</b>	Auto White Balance/Daylight/Cloudy/Shade/Incandescent lights/Flash/White set1/White set2/White Balance K set
<b>Exposure (AE)</b>	Program AE (P)/Aperture-priority AE (A)/Shutter-priority AE (S)/Manual exposure (M)/AUTO Exposure Compensation (1/3 EV Step, -3 EV to +3 EV)
<b>Metering Mode</b>	Multiple/Center weighted/Spot
<b>LCD monitor</b>	3.0" TFT LCD (3:2) (Approx. 920,000 dots) (field of view ratio about 100%) Touch screen
<b>Flash</b>	Built-in pop up flash GN 6.3 equivalent (ISO160·m) Flash range: Approx. 30 cm (0.99 feet) to 5.7 m (18.8 feet) [When the Interchangeable lens (H-PS14042) is mounted, WIDE, [ISO AUTO] is set] Flash range: Approx. 1.0 m (3.29 feet) to 4.9 m (16.1 feet) [When the Interchangeable lens (H-FS014042) is mounted, focal length is 18 mm, [ISO AUTO] is set, and the aspect ratio is set to [4:3]] AUTO, AUTO/Red-Eye Reduction, Forced ON, Forced ON/Red-Eye Reduction, Slow Sync., Slow Sync./Red-Eye Reduction, Forced OFF
<b>Flash synchronization speed</b>	Equal to or smaller than 1/160th of a second
<b>Microphone</b>	Stereo
<b>Speaker</b>	Monaural
<b>Recording media</b>	SD Memory Card/SDHC Memory Card/SDXC Memory Card

<b>Picture size</b>		
<b>Still picture</b>	When the aspect ratio setting is [4:3] 4000×3000 pixels, 2816×2112 pixels, 2048×1536 pixels When the aspect ratio setting is [3:2] 4000×2672 pixels, 2816×1880 pixels, 2048×1360 pixels When the aspect ratio setting is [16:9] 4000×2248 pixels, 2816×1584 pixels, 1920×1080 pixels When the aspect ratio setting is [8:1] 2992×2992 pixels, 2112×2112 pixels, 1504×1504 pixels	
<b>Recording quality</b>		
<b>Motion pictures</b>	[AVCHD] When set to [FSH]: 1920×1080 pixels (60i* recording/ Approx. 17 Mbps/ When set to [SH]: 1280×720 pixels (60p* recording/ Approx. 17 Mbps/ (*Sensor output is 30 frames/sec.) [MP4] When set to [FHD]: 1920×1080 pixels (30 frames/sec., Approx. 20 Mbps/ When set to [HD]: 1280×720 pixels (30 frames/sec., Approx. 10 Mbps/ When set to [VGA]: 640×480 pixels (30 frames/sec., Approx. 4 Mbps)	
<b>Quality</b>	RAW/RAW+Fine/RAW+Standard/Fine/Standard/MPO+Fine/MPO+Standard	
<b>Recording file format</b>		
<b>Still Picture</b>	RAW/JPEG (based on "Design rule for Camera File system", based on "Exif 2.3" standard, DPOF corresponding)/MPO	
<b>Motion pictures</b>	AVCHD/MP4	
<b>Audio compression</b>	AVCHD	Dolby® Digital (2 ch)
	MP4	AAC (2 ch)
<b>Interface</b>		
<b>Digital</b>	"USB 2.0" (High Speed)	
<b>Analog video/audio</b>	NTSC Audio line output (monaural)	
<b>Terminal</b>		
<b>[AV OUT/DIGITAL]</b>	Dedicated jack (8 pin)	
<b>[HDMI]</b>	MiniHDMI TypeC	

<b>Dimensions</b>	Approx. 107.7 mm (W)×66.6 mm (H)×36.8 mm (D) [4.24" (W)×2.62"(H)×1.45" (D)] (excluding the projecting parts)
<b>Mass (weight)</b>	Approx. 267 g/0.59 lb [with the card and battery] Approx. 225 g/0.50 lb (camera body) Approx. 362 g/0.80 lb [with the Interchangeable lens (H-PS14042), card and battery] Approx. 432 g/0.95 lb [with the Interchangeable lens (H-FS014042), card and battery]
<b>Operating temperature</b>	0 °C to 40 °C (32 °F to 104 °F)
<b>Operating humidity</b>	10%RH to 80%RH
<b>Language select</b>	[ENGLISH]/[ESPAÑOL]/[PORTUGUÊS]

### **Battery Charger (Panasonic DE-A99B):**

Information for your safety

<b>Input:</b>	~ 110 V to 240 V, 50/60 Hz, 0.15 A
<b>Output:</b>	=== 8.4 V, 0.43 A

**Equipment mobility:** Movable

### **Battery Pack (lithium-ion) (Panasonic DMW-BLE9PP):**

Information for your safety

<b>Voltage/capacity:</b>	7.2 V/940 mAh
--------------------------	---------------

**Interchangeable Lens (H-PS14042)****“LUMIX G X VARIO PZ 14–42 mm/F3.5–5.6 ASPH./POWER O.I.S.”**

<b>Focal length</b>	f=14 mm to 42 mm (35 mm film camera equivalent: 28 mm to 84 mm)
<b>Aperture type</b>	7 diaphragm blades/circular aperture diaphragm
<b>Aperture range</b>	F3.5 (Wide) to F5.6 (Tele)
<b>Minimum aperture value</b>	F22
<b>Lens construction</b>	9 elements in 8 groups (4 aspherical lenses, 2 ED Lens)
<b>Nano surface coating</b>	Yes
<b>In focus distance</b>	0.2 m (0.66 feet) (Wide to focal length 20 mm) to $\infty$ (from the focus distance reference line), 0.3 m (0.99 feet) (focal length 21 mm to Tele) to $\infty$ (from the focus distance reference line)
<b>Maximum image magnification</b>	0.17 $\times$ (35 mm film camera equivalent: 0.34 $\times$ )
<b>Optical Image Stabilizer</b>	Available
<b>[O.I.S.] switch</b>	None (Setting of the [Stabilizer] is done in [Rec] menu.)
<b>Mount</b>	“Micro Four Thirds Mount”
<b>Angle of view</b>	75° (Wide) to 29° (Tele)
<b>Filter diameter</b>	37 mm (1.46 inch)
<b>Max. diameter</b>	Approx. 61 mm (2.40 inch)
<b>Overall length</b>	Approx. 26.8 mm (1.06 inch) (from the tip of the lens to the base side of the lens mount when the lens barrel is recessed)
<b>Mass (weight)</b>	Approx. 95 g/0.21 lb

**Interchangeable Lens (H-FS014042)****“LUMIX G VARIO 14–42 mm/F3.5–5.6 ASPH./MEGA O.I.S.”**

<b>Focal length</b>	f=14 mm to 42 mm (35 mm film camera equivalent: 28 mm to 84 mm)
<b>Aperture type</b>	7 diaphragm blades/circular aperture diaphragm
<b>Aperture range</b>	F3.5 (Wide) to F5.6 (Tele)
<b>Minimum aperture value</b>	F22
<b>Lens construction</b>	12 elements in 9 groups (1 aspherical lens)
<b>In focus distance</b>	0.3 m (0.99 feet) to $\infty$ (from the focus distance reference line)
<b>Maximum image magnification</b>	0.16 $\times$ (35 mm film camera equivalent: 0.32 $\times$ )
<b>Optical Image Stabilizer</b>	Available
<b>[O.I.S.] switch</b>	None (Setting of the [Stabilizer] is done in [Rec] menu.)
<b>Mount</b>	“Micro Four Thirds Mount”
<b>Angle of view</b>	75° (Wide) to 29° (Tele)
<b>Filter diameter</b>	52 mm (2.05 inch)
<b>Max. diameter</b>	Approx. 60.6 mm (2.39 inch)
<b>Overall length</b>	Approx. 63.6 mm (2.50 inch) (from the tip of the lens to the base side of the lens mount)
<b>Mass (weight)</b>	Approx. 165 g/0.36 lb



## Digital Camera Accessory System

Description	Accessory#
Lithium Ion Battery	DMW-BLE9
AC Adaptor*1	DMW-AC8
DC Coupler*1	DMW-DCC11
Zoom Lever	DMW-ZL1*2
MC Protector	DMW-LMCH37*3, DMW-LMC52*4
ND Filter	DMW-LND37*3, DMW-LND52*4
PL Filter (Circular Type)	DMW-LPL37*3, DMW-LPL52*4
Lens Cap	DMW-LFC37*3, DMW-LFC52*4
Lens Rear Cap	DMW-LRC1
Body Cap	DMW-BDC1
Tripod Adaptor*5	DMW-TA1
AV Cable	DMW-AVC1
HDMI mini Cable	RP-CDHM15, RP-CDHM30
Wide conversion lens (0.79×)	DMW-GWC1*3
Tele conversion lens (2.0×)	DMW-GTC1*3
Macro conversion lens	DMW-GMC1*3
Fisheye conversion lens	DMW-GFC1*3
Conversion lens kit	DMW-GCK1*3
Interchangeable Lens	H-PS45175, H-PS14042, H-VS014140, H-FS100300, H-FS045200, H-FS014042, H-FS014045, H-F007014, H-F008, H-ES045, H-X025, H-H020, H-H014 H-FT012
Mount Adaptor	DMW-MA1, DMW-MA2M, DMW-MA3R

\*1 The AC Adaptor (optional) can only be used with the designated Panasonic DC Coupler (optional). The AC adaptor (optional) cannot be used by itself.

Do not attempt to use AC adaptor in other devices.

\*2 The interchangeable lens (H-PS14042) is not used.

\*3 When the interchangeable lens (H-PS14042) is used

\*4 When the interchangeable lens (H-FS014042) is used

\*5 Use if the attached lens is in contact with the tripod pedestal.

Description	Accessory#
Class 10 64 GB SDXC Memory Card	RP-SDU64GG1K
Class 10 32 GB SDHC Memory Card	RP-SDU32GG1K
Class 10 16 GB SDHC Memory Card	RP-SDU16GG1K
Class 10 8 GB SDHC Memory Card	RP-SDU08GG1K
Class 10 4 GB SDHC Memory Card	RP-SDU04GG1K
Class 6 32 GB SDHC Memory Card	RP-SDQA32GUK
Class 6 16 GB SDHC Memory Card	RP-SDQA16GUK
Class 6 8 GB SDHC Memory Card	RP-SDQA08GUK
Class 6 4 GB SDHC Memory Card	RP-SDQA04GUK
Class 4 32 GB SDHC Memory Card	RP-SDLA32GUK
Class 4 16 GB SDHC Memory Card	RP-SDLA16GUK
Class 4 8 GB SDHC Memory Card	RP-SDLA08GUK
Class 4 4 GB SDHC Memory Card	RP-SDLA04GUK
Class 4 2 GB SD Memory Card	RP-SDLA02GUK
<ul style="list-style-type: none"> <li>• This unit is compatible with UHS-I standard SDHC/SDXC memory cards.</li> </ul>	

Product numbers correct as of April 2012. These may be subject to change.

- Refer to P15 for information about the battery charging time.
- NOTE: Accessories and/or model numbers may vary between countries. Consult your local dealer.
- Refer to catalogs/Web pages for most current information regarding optional accessories.  
<http://panasonic.jp/support/global/cs/dsc/>  
 (This Site is English only.)

# Digital Camera Accessory Order Form

(For USA and Puerto Rico Customers)

Please photocopy this form when placing an order.

1. Digital Camera Model # \_\_\_\_\_

2. Items Ordered

Accessory #	Description	Price Each	Quantity	Total Price
Shipping & Handling				\$6.95
Subtotal				
Your State & Local Sales Tax				
Total				

3. Method of payment (check one)

- American Express  
 VISA                      Credit Card # \_\_\_\_\_  
 MasterCard              Expiration Date \_\_\_\_\_  
 Discover                    Customer Signature \_\_\_\_\_

(Please do not send cash)

4. Shipping information (UPS delivery requires complete street address)

Ship To:

Mr.

Mrs.

Ms.

\_\_\_\_\_

First

Last

Phone#:

Day ( ) \_\_\_\_\_

Street Address

\_\_\_\_\_

Night ( ) \_\_\_\_\_

City \_\_\_\_\_ State \_\_\_\_\_ Zip \_\_\_\_\_

TO OBTAIN ANY OF OUR DIGITAL CAMERA ACCESSORIES YOU CAN DO ANY OF THE FOLLOWING:

VISIT YOUR LOCAL PANASONIC DEALER

OR

CALL PANASONIC'S ACCESSORY ORDER LINE AT 1-800-332-5368

[6 AM-6 PM M-F, PACIFIC TIME]

OR

MAIL THIS ORDER TO: PANASONIC NATIONAL PARTS CENTER

20421 84th Ave S., Kent, WA 98032

## Limited Warranty (ONLY FOR U.S.A. AND PUERTO RICO)

Panasonic Consumer Marketing Company of North America,  
Division of Panasonic Corporation of North America  
One Panasonic Way, Secaucus, New Jersey 07094

### Panasonic Digital Still Camera Products Limited Warranty

#### Limited Warranty Coverage (For USA and Puerto Rico Only)

If your product does not work properly because of a defect in materials or workmanship, Panasonic Consumer Marketing Company of North America (referred to as “the warrantor”) will, for the length of the period indicated on the chart below, which starts with the date of original purchase (“warranty period”), at its option either (a) repair your product with new or refurbished parts, (b) replace it with a new or a refurbished equivalent value product, or (c) refund your purchase price. The decision to repair, replace or refund will be made by the warrantor.

Product or Part Name	Parts	Labor
Digital Still Camera	1 year	1 year
SD Memory Cards, Rechargeable Battery Pack (defective exchange)	90 days	Not Applicable

During the “Labor” warranty period there will be no charge for labor. During the “Parts” warranty period, there will be no charge for parts. This Limited Warranty excludes both parts and labor for non-rechargeable batteries, antennas, and cosmetic parts (cabinet). This warranty only applies to products purchased and serviced in the United States or Puerto Rico. This warranty is extended only to the original purchaser of a new product which was not sold “as is”.

## **Mail-In Service**

For assistance in the U.S.A. and Puerto Rico in obtaining repairs, please ship the product prepaid to:

**Panasonic Exchange Center**  
**4900 George McVay Drive**  
**Suite B**  
**McAllen, TX 78503**  
**[panacare@us.panasonic.com](mailto:panacare@us.panasonic.com)**

When shipping the unit, carefully pack, include all supplied accessories listed in the Owner's Manual, and send it prepaid, adequately insured and packed well in a carton box. When shipping Lithium Ion batteries please visit our Web Site at [www.panasonic.com/BatteryHandling](http://www.panasonic.com/BatteryHandling) as Panasonic is committed to providing the most up to date information. Include a letter detailing the complaint, a return address and provide a daytime phone number where you can be reached. A valid registered receipt is required under the Limited Warranty.

**IF REPAIR IS NEEDED DURING THE WARRANTY PERIOD. THE PURCHASER WILL BE REQUIRED TO FURNISH A SALES RECEIPT/PROOF OF PURCHASE INDICATING DATE OF PURCHASE, AMOUNT PAID AND PLACE OF PURCHASE. CUSTOMER WILL BE CHARGED FOR THE REPAIR OF ANY UNIT RECEIVED WITHOUT SUCH PROOF OF PURCHASE.**

## **Limited Warranty Limits And Exclusions**

This warranty ONLY COVERS failures due to defects in materials or workmanship, and DOES NOT COVER normal wear and tear or cosmetic damage. The warranty ALSO DOES NOT COVER damages which occurred in shipment, or failures which are caused by products not supplied by the warrantor, or failures which result from accidents, misuse, abuse, neglect, mishandling, misapplication, alteration, faulty installation, set-up adjustments, misadjustment of consumer controls, improper maintenance, power line surge, lightning damage, modification, introduction of sand, humidity or liquids, commercial use such as hotel, office, restaurant, or other business or rental use of the product, or service by anyone other than a Factory Service Center or other Authorized Servicer, or damage that is attributable to acts of God.

**THERE ARE NO EXPRESS WARRANTIES EXCEPT AS LISTED UNDER "LIMITED WARRANTY COVERAGE".**

**THE WARRANTOR IS NOT LIABLE FOR INCIDENTAL OR CONSEQUENTIAL DAMAGES RESULTING FROM THE USE OF THIS PRODUCT, OR ARISING OUT OF ANY BREACH OF THIS WARRANTY.**

(As examples, this excludes damages for lost time, travel to and from the servicer, loss of or damage to media or images, data or other memory or recorded content. The items listed are not exclusive, but for illustration only.)

**ALL EXPRESS AND IMPLIED WARRANTIES, INCLUDING THE WARRANTY OF MERCHANTABILITY, ARE LIMITED TO THE PERIOD OF THE LIMITED WARRANTY.**

Some states do not allow the exclusion or limitation of incidental or consequential damages, or limitations on how long an implied warranty lasts, so the exclusions may not apply to you.

This warranty gives you specific legal rights and you may also have other rights which vary from state to state. If a problem with this product develops during or after the warranty period, you may contact your dealer or Service Center. If the problem is not handled to your satisfaction, then write to the warrantor's Consumer Affairs Department at the addresses listed for the warrantor.

**PARTS AND SERVICE, WHICH ARE NOT COVERED BY THIS LIMITED WARRANTY, ARE YOUR RESPONSIBILITY.**

#### ***Customer Services Directory (United States and Puerto Rico)***

**Obtain Product Information and Operating Assistance; locate your nearest Dealer or Service Center; purchase Parts and Accessories; or make Customer Service and Literature requests by visiting our Web Site at:**

**<http://www.panasonic.com/help>**

**or, contact us via the web at:**

**<http://www.panasonic.com/contactinfo>**

You may also contact us directly at:

1-800-211-PANA (7262)

Monday-Friday 9am-9pm, Saturday-Sunday 10am-7pm EST

**For hearing or speech impaired TTY users, TTY: 1-877-833-8855**

#### ***Accessory Purchases (United States and Puerto Rico)***

Purchase Parts, Accessories and Instruction Books online for all Panasonic Products by visiting our Web Site at:

**<http://www.pstc.panasonic.com>**

Or, send your request by E-mail to:

**[npcparts@us.panasonic.com](mailto:npcparts@us.panasonic.com)**

You may also contact us directly at:

1-800-332-5368 (Phone) 1-800-237-9080 (Fax Only)

(Monday-Friday 9am-9pm EST)

Panasonic National Parts Center

20421 84th Ave S., Kent, WA 98032

(We accept Visa, MasterCard, Discover Card, American Express)

**For hearing or speech impaired TTY users, TTY: 1-866-605-1277**

As of January 2012

### Customer Service

#### Customer Service Directory

Obtain product information and operative assistant; localize the closer distributor or Service Center; buy spare parts and accessories by our web site to Latin American:

**<http://www.lar.panasonic.com>**

Also you may contact us directly by our Contact Center:

Panama	800-PANA (800-7262)
Colombia	01-8000-94PANA (01-8000-947262)
Ecuador	1800-PANASONIC (1800-726276)
Costa Rica	800-PANA737 (800-7262737)
El Salvador	800-PANA (800-7262)
Guatemala	1-801-811-PANA (1-801-811-7262)
Chile	800-390-602 From a cell phone: 797-5000
Venezuela	800-PANA-800 (800-7262-800)
Uruguay	0-800-PANA (0-800-7262)
Peru	0800-00726
Argentina	0800-333-PANA (0800-333-7262) 0810-321-PANA (0810-321-7262)
Paraguay	0800-11-PANA (0800-11-7262)

#### Mexico Service

To obtain information in the Republic of Mexico contact us at:

**[email: atencion.clientes@mx.panasonic.com](mailto:atencion.clientes@mx.panasonic.com)**

Or you may contact us in the next following phones numbers:

**01800-VIP-PANA (01800-847-7262) - Interior**  
**(55) 5000-1200 - Mexico D.F. and Metropolitan Area**

- G MICRO SYSTEM is a lens exchange type digital camera system of LUMIX based on a Micro Four Thirds System standard.
- Micro Four Thirds™ and Micro Four Thirds Logo marks are trademarks or registered trademarks of Olympus Imaging Corporation, in Japan, the United States, the European Union and other countries.
- Four Thirds™ and Four Thirds Logo marks are trademarks or registered trademarks of Olympus Imaging Corporation, in Japan, the United States, the European Union and other countries.
- SDXC Logo is a trademark of SD-3C, LLC.
- "AVCHD" and the "AVCHD" logo are trademarks of Panasonic Corporation and Sony Corporation.
- Manufactured under license from Dolby Laboratories. Dolby and the double-D symbol are trademarks of Dolby Laboratories.
- HDMI, the HDMI Logo, and High-Definition Multimedia Interface are trademarks or registered trademarks of HDMI Licensing LLC in the United States and other countries.
- VIERA Link™ is a trademark of Panasonic Corporation.
- EZ Sync™ is a trademark of Panasonic Corporation.
- HDAVI Control™ is a trademark of Panasonic Corporation.
- QuickTime and the QuickTime logo are trademarks or registered trademarks of Apple Inc., used under license therefrom.
- Adobe is a trademark or registered trademark of Adobe Systems Incorporated in the United States and/or other countries.
- Mac and Mac OS are trademarks of Apple Inc., registered in the U.S. and other countries.
- Windows and Windows Vista are either registered trademarks or trademarks of Microsoft Corporation in the United States and/or other countries.
- This product uses "DynaFont" from DynaComware Corporation. DynaFont is a registered trademark of DynaComware Taiwan Inc.
- Other names of systems and products mentioned in these instructions are usually the registered trademarks or trademarks of the manufacturers who developed the system or product concerned.

AVCHD™

DOLBY  
DIGITAL  
STEREO CREATOR

HDMI



VIERA Link™

This product is licensed under the AVC patent portfolio license for the personal and non-commercial use of a consumer to (i) encode video in compliance with the AVC Standard ("AVC Video") and/or (ii) decode AVC Video that was encoded by a consumer engaged in a personal and non-commercial activity and/or was obtained from a video provider licensed to provide AVC Video. No license is granted or shall be implied for any other use. Additional information may be obtained from MPEG LA, LLC. See <http://www.mpegla.com>.

For USA

Panasonic Consumer Marketing Company of North America,  
Division of Panasonic Corporation of North America

One Panasonic Way, Secaucus, NJ 07094

© Panasonic Corporation 2012

Printed in Japan