

Nikon

DIGITAL CAMERA

COOLPIX P7800

Reference Manual

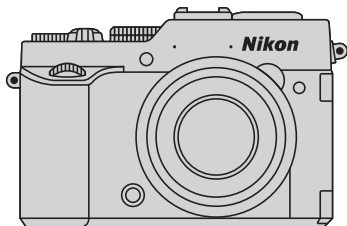

En

Introduction	
Parts of the Camera and Main Functions	
The Basics of Shooting and Playback	
Shooting Features	
Playback Features	
Recording and Playing Back Movies	
General Camera Setup	
Connecting the Camera to a TV, Computer, or Printer	
Reference Section	
Technical Notes and Index	

Introduction

Read This First

Thank you for purchasing the Nikon COOLPIX P7800 digital camera. Before using the camera, please read the information in "For Your Safety" (📖vii-ix) and familiarize yourself with the information provided in this manual. After reading, please keep this manual handy and refer to it to enhance your enjoyment of your new camera.

About This Manual





If you want to start using the camera right away, see “The Basics of Shooting and Playback” (📖20).

To learn about the parts of the camera and information that is displayed in the monitor, see “Parts of the Camera and Main Functions” (📖1).

Other Information

- Symbols and Conventions

To make it easier to find the information you need, the following symbols and conventions are used in this manual:

Symbol	Description
	This icon indicates cautions and information that should be read before using the camera.
	This icon indicates notes and information that should be read before using the camera.
	These icons indicate other pages containing relevant information;  : “Reference Section”,  : “Technical Notes and Index.”

- SD and SDHC/SDXC memory cards are referred to as “memory cards” in this manual.
- The setting at the time of purchase is referred to as the “default setting.”
- The names of menu items displayed in the camera monitor, and the names of buttons or messages displayed on a computer monitor appear in bold.
- In this manual, images are sometimes omitted from monitor display samples so that monitor indicators can be more clearly shown.
- Illustrations and monitor content shown in this manual may differ from the actual product.

Information and Precautions

Life-Long Learning

As part of Nikon's "Life-Long Learning" commitment to ongoing product support and education, continually updated information is available online at the following sites:

- For users in the U.S.A.: <http://www.nikonusa.com/>
- For users in Europe and Africa: <http://www.europe-nikon.com/support/>
- For users in Asia, Oceania, and the Middle East: <http://www.nikon-asia.com/>

Visit these sites to keep up-to-date with the latest product information, tips, answers to frequently asked questions (FAQs), and general advice on digital imaging and photography. Additional information may be available from the Nikon representative in your area. Visit the site below for contact information:

<http://imaging.nikon.com/>

Use Only Nikon Brand Electronic Accessories

Nikon COOLPIX cameras are designed to the highest standards and include complex electronic circuitry. Only Nikon brand electronic accessories (including battery chargers, batteries and AC adapters) certified by Nikon specifically for use with this Nikon digital camera are engineered and proven to operate within the operational and safety requirements of this electronic circuitry.

THE USE OF NON-NIKON ELECTRONIC ACCESSORIES COULD DAMAGE THE CAMERA AND MAY VOID YOUR NIKON WARRANTY.

The use of third-party rechargeable Li-ion batteries not bearing the Nikon holographic seal could interfere with normal operation of the camera or result in the batteries overheating, igniting, rupturing, or leaking.

For more information about Nikon brand accessories, contact a local authorized Nikon dealer.

Holographic seal: Identifies this device as an authentic Nikon product.



Before Taking Important Pictures

Before taking pictures on important occasions (such as at weddings or before taking the camera on a trip), take a test shot to ensure that the camera is functioning normally. Nikon will not be held liable for damages or lost profits that may result from product malfunction.

About the Manuals

- No part of the manuals included with this product may be reproduced, transmitted, transcribed, stored in a retrieval system, or translated into any language in any form, by any means, without Nikon's prior written permission.
- Nikon reserves the right to change the specifications of the hardware and software described in these manuals at any time and without prior notice.
- Nikon will not be held liable for any damages resulting from the use of this product.
- While every effort was made to ensure that the information in these manuals is accurate and complete, we would appreciate it were you to bring any errors or omissions to the attention of the Nikon representative in your area (address provided separately).

Notice Concerning Prohibition of Copying or Reproduction

Note that simply being in possession of material that was digitally copied or reproduced by means of a scanner, digital camera or other device may be punishable by law.

• Items prohibited by law from being copied or reproduced

Do not copy or reproduce paper money, coins, securities, government bonds or local government bonds, even if such copies or reproductions are stamped "Sample." The copying or reproduction of paper money, coins, or securities which are circulated in a foreign country is prohibited. Unless the prior permission of the government was obtained, the copying or reproduction of unused postage stamps or post cards issued by the government is prohibited.

The copying or reproduction of stamps issued by the government and of certified documents stipulated by law is prohibited.

• Cautions on certain copies and reproductions

The government has issued cautions on copies or reproductions of securities issued by private companies (shares, bills, checks, gift certificates, etc.), commuter passes, or coupon tickets, except when a minimum of necessary copies are to be provided for business use by a company. Also, do not copy or reproduce passports issued by the government, licenses issued by public agencies and private groups, ID cards and tickets, such as passes and meal coupons.

• Comply with copyright notices

The copying or reproduction of copyrighted creative works such as books, music, paintings, woodcut prints, maps, drawings, movies, and photographs is governed by national and international copyright laws. Do not use this product for the purpose of making illegal copies or to infringe copyright laws.

Disposing of Data Storage Devices

Please note that deleting images or formatting data storage devices such as memory cards or built-in camera memory does not completely erase the original image data. Deleted files can sometimes be recovered from discarded storage devices using commercially available software, potentially resulting in the malicious use of personal image data. Ensuring the privacy of such data is the user's responsibility.

Before discarding a data storage device or transferring ownership to another person, erase all data using commercial deletion software, or format the device and then completely refill it with images containing no private information (for example, pictures of empty sky) without attaching the GPS unit (available separately). Be sure to also replace any pictures selected for the **Select an image** option in the **Welcome screen** setting (📖99). Care should be taken to avoid injury or damage to property when physically destroying data storage devices.

For Your Safety

To prevent damage to your Nikon product or injury to yourself or to others, read the following safety precautions in their entirety before using this equipment. Keep these safety instructions where all those who use the product will read them.

The consequences that could result from failure to observe the precautions listed in this section are indicated by the following symbol:



This icon marks warnings, information that should be read before using this Nikon product, to prevent possible injury.

WARNINGS

Turn off in the event of malfunction

Should you notice smoke or an unusual smell coming from the camera or battery charger, unplug the battery charger and remove the battery immediately, taking care to avoid burns. Continued operation could result in injury. After removing or disconnecting the power source, take the equipment to a Nikon-authorized service representative for inspection.

Do not disassemble

Touching the internal parts of the camera or battery charger could result in injury. Repairs should be performed only by qualified technicians. Should the camera or battery charger break open as the result of a fall or other accident, take the product to a Nikon-authorized service representative for inspection, after unplugging the product and/or removing the battery.

Do not use the camera or battery charger in the presence of flammable gas

Do not use electronic equipment in the presence of flammable gas, as this could result in explosion or fire.

Handle the camera strap with care

Never place the strap around the neck of an infant or child.

Keep out of reach of children

Particular care should be taken to prevent infants from putting the battery or other small parts into their mouths.

Do not remain in contact with the camera, battery charger, or AC adapter for extended periods while the devices are on or in use

Parts of the devices become hot. Leaving the devices in direct contact with the skin for extended periods may result in low-temperature burns.

 **Do not leave the product where it will be exposed to extremely high temperatures, such as in an enclosed automobile or in direct sunlight**

Failure to observe this precaution could cause damage or fire.

 **Observe caution when handling the battery**

The battery may leak, overheat, or explode if improperly handled. Observe the following precautions when handling the battery for use in this product:

- Before replacing the battery, turn the product off. If you are using the battery charger/AC adapter, be sure it is unplugged.
- Use only a Rechargeable Li-ion Battery EN-EL14 (included). Charge the battery by using a Battery Charger MH-24 (included). For Remote Control ML-L3 (available separately), use only 3 V CR2025 lithium battery.
- When inserting the battery, do not attempt to insert it upside down or backwards.
- Do not short or disassemble the battery or attempt to remove or break the battery insulation or casing.
- Do not expose the battery to flame or to excessive heat.
- Do not immerse in or expose to water.
- Replace the terminal cover when transporting the battery. Do not transport or store with metal objects such as necklaces or hairpins.
- The battery is prone to leakage when fully discharged. To avoid

damage to the product, be sure to remove the battery when no charge remains.

- Discontinue use immediately should you notice any change in the battery, such as discoloration or deformation.
- If liquid from the damaged battery comes in contact with clothing or skin, rinse immediately with plenty of water.

 **Observe the following precautions when handling the battery charger**

- Keep dry. Failure to observe this precaution could result in fire or electric shock.
- Dust on or near the metal parts of the plug should be removed with a dry cloth. Continued use could result in fire.
- Do not handle the plug or go near the battery charger during lightning storms. Failure to observe this precaution could result in electric shock.
- Do not damage, modify, forcibly tug or bend the USB cable, place it under heavy objects, or expose it to heat or flames. Should the insulation be damaged and the wires become exposed, take it to a Nikon-authorized service representative for inspection. Failure to observe these precautions could result in fire or electric shock.
- Do not handle the plug or battery charger with wet hands. Failure to observe this precaution could result in electric shock.
- Do not use with travel converters or adapters designed to convert from one voltage to another or

with DC-to-AC inverters. Failure to observe this precaution could damage the product or cause overheating or fire.

 **Use appropriate cables**

When connecting cables to the input and output jacks, use only the cables provided or sold by Nikon for the purpose, to maintain compliance with product regulations.

 **Handle moving parts with care**

Be careful that your fingers or other objects are not pinched by the lens cover or other moving parts.

 **CD-ROMs**

The CD-ROMs included with this device should not be played back on audio CD equipment. Playing CD-ROMs on an audio CD player could cause hearing loss or damage the equipment.

 **Using the flash close to your subject's eyes could cause temporary visual impairment.**

The flash should be no less than 1 m (3 ft 4 in.) from the subject.

Particular care should be observed when photographing infants.

 **Do not operate the flash with the flash window touching a person or object**

Failure to observe this precaution could result in burns or fire.

 **Avoid contact with liquid crystal**

Should the monitor break, care should be taken to avoid injury caused by broken glass and to

prevent liquid crystal from the monitor touching the skin or entering the eyes or mouth.

 **Turn the power off when using inside an airplane or the hospital**

Turn the power off while inside the aircraft during take off or landing. Do not use wireless network functions while in the air.

Follow the instructions of the hospital when using while in a hospital.

The electromagnetic waves emitted by this camera may disrupt the electronic systems of the aircraft or the instruments of the hospital.

If you are using wireless network devices, remove them from the camera before boarding an aircraft or entering a hospital.

Notices

Notices for Customers in the U.S.A.

IMPORTANT SAFETY INSTRUCTIONS -

SAVE THESE INSTRUCTIONS.

DANGER - TO REDUCE THE RISK OF FIRE OR ELECTRIC SHOCK, CAREFULLY FOLLOW THESE INSTRUCTIONS

For connection to a supply not in the U.S.A., use an attachment plug adapter of the proper configuration for the power outlet if needed.

The power supply unit is intended to be correctly orientated in a vertical or floor mount position.

Federal Communications Commission (FCC) Radio Frequency Interference Statement

This equipment has been tested and found to comply with the limits for a Class B digital device, pursuant to Part 15 of the FCC rules. These limits are designed to provide reasonable protection against harmful interference in a residential installation. This equipment generates, uses, and can radiate radio frequency energy and, if not installed and used in accordance with the instructions, may cause harmful interference to radio communications. However, there is no guarantee that interference will

not occur in a particular installation. If this equipment does cause harmful interference to radio or television reception, which can be determined by turning the equipment off and on, the user is encouraged to try to correct the interference by one or more of the following measures:

- Reorient or relocate the receiving antenna.
- Increase the separation between the equipment and receiver.
- Connect the equipment into an outlet on a circuit different from that to which the receiver is connected.
- Consult the dealer or an experienced radio/television technician for help.



Nikon

COOLPIX P7800

CAUTIONS

Modifications

The FCC requires the user to be notified that any changes or modifications made to this device that are not expressly approved by Nikon Corporation may void the user's authority to operate the equipment.

Interface Cables

Use the interface cables sold or provided by Nikon for your equipment. Using other interface cables may exceed the limits of Class B Part 15 of the FCC rules.

Notice for Customers in the State of California

WARNING

Handling the cord on this product will expose you to lead, a chemical known to the State of California to cause birth defects or other reproductive harm.

Wash hands after handling.

Nikon Inc.,
1300 Walt Whitman Road,
Melville, New York 11747-3064
USA
Tel: 631-547-4200

Notice for Customers in Canada

CAN ICES-3 B / NMB-3 B

Notices for Customers in Europe

CAUTIONS

RISK OF EXPLOSION IF BATTERY IS REPLACED BY AN INCORRECT TYPE.

DISPOSE OF USED BATTERIES ACCORDING TO THE INSTRUCTIONS.

This symbol indicates that electrical and electronic equipment is to be collected separately.



The following apply only to users in European countries:

- This product is designated for separate collection at an appropriate collection point. Do not dispose of as household waste.
- Separate collection and recycling helps conserve natural resources and prevent negative consequences for human health and the environment that might result from incorrect disposal.
- For more information, contact the retailer or the local authorities in charge of waste management.

This symbol on the battery indicates that the battery is to be collected separately.































The following apply only to users in European countries:













































- All batteries, whether marked with this symbol or not, are designated for separate collection at an appropriate collection point. Do not dispose of as household waste.
- For more information, contact the retailer or the local authorities in charge of waste management.











































Table of Contents

















Introduction	ii
Read This First	ii
About This Manual	iii
Information and Precautions	iv
For Your Safety	vii
WARNINGS	vii
Notices	x
<hr/>	
Parts of the Camera and Main Functions	1
The Camera Body	1
Principle Functions of the Controls	3
Attaching the Camera Strap	8
Attaching and Detaching the Lens Cap	8
Opening and Adjusting the Angle of the Monitor	9
Switching Between the Monitor and Viewfinder (<input type="checkbox"/> Button)	10
Switching the Monitor Display (Fn2 Button)	11
Using Menus (the MENU Button)	12
The Monitor	14
<hr/>	
The Basics of Shooting and Playback	20
Preparation 1 Charge the Battery	20
Preparation 2 Insert the Battery	22
Preparation 3 Insert a Memory Card	24
Internal Memory and Memory Cards	25
Approved Memory Cards	25
Step 1 Turn the Camera On	26
Setting the Display Language, Date, and Time	28
Step 2 Select a Shooting Mode	30
Available Shooting Modes	31
Step 3 Frame a Picture	32
Using the Zoom	33
Step 4 Focus and Shoot	34
Step 5 Play Back Images	36
Step 6 Delete an Image	37

Shooting Features.....	38
📷 (Auto) Mode	38
Scene Mode (Shooting Suited to Scenes).....	39
Tips and Notes	40
Special Effects Mode (Applying Effects When Shooting).....	46
P, S, A, M Modes (Setting the Exposure for Shooting).....	49
The Control Range of the Shutter Speed.....	53
U1, U2 and U3 (User Settings Modes).....	55
Saving Settings in U1, U2 or U3 Mode (Save User Settings).....	55
Functions That Can Be Set Using the Multi Selector	58
Using the Flash	59
Using the Self-timer.....	62
Shooting Smiling Faces Automatically (Smile Timer).....	63
Using Focus Mode.....	64
Taking Images with Manual Focus.....	66
Default Settings.....	67
Functions That Can Be Set Using the Exposure Compensation Dial	69
Adjusting Brightness (Exposure Compensation)	69
Functions That Can Be Set Using the  Button (Quick Menu: When Shooting Still Images).....	70
Basic Quick Menu Operations	70
Available Quick Menu	72
Functions That Can Be Set with the MENU Button (Shooting Menu, Specialized Menu for U1, U2 or U3).....	73
Shooting Menu.....	73
Specialized Menu for U1, U2 or U3	75
Functions That Cannot Be Used Simultaneously	77
Focusing	82
Focusing in 📷 (Auto) Mode or EFFECTS Mode.....	82
Using the Target Finding AF	82
Using Face Detection.....	83
Using Skin Softening.....	84
Subjects Not Suitable for Autofocus.....	84
Focus Lock.....	85
<hr/>	
Playback Features.....	86
Playback Zoom	86
Thumbnail Display, Calendar Display.....	87
Functions That Can Be Set with the MENU Button (Playback Menu)	88











Using the Screen for Selecting Images	90
Recording and Playing Back Movies.....	91
Recording Movies.....	91
Functions That Can Be Set Using the  Button (Quick Menu: When Recording Movies)	95
Functions That Can Be Set with the MENU Button (Movie and Movie Custom Setting Menus)	96
Playing Back Movies	97
General Camera Setup.....	99
Functions That Can Be Set with the MENU Button (Setup Menu)	99
Connecting the Camera to a TV, Computer, or Printer.....	102
Connection Methods.....	102
Using ViewNX 2	104
Installing ViewNX 2	104
Transferring Images to the Computer	106
<hr/>	
Reference Section	 1
<hr/>	
Using Easy Panorama (Shooting and Playback)	 2
Shooting with Easy Panorama.....	 2
Viewing Images Captured with Easy Panorama.....	 4
Using Panorama Assist.....	 5
Viewing and Deleting Images Captured Continuously (Sequence).....	 7
Viewing Images in a Sequence	 7
Deleting Images in a Sequence	 8
Editing Still Images.....	 9
Before Editing Images	 9
 Quick Retouch: Enhancing Contrast and Saturation	 10
 D-Lighting: Enhancing Brightness and Contrast	 10
 Skin Softening: Softening Skin Tones.....	 11
 Filter Effects: Applying Digital Filter Effects	 12
 Small Picture: Reducing the Size of an Image	 13
 Black Border: Adding a Black Border to Images	 14
 Straighten: Compensating for Image Slanting	 15
NRW RAW (NRW) Processing: Creating JPEG Images from NRW Images ...	 15
 Crop: Creating a Cropped Copy	 17

Connecting the Camera to a TV (Viewing Images on a TV)	 18
Connecting the Camera to a Printer (Direct Print).....	 20
Connecting the Camera to a Printer	 20
Printing Individual Images.....	 21
Printing Multiple Images	 22
Editing Movies	 25
Extracting Only the Desired Portion of a Movie.....	 25
Saving a Frame from a Movie as a Still Image	 26
The Quick Menu	 27
QUAL Image Quality and Image Size	 27
QUAL Movie Options	 30
ISO ISO Sensitivity.....	 33
WB White Balance (Adjusting Hue).....	 35
BKT Auto Bracketing (Continuous Shooting While Changing the Exposure and White Balance).....	 38
 Picture Control (COOLPIX Picture Control) (Changing the Settings for Image Recording).....	 40
The Shooting Menu (P , S , A or M Mode).....	 44
Custom Picture Control (COOLPIX Custom Picture Control).....	 44
Metering	 45
Continuous Shooting	 46
AF Area Mode.....	 49
Autofocus Mode.....	 53
Flash Exp. Comp.	 54
Noise Reduction Filter	 54
Built-in ND Filter.....	 55
Distortion Control	 55
Active D-Lighting	 56
Zoom Memory.....	 57
Startup Zoom Position	 57
M Exposure Preview	 58
Focus-coupled Metering	 58
Commander Mode	 59
The Playback Menu	 62
 Print Order (Creating a DPOF Print Order)	 62
 Slide Show	 64
 Delete	 65
 Protect.....	 66
 Rotate Image	 66
 Voice Memo.....	 67

 Copy (Copy Between Internal Memory and Memory Card).....	 68
 Sequence Display Options	 69
 Choose Key Picture	 69
The Movie and Movie Custom Setting Menus	 70
Shooting Mode (Movie Custom Setting Only)	 70
Custom Picture Control (Movie Custom Setting Only)	 70
Autofocus Mode.....	 71
Built-in ND Filter (Movie Custom Setting Only)	 71
Wind Noise Reduction	 72
The Setup Menu	 72
Welcome Screen.....	 72
Time Zone and Date	 73
Monitor Settings.....	 75
Print Date (Imprinting Date and Time on Images).....	 77
Self-timer: After Release	 78
Vibration Reduction.....	 79
AF Assist	 80
ISO Sensitivity Step Value	 80
Digital Zoom.....	 81
Zoom Speed	 82
Fixed Aperture	 82
Sound Settings	 83
Record Orientation	 83
Rotate Tall	 84
Auto Off	 84
Format Memory/Format Card.....	 85
Language	 85
TV Settings.....	 86
External Mic Sensitivity	 86
Customize Command Dials.....	 87
Command Dial Rotation	 87
Multi Selector Right Press	 88
Delete Button Options	 88
AE/AF Lock Button	 89
Fn1 + Shutter Button.....	 90
Fn1 + Command Dial/Fn1 + Selector Dial	 91
Fn1 Guide Display.....	 92
Fn2 Button	 92
Customize My Menu	 93
Reset File Numbering.....	 94

Accessory Terminal		95
Eye-Fi Upload.....		96
MF Distance Indicator Units		97
Reverse Indicators		97
Flash Control		97
Reset All.....		98
Firmware Version		98
Error Messages.....		99
File Names		103
Optional Accessories		104
Shooting with Remote Control ML-L3		106
Speedlights (External Flash Unit)		108
How to Attach the Speedlight/Wireless Speedlight Commander.....		108
Using the GPS Unit		113
How to Attach the GPS Unit.....		113
Recording GPS Data on Images.....		113

Technical Notes and Index..... 1

Caring for the Products.....		2
The Camera.....		2
The Battery		3
The Battery Charger.....		4
Memory Cards.....		5
Caring for the Camera		6
Cleaning.....		6
Storage		7
Troubleshooting		8
Specifications		16
Index.....		22



A series of horizontal dashed lines for handwriting practice, starting from the first line below the pen illustration and continuing down the page.

Parts of the Camera and Main Functions

The Camera Body

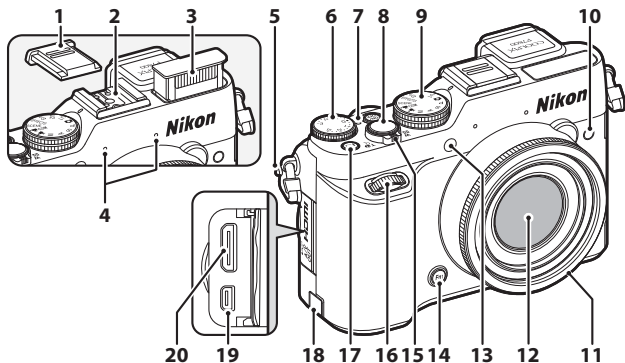

1	Accessory Shoe Cover BS-1 108	14	Fn1 (function 1) button 4, 100
2	Accessory shoe..... 108		Zoom control 33
3	Flash 59		W : wide-angle 33
4	Microphone (stereo) 88, 91	15	T : telephoto 33
5	Eyelet for camera strap 8		: thumbnail playback 87
6	Exposure compensation dial 69		: playback zoom 86
7	Exposure compensation dial mark 69		: help 39
8	Shutter-release button 4, 34	16	Sub-command dial 3, 6, 49, 51
9	Mode dial 30	17	Fn2 (function 2) button 11, 101
10	Infrared receiver (for optional Remote Control ML-L3) 58, 106	18	Power connector cover (for optional AC adapter) 104
11	Lens ring 105	19	USB/audio/video output connector 102
12	Lens	20	HDMI mini connector (Type C) 102
13	Self-timer lamp 62 AF-assist illuminator 99		

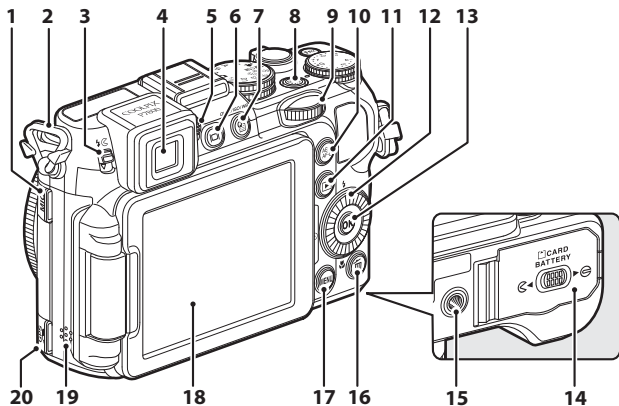

1 External microphone connector 104

2 Eyelet for camera strap 8

3 (flash pop-up) control 59

4 Electronic viewfinder 10

5 Diopter adjustment control 10

6 (monitor) button 10

7 (quick menu) button 70, 95

8 Power switch/power-on lamp 26

9 Main command dial 3, 6, 49, 51

10 (AE-L/AF-L) button 4, 100

11 (playback) button 36

12 Rotary multi selector (multi selector)* 3, 6, 58

13 (apply selection) button 3, 6, 12

14 Battery-chamber/memory card slot cover 22, 24

15 Tripod socket

16 (delete) button 37, 98, 100

17 MENU (menu) button 12, 73, 88, 96, 99

18 Monitor 9, 11, 14











19 Speaker 88, 97, 100







20 Accessory terminal 101, 95, 104





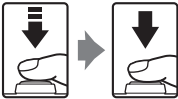



* Also referred to as the "multi selector" in this manual.

Principle Functions of the Controls



















For Shooting









Control	Main Function	
 <p>Mode dial</p>	Change the shooting mode.	30
 <p>Zoom control</p>	Move toward T (Q) (telephoto) to zoom in closer to the subject, and move toward W (wide-angle) to zoom out and view a larger area.	33
 <p>Multi selector</p>	<ul style="list-style-type: none"> While the shooting screen is displayed: Display the following setting screens by pressing: <ul style="list-style-type: none"> Up (▲):  (flash mode) Left (◀):  (self-timer/smile timer/remote control) Down (▼):  (focus mode) Right (▶):  (AF area mode) While the setting screen/quick menu is displayed: Select an item using ▲▼◀▶ or by rotating the multi selector; apply the selection by pressing the OK button. 	58 12, 70, 95
 <p>Main command dial</p>	<ul style="list-style-type: none"> When the shooting mode is P: Set the flexible program. When the shooting mode is S or M: Set the shutter speed. While the setting screen is displayed: Select an item. While the quick menu is displayed: Select an item on the left or right. 	49, 51 49, 51 12 70, 95
 <p>Sub-command dial</p>	<ul style="list-style-type: none"> When the shooting mode is A or M: Set the aperture value. While the setting screen is displayed: Move between menu levels. While the quick menu is displayed: Select an item above or below. 	49, 51 12 70, 95

Control	Main Function	
 Q (quick menu) button	Display or exit the quick menu.	70, 95
 MENU (menu) button	Display and hide the menu.	12, 73, 96, 99
 Shutter-release button	When pressed halfway (i.e., if you stop pressing when you feel resistance slightly): Set focus and exposure. When pressed all the way (i.e., if you press the button all the way down): Release the shutter.	34, 35
 Exposure compensation dial	Adjust the brightness (exposure compensation).	69
 AE-L/AF-L button	Lock the exposure or focus.	85, 100
 Fn1 (function 1) button	<ul style="list-style-type: none"> • When the zoom control is moved while pressing this button: Change the zoom lens focal length. • When the shutter-release button is pressed while pressing this button: Shoot with the setting assigned in Fn1 + shutter button. • When the command dial is rotated while pressing this button: Set the function assigned in Fn1 + command dial. • When the multi selector is rotated while pressing this button: Set the function assigned in Fn1 + selector dial. 	74 100 100 101

Control	Main Function	
 Fn2 (function 2) button	<ul style="list-style-type: none"> • Switch the information displayed in the monitor. • Set the function assigned in Fn2 button. 	11 101
  (monitor) button	Switch between the monitor and viewfinder.	10
  (playback) button	Play back images.	36
  (delete) button	Delete the last image that was saved.	37

For Playback

Control	Main Function	
 (playback) button	<ul style="list-style-type: none"> When the camera is turned off, press and hold this button to turn the camera on in playback mode. Return to shooting mode. 	36 36
 Zoom control	<ul style="list-style-type: none"> Move toward T () to zoom in on the image, and move toward W () to display images as thumbnails or the calendar. Adjust the volume for voice memo and movie playback. 	86, 87 88, 97
 Multi selector	<ul style="list-style-type: none"> While the playback screen is displayed: Change the displayed image using up () , left () , down () , right () , or by rotating the multi selector. While the setting screen is displayed: Select an item using    or by rotating the multi selector. While an enlarged image is displayed: Move the display area. 	36 12 86
 OK (apply selection) button	<ul style="list-style-type: none"> Display individual images of a sequence in full-frame playback mode. Scroll an image shot with Easy panorama. Play back movies. Switch from thumbnail playback or zoomed image display to full-frame playback. While the setting screen is displayed, apply the selection. 	89,  7 44,  4 97 86, 87 12
 Main command dial	<ul style="list-style-type: none"> Select images and date. 	36, 87
 Sub-command dial	<ul style="list-style-type: none"> Switch the magnification of an enlarged image. 	86

Control	Main Function	
 MENU (menu) button	Display and hide the menu.	12, 88
  (delete) button	Delete an image.	37
 Fn2 (function 2) button	Switch the information displayed in the monitor.	11
  (monitor) button	Switch between the monitor and viewfinder.	10
 Shutter-release button	Return to shooting mode.	-

Attaching the Camera Strap

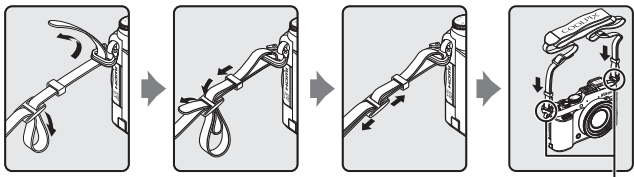

Attach the strap at two places.

Attaching and Detaching the Lens Cap

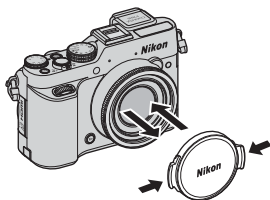

Lens Cap

At times when you are not shooting images, attach the lens cap to the lens to protect it.

Opening and Adjusting the Angle of the Monitor

The orientation and tilt of the monitor can be changed. This is useful when shooting with the camera in a high or a low position, or when taking self-portraits.

For normal shooting, fold the monitor against the camera body with the screen facing out (③).

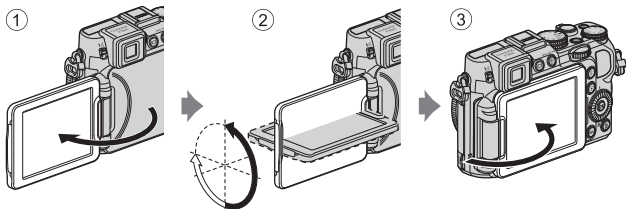

When you are not using or carrying the camera, fold the monitor against the camera body with the screen facing inward to prevent scratches or contamination.



✓ Notes About the Monitor

- When moving the monitor, do not apply excessive force and turn slowly within the monitor's adjustable range so that the connection will not be damaged.
- When the monitor is turned with a cable connected to the external microphone connector or accessory terminal, the monitor may catch on the cable or cover. Do not apply excessive force to the cable or to the connector of the camera.

Switching Between the Monitor and Viewfinder (|◻| Button)

You can use the viewfinder when bright light under the open sky makes it difficult to see the monitor.

Each press of the |◻| button switches the display between the monitor and viewfinder.

- When you fold the monitor against the camera body with the screen facing inward, the display in the monitor is switched to the viewfinder.

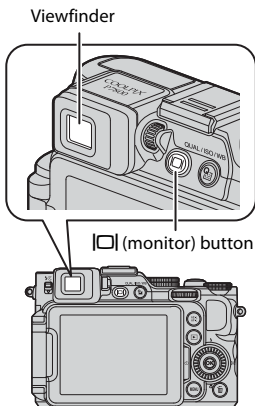

Diopter Adjustment of the Viewfinder

When the image in the viewfinder is difficult to see, adjust by rotating the diopter adjustment control while looking through the viewfinder.

- Take care not to scratch your eye with your fingertips or nails.

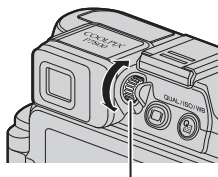

Diopter adjustment control

✓ Notes About Checking and Adjusting Image Colors

Use the monitor on the back of the camera because the monitor has higher color reproducibility than the viewfinder.

Switching the Monitor Display (Fn2 Button)

To switch the information displayed in the monitor during shooting and playback, press the **Fn2** (function 2) button.

- This operation is available when **Fn2 button** (📖101) in the setup menu is set to **Show/hide info** (default setting).

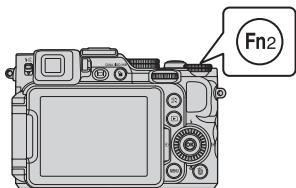

For Shooting

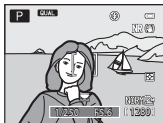

Show information

Display the image and the shooting information.



Hide information

Display the image only.

For Playback

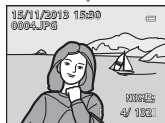

Show information

Display the image and photo information.

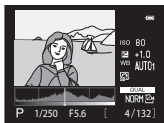

Tone level information (except movies)

Display a histogram, tone level and shooting information (📖19).



Hide information

Display the image only.



Virtual Horizon, Histogram and Framing Grid Displays for Shooting

You can set the virtual horizon, histogram or framing grid (📖16) to be displayed by selecting **Monitor settings** in the setup menu (📖99) followed by **Photo info**.

Using Menus (the MENU Button)

Use the multi selector and **OK** button to navigate the menus.

1 Press the MENU button.

- The menu that matches the status of the camera, such as shooting or playback menu, is displayed.
Unavailable menu items are displayed in gray and cannot be selected.

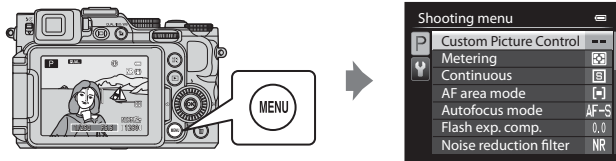

2 Use the multi selector to select a menu item.

- ▲▼ or rotation: Select an item above or below.
- ◀▶: Select an item on the left or right, or move between menu levels.
- **OK**: Apply a selection. Pressing ▶ also applies a selection.
- See [13](#) for more information on how to switch tabs.



3 After completing the settings, press the MENU button or shutter-release button.

- Press the shutter-release button to display the shooting screen.

Notes About the Command Dial Operation When a Menu is Displayed

Rotating the main command dial when a menu is displayed allows you to select an item. Rotating the sub-command dial allows you to move between menu levels.

Switching Among Menu Tabs

To display a different menu, such as the setup menu (📖99), use the multi-selector to switch to another tab.

Tabs

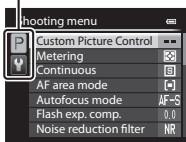

Use ◀ to move to the tabs.

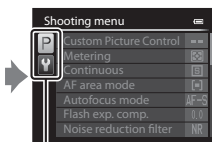

Use ▲▼ to select a tab, and press the OK button or ▶ to apply the selection.

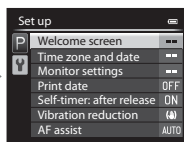

Tab Types

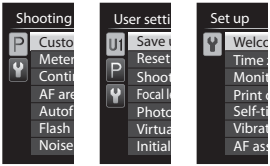
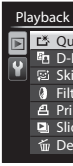



For Shooting	For Playback
	
<p>P tab: Displays the settings available for the current shooting mode (📖31). Depending on the current shooting mode, the tab icon that is displayed will be different. In 📷 (auto) mode, only Y tab is displayed.</p> <p>U1/U2/U3 tab: Displays the settings for the specialized menu in U1, U2 or U3 mode (📖55).</p> <p>Y tab: Displays the setup menu, where you can change general settings.</p>	<p>P tab: Displays the settings available for the playback mode.</p>

The Monitor

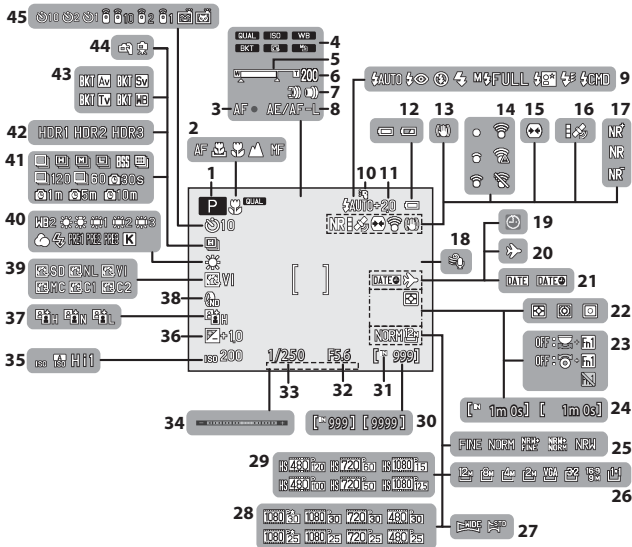



The information that is displayed in the monitor during shooting and playback changes depending on the camera's settings and state of use. Press the **Fn2** button to show or hide the information in the monitor (11).

For Shooting

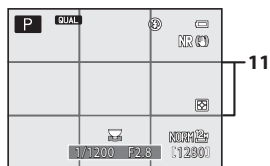
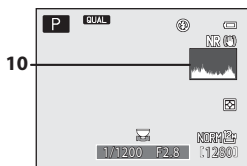
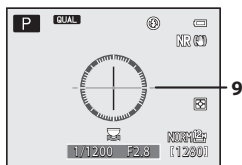
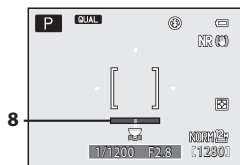
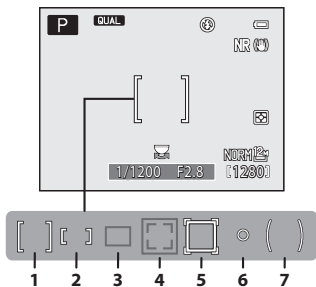

1	Shooting mode.....	30, 31	26	Image size.....	72
2	Focus mode.....	65	27	Easy panorama.....	44
3	Focus indicator.....	34	28	Movie options (normal speed movies).....	95
4	Quick menu icon.....	70, 95	29	Movie options (HS movies).....	95
5	Zoom indicator.....	33, 65	30	Number of exposures remaining (still images).....	26,  28
6	Zoom memory.....	74	31	Internal memory indicator.....	26
7	Zoom speed setting.....	99	32	Aperture value.....	49
8	AE/AF-L indicator.....	100,  6	33	Shutter speed.....	49
9	Flash mode.....	59	34	Exposure indicator.....	51
10	Speedlight.....	61	35	ISO sensitivity.....	72, 95
11	Flash exp. comp.....	74	36	Exposure compensation value.....	69
12	Battery level indicator.....	26	37	Active D-Lighting.....	74
13	Vibration reduction icon.....	99	38	Built-in ND filter.....	74
14	Eye-Fi communication indicator.....	101,  96	39	COOLPIX Picture Control.....	72, 95
15	Distortion control.....	74	40	White balance.....	72, 95
16	GPS reception.....	101,  114	41	Continuous shooting mode.....	45, 73
17	Noise reduction filter.....	74	42	Backlighting (HDR).....	43
18	Wind noise reduction.....	97	43	Auto bracketing.....	72
19	"Date not set" indicator.....	28, 99	44	Hand-held/tripod.....	41
20	Travel destination icon.....	99		Self-timer indicator.....	62
21	Print date.....	99	45	Remote control.....	58
22	Metering.....	73		Smile timer.....	63
23	<td>4, 101</td> <td></td> <td>Pet portrait auto release.....</td> <td>45</td>	4, 101		Pet portrait auto release.....	45
24	Movie recording time remaining.....	91, 92			
25	Image quality.....	72			



1	Focus area (for center)58, 67, 73, 85
2	Focus area (for manual)41, 42, 58, 67, 73
3	Focus area (auto, target finding AF).....58, 67, 73, 82
4	Focus area (face detection, pet detection)45, 58, 63, 67, 73, 83
5	Focus area (subject tracking)58, 67, 73,  51
6	Spot metering area.....73
7	Center-weighted area73
8	Virtual horizon (bars)11, 99,  75
9	Virtual horizon (circle)11, 99,  75
10	View/hide histograms11, 99,  75
11	View/hide framing grid11, 99,  75

For Playback

Full-frame playback (📖36)

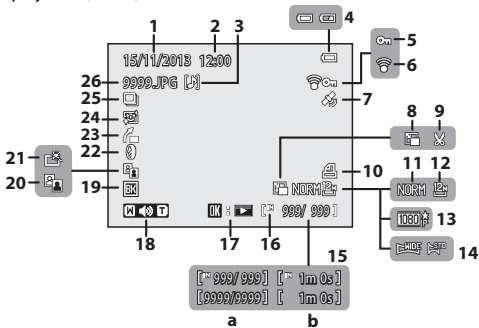

1	Date of recording	28	15	(a) Current image number/total number of images (b) Movie length
2	Time of recording.....	28	16	Internal memory indicator.....
3	Voice memo indicator.....	88	17	Easy panorama playback guide 6, 44, 📷4 Sequence playback guide 6, 37, 📷7 Movie playback guide..... 97
4	Battery level indicator.....	26	18	Volume indicator.....88, 97
5	Protect icon.....	88	19	Black border icon
6	Eye-Fi communication indicator.....	101, 📷96	20	D-Lighting icon
7	Recorded GPS information indicator.....	101, 📷113	21	Quick retouch icon.....
8	Small picture icon.....	88	22	Filter effects icon
9	Crop icon.....	86	23	Straighten icon
10	Print order icon	88	24	Skin softening icon
11	Image quality.....	72	25	Sequence display (when Individual pictures is selected)
12	Image size.....	72	26	File number and type..... 📷103
13	Movie options.....	95, 97		
14	Easy panorama indicator.....	44		

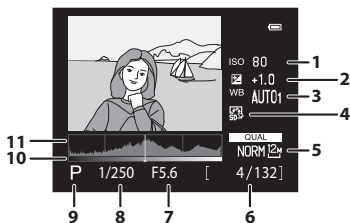
Tone level information display¹ (📖11)

1	ISO sensitivity.....	72	6	Current image number/ total number of images	
2	Exposure compensation value...	69	7	Aperture value.....	49
3	White balance.....	72	8	Shutter speed.....	49
4	COOLPIX Picture Control.....	72	9	Shooting mode ²	31
5	Image quality/Image size.....	72	10	Tone level ³	
			11	Histogram ⁴	

¹ You can check for loss of contrast detail in highlights and shadows from the histogram that is displayed, or the flashing display for each tone level. These provide guidelines when adjusting the image brightness with functions such as exposure compensation.

² **P** is displayed when the shooting mode **SCENE**, **EFFECTS** or **P** is selected.

³ The tone level indicates the brightness level. When the tone level to check is selected using the multi selector **◀▶**, the area of the image that corresponds to the selected tone level flashes.

⁴ A histogram is a graph showing the distribution of tones in the image. The horizontal axis corresponds to pixel brightness, with dark tones to the left and bright tones to the right. The vertical axis shows the number of pixels.

The Basics of Shooting and Playback

Preparation 1 Charge the Battery

1 Prepare the included battery charger.

If a plug adapter* is included with your camera, attach the plug adapter to the plug on the battery charger. Push the plug adapter firmly until it is securely held in place. Once the two are connected, attempting to forcibly remove the plug adapter could damage the product.

* The shape of the plug adapter varies according to the country or region in which the camera was purchased.

This step can be omitted if the plug adapter comes permanently bonded to the battery charger.

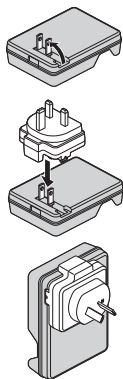

2 While pushing in the battery (①), set it into the battery charger (②).

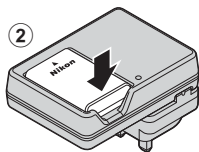
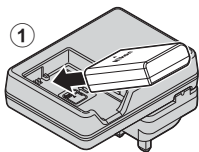

3 Plug the battery charger into an electrical outlet.

- CHARGE lamp starts flashing when charging starts.

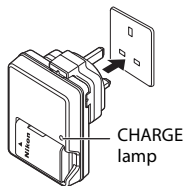

CHARGE lamp	Description
Flashes	The battery is charging.
On	The battery is fully charged. About 1 hour and 30 minutes are required to charge a fully exhausted battery.
Flashes quickly	<ul style="list-style-type: none"> • The battery is set incorrectly. Disconnect the battery charger from the electrical outlet, remove the battery, and then reset the battery to lie flat in the battery charger. • The ambient temperature is not suited to charging. Charge the battery indoors with an ambient temperature of 5°C to 35°C (41°F to 95°F). • There is a problem with the battery. Immediately disconnect the battery charger from the electrical outlet, and stop charging. Take the battery and battery charger to your retailer or Nikon-authorized service representative.

4 When charging is complete, remove the battery and then disconnect the battery charger from the electrical outlet.

Preparation 2 Insert the Battery

- 1 Open the battery-chamber/
memory card slot cover.

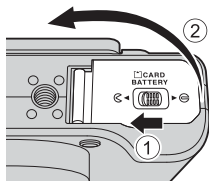

- 2 Insert the battery.

- Push the orange battery latch in the direction indicated by the arrow (1), and fully insert the battery (2).
- The battery locks into place when inserted correctly.

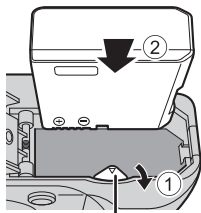

Battery latch

- ✓ Be Careful to Insert the Battery in Correct Direction**

Inserting the battery upside down or backwards could damage the camera.



- 3 Close the battery-chamber/
memory card slot cover.

- While the battery-chamber/memory card slot cover is open, the camera cannot be turned on.

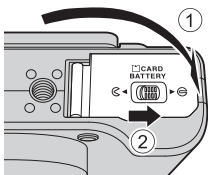

Removing the Battery

Turn the camera off and make sure that the power-on lamp and the monitor have turned off, and then open the battery-chamber/memory card slot cover.

Move the battery latch in the direction indicated by the arrow (①) to eject the battery (②).

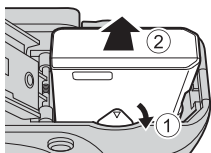

High Temperature Caution

The camera, battery, and memory card may be hot immediately after using the camera.

Preparation 3 Insert a Memory Card

- 1 Turn off the camera and open the battery-chamber/memory card slot cover.

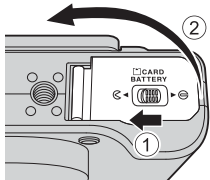

- 2 Insert the memory card.
 - Slide the memory card in until it clicks into place.

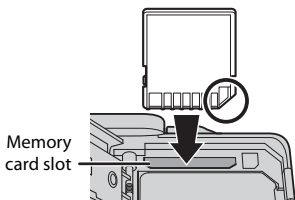

- ✓ Be Careful to Insert the Memory Card in Correct Direction**

Inserting the memory card upside down or backwards could damage the camera and the memory card.



- 3 Close the battery-chamber/memory card slot cover.

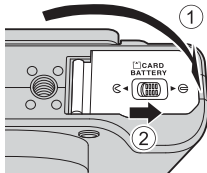

- ✓ Formatting Memory Cards**

The first time you insert a memory card that has been used in another device into this camera, make sure to format it with this camera. Insert the card into the camera, press the **MENU** button, and select **Format card** in the setup menu.

Removing Memory Cards

Turn the camera off and make sure that the power-on lamp and the monitor have turned off, and then open the battery-chamber/memory card slot cover.

Gently push the memory card into the camera (①) to partially eject the card (②).

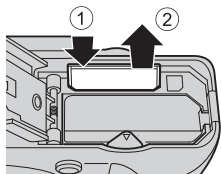

High Temperature Caution

The camera, battery, and memory card may be hot immediately after using the camera.

Internal Memory and Memory Cards

Camera data, including images and movies, can be saved either in the camera's internal memory or on a memory card. To use the camera's internal memory, first remove the memory card.

Approved Memory Cards

The following Secure Digital (SD) memory cards have been tested and approved for use in this camera.

- Memory cards with an SD Speed Class rating of 6 or faster are recommended for recording movies. When using a memory card with a lower Speed Class rating, movie recording may stop unexpectedly.

	SD memory cards	SDHC memory cards ²	SDXC memory cards ³
SanDisk	2 GB ¹	4 GB, 8 GB, 16 GB, 32 GB	64 GB, 128 GB
TOSHIBA	-	4 GB, 8 GB, 16 GB, 32 GB	64 GB
Panasonic	2 GB ¹	4 GB, 8 GB, 16 GB, 32 GB	64 GB
Lexar	-	4 GB, 8 GB, 16 GB, 32 GB	64 GB, 128 GB

¹ If the memory card will be used with a card reader or similar device, make sure that the device supports 2 GB cards.

² SDHC-compliant. If the memory card will be used with a card reader or similar device, make sure that the device supports SDHC.

³ SDXC-compliant. If the memory card will be used with a card reader or similar device, make sure that the device supports SDXC.



- Contact the manufacturer for details on the above cards. We cannot guarantee camera performance when using memory cards made by other manufacturers.

Step 1 Turn the Camera On

1 Open the monitor and remove the lens cap.

- See “Opening and Adjusting the Angle of the Monitor” (📖9) for more information.
- See “Attaching and Detaching the Lens Cap” (📖8) for more information.

2 Press the power switch.

- **If you are turning the camera on for the first time, see “Setting the Display Language, Date, and Time” (📖28).**
- The monitor turns on.
- To turn the camera off, press the power switch again.

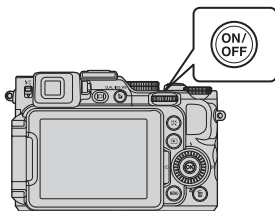

3 Check the battery level indicator and the number of exposures remaining.

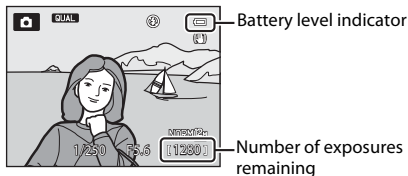

Battery level indicator

Display	Description
	The battery level is high.
	The battery level is low.
Battery exhausted.	The camera cannot capture images. Recharge the battery.



Number of Exposures Remaining

The number of images that can be taken is displayed.

- is displayed when no memory card is inserted in the camera, and images are saved in the internal memory.

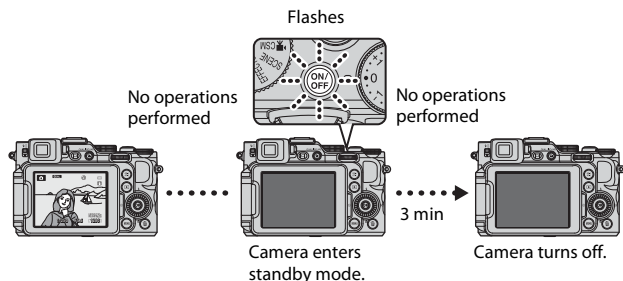
The Auto Off Function



- The time that elapses before the camera enters standby mode is about 1 minute. The time can be changed using the **Auto off** setting in the setup menu ( 99).
- While the camera is in standby mode, the monitor turns back on if you perform any of the following operations:
 - Press the power switch, shutter-release button, or  button.
 - Rotate the mode dial.
 - Open or close the monitor.



Monitor Display

Press the **Fn2** button to switch between showing and hiding the photo information or shooting information that is displayed in the monitor ( 11).

Setting the Display Language, Date, and Time

When the camera is turned on for the first time, the language-selection screen and the date and time setting screen for the camera clock are displayed.

- If you exit without setting the date and time,  will flash when the shooting screen is displayed.

- 1** Use the multi selector   to select the desired language and press the  button.

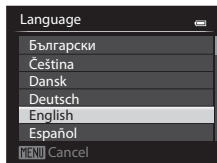

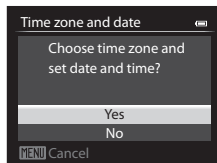

- 2** Select **Yes** and press the  button.

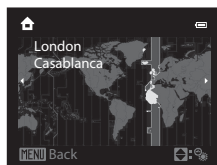

- 3** Select your home time zone and press the  button.



- To enable daylight saving time, press . When the daylight saving time function is enabled,  is displayed above the map.

To turn off the daylight saving time function, press .

- 4** Select the date format and press the  button.

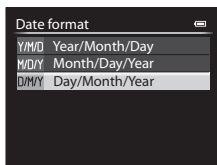

5 Set the date and time, and press the **OK** button.

- Select a field: Press **◀▶** (changes between **D**, **M**, **Y**, hour, and minute).
- Edit the date and time: Press **▲▼**.
Date and time can also be changed by rotating the multi selector or main command dial.
- Confirm the setting: Select the minute field and press the **OK** button.

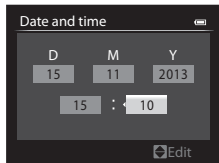

6 Select **Yes** and press the **OK** button.

- When settings are finished, the lens extends and the camera switches to shooting mode.

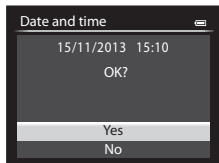

Changing the Language Setting and the Date and Time Setting

- You can change these settings using the **Language** and **Time zone and date** settings in the **Y** setup menu (📖99).
- You can enable or disable daylight saving time in the **Y** setup menu by selecting **Time zone and date** followed by **Time zone**. Enabling day light saving time moves the clock forward one hour, and disabling it moves the clock back one hour.

The Clock Battery

- The camera's clock is powered by a built-in backup battery. The backup battery charges when the main battery is inserted into the camera or when the camera is connected to an optional AC adapter, and it can run the clock for several days after about 10 hours of charging.
- If the camera's backup battery becomes exhausted, the date and time setting screen is displayed when the camera is turned on. Set the date and time again. See step 2 of "Setting the Display Language, Date, and Time" (📖28) for more information.

Imprinting the Shooting Date on Printed Images

- You can permanently imprint the shooting date on images as they are captured by setting **Print date** in the setup menu.
- If you want the shooting date to be printed without using the **Print date** setting, print using the ViewNX 2 software (📖104).

Step 2 Select a Shooting Mode

Rotate the mode dial to select a shooting mode.

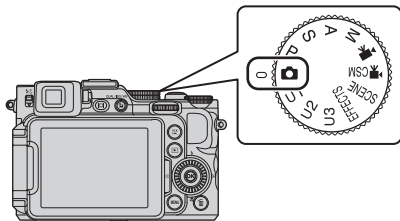

-  (auto) mode is used in this example. Rotate the mode dial to .



Notes About the Flash

In situations where a flash is needed, such as in dark locations or when the subject is backlit, make sure to raise the flash ( 59).

Available Shooting Modes

	Auto mode (📖38)
	Used for general shooting.
SCENE	Scene mode (📖39)
	Camera settings are optimized according to the scene that you select. When using scene auto selector, the camera automatically selects the optimum scene mode when you frame an image, making it even easier to take images using settings that suit the scene.
EFFECTS	Special effects (📖46)
	Effects can be applied to images during shooting.
P, S, A, M	mode (📖49)
	Select these modes for greater control over shutter speed and aperture value.
U1, U2, U3	User settings mode (📖55)
	Setting combinations that are frequently used for shooting can be saved. The saved settings can be immediately retrieved for shooting simply by rotating the mode dial to U1, U2 or U3 .
	Movie mode (📖91)
	You can record slow motion and fast motion movies, in addition to basic movies.
 CSM	Movie custom setting mode (📖91)
	You can use aperture-priority auto or manual mode, or change the settings for image recording.

Step 3 Frame a Picture

1 Hold the camera steady.

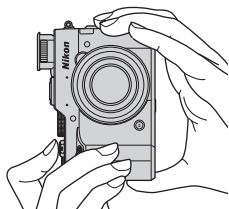

- Keep fingers and other objects away from the lens, flash, AF-assist illuminator, microphone, and speaker.
- When taking pictures in portrait (“tall”) orientation, turn the camera so that the flash is above the lens.

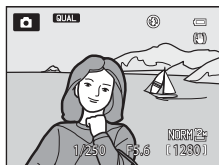

2 Frame the picture.



Viewfinder

By pressing the  button, you can shoot while looking through the viewfinder (10).

When Using a Tripod

- We recommend using a tripod to stabilize the camera in the following situations.
 - When shooting in dim lighting with the flash lowered, or in a shooting mode in which the flash is disabled
 - When using the telephoto setting
- When using a tripod to stabilize the camera during shooting, set **Vibration reduction** to **Off** in the setup menu (99) to prevent potential errors caused by this function.

Using the Zoom

When you move the zoom control, the zoom lens position changes.

- To zoom in closer to the subject: Move toward **T** (telephoto)
 - To zoom out and view a larger area: Move toward **W** (wide-angle)
- A zoom indicator is displayed at the top of the monitor when the zoom control is moved.
 - Digital zoom, which allows you to further magnify the subject up to approximately 4x the maximum optical zoom ratio, can be activated by moving and holding the zoom control toward **T** when the camera is zoomed in to the maximum optical zoom position.

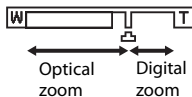
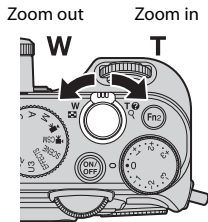

Digital Zoom and Interpolation

While using digital zoom, the image quality decreases due to interpolation when the zoom is increased beyond the  position.

The position of  moves to the right as the size of an image decreases.

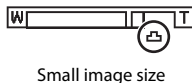

Step 4 Focus and Shoot

1 Press the shutter-release button halfway.

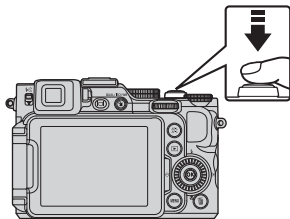

- When the subject is in focus, the focus area that includes the subject or focus indicator (📖 14) glows green (multiple focus areas can glow green).
- When you are using digital zoom, the camera focuses on the subject in the center of the frame and the focus area is not displayed. When the camera has focused, the focus indicator glows green.
- If the focus area or focus indicator flashes red, the camera is unable to focus. Modify the composition and try pressing the shutter-release button halfway again.



2 Without lifting your finger, press the shutter-release button the rest of the way down.



The Shutter-release Button

Press halfway		To set focus and exposure (shutter speed and aperture value), press the shutter-release button lightly until you feel a slight resistance. Focus and exposure remain locked while the shutter-release button is pressed halfway.
Press all the way		Press the shutter-release button all the way to release the shutter and take an image. Do not use force when pressing the shutter-release button, as this may result in camera shake and blurred images. Press the button gently.

Notes About Saving Images and Recording Movies

The indicator showing the number of exposures remaining or the indicator showing the maximum movie length flashes while images are being saved or while a movie is being recorded. **Do not open the battery-chamber/memory card slot cover or remove the battery or memory card** while an indicator is flashing. Doing this could result in loss of data, or in damage to the camera or the memory card.

Step 5 Play Back Images



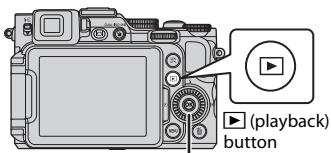

1 Press the (playback) button.

- If you press and hold down the  (playback) button while the camera is turned off, the camera turns on in playback mode.



Multi selector

2 Use the multi selector to select an image to display.

- Press and hold down     to scroll through the images quickly.
- Images can also be selected by rotating the multi selector or command dial.
- To return to shooting mode, press the  button or shutter-release button.

Display the previous image

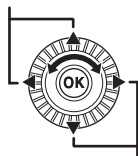

Display the next image

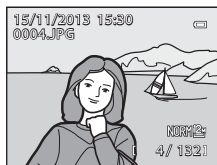





Switching the Information in the Monitor

Press the **Fn2** button to switch between showing and hiding the photo information or shooting information that is displayed in the monitor ( 11).

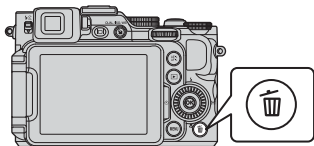
Step 6 Delete an Image

- 1 Press the  button to delete the image currently displayed in the monitor.



- 2 Use the multi selector   to select **Yes** and press the  button.

- The deleted image cannot be recovered.
- To cancel, select **No** and press the  button.

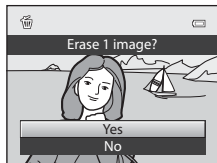





Notes About RAW and JPEG Images Recorded at the Same Time

When images taken with an **Image quality** (72) setting of **RAW (NRW) + Fine** or **RAW (NRW) + Normal** are deleted with the  button, both the RAW (NRW) and JPEG images that were recorded at the same time are deleted.

To delete only RAW (NRW) images or JPEG images, select **Erase selected NRW images** or **Erase selected JPEG images** in **Delete** of the playback menu (88).

Deleting Images in a Sequence

- If you press the  button and delete a key picture while only key pictures are displayed for sequences of images (89), all images in the sequence, including the key picture, are deleted.
- To delete individual images in a sequence, press the  button to display them one at a time and press the  button.

Deleting the Last Image Captured While in Shooting Mode

When using shooting mode, press the  button to delete the last image that was saved.

Deleting Multiple Images

To delete multiple images, select **Delete** from the playback menu (88).

Shooting Features

(Auto) Mode

Used for general shooting.

The camera selects the focus area for autofocus in accordance with the composition or subject.

- The camera automatically selects one or more of the 9 focus areas containing the subject closest to the camera. When the subject is in focus, the focus areas that are in focus glow green.
- See "Focusing" (📖 82) for more information.

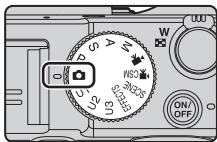

Functions Available in (Auto) Mode

- Flash mode (📖 59)
- Self-timer (📖 62)
- Focus mode (📖 64)
- Exposure compensation (📖 69)
- Quick menu (📖 70)

Scene Mode (Shooting Suited to Scenes)

When a scene is selected, camera settings are automatically optimized for the selected scene.

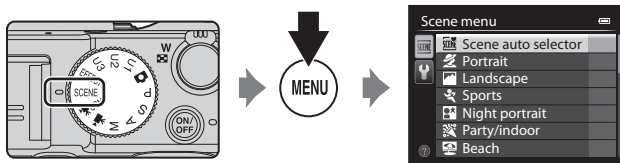

Press the **MENU** button to display the scene menu and select a scene using the multi selector.

Scene auto selector (default setting) (📖40)	Night landscape (📖41) ²
Portrait	Close-up (📖41)
Landscape ²	Food (📖42)
Sports (📖40) ¹	Museum (📖42) ¹
Night portrait (📖40) ³	Fireworks show (📖42) ^{2,3}
Party/indoor (📖41) ¹	Black and white copy (📖42) ¹
Beach ¹	Backlighting (📖43) ¹
Snow ¹	Panorama (📖44)
Sunset ^{2,3}	Pet portrait (📖45)
Dusk/dawn ^{2,3}	

¹ The camera focuses on the area in the center of the frame.

² The camera focuses at infinity.

³ Use of a tripod is recommended, because the shutter speed is slow. Set **Vibration reduction to Off** in the setup menu (📖99) when using a tripod to stabilize the camera during shooting.













To View a Description (Help Display) of Each Scene



Select a scene and move the zoom control (📖1) toward **T** (🔍) to view a description of that scene. To return to the original screen, move the zoom control toward **T** (🔍) again.

Tips and Notes

Scene auto selector

- When you point the camera at the subject, the camera automatically selects the optimum scene mode from the list below and adjusts the shooting settings accordingly.

	Portrait (close-up image of one to two persons)
	Portrait (shooting an image of three or more persons or shooting a composition with a large background area)
	Landscape
	Night portrait (close-up image of one to two persons)
	Night portrait (shooting an image of three or more persons or shooting a composition with a large background area)
	Night landscape <ul style="list-style-type: none">The camera shoots images continuously and combines and saves them as one image in the same way as when Hand-held in  (night landscape) (41) is selected.
	Close-up
	Backlighting (shooting non-human subjects)
	Backlighting (shooting human subjects)
	Other shooting scenes

- Depending upon shooting conditions, the camera may not select the desired scene mode. Should this occur, switch to  (auto) mode (30) or select the optimum scene mode for the subject manually.

Sports

- While the shutter-release button is held all the way down, the camera shoots up to about 6 images continuously at a rate of about 8 fps (when image quality is set to **Normal** and image size is set to  **4000x3000**).
- The frame rate for continuous shooting may become slow depending upon the current image quality setting, image size setting, the memory card used, or shooting condition.
- Focus, exposure, and hue are fixed at the values determined with the first image in each series.







Night portrait

- The flash always fires. Raise the flash before shooting.









Party/indoor

- To avoid the effects of camera shake, hold the camera steady. Set **Vibration reduction** to **Off** in the setup menu (99) when using a tripod to stabilize the camera during shooting.

Night landscape

- From the screen displayed after  **Night landscape** is selected, select  **Hand-held** or  **Tripod**.
-  **Hand-held** (default setting):
 - Press the shutter-release button all the way to capture a series of images which are combined into a single image and saved.
 - Once the shutter-release button is pressed all the way, hold the camera still until a still image is displayed. After taking an image, do not turn the camera off before the monitor switches to the shooting screen.
 - The angle of view (i.e., the area visible in the frame) seen in the saved image is narrower than that seen in the monitor at the time of shooting.
-  **Tripod**:
 - One image is captured at a slow shutter speed when the shutter-release button is pressed all the way.
 - Vibration reduction is disabled even when **Vibration reduction** (99) in the setup menu is set to **On**.

Close-up

- The focus mode (64) setting is changed to  (close range only) and the camera automatically zooms to the closest position at which it can focus.
- You can move the focus area. Press the  button, use the multi selector     or rotate it to move the focus area, and press the  button to apply the setting.

Food

- The focus mode (📖64) setting is changed to 🍷 (macro close-up) and the camera automatically zooms to the closest position at which it can focus.
- You can adjust hue by using the multi selector ▲▼. The hue setting is saved in the camera's memory even after the camera is turned off.
- You can move the focus area. Press the OK button, use the multi selector ▲▼◀▶ or rotate it to move the focus area, and press the OK button to apply the setting.

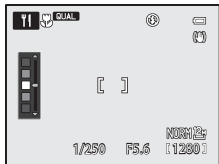

Museum

- The camera captures a series of up to 10 images while the shutter-release button is held all the way down, and the sharpest image in the series is automatically selected and saved (BSS (Best Shot Selector)).
- The flash does not fire.

Fireworks show

- The shutter speed is fixed at about 4 seconds.
- The zoom position moved one step toward the wide-angle position from the maximum optical zoom position cannot be used.



Black and white copy

- Use together with 🍷 (macro close-up) focus mode (📖64) when shooting subjects that are close to the camera.











Backlighting

- From the screen displayed after  **Backlighting** is selected, HDR (high dynamic range) composition can be set.
- **Off** (default setting): The flash fires to prevent the subject from being hidden in shadow. Shoot images with the flash raised.
- **Level 1-Level 3**: Use when taking images with very bright and dark areas in the same frame. Select **Level 1** when there is less difference between bright and dark areas, and **Level 3** when there is more difference between bright and dark areas.

Notes About HDR

- Use of a tripod is recommended. Set **Vibration reduction** in the setup menu (99) to **Off** when using a tripod to stabilize the camera.
- The angle of view (i.e., the area visible in the frame) seen in the saved image is narrower than that seen in the monitor at the time of shooting.
- When the shutter-release button is pressed all the way, the camera shoots images continuously and saves the following two images.
 - A non-HDR composite image
 - An HDR composite image in which the loss of details in highlights or shadows is minimized
- If there is only enough memory to save one image, an image processed by D-Lighting (88) at the time of shooting, in which dark areas of the image are corrected, is the only image saved.
- Once the shutter-release button is pressed all the way, hold the camera still until a still image is displayed. After taking an image, do not turn the camera off before the monitor switches to the shooting screen.
- Depending on the shooting conditions, dark shadows may appear around bright subjects and bright areas may appear around dark subjects. You can compensate by lowering the level setting.

Panorama

- From the screen displayed after  **Panorama** is selected, select  **Easy panorama** or  **Panorama assist**.
- **Easy panorama** (default setting): You can take a panorama image simply by moving the camera in the desired direction.
 - Shooting range can be selected from **Normal (180°)** (default setting) or **Wide (360°)**.
 - The zoom position is fixed at wide-angle.
 - Press the shutter-release button all the way down, remove your finger from the button, and then slowly pan the camera horizontally. Shooting ends when the camera captures the specified shooting range.
 - Focus and exposure are locked when shooting starts.
 - If you press the  button when a captured image is displayed in full-frame playback mode, the image scrolls automatically. The images cannot be edited on this camera.See "Using Easy Panorama (Shooting and Playback)" (2) for more information.
- **Panorama assist**: Use this mode when shooting a series of images that can later be joined on a computer to form a single panorama.
 - Use the multi selector  to select the direction in which images are to be joined and press the  button.
 - After shooting the first image, shoot the necessary number of images while confirming the seams. To finish shooting, press the  button.
 - Transfer taken images to a computer and use the **Panorama Maker** software (105) to join them in a single panorama.See "Using Panorama Assist" (5) for more information.



Notes About Printing Panorama Images

The entire image may not be able to be printed depending on the printer's settings. Additionally, printing may not be possible depending on the printer.

Pet portrait

- When you point the camera at a dog or cat, the camera detects the pet's face and focuses on it. By default, the shutter is automatically released when focus is acquired (pet portrait auto release).
- From the screen displayed after  **Pet portrait** is selected, select **Single** or **Continuous**.
 - **Single**: Whenever the detected face is in focus, the camera captures 1 image.
 - **Continuous**: Whenever the detected face is in focus, the camera captures 3 images continuously.

Pet Portrait Auto Release

- Press the multi selector  to change the **Pet portrait auto release** settings.
 - : The camera detects a dog or cat face and automatically releases the shutter when the detected face is in focus.
 - **OFF**: The camera does not release the shutter automatically, even if a dog or cat face is detected. Press the shutter-release button. The camera also detects human faces when **OFF** is selected.
- **Pet portrait auto release** is set to **OFF** after 5 bursts have been taken.
- Shooting is also possible by pressing the shutter-release button, regardless of the **Pet portrait auto release** setting. When **Continuous** is selected, you can take images continuously while holding down the shutter-release button all the way.

Focus Area

- When the camera detects a face, the face is displayed inside a yellow border. When the camera acquires focus on a face displayed inside a double border (focus area), the double border turns green. If no faces are detected, the camera focuses on the subject in the center of the frame.
- In some shooting conditions, the pet face may not be detected and other subjects may be displayed inside a border.

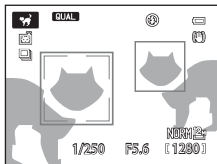

Special Effects Mode (Applying Effects When Shooting)

Effects can be applied to images during shooting.

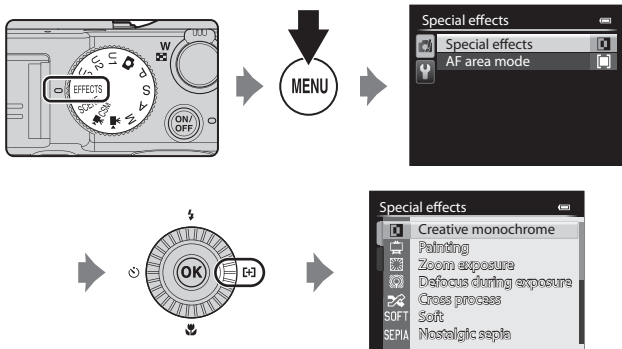

Press the **MENU** button to display the special effects menu and select an effect using the multi selector.

Creative monochrome
(default setting)

Creates monochrome photographs by adjusting the grainy feel and contrast. Monochrome photographs with the dark and light tones reversed can also be created (solarization).

- Rotate the main command dial to adjust grainy feel.
- Rotate the sub-command dial to adjust contrast.

Painting

Gives the image a painting-like appearance.

Zoom exposure*

Creates dynamic images converging toward the center of the frame by moving the zoom position from the wide-angle to telephoto zoom position until the shutter closes.

- The zooming magnification can be set to 2× or 3× (default setting) by rotating the main command dial.
- The zoom is fixed at the wide-angle end before shooting.
- **AF area mode** (📖 58, 73) is fixed at **Center (normal)**.
- The shutter speed is fixed at 2 seconds, and the effect can be produced only when the shooting mode icon on the shooting screen is green.
- When a shutter speed that is slow enough for zoom exposure cannot be obtained due to too bright a subject, etc., the shooting mode icon does not turn green, and the effect will not be produced.

Defocus during exposure*	<p>Creates images with a soft blur by varying focus slightly until the shutter closes.</p> <ul style="list-style-type: none"> • The effect can be produced only when the shooting mode icon on the shooting screen is green. • When a shutter speed that is slow enough for defocus during exposure cannot be obtained due to too bright a subject, etc., the shooting mode icon does not turn green, and the effect will not be produced. • The desired effect may not be produced depending on shooting conditions such as the distance to the subject.
Cross process	<p>Creates images with an unusual hue by converting a positive color image into negative or negative color image into positive.</p> <ul style="list-style-type: none"> • Rotate the main command dial to select hue.
Soft	<p>Softens the image by adding a slight blur to the entire image.</p>
Nostalgic sepia	<p>Adds a sepia tone and reduces the contrast to simulate the qualities of an old photograph.</p>
High key	<p>Gives the entire image a bright tone.</p>
Low key	<p>Gives the entire image a dark tone.</p>
Selective color	<p>Creates a black and white image in which only the specified color remains.</p> <ul style="list-style-type: none"> • Rotate the main command dial to select the color to be retained from the slider. • Press the OK button to hide the slider and cancel color selection. To display the slider again, press the OK button again.

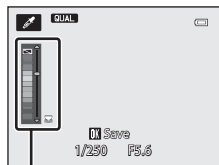

Slider

* Use of a tripod is recommended during **Zoom exposure** or **Defocus during exposure**. **Vibration reduction** will not function even if **Vibration reduction** in the setup menu is set to **On**.

- The focus area for autofocus differs depending on the setting of **AF area mode** (p. 58, 73).
- When **AF area mode** is set to **Auto** (default setting), the camera automatically selects one or more of the 9 focus areas containing the subject closest to the camera. When the subject is in focus, the focus areas that are in focus glow green.

Functions Available in Special Effects Mode

- AF area mode (📖58, 73)
- Flash mode (📖59)
- Self-timer (📖62)
- Focus mode (📖64)
- Exposure compensation (📖69)
- Special effects menu (📖46)
- Quick menu (📖70)

P, S, A, M Modes (Setting the Exposure for Shooting)

Images can be shot with greater control by setting the quick menu (📖70) or shooting menu (📖73) items in addition to setting the shutter speed or aperture value manually according to shooting conditions and requirements.

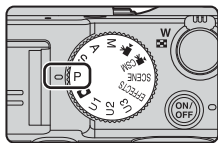

- The focus area for autofocus differs depending on the setting of **AF area mode** (📖58, 73).
- When **AF area mode** is set to **Center (normal)** (default setting), the camera focuses on the area in the center of the frame.

Rotate the command dial to set the shutter speed and aperture value.

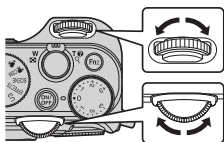

Sub-command dial

Main command dial

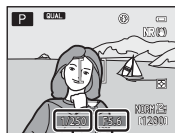

Shutter speed

Aperture value

Exposure mode	Shutter speed (📖53)	Aperture value (📖50)
P Programmed auto (📖51)	Automatically adjusted (flexible program is enabled by the main command dial).	
S Shutter-priority auto (📖51)	Adjusted by the main command dial.	Automatically adjusted.
A Aperture-priority auto (📖51)	Automatically adjusted.	Adjusted by the sub-command dial.
M Manual (📖51)	Adjusted by the main command dial.	Adjusted by the sub-command dial.



More Information

See “Customize command dials” (📖100) for more information.

Exposure

The procedure for shooting images at the desired brightness (exposure) by adjusting the shutter speed or aperture value is called “determine exposure”. The sense of dynamism and amount of background defocus in images to be shot vary depending on the combinations of shutter speed and aperture value even if the exposure is the same.

Adjusting the Shutter Speed

In **S** mode, the range is from a maximum of 1/4000 to 15 seconds.

In **M** mode, the range is from a maximum of 1/4000 to 60 seconds.

See “The Control Range of the Shutter Speed” (📖 53) for more information.



Faster 1/1000 s



Slower 1/30 s

Adjusting the Aperture Value

In **A** and **M** modes, the range is from f/2 to 8 (wide-angle position) and from f/4 to 8 (telephoto zoom position).



Larger aperture (Small f-number)
f/2



Smaller aperture (Large f-number)
f/8



Aperture Value (F-number) and Zoom

Large apertures (expressed by small f-numbers) let more light into the camera, and small apertures (large f-numbers) let less light.

The aperture value of the zoom lens of this camera changes depending on the zoom position. When zooming to the wide-angle position and telephoto zoom position, the aperture values are f/2 and f/4, respectively.

- When **Fixed aperture** (📖 99) is set to **On**, zooming can be performed with minimum changes in the aperture value.

P (Programmed auto)

Use for automatic control of the exposure by the camera.

- Different combinations of shutter speed and aperture value can be selected without changing the exposure by rotating the main command dial ("flexible program"). While flexible program is in effect, a flexible program mark (**PK**) is displayed next to the mode indicator (**P**) in the upper left of the monitor.
- To cancel flexible program, rotate the main command dial until the flexible program mark (**PK**) is no longer displayed, or press the AE-L/AF-L button while pressing the **Fn1** button. Selecting another shooting mode, or turning off the camera, also cancels flexible program.

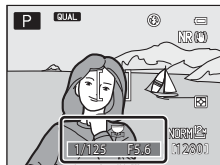

S (Shutter-priority auto)

Use to shoot fast moving subjects at a fast shutter speed, or use to emphasize the movements of a moving subject at a slow shutter speed.

- The shutter speed can be adjusted by rotating the main command dial.

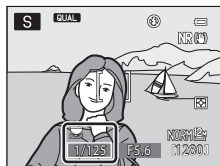

A (Aperture-priority auto)

Use to bring subjects including both the foreground and background into focus or blur the subject's background intentionally.

- The aperture value can be adjusted by rotating the sub-command dial.

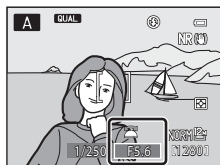

M (Manual)

Use to control the exposure according to shooting requirements.

- When adjusting the aperture value or shutter speed, the degree of deviation from the exposure value measured by the camera is displayed in the exposure indicator of the monitor. The degree of deviation in the exposure indicator is displayed in EVs (-3 to +3 EV in increments of 1/3 EV).
- The shutter speed can be adjusted by rotating the main command dial and the aperture value can be adjusted by rotating the sub-command dial.

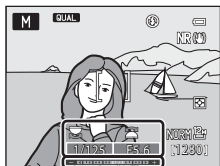

Exposure indicator

Notes About Shooting

- When zooming is performed after the exposure is set, exposure combinations or aperture value may be changed.
- When the subject is too dark or too bright, it may not be possible to obtain the appropriate exposure. In such cases, the shutter speed indicator or aperture value indicator flashes when the shutter-release button is pressed halfway (except when the **M** mode is used). Change the shutter speed setting or aperture value.

Notes About ISO Sensitivity

When **ISO sensitivity** (📖72) is set to **Auto** (default setting), **ISO 80-200**, **ISO 80-400** or **ISO 80-800**, the ISO sensitivity in **M** mode is fixed at ISO 80.

Built-in ND Filter

When the subject is too bright, set **Built-in ND filter** in the shooting menu (📖73) to reduce the light and shoot.

Functions Available in P, S, A, M Modes

- AF area mode (📖58, 73)
- Flash mode (📖59)
- Self-timer (📖62)
- Focus mode (📖64)
- Exposure compensation (📖69)
- Quick menu (📖70)
- Shooting menu (📖73)
- Setup menu (📖99)

The Control Range of the Shutter Speed

The control range of the shutter speed differs depending on the aperture value or the ISO sensitivity setting. Additionally, the control range changes in the following continuous shooting settings.

P, S, A, M Modes

Setting		Control range	
		P, S, A mode	M mode
ISO sensitivity ( 72) ¹	Auto ² , ISO 80-200 ² , ISO 80-400 ² , ISO 80-800 ²	1/4000 ³ - 1 s	1/4000 ³ - 60 s
	ISO 80, 100	1/4000 ³ - 15 s	
	ISO 125	1/4000 ³ - 13 s	
	ISO 160	1/4000 ³ - 10 s	
	ISO 200	1/4000 ³ - 8 s	
	ISO 250	1/4000 ³ - 6 s	
	ISO 320	1/4000 ³ - 5 s	
	ISO 400	1/4000 ³ - 4 s	1/4000 ³ - 30 s
	ISO 500	1/4000 ³ - 3 s	
	ISO 640	1/4000 ³ - 2.5 s	
	ISO 800	1/4000 ³ - 2 s	1/4000 ³ - 15 s
	ISO 1000	1/4000 ³ - 1.6 s	
	ISO 1250	1/4000 ³ - 1.3 s	
	ISO 1600	1/4000 ³ - 1 s	
	ISO 2000	1/4000 ³ - 1/1.3 s	1/4000 ³ - 8 s
	ISO 2500	1/4000 ³ - 1/1.6 s	
	ISO 3200	1/4000 ³ - 1/2 s	
	Hi 1	1/4000 ³ - 1/4 s	1/4000 ³ - 2 s

Setting		Control range	
		P, S, A mode	M mode
Continuous ( 73)	Continuous H, Continuous M, Continuous L, BSS	1/4000 ³ - 1/8 s	1/4000 ³ - 1/8 s
	Multi-shot 16	1/4000 - 1/30 s	1/4000 - 1/30 s
	Continuous H: 120 fps	1/4000 - 1/125 s	1/4000 - 1/125 s
	Continuous H: 60 fps	1/4000 - 1/60 s	1/4000 - 1/60 s
	Intvl timer shooting	1/4000 ³ - 1 s	1/4000 ³ - 1 s

¹ The ISO sensitivity setting is restricted depending on the continuous shooting setting (78).

² In **M** mode, the ISO sensitivity is fixed at ISO 80.

³ The maximum shutter speed value varies depending on the aperture value. The shutter speed becomes slower when the aperture value is smaller. When the aperture value is set to f/2 (wide-angle position) or f/4 (telephoto zoom position), the shutter speed can be set to maximum 1/2000 second. When the aperture value is set to f/4.5 to f/8 (wide-angle position) or f/7.1 to f/8 (telephoto zoom position), the shutter speed can be set to maximum 1/4000 second.

During Movie Custom Setting Mode

Setting		Control range
Shooting mode ( 96)	A Mode	1/8000 - 1/30 s
	M Mode	1/4000 - 1/30 s

U1, U2 and U3 (User Settings Modes)

Setting combinations that are frequently used for shooting (User settings) can be saved in **U1**, **U2** and **U3**. Shooting is possible in **P** (Programmed auto), **S** (Shutter-priority auto), **A** (Aperture-priority auto) or **M** (Manual).

Rotate the mode dial to **U1**, **U2** or **U3** to retrieve the settings saved in **Save user settings**.

- Frame the subject and shoot with these settings, or change the settings as required.
- The setting combinations that are retrieved when the mode dial is rotated to **U1**, **U2** or **U3** can be changed as many times as you want in **Save user settings**.

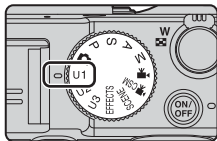



Saving Settings in U1, U2 or U3 Mode (Save User Settings)

The frequently used settings for shooting can be changed and saved in **U1**, **U2** and **U3**.

1 Rotate the mode dial to **U1**, **U2** or **U3**.

2 Change to a frequently used combination of shooting settings.

- Set the flash mode (📖59) or focus mode (📖64).
- Display the quick menu by pressing the  button (📖70).
- Press the **MENU** button to display the menu and switch between tabs with the multi selector (📖13).
 - **U1, U2, U3** tabs: Display the specialized menus for **U1**, **U2** and **U3** (📖75).
 - **P, S, A, M** tabs: Display the shooting menus (📖73).

3 After changing the settings, use the multi selector  to select **Save user settings** in the specialized menu for **U1**, **U2** or **U3**, and press the  button.

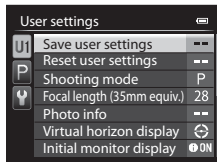

4 Select **Yes** and press the **OK** button.

- The current settings are saved.
- Move the zoom control toward **T** (Q) to display the settings. Move toward **T** (Q) again to return to the Save user settings screen.

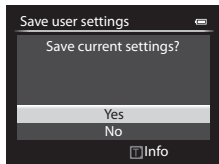

✓ The Clock Battery

If the internal clock battery (🔋29) is exhausted, the settings saved in **U1**, **U2** or **U3** will be reset. Writing down any important setting is recommended.

📌 Confirmation Screen of User Settings

Move the zoom control toward **T** (Q) in step 4 of **Save user settings** to display the settings on the screen.

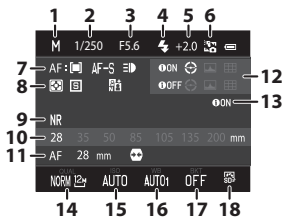

- | | |
|---|---|
| 1 Shooting mode | 10 Zoom memory |
| 2 Shutter speed (S or M mode) | 11 Focus mode, Focal length (35mm equiv.), Distortion control |
| 3 Aperture value (A or M mode) | 12 Photo info, Virtual horizon display |
| 4 Flash mode | 13 Initial monitor display |
| 5 Flash exp. comp. | 14 Image quality, Image size |
| 6 Flash control | 15 ISO sensitivity |
| 7 AF area mode, Autofocus mode, AF assist | 16 White balance |
| 8 Metering, continuous shooting mode, Active D-Lighting | 17 Auto bracketing |
| 9 Noise reduction filter | 18 Picture Control |

Functions Available in U1, U2 and U3 Modes

- Flash mode (📖59)
- Self-timer (📖62)
- Focus mode (📖64)
- Exposure compensation (📖69)
- Quick menu (📖70)
- Shooting menu (📖73)
- Specialized menu for U1, U2 or U3 (📖75)
- Setup menu (📖99)

Resetting for U1, U2 and U3

If **Reset user settings** is selected in specialized menu for U1, U2 or U3, the settings that are saved in the user settings are reset as follows:

- Specialized menus for U1, U2 and U3 (📖75): **Shooting mode: P**
Programmed auto, Focal length (35mm equiv.): 28 mm, Photo info:
 information hidden, **Virtual horizon display: Circle, Initial monitor display:**
Show info, Flash mode: ~~⚡~~AUTO Auto, Focus: AF Autofocus, Self-timer: Off, AF
assist: Auto
- Shooting menu, quick menu: Same as the default setting for each item.

Functions That Can Be Set Using the Multi Selector

The functions that are available vary with the shooting mode, as shown below.

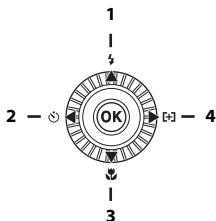

Function		SCENE	EFFECTS	P, S, A, M, U1, U2, U3	CSM
1 Flash mode (📖59)	✓	3	3	✓	–
Self-timer (📖62)	✓		✓	✓	✓
2 Smile timer (📖63)	✓		–	✓	–
Remote control ¹	✓		✓	✓	✓
3 Focus mode (📖64)	✓		✓	✓	✓
4 AF area mode ²	–	–	3	✓	–

¹ Set this function to release the shutter with the Remote Control ML-L3 (available separately) (🔗106).

² Set the method of how the camera selects the focus area for autofocus (📖73). Set **Multi selector right press** to **Off** in the setup menu (📖99) if you do not want to display the AF area mode setting when the multi selector is pressed.

³ Availability depends on the setting. See “Default Settings” (📖67) for more information.

Using the Flash

You can shoot images with a flash by raising the built-in flash. You can set the flash mode to match the shooting conditions.

1 Lower the ⚡ (flash pop-up) control to raise the flash.

- When the flash is lowered, flash operation is disabled and Ⓜ is displayed.

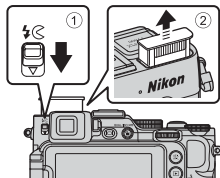

2 Press the multi selector ▲ (⚡).

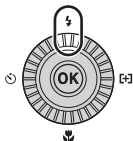

3 Select the desired flash mode (Ⓜ60) and press the OK button.

- When the manual flash is selected, select the flash output and press the OK button.
- If a setting is not applied by pressing the OK button within a few seconds, the selection will be canceled.



✓ Flash Status Display

The status of the flash can be confirmed with the flash mode icon at the top of the monitor by pressing the shutter-release button halfway.

- On: The flash fires in accordance with the flash mode when you press the shutter-release button all the way down. When ⓂAUTO (auto) is set, the flash fires when ⚡ is displayed.
- Flashing: The flash is charging. The camera cannot shoot images.
- Off: The flash does not fire when an image is taken.

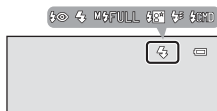

Available Flash Modes



Auto

The flash fires when necessary, such as in dim lighting.

- The flash mode icon on the shooting screen is displayed only immediately after the setting is made.



Auto with red-eye reduction

Reduce red-eye in portraits caused by the flash (📖61).



Off

The flash does not fire.

- Available when an external flash unit (optional) is attached.
- We recommend using a tripod to stabilize the camera when shooting in dark surroundings.



Fill flash

The flash fires whenever an image is taken. Use to “fill-in” (illuminate) shadows and backlit subjects.



Manual

Fill flash fires at the flash output set for the built-in flash or an optional flash unit whose flash output can be set on the camera.

- Select the flash output from **M** $\frac{1}{2}$ **FULL** (full flash), **M** $\frac{1}{2}$, **M** $\frac{1}{4}$, **M** $\frac{1}{8}$, **M** $\frac{1}{16}$, **M** $\frac{1}{32}$, **M** $\frac{1}{64}$ and **M** $\frac{1}{128}$ (only when an optional flash unit is used). For example, when **M** $\frac{1}{16}$ is selected, the flash output is 1/16 of the full flash.



Slow sync

Suited to evening and night portraits that include background scenery. Fill flash fires to illuminate the main subject; slow shutter speeds are used to capture background at night or under dim lighting.



Rear-curtain sync

Fill flash fires just before the shutter closes, creating the effect of a stream of light behind moving subjects.



Commander mode

The camera's built-in flash emits low-level flashes and an off-camera optional flash unit is controlled wirelessly as a remote flash (📖60). The Speedlight fires according to the **Commander mode** options set in the shooting menu (📖73).

- Not available when an optional flash unit is attached.
- Can be used when **P**, **S**, **A**, **M**, **U1**, **U2** or **U3** mode is selected.

✓ High Temperature Caution



If you are taking images repeatedly with the flash within a short period of time, the flash unit and its surrounding area can become hot. Before lowering the flash, make sure to allow the flash unit and its surrounding area to cool down.

📎 Lowering the Flash

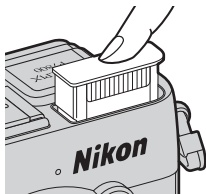
When not using the flash, gently push to lower the flash until it clicks shut.



📎 The Flash Mode Setting

- The setting may not be available with some shooting modes.
- The setting applied in the following situations is saved in the camera's memory even after the camera is turned off.
 - When shooting mode **P**, **S**, **A** or **M** is used
 - When  (auto with red-eye reduction) is selected in  (auto) mode



📎 Red-eye Reduction

If the camera detects red-eye while saving an image, the affected area is processed to reduce red-eye before the image is saved.

Note the following when shooting:

- More time than usual is required to save images.
- Red-eye reduction may not produce the desired results in all situations.
- In some cases, red-eye reduction may be applied to areas of an image unnecessarily. In these cases, select another flash mode and take the image again.

📎 External Flash Unit

When an optional Speedlight or wireless Speedlight commander is attached to the accessory shoe ()1), the built-in flash is set to off. While the  icon (Speedlight indicator) is lit on the shooting screen, the Speedlight flash mode is displayed in the monitor.

See "Speedlights (External Flash Unit)" (108) for more information.

Using the Self-timer

The camera is equipped with a self-timer that releases the shutter about 10 seconds, 2 seconds or 1 second after you press the shutter-release button. Set **Vibration reduction to Off** in the setup menu (📖99) when using a tripod to stabilize the camera during shooting.

- 1 Press the multi selector ◀ (🕒).

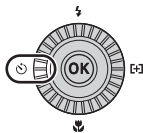

- 2 Select 🕒10s (or 🕒2s, 🕒1s), and press the OK button.

- To change the time for self-timer, press ▶ before pressing the OK button.
- 🕒10s (10 seconds): Use on important occasions, such as weddings.
- 🕒2s (2 seconds), 🕒1s (1 second): Use to prevent camera shake.
- If a setting is not applied by pressing the OK button within a few seconds, the selection will be canceled.
- When the shooting mode is **Pet portrait** scene mode, 🐾 (pet portrait auto release) is displayed (📖45). The self-timer cannot be used.

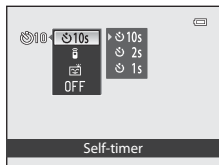

- 3 Frame the picture and press the shutter-release button halfway.

- Focus and exposure are set.

- 4 Press the shutter-release button the rest of the way down.

- Countdown starts. The self-timer lamp flashes and then glows steadily about one second before the shutter is released (except when 🕒1s is set).
- When the shutter is released, the self-timer is set to **OFF**.
- To stop the countdown, press the shutter-release button again.

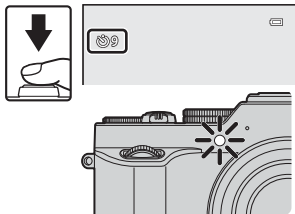

Shooting Smiling Faces Automatically (Smile Timer)

When the camera detects a smiling face, you can take an image automatically without pressing the shutter-release button.

- This function can be used when the shooting mode is  (auto), P, S, A, M, U1, U2, U3, scene mode **Portrait** or **Night portrait**.

1 Press the multi selector .

- Change any flash mode, exposure, or shooting menu settings before pressing .

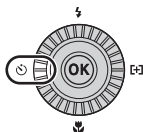

2 Select , and press the .

- If a setting is not applied by pressing the  button within a few seconds, the selection will be canceled.

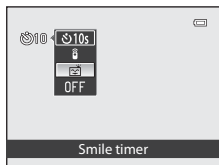

3 Frame the picture and wait for the subject to smile without pressing the shutter-release button.

- Point the camera at a human face.
- If the camera detects that the face framed by the double border is smiling, the shutter is automatically released.
- Whenever the camera detects a smiling face, it automatically releases the shutter.

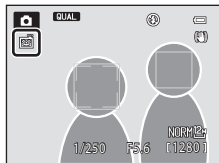

4 End automatic shooting.

- To end automatic shooting with smile timer, return to step 1 and select **OFF**.

Notes About Smile Timer

Under some shooting conditions, the camera may be unable to detect faces or detect smiles (83). The shutter-release button can also be used for shooting.

When the Self-timer Lamp Flashes

When using smile timer, the self-timer lamp flashes when the camera detects a face and flashes quickly immediately after the shutter is released.

Using Focus Mode

Set the focus mode according to the distance to the subject.

- 1 Press the multi selector ▼ (👉).

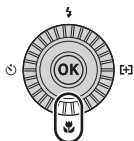

- 2 Select the desired focus mode and press the **OK** button.

- If a setting is not applied by pressing the **OK** button within a few seconds, the selection will be canceled.

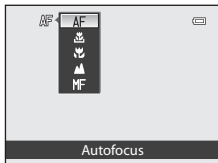

Available Focus Modes

AF

Autofocus

The camera automatically adjusts the focus according to the distance to the subject. Use when the distance from the subject to the lens is 50 cm (1 ft 8 in.) or more, or 80 cm (2 ft 8 in.) or more at the maximum telephoto zoom position.

- The focus mode icon on the shooting screen is displayed only immediately after the setting is made.



Close range only/ Macro close-up

Set when taking close-up images.

When the zoom ratio is set to a position where / and the zoom indicator glow green, the camera can focus on subjects as close as approximately 10 cm (4 in.) from the lens. When the zoom is at the position where is displayed, the camera can focus on subjects as close as approximately 2 cm (0.8 in.) from the lens.

- When using the maximum telephoto zoom position, the camera can focus on subjects as close as approximately 45 cm (1 ft 6 in.) from the lens.
- When using (close range only), the camera focuses on subjects in close range. The camera may not be able to focus on subjects at far distances.



Infinity

Use when shooting distant scenes through window glass or when shooting landscapes.

The camera automatically adjusts the focus near infinity.

- The camera may not be able to focus on nearby objects.
- The flash mode is set to (off).

MF

Manual focus

The focus can be adjusted on any subject at a distance from approximately 2 cm (0.8 in.) to infinity from the lens (66). The closest distance at which the camera can focus varies depending on the zoom position.



Notes About Shooting with the Flash

The flash may be unable to light the entire subject at distances of less than 50 cm (1 ft 8 in.).



Focus Mode Setting

- The setting may not be available with some shooting modes.
- For shooting modes **P**, **S**, **A** and **M**, the setting is saved in the camera's memory even after the camera is turned off.

Taking Images with Manual Focus



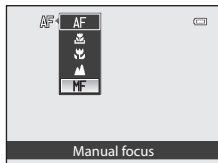
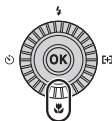

Available when the shooting mode is **P**, **S**, **A**, **M**, **U1**, **U2**, **U3**, special effects mode, **Sports** scene mode, movie mode or movie custom setting mode.

- Press the multi selector , select **MF** (manual focus), and then press the **OK** button.

- An enlarged view of the center area of the frame is displayed.



- Use the multi selector to adjust the focus while checking the enlarged view.

- Press  to move the focus farther away and press  to move it closer.
- The focus can be adjusted in higher detail by rotating the multi selector than pressing  .
- When  is pressed, first the camera focuses with autofocus, and then the manual focus can be operated. When a confirmation dialog is displayed, select **Yes** and press the **OK** button so that the camera focuses on the subject in the center of the frame with autofocus.
- Press the shutter-release button halfway to check the composition. Press the shutter-release button all the way to take the image.

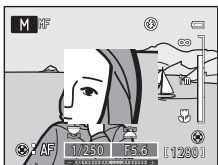

- Press the **OK** button.

- The set focus is locked.
- Press the shutter-release button all the way to take the image.
- To readjust the focus, press the **OK** button to display the screen in step 2.

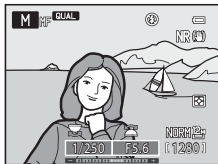





























































MF (Manual Focus)

- The digits displayed for the gauge on the right of the monitor in step 2 serve as a guideline for the distance to a subject that is in focus when the gauge indicates the center. To change the unit of this gauge, use **MF distance indicator units** in the setup menu (99).
- The actual range at which the subject can be in focus varies depending on the aperture value and zoom position. To see whether the subject is in focus, check the image after shooting.

Default Settings

The default settings for each shooting mode are described below.

Shooting mode	Flash mode ( 59)	Self-timer ( 62)	Focus mode ( 64)	AF area mode ( 73)
 (auto)	 AUTO	OFF ¹	AF ²	–
EFFECTS (special effects)	 ³	OFF	AF	 ⁴
P, S, A, M	 AUTO	OFF ¹	AF	
U1, U2, U3 (User settings)	 AUTO	OFF ¹	AF	
 (movie),  CSM (movie custom setting)	 ⁵	OFF	AF	–
Scene				
 (scene auto selector)	 AUTO ⁶	OFF	AF ⁵	–
 (portrait)		OFF ¹	AF ⁵	–
 (landscape)	 ⁵	OFF	 ⁵	–
 (sports)	 ⁵	OFF	AF ⁷	–
 (night portrait)	 ⁸	OFF ¹	AF ⁵	–
 (party/indoor)	 ⁹	OFF	AF ⁵	–
 (beach)	 AUTO	OFF	AF ¹⁰	–
 (snow)	 AUTO	OFF	AF ¹⁰	–
 (sunset)	 ⁵	OFF	 ⁵	–
 (dusk/dawn)	 ⁵	OFF	 ⁵	–
 (night landscape)	 ⁵	OFF	 ⁵	–
 (close-up)	 ⁵	OFF	 ⁵	–
 (food)	 ⁵	OFF	 ⁵	–
 (museum)	 ⁵	OFF	AF ¹⁰	–
 (fireworks show)	 ⁵	OFF	 ⁵	–
 (black and white copy)	 ⁵	OFF	AF ¹⁰	–
 (backlighting)	 ¹¹	OFF	AF ⁵	–
 (panorama)	 ¹²	OFF	AF ¹⁰	–
 (pet portrait)	 ⁵	 ¹³	AF ¹⁰	–

- 1 Smile timer can also be selected.
- 2 **MF** (manual focus) cannot be selected.
- 3 The default setting is **SAUTO** (auto) when **Creative monochrome** or **Cross process** is selected.
The flash is fixed at **⊖** (off) when **Zoom exposure** or **Defocus during exposure** is selected.
- 4 **⊞** (subject tracking) and **⊞** (target finding AF) are not available.
The AF area mode is fixed at **Center (normal)** when **Zoom exposure** is selected.
- 5 The setting cannot be changed.
- 6 The camera automatically selects the flash mode appropriate for the scene it has selected. The setting cannot be changed when using the built-in flash.
- 7 **AF** (autofocus) or **MF** (manual focus) can be selected.
- 8 The setting cannot be changed. The flash mode setting is fixed at fill flash with slow sync and red-eye reduction.
- 9 May switch to slow sync with red-eye reduction flash mode.
- 10 **AF** (autofocus) or **⊞** (macro close-up) can be selected.
- 11 When **HDR** is set to **Off**, the flash mode is fixed at **⊞** (fill flash). When **HDR** is set to other than **Off**, the flash mode is fixed at **⊖** (off).
- 12 The setting cannot be changed when using **Easy panorama**.
- 13 Pet portrait auto release (**⊞** 45) can be set to on or off. Self-timer and remote control cannot be used.

Functions That Can Be Set Using the Exposure Compensation Dial

Adjusting Brightness (Exposure Compensation)

You can adjust overall image brightness.

Select the compensation value by rotating the exposure compensation dial.

- To brighten the image, set a positive (+) value.
- To darken the image, set a negative (-) value.
- When set to a value other than "0", the exposure compensation dial mark turns on when shooting.

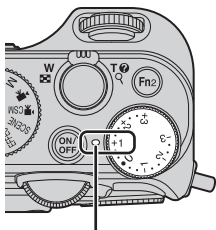

Exposure compensation dial mark

Exposure Compensation Value

- If the exposure compensation value is set to a value other than 0.0 when the shooting mode is **M** (manual) mode, the exposure is not compensated and the standard value of exposure indicator will change.
- When the shooting mode is **Fireworks show** scene mode (📖42), exposure compensation cannot be used.
- When the exposure compensation is set while using a flash, the compensation is applied to both the background exposure and to the flash output.

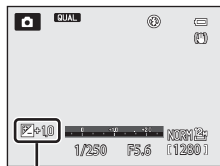



Exposure compensation value

Exposure Compensation During Movie Recording

- The range of exposure compensation values that can be set is between -2 and +2.
- Once recording starts, the compensation value cannot be changed.
- If the exposure compensation value is set to a value other than 0.0 when **Shooting mode** (📖96) of the movie custom setting is **Manual**, the exposure is not compensated and the standard value of the exposure indicator will not change either.

Functions That Can Be Set Using the Button (Quick Menu: When Shooting Still Images)



The functions that can be set vary depending on the shooting mode, as shown below.

Function		P, S, A, M, U1, U2, U3	SCENE	EFFECTS
QUAL Image quality/Image size	✓	✓	✓	✓
ISO ISO sensitivity	-	✓	-	-
WB White balance	-	✓	-	-
BKT Auto bracketing	-	✓	-	-
 My Menu	-	✓	-	-
 Picture Control	-	✓	-	-

Basic Quick Menu Operations

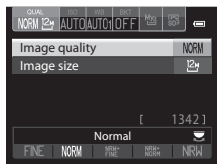
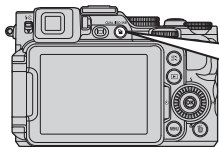
- 1 Press the  button.



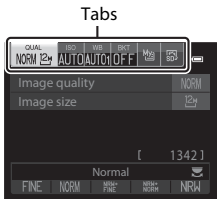

- 2 Use the multi selector   to move to the tabs at the top of the screen.

- You can also move to the tabs by rotating the sub-command dial.



3 Use ◀▶ to select the tab for the function to be set.

- You can also select a tab by rotating the main command dial.
 - QUAL** Image quality/Image size
 - * **Movie options** will be shown when the mode dial is rotated to  or  CSM.
 - ISO** ISO sensitivity
 - WB** White balance
 - BKT** Auto bracketing
 - My** My Menu
 - PC** Picture Control

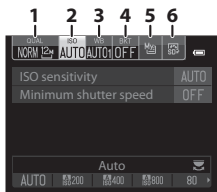

4 Use ▲▼ to select an item and change the setting using ◀▶.











- You can also change the setting by rotating the main command dial.



5 Press the button or button when setting is complete.

- You can also press the shutter-release button to finish setting.

Available Quick Menu

Option	Description	
QUAL Image quality/Image size	Allows you to set the image quality (compression ratio) and image size used when saving images. <ul style="list-style-type: none"> • Default setting: Normal (image quality),  4000x3000 (image size) 	 27
ISO ISO sensitivity	Allows you to control the camera's sensitivity to light. <ul style="list-style-type: none"> • Default setting: Auto When Auto is selected, ISO is displayed in the monitor while shooting if ISO sensitivity increases. <ul style="list-style-type: none"> • In M (manual) mode, when set to Auto, ISO 80-200, ISO 80-400 or ISO 80-800, the ISO sensitivity is fixed at ISO 80. 	 33
WB White balance	Allows you to adjust white balance to suit the weather conditions or light source in order to make the colors in images match what you see with your eyes. <ul style="list-style-type: none"> • Default setting: Auto (normal) 	 35
BKT Auto bracketing	Continuous shooting can be performed while changing the exposure (brightness) automatically with the shutter speed (Tv), aperture value (Av) or ISO sensitivity (Sv), or multiple images can be recorded while varying the white balance (WB). <ul style="list-style-type: none"> • Default setting: OFF 	 38
 My Menu	Only the menu items that are frequently used for shooting can be displayed. <ul style="list-style-type: none"> • Options that are displayed in My Menu can be changed from Customize My Menu in the setup menu (99). 	 93
 Picture Control (COOLPIX Picture Control)	Allows you to change the settings for image recording according to the shooting scene or your preferences. <ul style="list-style-type: none"> • Default setting: Standard 	 40

Functions That Can Be Set with the MENU Button (Shooting Menu, Specialized Menu for U1, U2 or U3)







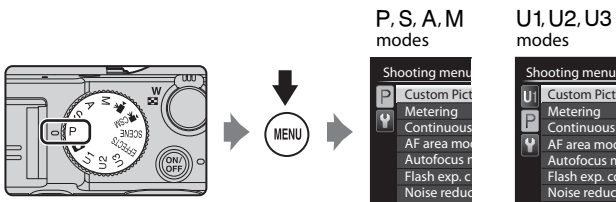



Shooting Menu

In the following shooting modes, the settings of the shooting menu can be changed by pressing the **MENU** button (📖12).

- **P, S, A** and **M** modes
- Special effects mode (Only **AF area mode** can be set.)
- **U1, U2** and **U3** modes (The settings can be changed in the second tab.)



Option	Description	📖
Custom Picture Control (COOLPIX Custom Picture Control)	Allows you to customize the settings of COOLPIX Picture Control (📖72) and register them in Custom 1 or Custom 2 of Picture Control in the quick menu.	🔍44
Metering	Allows you to set the method that the camera uses to measure the brightness of the subject. <ul style="list-style-type: none"> • Default setting: Matrix 	🔍45
Continuous	Allows you to select single or continuous shooting. <ul style="list-style-type: none"> • Default setting: Single 	🔍46
AF area mode	Allows you to change the method of how the camera selects the focus area for autofocus. <ul style="list-style-type: none"> • Default setting: <ul style="list-style-type: none"> - P, S, A or M mode: Center (normal) - EFFECTS mode: Auto 	🔍49

Option	Description	
Autofocus mode	Allows you to select either Single AF , which focuses only when the shutter-release button is pressed halfway, or Full-time AF , which continues focusing even when the shutter-release button is not pressed halfway. <ul style="list-style-type: none"> • Default setting: Single AF 	 53
Flash exp. comp.	Allows you to adjust the flash output. <ul style="list-style-type: none"> • Default setting: 0.0 	 54
Noise reduction filter	Allows you to set the strength of the noise reduction function that is normally performed when saving images. <ul style="list-style-type: none"> • Default setting: Normal 	 54
Built-in ND filter	Allows you to select On or Off for the built-in ND filter. <ul style="list-style-type: none"> • Default setting: Off 	 55
Distortion control	Allows you to select whether to correct the peripheral distortion that occurs due to the intrinsic characteristics of lenses. Enabling distortion control reduces the size of the frame, as compared to when distortion control is not enabled. <ul style="list-style-type: none"> • Default setting: Off 	 55
Active D-Lighting	Allows you to prevent loss of contrast details in highlights and shadows when shooting images. <ul style="list-style-type: none"> • Default setting: Off 	 56
Zoom memory	When the zoom control is moved while pressing the Fn1 button, the zoom position (equivalent to focal length/angle of view in 35mm [135] format) is switched to the positions that have been selected by setting the check box to on in this menu option. <ul style="list-style-type: none"> • Default setting: On  for all the check boxes 	 57
Startup zoom position	Allows you to set the zoom position (equivalent to focal length/angle of view in 35mm [135] format) for when the camera is turned on. <ul style="list-style-type: none"> • Default setting: 28 mm 	 57
M exposure preview	When On is selected, the exposure setting resulting from the shutter speed and aperture value set in M (manual) mode is reflected in the brightness on the shooting screen. <ul style="list-style-type: none"> • Default setting: Off 	 58

Option	Description	
Focus-coupled metering	If Metering (📖73) is set to Matrix or Spot and AF area mode (📖73) is set to Manual , the brightness of the subject is measured by giving higher priority to the focus area. <ul style="list-style-type: none"> • Default setting: On 	📖58
Commander mode	Allows you to set how the wirelessly-controlled optional flash unit fires when the flash mode (📖59) is set to COMMAND (commander mode). <ul style="list-style-type: none"> • Default setting: <ul style="list-style-type: none"> - Flash mode: Standard flash - Flash control mode: TTL 	📖59

Specialized Menu for U1, U2 or U3

In **U1**, **U2** and **U3** shooting modes, the settings of the following menu options can be changed in the top tab (📖12).

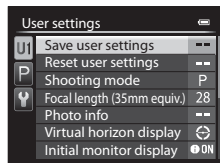
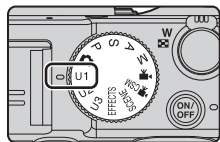

Option	Description	
Save user settings	Allows you to save the current settings.	55
Reset user settings	Allows you to reset the settings saved in U1 , U2 or U3 .	57
Shooting mode	Allows you to select the standard shooting mode. <ul style="list-style-type: none"> • Default setting: P Programmed auto The current flexible program (when set to P), shutter speed (when set to S or M) or aperture value (when set to A or M) settings are also saved.	49
Focal length (35mm equiv.)	Allows you to set the zoom position for when the mode dial is set. <ul style="list-style-type: none"> • Default setting: 28 mm 	-
Photo info	Allows you to set whether or not the virtual horizon, histogram and framing grid are displayed in the monitor. This setting is not applied to the setup menu settings. <ul style="list-style-type: none"> • Default setting: No check marks 	99

Option	Description	
Virtual horizon display	Allows you to set the virtual horizon display. This setting is not applied to the setup menu settings. • Default setting: Circle	99
Initial monitor display	Allows you to set the information displayed in the monitor. • Default setting: Show info	11
Flash mode	Allows you to set the flash mode. • Default setting: Auto	59
Focus	Allows you to set the focus mode. • Default setting: Autofocus	64
Self-timer	Allows you to set the self-timer. Default setting: Off	62
AF assist	Allows you to enable or disable the AF-assist illuminator. This setting is not applied to the setup menu settings. Default setting: Auto	99

Functions That Cannot Be Used Simultaneously







Some functions cannot be used with other menu settings.

Restricted function	Setting	Description
Flash mode	Focus mode (📖64)	When ▲ (infinity) is selected, the flash is not available.
	Image quality (📖72)	When RAW (NRW) images are recorded, red-eye reduction processing is not performed even if 📷 (auto with red-eye reduction) is set (including JPEG images when both RAW (NRW) and JPEG images were recorded at the same time).
	Continuous (📖73)	The flash is not available.
	Auto bracketing (📖72)	The flash is not available.
Self-timer/ Smile timer/ Remote control	AF area mode (📖73)	When Subject tracking is selected, the self-timer/smile timer/remote control are not available.
Focus mode	AF area mode (📖73)	When Subject tracking is selected, MF (manual focus) is not available.
Image quality	Continuous (📖73)	When BSS , Multi-shot 16 , Continuous H: 120 fps or Continuous H: 60 fps is selected, RAW (NRW) , RAW (NRW) + Fine and RAW (NRW) + Normal are not available.
	Auto bracketing (📖72)	When White balance bracketing is selected, RAW (NRW) , RAW (NRW) + Fine and RAW (NRW) + Normal are not available.
Image size	Image quality (📖72)	<ul style="list-style-type: none"> When Image quality is set to RAW (NRW), Image size is fixed at 📷 4000×3000. When RAW (NRW) + Fine or RAW (NRW) + Normal is selected, Image size of the JPEG image can be set. Note, however, that 📷 3984×2656, 📷 3968×2232 and 📷 3000×3000 cannot be selected.
	Continuous (📖73)	<ul style="list-style-type: none"> When Continuous H: 120 fps or Continuous H: 60 fps is selected, Image size is fixed at 📷 (1280 × 960 pixels). When Multi-shot 16 is selected, Image size is fixed at 📷 (2560 × 1920 pixels).

Restricted function	Setting	Description
ISO sensitivity	Continuous (📖73)	When Multi-shot 16, Continuous H: 120 fps or Continuous H: 60 fps is selected, ISO sensitivity is fixed at Auto .
	Active D-Lighting (📖74)	<ul style="list-style-type: none"> When ISO sensitivity is set to Auto and Active D-Lighting is set to any mode other than Off, the maximum value for ISO sensitivity is set to ISO 800. When Active D-Lighting is set to any mode other than Off, 1600, 2000, 2500, 3200 and Hi 1 in ISO sensitivity are not available.
	Shooting mode of Movie custom setting (📖96)	<ul style="list-style-type: none"> If ISO sensitivity is set to Auto when Shooting mode is Manual, ISO sensitivity is fixed at ISO 80. When Shooting mode is Special effects, ISO sensitivity is switched to Auto.
White balance	Picture Control (📖72)	When Monochrome is selected, White balance is fixed at Auto (normal) .
Picture Control	Active D-Lighting (📖74)	When using Active D-Lighting, Contrast in manual adjustment cannot be adjusted.
	Shooting mode of Movie custom setting (📖96)	When Shooting mode is Special effects , Picture Control is not available.
Metering	Active D-Lighting (📖74)	When Active D-Lighting is set to any mode other than Off, Metering is reset to Matrix .

Restricted function	Setting	Description
Continuous/ Auto bracketing	Continuous (📖73)/Auto bracketing (📖72)	Continuous and Auto bracketing are not available simultaneously.
	Self-timer (📖62)/Remote control (📖58)	When self-timer or the Remote Control ML-L3 is used, a single image is shot even if Continuous H , Continuous M , Continuous L , or BSS has been set.
	Smile timer (📖63)	When the camera detects smiling faces and the shutter is released, only one image is shot. If Intvl timer shooting is set, shooting finishes automatically after one image is shot.
	Image quality (📖72)	When Image quality is set to RAW (NRW) , RAW (NRW) + Fine or RAW (NRW) + Normal , BSS , Multi-shot 16 , Continuous H: 120 fps , Continuous H: 60 fps and White balance bracketing are not available.
	Picture Control (📖72)	When Monochrome is selected, White balance bracketing is not available.
AF area mode	Smile timer (📖63)	The camera captures images using face detection regardless of the applied AF area mode option.
	Focus mode (📖64)	When set to MF (manual focus), the AF area mode cannot be set.
	Picture Control (📖72)	When Target finding AF is selected and Picture Control is set to Monochrome , AF area mode operates using the Auto setting.
	White balance (📖72)	When Target finding AF is selected, and if the white balance is set to Preset manual , Incandescent , Fluorescent FL3 or Choose color temp. , or fine adjustment of white balance is performed, the camera focuses on a face or selects one or more of the 9 focus areas containing the subject closest to the camera.

Restricted function	Setting	Description
Autofocus mode	Smile timer (📖63)	Autofocus mode option cannot be changed when the smile timer is selected.
	Focus mode (📖64)	When the focus mode is set to ▲ (infinity), the autofocus mode operates using the Single AF setting.
	AF area mode (📖73)	When AF area mode is set to Face priority , Subject tracking or Target finding AF , Single AF is automatically selected.
Built-in ND filter	Shooting mode of Movie custom setting (📖96)	When Shooting mode is set to Special effects , the built-in ND filter is automatically controlled.
Active D-Lighting	ISO sensitivity (📖72)	When ISO sensitivity is set to 1600, 2000, 2500, 3200 or Hi 1 , Active D-Lighting is not available.
Photo info	Smile timer (📖63)	The virtual horizon is not displayed when the smile timer is selected.
	AF area mode (📖73)	<ul style="list-style-type: none"> The virtual horizon is not displayed when Face priority is selected. The virtual horizon is not displayed when Subject tracking is selected. After the subject has been registered (during subject tracking), the histogram is not displayed. The virtual horizon and histogram are not displayed when Target finding AF is selected.
Print date	Image quality (📖72)	When Image quality is set to RAW (NRW) , RAW (NRW) + Fine or RAW (NRW) + Normal , date cannot be imprinted on images.
	Continuous (📖73)	When Continuous H: 120 fps or Continuous H: 60 fps is selected, date cannot be imprinted on images.
Sound settings	Continuous (📖73)	When Continuous H , Continuous M , Continuous L , Continuous H: 120 fps , Continuous H: 60 fps , BSS , or Multi-shot 16 is selected, shutter sound is disabled.
	Auto bracketing (📖72)	When AE Bracketing (Tv) , AE Bracketing (Av) or AE Bracketing (Sv) is selected, shutter sound is disabled.

Restricted function	Setting	Description
Digital zoom	Smile timer ( 63)	When the smile timer is selected, digital zoom is not available.
	Focus mode ( 64)	When MF (manual focus) is selected, digital zoom is not available.
	Image quality ( 72)	When Image quality is set to RAW (NRW) , RAW (NRW) + Fine or RAW (NRW) + Normal , digital zoom is not available.
	Continuous ( 73)	When Multi-shot 16 is selected, digital zoom is not available.
	AF area mode ( 73)	When Subject tracking is selected, digital zoom is not available.
	Zoom memory ( 4, 74)	When the Fη1 button is held down, digital zoom is not available.

Notes About Digital Zoom

- Depending on the shooting mode or the current settings, digital zoom may not be available (81).
- When digital zoom is in effect, selectable options for AF area mode or metering mode are restricted.

Focusing

The focus area varies depending on the shooting mode.

Focusing in (Auto) Mode or EFFECTS Mode

- The camera automatically selects one or more of the 9 focus areas containing the subject closest to the camera when the shutter-release button is pressed halfway. When the subject is in focus, the focus areas that are in focus glow green.
- In special effects mode, the method of how the camera selects the focus area for autofocus can be changed by selecting **AF area mode** (📖73) in the shooting menu.

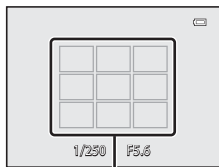

Focus areas

Using the Target Finding AF

When **AF area mode** (default setting: **Center (normal)**) in **P, S, A, M, U1, U2** or **U3** mode is set to **Target finding AF**, the camera operates in the manner described below when you press the shutter-release button halfway.

- The camera detects the main subject and focuses on it. When the subject is in focus, the focus area glows green. If a human face is detected, the camera automatically sets focus priority on it.
- If no main subject is detected, the camera operates in the same manner as in  (auto) mode.

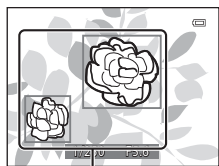

Focus areas

Notes About Target Finding AF

- Depending on shooting conditions, the subject that the camera determines to be the main subject may vary.
- The main subject may not be detected when using certain **White balance** or **Picture Control** settings.
- The camera may not detect the main subject appropriately in the following situations:
 - When the subject is very dark or bright
 - When the main subject lacks clearly defined colors
 - When the shot is framed so that the main subject is on the edge of the monitor
 - When the main subject is composed of a repeating pattern

Using Face Detection

In the following settings, the camera uses face detection to automatically focus on human faces.

- **Scene auto selector**, **Portrait**, or **Night portrait** scene mode (📖39)
-  (Smile timer) (📖63)
- When **AF area mode** (📖73) is set to **Face priority**

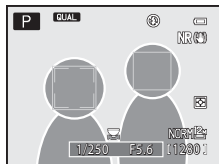

If the camera detects more than one face, a double border is displayed around the face that the camera focuses on, and single borders are displayed around the other faces.

If the shutter-release button is pressed halfway when no faces are detected:

- When **Scene auto selector** is selected, the focus area changes depending on the scene.
- In **Portrait** and **Night portrait** scene modes, the camera focuses on the area in the center of the frame.
- When  (smile timer) is selected, the camera focuses on the subject in the center of the frame.
- When **AF area mode** is set to **Face priority**, the camera selects the focus area containing the subject closest to the camera.

Notes About Face Detection

- The camera's ability to detect faces depends on a variety of factors, including the direction in which the faces are looking.
- The camera may be unable to detect faces in the following situations:
 - When faces are partially hidden by sunglasses or otherwise obstructed
 - When faces take up too much or too little of the frame

Using Skin Softening

When the shutter is released while using one of the shooting modes listed below, the camera detects human faces and processes the image to soften facial skin tones (up to 3 faces).

- **Scene auto selector, Portrait** or **Night portrait** in scene mode (📖39)
Skin softening can also be applied to saved images (📖88).

✔ Notes About Skin Softening

- It may take more time than usual to save images after shooting.
- Under some shooting conditions, the desired skin softening results may not be achieved, and skin softening may be applied to areas of the image where there are no faces.

Subjects Not Suitable for Autofocus

The camera may not focus as expected in the following situations. In some rare cases, the subject may not be in focus despite the fact that the focus area or focus indicator glows green:

- Subject is very dark
- Objects of sharply differing brightness are included in the scene (e.g. the sun behind the subject makes that subject appear very dark)
- No contrast between the subject and surroundings (e.g. a portrait subject wearing a white shirt is standing in front of a white wall)
- Several objects are at different distances from the camera (e.g. the subject is inside a cage)
- Subjects with repeating patterns (window blinds, buildings with multiple rows of similarly shaped windows, etc.)
- Subject is moving rapidly

In the situations noted above, try pressing the shutter-release button halfway to refocus several times, or focus on another subject positioned at the same distance from the camera as the actual desired subject, and use focus lock (📖85).

The camera can also focus using manual focus (📖64, 66).

Focus Lock

Focus lock shooting is recommended when the camera does not activate the focus area that contains the desired subject.

1 Set AF area mode to **Center (normal)** (📖73).

- **AF area mode** can be set when the shooting mode is **P, S, A, M, U1, U2, U3**, or special effects.

2 Position the subject in the center of the frame and press the shutter-release button halfway.

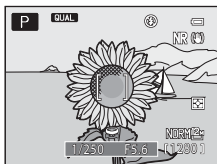

- Confirm that the focus area glows green.
- Focus and exposure are locked.

3 Without lifting your finger, recompose the picture.

- Make sure to maintain the same distance between the camera and the subject.

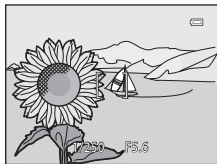

4 Press the shutter-release button the rest of the way down to take the picture.



Using the AE-L/AF-L Button for Focus Lock

You can lock the exposure and focus while holding down the AE-L/AF-L button (📖100) instead of pressing the shutter-release button halfway.

Playback Features

Playback Zoom

Moving the zoom control toward **T** (Q) in full-frame playback mode (📖36) zooms in on the image.

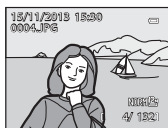
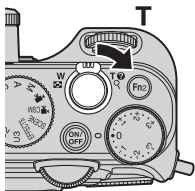

Image is displayed full-frame.

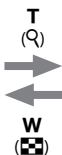

Image is zoomed in.

Displayed area guide

- You can change the zoom ratio by moving the zoom control toward **W** (🏁) or **T** (Q). The zoom can also be adjusted by rotating the command dial.
- To view a different area of the image, press the multi selector ▲▼◀▶.
- If you are viewing an image that was captured using face detection or pet detection, the camera zooms in on the face detected at the time of shooting (except images captured using **Continuous**, **AE Bracketing (Tv)**, **AE Bracketing (Av)** or **AE Bracketing (Sv)**). To zoom in on an area of the image where there are no faces, adjust the zoom ratio and then press ▲▼◀▶.
- When a zoomed image is displayed, press the **OK** button to return to full-frame playback mode.

Cropping Images

When a zoomed image is displayed, you can press the **MENU** button to crop the image to include only the visible portion and save it as a separate file (📖17).

Thumbnail Display, Calendar Display

Moving the zoom control toward **W** (📐) in full-frame playback mode (📖36) displays images as thumbnails.

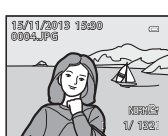
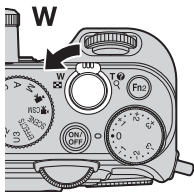

Full-frame Display



Thumbnail Display



Calendar Display

- You can change the number of thumbnails displayed by moving the zoom control toward **W** (📐) or **T** (🔍).
- While using thumbnail playback mode, use the multi selector ▲▼◀▶ or rotate it to select an image, and then press the **OK** button to display that image full-frame.
- While using calendar display mode, use the multi selector ▲▼◀▶ or rotate it to select a date, and then press the **OK** button to display the images captured on that day.
- An image or date can also be selected by rotating the command dial.

📌 Calendar Display







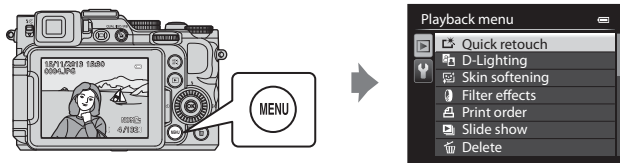







Images captured when the camera's date is not set are treated as images captured on January 1, 2013.

Functions That Can Be Set with the MENU Button (Playback Menu)

When viewing images in full-frame playback mode or thumbnail playback mode, you can configure the playback menu settings listed below by pressing the **MENU** button (📖12).



Option	Description	📖
🔍 Quick retouch ¹	Allows you to create retouched copies in which contrast and saturation have been enhanced.	🔑10
🔦 D-Lighting ¹	Allows you to create copies with enhanced brightness and contrast, brightening dark portions of an image.	🔑10
👤 Skin softening ¹	Detects faces in images and creates a copy with softer facial skin tones.	🔑11
🎛️ Filter effects ¹	Allows you to apply a variety of effects using digital filter. The available effects are Soft , Selective color , Cross screen , Fisheye , Miniature effect , Painting and Vignette .	🔑12
🖨️ Print order ²	Allows you to select which images are printed, and how many copies of each image are printed, prior to printing.	🔑62
📺 Slide show	Allows you to view images in an automatic slide show.	🔑64
🗑️ Delete ²	Deletes an image. Multiple images can be deleted.	🔑65
🔒 Protect ²	Protects selected images and movies from accidental deletion.	🔑66
🔄 Rotate image ²	Allows you to rotate the displayed image to portrait or landscape orientation.	🔑66
🖼️ Small picture ¹	Creates a small copy of images.	🔑13
🗣️ Voice memo	Allows you to use the camera's microphone to record voice memos and attach them to images.	🔑67

Option	Description	
 Copy ²	Allows you to copy images between the internal memory and a memory card. This function can also be used to copy movies.	 68
 Black border ¹	Creates a new image surrounded by a black border.	 14
 Straighten ¹	Compensates for the slanting of images taken.	 15
NRW RAW (NRW) processing ^{1,2}	Creates JPEG-format copies by performing RAW processing within the camera for RAW (NRW) images without having to use a computer.	 15
 Sequence display options	Allows you to select whether to display only the key picture for a sequence of images captured continuously or to display the sequence as individual images. <ul style="list-style-type: none"> When only the key picture is displayed for a sequence, press the  button to display each image in the sequence. Press the multi selector  to return to the key picture display. 	 69
 Choose key picture ²	Allows you to change the key picture for images captured in sequence.	 69

¹ Edited images are saved as separate files. Some images may not be edited.

² Select an image on the image selection screen. See "Using the Screen for Selecting Images" ( 90) for more information.

Using the Screen for Selecting Images

When an image selection screen such as the one shown on the right is displayed while operating the camera, follow the procedures described below to select the images.



1 Use the multi selector ◀▶ or rotate it to select the desired image.

- Move the zoom control (1) toward **T** (Q) to switch to full-frame playback, or **W** (R) to switch to thumbnail playback.
- Only one image can be selected for **Rotate image**, **Choose key picture**, and **Welcome screen**. Proceed to step 3.



2 Use ▲▼ to select **ON** or **OFF** (or the number of copies).

- When **ON** is selected, a check mark (✓) is displayed with the image. Repeat steps 1 and 2 to select additional images.





3 Press the **OK** button to apply the image selection.

- With selections such as **Selected images**, a confirmation dialog is displayed. Follow the instructions displayed in the monitor.



Recording and Playing Back Movies



Recording Movies

Movies can be recorded using the following two modes.

 (movie) mode	You can perform basic movie recording. When Movie options is set to HS movies, you can record slow motion movies and fast motion movies ( , 31).
 CSM (movie custom setting) mode	You can set the Shooting mode and ISO sensitivity and enjoy recording more authentic movies.

1 Rotate the mode dial to

 (or  CSM).

- Check the remaining amount of movie recording time.
- When **Shooting mode** (, 96) of the movie custom setting mode is set to **Aperture-priority auto** or **Manual**, set the aperture value or shutter speed before recording a movie (, 49). The aperture value and shutter speed cannot be set during movie recording.

Movie recording time remaining

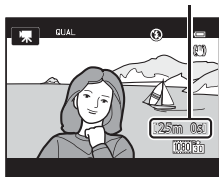
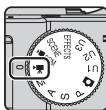

2 Press the shutter-release button all the way to start recording.

- The camera focuses on the area in the center of the frame.
- See "Focusing During Movie Recording" (, 93) for more information.



3 Press the shutter-release button all the way to end recording.

✓ Maximum Movie Length

Individual movie files cannot exceed 4 GB in size or 29 minutes in length, even when there is sufficient free space on the memory card for longer recording.

- The maximum movie length for a single movie is displayed on the shooting screen.
- Recording may end before either limit is reached if camera temperature becomes elevated.
- The actual movie length may vary depending on the movie content, subject movement, or type of memory card.

✓ Notes About Saving Images and Recording Movies

The indicator showing the number of exposures remaining or the indicator showing the maximum movie length flashes while images are being saved or while a movie is being recorded. **Do not open the battery-chamber/memory card slot cover or remove the battery or memory card** while an indicator is flashing. Doing this could result in loss of data, or in damage to the camera or the memory card.

✓ Notes About Movie Recording

- Memory cards with an SD Speed Class rating of 6 or faster are recommended when recording movies (p.25). Movie recording may stop unexpectedly when a memory card with a lower Speed Class rating is used.
- The sounds of zoom control operation, zoom, autofocus lens drive movement, vibration reduction, and aperture operation when brightness changes may be recorded.
- The following phenomena may be seen in the monitor while recording movies. These phenomena are saved in the recorded movies.
 - Banding may occur in images under fluorescent, mercury-vapor, or sodium-vapor lighting.
 - Subjects that move quickly from one side of the frame to the other, such as a moving train or car, may appear skewed.
 - The entire movie image may be skewed when the camera is panned.
 - Lighting or other bright areas may leave residual images when the camera is moved.
- Depending on the distance to the subject or the amount of zoom applied, subjects with repeating patterns (fabrics, lattice windows, etc.) may have colored stripes (interference patterns, moire, etc.) in them during movie recording and playback. This occurs when the pattern in the subject and the layout of the image sensor interfere with each other; it is not a malfunction.

✓ Notes About Using Zoom During Movie Recording

- The zoom indicator is not displayed during movie recording.
- There may be some degradation in image quality when digital zoom is used. When recording movies, digital zoom operates up to approximately 2x the maximum optical zoom ratio. If you zoom in on the subject while recording a movie, the zoom motion temporarily stops at the position where optical zoom is changed to digital zoom.
- When **Shooting mode** (📖96) of the movie custom setting mode is set to **Aperture-priority auto** or **Manual**, optical zoom cannot be used during movie recording.

✓ Camera Temperature

- The camera may become warm when recording movies for an extended period of time or when the camera is used in a hot area.
- If the inside of the camera becomes extremely hot when recording movies, the camera will automatically stop recording. The amount of time remaining until the camera stops recording (🕒10s) is displayed. After the camera stops recording, it turns itself off.
Leave the camera off until the inside of the camera has cooled.

Focusing During Movie Recording

- The focus can be adjusted during movie recording in the following manner in accordance with the **Autofocus mode** (📖96) setting of the movie menu.
 - **AF-S Single AF** (default setting): The focus is locked when movie recording starts. To perform the autofocus function during movie recording, press the AE-L/AF-L button (📖2).
 - **AF-F Full-time AF**: The focus is adjusted repeatedly even during movie recording. To lock the exposure or focus during movie recording, press the AE-L/AF-L button. To cancel the lock, press the AE-L/AF-L button again.
- When the focus mode (📖64) is **MF** (manual focus), adjust the focus manually. The focus can be adjusted by using the multi selector ▲ (far) ▼ (near) while recording movies.
- Autofocus may not perform as expected (📖84). Should this occur, try **MF** (manual focus) (📖64, 66) or set **Autofocus mode** in the movie menu to **AF-S Single AF** (default setting) and then use focus lock (📖85) to record.











Functions Available in Movie Mode and Movie Custom Setting Mode











- Self-timer (📖62)
- Focus mode (📖64)
- Exposure compensation (📖69)
- Quick menu (📖70)
- Movie menu (📖96)
- Setup menu (📖99)

Functions That Can Be Set Using the Button (Quick Menu: When Recording Movies)

Available functions differ according to the movie mode.

- See “Basic Quick Menu Operations” ( 70) for how to set the quick menu options.

Function		 CSM
QUAL Movie options		
ISO ISO sensitivity	-	
WB White balance		
BKT Auto bracketing	-	-
 My Menu	-	-
 Picture Control	-	

Option	Description	
QUAL Movie options	<p>Allows you to select the movie type. Select normal speed to record movies at normal speed, or HS (high speed) to record movies that play in slow or fast motion. Only normal speed movies can be selected in  CSM (movie custom setting) mode.</p> <ul style="list-style-type: none"> • Default setting:  1080★/30p or  1080★/25p 	 30
ISO ISO sensitivity	<p>Allows you to control the camera's sensitivity to light.</p> <ul style="list-style-type: none"> • Default setting: Auto • If ISO sensitivity is set to Auto when Shooting mode of the movie custom setting menu ( 96) is Manual, ISO sensitivity is fixed at ISO 80. 	 33
WB White balance	<p>Allows you to adjust white balance to suit the weather conditions or light source in order to make the colors in images match what you see with your eyes.</p> <ul style="list-style-type: none"> • Default setting: Auto (normal) 	 35
 Picture Control (COOLPIX Picture Control)	<p>Allows you to change the settings for image recording according to the shooting scene or your preferences.</p> <ul style="list-style-type: none"> • Can be set when Shooting mode ( 96) of the movie custom setting menu is set to Aperture-priority auto or Manual. • Default setting: Standard 	 40

Functions That Can Be Set with the MENU Button (Movie and Movie Custom Setting Menus)

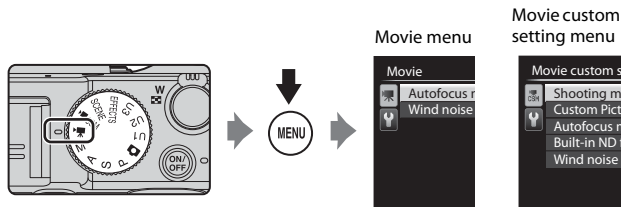

In movie mode or movie custom setting mode, press the **MENU** button to set the following menu options (📖12).







Available functions differ according to the movie mode.

Function	📽 (movie)	📽CSM (movie custom setting)
Shooting mode	-	✓
Custom Picture Control	-	✓
Autofocus mode	✓	✓
Built-in ND filter	-	✓
Wind noise reduction	✓	✓

Option	Description	📖
Shooting mode	Allows you to set the standard shooting mode. <ul style="list-style-type: none"> Default setting: Aperture-priority auto When Special effects is selected, also allows you to select a shooting effect (📖46) (default setting: Painting). 	📖70
Custom Picture Control (COOLPIX Custom Picture Control)	Allows you to customize the settings of COOLPIX Picture Control (📖95) and register them in Custom 1 or Custom 2 of Picture Control in the quick menu.	📖44
Autofocus mode	Allows you to select either Single AF , which locks focus when movie recording begins, or Full-time AF , which continues focusing during movie recording. <ul style="list-style-type: none"> Default setting: Single AF 	📖71

Option	Description	
Built-in ND filter	Allows you to select On or Off for the built-in ND filter. <ul style="list-style-type: none"> • Default setting: Off • When Shooting mode of the movie custom setting menu is set to Special effects, the built-in ND filter is automatically controlled. 	 55
Wind noise reduction	Allows you to set whether or not to reduce wind noise during movie recording. <ul style="list-style-type: none"> • Default setting: Off 	 72

Playing Back Movies

Press the  button to enter playback mode. Movies are indicated by the movie options icon ( 95,  30). Press the  button to play back movies.

- To adjust the volume, move the zoom control ( 1).

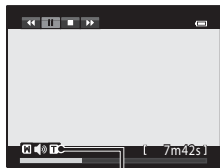
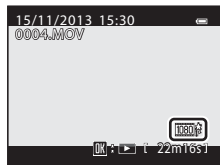

Volume indicator

Functions Available During Playback

Rotate the multi selector or the main command dial to fast forward or rewind. Playback controls are displayed at the top of the monitor.

The operations listed below can be performed by using the multi selector ◀▶ or sub-command dial to select a control and then pressing the OK button.

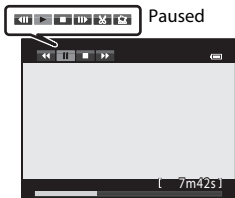

Function	Icon	Description	
Rewind	◀◀	Hold down the OK button to rewind the movie.	
Advance	▶▶	Hold down the OK button to advance the movie.	
Pause		Pause playback. The operations listed below can be performed while paused.	
		◀	Rewind the movie one frame. Hold down the OK button for continuous rewinding.*
		▶	Advance the movie one frame. Hold down the OK button for continuous advancing.*
		▶	Resume playback.
		✂	Extract the desired portion of a movie and save it as a separate file.
	🖼	Extract a single frame of a movie and save it as a still image.	
End	■	Return to full-frame playback mode.	

* The movie can also be advanced or rewound by one frame by rotating the multi selector or main command dial.

Deleting Movies

To delete a movie, select the desired movie in full-frame playback mode (📖36) or thumbnail playback mode (📖87) and press the 🗑 button (📖37).

General Camera Setup







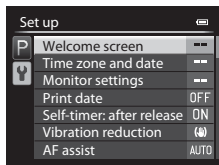













Functions That Can Be Set with the MENU Button (Setup Menu)















Press the MENU button → Y (setup) tab (📖13)

The settings of the menu options listed below can be configured.



Option	Description	📖
Welcome screen	Allows you to select whether or not the welcome screen is displayed when the camera is turned on.	👁️72
Time zone and date	Allows you to set the camera clock.	👁️73
Monitor settings	Allows you to adjust post-shooting image review, monitor brightness, and photo information display settings.	👁️75
Print date	Allows you to imprint the shooting date and time on images.	👁️77
Self-timer: after release	Allows you to select whether or not to cancel the setting after shooting images with the self-timer.	👁️78
Vibration reduction	Allows you to select the vibration reduction setting used when shooting.	👁️79
AF assist	Allows you to enable or disable the AF-assist illuminator.	👁️80
ISO sensitivity step value	Allows you to set the step value of the sensitivity to be set for ISO sensitivity of the quick menu.	👁️80
Digital zoom	Allows you to set the operation of digital zoom.	👁️81
Zoom speed	Allows you to set the zoom operation speed.	👁️82
Fixed aperture	When set to On , zoom operates while keeping changes in the aperture value to a minimum in A or M shooting mode.	👁️82

Option	Description	
Sound settings	Allows you to adjust sound settings.	 83
Record orientation	Allows you to set whether or not to record the “tall” orientation data on the images that are shot with the camera held in “tall” orientation.	 83
Rotate tall	Allows you to set whether or not to rotate the images in accordance with the “tall” or landscape orientation of the camera during playback.	 84
Auto off	Allows you to set the amount of time that passes before the monitor turns off to save power.	 84
Format memory/ Format card	Allows you to format the internal memory or the memory card.	 85
Language	Allows you to change the camera’s display language.	 85
TV settings	Allows you to adjust TV-connection settings.	 86
External mic sensitivity	Allows you to set the external microphone sensitivity.	 86
Customize command dials	Allows you to swap the function of the main command dial for that of the sub-command dial when the exposure is set ( 49).	 87
Command dial rotation	Allows you to set the direction of operation when the command dial is rotated during shooting.	 87
Multi selector right press	When set to AF area mode , the AF area mode setting is displayed if the multi selector  () is pressed during shooting.	 88
Delete button options	When set to Press twice to delete , the image can be deleted by pressing the  button again while the delete confirmation message is displayed.	 88
AE/AF lock button	Allows you to select the function to be performed when the AE-L/AF-L button is pressed during shooting.	 89
Fn1 + shutter button	Allows you to set the function to be performed when the shutter-release button is pressed while pressing the Fn1 (function 1) button during shooting.	 90
Fn1 + command dial	Allows you to set the function to be performed when the command dial is rotated while pressing the Fn1 (function 1) button during shooting.	 91

Option	Description	
Fn1 + selector dial	Allows you to set the function to be performed when the multi selector is rotated while pressing the Fn1 (function 1) button during shooting.	 91
Fn1 guide display	Allows you to set whether or not to display guides for the functions assigned to Fn1 + shutter button , Fn1 + command dial and Fn1 + selector dial in the monitor, when the Fn1 (function 1) button is pressed during shooting.	 92
Fn2 button	Allows you to set the operation to be performed when the Fn2 (function 2) button is pressed.	 92
Customize My Menu	Allows you to register frequently used menu items in My Menu ( 72) (up to 5 items).	 93
Reset file numbering	Allows you to reset the sequential numbering of file numbers when Yes is selected.	 94
Accessory terminal	Allows you to configure settings for the optional Wireless Remote Controller WR-R10 or GPS unit when either one is attached to the accessory terminal.	 95
Eye-Fi upload	Allows you to set whether or not to enable the function for sending images to a computer using a commercially available Eye-Fi card.	 96
MF distance indicator units	Allows you to set the unit of distance for displaying at screen gauge, to either m (meter) or ft (feet) when using manual focus.	 97
Reverse indicators	Allows you to set the +/- display direction of indicators that are displayed for setting the exposure and bracketing when shooting mode is M .	 97
Flash control	When set to Auto , the external flash unit (optional) fires when it is attached to the camera.	 97
Reset all	Allows you to reset the camera's settings to their default values.	 98
Firmware version	View the current camera firmware version.	 98

Connecting the Camera to a TV, Computer, or Printer

Connection Methods

You can enhance your enjoyment of images and movies by connecting the camera to a TV, computer, or printer.

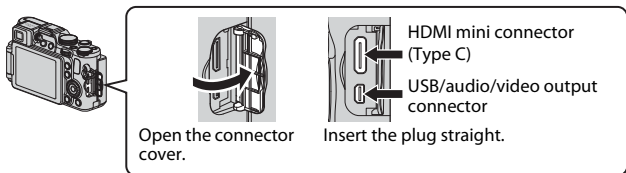

- Before connecting the camera to an external device, make sure the remaining battery level is sufficient and turn the camera off. Before disconnecting, make sure to turn the camera off.
- If the AC Adapter EH-5b and the Power Connector EP-5A (available separately) (● 104) are used, this camera can be powered from an electrical outlet. Do not use any other make or model of AC adapter or power connector as it may cause the camera to heat up or malfunction.
- For information about the connection methods and subsequent operations, refer to the documentation included with the device in addition to this document.

Viewing images on a TV 18

Images and movies captured with the camera can be viewed on a TV.

Connection method: Connect the video and audio plugs of the optional Audio Video Cable EG-CP16 ( 104) to the TV's input jacks. Alternatively, connect a commercially available HDMI cable to the TV's HDMI input jack.

Viewing and organizing images on a computer 104

You can transfer images to a computer to perform simple retouching and manage image data.

Connection method: Connect the camera to the computer's USB port with the included USB cable.

- Before connecting to a computer, install ViewNX 2 on the computer ( 104).

Printing images without using a computer 20

If you connect the camera to a PictBridge-compatible printer, you can print images without using a computer.

Connection method: Connect the camera directly to the printer's USB port with the included USB cable.

Using ViewNX 2

ViewNX 2 is an all-in-one software package which enables you to transfer, view, edit and share images. Install ViewNX 2 using the included ViewNX 2 CD-ROM.

Your Imaging Toolbox

ViewNX 2™



Installing ViewNX 2

Compatible Operating Systems

Windows

Windows 8, Windows 7, Windows Vista, Windows XP

Macintosh

Mac OS X 10.6, 10.7, 10.8

Refer to the Nikon website for details on system requirements, including the latest information on operating system compatibility.

1 Start the computer and insert the ViewNX 2 CD-ROM into the CD-ROM drive.

- Windows: If instructions for operating the CD-ROM are displayed in the window, follow the instructions to proceed to the installation window.
- Mac OS: When the **ViewNX 2** window is displayed, double-click the **Welcome** icon.

2 Select a language in the language selection dialog to open the installation window.

- If the desired language is not available, click **Region Selection** to choose a different region and then choose the desired language (the **Region Selection** button is not available in the European release).
- Click **Next** to display the installation window.



3 Start the installer.

- We recommend clicking **Installation Guide** in the installation window to check the installation help information and system requirements before installing ViewNX 2.
- Click **Typical Installation (Recommended)** in the installation window.
- Follow the on-screen instructions to install the software.

4 Exit the installer when the installation completion screen is displayed.

- Windows: Click **Yes**.
- Mac OS: Click **OK**.

The following software is installed:

- ViewNX 2 (consisting of the three modules below)
 - Nikon Transfer 2: For transferring images to the computer
 - ViewNX 2: For viewing, editing, and printing transferred images
 - Nikon Movie Editor: For basic editing of transferred movies
- Panorama Maker (for creating a single panorama photo using a series of images shot in panorama assist scene mode)

5 Remove the ViewNX 2 CD-ROM from the CD-ROM drive.

Transferring Images to the Computer

1 Choose how images will be copied to the computer.

Choose one of the following methods:

- Direct USB connection:** Turn the camera off and ensure that the memory card is inserted in the camera. Connect the camera to the computer using the included USB cable. The camera automatically turns on. To transfer images that are saved in the camera's internal memory, remove the memory card from the camera before connecting it to the computer.

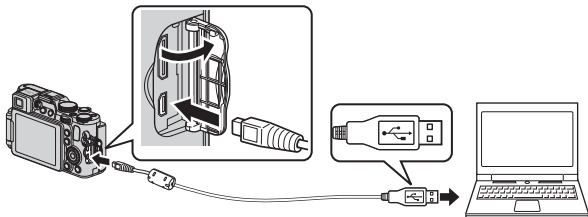

- SD card slot:** If your computer is equipped with an SD card slot, the card can be inserted directly in the slot.
- SD card reader:** Connect a card reader (available separately from third-party suppliers) to the computer and insert the memory card.

If a message is displayed prompting you to choose a program, select Nikon Transfer 2.

• When using Windows 7

If the dialog shown at right is displayed, follow the steps below to select Nikon Transfer 2.

- Under **Import pictures and videos**, click **Change program**. A program selection dialog will be displayed; select **Import File using Nikon Transfer 2** and click **OK**.
- Double-click **Import File**.



If the memory card contains a large number of images, it may take a while for Nikon Transfer 2 to start. Wait until Nikon Transfer 2 starts.

✓ Connecting the USB Cable

The connection may not be recognized if the camera is connected to the computer via a USB hub.

2 Transfer images to the computer.

- Confirm that the name of the connected camera or removable disk is displayed as the “Source” on the “Options” title bar of Nikon Transfer 2 (①).
- Click **Start Transfer** (②).

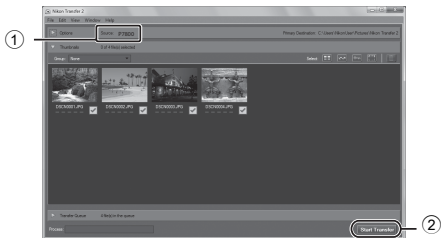

- At default settings, all the images on the memory card will be copied to the computer.
- Images are displayed in ViewNX 2 when transfer is complete.

3 Terminate the connection.

- If the camera is connected to the computer, turn the camera off and disconnect the USB cable.
- If you are using a card reader or card slot, choose the appropriate option in the computer operating system to eject the removable disk corresponding to the memory card and then remove the card from the card reader or card slot.

Starting ViewNX 2 Manually

- **Windows:** Double-click the **ViewNX 2** shortcut on the desktop.
- **Mac OS:** Click the **ViewNX 2** icon in the Dock.
- Consult online help for more information on using ViewNX 2.



A series of horizontal dashed lines spanning the width of the page, intended for handwriting practice.



Reference Section

The Reference Section provides detailed information and hints about using the camera.

Shooting

- Using Easy Panorama (Shooting and Playback) 2
- Using Panorama Assist 5

Playback

- Viewing and Deleting Images Captured Continuously (Sequence) 7
- Editing Still Images 9
- Connecting the Camera to a TV (Viewing Images on a TV) 18
- Connecting the Camera to a Printer (Direct Print) 20
- Editing Movies 25

Menu

- The Quick Menu 27
- The Shooting Menu (P, S, A or M Mode)..... 44
- The Playback Menu..... 62
- The Movie and Movie Custom Setting Menus..... 70
- The Setup Menu..... 72

Additional Information

- Error Messages 99
- File Names..... 103
- Optional Accessories..... 104
- Shooting with Remote Control ML-L3 106
- Speedlights (External Flash Unit)..... 108
- Using the GPS Unit..... 113



Using Easy Panorama (Shooting and Playback)

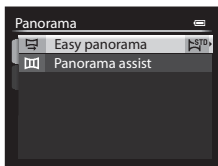

Shooting with Easy Panorama

Rotate the mode dial to **SCENE** → **MENU** button →  Panorama

- 1 Use the multi selector ▲▼ to select  **Easy panorama** and press the **OK** button.



- 2 Select  **Normal (180°)** or  **Wide (360°)** as the shooting range and press the **OK** button.

- When the camera is readied in the horizontal position, the image size (width × height) is as follows.
 -  **Normal (180°)**:
3200 × 560 when moved horizontally,
1024 × 3200 when moved vertically
 -  **Wide (360°)**:
6400 × 560 when moved horizontally,
1024 × 6400 when moved vertically

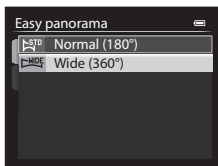

- 3 Frame the first edge of the panorama scene, and then press the shutter-release button halfway to focus.

- The zoom position is fixed at wide-angle.
- The camera focuses on the area in the center of the frame.

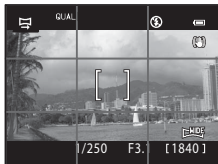

- 4** Press the shutter-release button all the way, and then remove your finger from the shutter-release button.

- $\triangle \nabla \langle \rangle$ are displayed to indicate the direction of camera movement.

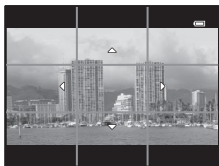

- 5** Move the camera in one of the four directions until the guide indicator reaches the end.

- When the camera detects which direction it is moving in, shooting begins.



Guide

Example of Camera Movement

- Using your body as the axis of rotation, move the camera slowly in an arc, in the direction of the marking ($\triangle \nabla \langle \rangle$).
- Shooting stops if the guide does not reach the edge within about 15 seconds (when **STD Normal (180°)** is selected) or within about 30 seconds (when **WIDE Wide (360°)** is selected) after shooting starts.



✓ Notes About Easy Panorama Shooting

- The range of the image seen in the saved image is narrower than that seen in the monitor at the time of shooting.
- If the camera is moved too quickly or shaken too much, or if the subject is too uniform (e.g. walls or darkness), an error may occur.
- If shooting is stopped before the camera reaches the half-way point in the panorama range, a panorama image is not saved.
- If more than half of the panorama range is captured but shooting ends before reaching the edge of the range, the range not captured is recorded and displayed in gray.

Viewing Images Captured with Easy Panorama

Switch to playback mode (📖36), display an image captured using easy panorama in full-frame playback mode, and then press the **OK** button to scroll the image in the direction that was used when shooting.

- Rotate the multi selector to scroll forward or backward quickly.

Playback controls are displayed at the top of the monitor during playback.

Use the multi selector **◀▶** to select a control, and then press the **OK** button to perform the following operations.

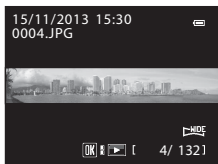

Function	Icon	Description
Rewind	⏮	Hold down the OK button to scroll backward quickly.*
Advance	⏭	Hold down the OK button to scroll forward quickly.*
Pause	⏸	Pause playback. The operations listed below can be performed while paused.
		⏮ OK Hold down the OK button to rewind.*
		⏭ OK Hold down the OK button to scroll.*
		▶ OK Resume automatic scrolling.
End	⏹	Switch to full-frame playback mode.

* These operations can also be performed by rotating the multi selector.

✔ Notes About Scroll Playback

This camera may not be able to scroll the playback of, or zoom in on, easy panorama images captured with another make or model of digital camera.

Using Panorama Assist

Using a tripod makes the composition easier. When using a tripod to stabilize the camera, set **Vibration reduction** (🔧79) to **Off** in the setup menu.

Rotate the mode dial to **SCENE** → **MENU** button → 📷 Panorama

- 1 Use the multi selector ▲▼ to select 📷 **Panorama assist** and press the Ⓞ button.

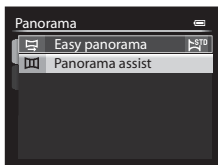

- 2 Use ▲▼◀▶ to select the direction in which images are joined, and press the Ⓞ button.

- Apply flash mode (📖59), self-timer (📖62)/remote control (🔧106), focus mode (📖64) and exposure compensation (📖69) settings in this step, if necessary.
- Press the Ⓞ button to reselect the direction.



- 3 Frame the first edge of the panorama scene, and take the first image.



- The camera focuses on the area in the center of the frame.
- About 1/3 of the image will be displayed as translucent.

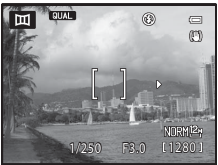

4 Shoot the next image.

- Match the outline of the next image so that 1/3 of the frame overlaps the previous image, and press the shutter-release button.

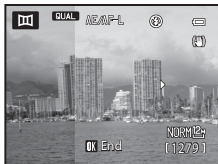

5 Press the **OK** button when shooting is completed.

- The camera returns to step 2.

✓ Notes About Panorama Assist

- The panorama series is terminated if the auto off function (📷84) triggers the standby mode during shooting. To prevent this, setting a longer time for the auto off function is recommended.
- Images cannot be deleted while shooting in panorama assist mode. When shooting a new image, return to step 2 and start over again.

📌 AE/AF-L (Exposure Lock) Indicator

When using panorama assist mode, all images in the panorama have the same exposure, white balance, and focus as the first image of the panorama.

When the first image is shot, AE/AF-L is displayed in the monitor to indicate that exposure, white balance, and focus are locked.



📌 Panorama Creation with Panorama Maker

Transfer images to a computer (📖106) and use Panorama Maker to join them in a single panorama.

- Panorama Maker can be installed on a computer using the included ViewNX 2 CD-ROM (📖104).
- For more information on using Panorama Maker, refer to the on-screen instructions and help information contained in Panorama Maker.

Viewing and Deleting Images Captured Continuously (Sequence)

Viewing Images in a Sequence

Images captured continuously are saved as a sequence.

The first image of a sequence is used as the key picture to represent the sequence when displayed in full-frame playback mode or thumbnail playback mode (default setting).

To display each image in the sequence individually, press the **OK** button.

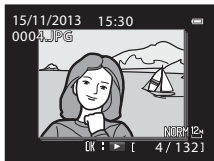

After pressing the **OK** button, the operations listed below are available.

- To display the previous or next image, rotate the multi selector or press **◀▶**.
- To display images that are not included in the sequence, press **▲** to return to the key picture display.
- To display images in a sequence as thumbnails, or to play them back in a slide show, set **Sequence display options to Individual pictures** in the playback menu (069).

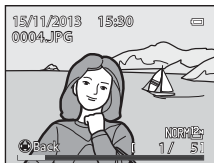

✓ Sequence Display Options

Images captured continuously with cameras other than this camera cannot be displayed as a sequence.

📎 Playback Menu Options Available When Using Sequence

- When images in a sequence are displayed in full-frame playback mode, press the **MENU** button to select functions in playback menu (88).
- If you press the **MENU** button when a key picture is displayed, the following settings can be applied to all images in the sequence:
 - Print order, Protect, Copy

Deleting Images in a Sequence

When the  button is pressed for images in a sequence, the images that are deleted vary depending on how the sequences are displayed.

- When the key picture is displayed: All images in the displayed sequence are deleted.
- When images in a sequence are displayed in full-frame playback mode: The image currently displayed is deleted.

When **Delete** (65) of the playback menu is used, multiple images can be deleted or multiple images in the same sequence can be selected and deleted.

Editing Still Images

Before Editing Images

You can easily edit images on this camera. Edited copies are saved as separate files (📷103).

Edited copies are saved with the same shooting date and time as the original.

Restrictions on Image Editing

- Images taken using an aspect ratio of 16:9, 3:2 or 1:1 cannot be edited (except when using the black border editing function).
- Editing other than **RAW (NRW) processing** cannot be performed on RAW (NRW) images.
Edit a JPEG image created with RAW (NRW) processing.
If you select images taken with an image quality of **RAW (NRW) + Fine** or **RAW (NRW) + Normal**, only the JPEG images will be edited.
- Images that were extracted from a movie cannot be edited using the quick retouch or skin softening function.
- When an edited copy is further modified with another editing function, check the following restrictions.

Editing function used	Editing functions to use
Quick retouch D-Lighting	The skin softening, filter effects, small picture, black border, straighten, or crop function can be used. The quick retouch and D-Lighting functions cannot be used in combination.
Skin softening Filter effects Straighten RAW (NRW) processing	Other editing functions can be used.
Small picture	Another editing function cannot be used. When using in combination with other editing functions, use the small picture after the other editing functions have been applied.
Black border	The small picture function can be used.
Crop	The black border or straighten function can be used. <ul style="list-style-type: none">• Another editing function cannot be used if the image size is extremely small after the crop function is applied.

- Copies created with editing functions cannot be further edited with the same function used to create them.

Quick Retouch: Enhancing Contrast and Saturation

Select an image (📖36) → MENU button (📖12) →  Quick retouch

Use the multi selector ▲▼ to select the desired effect level and press the  button.

- The edited version is displayed on the right.
- To exit without saving the copy, press ◀.

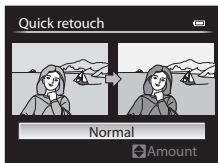

D-Lighting: Enhancing Brightness and Contrast

Select an image (📖36) → MENU button (📖12) →  D-Lighting

Use the multi selector ▲▼ to select the desired effect level and press the  button.

- The edited version is displayed on the right.
- To exit without saving the copy, press ◀.

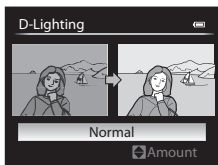



Skin Softening: Softening Skin Tones

Select an image (📖36) → MENU button (📖12) →  Skin softening

- 1 Use the multi selector ▲▼ to select the desired effect level and press the  button.

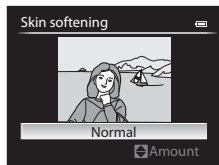
- To exit without saving the copy, press ◀.



- 2 Preview the result and press the  button.

- The edited face is zoomed in.
- When more than one face has been edited, press ◀▶ to switch the face that is displayed.
- To change the effect level, press the MENU button and return to step 1.
- An edited copy is created.



Notes About Skin Softening

- Up to 12 faces, in order of proximity to the center of the frame, can be enhanced.
- Depending upon the direction in which faces are looking, or the brightness of faces, the camera may be unable to accurately detect faces, or the skin softening function may not perform as expected.
- If no faces are detected, a warning is displayed and the screen returns to the playback menu.

Filter Effects: Applying Digital Filter Effects

Select an image (📖36) → MENU button (📖12) → 🎛️ Filter effects

Option	Description
Soft	Gently softens the focus of the image from the center to the edge. In images taken with face detection (📖83) or pet detection (📖45) selected, areas around faces will be blurred.
Selective color	Keeps only a selected image color and makes other colors black-and-white.
Cross screen	Produces star-like rays of light that radiate outward from bright objects such as sunlight reflections and city lights. Suitable for night scenes.
Fisheye	Creates images that look like they were shot with a fisheye lens. Suitable for images shot in macro mode.
Miniature effect	Creates images that look like close-up photos of a diorama. Suitable for images shot while looking down from a high location, with the main subject near the center of the frame.
Painting	Creates images with the ambience of paintings.
Vignette	Creates images by lowering the peripheral light intensity from the center to the edges of an image.

1 Use the multi selector ▲▼ to select the desired filter effect and press the **OK** button.

- When **Cross screen**, **Fisheye**, **Miniature effect**, **Painting** or **Vignette** is selected, proceed to step 3.

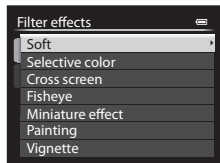

2 Adjust the effect and press the **OK** button.

- **Soft:** Use ▲▼ to select the extent of the effect.
- **Selective color:** Use ▲▼ to select the color to keep.

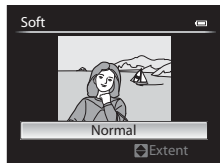

Soft

3 Preview the result and press the **OK** button.

- An edited copy is created.
- To exit without saving the copy, press ◀.



Small Picture: Reducing the Size of an Image

Select an image (📖36) → MENU button (📖12) →  Small picture

1 Use the multi selector ▲▼ to select the desired copy size and press the **OK** button.

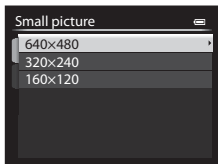

2 Select **Yes** and press the **OK** button.

- An edited copy is created (compression ratio of approximately 1:16).

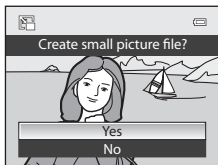

BK Black Border: Adding a Black Border to Images

Select an image (📖36) → MENU button (📖12) → **BK** Black border

- 1 Use the multi selector ▲▼ to select the desired border thickness and press the **OK** button.

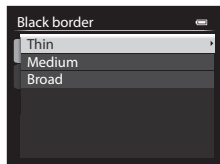

- 2 Select **Yes** and press the **OK** button.

- An edited copy is created.

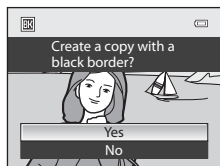

✓ Notes About Black Border

- A portion of the image equivalent to the thickness of the black border is cut off because the black border overlaps the image.
- When an image with a black border is printed using a printer's borderless print function, the black border may not be printed.

📷 Straighten: Compensating for Image Slanting

Select an image (📖36) → MENU button (📖12) → 📷 Straighten

Use the multi selector to compensate for slanting and press the **OK** button.

- Press ◀ to rotate counterclockwise by 1 degree.
- Press ▶ to rotate clockwise by 1 degree.
- To cancel, press the MENU button.

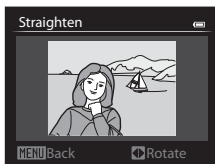

✔ Notes About Straighten

- The larger the slant for which compensation is performed, the larger the area around the image that is cut.
- Straighten can be performed up to 15 degrees.

NRW RAW (NRW) Processing: Creating JPEG Images from NRW Images

Press the ▶ button (playback mode) → MENU button (📖12) →
NRW RAW (NRW) processing

- 1 Use the multi selector ▲▼◀▶ to select the image to be RAW processed and press the **OK** button.

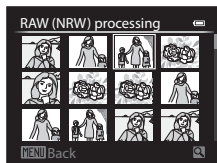

2 Set the RAW (NRW) processing parameters.

- Apply the settings below while checking the image and moving the zoom control toward **T** (Q). Move toward **T** (Q) again to return to the setting screen.
 - White balance** (🔍35)
 - Exp. +/-**
 - Picture Control** (🔍40)
 - Image quality** (🔍27)
 - Image size** (🔍29)
 - Distortion control** (🔍55)
 - D-Lighting** (🔍10)
- Press the  button to change back to the default settings.
- Select **EXE** when all settings have been adjusted.

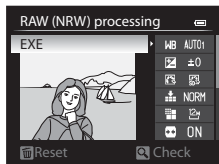

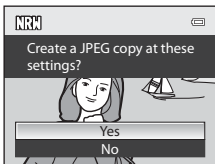

3 Select **Yes** and press the **OK** button.

- A JPEG image is created.



✓ Notes About RAW (NRW) Processing

- This camera can only create JPEG-format copies of RAW (NRW) images taken with this camera.
- The image is cropped if **Image size** is set to  **3984×2656**,  **3968×2232** or  **3000×3000**.
- Preset manual** of **White balance** can only be selected for images taken with **White balance** set to **Preset manual**.
- The **Noise reduction filter** (🔍54) that was set for shooting images is applied to the JPEG images to be created.







More Information

See "Printing Images of Size 1:1" (🔍29) for more information.

Crop: Creating a Cropped Copy

1 Move the zoom control to enlarge the image (86).

2 Refine copy composition and press the **MENU** button.

- Move the zoom control toward **T** () or **W** () to adjust the zoom ratio. Set a zoom ratio at which **MENU**  is displayed.
- Use the multi selector     to scroll the image so that only the portion to be copied is visible in the monitor.



3 Select **Yes** and press the **OK** button.

- An edited copy is created.

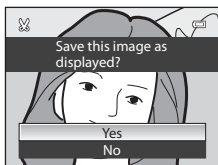



Image Size

When the image size of the cropped copy is 320 x 240 or smaller, the image is displayed at a smaller size during playback.

Cropping the Image in Its Current “Tall” Orientation

Use the **Rotate image** option ()66) to rotate the image so that it is displayed in landscape orientation. After cropping the image, rotate the cropped image back to “tall” orientation.

Connecting the Camera to a TV (Viewing Images on a TV)

1 Turn off the camera and connect it to the TV.

- Make sure that the plugs are properly oriented. Do not insert or remove the plugs at an angle when connecting or disconnecting them.

When using the optional audio video cable (🔗104)

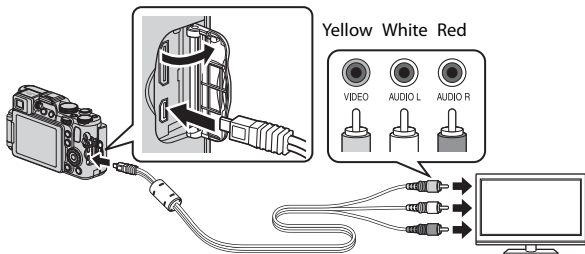

When using a commercially available HDMI cable

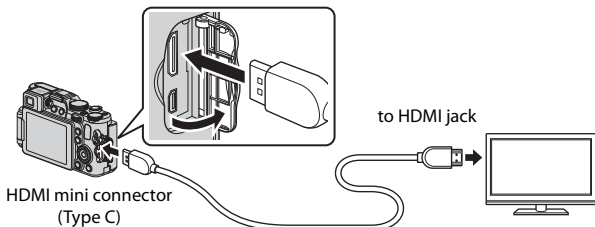

2 Set the TV's input to external video input.

- See the documentation provided with your TV for details.

3 Hold down the button to turn on the camera.

- Images are displayed on the TV.
- The camera monitor does not turn on.

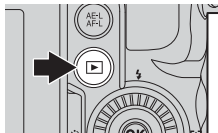

If Images Are Not Displayed on the TV

Make sure that **TV settings** (86) in the setup menu conforms to the standard used by your TV.

Using a TV Remote Control (HDMI Device Control)

The remote control of an HDMI-CEC-compatible TV can be used to select images, start and pause movie playback, switch between full-screen playback mode and four-image thumbnail display, etc.

- Set **HDMI device control** (86) of **TV settings** to **On** (default setting) in the setup menu, and then connect the camera and TV using an HDMI cable.
- Aim the remote control at the TV when operating it.

Connecting the Camera to a Printer (Direct Print)

Users of PictBridge-compatible printers can connect the camera directly to the printer and print images without using a computer.

Connecting the Camera to a Printer

- 1 Turn off the camera.
- 2 Turn on the printer.
 - Check printer settings.
- 3 Connect the camera to the printer using the included USB cable.
 - Make sure that the plugs are properly oriented. Do not insert or remove the plugs at an angle when connecting or disconnecting them.

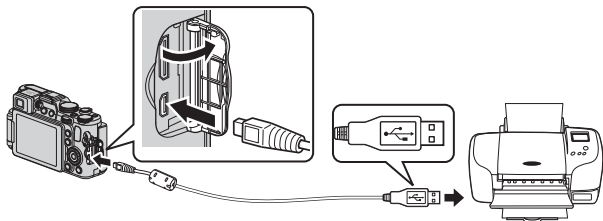

4 The camera is automatically turned on.

- The **PictBridge** startup screen (①) is displayed in the camera monitor, followed by the **Print selection** screen (②).

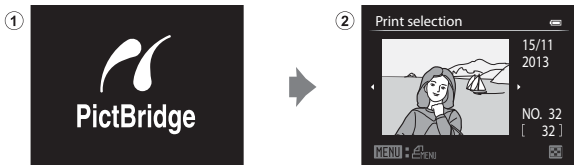

More Information

See "Printing Images of Size 1:1" (🔍29) for more information.

Printing Individual Images

- 1 Use the multi selector ▲▼◀▶ to select the desired image and press the **OK** button.

- Move the zoom control toward **W** (🔍) to switch to thumbnail playback or **T** (📄) to switch to full-frame playback.

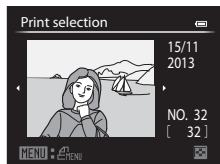

- 2 Use ▲▼ to select **Copies** and press the **OK** button.

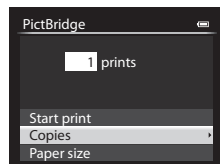

- 3 Select the desired number of copies (up to 9) and press the **OK** button.

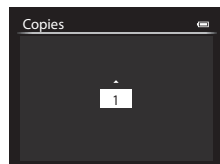

- 4** Select **Paper size** and press the **OK** button.

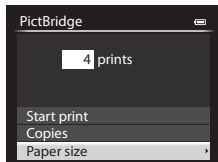

- 5** Select the desired paper size and press the **OK** button.

- To apply the paper size setting configured on the printer, select **Default** as the paper size option.
- The paper size options available on the camera vary depending on the printer that you use.

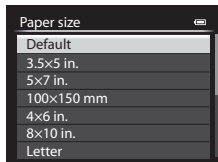

- 6** Select **Start print** and press the **OK** button.

- Printing starts.
- To cancel printing, press the **OK** button.

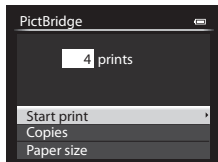

Printing Multiple Images

- 1** When the **Print selection** screen is displayed, press the **MENU** button.

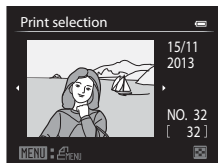

2 Use the multi selector ▲▼ to select **Paper size** and press the **OK** button.

- To exit the print menu, press the **MENU** button.

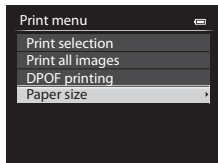

3 Select the desired paper size and press the **OK** button.

- To apply the paper size setting configured on the printer, select **Default** as the paper size option.
- The paper size options available on the camera vary depending on the printer that you use.

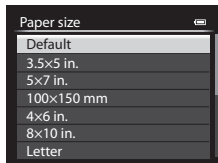

4 Select **Print selection, Print all images, or DPOF printing** and press the **OK** button.

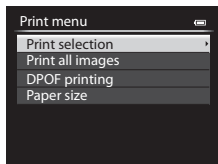

Print selection

Select images (up to 99) and the number of copies (up to 9) of each.

- Use the multi selector ◀▶ to select images, and use ▲▼ to specify the number of copies to be printed.
- Images selected for printing are indicated by the check mark icon and the numeral indicating the number of copies to be printed. If no copies have been specified for images, the selection is canceled.
- Move the zoom control toward **T** (Q) to switch to full-frame playback or **W** (R) to switch to thumbnail playback.
- Press the **OK** button when setting is complete.
- When the screen shown on the right is displayed, select **Start print** and press the **OK** button to start printing.

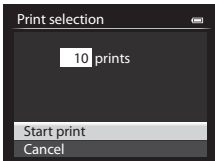

Print all images

One copy each of all images saved in the internal memory, or on the memory card, is printed.

- When the screen shown on the right is displayed, select **Start print** and press the **OK** button to start printing.

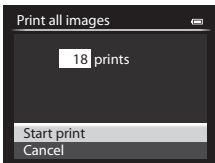

DPOF printing

Print images for which a print order was created using the **Print order** option (62).

- When the screen shown on the right is displayed, select **Start print** and press the **OK** button to start printing.
To view the current print order, select **View images** and press the **OK** button. To print images, press the **OK** button again.

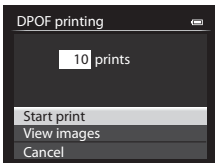

Editing Movies

Extracting Only the Desired Portion of a Movie

The desired portion of a recorded movie can be saved as a separate file.

1 Play back the desired movie and pause at the start point of the portion that is to be extracted (📖98).

2 Use the multi selector ◀▶ to select the ✂ control, and then press the Ⓞ button.

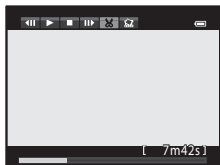

3 Use ▲▼ to select the ⏮ control (Choose start point).

- Use the multi selector ◀▶ or rotate it to move the start point.
- To cancel editing, select ⏪ (Back), and press the Ⓞ button.

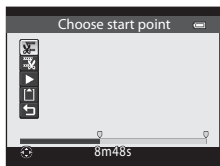

4 Use ▲▼ to select the ⏭ control (Choose end point).

- Use the multi selector ◀▶ or rotate it to move the end point.
- To preview the specified portion, use ▲▼ to select ▶ and then press the Ⓞ button. Press the Ⓞ button again to stop previewing.

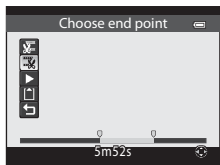

5 Use ▲▼ to select the 💾 control (Save) and press the Ⓞ button.

- Follow the instructions on the screen to save the movie.

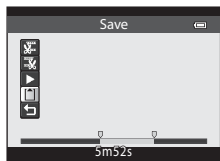





✓ Notes About Movie Editing



- Use a sufficiently charged battery to prevent the camera from turning off during editing. When the battery level indicator is , movie editing is not possible.
- A movie that was created by editing cannot be trimmed again.
- The actual trimmed portion of a movie may differ slightly from the portion selected using the start and end points.
- Movies cannot be trimmed so that they are less than two seconds long.

Saving a Frame from a Movie as a Still Image

The desired frame of a recorded movie can be extracted and saved as a still image.

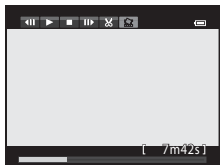
- Pause a movie and display the frame to be extracted (98).
- Use the multi selector  to select the  control and press the  button.



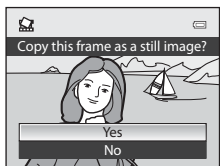

- Select **Yes** when a confirmation dialog is displayed, and press the  button to save the image.
- The still image is saved with **Normal** as the image quality. The image size is determined by the type (image size) (30) of the original movie.

For example, a still image saved from a movie recorded with  **1080★/30p** (or  **1080★/25p**) is  (1920 × 1080 pixels).



The Quick Menu



QUAL Image Quality and Image Size

Display the still image shooting screen →  button → QUAL (Image quality/Image size) tab (70)

Set the image quality (compression ratio) and image size (number of pixels) used when saving images.

Available Image Quality

Lower compression ratios result in higher quality images, but the number of images that can be saved is reduced.

	Option	Description
FINE	Fine	Fine image quality than Normal . File format: JPEG, compression ratio of about 1:4
NORM	Normal (default setting)	Normal image quality, suitable for most applications. File format: JPEG, compression ratio of about 1:8
NRW+ FINE	RAW (NRW) + Fine	Two images are recorded at the same time: one RAW (NRW) image and one fine-quality JPEG image.
NRW+ NORM	RAW (NRW) + Normal	Two images are recorded at the same time: one RAW (NRW) image and one normal-quality JPEG image.
NRW	RAW (NRW)	Raw data from the image sensor are saved. Create JPEG image files after shooting using RAW (NRW) processing ( 15) in the playback menu. <ul style="list-style-type: none">When RAW (NRW) is selected, Image size is reset to  4000×3000. File format: RAW (NRW), Nikon's own format

RAW (NRW) Images of This Camera



- To print or edit RAW (NRW) images, use JPEG images created from the RAW (NRW) images using **RAW (NRW) processing** ( 15). RAW (NRW) images cannot be printed or edited.
- ViewNX 2 ( 104) needs to be installed on the computer to be able to view RAW (NRW) images on the computer. Capture NX 2 is also compatible with RAW (NRW) images.



Image Quality Setting

- The image quality can be set in any shooting mode. The setting is also applied to other shooting modes (except **U1**, **U2** and **U3** shooting modes and **Easy panorama** scene mode).
- RAW (NRW) images cannot be recorded in the following shooting modes.
 - Scene mode
 - Special effects mode (except **Zoom exposure** and **Defocus during exposure**)

If you change the shooting mode to either of the above shooting modes when a RAW (NRW) image quality has been selected, the image quality will change to **Fine** or **Normal**.

- Digital zoom cannot be used when **Image quality** is set to **RAW (NRW)**, **RAW (NRW) + Fine** or **RAW (NRW) + Normal**.
- The setting may not be changed when using certain settings of other functions.

Recording of RAW (NRW) and JPEG Images at the Same Time

- The RAW (NRW) image and the JPEG image that are recorded at the same time have the same file number but with their own file extensions, ".NRW" and ".JPG" ( 103).
- When playing back on the camera, only the JPEG image is displayed.
- Note that when the JPEG image is deleted by pressing the  button, the RAW (NRW) image that was recorded at the same time is also deleted.

Number of Images That Can Be Saved

- The approximate number of images that can be saved can be checked in the monitor when shooting ( 26).
- Note that due to JPEG compression, the number of images that can be saved may vary greatly depending on the image content, even when using memory cards with the same capacity and the same image quality and image size settings. In addition, the number of images that can be saved may vary depending on the make of the memory card.
- If the number of exposures remaining is 10,000 or more, the number of exposures remaining display shows "9999".

Available Image Size

Set the image size (number of pixels) used when saving JPEG images. The larger the image size, the larger the size at which it can be printed, but the number of images that can be saved is reduced.













Option	Aspect ratio (horizontal to vertical)
 4000×3000 (default setting)	4:3
 3264×2448	4:3
 2272×1704	4:3
 1600×1200	4:3
 640×480	4:3
 3984×2656	3:2
 3968×2232	16:9
 3000×3000	1:1





Image Size Setting

- The image size can be set in any shooting mode. The setting is also applied to other shooting modes (except **U1**, **U2** and **U3** shooting modes and **Easy panorama** scene mode).
- The size of JPEG images can be selected when you create JPEG images from RAW (NRW) images using **RAW (NRW) processing** ( 15) (up to a maximum of 4000 × 3000 pixels).
- Image size** for the JPEG image can be set when **RAW (NRW) + Fine** or **RAW (NRW) + Normal** is selected. However, note that  **3984×2656**,  **3968×2232** and  **3000×3000** cannot be selected.
- The setting may not be changed when using certain settings of other functions.

Printing Images of Size 1:1

Change the printer setting to “Border” when printing images with the size set to 1:1. The images may not be printed in 1:1 ratio depending on the printer.

QUAL Movie Options









Rotate the mode dial to  or  CSM →  button → QUAL (Movie options) tab (70)

Select the desired movie option to record.

Select normal speed movie options to record at normal speed, or HS movie options (31) to record in slow or fast motion.



- Memory cards (Class 6 or higher) are recommended for recording movies (25).

Normal Speed Movie Options

Option (Image size/ Frame rate, File format)*	Image size	Aspect ratio (horizontal to vertical)
 1080★/30p  1080★/25p (default setting)	1920 × 1080 (High)	16:9
 1080/30p  1080/25p	1920 × 1080	16:9
 720/30p  720/25p	1280 × 720	16:9
 480/30p  480/25p	640 × 480	4:3

* The items and frame rate that can be set vary depending on the settings of **Video mode** in the **TV settings** (86) setup menu. The frame rate can be set to about 30 fps for **NTSC**, and about 25 fps for **PAL**.



Notes About Movie Custom Setting Mode

 **480/30p** (or  **480/25p**) of normal speed movies and HS movies cannot be selected.

HS Movie Options (🎬 (Movie) Mode Only)

Recorded movies are played back in fast or slow motion.

See “Playing Back in Slow Motion and Fast Motion” (👁️32) for more information.

Option	Image size Aspect ratio (horizontal to vertical)	Description
 HS 480/4x	640 × 480 4:3	1/4-speed slow motion movies • Max. recording time: 7 minutes 15 seconds (playback time: 29 minutes)
 HS 720/2x	1280 × 720 16:9	1/2-speed slow motion movies • Max. recording time: 14 minutes 30 seconds (playback time: 29 minutes)
 HS 1080/ 0.5x	1920 × 1080 16:9	2x speed fast motion movies • Max. recording time: 29 minutes (playback time: 14 minutes 30 seconds)

✔️ Notes About HS Movie

- Sound is not recorded.
- Zoom position, focus, exposure, and white balance are locked when movie recording starts.



Playing Back in Slow Motion and Fast Motion

When recording at normal speed:

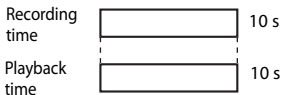

When recording at $\frac{480}{120}$ / $\frac{480}{100}$ HS 480/4x:

Movies are recorded at 4x normal speed.

They are played back in slow motion at 4x slower speed.

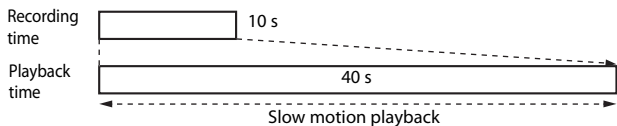

When recording at $\frac{1080}{15}$ / $\frac{1080}{75}$ HS 1080/0.5x:

Movies are recorded at 1/2 normal speed.

They are played back in fast motion at 2x faster speed.

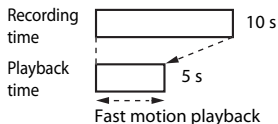

ISO ISO Sensitivity

Rotate the mode dial to **P, S, A, M, U1, U2, U3** or **CSM** → **Q** button → **ISO (ISO sensitivity) tab** (📖70)

Higher ISO sensitivity allows darker subjects to be captured. Additionally, even with subjects of similar brightness, images can be taken at faster shutter speeds, and blurring caused by camera shake and subject movement can be reduced.

- When higher ISO sensitivity is set, images may contain noise.

Option	Description
ISO sensitivity	<ul style="list-style-type: none">• Auto (default setting): ISO sensitivity is automatically adjusted within a range from ISO 80 to 1600.• ISO 200 ISO 80-200, ISO 400 ISO 80-400, ISO 800 ISO 80-800 (fixed range auto): Restrict the range in which the camera automatically adjusts ISO sensitivity.• 80 to 3200, Hi 1 (equivalent to ISO 6400): ISO sensitivity is fixed at the specified value.
Minimum shutter speed	<p>Set the shutter speed at which ISO sensitivity starts to be automatically adjusted, when the shooting mode is P or A. If the exposure is insufficient with the shutter speed that is set here, the ISO sensitivity is increased automatically to obtain the correct exposure.</p> <ul style="list-style-type: none">• The setting is enabled when ISO sensitivity is set to Auto, ISO 80-200, ISO 80-400 or ISO 80-800.• If the exposure is still insufficient even after ISO sensitivity is increased, the shutter speed slows down.• Default setting: None

ISO Sensitivity Display on the Shooting Screen

- When **Auto** is selected, **ISO** is displayed if the ISO sensitivity automatically increases.
- When **ISO 80-200, ISO 80-400** or **ISO 80-800** is selected, the maximum value for ISO sensitivity is displayed.

Notes About ISO Sensitivity

- In **M** (manual) mode, when set to **Auto, ISO 80-200, ISO 80-400** or **ISO 80-800**, the ISO sensitivity is fixed at ISO 80.
- The setting may not be changed when using certain settings of other functions.

Notes About ISO Sensitivity Settings in CSM (Movie Custom Setting) Mode

- When **Shooting mode** ( 70) of the movie custom setting menu is set to **Special effects**, ISO sensitivity cannot be set.
- **ISO 80-200, ISO 80-400, ISO 80-800, Hi 1** and **Minimum shutter speed** cannot be selected.
- When **Shooting mode** is set to **Aperture-priority auto** with **ISO sensitivity** set to **Auto**, ISO sensitivity is automatically adjusted within a range from ISO 80 to 3200. When Shooting mode is set to **Manual**, ISO sensitivity is fixed at ISO 80.

WB White Balance (Adjusting Hue)

Rotate the mode dial to P, S, A, M, U1, U2, U3, or CSM → button → WB (White balance) tab (70)

Adjust white balance to suit the light source or weather conditions in order to make the colors in images match what you see with your eyes.

- Use **Auto (normal)** under most conditions. Change the setting when you want to adjust the hue of the image you are taking.

Option	Description
AUTO1 Auto (normal) (default setting)	White balance is automatically adjusted to suit lighting conditions. When set to Auto (warm lighting) , the images are preserved with warm colors if they are shot under an incandescent light source. When using the flash, white balance is adjusted according to the flash lighting condition.
AUTO2 Auto (warm lighting)	
Daylight	White balance is adjusted for direct sunlight.
Incandescent	Use under incandescent lighting.
1 2 3	Select one of Fluorescent FL1 (white fluorescent), Fluorescent FL2 (daylight white/neutral fluorescent) and Fluorescent FL3 (daylight fluorescent).
Cloudy	Use when taking images under overcast skies.
Flash	Use with the flash.
Choose color temp.	Use to directly specify color temperature (36). • Select Choose color temp. of White balance in the first line, and then select the value of Choose color temp. in the second line.
PRE1 Preset manual 1 PRE2 Preset manual 2 PRE3 Preset manual 3	Use when the desired result is not achieved with Auto (normal) , Auto (warm lighting) , Incandescent , etc. (37).

Notes About White Balance

- Lower the flash when white balance is set to any setting other than **Auto (normal)**, **Auto (warm lighting)** or **Flash** (59).
- The setting may not be changed when using certain settings of other functions.

Fine Adjustment of White Balance

To perform fine adjustment of white balance, select **Fine-tune** and press the **OK** button.

Use the multi selector **▲▼◀▶** to configure settings.

- "A" represents amber, "B" blue, "G" green, and "M" magenta.
- Press the  button to reset.
- Rotate the sub-command dial to return to the previous screen.

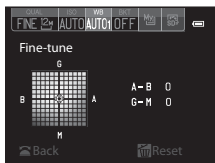

The color displayed in the fine-tune screen represents the approximate color in the color temperature direction. A fine-tuned color may not be exactly the same as that in the image. For example, when the white balance is set to **Incandescent**, the image will not have a strong blue color even if fine adjustment is performed in the B (blue) direction.

Color Temperature

Color temperature is an objective measure of colors of light sources which are expressed in the unit of absolute temperature (K: Kelvin). Light sources with lower color temperatures appear more reddish, while light sources with higher color temperatures appear more bluish.

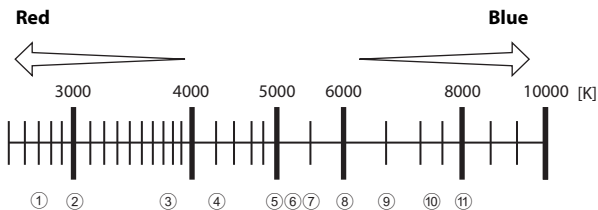

- | | |
|--|-----------------------------------|
| ① Sodium-vapor lamps: 2700K | ⑦ Flash: 5400K |
| ② Incandescent/
Warm-white fluorescent: 3000K | ⑧ Cloudy: 6000K |
| ③ White fluorescent: 3700K | ⑨ Daylight fluorescent: 6500K |
| ④ Cool-white fluorescent: 4200K | ⑩ High temp. mercury-vapor: 7200K |
| ⑤ Day white fluorescent: 5000K | ⑪ Shade: 8000K |
| ⑥ Direct sunlight: 5200K | |

Using Preset Manual

Use the procedure below to measure the white balance value under the lighting used during shooting.

- Up to 3 measured values can be saved: PRE1, PRE2 and PRE3.

1 Place a white or gray reference object under the lighting that will be used during shooting.

2 Use the multi selector ◀▶ to select PRE1, PRE2 or PRE3.

- Items can also be selected by rotating the main command dial.

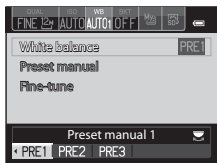

3 Use ▼ to select **Preset manual** and ▶◀ to select **PRE**.

- The lens extends to the zoom position for measurement.
- To apply the last measured value, select ✕.

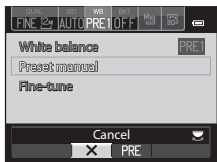

4 Frame the white or gray reference object in the measuring window, and press the OK button to measure the value.

- The shutter is released and measurement is complete. No image is saved.

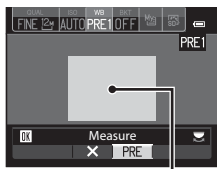



Measuring window

✓ Notes About Preset Manual

A value for flash lighting cannot be measured with **Preset manual**. When shooting using the flash, set **White balance** to **Auto (normal)**, **Auto (warm lighting)** or **Flash**.

BKT Auto Bracketing (Continuous Shooting While Changing the Exposure and White Balance)

Rotate the mode dial to P, S, A, M, U1, U2 or U3 →  button → BKT (Auto bracketing) tab ()

Continuous shooting can be performed while changing the exposure (brightness) automatically with the shutter speed (Tv), the aperture value (Av) or ISO sensitivity (Sv), or multiple images can be recorded while varying the white balance (WB). This is effective when adjusting the brightness of an image is difficult, or when multiple light sources are mixed together and it is difficult to decide the white balance.

1 Use the multi selector to select the desired type of bracketing ()39), and press .

- Items can also be selected by rotating the main command dial.

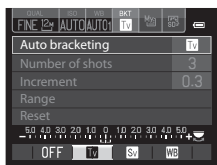

2 Select the number of images to shoot and press .

- 3 or 5 images can be selected.

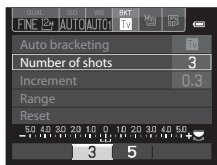



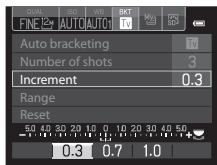

3 Select the desired step increment of compensation.

- For **WB** (white balance bracketing), select **Range** and set the bracketing range.



4 Press the button or the .

- The monitor display returns to the shooting screen.
- To change the values to the default setting, select **Reset** and press the .

Option		Description
OFF	OFF (default setting)	Bracketing is not performed.
	Exposure bracketing (Tv)	When the shutter-release button is pressed all the way, images are captured continuously while the shutter speed is changed automatically. • “Tv” stands for “Time value.”
	Exposure bracketing (Av)	When the shutter-release button is pressed all the way, images are captured continuously while the aperture value is changed automatically. • “Av” stands for “Aperture value.”
	Exposure bracketing (Sv)	When the shutter-release button is pressed all the way, images are captured continuously while changing the ISO sensitivity, with the shutter speed and aperture value fixed. • “Sv” stands for “Sensitivity value.”
	White balance bracketing	When the shutter-release button is pressed all the way, one image is captured, and the set number of images are recorded with the color temperature changed for each one.





Various types of bracketing can be set depending on the shooting mode.

Shooting mode	Exposure bracketing (Tv)	Exposure bracketing (Av)	Exposure bracketing (Sv)	White balance bracketing
P (Programmed auto)	✓	–	–	✓
S (Shutter-priority auto)	–	✓	–	✓
A (Aperture-priority auto)	✓	–	–	✓
M (Manual)	✓	–	✓	✓







Notes About Auto Bracketing

- When exposure compensation (69) is set with **AE Bracketing (Tv)**, **AE Bracketing (Av)** or **AE Bracketing (Sv)** simultaneously, a combined exposure compensation is applied. The new exposure compensation value updates the reference point to be displayed in the indicator.
- In **White balance bracketing**, only compensation for the color temperature (horizontal direction from A (amber) to B (blue)) is performed. Compensation in the vertical direction from G (green) to M (magenta) is not performed.
- The setting may not be changed when using certain settings of other functions.

Picture Control (COOLPIX Picture Control) **(Changing the Settings for Image Recording)**



Rotate the mode dial to P, S, A, M, U1, U2, U3 or  CSM →  button →  tab ( 70)

Change the settings for image recording according to the shooting scene or your preferences. Sharpness, contrast and saturation can be adjusted in detail.

Option	Description
 Standard (default setting)	Standard processing for balanced results. Recommended for most situations.
 Neutral	Minimal processing for natural results. Select for images that will later be extensively processed or retouched.
 Vivid	Images are enhanced for a vivid, photoprint effect. Select for images that emphasize primary colors, such as blue, red, and green.
 Monochrome	Shoots monochrome photographs such as in black-and-white or sepia.
 Custom 1*	Changes to the setting of Custom 1 in COOLPIX Custom Picture Control.
 Custom 2*	Changes to the setting of Custom 2 in COOLPIX Custom Picture Control.

* Only displayed when the setting customized in **Custom Picture Control** ( 44) has been registered.

COOLPIX Picture Control

- The COOLPIX Picture Control function of this camera cannot be used with other makes of cameras, Capture NX, Capture NX 2 and ViewNX 2 Picture Control function.
- In  CSM (movie custom setting) mode, Picture Control cannot be selected when **Shooting mode** ( 70) of the movie custom setting menu is set to **Special effects**.
- The setting may not be changed when using certain settings of other functions.

Customizing Existing COOLPIX Picture Controls: Quick Adjust and Manual Adjust

COOLPIX Picture Control can be customized using Quick adjust, which allows for balanced adjustment of sharpness, contrast, saturation and other image editing components, or manual adjust, which allows for detailed adjustment of the components individually.

- 1 Use the multi selector ▲▼ to select the desired type of COOLPIX Picture Control and press the OK button.

- Items can also be selected by rotating the main command dial.

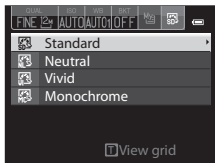

- 2 Use ▲▼ to highlight the desired setting (0-42) and use ◀▶ to select a value.

- Press the OK button to set the value.
- When COOLPIX Picture Controls are modified from the default settings, an asterisk (*) is displayed after the options in the Picture Control setting menu.
- To change the values to the default setting, select **Reset** and press the OK button.

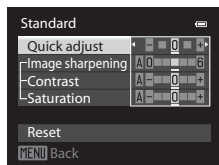

View Grid of COOLPIX Picture Control

When the zoom control is moved toward T (Q) on the screen shown in step 1, the current and default settings are displayed on a square grid so that you can see their relations with the other COOLPIX Picture Controls.

The vertical axis indicates the level of contrast, and the horizontal axis indicates the level of saturation. To return to the setting screen, move the zoom control toward T (Q) again.

- Rotate the multi selector to change to other COOLPIX Picture Controls.
- Press the OK button to display the COOLPIX Picture Control setting screen (step 2 above).
- For **Monochrome**, the grid is displayed for contrast only.
- The grid is also displayed when adjusting **Contrast** or **Saturation** with manual adjustment.

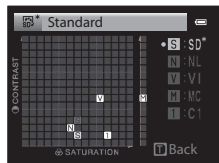

Types of Quick Adjust and Manual Adjust

Option	Description
Quick adjust ¹	Adjusts the sharpness, contrast and saturation levels automatically. Setting to the – side reduces the effect of the selected COOLPIX Picture Control, and setting to the + side emphasizes its effect. <ul style="list-style-type: none">• Default setting: 0
Image sharpening	Controls how much outlines are sharpened during shooting. The higher the number, the sharper the image, and the lower the number, the softer the image. Select A (auto) for automatic adjustment. <ul style="list-style-type: none">• Default setting: 3 for Standard or Monochrome, 2 for Neutral and 4 for Vivid
Contrast	Controls the contrast. Setting to the – side gives the image a softer appearance, and setting to the + side gives it a harder appearance. Select lower values to prevent highlights in portrait subjects from being “washed out” in direct sunlight, higher values to preserve detail in misty landscapes and other low-contrast subjects. Select A (auto) for automatic adjustment. <ul style="list-style-type: none">• Default setting: 0
Saturation ²	Controls the vividness of colors. Setting to the – side reduces the vividness, and setting to the + side increases the vividness. Select A (auto) for automatic adjustment. <ul style="list-style-type: none">• Default setting: 0
Filter effects ³	Simulates the effect of color filters on monochrome photographs. <ul style="list-style-type: none">• OFF: Filter effects are not used.• Y (yellow), O (orange), R (red): Enhance contrast. Can be used to tone down the brightness of the sky in landscape photographs. The contrast is strengthened in the order Y → O → R.• G (green): Softens skin tones. Suitable for portraits.• Default setting: OFF

Option	Description
Toning ³	Controls the tint used in monochrome photographs from B&W (black-and-white), Sepia , and Cyanotype (blue-tinted monochrome). Pressing the multi selector ▼ when Sepia or Cyanotype is selected enables you to select a saturation level. Press ◀▶ to adjust the saturation. <ul style="list-style-type: none"> • Default setting: B&W (black-and-white)

¹ Quick adjust is not available in **Neutral**, **Monochrome**, **Custom 1** and **Custom 2**.
 The values set manually are disabled if quick adjust is used after manual setting.

² Not displayed for **Monochrome**.

³ Only displayed for **Monochrome**.

Notes About Image Sharpening

- The effects of **Image sharpening** cannot be previewed in the monitor during shooting. Check the results in playback mode.
- In  CSM (movie custom setting) mode, the image sharpening effect is fixed at **A** (auto).

Contrast, Saturation and A (Auto)

- Results for contrast and saturation vary with the exposure, and the position and size of the subject in the frame.
- The setting for the COOLPIX Picture Control which has **A** (auto) selected for either **Contrast** or **Saturation** is displayed in green in the COOLPIX Picture Control grid.

The Shooting Menu (P, S, A or M Mode)

Custom Picture Control (COOLPIX Custom Picture Control)

Rotate the mode dial to P, S, A, M, U1, U2 or U3 → MENU button → P, S, A or M tab (📖13) → Custom Picture Control

Customize the settings of COOLPIX Picture Control (🔑41) and register them in **Custom 1** or **Custom 2** of **Picture Control** in the quick menu.

Creating COOLPIX Custom Picture Controls

- 1 Use the multi selector ▲▼ to select **Edit and save**, and press the Ⓞ button.

- Select **Delete** to delete a registered Custom Picture Control.

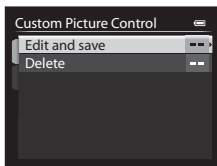

- 2 Select the original COOLPIX Picture Control (🔑41) to be edited, and press the Ⓞ button.

- 3 Use ▲▼ to highlight the desired setting and use ◀▶ to select a value (🔑41).

- The options are the same as those for adjusting the COOLPIX Picture Control.
- Press the Ⓞ button when you finish adjustment.
- To change the values to the default setting, select **Reset** and press the Ⓞ button.

- 4 Select the registration destination and press the Ⓞ button.

- **Custom 1** or **Custom 2** becomes selectable in **Picture Control** of the quick menu.
- To change the adjusted values, select **Custom 1** or **Custom 2** in **Picture Control** or **Custom Picture Control**.

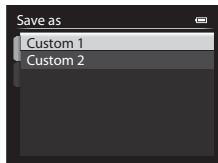



Metering

Rotate the mode dial to **P, S, A, M, U1, U2** or **U3** → **MENU** button → **P, S, A** or **M** tab (📖13) → **Metering**

The process of measuring the brightness of the subject to determine the exposure is known as “metering.”

Use this option to set the method of how the camera meters exposure.

Option	Description
 Matrix ¹ (default setting)	The camera uses a wide area of the screen for metering. Recommended for typical shooting.
 Center-weighted	The camera meters the entire frame but assigns greatest weight to the subject in the center of the frame. The classic metering for portraits; it preserves background details while letting lighting conditions in the center of the frame determine exposure. ²
 Spot ¹	The camera meters the area shown by the circle in the center of the frame. This can be used when the subject is much lighter or darker than the background. Ensure that the subject is within the area shown by the circle when shooting. ²

¹ When **Focus-coupled metering** is set to **On** and **AF area mode** (🔍49) is set to **Manual**, the brightness of the subject is measured by giving higher priority to the focus area. See “Focus-coupled Metering” (🔍58) for more information.

² Can be used with focus lock (📖85) to meter off-center subjects.

✓ **Notes About Metering**











- When digital zoom is in effect, **Center-weighted** or **Spot** is selected depending on the magnification of an enlargement.
- The setting may not be changed when using certain settings of other functions.

📎 **Display on the Shooting Screen**

- When **Center-weighted** or **Spot** is selected, the metering range guide (📖16) is displayed (except when digital zoom is used).
- When **Focus-coupled metering** is set to **On**, the metering range guide for **Spot** is not displayed.

Continuous Shooting

Rotate the mode dial to **P, S, A, M, U1, U2** or **U3** → **MENU** button → **P, S, A** or **M** tab (📖13) → Continuous

Option	Description
 Single (default setting)	One image is shot each time the shutter-release button is pressed.
 Continuous H	While the shutter-release button is held all the way down, images are captured continuously. <ul style="list-style-type: none">The frame rate for continuous shooting is about 8 fps and the maximum number of continuous shots is about 6 (when image quality is set to Normal and image size is set to  4000×3000).
 Continuous M	While the shutter-release button is held all the way down, images are captured continuously. <ul style="list-style-type: none">The frame rate for continuous shooting is about 4 fps and the maximum number of continuous shots is about 6 (when image quality is set to Normal and image size is set to  4000×3000).
 Continuous L	While the shutter-release button is held all the way down, images are captured continuously. <ul style="list-style-type: none">The frame rate for continuous shooting is about 1 fps and the maximum number of continuous shots is about 30 (when image quality is set to Normal and image size is set to  4000×3000).
 BSS (Best Shot Selector)	While the shutter-release button is held all the way down, the camera captures a series of up to 10 images and automatically saves the sharpest image. Use when shooting a stationary subject in a place where flash photography is prohibited and camera shake is likely to occur.
 Multi-shot 16	Each time the shutter-release button is pressed all the way, the camera captures a series of 16 images and saves it as a single image. <ul style="list-style-type: none">The frame rate for continuous shooting is about 30 fps.Image quality is set to Normal and image size is fixed at  (2560 × 1920 pixels).Digital zoom is not available. 

Option	Description
120 Continuous H: 120 fps	Each time the shutter-release button is pressed all the way, images are captured at a high speed rate. <ul style="list-style-type: none"> The frame rate for continuous shooting is about 120 fps and the maximum number of continuous shots is 60. Image size is fixed at (1280 × 960 pixels).
60 Continuous H: 60 fps	Each time the shutter-release button is pressed all the way, images are captured at a high speed rate. <ul style="list-style-type: none"> The frame rate for continuous shooting is about 60 fps and the maximum number of continuous shots is 60. Image size is fixed at (1280 × 960 pixels).
Intvl timer shooting	The camera shoots still images automatically at the specified interval (47).

✓ Notes About Continuous Shooting

- Focus, exposure and white balance are fixed at the values determined with the first shot in each series.
- It may take some time to save the images after shooting.
- When ISO sensitivity increases, noise may appear in captured images.
- The frame rate may become slower depending on the image quality, image size, memory card type or shooting conditions (such as when recording RAW images).
- When using **Multi-shot 16, Continuous H: 120 fps** or **Continuous H: 60 fps**, banding or variance in brightness or hue may occur in images that were captured under lighting that flashes quickly at high speeds, such as fluorescent, mercury-vapor, or sodium-vapor lighting.
- The setting may not be changed when using certain settings of other functions.

Interval Timer Shooting

Rotate the mode dial to P, S, A, M, U1, U2 or U3 → MENU button → P, S, A or M tab (13) → Continuous

- Use the multi selector to select **Intvl timer shooting**, and then press the button.

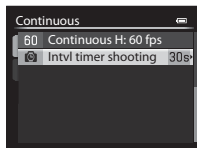

2 Select the desired interval between each shot and press the **OK** button.

- The maximum number of images that can be taken during interval timer shooting differs according to the selected interval.
 - 30 s:** 600 images
 - 1 min:** 300 images
 - 5 min:** 60 images
 - 10 min:** 30 images

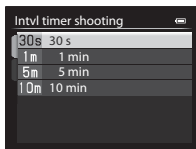

3 Press the **MENU** button to display the shooting screen.

4 Press the shutter-release button all the way to shoot the first image.

- The shutter is automatically released at the specified interval to shoot subsequent images.
- The monitor turns off and the power-on lamp flashes during the intervals between shots (when the battery is used).

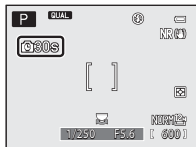

5 When the desired number of images have been taken, press the shutter-release button.

- Shooting ends.
- Shooting ends automatically when the number of shot images reaches the upper limit, or if the internal memory or memory card becomes full.

✓ Notes About Interval Timer Shooting



- To prevent the camera from turning off unexpectedly during shooting, use a fully charged battery.
- If the AC Adapter EH-5b and the Power Connector EP-5A (available separately) (☞ 104) are used, this camera can be powered from an electrical outlet. Do not, under any circumstances, use an AC adapter other than the EH-5b or a power connector other than the EP-5A. Failure to observe this precaution could result in overheating or damage to the camera.
- Do not rotate the mode dial to a different setting while performing interval timer shooting.

AF Area Mode

Rotate the mode dial to **P, S, A, M, U1, U2, U3** or **EFFECTS** → MENU button → **P, S, A, M** or  tab (📖13) → AF area mode

Change the method of how the camera selects the focus area for autofocus.

- The AF area mode can also be selected by pressing the multi selector  (📖58, 📖88).
- In **P, S, A** or **M** mode, the default setting is **Center (normal)**.
- In **EFFECTS** mode, the default setting is **Auto**.

Option	Description
 Face priority	<p>When the camera detects a human face, it focuses on that face. See "Using Face Detection" (📖83) for more information.</p> <p>When framing a composition with no human subjects or detected faces, AF area mode operates in the same way as when set to Auto.</p> <div data-bbox="637 436 916 647" data-label="Image"> </div> <p style="text-align: center;">Focus area</p>
 Auto	<p>The camera automatically selects one or more of the 9 focus areas containing the subject closest to the camera when the shutter-release button is pressed halfway.</p> <div data-bbox="637 735 916 939" data-label="Image"> </div> <p style="text-align: center;">Focus areas</p>

Option	Description
<p data-bbox="117 302 242 329">[MF] Manual</p>	<p data-bbox="313 110 601 215">Use the multi selector ▲▼◀▶ or rotate it to move the focus area to where you want to focus.</p> <ul data-bbox="313 222 601 521" style="list-style-type: none"> <li data-bbox="313 222 601 382">• To use the multi selector to configure the flash mode or other settings, press the OK button. To return to moving the focus area, press the OK button again. <li data-bbox="313 390 601 463">• At an Image size setting (📷29) of [1:1] 3000×3000, 81 focus areas are available. <li data-bbox="313 470 601 521">• When Metering (📷45) is set to Matrix, the camera meters by assigning greatest weight to the focus area.
<p data-bbox="117 615 254 642">[C] Center (normal)</p> <p data-bbox="117 674 234 700">[CW] Center (wide)</p>	<p data-bbox="313 543 596 615">The camera focuses on the area in the center of the frame.</p> <p data-bbox="313 623 596 695">Either the normal or wide size can be selected for the focus area.</p>
<p data-bbox="117 899 254 940">[ST] Subject tracking*</p>	<p data-bbox="313 812 596 1023">Use this function to take images of moving subjects. Register the subject on which the camera focuses. The focus area automatically moves to track the subject. See "Using Subject Tracking" (📷51) for more information.</p>

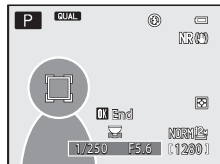
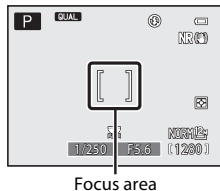
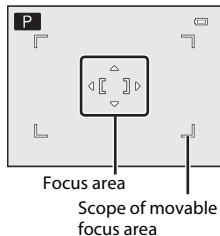

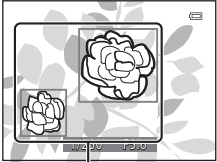
Option	Description
 Target finding AF*	<p>When the camera detects the main subject, it focuses on that subject. See "Using the Target Finding AF" (📖 82).</p>  <p style="text-align: center;">Focus areas</p>



* Not available in special effects mode.

Notes About AF Area Mode

- When digital zoom is in effect, the camera focuses on the area in the center of the frame regardless of the **AF area mode** setting.
- The setting may not be changed when using certain settings of other functions.

Using Subject Tracking

Rotate the mode dial to P, S, A, M, U1, U2 or U3 → MENU button → P, S, A or M tab (📖13) → AF area mode

1 Use the multi selector ▲▼ to select  **Subject tracking**, and press the  button.

- Press the **MENU** button after changing the settings and return to the shooting screen.
- The AF area mode can also be selected by pressing the multi selector ► (H).

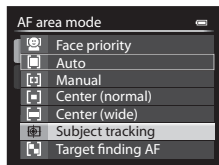

2 Register a subject.

- Align the subject that you want to track with the border in the center of the monitor and press the **OK** button.
- When the subject is registered, a yellow border (focus area) is displayed around that subject and the camera begins tracking that subject.
- If the subject cannot be registered, the border glows red. Change the composition and try registering the subject again.
- To cancel subject registration, press the **OK** button.
- If the camera can no longer track the registered subject, the focus area disappears. Register the subject again.

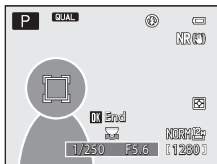
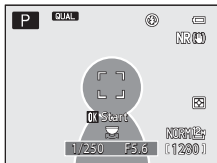

3 Press the shutter-release button fully to take the picture.

- If the shutter-release button is pressed while the focus area is not displayed, the camera focuses on the subject in the center of the frame.



✓ Notes About Subject Tracking

- If you perform operations such as zooming while the camera is tracking the subject, the registration is canceled.
- Subject tracking may not be possible in certain shooting conditions.

Autofocus Mode

Rotate the mode dial to P, S, A, M, U1, U2 or U3 → MENU button → P, S, A or M tab (📖13) → Autofocus mode

Select how the camera focuses when shooting still images.

Option	Description
AF-S Single AF (default setting)	The camera focuses only when the shutter-release button is pressed halfway.
AF-F Full-time AF	The camera continues focusing even when the shutter-release button is not pressed halfway. The sound of lens drive movement is heard while the camera focuses.

✔ Notes About Autofocus Mode

The setting may not be changed when using certain settings of other functions.

📎 Autofocus Mode for Movie Recording

Autofocus mode for movie recording can be set with **Autofocus mode** (🔍71) in the movie menu or movie custom setting menu.

Flash Exp. Comp.

Rotate the mode dial to P, S, A, M, U1, U2 or U3 → MENU button → P, S, A or M tab (📖13) → Flash exp. comp.

Adjust the flash output.

Use this option when the flash is too bright or too dark.

Option	Description
+0.3 to +2.0	The flash output is increased from +0.3 to +2.0 EV, in increments of 1/3 EV, to make the main subject of the frame appear brighter.
0.0 (default setting)	The flash output is not adjusted.
-0.3 to -2.0	The flash output is reduced from -0.3 to -2.0 EV, in increments of 1/3 EV, to prevent unwanted highlights or reflections.

Notes About Flash Exp. Comp.

When flash exposure compensation has been set on the optional flash unit the compensation values on the camera and the Speedlight are added.

Noise Reduction Filter

Rotate the mode dial to P, S, A, M, U1, U2 or U3 → MENU button → P, S, A or M tab (📖13) → Noise reduction filter

Set the strength of the noise reduction function that is normally performed when saving images.

Option	Description
NR High	Performs noise reduction at a level higher than the standard strength.
NR Normal (default setting)	Performs noise reduction at the standard strength.
NR Low	Performs noise reduction at a level lower than the standard strength.

Built-in ND Filter

Rotate the mode dial to **P, S, A, M, U1, U2** or **U3** → **MENU** button → **P, S, A** or **M** tab (📖13) → Built-in ND filter

When the camera's built-in ND filter is used, the amount of light that enters the camera can be reduced to about one-eighth (equivalent to three steps lower in terms of the exposure value) while shooting. Use in situations such as when overexposure results from the subject being too bright.

Option	Description
On	The ND filter is used to reduce the light.
Off (default setting)	The ND filter is not used.

Effects of the Built-in ND Filter

Using the filter may enable the shooting of subjects that are too bright without overexposing the image. It can also be used in situations such as when you want to slow down the shutter speed at a low aperture value.

For example, at a shutter speed of 1/2000 second with the correct exposure, if the ND filter is used to reduce the light in three steps, the speed can be changed to 1/250 second without changing the aperture value.

Distortion Control



Rotate the mode dial to **P, S, A, M, U1, U2** or **U3** → **MENU** button → **P, S, A** or **M** tab (📖13) → Distortion control

Option	Description
On	The peripheral distortion that occurs due to the intrinsic characteristics of lenses is corrected. The size of the frame is reduced, as compared to when distortion control is not enabled.
Off (default setting)	Distortion is not corrected.

Active D-Lighting

Rotate the mode dial to P, S, A, M, U1, U2 or U3 → MENU button → P, S, A or M tab (📖13) → Active D-Lighting

Details in highlights and shadows are preserved, and the natural contrast that is seen with the naked eye is well reproduced in the image taken. This is particularly effective for shooting scenes with high contrast, such as brightly lit outdoor scenery from a dark room or shaded subjects at a sunny seaside.

Option	Description
 High	Set the effect level.
 Normal	
 Low	
OFF Off (default setting)	Active D-Lighting is not applied.

✓ Notes About Active D-Lighting

- Additional time is required to record images after shooting.
- The setting may not be changed when using certain settings of other functions.

✓ Active D-Lighting Versus D-Lighting

The **Active D-Lighting** option in the shooting menu reduces exposure before shooting to optimize the dynamic range. The **D-Lighting** (🔍10) option in the playback menu optimizes dynamic range in images captured.

Zoom Memory

Rotate the mode dial to **P, S, A, M, U1, U2** or **U3** → **MENU** button → **P, S, A** or **M** tab (📖13) → Zoom memory

When the zoom control is moved while pressing the **Fn1** button, the zoom position (equivalent to focal length/angle of view in 35mm [135] format) is switched to the positions that have been selected by setting the check box to on in this menu option. The following settings are available: **28 mm, 35 mm, 50 mm, 85 mm, 105 mm, 135 mm** and **200 mm**.

- Select the focal length with the multi selector, and then press the **OK** button to set the check box to on or off.
- The default setting is on for all the check boxes.
- To finish the setting, press the multi selector **▶**.
- The focal length set in the **Startup zoom position** is automatically set to on .

Notes About Zoom Operation

- When more than one focal length has been set, move the zoom control while pressing the **Fn1** button to switch to the focal length closest to that before the operation. To switch to a different focal length, release the zoom control and then move it again.
- Release your finger from the **Fn1** button when using digital zoom.

Startup Zoom Position

Rotate the mode dial to **P, S, A, M, U1, U2** or **U3** → **MENU** button → **P, S, A** or **M** tab (📖13) → Startup zoom position

Set the zoom position (equivalent to focal length/angle of view in 35mm [135] format) for when the camera is turned on.

The following settings are available: **28 mm** (default setting), **35 mm, 50 mm, 85 mm, 105 mm, 135 mm** and **200 mm**.

M Exposure Preview

Rotate the mode dial to **P, S, A, M, U1, U2** or **U3** → MENU button → **P, S, A** or **M** tab (📖13) → M exposure preview

Option	Description
On	When the shutter speed and aperture value combination is changed in M (manual) mode, the brightness of the shooting screen changes accordingly.
Off (default setting)	The brightness of the shooting screen does not change.

Focus-coupled Metering

Rotate the mode dial to **P, S, A, M, U1, U2** or **U3** → MENU button → **P, S, A** or **M** tab (📖13) → Focus-coupled metering

Set whether or not to measure the brightness of the subject by giving higher priority to the focus area when **AF area mode** (🔍49) is set to **Manual**.

Option	Description
On (default setting)	When Metering (🔍45) is set to Matrix , the brightness is measured with emphasis on the focus area. When Metering is set to Spot , the brightness is measured in the focus area.
Off	The function for measuring the brightness coupled with the selected focus area is disabled.

Commander Mode

Rotate the mode dial to P, S, A, M, U1, U2 or U3 → MENU button → P, S, A or M tab (📖13) → Commander mode

Set how the wirelessly-controlled optional flash unit fires when the flash mode (📖59) is set to **CM** (commander mode).

Option	Description
Flash mode	<p>Standard flash (default setting): The flash unit (Speedlight) fires regardless of how bright the subject is.</p> <p>Slow sync: The flash unit illuminates the main subject and at the same time slow shutter speeds are used to capture the background.</p> <p>Rear-curtain sync: Fill flash fires on the flash unit just before the shutter closes.</p> <p>Red-eye reduction: If the camera detects "red-eye" while saving an image, it reduces the red-eye effect before the image is saved (📖61).</p>
Flash control mode	<p>TTL (default setting): Fill flash fires with the amount of light emitted by all flash units (Speedlights) automatically adjusted according to the shooting conditions.</p> <ul style="list-style-type: none">The compensation value is from -3.0 EV to +3.0 EV. <p>Manual: Fill flash fires after adjusting the amount of light emitted by all flash units.</p> <ul style="list-style-type: none">Select the flash output from M^FFULL (full flash), M^F1/2, M^F1/4, M^F1/8, M^F1/16, M^F1/32, M^F1/64 and M^F1/128.



More Information

- See "Using the Commander Mode" (📖60) for more information.
- See "Speedlights (External Flash Unit)" (📖108) for more information.

Using the Commander Mode

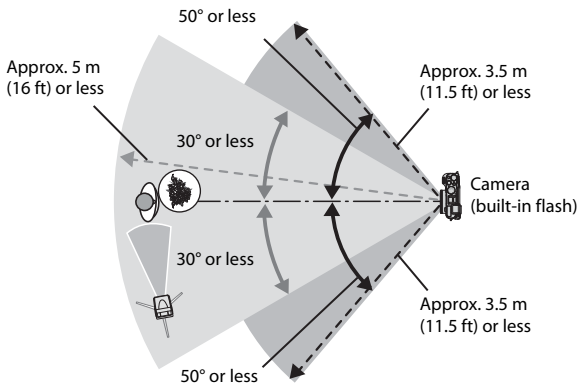

When the flash mode (📖59) is set to ⚡CMD (commander mode), you can wirelessly control an off-camera optional flash unit.

- Set the group and channel settings for the remote flash unit to “Group A” and “3 CH,” respectively.
- Place the flash unit within the range shown in the diagram below.
- Set up the remote flash unit facing the camera to ensure that the light from the built-in flash will enter the wireless remote sensor window of the remote flash unit. Set up the remote flash unit in a position closer to the subject than the camera.



- The distances shown in the diagram above may vary depending on the surrounding environment.

Notes About Using Commander Mode

- In commander mode, the camera's built-in flash emits low-level flashes in order to control the flash unit. Therefore, the built-in flash must always be raised when using commander mode. The remote flash unit fires in accordance with the **Commander mode** options (59) set.
- The built-in flash is not usable when it is set to the commander mode.
- Ensure that light directly from the flash unit or strong reflections do not enter the shooting lens of the camera. It may not be possible to obtain the correct exposure if such light enters the lens.
- If the light of the remote flash bounces and does not directly light a subject, set the **Flash control mode** of the **Commander mode** () to **Manual** in order to adjust the flash output.
- Aside from monitor preflashes, the camera's built-in flash emits low-level flashes during shooting to match the flash timing of the flash unit. When shooting a subject at close distance, these low-level flashes may be captured on the image. To prevent such adverse effects, use a lower ISO sensitivity or a larger aperture value (50).
- Refer to the documentation provided with your Speedlight for more information on flash unit settings.

The Playback Menu

See “Editing Still Images” (📷9) for information about image editing functions.

🖨️ Print Order (Creating a DPOF Print Order)

Press the  button (playback mode) → MENU button (📖12) → 🖨️ Print order

If you configure print order settings in advance, you can use them with the printing methods listed below.

- Taking the memory card to a digital photo lab that supports DPOF (Digital Print Order Format) printing.
- Inserting the memory card into a DPOF-compatible printer’s card slot.
- Connecting the camera to a PictBridge-compatible printer (📷20).

- 1 Use the multi selector ▲▼ to select **Select images**, and press the  button.

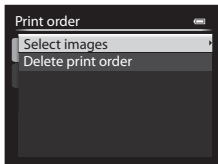

- 2 Select images (up to 99) and the number of copies (up to 9) of each.

- Use the multi selector ◀▶ or rotate it to select images, and use ▲▼ to specify the number of copies to be printed.
- Images selected for printing are indicated by the check mark icon and the numeral indicating the number of copies to be printed. If no copies have been specified for images, the selection is canceled.
- Move the zoom control toward T (📷) to switch to full-frame playback or W (🖼️) to switch to thumbnail playback.
- Press the  button when setting is complete.



3 Select whether or not to print shooting date and shooting information.

- Select **Date** and press the **OK** button to print the shooting date on all images.
- Select **Info** and press the **OK** button to print the shutter speed and aperture value on all images.
- Lastly, select **Done** and press the **OK** button to complete the print order.

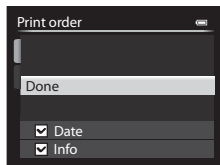

✓ Notes About Printing Shooting Date and Shooting Information

- Some printers may not be able to print the shooting date and shooting information.
- Shooting information is not printed when the camera is connected to a printer.
- The **Date** and **Info** settings are reset each time the **Print order** option is displayed.
- The date printed is that saved when the image was captured.
- For images taken with the **Print date** (Fn/77) option enabled, only the date and time imprinted at the time of shooting are printed, even if the **Print order** date option is enabled for the images.



✓ Notes About Print Order

RAW (NRW) images cannot be set for print order. Create a JPEG image using **RAW (NRW) processing** (Fn/15), and then set the JPEG image for print order.



📎 Canceling Existing Print Order

Select **Delete print order** in step 1 of "Print Order (Creating a DPOF Print Order)" (Fn/62).

📎 More Information



See "Printing Images of Size 1:1" (Fn/29) for more information.

Slide Show

Press the  button (playback mode) → MENU button (12) →  Slide show



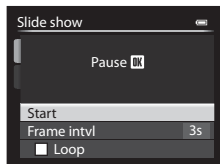

Play back images one by one in an automated “slide show.” When movie files (97) are played back in the slide show, only the first frame of each movie is displayed.

1 Use the multi selector to select **Start** and press the button.

- The slide show begins.
- To change the interval between images, select **Frame intvl**, press the  button, and specify the desired interval time before selecting **Start**.
- To repeat the slide show automatically, select **Loop** and press the  button before selecting **Start**.
- The maximum playback time is up to about 30 minutes even if **Loop** is enabled.





2 Select End or Restart.



- The screen shown on the right is displayed after the slide show ends or is paused. To exit the show, select  and then press the  button. To resume the slide show, select  and then press the  button.



Operations During Playback

- Use   to display the previous/next image. Press and hold to rewind/fast forward.
- Press the  button to pause or end the slide show.

Delete



Press the  button (playback mode) → MENU button (12) →  Delete

Delete selected images, or all images at one time.



See “Using the Screen for Selecting Images” (90) for more information.

Option	Description
Erase selected images	On the image selection screen, select the images for deletion. <ul style="list-style-type: none">When images where RAW (NRW) and JPEG images are recorded at the same time are selected, the RAW (NRW) and JPEG images are deleted at the same time.When the key picture of a sequence is selected, all images in the sequence are deleted.
All images	Delete all images. <ul style="list-style-type: none">This option is not displayed when images in a sequence are displayed in full-frame playback mode.
Entire sequence	This option is displayed when images in a sequence are displayed in full-frame playback mode. Delete all images in the displayed sequence.
Erase selected NRW images	Only RAW (NRW) images are displayed on the image selection screen. Select and delete images. <ul style="list-style-type: none">For images where RAW (NRW) and JPEG images are recorded at the same time, only RAW (NRW) images are deleted.
Erase selected JPEG images	Only JPEG images are displayed on the image selection screen. Select and delete images. <ul style="list-style-type: none">For images where RAW (NRW) and JPEG images are recorded at the same time, only JPEG images are deleted.

Notes About Deletion

- Deleted images cannot be recovered. Transfer important images to a computer before deleting them.
- Images marked with the  icon are protected and cannot be deleted (.
-  is displayed on the image selection screen for images where RAW (NRW) and JPEG images are recorded at the same time.

Protect



Press the  button (playback mode) → MENU button (12) →  Protect

The camera protects selected images from accidental deletion.

Select images to protect or cancel protection for previously protected images from the image selection screen (90).



Note that formatting the camera's internal memory or the memory card (85) permanently deletes protected files.

Rotate Image

Press the  button (playback mode) → MENU button (12) →  Rotate image

Specify the orientation in which saved images are displayed during playback. Still images can be rotated 90 degrees clockwise or 90 degrees counterclockwise.

Images that were recorded in the "tall" orientation can be rotated up to 180 degrees in either direction.

Select an image from the image selection screen (90). When the Rotate image screen is displayed, use the multi selector  or rotate it to rotate the image 90 degrees.

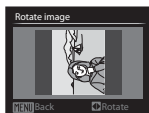

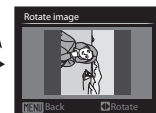
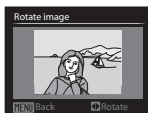

Rotate 90 degrees
counterclockwise



Rotate 90 degrees
clockwise





Press the  button to finalize display orientation, and save orientation information with the image.

Voice Memo

Press the  button (playback mode) → select an image → **MENU** button (12) →  Voice memo

Voice memos can be recorded and attached to images.

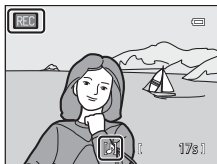

Recording Voice Memos

- Press and hold the  button to record (up to about 20 seconds).
- Do not touch the microphone.
- During recording, **REC** and  flash in the monitor.
- The voice memo playback screen is displayed after recording ends. Press the  button to play back the voice memo.
- Delete the current voice memo before recording a new voice memo.
-  is displayed for images with a voice memo when in full-frame playback mode.
- Press the multi selector  before or after recording a voice memo to return to the playback menu.





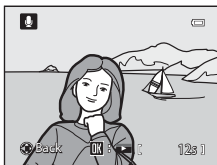

Playing Voice Memos

Select an image with  displayed before pressing the **MENU** button.

- Press the  button to play the voice memo. Press the button again to stop playback.
- Move the zoom control during playback to adjust playback volume.
- Press  before or after playing a voice memo to return to the playback menu.





Deleting Voice Memos

Press the  button on the voice memo playback screen. Use   to select **Yes** and press the  button.

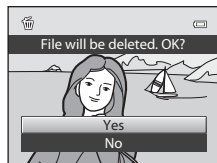

- To delete a voice memo for a protected image, the **Protect** setting must first be disabled.





Copy (Copy Between Internal Memory and Memory Card)

Press the  button (playback mode) → MENU button (12) →  Copy

Copy images or movies between the internal memory and a memory card.

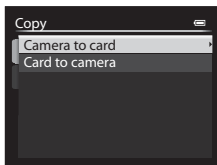
- 1 Use the multi selector   to select a destination option to which images are copied and press the  button.



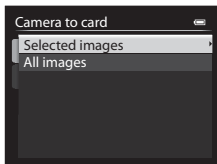

- 2 Select a copy option and press the  button.

- If you choose the **Selected images** option, use the image selection screen to specify images (90).



Notes About Copying Images

- Only files in formats that this camera can record can be copied.
- When images saved with an **Image quality** (27) setting of **RAW (NRW) + Fine** or **RAW (NRW) + Normal** are selected, the RAW (NRW) and JPEG images are copied at the same time.
- Operation is not guaranteed with images captured with another make of camera or that have been modified on a computer.
- The **Print order** (62) settings configured for images are not copied.



Notes About Copying Images in a Sequence

- If you select a key picture of a sequence in **Selected images**, all images in the sequence are copied.
- If you press the MENU button while images in a sequence are displayed, only the **Card to camera** copy option is available. All images in the sequence are copied if you select **Current sequence**.

Copying to a Memory Card That Contains No Images

When the camera is switched to playback mode, **Memory contains no images.** is displayed. Press the MENU button to select **Copy**.

Sequence Display Options



Press the  button (playback mode) → MENU button (12) → 
Sequence display options

Select the method used to display images in the sequence (.

Option	Description
Individual pictures	Displays each image in a sequence individually.  is displayed on the playback screen.
Key picture only (default setting)	Displays only the key picture for images in a sequence.

Settings are applied to all sequences, and the setting is saved in the camera's memory even if the camera is turned off.

Choose Key Picture



Press the  button (playback mode) → display a sequence for which you want to change the key picture → MENU button (12) →  Choose key picture

Specify a different image in the sequence as the key picture.

- When the key picture selection screen is displayed, select an image (90).

The Movie and Movie Custom Setting Menus

Shooting Mode (Movie Custom Setting Only)

Rotate the mode dial to  CSM → MENU button →  (movie custom setting) tab (📖96) → Shooting mode

Set the standard shooting mode during  CSM (movie custom setting) mode.



Option	Description
A Aperture-priority auto (default setting)	Use this mode to shoot subjects clearly with both the foreground and background in focus or to blur the subject's background intentionally (📖51).
M Manual	Use this mode to control the exposure according to shooting requirements (📖51).
 Special effects	Use this mode to apply the effects to images during shooting. Select one of the following: <ul style="list-style-type: none">• Painting (default setting), Cross process, Soft, Nostalgic sepia, High key, Low key and Selective color See 📖46 for more information on characteristics of each special effect.



Notes About Shooting Mode



The setting may not be changed when using certain settings of other functions.

Custom Picture Control (Movie Custom Setting Only)

Rotate the mode dial to  CSM → MENU button →  (movie custom setting) tab (📖96) → Custom Picture Control

To set Custom Picture Control, see "Custom Picture Control (COOLPIX Custom Picture Control)" (📖44).

Autofocus Mode

Rotate the mode dial to  or  CSM → MENU button →  (movie) or  (movie custom setting) tab (96) → Autofocus mode

Set how the camera focuses when recording movies.



Option	Description
AF-S Single AF (default setting)	Focus is locked when movie recording starts. Select this option when the distance between the camera and the subject will remain fairly consistent.
AF-F Full-time AF	The camera focuses continuously. Select this option when the distance between the camera and subject will change significantly during recording. The sound of the camera focusing may be heard in the recorded movie. Use of Single AF is recommended to prevent the sound of the camera focusing from interfering with recording.



Notes About Autofocus Mode





- When an HS movie option is selected in **Movie options**, the setting is fixed at **Single AF**.
- The setting may not be changed when using certain settings of other functions.

Built-in ND Filter (Movie Custom Setting Only)

Rotate the mode dial to  CSM → MENU button →  (movie custom setting) tab (96) → Built-in ND filter

To set built-in ND filter, see “Built-in ND Filter” (55).

Wind Noise Reduction

Rotate the mode dial to  or  CSM → MENU button →  (movie) or  (movie custom setting) tab (96) → Wind noise reduction



Option	Description
 On	Reduces the sound produced when wind passes over the microphone. Other sounds may become difficult to hear during playback.
OFF Off (default setting)	Wind noise reduction is not enabled.

The Setup Menu

Welcome Screen

Press the MENU button →  tab (13) → Welcome screen

Configure the welcome screen that is displayed when you turn on the camera.

Option	Description
None (default setting)	Does not display the welcome screen.
COOLPIX	Displays a welcome screen with the COOLPIX logo.
Select an image	Displays an image selected for the welcome screen. <ul style="list-style-type: none">• The image selection screen is displayed. Select an image (90) and press the  button.• Because a copy of the selected image is saved in the camera, it will be displayed when the camera is turned on, even if the original image is deleted.• An image cannot be selected if its aspect ratio is different from that of the screen, or if the image size is extremely small after the small picture or crop function is applied.

Time Zone and Date

Press the **MENU** button → **Y** tab (📖13) → Time zone and date

Set the camera clock.

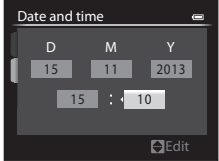
Option	Description
Date and time	<ul style="list-style-type: none">• Select an item: Press the multi selector ◀▶ (changes between D, M, Y, hour, and minute).• Edit the date and time: Press ▲▼. Date and time can also be changed by rotating the multi selector or main command dial.• Apply the setting: Select the minute setting and press the OK button or ▶. 
Date format	Select Year/Month/Day , Month/Day/Year , or Day/Month/Year .
Time zone	Set time zone and daylight saving time. <ul style="list-style-type: none">• When Travel destination (📍) is set after having set the home time zone (🏠), the time difference between the travel destination and the home time zone is automatically calculated, and the date and time are saved for the selected region.

Setting the Time Zone

- 1 Use the multi selector ▲▼ to select **Time zone** and press the **OK** button.

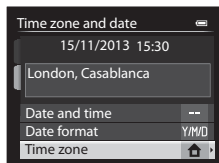

- 2 Select **Home time zone** or **Travel destination** and press the **OK** button.
 - The date and time displayed in the monitor changes depending on whether the home time zone or travel destination is selected.

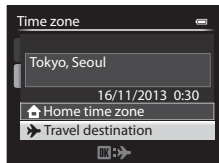

- 3 Press **▶**.

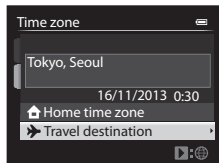





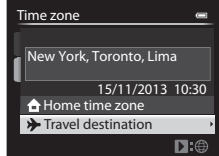
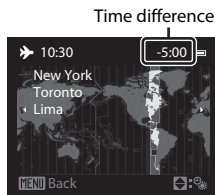

- 4 Use **◀▶** to select the time zone.

- The time difference between home and the travel destination is displayed.
- Press ▲ to enable daylight saving time function, and ☀ is displayed. Press ▼ to disable the daylight saving time function.
- Press the **OK** button to apply the time zone.
- If the correct time is not displayed for the home or travel destination time zone setting, set the appropriate time in **Date and time**.





Monitor Settings

Press the MENU button → Y tab (📖13) → Monitor settings

Option	Description
Image review	<p>On (default setting): The captured image is displayed in the monitor immediately after shooting and the monitor display returns to the shooting screen.</p> <p>Off: The captured image is not displayed immediately after shooting.</p> <p>Tone level information: Tone level information (📖11) is displayed in the monitor immediately after shooting.</p>
Brightness	<p>Set the monitor brightness to one of 6 levels.</p> <ul style="list-style-type: none"> • Default setting: 3 • Hi is suitable when very bright light under the open sky makes the monitor difficult to see. Colors may appear different from the actual image. • Cannot be set when the viewfinder is used.
Photo info	<p>Set the display options displayed in the monitor (📖11) during shooting. The following display options can be set for each of Show info and Hide info.</p> <p> Virtual horizon: Displays the virtual horizon for checking whether the camera is horizontal. When the camera is horizontal or vertical, the mark on the virtual horizon display turns green.</p> <p> Histograms: Displays a graph that shows the brightness distribution in the image (📖16).</p> <p> Framing grid: Displays a boxed guide for framing.</p> <ul style="list-style-type: none"> • Default setting: All hidden (off) • To select show or hide, select an option with the multi selector, and then press the OK button to turn the check box on  or off. • After finishing the setting, select Confirm and press the OK button.
Virtual horizon display	<p>Select Circle (default setting) or Bars when the virtual horizon is set to be displayed in Photo info (📖16).</p>
Playback/menus	<p>Select which of the monitor and viewfinder is used to display the playback screen or menu screen when the  button or MENU button is pressed during shooting.</p> <p>Monitor priority: Switches to the monitor when the viewfinder has been used for shooting.</p> <p>Monitor or viewfinder (default setting): Either the monitor or viewfinder which had been selected before the  button or MENU button was pressed is continuously used.</p>

Notes About Photo Info

- The histogram is not displayed during movie recording. The virtual horizon is displayed only before recording is started.
- The virtual horizon is not displayed in the following scene modes:
Scene auto selector, Portrait, Night portrait, Food, Panorama and Pet portrait
- The virtual horizon and histogram may not be displayed when shooting with some of the settings of **Smile timer** or **AF area mode**. See 80 for more information.
- In shooting modes **U1, U2** and **U3**, set **Photo info** in the specialized menus for **U1, U2** and **U3** (73, 75).

Print Date (Imprinting Date and Time on Images)

Press the **MENU** button → **Y** tab (📖13) → Print date

The shooting date and time can be imprinted on the images when shooting, allowing the information to be printed even from printers that do not support date printing (📷63).



Option	Description
DATE Date	Date is imprinted on images.
DATE Date and time	Date and time are imprinted on images.
OFF Off (default setting)	Date and time are not imprinted on images.

✓ Notes About Print Date

- Imprinted dates form a permanent part of image data and cannot be deleted. The date and time cannot be imprinted on images after they have been captured.
- The date and time cannot be imprinted in the following situations.
 - When the scene mode is set to **Easy panorama** or **Panorama assist**
 - When **Image quality** (📷27) is set to **RAW (NRW)**, **RAW (NRW) + Fine** or **RAW (NRW) + Normal**
 - When **Continuous H: 120 fps** or **Continuous H: 60 fps** is selected for **Continuous** (📷46)
 - When shooting movies
- The imprinted date and time may be difficult to read when using a small image size.

Self-timer: After Release

Press the MENU button → Y tab (📖13) → Self-timer: after release

Set whether or not to cancel the self-timer setting after shooting with self-timer (📖62).

Option	Description
Exit self-timer mode (default setting)	<p>Cancels the self-timer setting after shooting.</p> <ul style="list-style-type: none">• When the self-timer remote control (10s/2s/1s) has been set (📖106), the setting is changed to the quick-response remote after shooting.• When smile timer (📖63) has been set, the setting is not canceled.
Stay in self-timer mode	<p>Shooting is continued without canceling the self-timer setting.</p> <ul style="list-style-type: none">• The setting is canceled when the camera is turned off.

Vibration Reduction

Press the **MENU** button → **Y** tab (📖13) → Vibration reduction

Set to reduce the effects of camera shake while shooting.

Set **Vibration reduction** to **Off** when using a tripod to stabilize the camera during shooting.

Option	Description
 On (default setting)	Vibration reduction is enabled. The camera automatically detects the panning direction and only compensates for vibration caused by camera shake. When the camera is panned horizontally, for example, vibration reduction only reduces vertical shake. If the camera is panned vertically, vibration reduction only compensates for horizontal shake.
OFF Off	Vibration reduction is disabled.

Notes About Vibration Reduction

- After turning on the camera or after switching from playback mode to shooting mode, wait for the shooting mode screen to be displayed completely before taking images.
- Images displayed in the camera monitor immediately after shooting may be displayed blurry.
- Vibration reduction may be unable to completely eliminate the effects of camera shake in some situations.

AF Assist

Press the **MENU** button → **Y** tab (📖13) → AF assist

Enable or disable the AF-assist illuminator which assists autofocus operation.

Option	Description
Auto (default setting)	The AF-assist illuminator automatically lights up when the subject is dimly lit. The illuminator has a range of about 4.0 m (13 ft) at the maximum wide-angle position and about 2.0 m (6 ft 6 in.) at the maximum telephoto position. <ul style="list-style-type: none">Note that for some scene modes or focus areas, the AF-assist illuminator may not light.
Off	The AF-assist illuminator does not light.

✓ Notes About the AF-assist Illuminator

In shooting modes **U1**, **U2** and **U3**, set **AF assist** in the specialized menu for **U1**, **U2** or **U3** (📖73, 75).

ISO Sensitivity Step Value

















Press the **MENU** button → **Y** tab (📖13) → ISO sensitivity step value

Set the step value of the sensitivity to be set for **ISO sensitivity** (🔍33) of the quick menu.

Option	Description
1 step (default setting)	The ISO sensitivity step value is set to 1 step. <ul style="list-style-type: none">80, 100, 200, 400, 800, 1600, 3200, Hi 1 (equivalent to ISO 6400)
1/3 step	The ISO sensitivity step value is set to 1/3 step. <ul style="list-style-type: none">80, 100, 125, 160, 200, 250, 320, 400, 500, 640, 800, 1000, 1250, 1600, 2000, 2500, 3200, Hi 1 (equivalent to ISO 6400)

Digital Zoom

Press the MENU button → Y tab (📖13) → Digital zoom

Option	Description
On (default setting)	Digital zoom is enabled.
Crop	<p>The zoom ratio is limited within a range in which the image quality does not deteriorate (up to the  position of the zoom indicator) (📖33).</p> <ul style="list-style-type: none"> Digital zoom cannot be used in the following situations. <ul style="list-style-type: none"> When Image size is  4000×3000,  3264×2448,  3984×2656,  3968×2232 or  3000×3000 When the Movie options setting is  1080★/30p/ 1080★/25p,  1080/30p/ 1080/25p,  480/120/ 480/100 HS 480/4x,  720/60/ 720/50 HS 720/2x or  1080/15/ 1080/25 HS 1080/0.5x When Continuous is set to Continuous H: 120 fps or Continuous H: 60 fps
Off	Digital zoom is disabled.



✓ Notes About Digital Zoom

- Digital zoom cannot be used in the following situations.
 - When **Scene auto selector**, **Portrait**, **Night portrait**, **Easy panorama** in **Panorama** or **Pet portrait** is selected in scene mode
 - When **Zoom exposure** is selected in special effects mode
- Digital zoom cannot be used when using certain settings of other functions.
- When digital zoom is in effect, **Metering** (📷45) is set to **Center-weighted** or **Spot** depending on the magnification of an enlargement.

Zoom Speed

Press the MENU button → Y tab (13) → Zoom speed

Set the zoom operation speed. Slow down the zoom speed to minimize the recording of the zoom operating noise during movie recording.

Option	Description
 Auto (default setting)	During still image shooting, the zoom operates at the Normal speed. During movie recording, the zoom operates at a lower speed than Normal .
 Normal	During both still image shooting and movie recording, the zoom operates at the normal speed. Rotating the zoom control all the way in either direction adjusts the zoom quickly, while moving the control partially adjusts the zoom slowly.
 Quiet	During both still image shooting and movie recording, the zoom operates at a lower speed than Normal .

Fixed Aperture

Press the MENU button → Y tab (13) → Fixed aperture

Option	Description
On	In A or M shooting mode, zooming can be performed with minimum changes in the aperture value. <ul style="list-style-type: none">When the f-number exceeds the aperture control range at a new zoom position, the aperture value is not fixed.
Off (default setting)	The aperture value is not fixed.



More Information

See “Aperture Value (F-number) and Zoom” (50) for more information.

Sound Settings

Press the **MENU** button → **Y** tab (📖13) → Sound settings

Option	Description
Button sound	<p>When On (default setting) is selected, the camera produces one beep when operations are performed, two beeps when focus is acquired on the subject, and three beeps when an error occurs. The start-up sound is also produced.</p> <ul style="list-style-type: none"> • Sounds are disabled when using Pet portrait scene mode. • The start-up sound is not produced when Welcome screen is set to None.
Shutter sound	<p>When On (default setting) is selected, the shutter sound is produced when the shutter is released.</p> <ul style="list-style-type: none"> • The shutter sound is not produced when using continuous shooting mode, when recording movies, or when using Pet portrait scene mode.

Record Orientation

Press the **MENU** button → **Y** tab (📖13) → Record orientation

Set whether or not to record the “tall” orientation data on the images that are shot with the camera held in “tall” orientation.

Option	Description
Auto (default setting)	<p>The “tall” orientation data is recorded on the images when they are shot.</p> <p>When Rotate tall (📷84) is set to On, the images are displayed in “tall” orientation during playback.</p>
Off	The “tall” orientation data is not recorded.

- The orientation data can be changed after shooting using **Rotate image** in the playback menu (📷66).

✓ Notes About Recording the “Tall” Orientation Data

- In **Continuous** or **Auto bracketing** mode, all images are recorded with the same orientation data as the first image.
- Correct orientation data may not be obtained for images recorded with the camera facing up or down.

Rotate Tall

Press the **MENU** button → **Y** tab (📖13) → Rotate tall

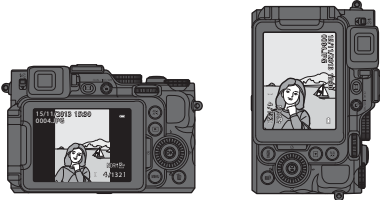
Option	Description
On (default setting)	<p>The images are rotated when the camera is turned in "tall" or landscape orientation during playback. The images on which the "tall" orientation data is recorded are displayed in "tall" orientation.</p> <div data-bbox="370 365 864 623"></div>
Off	The images are not rotated.

Auto Off

Press the **MENU** button → **Y** tab (📖13) → Auto off

Set the amount of time that elapses before the camera enters standby mode (📖27).

You can select **30 s**, **1 min** (default setting), **5 min**, or **30 min**.



Notes About Auto Off

- The time that passes before the camera enters standby mode is fixed in the following situations:
 - When a menu is displayed: 3 minutes (when auto off is set to **30 s** or **1 min**)
 - When the AC Adapter EH-5b is connected: 30 minutes

Format Memory/Format Card

Press the MENU button → Y tab (📖13) → Format memory/Format card

Use this option to format the internal memory or a memory card.

Formatting the internal memory or memory cards permanently deletes all data. Data that has been deleted cannot be recovered. Make sure to transfer important images to a computer before formatting.

- Do not turn the camera off or open the battery-chamber/memory card slot cover during formatting.

Formatting the Internal Memory

Remove the memory card from the camera. The

Format memory option is displayed in the setup menu.

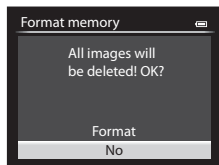

Formatting Memory Cards

Insert a memory card in the camera. The

Format card option is displayed in the setup menu.

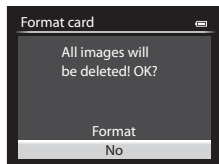

Language

Press the MENU button → Y tab (📖13) → Language

Select a language for display of camera menus and messages.

TV Settings

Press the **MENU** button → **Y** tab (📖13) → TV settings

Adjust settings for connection to a TV.

Option	Description
Video mode	Select from NTSC and PAL . Both NTSC and PAL are standards for analog color television broadcasting. <ul style="list-style-type: none">The available frame rates in Movie options (🎮30) change depending on the setting of the video mode.
HDMI	Select a resolution for HDMI output. When Auto (default setting) is selected, the option best suited to the TV to which the camera is connected is automatically selected from 480p , 720p , or 1080i .
HDMI device control	When On (default setting) is selected, the HDMI-CEC-compatible TV's remote control can be used to control the camera during playback (🎮19).



HDMI and HDMI-CEC

HDMI (High-Definition Multimedia Interface) is a multimedia interface.

HDMI-CEC (HDMI-Consumer Electronics Control) allows compatible devices to inter-operate.

External Mic Sensitivity

Press the **MENU** button → **Y** tab (📖13) → External mic sensitivity

Set the external microphone sensitivity to **Auto** (default setting), **High**, **Medium** or **Low** when recording movies.

When the microphone sensitivity is set to **Auto**, the camera automatically adjusts the microphone sensitivity.

Customize Command Dials

Press the **MENU** button → **Y** tab (📖13) → Customize command dials

Swap the function of the main command dial for that of the sub-command dial when the exposure is set (📖49).

- This option is available only when shooting mode is set to **P**, **S**, **A**, **M**, **U1**, **U2** or **U3** mode or during movie custom setting mode (when **Shooting mode** is set to **Aperture-priority auto** or **Manual**).

Option	Description
No swap (default setting)	In P mode, set the flexible program using the main command dial. In S , A or M mode, set the shutter speed using the main command dial and set the aperture value using the sub-command dial.
Swap main and sub	In P mode, set the flexible program using the sub-command dial. In S , A or M mode, set the shutter speed using the sub-command dial and set the aperture value using the main command dial.

Command Dial Rotation

Press the **MENU** button → **Y** tab (📖13) → Command dial rotation

Change the direction of operation when the command dial is rotated during shooting.

- This option is available only when shooting mode is set to **P**, **S**, **A**, **M**, **U1**, **U2** or **U3** mode or during movie custom setting mode (when **Shooting mode** is set to **Aperture-priority auto** or **Manual**).

Option	Description
Standard rotation (default setting)	For example, in S mode, the shutter speed is set to the low speed side if the main command dial is rotated counterclockwise.
Reverse rotation	For example, in S mode, the shutter speed is set to the high speed side if the main command dial is rotated counterclockwise.

Multi Selector Right Press

Press the MENU button → Y tab (📖13) → Multi selector right press

Set the function to be performed when the multi selector ► is pressed.

Option	Description
AF area mode (default setting)	The AF area mode (📷49) setting is displayed when the multi selector ► is pressed.
Off	The setting is not displayed.

Delete Button Options

Press the MENU button → Y tab (📖13) → Delete button options

Option	Description
Press twice to delete	Press the 🗑️ button once more to delete an image while the deletion confirmation message is displayed (📖37).
Disable second press (default setting)	Even if the 🗑️ button is pressed again while the deletion confirmation message is displayed, the image is not deleted.

AE/AF Lock Button

Press the MENU button → Y tab (📖13) → AE/AF lock button

Set the function to be performed when the AE-L/AF-L button (📖4) is pressed while shooting.

Option	Description
AE/AF lock (default setting)	Locks both the focus and exposure while the AE-L/AF-L button is pressed.
AE lock only	Locks only the exposure while the AE-L/AF-L button is pressed.
AE lock (Hold)	Locks the exposure when the AE-L/AF-L button is pressed. To cancel the lock, press the button again.
AF lock only	Locks only the focus while the AE-L/AF-L button is pressed.

- See “Focusing During Movie Recording” (📖93) for more information on the operation when the AE-L/AF-L button is pressed during movie recording.

✔ Notes About AE/AF Lock Button Setting

- When the scene mode is **Scene auto selector**, AF-L (focus locking) using the AE-L/AF-L button is disabled. When the scene mode is **Fireworks show**, the AE-L/AF-L button cannot be used.
- AE-L (exposure locking) cannot be used when the shooting mode is set to **M**.
- AF-L (focus locking) cannot be used when focus mode (📖64) is set to **MF** (manual focus).

📎 More Information

See “Focus Lock” (📖85) for more information.

Fn1 + Shutter Button

Press the MENU button → Y tab (13) → Fn1 + shutter button

Set the function to be performed when the shutter-release button is pressed while pressing the **Fn1** (function 1) button (4) during shooting.

- This option is available when **P, S, A, M, U1, U2** or **U3** is selected for shooting mode.

Option	Description
Off (default setting)	Shoots without changing the setting.
RAW (NRW)/NORMAL (Image quality) (27)	Changes the image quality setting for images to be shot. When Fine or Normal is set, the setting is changed to RAW (NRW) , and when RAW (NRW) is set, it is changed to Normal . <ul style="list-style-type: none">• The image size is 4000×3000.• Shoots without changing the setting when RAW (NRW) + Fine or RAW (NRW) + Normal is set.
ISO sensitivity (33)	Shoots with ISO sensitivity set to Auto .
White balance (35)	Shoots with White balance set to Auto (normal) . <ul style="list-style-type: none">• Cannot be used when Picture Control is set to Monochrome.
Picture Control (40)	Shoots with COOLPIX Picture Control set to Standard .

Fn1 + Command Dial/Fn1 + Selector Dial

Press the **MENU** button → **Y** tab (📖13) → Fn1 + command dial/Fn1 + selector dial

Set the function to be performed when the command dial or multi selector is rotated while pressing the **Fn1** (function 1) button during shooting.

- Rotating either the main command dial or sub-command dial enables the command dial operation.
- This option is available when the shooting mode is **P, S, A, M, U1, U2, U3** or movie custom setting mode.

Option	Description
Off (default setting)	No function is set. Operation will be disabled.
Metering (📷45)	Change the setting for metering.
Continuous (📷46)	Change the settings for continuous shooting.
Flash exp. comp. (📷54)	Change the setting for Flash exp. comp.
Active D-Lighting (📷56)	Change the setting for Active D-Lighting.
ISO sensitivity (📷33)	Change the setting for ISO sensitivity.
White balance (📷35)	Change the setting for white balance. <ul style="list-style-type: none">• Preset manual measurement and fine adjustment of white balance are not available.
Picture Control (📷40)	Change the setting for COOLPIX Picture Control. <ul style="list-style-type: none">• Quick adjust and manual adjust are not available.
Vibration reduction (📷79)	Change the setting for vibration reduction.

✓ Notes About Fn1 + Command Dial/Fn1 + Selector Dial

Operation is disabled when AE or AF is locked.

Fn1 Guide Display

Press the MENU button → Y tab (📖13) → Fn1 guide display

Option	Description
On (default setting)	When the Fn1 (function 1) button is pressed during shooting, guides for the functions assigned to Fn1 + shutter button (🔍90), Fn1 + command dial and Fn1 + selector dial (🔍91) are displayed in the monitor. <ul style="list-style-type: none">In the shooting modes or settings during which the Fn1 button cannot be used, 📷 will be displayed.
Off	Even if the Fn1 button is pressed, guides are not displayed.

Fn2 Button

Press the MENU button → Y tab (📖13) → Fn2 button

Set the function to be performed when the **Fn2** button (📖5) is pressed.

Option	Description
Off	No function is set. Operation will be disabled.
Show/hide info (default setting)	Switches the information displayed in the monitor during shooting and playback (📖11).
Virtual horizon, View/hide histograms, View/hide framing grid	Shows or hides the virtual horizon, histogram or framing grid (🔍75) in the monitor during shooting.
Built-in ND filter	Change the built-in ND filter (🔍55) setting during shooting.

Customize My Menu

Press the **MENU** button → **Y** tab (📖13) → **Customize My Menu**

Register frequently used menu items in My Menu (up to 5 items). The settings of the menu items registered in My Menu can be checked and changed in the **My** tab of the quick menu (only when the shooting mode is set to **P**, **S**, **A**, **M**, **U1**, **U2** or **U3**).

The following items can be registered.

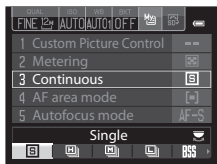

- Custom Picture Control (🔍44)
- Metering (🔍45)
- Continuous (🔍46)
- AF area mode (🔍49)
- Autofocus mode (🔍53)
- Flash exp. comp. (🔍54)
- Noise reduction filter (🔍54)
- Distortion control (🔍55)
- Active D-Lighting (🔍56)
- Vibration reduction (🔍79)
- Digital zoom (🔍81)
- Format memory/Format card (🔍85)
- Built-in ND filter (🔍55)
- Eye-Fi upload (🔍96)
- None (delete)*

* Select to remove an item from My Menu.

Registering into My Menu

- 1 Use the multi selector ▲▼ to select the menu item and press the **OK** button.

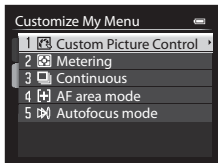

- 2 Select the menu item to be registered and press the **OK** button.

- To finish the setting, press ◀.

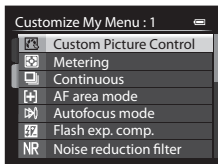

Reset File Numbering

Press the MENU button → Y tab (📖13) → Reset file numbering

When **Yes** is selected, the sequential numbering of file numbers is reset (📷103). After resetting, a new folder is created and the file number for the next image taken starts with "0001."

✔ Notes About Reset File Numbering

Reset file numbering cannot be applied when the folder number reaches 999 and there are images in the folder. Insert a new memory card, or format the internal memory/memory card (📷85).

📎 Folders for Storing Files

Still images, movies and voice memos shot or recorded with this camera are saved in folders of the internal memory/memory card.

- Sequential numbers are added to folder names in ascending order, starting with "100" and ending with "999" (the folder names are not displayed on the camera).
- A new folder is created in the following situations.
 - When the number of files in a folder reaches 200
 - When a file in a folder is numbered "9999"
 - When **Reset file numbering** is performed
- A new folder is created each time a series of images are captured using panorama assist or interval timer shooting, and the images are saved in that folder with file numbers starting with "0001."

Accessory Terminal

Press the **MENU** button → **Y** tab (📖13) → **Accessory terminal**

Set this option when the optional Wireless Remote Controller WR-R10 or GPS unit (🕒105) is attached to the accessory terminal (📖2).



Option	Description
Power supply	When set to On (default setting), the WR-R10 or GPS unit works.
Use GPS to set clock	When the GPS unit is attached, signals from the GPS satellites are used to set the date and time of the camera's internal clock (only when Power supply is set to On). Check the positioning status before setting the clock.

✔ Notes About Use GPS to Set Clock

- Date/time adjustment by **Use GPS to set clock** is set according to the time zone set in **Time zone and date** (📖28, 🕒73) of the setup menu. Check the time zone before setting **Use GPS to set clock**.
- The date/time set using **Use GPS to set clock** is not as accurate as radio clocks. Use **Time zone and date** in the setup menu to set the time if it is not accurate in **Use GPS to set clock**.

Eye-Fi Upload

Press the MENU button → Y tab (📖13) → Eye-Fi upload





Option	Description
 Enable (default setting)	Upload images created by the camera to a preselected destination.
 Disable	Images are not uploaded.

✓ Notes About Eye-Fi Cards

- Note that images will not be uploaded if signal strength is insufficient even if **Enable** is selected.
- Remove your Eye-Fi card from the camera where wireless devices are prohibited. Signals may be transmitted even if **Disable** is selected.
- Refer to the instruction manual of your Eye-Fi card for more information. In the event of malfunction, contact the card manufacturer.
- The camera can be used to turn Eye-Fi cards on and off, but may not support other Eye-Fi functions.
- The camera is not compatible with the Endless Memory function. When it is set on a computer, disable the function. If the Endless Memory function is enabled, the number of images taken may not be displayed correctly.
- Eye-Fi cards are for use only in the country of purchase. Observe all local laws concerning wireless devices.
- Leaving the setting as **Enable** will result in the battery being depleted in a shorter period of time.

Eye-Fi Communication Indicator

The communication status of the Eye-Fi card in the camera can be confirmed in the monitor (📖14).

- : **Eye-Fi upload** is set to **Disable**.
-  (lights): Eye-Fi upload enabled; waiting to begin upload.
-  (flashes): Eye-Fi upload enabled; uploading data.
- : An error occurred. The camera cannot control the Eye-Fi card.

MF Distance Indicator Units

Press the **MENU** button → **Y** tab (📖13) → MF distance indicator units

Set either **m** (meter) (default setting) or **ft** (feet) for the unit of gauge displayed when the focus mode is set to manual focus (📖66).

Reverse Indicators

Press the **MENU** button → **Y** tab (📖13) → Reverse indicators

Change the +/- display direction of the exposure indicator (📖51) displayed when shooting mode is **M** and the indicator displayed for setting bracketing (📖38).

- Default setting: The – side of the indicators is set to the left and + side is set to the right.

Flash Control

Press the **MENU** button → **Y** tab (📖13) → Flash control

Set whether or not to switch the flash to be used.

Option	Description
AUTO Auto (default setting)	When the Speedlight (external flash unit) (📖108) is attached, the Speedlight fires. When the Speedlight is not used, the built-in flash fires.
📷 Optional flash	The built-in flash is always disabled. Only the Speedlight is used.

Reset All

Press the **MENU** button → **Y** tab (📖13) → **Reset all**

When **Reset** is selected, the camera's settings are restored to their default values.

- Some settings, such as **Time zone and date** or **Language**, are not reset.
- User settings that were saved in **U1**, **U2** and **U3** of the mode dial are not reset. To reset these settings, use **Reset user settings** (📖75).



Resetting File Numbering

To reset file numbering to "0001", delete all images saved in the internal memory or on the memory card before selecting **Reset all**. **Reset file numbering** can also be used to reset to "0001" (📖94).





Firmware Version







Press the **MENU** button → **Y** tab (📖13) → **Firmware version**







View the current camera firmware version.









Error Messages

Refer to the table below if an error message is displayed.

Display	Cause/Solution	
Battery temperature high	The camera turns off automatically. Wait until the battery has cooled before resuming use.	-
The camera will turn off to prevent overheating.	The inside of the camera has become hot. The camera turns off automatically. Wait until the camera has cooled before resuming use.	-
Memory card is write protected.	The write-protect switch is in the "lock" position. Slide the write-protect switch to the "write" position.	-
This card cannot be used.	An error occurred while accessing the memory card.	25 24 24
This card cannot be read.	<ul style="list-style-type: none"> • Use an approved card. • Check that the terminals are clean. • Confirm that the memory card is correctly inserted. 	
Card is not formatted. Format card?	The memory card has not been formatted for use in the camera. Formatting deletes all data saved on the memory card. If you need to keep copies of any images, make sure to select No and save the copies to a computer or other medium before formatting the memory card. Select Yes and press the  button to format the memory card.	24,  5
Not available if Eye-Fi card is locked.	The write-protect switch of the Eye-Fi card is in the "lock" position.	-
	An error occurred while accessing the Eye-Fi card. <ul style="list-style-type: none"> • Check that the terminals are clean. • Confirm that the Eye-Fi card is correctly inserted. 	24 24
Out of memory.	Delete images or insert a new memory card.	37, 98,  65, 24

Display	Cause/Solution	
Image cannot be saved.	An error occurred while saving the image. Insert a new memory card or format the internal memory or memory card.	24,  85
	The camera has run out of file numbers. Insert a new memory card or format the internal memory or memory card.	
	The image cannot be used for the welcome screen.	 72
	There is insufficient space to save the copy. Delete images from the destination.	37
Sound file cannot be saved.	A voice memo cannot be attached to this image. <ul style="list-style-type: none"> Voice memos cannot be attached to movies. Select an image captured with this camera. 	–  67
Image cannot be modified.	<ul style="list-style-type: none"> Select images that support the editing function. Images captured with cameras other than this camera cannot be edited. 	 9 –
Cannot record movie.	A time-out error occurred while saving the movie on the memory card. Select a memory card with a faster write speed.	25
Cannot reset file numbering.	File numbering cannot be reset because the sequential number of a folder has reached the upper limit. Insert a new memory card or format the internal memory or memory card.	24,  85
Memory contains no images.	There are no images in the internal memory or on the memory card. <ul style="list-style-type: none"> Remove the memory card from the camera to play back images in the camera's internal memory. To copy the images saved in the camera's internal memory to the memory card, press the MENU button to select Copy in the playback menu. 	24  68
File contains no image data.	The file was not created or edited with this camera.	
This file cannot be played back.	The file cannot be viewed on this camera. View the file using a computer or the device used to create or edit this file.	–

Display	Cause/Solution	
All images are hidden.	<ul style="list-style-type: none"> There are no images available for a slide show, etc. There are no images that can be displayed on the image selection screen for deletion. 	-
This image cannot be deleted.	The image is protected. Disable protection.	 66
My Menu can not be changed at current settings.	<p>All registered menu items cannot be changed at the current setting.</p> <ul style="list-style-type: none"> Some functions cannot be used in combination with other menu settings. There is no item that can be set using the current shooting mode. Change the menu item to be registered in My Menu. 	77 -  93
Raise the flash.	<ul style="list-style-type: none"> When the scene mode is Scene auto selector, you can take an image even if the flash is lowered but the flash will not fire. When the scene mode is Night portrait or Backlighting with HDR set to Off, you must raise the flash to take an image. 	40 40, 43
Speedlight setting error	Refer to the documentation provided with your Speedlight or wireless Speedlight commander to check the settings.	 59,  108
Lens error	A lens error occurred. Turn the camera off and then on again. If the error persists, contact your retailer or Nikon-authorized service representative.	26
Communications error	An error occurred while communicating with the printer. Turn the camera off and reconnect the USB cable.	 20
System error	An error occurred in the camera's internal circuitry. Turn the camera off, remove and reinsert the battery, and turn the camera on. If the error persists, contact your retailer or Nikon-authorized service representative.	26
Failed to acquire GPS data.	The camera clock is not set correctly. Change the location or time and determine the location again.	-

Display	Cause/Solution	
Printer error: check printer status.	After solving the problem, select Resume and press the  button to resume printing.*	–
Printer error: check paper	Load the specified size of paper, select Resume , and press the  button to resume printing.*	–
Printer error: paper jam	Remove the jammed paper, select Resume , and press the  button to resume printing.*	–
Printer error: out of paper	Load the specified size of paper, select Resume , and press the  button to resume printing.*	–
Printer error: check ink	There is a problem with the printer's ink. Check the ink, select Resume , and press the  button to resume printing.*	–
Printer error: out of ink	Replace the ink cartridge, select Resume , and press the  button to resume printing.*	–
Printer error: file corrupt	There is a problem with the image file to be printed. Select Cancel and press the  button to cancel printing.	–

* See the documentation provided with your printer for further guidance and information.

File Names

Images, movies, or voice memos are assigned file names as follows.

File name: **DSCN0001.JPG**



(1) (2) (3)

(1) Identifier	Not shown on camera monitor.	
	DSCN	Original still images, movies, still images extracted from movies
	SSCN	Small picture copies
	RSCN	Cropped copies
	FSCN	Images created by an image editing function other than crop and small picture, movies created by the movie editing function
(2) File number	Assigned automatically in ascending order, starting with "0001" and ending up with "9999." <ul style="list-style-type: none">• When a file number reaches "9999," a new folder is created and the next file number returns to "0001."• A new folder is created each time a series of images are captured using panorama assist or interval timer shooting, and the images are saved in that folder with file numbers starting with "0001."	
(3) Extension	Indicates file format.	
	.JPG	JPEG still images
	.NRW	RAW still images
	.MOV	Movies
	.WAV	Voice memos <ul style="list-style-type: none">• Identifier and file number are the same as the image to which the voice memo is attached.

Notes

When images are shot with an **Image quality** (🔍27) setting of **RAW (NRW) + Fine** or **RAW (NRW) + Normal**, the RAW (NRW) and JPEG images that are recorded at the same time are assigned the same identifier and file number. The pair of images is saved in the same folder and is counted as one file.

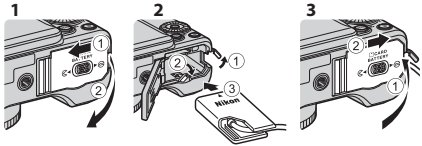
Optional Accessories

<p>AC adapter/power connector</p>	<p>AC Adapter EH-5b and power connector:</p> <ul style="list-style-type: none"> When the power connector is inserted into the camera and the AC adapter is connected, the camera can be powered from an electrical outlet. The AC adapter and the power connector are available separately. <p style="text-align: center;"><How to attach the EP-5A></p>  <p>Before closing the battery-chamber/memory card slot cover, fully insert the cord of the power connector into the slot in the battery chamber. If part of the cord runs out of the grooves, the cover or cord may be damaged when the cover is closed.</p> <p>Insert the DC plug of the AC Adapter EH-5b into the DC plug connector of the Power Connector EP-5A.</p>
<p>Audio video cable</p>	<p>Audio Video Cable EG-CP16</p>
<p>Speedlight (external flash unit), wireless Speedlight commander</p>	<p>See "Speedlights (External Flash Unit)" (📖 108).</p>
<p>Filter</p>	<p>40.5mm screw-on filter 40.5 NC</p>
<p>Lens hood</p>	<p>Lens Hood HN-CP17:</p> <ul style="list-style-type: none"> Cuts out light which adversely affects the image and protects the lens surface. A 58mm screw-on filter can be attached to the lens hood. 
<p>External microphone</p>	<p>Stereo Microphone ME-1</p>

Wireless mobile adapter	<p>Wireless Mobile Adapter WU-1a: When you attach the WU-1a to the USB/audio/video output connector of the camera, the camera can connect via Wi-Fi (wireless LAN) connection to smart devices that have the dedicated software installed. You can use your smart device to release the camera's shutter by remote operation or copy images stored on the memory card inserted in the camera to the smart device.</p> <ul style="list-style-type: none"> • Operations other than turning on and off the camera using the camera's controls cannot be performed during remote control operation. • This function cannot be used when the Eye-Fi card is inserted into the camera. <p>See our websites, product catalogs, or the documentation provided with the WU-1a for further details.</p>
Remote control*	<p>Remote Control ML-L3 (📷106)</p>
	<p>Remote Cord MC-DC2: When attached to the accessory terminal, you can release the shutter using the MC-DC2 instead of pressing the shutter-release button on the camera.</p> <hr/> <p>Wireless Remote Controller WR-R10, WR-T10: When the WR-R10 (receiver) is attached to the accessory terminal, you can release the shutter wirelessly from the WR-T10 (transmitter).</p> <ul style="list-style-type: none"> • When using a tripod, attach the camera to the tripod before attaching the WR-R10. • When using the WR-R10, first attach it, select Accessory terminal in the setup menu, and then set Power supply (📷95) to On.
GPS accessory	<p>GPS Unit GP-1 (📷113)</p>
Hand strap	<p>Hand Strap AH-CP1</p>

* Setting a longer **Auto off** time (📷84) is recommended when using the remote control function.

Availability may vary with country or region.
See our website or brochures for the latest information.

✔ Using a Commercially Available Step-up Ring

When a commercially available step-up ring is used, remove the lens ring (📖1) from the camera.

Shooting with Remote Control ML-L3

Use the Remote Control ML-L3 (available separately) (📷105) to release the shutter. Set **Vibration reduction** (📷79) in the setup menu to **Off** when using a tripod to stabilize the camera.

1 Press the multi selector ◀ (📷).

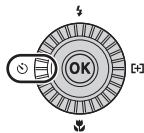

2 Select remote control mode and use ▶ to display the setting.

- Select the remote control setting and press the OK button.
- 📷: Press the transmission button on the remote control to shoot instantly (quick-response remote).
- 📷 10s (10 seconds), 📷 2s (2 seconds) and 📷 1s (1 second): Press the transmission button on the remote control to shoot with the selected seconds delay (self-timer remote control).
- If the OK button is not pressed within a few seconds, the selection will be canceled.

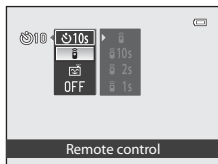

3 Frame the picture.

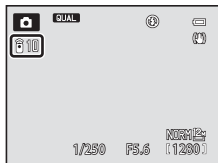

4 Aim the transmitter at the infrared receiver on the front of the camera (📖1) and press the transmission button.

- Press the transmission button from a distance of 5 m (16 ft) or less.
- In the quick-response remote mode, once the subject is in focus, the shutter is released.
- When the time for self-timer is set to **🕒 10s** (10 seconds) or **🕒 2s** (2 seconds), the self-timer lamp flashes when the subject is in focus, and then about 1 second before the shutter is released, the lamp stops flashing and remains lit. To stop the self-timer before an image is taken, press the transmission button again.
- In the self-timer remote control mode, the remote control mode is set to **🕒** (quick-response remote) when the shutter is released.



Replacing the Battery for Remote Control ML-L3 (3V CR2025 Lithium Battery)

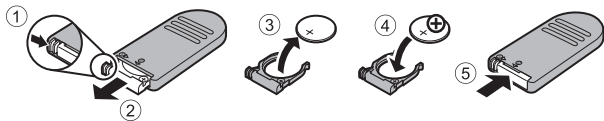

- When changing the remote control battery, make sure that the battery's positive (+) and negative (-) terminals are oriented correctly.
- Make sure to read and follow the warnings of "For Your Safety" (📖vii).

✓ Notes About the Remote Control

- The remote control may not function even from a distance of 5 m (16 ft) or less when shooting in backlit conditions.
- The setting may not be changed when using certain settings of other functions.

📎 More Information

See "Self-timer: After Release" (📖78) for more information.

Speedlights (External Flash Unit)

With this camera, various functions are available in combination with the Speedlight (external flash unit) supported by the Nikon Creative Lighting System (CLS) (👁️109). Use the Speedlight when the built-in flash cannot provide sufficient lighting.

The following Speedlights and wireless Speedlight commander can be used for the camera.

Speedlights	SB-910, SB-900, SB-800, SB-700, SB-600, SB-400, SB-R200*
Wireless Speedlight commander	SU-800

* Speedlight used for remote flash. Attachment Ring SX-1 cannot be mounted on this camera. To use the SB-R200, it must be attached to the Speedlight Stand AS-20.

How to Attach the Speedlight/Wireless Speedlight Commander

- Do not raise the built-in flash.
- Remove the accessory shoe cover from the camera.
- Refer to the documentation provided with your Speedlight/wireless Speedlight commander for more information on how to attach and detach the Speedlight with a locking pin and other details.
- Attach the accessory shoe cover when the accessory shoe is not in use.
- Attempting to attach an accessory that does not support this camera may damage the camera and the accessory.

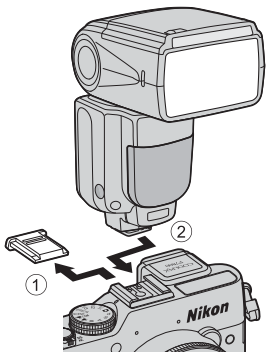

✔ Use Only Nikon Flash Accessories

Use only Nikon Speedlights. Flash units of other manufacturers (with voltages over 250 V applied to the camera's X sync contact, or causing short circuit at the accessory shoe contact) could not only prevent normal operation, but damage the sync circuitry of the camera or flash.

Functions That Can Be Used in Combination with the Speedlight

- SB-910, SB-900, SB-800, SB-700 or SB-600

			CLS compatible Speedlight				
			SB-910 SB-900	SB-800	SB-700	SB-600	
Single flash unit	i-TTL	i-TTL-BL flash ¹	✓	✓	✓	✓	
		Standard i-TTL flash	✓ ³	✓ ³	✓	✓ ³	
	AA	Auto aperture flash	✓ ⁴	✓ ⁴	-	-	
	A	Non-TTL auto flash	✓ ⁴	✓ ⁴	-	-	
	GN	Distance priority manual flash	✓	✓	✓	-	
	M	Manual flash	✓	✓	✓	✓	
	RPT	Repeating flash	✓	✓	-	-	
Advanced Wireless Lighting (AWL)	Master flash unit	Instruction to flash unit ²		✓	✓	✓	-
		i-TTL	i-TTL flash	✓	✓	✓	-
		AA	Auto aperture flash	✓	✓	-	-
		M	Manual flash	✓	✓	✓	-
		RPT	Repeating flash	✓	✓	-	-
	Remote flash unit	i-TTL	i-TTL flash	✓	✓	✓	✓
		AA	Auto aperture flash	✓	✓	-	-
		M	Manual flash	✓	✓	✓	✓
		RPT	Repeating flash	✓	✓	✓	✓
	Transmission of flash color temperature information			✓	✓	✓	✓
Flash mode setting from camera			-	-	-	-	

¹ Not available when metering mode is set to Spot.

² The remote flash unit can control Group A only.

³ Can also be set on the Speedlight.

⁴ The selection of AA mode and A mode is performed using the custom setting for the Speedlight.

- SU-800, SB-400 or SB-R200

			CLS compatible Speedlight			
			SU-800	SB-400	SB-R200	
Single flash unit	i-TTL	i-TTL-BL flash ¹	-	✓	-	
		Standard i-TTL flash	-	✓	-	
	AA	Auto aperture flash	-	-	-	
	A	Non-TTL auto flash	-	-	-	
	GN	Distance priority manual flash	-	-	-	
	M	Manual flash	-	✓ ³	-	
	RPT	Repeating flash	-	-	-	
Advanced Wireless Lighting (AWL)	Master flash unit	Instruction to flash unit ²		✓	-	-
		i-TTL	i-TTL flash	-	-	-
		AA	Auto aperture flash	-	-	-
		M	Manual flash	-	-	-
		RPT	Repeating flash	-	-	-
	Remote flash unit	i-TTL	i-TTL flash	-	-	✓
		AA	Auto aperture flash	-	-	-
		M	Manual flash	-	-	✓
		RPT	Repeating flash	-	-	-
	Transmission of flash color temperature information			-	✓	-
Flash mode setting from camera			-	✓	-	

¹ Not available when metering mode is set to Spot.



² The remote flash unit can control Group A only.

³ This setting can be made using the flash mode (📖59) of this camera. When **M** (manual) is set, fill flash fires at the flash output that was set. If other flash mode is set, i-TTL Flash is enabled.

Notes About i-TTL Flash

- The monitor preflashes are fired to measure the reflecting light from a subject in order to adjust the flash output of the Speedlight.
 - i-TTL-BL flash: The flash output is adjusted with consideration for the balance between a subject and its background light.
 - Standard i-TTL flash: The flash output is adjusted to achieve proper exposure according to the brightness of the main subject without consideration of the background light. This setting is optimal for taking images with emphasis on the main subjects.
- When shooting using i-TTL flash, set the flash control mode of the Speedlight to i-TTL before taking images (except SB-400).
- When shooting using SB-700 or SB-400 and if **Metering** of the camera is set to **Matrix** or **Center-weighted**, i-TTL-BL flash is set. If **Metering** of the camera is set to **Spot**, Standard i-TTL flash is set.

Notes About Speedlights

- This camera does not support Auto FP High-Speed Sync, FV lock, red-eye reduction or AF-assist for multi-area AF when using Speedlights.
- The power zoom function can be used with Speedlights SB-910, SB-900, SB-800, SB-700 or SB-600 and the zoom head position is automatically set depending on the focal length of the lens.
- When using Speedlights SB-910, SB-900, SB-800, SB-700 or SB-600, the edges of images shot at ranges less than 2 m (6 ft 7 in.) on the wide-angle zoom position may appear dark. In such cases, use the wide panel.
- When set to STBY (standby), the Speedlight turns on and off at the same time as the camera. Confirm on the Speedlight that the Ready-light is on.
- Advanced Wireless Lighting shooting can be performed by setting SB-910, SB-900, SB-800 or SB-700 attached to this camera to master flash, or by setting SU-800 to the Commander mode, and setting SB-910, SB-900, SB-800, SB-700, SB-600 or SB-R200 to remote flash (when shooting with this camera, the remote flash setting is only applicable to Group A).
- Advanced Wireless Lighting shooting can be performed also by using this camera's built-in flash in Commander mode (only applicable to Group A and fixed at 3 CH) ( 60, 75,  59).
- Refer to the documentation provided with your Speedlight for more information.



Notes About Using the Remote Flash Unit

- Set up the remote flash unit in a position close to the subject from the camera to ensure the light from the Speedlight to enter the sensor window.
- Aside from monitor preflashes, the master flash unit emits a minute amount of flashes to control the remote flash unit. When shooting a subject at a short distance from the master flash unit, these minute amounts of flashes may cause adverse effects and the proper exposure may not be achieved. To reduce such adverse effects, use the wide panel for the master flash when the master flash unit is directly facing a subject that is being shot at a short distance.

Using the GPS Unit

When the GPS unit (available separately) is attached to the accessory terminal, signals from GPS satellites are received to determine the current position and the position information (latitude and longitude) can be recorded on the images to be shot.

Position information recorded on images can be checked on a map with ViewNX 2 after transferring the images to a computer (📖104).

How to Attach the GPS Unit

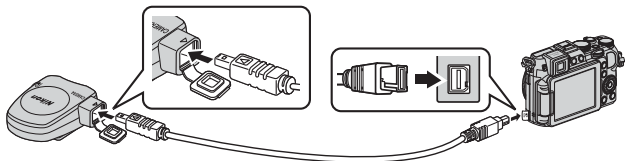

- Turn the camera off before attaching the GPS unit.
- Make sure that the plug is inserted in the correct direction. Inserting the plug in the wrong direction could damage the plug or connector.
- To use the built-in flash, do not attach the GPS unit to the accessory shoe.

Recording GPS Data on Images

- Set **Power supply of Accessory terminal** in the setup menu to **On** (default setting) (🔧95).
- Signals are received from GPS satellites and positioning starts.
- When you take an image at a place where positioning is successfully performed, the position information is recorded on the image.
- Operate in an open-air area when starting to receive signals from GPS satellites.
- Be aware of your surroundings when positioning.

GPS Reception Indicator

GPS reception can be checked on the shooting screen (📖14).

- 📶: Signals are being received from four or more satellites and determine position. Position information is recorded on the image.
- 📶: Signals are being received from three satellites and determine position. Position information is recorded on the image.
- 📶: Signals are no longer received from the satellites. If the camera has position information that has been obtained in the last 1 minute, this position information is recorded on the image.
- 📶: Signals cannot be received from the satellites, and positioning is not possible. The position information is not recorded on the image.

Information Recorded on Images

- The shooting date and time that is displayed when playing back images is determined by the camera's internal clock at the time of shooting. The time obtained by the position information and recorded on images will not be displayed on the camera.
- Position information for the first frame will be recorded on a series of pictures shot using continuous shooting.
- Position information cannot be displayed on the camera.
- The actual place of shooting may differ from the GPS information recorded on the image files due to the accuracy of the position information obtained and a difference in the geodetic system used.

Notes About Images with Recorded Position Information

An individual may be identified from images that have been recorded with position information. Observe caution when you transfer images recorded with position information to a third party or upload them to a network such as the Internet where the public can view them.



Technical Notes and Index

Caring for the Products	2
The Camera.....	2
The Battery.....	3
The Battery Charger.....	4
Memory Cards.....	5
Caring for the Camera	6
Cleaning.....	6
Storage	7
Troubleshooting	8
Specifications.....	16
Index	22

Caring for the Products

The Camera

To ensure continued enjoyment of this Nikon product, observe the precautions described below in addition to the warnings in "For Your Safety" (📖vii-ix) when using or storing the device.

✔ Do Not Drop

The product may malfunction if subjected to strong shock or vibration.

✔ Handle the Lens and All Moving Parts with Care

Do not apply force to the lens, lens cover, monitor, memory card slot, or battery chamber. These parts are easily damaged. Applying force to the lens cover could result in camera malfunction or damage to the lens. Should the monitor break, care should be taken to avoid injury caused by broken glass and to prevent the liquid crystal from the display touching the skin or entering the eyes or mouth.

✔ Keep Dry

The device will be damaged if immersed in water or subjected to high humidity.

✔ Avoid Sudden Changes in Temperature

Sudden changes in temperature, such as when entering or leaving a heated building on a cold day, can cause condensation to form inside the device. To prevent condensation, place the device in a carrying case or a plastic bag before exposing it to sudden changes in temperature.

✔ Keep away from Strong Magnetic Fields

Do not use or store this device in the vicinity of equipment that generates strong electromagnetic radiation or magnetic fields. Strong static charge or the magnetic fields produced by equipment such as radio transmitters could interfere with the monitor, damage data saved on the memory card, or affect the product's internal circuitry.

✔ Do Not Point the Lens at Strong Light Sources for Extended Periods

Avoid pointing the lens at the sun or other strong light sources for extended periods when using or storing the camera. Intense light may cause deterioration of the image sensor, producing a white blur effect in photographs.

Turn the Product off Before Removing or Disconnecting the Power Source or the Memory Card

Do not remove the battery while the product is on, or while images are being saved or deleted. Forcibly cutting power in these circumstances could result in loss of data or in damage to product memory or internal circuitry.

Notes About the Monitor

- Monitors and electronic viewfinders are constructed with extremely high precision; at least 99.99% of pixels are effective, with no more than 0.01% being missing or defective. Hence while these displays may contain pixels that are always lit (white, red, blue, or green) or always off (black), this is not a malfunction and has no effect on images recorded with the device.
- Images in the monitor may be difficult to see under bright lighting.
- The monitor is lit by an LED backlight. Should the monitor begin to dim or flicker, contact your Nikon-authorized service representative.

The Battery

- Be sure to read and follow the warnings in “For Your Safety” (📖vii-ix) before use.
- Check the battery level before using the camera and replace or charge the battery if necessary. Do not continue charging once the battery is fully charged as this will result in reduced battery performance. Whenever possible, carry a fully charged spare battery when taking images on important occasions.
- Do not use the battery at ambient temperatures below 0°C (32°F) or above 40°C (104°F).
- Charge the battery indoors with an ambient temperature of 5°C to 35°C (41°F to 95°F) before use.
- When the battery temperature is between 0°C and 10°C (32°F to 50°F) or 45°C to 60°C (113°F to 140°F), the chargeable capacity may decrease.
- The battery is not charged at ambient temperatures below 0°C (32°F) or above 60°C (140°F).
- Note that the battery may become hot during use; wait for the battery to cool before charging. Failure to observe these precautions could damage the battery, impair its performance, or prevent it from charging normally.
- On cold days, the capacity of batteries tends to decrease. If an exhausted battery is used at a low temperature, the camera will not turn on. Be sure that the battery is fully charged before heading outside to take images in cold weather. Keep spare batteries in a warm place and exchange as necessary. Once warmed, a cold battery may recover some of its charge.
- Dirt on the battery terminals can prevent the camera from functioning. Should the battery terminals become dirty, wipe them off with a clean, dry cloth before use.

- If the battery will not be used for some time, insert it in the camera and completely exhaust it before removing it for storage. The battery should be stored in a cool location with an ambient temperature of 15°C to 25°C (59°F to 77°F). Do not store the battery in hot or extremely cold locations.
- Always remove the battery from the camera or battery charger when it is not being used. When inserted, minute amounts of current are drawn from the battery even when not in use. This may result in excessive draining of the battery and complete loss of function. Turning the camera on or off while the battery is exhausted can result in reduced battery life.
- Recharge the battery at least once every six months and completely exhaust it before returning it to storage.
- After removing the battery from the camera or battery charger, attach the included terminal cover to the battery and store it in a cool place.
- A marked drop in the time a fully-charged battery retains its charge, when used at room temperature, indicates that the battery needs to be replaced. Purchase a new EN-EL14 battery.
- Replace the battery when it no longer holds a charge. Used batteries are a valuable resource. Please recycle used batteries in accordance with local regulations.

The Battery Charger

- Be sure to read and follow the warnings of "For Your Safety" (📖vii-ix) thoroughly before using the battery charger.
- The included battery charger is for use only with a Rechargeable Li-ion Battery EN-EL14.
- The MH-24 is compatible with AC 100-240 V, 50/60 Hz electrical outlets. When using in other countries, use a commercially available plug adapter as necessary. For more information about plug adapters, consult your travel agency.

Memory Cards

- Use only Secure Digital memory cards. See “Approved Memory Cards” (125).
- Observe the precautions noted in the documentation included with your memory card.
- Do not affix labels or stickers to the memory card.
- Do not format the memory card using a computer.
- The first time you insert a memory card that has been used in another device into this camera, be sure to format it with this camera. We recommend formatting new memory cards with this camera before using them with this camera.
- Note that **formatting a memory card permanently deletes all images and other data on the memory card.** If there is data saved on the memory card that you wish to keep, copy that data to a computer before formatting.
- If the message **Card is not formatted. Format card?** is displayed when the camera is turned on, the memory card must be formatted. If there is data on the memory card that you do not want to delete, select **No** and press the  button. Copy that data to a computer before formatting. To format the memory card, select **Yes**.
- Observe the following precautions while formatting the memory card, saving and deleting images, and copying images to a computer, otherwise data or the memory card itself may be damaged.
 - Do not open the battery-chamber/memory card slot cover or remove the memory card or battery.
 - Do not turn off the camera.
 - Do not disconnect the AC adapter.

Caring for the Camera

Cleaning

Lens/ viewfinder	Avoid touching glass parts with your fingers. Remove dust or lint with a blower (typically a small device with a rubber bulb attached to one end that is pumped to produce a stream of air out the other end). To remove fingerprints or other stains that cannot be removed with a blower, wipe the lens with a soft cloth, using a spiral motion that starts at the center of them and working toward the edges. If this fails, clean the lens using a cloth lightly dampened with commercial lens cleaner.
Monitor	Remove dust or lint with a blower. To remove fingerprints and other stains, clean the monitor with a soft, dry cloth, being careful not to apply pressure.
Body	Use a blower to remove dust, dirt, or sand, then wipe gently with a soft, dry cloth. After using the camera at the beach or other sandy or dusty environment, wipe off any sand, dust, or salt with a dry cloth lightly dampened with fresh water and dry thoroughly. Note that foreign matter inside the camera could cause damage not covered by the warranty.

Do not use volatile organic solvents such as alcohol or thinner, chemical detergents, anticorrosive agents, or anti-fogging agents.

Storage

Turn the camera off when not in use. Be sure that the power-on lamp is off before putting the camera away. Remove the battery if the camera will not be used for an extended period. Do not store the camera with naphtha or camphor moth balls, or in any of the following locations:

- Next to equipment that produces strong electromagnetic fields, such as televisions or radios
- Exposed to temperatures below -10°C (14°F) or above 50°C (122°F)
- Places that are poorly ventilated or subject to humidity of over 60%







To prevent mold or mildew, take the camera out of storage at least once a month. Turn the camera on and release the shutter a few times before putting the camera away again.









For storing the battery, follow the precautions in "The Battery" (🔋:3) in "Caring for the Products" (🔧:2).



Troubleshooting

If the camera fails to function as expected, check the list of common problems below before consulting your retailer or Nikon-authorized service representative.





Power, Display, Settings Issues







Problem	Cause/Solution	
The camera is on but does not respond.	<ul style="list-style-type: none"> • Wait for recording to end. • If the problem persists, turn the camera off. If the camera does not turn off, remove and reinsert the battery or batteries or, if you are using an AC adapter, disconnect and reconnect the AC adapter. Note that although any data currently being recorded will be lost, data that have already been recorded will not be affected by removing or disconnecting the power source. 	- 26,  104
Camera cannot be turned on.	<ul style="list-style-type: none"> • The battery is exhausted. • The camera cannot be turned on if the battery-chamber/memory card slot cover is open. 	26 22
Camera turns off without warning.	<ul style="list-style-type: none"> • The camera automatically turns off to save power (auto off function). • The camera or battery have become too cold and cannot operate properly. • The inside of the camera has become hot. Leave the camera off until the inside of the camera has cooled, and then try turning it on again. 	27  3 -
The monitor or viewfinder is blank.	<ul style="list-style-type: none"> • The camera is off. • The battery is exhausted. • The camera has entered standby mode to save power. Press the power switch, shutter-release button or  button, or rotate the mode dial. • You cannot turn on both the monitor and viewfinder at the same time. It may take a while to switch between the monitor and viewfinder. • The camera and computer are connected via a USB cable. • The camera and TV are connected via an audio video cable or HDMI cable. • Interval timer shooting in progress. 	26 26 27 - 102, 106 102,  18  47























Problem	Cause/Solution	
Monitor is hard to see.	<ul style="list-style-type: none"> The ambient light is too bright. Move to a darker place or use the viewfinder. Adjust the monitor brightness. The monitor is dirty. Clean the monitor. 	10 99,  75  6
Image in the viewfinder is difficult to see.	Adjust the viewfinder using the diopter adjustment control.	10
Date and time of recording are not correct.	<ul style="list-style-type: none"> If the camera clock has not been set, the “Date not set” indicator flashes during shooting and movie recording. Images and movies saved before the clock is set are dated “00/00/0000 00:00” or “01/01/2013 00:00” respectively. Set the correct time and date from the Time zone and date option in the setup menu. The camera clock is not as accurate as ordinary watches or clocks. Periodically compare the time of the camera clock with that of a more accurate timepiece and reset as required. 	28, 99,  73 99,  73
No information displayed in monitor.	Shooting and photo information may be hidden. After confirming that the Fn2 button setting is set to Show/hide info , press the Fn2 button until information is displayed.	11, 101,  92
Print date not available.	Time zone and date has not been set in the setup menu.	28, 99,  73
Date not imprinted on images even when Print date is enabled.	<ul style="list-style-type: none"> The current shooting mode does not support Print date. A function that restricts the print date is enabled. The date cannot be imprinted on movies. 	99,  77 77 –
Screen for setting time zone and date is displayed when camera is turned on.	The clock battery is exhausted; all settings were restored to their default values.	28, 29
Camera settings reset.		













Problem	Cause/Solution	
Reset file numbering cannot be done.	Although a new folder is created in the internal memory or on the memory card by resetting file numbering, etc., if the sequential number of a folder name (which is not displayed on the camera) reaches the upper limit ("999"), reset is not possible. Change the memory card, or format the internal memory/memory card.	101,  94
Camera becomes hot.	The camera may become hot when used for an extended period of time to shoot movies or send images using an Eye-Fi card, or when used in a hot environment; this is not a malfunction.	-
Camera makes sound.	When Autofocus mode is set to Full-time AF or while in some shooting modes, the camera may produce an audible focusing sound.	74, 96

Shooting Issues

Problem	Cause/Solution	
Cannot switch to shooting mode.	Disconnect the HDMI cable or USB cable.	102, 106,  18,  20
No image captured when the shutter-release button is pressed.	<ul style="list-style-type: none"> • When the camera is in playback mode, press the  button or shutter-release button. • When menus are displayed, press the MENU button. • The battery is exhausted. • When the scene mode is Night portrait or Backlighting with HDR set to Off, raise the flash. • If the flash mode icon flashes when the shutter-release button is pressed halfway, the flash is charging. • When using the Speedlight, refer to the documentation provided with the Speedlight to check the settings. <ul style="list-style-type: none"> - When shooting using Advanced Wireless Lighting photography, set the group setting to Group A. When using the built-in flash as the commander, set the channel of the flash unit to 3 CH. - When the flash setting is enabled for a group other than Group A, disable the flash setting. 	36 12 26 40, 43, 59 59  108





Problem	Cause/Solution	
Camera cannot focus.	<ul style="list-style-type: none"> The subject is too close. Try shooting using the Scene auto selector or Close-up scene mode, or the close range only/macro close-up focus mode. Incorrect focus mode setting. Check or change the setting. The subject is hard to focus on. Set AF assist in the setup menu to Auto. Subject is not in focus area when the shutter-release button is pressed halfway. The focus mode is set to MF (manual focus). Turn the camera off and then on again. 	40, 41, 64, 65 64, 65 84 99,  80 34, 73 64, 66 26
Colored stripes appear in the monitor when shooting.	Colored stripes may appear when shooting subjects with repeating patterns (such as window blinds); this is not a malfunction. The colored stripes will not appear in captured images or recorded movies. However, when using Continuous H: 120 fps or HS 480/4x , the colored stripes may be seen in the captured images and recorded movies.	–
Images are blurred.	<ul style="list-style-type: none"> Use the flash. Enable vibration reduction. Use BSS (Best Shot Selector) of Continuous in the shooting menu. Use a tripod to stabilize the camera when shooting (using the self-timer at the same time is more effective). 	59 99 73 62
Bright specks appear in images captured with flash.	The flash is reflecting off particles in the air. Set the flash mode setting to  (off).	59
Flash does not fire.	<ul style="list-style-type: none"> The flash mode is set to  (off). A shooting mode where the flash cannot fire is selected. A function that restricts the flash is enabled. The built-in flash does not fire when an external flash unit (optional) is used. When shooting using Advanced Wireless Lighting photography, set the group setting to Group A. When using the built-in flash as the commander, set the channel of the remote flash unit to 3 CH. See the documentation provided with your Speedlight (external flash unit). 	59 67 77  108  108





Problem	Cause/Solution	
Digital zoom cannot be used.	<ul style="list-style-type: none"> • A function that restricts digital zoom is enabled. • Digital zoom is set to Off or Crop in the setup menu. • Digital zoom cannot be used in the following situations. <ul style="list-style-type: none"> - When Scene auto selector, Portrait, Night portrait, Easy panorama in Panorama or Pet portrait is selected in scene mode - When Zoom exposure is selected in special effects mode • When Digital zoom is set to Crop in the setup menu, digital zoom cannot be used in the following situations. <ul style="list-style-type: none"> - When Image size is  4000×3000,  3264×2448,  3984×2656,  3968×2232 or  3000×3000 - When Movie options is  1080★/30p/  1080★/25p,  1080/30p/  1080/25p,  HS 480/4x,  HS 720/2x or  HS 1080/0.5x - When Continuous is set to Continuous H: 120 fps or Continuous H: 60 fps 	77 99,  81 39 46 99,  81  29  30 73,  46
Image size not available.	<ul style="list-style-type: none"> • A function that restricts the Image size option is enabled. • When the scene mode is set to Easy panorama in Panorama, the image size is fixed. 	77 44
No sound when shutter is released.	Off is selected for Sound settings > Shutter sound in the setup menu. No sound is produced with some shooting modes and settings, even when On is selected.	77, 100,  83
AF-assist illuminator does not light.	Off is selected for the AF assist option in the setup menu. AF-assist illuminator may not light depending on the position of the focus area or the current scene mode, even when Auto is selected.	99,  80
Images appear smeared.	The lens is dirty. Clean the lens.	 6
Colors are unnatural.	White balance is not adjusted properly.	42, 72,  35
Randomly spaced bright pixels (“noise”) appear in image.	The subject is dark, and the shutter speed is too slow or ISO sensitivity is too high. Noise can be reduced by: <ul style="list-style-type: none"> • Using the flash. • Specifying a lower ISO sensitivity setting. 	59 72,  33

Problem	Cause/Solution	
Images are too dark (underexposed).	<ul style="list-style-type: none"> The flash mode is set to  (off). The flash window is blocked. The subject is beyond the range of the flash. Adjust exposure compensation. Increase ISO sensitivity. The subject is backlit. Raise the flash, and set the scene mode Backlighting with HDR set to Off or set the flash mode setting to  (fill flash). On is selected for Built-in ND filter in the shooting menu. 	59 32 59 69 72,  33 43, 59 74
Images are too bright (overexposed).	<ul style="list-style-type: none"> Adjust exposure compensation. Use the Built-in ND filter setting in the shooting menu. 	69 74,  55
Unexpected results when flash set to  (auto with red-eye reduction).	When taking images with  (auto with red-eye reduction) or fill flash with red-eye reduction in Night portrait scene mode, In-Camera Red-Eye Fix may be applied to areas not affected by red-eye in rare cases. Use any scene mode other than Night portrait , and change the flash mode to any setting other than  (auto with red-eye reduction) and try taking an image again.	40, 59
Skin tones are not softened.	<ul style="list-style-type: none"> In some shooting conditions, facial skin tones may not be softened. For images containing 4 or more faces, try using Skin softening in the playback menu. 	84 88,  11
Saving images takes time.	It may take more time to save images in the following situations. <ul style="list-style-type: none"> When the noise reduction function is in operation When the flash mode is set to  (auto with red-eye reduction) When taking images in the following scene modes. <ul style="list-style-type: none"> Hand-held in Night landscape HDR set to other than Off in Backlighting Easy panorama in Panorama Continuous in the shooting menu is set to Continuous H: 120 fps or Continuous H: 60 fps When using smile timer while shooting When using Active D-Lighting while shooting When Image quality is set to RAW (NRW), RAW (NRW) + Fine or RAW (NRW) + Normal 	– 60 41 43 44 73,  46 63 74,  56  27

Problem	Cause/Solution	
A ring-shaped belt or rainbow-colored stripe appears in the monitor or images.	When shooting with backlighting or when a very strong light source (such as sunlight) is in the frame, a ring-shaped belt or rainbow-colored stripe (ghosting) may occur. Change the position of the light source, or frame the image so that the light source does not enter the frame, and try again.	-
Cannot select a setting/Selected setting is disabled.	<ul style="list-style-type: none"> Certain menu items are unavailable depending on the shooting mode. Menu items that cannot be selected are displayed in gray. A function that restricts the selected function is enabled. 	12 -

Playback Issues

Problem	Cause/Solution	
File cannot be played back.	<ul style="list-style-type: none"> This camera may not be able to play back images saved with another make or model of digital camera. This camera cannot play back RAW (NRW) images or movies captured or recorded with another make or model of digital camera. This camera may not be able to play back data edited on a computer. File cannot be played back during interval timer shooting. 	- - - 73,  47
Cannot zoom in on image.	<ul style="list-style-type: none"> Playback zoom cannot be used with movies, small pictures, or images that have been cropped to a size of 320 x 240 or smaller. This camera may not be able to zoom in on images captured with another make or model of digital camera. 	- -
Cannot record voice memo.	<ul style="list-style-type: none"> Voice memos cannot be attached to movies. Voice memos cannot be attached to images taken using Easy panorama. Voice memos cannot be attached to images captured with other cameras. Voice memos attached to images using another camera cannot be played back on this camera. 	- - 88,  67
Cannot edit image.	<ul style="list-style-type: none"> Some images cannot be edited. Images that have already been edited may not be edited again. There is not enough free space in the internal memory or on the memory card. This camera is unable to edit images captured with other cameras. Editing functions used for images are not available for movies. 	44,  9 - 90,  9 -

Problem	Cause/Solution	
Images are not displayed on TV.	<ul style="list-style-type: none"> • Video mode or HDMI is not correctly set in the TV settings setup menu. • The cables are connected to the HDMI mini connector and to the USB/audio/video output connector simultaneously. • The memory card contains no images. Replace the memory card. Remove the memory card to play back images from the internal memory. 	100,  86 102, 106,  18 24
Nikon Transfer 2 does not start when camera is connected to a computer.	<ul style="list-style-type: none"> • The camera is off. • The battery is exhausted. • The USB cable is not correctly connected. • The camera is not recognized by the computer. • Confirm system requirements. • The computer is not set to start Nikon Transfer 2 automatically. For more information about Nikon Transfer 2, refer to help information contained in ViewNX 2. 	26 26 102, 106 – 104 106
Images to be printed are not displayed.	<ul style="list-style-type: none"> • The memory card contains no images. Replace the memory card. • Remove the memory card to print images from the internal memory. 	24 25
Cannot select paper size with camera.	The camera cannot be used to select the paper size in the following situations, even when printing from a PictBridge-compatible printer. Use the printer to select the paper size. <ul style="list-style-type: none"> • The printer does not support the paper sizes specified by the camera. • The printer automatically selects the paper size. 	 21,  22 –

Specifications

Nikon COOLPIX P7800 Digital Camera

Type	Compact digital camera
Number of effective pixels	12.2 million
Image sensor	1/1.7-in. type CMOS; approx. 12.76 million total pixels
Lens	NIKKOR lens with 7.1x optical zoom
Focal length	6.0-42.8 mm (angle of view equivalent to that of 28-200 mm lens in 35mm [135] format)
f/-number	f/2-4
Construction	13 elements in 10 groups (2 ED lens elements)
Digital zoom magnification	Still pictures: Up to 4x (angle of view equivalent to that of approx. 800 mm lens in 35mm [135] format) Movies: Up to 2x (angle of view equivalent to that of approx. 400 mm lens in 35mm [135] format)
Vibration reduction	Lens shift
Autofocus (AF)	Contrast-detect AF
Focus range	<ul style="list-style-type: none">• [W]: Approx. 50 cm (1 ft 8 in.) - ∞, [T]: Approx. 80 cm (2 ft 8 in.) - ∞• Macro close-up mode: Approx. 2 cm (0.8 in.) (at a wide-angle zoom position) - ∞ (All distances measured from center of front surface of lens)
Focus-area selection	Face priority, auto (9-area automatic selection), center (wide, normal), manual with 99 focus areas, subject tracking, target finding AF
Viewfinder	Electronic viewfinder, 0.5 cm (0.2-in.) approx. 921k-dot LCD with the diopter adjustment function (-3 - +1 m ⁻¹)
Frame coverage (shooting mode)	Approx. 100% horizontal and 100% vertical (compared to actual picture)
Frame coverage (playback mode)	Approx. 100% horizontal and 100% vertical (compared to actual picture)
Monitor	7.5 cm (3-in.), approx. 921k-dot (RGBW), wide viewing angle TFT LCD with anti-reflection coating and 6-level brightness adjustment, vari-angle TFT LCD
Frame coverage (shooting mode)	Approx. 100% horizontal and 100% vertical (compared to actual picture)
Frame coverage (playback mode)	Approx. 100% horizontal and 100% vertical (compared to actual picture)

Storage		
Media		Internal memory (approx. 86 MB) SD/SDHC/SDXC memory card
File system		DCF, Exif 2.3 and DPOF compliant
File formats		Still pictures: JPEG, RAW (NRW) (Nikon's own format) Sound files (voice memo): WAV Movies: MOV (Video: H.264/MPEG-4 AVC, Audio: AAC stereo)
Image size (pixels)		<ul style="list-style-type: none"> • 12 M 4000×3000 • 8 M 3264×2448 • 4 M 2272×1704 • 2 M 1600×1200 • VGA 640×480 • 3:2 3984×2656 • 16:9 9M 3968×2232 • 1:1 3000×3000
ISO sensitivity (Standard output sensitivity)		<ul style="list-style-type: none"> • ISO 80 - 1600 • ISO 3200, Hi 1 (equivalent to ISO 6400) (available when using P, S, A or M mode)
Exposure		
Metering mode		Matrix, center-weighted, or spot. Also when AF area mode is set to Manual , the AF area can be coupled to the metering range using Focus-coupled metering .
Exposure control		Programmed auto exposure with flexible program, shutter-priority auto, aperture-priority auto, manual, exposure bracketing (Tv, Av, Sv) enabled, exposure compensation (in steps of 1/3 EV in the range of +/-3.0 EV for still pictures and +/-2.0 EV for movies) enabled
Shutter		Mechanical and CMOS electronic shutter
Speed		<ul style="list-style-type: none"> • 1/4000 * - 1 s • 1/4000 * - 60 s (when ISO sensitivity is set to 80 - 400 in M mode) * When the aperture value is set to f/4.5 - f/8 (wide-angle position) or the value is set to f/7.1 - f/8 (telephoto zoom position)
Aperture		Electronically-controlled 7-blade iris diaphragm
Range		13 steps of 1/3 EV (W) (A , M mode)
Self-timer		Can be selected from 10 s, 2 s and 1 s
Built-in flash		
Range (approx.) (ISO sensitivity: Auto)		[W]: 0.5 - 10 m (1 ft 8 in. - 32 ft) [T]: 0.5 - 5.5 m (1 ft 8 in. - 18 ft)
Flash control		TTL auto flash with monitor preflashes; manual flash control available
Flash exposure compensation		In steps of 1/3 EV in the range between -2 and +2 EV
Accessory shoe		ISO 518 hot-shoe with sync and data contacts and safety lock

Nikon Creative Lighting System	<ul style="list-style-type: none"> • i-TTL flash control support in combination with Nikon Creative Lighting System-compatible Speedlights (only Standard i-TTL flash control is supported during spot metering mode). • Flash Color Information Communication is supported. • Advanced Wireless Lighting is supported by setting SB-910, SB-900, SB-800 or SB-700 to master flash or by setting SU-800 to the Commander mode (the remote flash setting is only applicable to Group A). • Advanced Wireless Lighting is supported by setting the built-in flash to the Commander mode (only applicable to Group A and fixed at 3 CH).
Interface	Hi-Speed USB
Data transfer protocol	MTP, PTP
Video output	Can be selected from NTSC and PAL
HDMI output	Can be selected from Auto, 480p, 720p, and 1080i
I/O terminal	<ul style="list-style-type: none"> • Audio/video output; digital I/O (USB) • HDMI mini connector (Type C) (HDMI output) • External microphone connector (stereo mini-pin jack (3.5 mm diameter), plug-in power type) • Accessory terminal
Supported languages	Arabic, Bengali, Bulgarian, Chinese (Simplified and Traditional), Czech, Danish, Dutch, English, Finnish, French, German, Greek, Hindi, Hungarian, Indonesian, Italian, Japanese, Korean, Marathi, Norwegian, Persian, Polish, Portuguese (European and Brazilian), Romanian, Russian, Serbian, Spanish, Swedish, Tamil, Telugu, Thai, Turkish, Ukrainian, Vietnamese
Power sources	<ul style="list-style-type: none"> • One Rechargeable Li-ion Battery EN-EL14 (included) • AC Adapter EH-5b (used in combination with the Power Connector EP-5A) (available separately)
Battery life¹	
Still pictures	Approx. 350 shots when using EN-EL14
Movie recording (actual battery life for recording)²	Approx. 1 h 15 min when recording in NTSC mode using EN-EL14 Approx. 1 h 20 min when recording in PAL mode using EN-EL14
Tripod socket	1/4 (ISO 1222)
Dimensions (W × H × D)	Approx. 118.5 × 77.5 × 50.4 mm (4.7 × 3.1 × 2.0 in.) (excluding projections)
Weight	Approx. 399 g (14.1 oz) (including battery and SD memory card)

Operating environment

Temperature	0°C - 40°C (32°F - 104°F)
Humidity	85% or less (no condensation)

- Unless otherwise stated, all figures assume a fully-charged battery and an ambient temperature of 23 ±3°C (73.4 ±5.4°F) as specified by the Camera and Imaging Products Association (CIPA).
- ¹ Battery life may vary depending on conditions of use, such as the interval between shots or the length of time that menus and images are displayed.
 - ² Individual movie files cannot exceed 4 GB in size or 29 minutes in length. Recording may end before this limit is reached if camera temperature becomes elevated.

Rechargeable Li-ion Battery EN-EL14

Type	Rechargeable lithium-ion battery
Rated capacity	DC 7.4 V, 1030 mAh
Operating temperature	0°C - 40°C (32°F - 104°F)
Dimensions (W × H × D)	Approx. 38 × 53 × 14 mm (1.5 × 2.1 × 0.6 in.)
Weight	Approx. 48 g (1.7 oz) (excluding terminal cover)

Battery Charger MH-24

Rated input	AC 100 - 240 V, 50/60 Hz, 0.2 A max.
Rated output	DC 8.4 V, 0.9 A
Supported rechargeable battery	Rechargeable Li-ion Battery EN-EL14
Charging time	Approx. 1 hour and 30 minutes when no charge remains
Operating temperature	0°C - 40°C (32°F - 104°F)
Dimensions (W × H × D)	Approx. 70 × 26 × 97 mm (2.8 × 1.0 × 3.8 in.) (excluding plug adapter) For Argentina: Approx. 70 × 68 × 104 mm (2.8 × 2.7 × 4.1 in.)
Weight	Approx. 89 g (3.1 oz) (excluding plug adapter) For Argentina: Approx. 125 g (4.5 oz)

Specifications

- Nikon will not be held liable for any errors this manual may contain.
- The appearance of this product and its specifications are subject to change without notice.

AVC Patent Portfolio License

This product is licensed under the AVC Patent Portfolio License for the personal and non-commercial use of a consumer to (i) encode video in compliance with the AVC standard ("AVC video") and/or (ii) decode AVC video that was encoded by a consumer engaged in a personal and non-commercial activity and/or was obtained from a video provider licensed to provide AVC video. No license is granted or shall be implied for any other use. Additional information may be obtained from MPEG LA, L.L.C.

See <http://www.mpegla.com>.

FreeType License (FreeType2)

Portions of this software are copyright © 2013 The FreeType Project (<http://www.freetype.org>). All rights reserved.

MIT License (HarfBuzz)

Portions of this software are copyright © 2013 The HarfBuzz Project (<http://www.freedesktop.org/wiki/Software/HarfBuzz>). All rights reserved.

Trademark Information

- Microsoft, Windows and Windows Vista are either registered trademarks or trademarks of Microsoft Corporation in the United States and/or other countries.
- Macintosh and Mac OS are trademarks of Apple Inc., registered in the U.S. and other countries.
- Adobe and Acrobat are registered trademarks of Adobe Systems Inc.
- SDXC, SDHC and SD Logos are trademarks of SD-3C, LLC.
- PictBridge is a trademark.
- HDMI, HDMI logo and High-Definition Multimedia Interface are trademarks or registered trademarks of HDMI Licensing LLC.

HDMI

- Wi-Fi and the Wi-Fi logo are trademarks or registered trademarks of the Wi-Fi Alliance.
- All other trade names mentioned in this manual or the other documentation provided with your Nikon product are trademarks or registered trademarks of their respective holders.

Index

Symbols

AE/AF-L  6

AE-L AE-L/AF-L button..... 4, 85

[AF] AF area mode... 58, 73,  49

A Aperture-priority auto mode

..... 49, 51

[OK] Apply selection button..... 6

[Auto] Auto mode..... 30, 38

[Delete] Delete button..... 37, 98, 100,



 8,  67,  88

[Flash] Flash mode..... 58, 59

[Flash Pop-Up] Flash pop-up control..... 59

[Focus] Focus mode..... 58, 64

Fn1 Function 1 button..... 4, 74,

100,  57,  90,  91,

 92

Fn2 Function 2 button

..... 5, 7, 11, 101,  92

M Manual mode..... 49, 51

MENU Menu button

..... 12, 73, 88, 96, 99

[Monitor] Monitor button..... 10

[Movie Custom] CSM Movie custom setting mode... 91

[Movie] Movie mode..... 91

[Playback] Playback button... 5, 6, 36, 97

[Zoom] Playback zoom..... 86

P Programmed auto mode... 49, 51

[Quick Menu] Quick menu button..... 70, 95

SCENE Scene mode..... 39

[Self-Timer] Self-timer/Smile timer/Remote control

..... 58, 62, 63, 99,

 78,  106

S Shutter-priority auto mode

..... 49, 51

EFFECTS Special effects mode... 46

T (Telephoto)..... 33

[Thumbnail] Thumbnail display..... 87

U1, U2 and **U3** User settings

modes..... 55

W (Wide-angle)..... 33

.JPG.....  103

.MOV.....  103

.NRW.....  103

.WAV.....  103



A

AC adapter..... 102,  104

Accessory shoe..... 1,  108

Accessory Shoe Cover... 1,  108

Accessory terminal

..... 2, 101,  95,  113

Active D-Lighting..... 74,  56

AE/AF lock button... 85, 100,  89



AF area mode..... 58, 73,  49

AF assist..... 99,  80

Aperture value..... 49

Aperture-priority auto mode... 49, 51

Audio video cable

..... 103,  18,  104

Audio/video-in jack.....  18

Auto bracketing..... 70, 72,  38

Auto flash..... 60



Auto off..... 27, 100,  84

Auto with red-eye reduction... 60, 61











Autofocus..... 65, 74, 84, 96,

 53,  71













Autofocus mode

..... 65, 74, 96,  53,  71



B

- Backlighting  43
- Battery 20, 22,  18
- Battery charger 20,  19
- Battery level indicator 26
- Battery-chamber/memory card slot cover 22, 24
- Best Shot Selector 42,  46
- Black and white copy  42
- Black border 89,  14
- Brightness 99,  75
- BSS 42,  46
- Built-in ND filter 74, 97,  55
- Button sound  83













C

- Calendar display 87
- Choose key picture 89,  69
- Close range only 65
- Close-up  41
- CLS  108
- Color temperature  36
- Command dial 3, 6, 49
- Command dial rotation... 100,  87
- Commander mode... 60, 75,  59
- Computer 103, 106
- Continuous 73,  46
- Contrast  42
- COOLPIX Custom Picture Control
..... 73, 96,  44
- COOLPIX Picture Control
..... 70, 72, 95,  40
- Copy 89,  68
- Crop 86,  17
- Custom Picture Control
..... 73, 96,  44















Customize command dials

- 100,  87
- Customize My Menu 101,  93

D

- Date and time 28, 99,  73
- Daylight saving time 28,  74
- Delete 37, 88, 98,  8,  65,  67
- Delete button options... 100,  88
- Digital zoom 33, 99,  81
- Diopter adjustment control 10
- Direct Print 103,  20
- Distortion control 74,  55
- D-Lighting 88,  10
- DPOF printing  24
- DSCN  103

E

- Easy panorama 44,  2
 - Editing movies  25
 - Editing still images  9
 - Exposure compensation 69
 - Exposure compensation dial 69
 - Exposure mode 49
 - Extension  103
 - External flash unit ...  59,  108
 - External mic sensitivity... 100,  86
 - External microphone  104
 - Extracting still images  26
 - Eye-Fi upload 101,  96
 - Eyelet for camera strap 8
- E**
- Face detection 83
 - Face priority  49
 - Fast motion movies...  31,  32
 - File name  103

- Fill flash..... 60
 Filter effects 88, 12, 42
 Fireworks show 42
 Firmware version..... 101, 98
 Fixed aperture..... 99, 82
 Flash 58, 59
 Flash control..... 101, 97
 Flash control mode..... 59
 Flash exp. comp..... 74, 54
 Flash mode 58, 59
 Flash off..... 60
 Fn1 + command dial... 4, 100, 91
 Fn1 + selector dial ... 4, 101, 91
 Fn1 + shutter button ... 4, 100, 90
 Fn1 guide display ... 4, 101, 92
 Fn2 button 101, 92
 Focal length
 74, 75, 57, 16
 Focus.... 34, 76, 82, 93, 49,
53, 71
 Focus area
 16, 34, 45, 82, 49
 Focus indicator 15, 34
 Focus lock..... 85
 Focus mode..... 58, 64
 Focus-coupled metering... 75, 58
 Food 42
 Format..... 24, 100, 85
 Format memory cards
 24, 100, 85
 Format the internal memory
 100, 85
 Framing grid..... 16, 75
 FSCN..... 103
 Full-frame playback
 18, 36, 86, 87
 Full-time AF
 74, 96, 53, 71
 Functions that cannot be used
 simultaneously..... 77
G
 GPS unit..... 105, 113
H
 HDMI 86
 HDMI device control 86
 HDMI mini connector..... 18
 HDR 43
 High-speed continuous 47
 Histogram..... 19, 99, 75
 HS movie..... 31, 32
I
 Identifier 103
 Image copy 89, 68
 Image quality 70, 72, 27
 Image selection screen..... 90
 Image sharpening..... 42
 Image size 70, 72, 29
 Infinity..... 65
 Initial monitor display..... 76
 Internal memory indicator..... 26
 Interval timer shooting 47
 ISO sensitivity ... 70, 72, 95, 33
 ISO sensitivity step value... 99, 80
L
 Language..... 100, 85
 Lens..... 6, 16
 Lens cap 8
 Lens hood 104
 Lens ring..... 1, 105
 Li-ion rechargeable battery
 20, 22, 19

M

- M exposure preview..... 74, 58
- Macro close-up..... 65
- Main command dial..... 3, 6, 49
- Manual flash..... 60
- Manual focus..... 65, 66
- Manual mode..... 49, 51
- Memory capacity..... 26, 91, 92
- Memory card..... 24, 25
- Memory card slot..... 24
- Metering..... 73, 45
- MF distance indicator units
..... 101, 97
- Microphone..... 91, 67
- Minimum shutter speed..... 33
- Mode dial..... 30
- Monitor..... 9, 11, 14, 6
- Monitor settings..... 99, 75
- Movie and movie custom setting menus
..... 96, 70
- Movie custom setting mode..... 91
- Movie length..... 92
- Movie mode..... 91
- Movie options..... 95, 30
- Movie playback..... 97
- Movie recording..... 91
- Movie recording time remaining.... 91
- Multi selector..... 3, 6, 58
- Multi selector right press.... 100, 88
- Multi-shot 16..... 46
- Museum 42
- My Menu..... 72, 101, 93

N

- Night landscape 41
- Night portrait 40

Nikon Creative Lighting System

- 108, 18
 - Noise reduction filter.... 74, 54
 - Number of exposures remaining
..... 26, 28
- O**
- Optical zoom..... 33
 - Optional accessories..... 104
- P**
- Panorama assist..... 44, 5
 - Panorama 44
 - Party/indoor 41
 - Pet portrait 45
 - Photo info..... 75, 99, 75
 - PictBridge..... 103, 20
 - Picture Control... 70, 72, 95, 40
 - Playback..... 36, 97, 67
 - Playback menu..... 88
 - Playback mode..... 36
 - Playback zoom..... 86
 - Playback/menus..... 75
 - Power..... 26, 28
 - Power connector..... 104
 - Power supply..... 95
 - Power switch/power-on lamp..... 2
 - Preset manual..... 37
 - Pressing halfway..... 4, 34, 35
 - Print..... 20, 21, 22
 - Print date..... 99, 77
 - Print order..... 88, 62
 - Print order date option..... 63
 - Printer..... 102, 20
 - Programmed auto mode.... 49, 51
 - Protect..... 88, 66

Q

- Quick adjust..... 42
- Quick menu..... 70, 95, 27
- Quick retouch..... 88, 10

R

- RAW (NRW) images..... 27
- RAW (NRW) processing ... 89, 15
- Rear-curtain sync..... 60
- Rechargeable battery..... 20
- Record orientation 100, 83
- Remote control
..... 58, 105, 106, 107
- Reset all..... 101, 98
- Reset file numbering.... 101, 94
- Reset user settings 57
- Reverse indicators..... 101, 97
- Rotary multi selector.... 2, 3, 6, 58
- Rotate image 88, 66
- Rotate tall..... 100, 84
- RSCN..... 103

S

- Saturation..... 42
- Save user settings 55
- Scene auto selector 40
- Scene mode 39
- Selecting images..... 90
- Self-timer 58, 62, 76
- Self-timer lamp..... 62, 63
- Self-timer: after release... 99, 78
- Sequence..... 37, 7, 68
- Sequence display options
..... 89, 69
- Setup menu..... 99, 72
- Shooting..... 30
- Shooting information..... 11, 14
- Shooting menu..... 73, 44

Shooting mode





- 31, 75, 96, 70
- Shutter sound..... 83
- Shutter speed..... 49, 53
- Shutter-priority auto mode... 49, 51
- Shutter-release button ... 4, 7, 34, 35
- Single 73, 46
- Single AF ... 74, 96, 53, 71
- Skin softening..... 84, 88, 11
- Slide show..... 88, 64
- Slow motion movies.... 31, 32
- Slow sync..... 60
- Small picture..... 88, 13
- Smile timer 58, 63
- Sound settings..... 100, 83
- Special effects mode 46
- Specialized menu for **U1, U2** or **U3**
..... 55, 75
- Speedlight..... 108
- Sports 40
- SSCN..... 103
- Startup zoom position... 74, 57
- Straighten..... 89, 15
- Sub-command dial..... 3, 6, 49
- Subject tracking 50, 51
- Switching among tabs..... 13

T









- Target finding AF..... 82, 51
- Telephoto..... 33
- Thumbnail display 87
- Time difference..... 74
- Time zone..... 28, 74
- Time zone and date ... 28, 99, 73
- Tone level..... 19
- Tone level information
..... 11, 19, 75

Toning.....  43
TV 102,  18
TV settings 100,  86





U

USB cable 103, 106,  20
USB/audio/video output connector
..... 102, 106,  18,  20
Use GPS to set clock.....  95
User settings modes 55

V

Vibration reduction..... 99,  79
Video mode  86
View grid.....  41
Viewfinder..... 10, 32,  6
ViewNX 2 104
Virtual horizon..... 16, 99,  75
Virtual horizon display ... 76,  75
Voice memo 88,  67
Volume 97,  67

W

Welcome screen..... 99,  72
White balance... 70, 72, 95,  35
Wide-angle..... 33
Wind noise reduction... 97,  72
Wireless mobile adapter.....  105

Z

Zoom 33
Zoom control 6, 33
Zoom memory 74,  57
Zoom speed..... 99,  82

No reproduction in any form of this manual, in whole or in part (except for brief quotation in critical articles or reviews), may be made without written authorization from NIKON CORPORATION.

NIKON CORPORATION

© 2013 Nikon Corporation



**FX3104(11)
6MN29311-04**