



SAMSUNG

User Manual

ST65/ST67

This user manual includes detailed usage instructions for your camera. Please read this manual thoroughly.

 [Click a topic](#)

Basic troubleshooting

Quick reference

Contents

Basic functions

Extended functions

Shooting options

Playback/Editing

Settings

Appendixes

Index

Health and safety information

Always comply with the following precautions and usage tips to avoid dangerous situations and ensure peak performance of your camera.



Warning—situations that could cause injury to yourself or others

Do not disassemble or attempt to repair your camera.

This may result in electric shock or damage to the camera.

Do not use your camera near flammable or explosive gases and liquids.

This may cause a fire or explosion.

Do not insert flammable materials into the camera or store these materials near the camera.

This may cause a fire or electric shock.

Do not handle your camera with wet hands.

This may result in electric shock.

Prevent damage to subjects' eyesight.

Do not use the flash in close proximity (closer than 1 m/3 ft) to people or animals. If you use the flash too close to your subject's eyes, this can cause temporary or permanent eyesight damage.

Keep your camera away from small children and pets.

Keep your camera and all accessories out of the reach of small children and animals. Small parts may cause choking or serious injury if swallowed. Moving parts and accessories may present physical dangers as well.

Do not expose the camera to direct sunlight or high temperatures for an extended period of time.

Prolonged exposure to sunlight or extreme temperatures can cause permanent damage to your camera's internal components.

Avoid covering the camera or charger with blankets or clothes.

The camera may over-heat, which may distort the camera or cause a fire.

If liquid or foreign objects enter your camera, immediately disconnect all power sources such, as the battery or charger, and then contact a Samsung service center.



Caution—situations that could cause damage to your camera or other equipment

Remove the batteries from your camera when storing it for an extended period of time.

Installed batteries may leak or corrode over time and cause serious damage to your camera.

Use only authentic, manufacturer-recommended, Lithium-ion replacement batteries. Do not damage or heat the battery.

This may cause a fire or personal injuries.

Use only Samsung-approved batteries, chargers, cables and accessories.

- Unauthorized batteries, chargers, cables or accessories can cause batteries to explode, damage your camera, or cause injury.
- Samsung is not responsible for damages or injuries caused by unapproved batteries, chargers, cables or accessories.

Do not use batteries for unintended purposes.

This may cause a fire or electric shock.

Do not touch the flash while it fires.

The flash is very hot when fired and may burn your skin.

When you use AC charger, turn off the camera before you disconnect the power to the AC charger.

Failing to do so may result in fire or electric shock.

Disconnect chargers from power sources when not in use.

Failing to do so may result in fire or electric shock.

Do not use a damaged power supply cord, plug, or loose outlet when you charge batteries.

This may cause a fire or electric shock.

Do not allow the AC charger to come in contact with the +/- terminals on the battery.

This may cause a fire or electric shock.

Do not force the camera's parts or apply pressure to the camera.

This may cause your camera to malfunction.

Exercise caution when you connect cables or adapters and install batteries and memory cards.

If you force the connectors, improperly connect cables, or improperly install batteries and memory cards, you can damage ports, connectors, and accessories.

Keep cards with magnetic strips away from the camera case.

Information stored on the card may be damaged or erased.

Never use a damaged charger, battery, or memory card.

This may result in electric shock or camera malfunction or cause a fire.

Check that the camera is operating properly before use.

The manufacturer takes no responsibility for any loss of files or damages that may result from camera malfunction or improper use.

You must plug the end of the cable with the indicator light (▲) into your camera.

If the cable is reversed, it may damage your files. The manufacturer is not responsible for any loss of data.

Copyright information

- Microsoft Windows and the Windows logo are registered trademarks of the Microsoft Corporation.
- micro SD™, micro SDHC™ are registered trademarks of the SD Association.
- Mac is a registered trademark of the Apple Corporation.
- Trademarks and trade names used in this manual are the property of their respective owners.

- Camera specifications or contents of this manual may be changed without prior notice due to upgrade of camera functions.
- You are not allowed to reuse or distribute any part of this manual without prior permission.
- For Open Source License information, refer to the "OpenSourceInfo.pdf" in the provided CD-ROM.

Organization of the user manual

Basic functions 11

Learn about your camera's layout, icons, and basic functions for shooting.

Extended functions 26

Learn how to take a photo by selecting a mode and how to record a video or voice memo.

Shooting options 35

Learn about the options you can set in shooting mode.

Playback/Editing 53

Learn how to play back photos, videos, or voice memos and edit photos or videos. You will also learn how to connect your camera to your photo printer or TV.





Settings 76

Refer to options to configure your camera's settings.

Appendixes 82

Refer to error messages, specifications, and maintenance tips.



Indications used in this manual

Shooting mode	Indication
Smart Auto	
Program	
DIS	
Scene	
Movie	

Shooting mode icons

These icons indicate that a function is available in the corresponding modes. The  mode may not support functions for all scenes.

e.g.)

Adjusting the exposure manually (EV)   

Depending on the intensity of the ambient light, your photos may be too bright or dark. In these cases, you can adjust the exposure to get a better photo.



Darker (-)





Neutral (0)



Brighter (+)

Available in the Program, DIS, and Movie modes

Icons used in this manual

Icon	Function
	Additional information
	Safety warnings and precautions
[]	Camera buttons; for example: [Shutter] represents the shutter button.
()	Page number of related information
→	The order of options or menus you must select to perform a step. For example: Select Shooting → White Balance represents select Shooting , and then select White Balance .
*	Annotation

Abbreviations used in this manual

Abbreviation	Definition
ACB	Auto Contrast Balance
AEB	Auto Exposure Bracket
AF	Auto Focus
DIS	Digital Image Stabilization
DPOF	Digital Print Order Format
EV	Exposure Value
ISO	International Organization for Standardization
WB	White Balance

Expressions used in this manual

Pressing the shutter

- Half-press [**Shutter**]: Press the shutter halfway down.
- Press [**Shutter**]: Press the shutter all the way down.

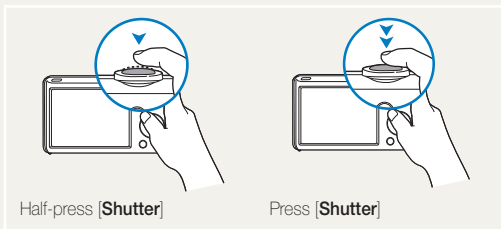

Exposure (Brightness)

The amount of light that enters your camera determines the exposure. You can alter the exposure with shutter speed, aperture value, and ISO speed. By altering the exposure, your photos will be darker or lighter.



Normal exposure

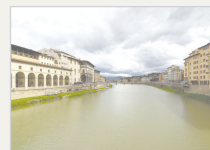

Overexposure (too bright)





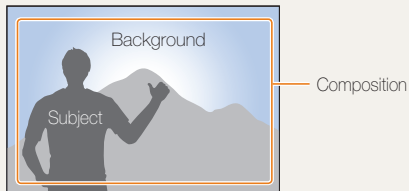









Subject, background, and composition

- **Subject:** The main object of a scene, such as a person, animal, or still life.
- **Background:** The objects around the subject.
- **Composition:** The combination of a subject and background.



Basic troubleshooting



You can get answers to common questions. Solve problems easily by setting shooting options.

	The subject's eyes appear red.	<p>This is caused by a reflection from the camera flash.</p> <ul style="list-style-type: none">• Set the flash option to  Red-eye or  Red-eye Fix. (p. 38)• If the photo has already been taken, select  Red-eye Fix in the edit menu. (p. 65)
	Photos have dust spots.	<p>Dust particles floating in the air may be captured in photos when using the flash.</p> <ul style="list-style-type: none">• Turn off the flash or avoid taking photos in a dusty place.• Set ISO speed options. (p. 39)
	Photos are blurred.	<p>This may be caused by taking photos in low light conditions or holding the camera incorrectly.</p> <ul style="list-style-type: none">• Press [Shutter] halfway down to make sure the subject is focused. (p. 24)• Use the  mode. (p. 31)
	Photos are blurred when shooting at night.	<p>As the camera tries to let in more light, the shutter speed slows. This can make it difficult to steady the camera and may result in camera shake.</p> <ul style="list-style-type: none">• Turn on the flash. (p. 38)• Set ISO speed options. (p. 39)• Use a tripod to prevent your camera from shaking.• Select  Night in the  mode. (p. 30)
	Subjects come out too dark because of backlighting.	<p>When the light source is behind the subject or when there is a high contrast between the light and dark areas, the subject may come out shaded.</p> <ul style="list-style-type: none">• Avoid shooting with the sun behind your subject.• Select  Backlight in the  mode. (p. 28)• Set the flash option to  Fill in. (p. 38)• Set the Auto Contrast Balance (ACB) option. (p. 46)• Adjust the exposure. (p. 46)• Set the metering option to  Spot if a bright subject is in the center of the frame. (p. 47)

Quick reference



Taking photos of people

-  mode > Beauty Shot ▶ 29
-  mode > Portrait ▶ 28
- Red-eye, Red-eye Fix (to prevent or correct red-eye) ▶ 38
- Face Detection ▶ 43



Taking photos at night or in the dark

-  mode > Night ▶ 30
-  mode > Sunset, Dawn, Fireworks ▶ 28
- Flash options ▶ 38
- ISO speed (to adjust the sensitivity to light) ▶ 39



Taking action photos

- Continuous, Motion Capture ▶ 49



Taking photos of text, insects, or flowers

-  mode > Close Up, Text ▶ 28
- Macro, Auto Macro (to take close-up photos) ▶ 40
- White Balance (to change the color tone) ▶ 47



Adjusting the exposure (brightness)

- EV (to adjust exposure) ▶ 46
- ACB (to compensate for subjects against bright backgrounds) ▶ 46
- Metering ▶ 47
- AEB (to take three photos of the same scene with different exposures) ▶ 49



Applying a different effect

- Photo styles (to apply tones) ▶ 50
- Smart filter effects ▶ 51
- Image adjustment (to adjust saturation, sharpness, or contrast) ▶ 52



Reducing camera shake

-  mode ▶ 31

- Viewing files by category in Smart Album ▶ 55
- Deleting all files on the memory card ▶ 57
- Viewing files as a slide show ▶ 58
- Viewing files on a TV ▶ 67
- Connecting your camera to a computer ▶ 68
- Adjusting sound and volume ▶ 78
- Adjusting the brightness of the display ▶ 78
- Changing the display language ▶ 79
- Setting the date and time ▶ 79
- Formatting the memory card ▶ 79
- Troubleshooting ▶ 92

Contents

Basic functions	11	Recording a voice memo	34
Unpacking	12	Adding a voice memo to a photo	34
Camera layout	13	Shooting options	35
Inserting the battery and memory card	15	Selecting a resolution and quality	36
Charging the battery and turning your camera on	16	Selecting a resolution	36
Charging the battery	16	Selecting image quality	36
Turning on your camera	16	Using the timer	37
Performing the initial setup	17	Shooting in the dark	38
Learning icons	18	Preventing red-eye	38
Selecting options	19	Using the flash	38
Setting the display and sound	21	Adjusting the ISO speed	39
Changing the display type	21	Changing the camera's focus	40
Setting the sound	21	Using macro	40
Taking photos	22	Using auto focus	40
Zooming	23	Using tracking auto focus	41
Tips for getting a clearer photo	24	Adjusting the focus area	42
Extended functions	26	Using face detection	43
Shooting modes	27	Detecting faces	43
Using the Smart Auto mode	27	Taking a self-portrait shot	44
Using the Scene mode	28	Taking a smile shot	44
Using the Beauty Shot mode	29	Detecting eye blinking	45
Using the frame guide	30	Adjusting brightness and color	46
Using the Night mode	30	Adjusting the exposure manually (EV)	46
Using the DIS mode	31	Compensating for backlighting (ACB)	46
Using the Program mode	32	Changing the metering option	47
Recording a video	32	Selecting a light source (White balance)	47
Recording voice memos	34	Using burst modes	49
		Improving your photos	50

Applying photo styles	50	Sound	78
Applying smart filter effects	51	Display	78
Adjusting your photos	52	Settings	79
Playback/Editing	53	Appendixes	82
Playing back	54	Error messages	83
Starting Playback mode	54	Camera maintenance	84
Viewing photos	58	Cleaning your camera	84
Playing a video	59	Using or storing the camera	85
Playing voice memos	60	About memory cards	86
Editing a photo	62	About the battery	88
Resizing photos	62	Before contacting a service center	92
Rotating a photo	62	Camera specifications	95
Applying photo styles	63	Glossary	99
Applying smart filter effects	64	FCC notice	103
Correcting exposure problems	65	Index	104
Creating a print order (DPOF)	66		
Viewing files on a TV	67		
Transferring files to your Windows computer	68		
Transferring files using Intelli-studio	70		
Transferring files by connecting the camera as a removable disk ..	72		
Disconnecting the camera (for Windows XP)	73		
Transferring files to your Mac computer	74		
Printing photos with a PictBridge photo printer	75		
Settings	76		
Camera settings menu	77		
Accessing the settings menu	77		

Basic functions

Learn about your camera's layout, icons, and basic functions for shooting.

Unpacking	12
Camera layout	13
Inserting the battery and memory card	15
Charging the battery and turning your camera on	16
Charging the battery	16
Turning on your camera	16
Performing the initial setup	17
Learning icons	18
Selecting options	19
Setting the display and sound	21
Changing the display type	21
Setting the sound	21
Taking photos	22
Zooming	23
Tips for getting a clearer photo	24

Unpacking

Check your product box for the following items.



Camera

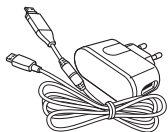

AC adapter/USB cable

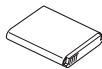

Rechargeable battery



Strap

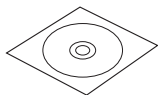

User Manual CD-ROM

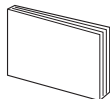

Quick Start Manual

Optional accessories



Camera case

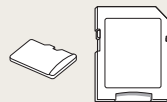

Memory card/
Memory card adapter

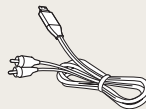

AV cable

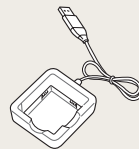

Battery charger



The illustrations may differ from your actual items.

Camera layout

Before you start, familiarize yourself with your camera's parts and their functions.

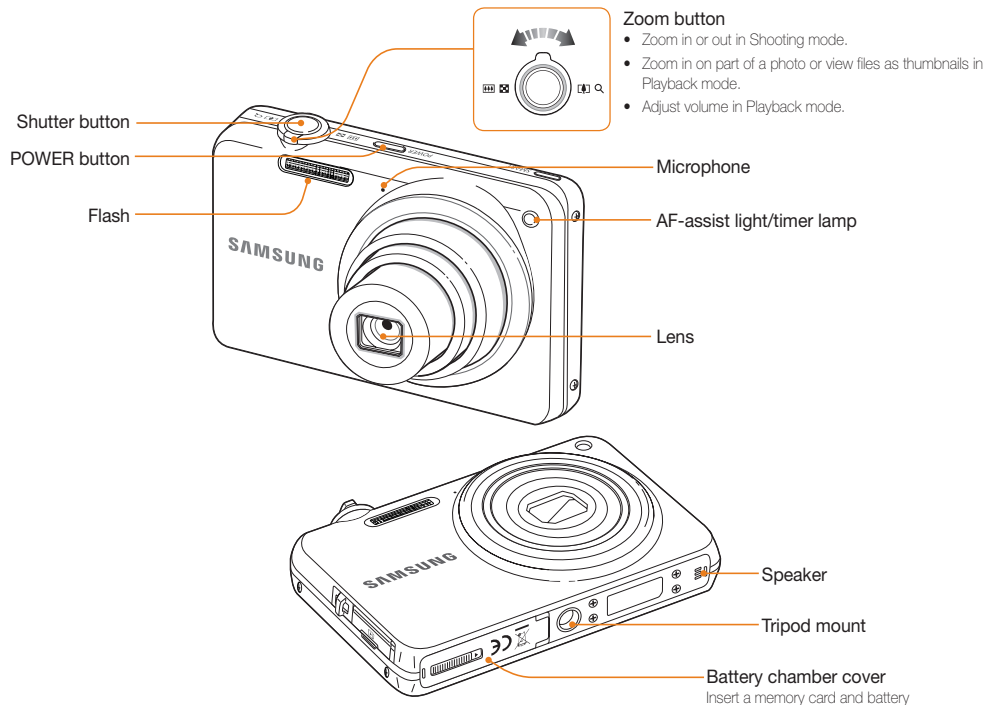

Camera layout

Smart button
Set to Smart mode (SMART)

Status lamp

- **Blinking:** When the camera is saving a photo or video, being read by a computer or printer, or out of focus
- **Steady:** When the camera is connecting to a computer or in focus

Display

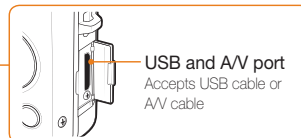
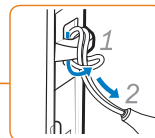
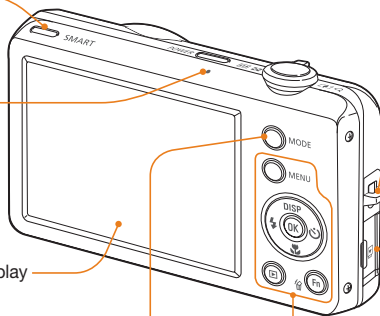

USB and AV port
Accepts USB cable or AV cable

Mode button: Open the list of shooting modes

Icon	Mode	Description
	Smart Auto	The camera automatically selects settings based on a the type of scene (Night, Portrait, Sunset, etc.) it detects.
	Program	Take a photo by setting options
	DIS	The camera activates options that reduce camera shake.
	Scene	Take a photo with options preset for a specific scene (Landscape, Portrait, Forest, etc.).
	Movie	Record a video.

Button		Description
	MENU	Access options or menus
		In Shooting mode While setting
	DISP	Change the display option Move up
		Change the macro option Move down
		Change the flash option Move left
		Change the timer option Move right
	OK	Confirm the highlighted option or menu
	Playback	Enter Playback mode
	Function	<ul style="list-style-type: none"> • Access options in Shooting mode • Delete files in Playback mode

Inserting the battery and memory card

Learn to insert the battery and an optional memory card into the camera.

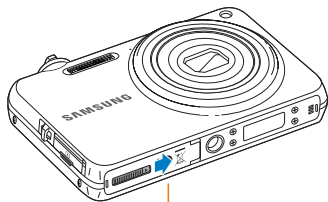

Insert a memory card with the gold-colored contacts facing up.

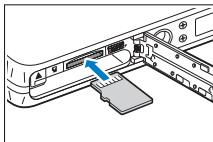

Insert the battery with the Samsung logo facing down.

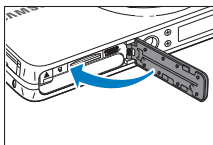
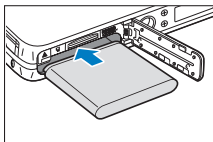

Removing the battery and memory card

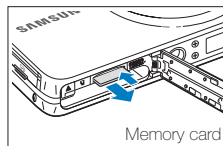

Push the card gently until the card disengages from the camera, and then pull it out of the slot.

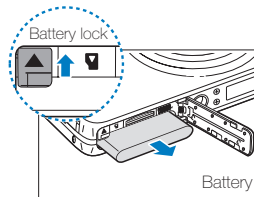

Push the lock up to release the battery.



- You can use the internal memory as a temporary storage device when the memory card is not inserted.
- Insert a memory card in the correct direction. Inserting a memory card in the wrong direction may damage your camera and memory card.

Charging the battery and turning your camera on

Charging the battery

Before using the camera for the first time, you must charge the battery. Attach the USB cable to the AC adapter, and then plug the end of cable with the indicator light into your camera.

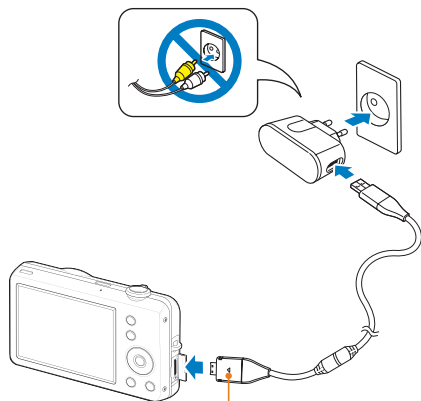

Indicator light

- Red: Charging
- Green: Fully charged

Turning on your camera

Press **[POWER]** to turn your camera on or off.

- The initial setup screen appears when you turn on the camera for the first time. (p. 17)

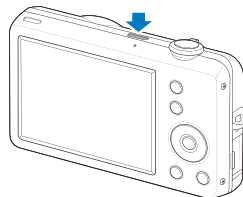

Turning on your camera in Playback mode

Press **[▶]**. The camera turns on and accesses Playback mode immediately.

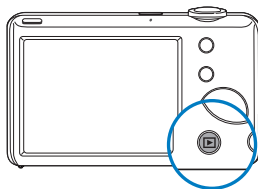

When you turn on your camera by pressing and holding **[▶]** for about 5 seconds, the camera does not emit any camera sounds.

Performing the initial setup

The initial setup screen appears to allow you to configure the camera's basic settings.

1 Press [POWER].

- The initial setup screen appears when you turn on the camera for the first time.

2 Press [OK] to select **Language** and press [OK] or [OK].

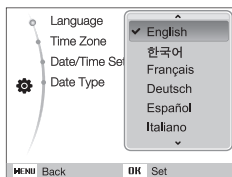

3 Press [DISP] or [OK] to select a language and press [OK].

4 Press [DISP] or [OK] to scroll to **Time Zone** and press [OK] or [OK].

5 Press [DISP] or [OK] to select a time zone and press [OK].

- To set the daylight-saving time, press [DISP].



6 Press [DISP] or [OK] to select **Date/Time Set** and press [OK] or [OK].

7 Press [DISP] or [OK] to select an item.

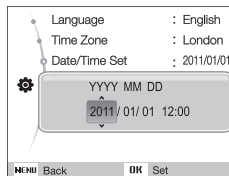

8 Press [DISP] or [OK] to set the date and time and press [OK].

9 Press [DISP] or [OK] to select **Date Type** and press [OK] or [OK].

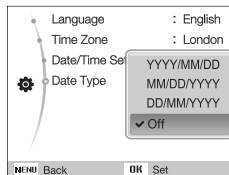

10 Press [DISP] or [OK] to select a date format and press [OK].

11 Press [MENU] to switch to the Shooting mode.

Learning icons

The icons displayed will change according to the mode you select or the options you set.

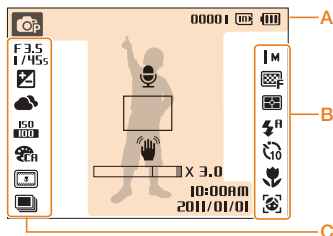

A. Information

Icon	Description
	Selected shooting mode
00001	Available number of photos
00:00:20	Available recording time
	Internal memory
	Memory card inserted
	<ul style="list-style-type: none"> : Fully charged : Partially charged : Charging needed
	Voice memo (On)

Icon	Description
	Auto focus frame
	Camera shake
	Zoom ratio
10:00AM 2011/01/01	Current date and time

B. Icons on the right

Icon	Description
1M	Photo resolution
640	Video resolution
	Frame rate
	Photo quality
	Metering option
	Flash option
	Timer option
	Auto focus option
	Face detection

C. Icons on the left



Icon	Description
F3.5 1/45s	Aperture and shutter speed
LT	Long time shutter
	Exposure value
	White balance
	Face tone
	Face retouch
ISO 100	ISO speed
	Photo style
	Image adjustment (contrast, sharpness, saturation)
	Video Stabilizer
	Smart filter effect
	Voice recording available when shooting video
	Burst type

Selecting options

You can select options by pressing [**MENU**], and then using the navigation buttons ([**DISP**], [, [, []).



You can also access shooting options by pressing [**Fn**], but some options are not available.

- 1 In Shooting mode, press [**MENU**].
- 2 Use the navigation buttons to scroll to an option or menu.
 - To move up or down, press [**DISP**] or [].
 - To move left or right, press [] or [].

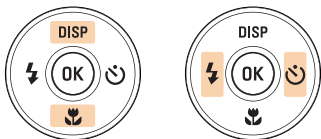

- 3 Press [**OK**] to confirm the highlighted option or menu.

Going back to the previous menu

Press [**MENU**] again to go back to the previous menu.



Half-press [**Shutter**] to return to the Shooting mode.



Example: Selecting a White Balance option in the P mode

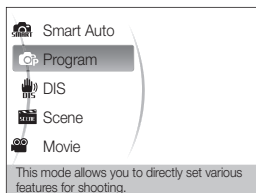

- 1 In Shooting mode, press **[MODE]**.
- 2 Press **[DISP]** or **[**] to scroll to **Program**, and then press **[OK]**.

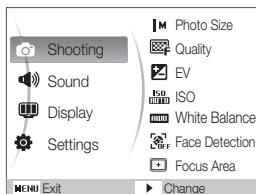

- 3 Press **[MENU]**.



- 4 Press **[DISP]** or **[**] to scroll to **Shooting**, and then press **[**] or **[OK]**.

- 5 Press **[DISP]** or **[**] to scroll to **White Balance**, and then press **[**] or **[OK]**.

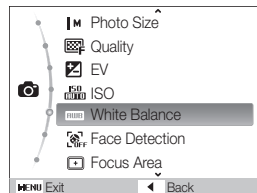

- 6 Press **[**] or **[**] to scroll to a White Balance option.

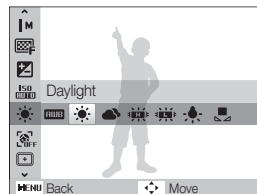

- 7 Press **[OK]**.

Setting the display and sound

Learn how to change the basic display and sound settings.

Changing the display type

Select a display type for Shooting or Playback mode. Each type displays different shooting or playback information.

Press **[DISP]** repeatedly to change a display type.

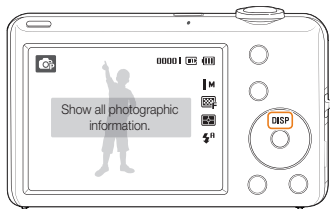

Modes	Display Type Choices
Shooting	<ul style="list-style-type: none">• Display all information about shooting• Hide information about shooting, except the available number of photos (or available recording time) and the battery icon
Playback	<ul style="list-style-type: none">• Display all information about the current photo• Hide all information about the current file• Display information about the current file, except the shooting settings and captured date

Setting the sound

Set whether your camera emits a specified sound when you operate your camera.

- 1 In Shooting or Playback mode, press **[MENU]**.
- 2 Select **Sound** → **Beep Sound** → an option.

Options	Description
Off	The camera does not emit any sounds.
1/2/3	The camera emits one of three sounds, depending on the option you select.

Taking photos

Learn basic actions to take photos easily and quickly in the Smart Auto mode.

- 1 In Shooting mode, press **[MODE]**.
- 2 Press **[DISP]** or  to scroll to **Smart Auto**, and then press **[OK]**.

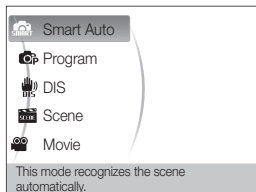

- 3 Align your subject in the frame.

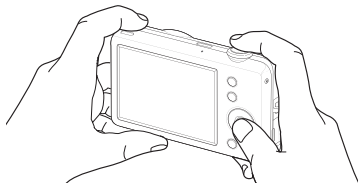

- 4 Half-press **[Shutter]** to focus.
 - A green frame means the subject in focus.
 - A red frame means the subject is out of focus.

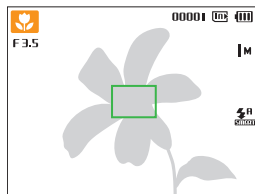

- 5 Press **[Shutter]** to take a photo.



See page 24 for tips to get clearer photos.

Zooming

You can shoot close-up photos by adjusting the zoom. Your camera has a 5X optical zoom and 3X digital zoom. By using both, you can zoom in up to 15 times.

Rotate **[Zoom]** right to zoom in on your subject. Rotate **[Zoom]** left to zoom out.

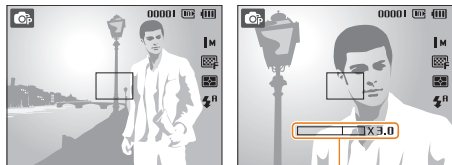

Zoom ratio

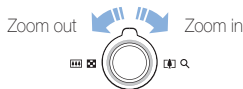

Digital zoom



If the zoom indicator is in the digital range, your camera is using the digital zoom. The picture quality may deteriorate when you use the digital zoom.

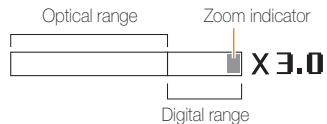

- The Digital zoom is not available with the Face Detection options, Smart Filter effect or Tracking AF option.
- It may take longer to save a photo when you are using the digital zoom.

Tips for getting a clearer photo

Holding your camera correctly

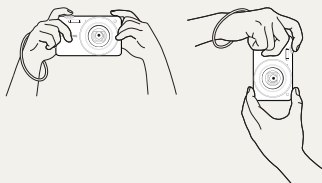

Make sure nothing is blocking the lens.

Half-pressing the shutter button

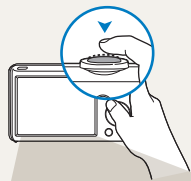

Half-press **[Shutter]** and adjust the focus. The camera adjusts the focus and exposure automatically.

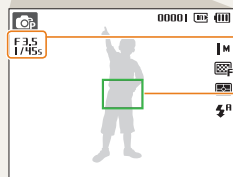

The camera sets the aperture value and shutter speed automatically.

Focus frame

- Press **[Shutter]** to take the photo if the focus frame appears in green.
- Change the composition and half-press **[Shutter]** again if the focus frame appears in red.

Reducing camera shake



Select the  mode to reduce camera shake digitally. (p. 31)

When is displayed

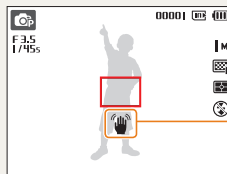

Camera shake

When shooting in the dark, avoid setting the flash option to **Slow Sync** or **Off**. The aperture remains open longer and it may be harder to hold the camera still.

- Use a tripod or set the flash option to **Fill in**. (p. 38)
- Set ISO speed options. (p. 39)

Preventing your subject from being out of focus

It may be difficult to get your subject in focus when:

- there is little contrast between the subject and background (for example, when your subject is wearing clothing that is similar in color to the background)
- the light source behind the subject is too bright
- the subject is shiny or reflective
- the subject includes horizontal patterns, such as blinds
- the subject is not positioned in the center of the frame



Use the focus lock

Half-press **[Shutter]** to focus. When the subject is in focus, you can reposition the frame to change the composition.

When you are ready, press **[Shutter]** to take your photo.

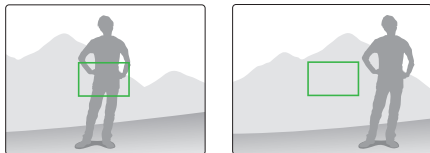

- When you take photos in low light



Turn on the flash.
(p. 38)

- When subjects are moving fast

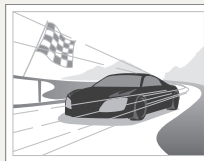

Use the continuous
or motion capture
function. (p. 49)

Extended functions

Learn how to take a photo by selecting a mode and how to record a video or voice memo.

Shooting modes	27
Using the Smart Auto mode	27
Using the Scene mode	28
Using the Beauty Shot mode	29
Using the frame guide	30
Using the Night mode	30
Using the DIS mode	31
Using the Program mode	32
Recording a video	32
Recording voice memos	34
Recording a voice memo	34
Adding a voice memo to a photo	34

Shooting modes

Take photos or record videos by selecting the best shooting mode for the conditions.

Using the Smart Auto mode

In this mode, your camera automatically chooses the appropriate camera settings based on the type of scene it detects.

Smart Auto Mode is helpful if you are not familiar with the camera settings for various scenes.



1 In Shooting mode, press [**MODE**].

2 Select **Smart Auto**.

3 Align your subject in the frame.

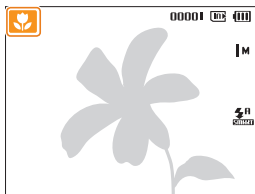
- The camera selects a scene automatically. An appropriate scene mode icon appears at the top left of the screen. The icons are listed below.





Icon	Description
	Appears when taking photos of landscapes.
	Appears when taking photos with bright white backgrounds.

Icon	Description
	Appears when taking photos of landscapes at night. This is available only when the flash is off.
	Appears when taking portraits at night.
	Appears when taking photos of landscapes with backlighting.
	Appears when taking portraits with backlighting.
	Appears when taking portraits.
	Appears when taking close-up photos of objects.
	Appears when taking close-up photos of text.
	Appears when taking photos of sunsets.
	Appears when taking photos of clear skies.
	Appears when taking photos of forested areas.
	Appears when taking close-up photos of colorful subjects.
	Appears when the camera is stable (on a tripod, for example) and the subject is motionless for a period of time. This is available only when you are shooting in the dark.
	Appears when taking photos of actively moving subjects.

4 Half-press [**Shutter**] to focus.

5 Press [**Shutter**] to take the photo.



- If the camera does not recognize a proper scene mode,  appears and the camera uses default settings.
- Even if it detects a face, the camera may not select a portrait mode depending on the subject's position or lighting.
- The camera may not select the correct scene depending on the shooting conditions, such as camera shake, lighting, and distance to the subject.
- Even if you use a tripod, the camera may not detect the  mode depending on the subject's movement.
- In  mode, the camera consumes more battery power, because it changes settings often to select appropriate scenes.

Using the Scene mode

Take a photo with options preset for a specific scene.

1 In Shooting mode, press [**MODE**].

2 Select **Scene** → a scene.

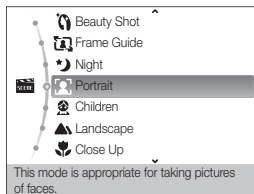

- To change the scene mode, press [**MODE**], and then select **Scene** → a scene.
- For the Beauty Shot mode, see "Using the Beauty Shot mode" on page 29.
- For the Frame Guide mode, see "Using the frame guide" on page 30.
- For the Night mode, see "Using the Night mode" on page 30.

3 Align your subject in the frame, and then half-press [**Shutter**] to focus.

4 Press [**Shutter**] to take the photo.

Using the Beauty Shot mode

Take a photo of a person with options to hide facial imperfections.

- 1 In Shooting mode, press [**MODE**].
- 2 Select **Scene** → **Beauty Shot**.
- 3 To make the subject's skin tone appear lighter (face only), press [**MENU**], and then go to Step 4. To hide facial imperfections, press [**MENU**], and then go to Step 5.
- 4 Select **Shooting** → **Face Tone** → an option.
 - Select a higher setting to make skin tone appear lighter.

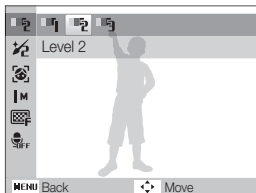

- 5 To hide facial imperfections, press [**MENU**].

- 6 Select **Shooting** → **Face Retouch** → an option.
 - Select a higher setting to hide a greater number of imperfections.

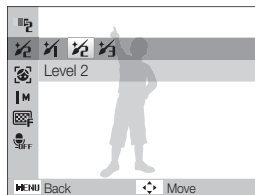

- 7 Align your subject in the frame, and then half-press [**Shutter**] to focus.
- 8 Press [**Shutter**] to take the photo.



The focus distance will be set to **Auto Macro**.

Using the frame guide

When you want another person to take a photo of you, you can compose the scene with the frame guide feature. The frame guide helps the other person take a photo of you by showing part of the pre-composed scene.

- 1 In Shooting mode, press [**MODE**].
- 2 Select **Scene** → **Frame Guide**.
- 3 Align your subject in the frame, and then press [**Shutter**].
 - Transparent guides appear on the left and right of the frame.

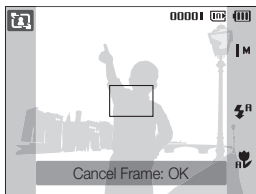

- 4 Ask another person to take a photo.
 - The person aligns the subject in the frame using the guides, and then presses [**Shutter**] to take the photo.
- 5 To cancel the guides, press [**OK**].

Using the Night mode

Use the Night mode to take a photo with options for preset for shooting at night. Use a tripod to prevent your camera from shaking.

- 1 In Shooting mode, press [**MODE**].
- 2 Select **Scene** → **Night**.
- 3 Align your subject in the frame, and then half-press [**Shutter**] to focus.
- 4 Press [**Shutter**] to take the photo.

Adjusting the exposure in the Night mode

In Night mode, you can use a slow shutter speed to extend the time until the shutter closes. Increase the aperture value to prevent overexposure.

- 1 In Shooting mode, press [**MODE**].
- 2 Select **Scene** → **Night**.
- 3 Press [**MENU**].
- 4 Select **Shooting** → **Long Time Shutter**.

5 Select the aperture value or shutter speed.



6 Select an option.

- If you select **Auto**, the camera adjusts the aperture value or shutter speed automatically.

7 Align your subject in the frame, and then half-press [Shutter] to focus.

8 Press [Shutter] to take the photo.



Use a tripod to prevent your photos from blurring.

Using the DIS mode

Reduce camera shake and prevent blurred photos with Digital Image Stabilization functions.

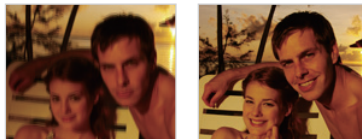

Before correction

After correction

- 1 In Shooting mode, press [MODE].
- 2 Select **DIS**.
- 3 Align your subject in the frame, and then half-press [Shutter] to focus.
- 4 Press [Shutter] to take the photo.



- The digital zoom does not work in this mode.
- If your subject is moving rapidly, the photo may be blurry.
- The DIS function may not work where the lighting is brighter than that of a fluorescent lamp.

Using the Program mode

In the Program mode, you can set various options except the shutter speed and aperture value, which the camera sets automatically.

- 1 In Shooting mode, press [**MODE**].
- 2 Select **Program**.
- 3 Set options.
(For a list of options, refer to "Shooting options".)

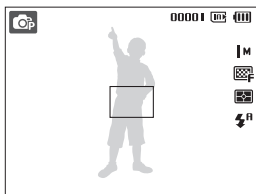

- 4 Align your subject in the frame, and then half-press [**Shutter**] to focus.
- 5 Press [**Shutter**] to take the photo.

Recording a video

In Movie mode, you can record high-definition videos in 1280 X 720 HQ resolution. You can record up to 2 GB (approximately 9 minutes) at 1280 X 720 HQ resolution and the camera saves recorded videos as MJPEG files.





Some memory cards may not support high definition recording. If this occurs, set a lower resolution. (p. 36)

- 1 In Shooting mode, press [**MODE**].
- 2 Select **Movie**.
- 3 Press [**MENU**].
- 4 Select **Movie** → **Frame Rate** → a frame rate (the number of frames per second).
 - As the frame rate increases, action appears more natural, but the file size also increases.





- **60 FPS** is available only when you set the video resolution to 320 X 240.
- The zoom ratio and angle of view might decrease when shooting video.
- **24 FPS** is available only when you set the video resolution to 1280 X 720 HQ.

- 5 Press **[MENU]**.
- 6 Select **Movie** → **Voice** → a sound option.

Option	Description
	On: Record a video with sound.
	Off: Record a video without sound.
	Zoom Mute: The camera stops recording sound temporarily when you use the zoom.

- 7 Press **[MENU]**.
- 8 Select **Movie** → **Stabilizer** → a stabilizer option.

Option	Description
	Off: Record a video with the image stabilization function turned off.
	On: Record a video with the image stabilization function turned on to prevent your video from blurring.

- 9 Set other options as desired.
(For options, refer to “Shooting options”.)
- 10 Press **[Shutter]** to start recording.
- 11 Press **[Shutter]** again to stop recording.

To pause recording

The camera allows you to pause a video temporarily while recording. With this function, you can record several scenes as a single video.

Press **[OK]** to pause while recording. Press it again to resume.

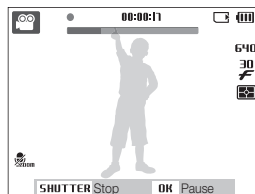

Recording voice memos



Learn how to record a voice memo that you can play back at any time. You can add a voice memo to a photo as a short reminder of shooting conditions.



You will get the best sound quality when recording 16 inches (40 cm.) away from the camera.

Recording a voice memo

- 1 In Shooting mode, press [**MENU**].
- 2 Select **Shooting** → **Voice** → **Record**.
- 3 Press [**Shutter**] to record.
 - You can record voice memos of up to 10 hours in length.
 - Press [**OK**] to pause or resume recording.



- 4 Press [**Shutter**] to stop.
 - Press [**Shutter**] again to record a new voice memo.
- 5 Press [**MENU**] to switch to Shooting mode.

Adding a voice memo to a photo

- 1 In Shooting mode, press [**MENU**].
- 2 Select **Shooting** → **Voice** → **Memo**.
- 3 Align your subject in the frame, and then take a photo.
 - Begin recording the voice memo right after taking the photo.
- 4 Record a short voice memo (10 seconds maximum).
 - Press [**Shutter**] to stop recording a voice memo before the 10 seconds are up.



You cannot add voice memos to photos if you set **Continuous Motion Capture**, or **AEB** options.

Shooting options

Learn about the options you can set in shooting mode.

Selecting a resolution and quality	36	Adjusting brightness and color	46
Selecting a resolution	36	Adjusting the exposure manually (EV)	46
Selecting image quality	36	Compensating for backlighting (ACB)	46
Using the timer	37	Changing the metering option	47
Shooting in the dark	38	Selecting a light source (White balance) ...	47
Preventing red-eye	38	Using burst modes	49
Using the flash	38	Improving your photos	50
Adjusting the ISO speed	39	Applying photo styles	50
Changing the camera's focus	40	Applying smart filter effects	51
Using macro	40	Adjusting your photos	52
Using auto focus	40		
Using tracking auto focus	41		
Adjusting the focus area	42		
Using face detection	43		
Detecting faces	43		
Taking a self-portrait shot	44		
Taking a smile shot	44		
Detecting eye blinking	45		

Selecting a resolution and quality

Learn how to change the image resolution and quality settings.

Selecting a resolution

As you increase the resolution, your photo or video will include more pixels, so it can be printed on larger paper or displayed on a larger screen. When you use a high resolution, the file size also increases.

When taking a photo

- 1 In Shooting mode, press **[MENU]**.
- 2 Select **Shooting** → **Photo Size** → an option.

Option	Description
14M	4320 X 3240: Print on A1 paper (23" x 34").
12M	4224 X 2816: Print on A1 paper (23" x 34") in wide ratio (3:2).
12M	4000 X 3000: Print on A1 paper (22" x 34").
11M	4224 X 2376: Print on A2 paper (17" x 22") in panorama ratio (16:9) or play back on an HDTV.
8M	3264 X 2448: Print on A3 paper (17" x 11").
5M	2592 X 1944: Print on A4 paper (8 1/2" x 11").
2M	1920 X 1080: Print on A5 paper in panorama ratio (16:9) or play back on an HDTV (5 3/4" x 8 1/2").
1M	1024 X 768: Attach to email.

The paper sizes in inches are approximate.

When recording a video



- 1 In the  mode, press **[MENU]**.
- 2 Select **Movie** → **Movie Size** → an option.

Option	Description
1280 HD	1280 X 720 HQ: For high-quality play back on an HDTV.
640	640 X 480: For play back on a standard, analog TV.
320	320 X 240: To post on a web page.

Selecting image quality

The camera compresses and saves the photos you take in JPEG format. Higher quality images result in larger file sizes.

- 1 In Shooting mode, press **[MENU]**.
- 2 Select **Shooting** → **Quality** → an option.

Option	Description
	Super Fine: Capture photos in super high quality.
	Fine: Capture photos in high quality.
	Normal: Capture photos in normal quality.

The options may differ depending on the shooting mode.

Using the timer



Learn how to set the timer to delay shooting.

1 In Shooting mode, press [⏻].

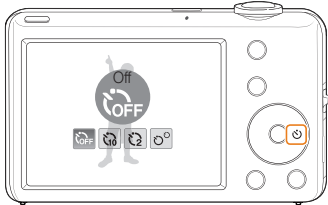

2 Select an option.

Option	Description
	Off: The timer is not active.
	10 Sec: Takes a photo in 10 seconds.
	2 Sec: Takes a photo in 2 seconds.
	Double: Takes a photo in 10 seconds, and then takes another 2 seconds later.

The options may differ depending on the shooting mode.

3 Press [Shutter] to start the timer.

- The AF-assist light/timer lamp blinks. The camera automatically takes a photo at the specified time.



- Press [⏻] to cancel the timer.
- Depending on the face detection option you have selected, the timer function or some timer options may not be available.
- When you set burst options, you cannot use the timer function.

Shooting in the dark

Learn how to take photos at night or in low light conditions.

Preventing red-eye

If the flash fires when you take a photo of a person in the dark, a red glow may appear in the person's eyes. To prevent this, select **Red-eye** or **Red-eye Fix**. Refer to flash options in "Using the flash."





Using the flash



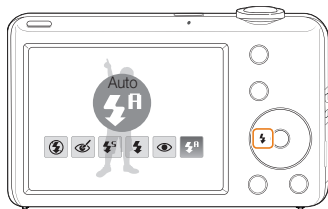



Use the flash when taking photos in the dark or when you need more light in your photos.

1 In Shooting mode, press .



2 Select an option.

Option	Description
	Off: <ul style="list-style-type: none">The flash does not fire.The camera displays the camera shake warning () when you are shooting in low light.
	Auto: The camera selects a proper flash setting for the scene it detects in the  mode.

Option	Description
	<p>Red-eye Fix*:</p> <ul style="list-style-type: none"> The flash fires twice when the subject or background is dark. The subject should not move until the flash fires a second time. The camera corrects red-eyes through its advanced software analysis.
	<p>Slow Sync:</p> <ul style="list-style-type: none"> The flash fires and the shutter stays open longer. This option is recommended when you want to capture ambient light to reveal more details in the background. Use a tripod to prevent your photos from blurring. The camera will display the shake warning () when you are shooting in low light.
	<p>Fill in:</p> <ul style="list-style-type: none"> The flash always fires. The camera adjusts light intensity automatically.
	<p>Red-eye*:</p> <ul style="list-style-type: none"> The flash fires when the subject or background is dark. The camera reduces red-eyes.
	<p>Auto: The flash fires automatically when the subject or background is dark.</p>

The options may differ depending on the shooting mode.



- Flash options are not available if you set **Continuous**, **Motion Capture**, **AEB** options or select **Self-Portrait** or **Blink Detection**.
- Make sure that your subjects are within the recommended distance from the flash. (p. 95)
- If light from the flash is reflected or there is a large amount of dust in the air, tiny spots may appear in your photo.

Adjusting the ISO speed

The ISO speed is the measure of a film's sensitivity to light as defined by the International Organization for Standardization (ISO). The higher ISO speed you select, the more sensitive to light your camera becomes. With a higher ISO speed, you can get a better photo without using the flash.

- In Shooting mode, press **[MENU]**.
- Select **Shooting** → **ISO** → an option.
 - Select  to use an appropriate ISO speed based on the brightness of the subject and lighting.



- The higher ISO speed you select, the more image noise you may get.
- When you select **Motion Capture**, the camera sets the ISO speed to **Auto**.
- When the  is selected, the image size is fixed to under 5M.

Changing the camera's focus

Learn how to adjust the camera's focus.

Using macro

Use macro to take close-up photos of subjects, such as flowers or insects. Refer to macro options in "Using auto focus".



- Try to hold the camera very still to prevent blurry photos.
- Turn off the flash if the distance to the subject is less than 16 in. (40 cm).



Using auto focus

To take sharp photos, select the appropriate focus according to your distance from the subject.

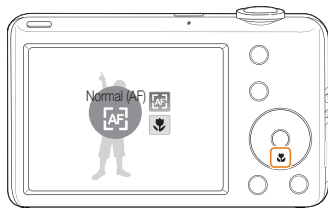
1 In Shooting mode, press .



2 Select an option.

Option	Description
	Normal (AF): Focus on a subject farther than 32 in. (80 cm) from the camera. Farther than 39 in. (100 cm) when using the zoom.
	Macro: Focus on a subject 2 to 32 in. (5 - 80 cm) from the camera. 39 in. to 59 in. (100 cm - 150 cm) when using the zoom.
	Auto Macro: Focus on a subject farther than 2 in. (5 cm). Farther than 39 in. (100 cm) when using the zoom.

The options may differ depending on the shooting mode.

Using tracking auto focus

Tracking AF allows you to track and auto focus on your subject, even when you are moving.

- 1 In Shooting mode, press **[MENU]**.
- 2 Select **Shooting** → **Focus Area** → **Tracking AF**.
- 3 Focus on the subject you want to track, and then press **[OK]**.
 - A focus frame appears on the subject and follows the subject as you move the camera.

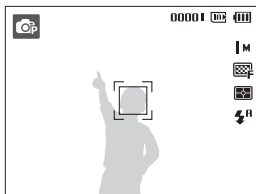

- The white frame means that your camera is tracking the subject.
- The green frame means that your subject is in focus when you half-press **[Shutter]**.



- If you do not touch any area on the screen, the focus frame will appear in the center of the screen.
- Tracking a subject may fail when:
 - the subject is too small or the subject moves excessively
 - the subject is backlit or you are shooting in a dark place
 - colors or patterns on the subject and the background are the same
 - the camera shakes excessively



In these cases, the focus frame appears as a white, single-line frame ().

- If the camera fails to track the subject, you must reselect the subject to track.
- If the camera fails to fix the focus, the focus frame changes to a red, single-line frame ().
- If you use this function, you cannot set self timer options, Face Detection options, Photo Style options and Smart Filter options.

Adjusting the focus area

You can get clearer photos by selecting an appropriate focus area according to your subject's location in the scene.

- 1 In Shooting mode, press [**MENU**].
- 2 Select **Shooting** → **Focus Area** → an option.

Option	Description
	Center AF: Focus on the center. Suitable when subjects are located in the center.
	Multi AF: Focus on one or more of 9 possible areas.
	Tracking AF: Focus on and track the subject. (p. 41)

The options may differ depending on the shooting mode.

Using face detection



If you use face detection options, your camera can automatically detect a human face. When you focus on a human face, the camera adjusts the exposure automatically. Take photos quickly and easily by using **Blink Detection** to detect closed eyes or **Smile Shot** to capture a smiling face.



- In some scene modes, face detection is unavailable.
- Face detection may not be effective when:
 - the subject is far from the camera (The focus frame will appear orange for **Smile Shot** and **Blink Detection**.)
 - it is too bright or too dark
 - the subject is not facing the camera
 - the subject is wearing sunglasses or a mask
 - the subject is in backlit or the lighting condition is unstable
 - the subject's facial expression changes remarkably
- Face detection is not available when using a photo style, smart filter effect, or image adjustment option or when used with **Tracking AF**.
- Face detection is not available when you are using the digital zoom.
- Depending on the face detection option you selected, the timer or some timer options are not available.
- Depending on the face detection option you selected, some burst options are not available.

Detecting faces

Your camera automatically detects human faces (up to 10 faces in one scene).

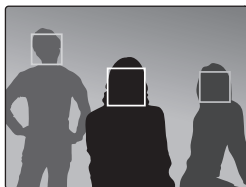

- 1 In Shooting mode, press [**MENU**].
- 2 Select **Shooting** → **Face Detection** → **Normal**.
 - The nearest face appears in a white focus frame and the rest of the faces appear in gray focus frames.



The closer you are to the subject, the quicker your camera detects faces.

Taking a self-portrait shot

Take photos of yourself. The camera automatically sets the photo distance to close-up and emits a beep when ready.

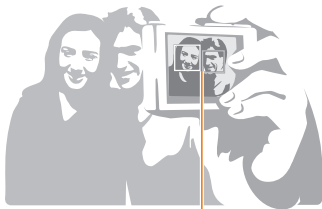

When faces are located in the center, the camera beeps rapidly.

- 1 In Shooting mode, press [**MENU**].
- 2 Select **Shooting** → **Face Detection** → **Self-Portrait**.
- 3 When you hear a beep, press [**Shutter**].



If you turn **Volume** off in the sound settings, the camera will not emit a beep. (p. 78)

Taking a smile shot

The camera automatically releases the shutter when it detects a smiling face.

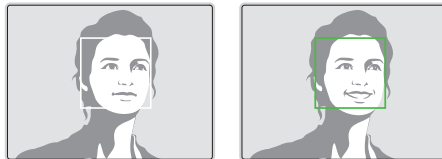

- 1 In Shooting mode, press [**MENU**].
- 2 Select **Shooting** → **Face Detection** → **Smile Shot**.
 - When your subject smiles broadly, your camera can detect the smile more easily.

Detecting eye blinking

If your camera detects closed eyes, it automatically takes two photos in succession.

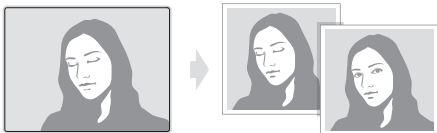

1 In Shooting mode, press **[MENU]**.

2 Select **Shooting** → **Face Detection** → **Blink Detection**.



- Hold your camera still while **"Capturing"** is displayed on the screen.
- When blink detection fails, the **"Picture taken with eyes closed."** message appears. Take another photo.

Adjusting brightness and color

Learn how to adjust the brightness and color for better image quality.

Adjusting the exposure manually

(EV)   

Depending on the intensity of the ambient light, your photos may be too bright or dark. In these cases, you can adjust the exposure to get a better photo.



Darker (-)



Neutral (0)



Brighter (+)

- 1 In Shooting mode, press **[MENU]**.
- 2 Select **Shooting** or **Movie** → **EV**.
- 3 Select a value to adjust the exposure.



- Once you adjust the exposure, the setting will remain the same. You may need to change the exposure value later to avoid overexposure or underexposure.
- If you cannot decide on an appropriate exposure, select **AEB** (Auto Exposure Bracket). The camera takes three photos, each with a different exposure: normal, underexposed, and overexposed. (p. 49)

Compensating for backlighting (ACB)

When the light source is behind your subject or there is high contrast between your subject and the background, your subject is likely to appear dark in the photo. If this occurs, turn the Auto Contrast Balance (ACB) option on.



Without ACB



With ACB

- 1 In Shooting mode, press **[MENU]**.
- 2 Select **Shooting** → **ACB** → an option.

Option	Description
 Off	Off: ACB is off.
 On	On: ACB is on.





The ACB feature is not available when you set **Continuous Motion Capture**, **AEB** options.

Changing the metering option

The metering mode refers to the way in which a camera measures the quantity of light. The brightness and lighting of your photos will vary depending on the metering mode you select.

- 1 In Shooting mode, press **[MENU]**.
- 2 Select **Shooting or Movie** → **Metering** → an option.

Option	Description
	<p>Multi:</p> <ul style="list-style-type: none"> • Your camera divides the scene into several areas, and then measures the light intensity of each area. • Suitable for general photos.
	<p>Spot:</p> <ul style="list-style-type: none"> • Your camera measures only the light intensity of the very center of the frame. • If a subject is not in the center of the scene, your photo may be improperly exposed. • Suitable for a subject with backlighting.
	<p>Center-weighted:</p> <ul style="list-style-type: none"> • Your camera averages the meter reading of the entire frame with emphasis placed on the center. • Suitable for photos with subjects in the center of the frame.

Selecting a light source (White balance)

The color of your photo depends on the type and quality of the light source. If you want the color of your photo to be realistic, select a white balance setting that matches the lighting conditions, such as Daylight, Cloudy, or Tungsten.



 (Auto WB)



 (Daylight)









 (Cloudy)



 (Tungsten)

- 1 In Shooting mode, press [**MENU**].
- 2 Select **Shooting** or **Movie** → **White Balance** → an option.

Icon	Description
	Auto WB: Automatically sets the white balance based on the lighting conditions.
	Daylight: Select when taking outdoor photos on a sunny day.
	Cloudy: Select when taking outdoor photos on a cloudy day or in shadows.
	Fluorescent_H: Select when shooting under a daylight fluorescent or three-way fluorescent light.
	Fluorescent_L: Select when shooting under white fluorescent light.
	Tungsten: Select when taking indoor photos under incandescent bulbs or halogen lamps.
	Custom Set: Use white balance settings you defined. (See procedure at right.)

Defining your own white balance

- 1 In Shooting mode, press [**MENU**].
- 2 Select **Shooting** or **Movie** → **White Balance** → **Custom Set**.
- 3 Aim the lens at a piece of white paper.

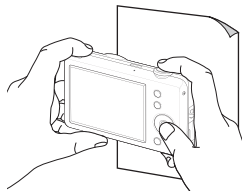

- 4 Press [**Shutter**].





Using burst modes

It can be difficult to take photos of fast-moving subjects or capture natural facial expressions and gestures of your subjects in photos. In these cases, select one of the burst modes to take multiple pictures rapidly.



- You can use the flash, timer, ACB, and Smart Filter only when you select **Single**.
- When you select **Motion Capture**, the resolution is set to VGA and the ISO speed is set to **Auto**.
- Depending on the face detection option you selected, some burst options are not available.

- 1 In Shooting mode, press **[MENU]**.
- 2 Select **Shooting** → **Drive** → an option.

Option	Description
	Single: Take a single photo.
	Continuous: <ul style="list-style-type: none">• While you are pressing [Shutter], the camera takes photos continuously.• Maximum of 3 photos
	Motion Capture: <ul style="list-style-type: none">• While you are pressing [Shutter], the camera takes VGA photos (6 photos per second; maximum of 30 photos).
	AEB: <ul style="list-style-type: none">• Take 3 photos with different exposures: normal, underexposed, and overexposed.• Use a tripod to prevent blurry photos.

The options may differ depending on the shooting mode.

Improving your photos

Learn how to improve your photos by applying photo styles, colors, or smart filter effects, or make some adjustments.

Applying photo styles

Apply a different photo style to your photos, such as Soft, Vivid, or Forest.



Soft



Vivid



Forest

- 1 In Shooting mode, press **[MENU]**.
- 2 Select **Shooting** or **Movie** → **Photo Style Selector** → an option.
 - Select **Custom RGB** to define your own RGB tone.



If you apply photo styles, you cannot set face detection, smart filter, or image adjustment.

Defining your own RGB tone

- 1 In Shooting mode, press **[MENU]**.
- 2 Select **Shooting** or **Movie** → **Photo Style Selector** → **Custom RGB**.
- 3 Select a color (R: Red, G: Green, B: Blue).

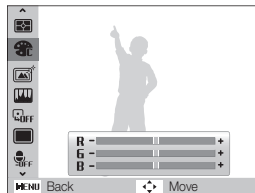

- 4 Adjust the amount of the selected color.
(-: less or +: more)

Applying smart filter effects

Apply various filter effects to your photos to create unique images.



Miniature



Vignetting





Fish-eye



Sketch

- 1 In Shooting mode, press **[MENU]**.
- 2 Select **Shooting** or **Movie** → **Smart Filter**.
- 3 Select an effect.

Option	Description
	Normal: No effect.
	Miniature: Apply a tilt-shift effect to make the subject appear in miniature.
	Vignetting: Apply the retro-looking colors, high contrast, and strong vignette effect of Lomo cameras.
	Fish-eye: Distort close objects to imitate the visual effect of a fisheye lens.
	Sketch: Apply a pen sketch effect.
	Defog: Make a photo clearer.



- If you select **Miniature** when you are recording a video, the camera will not record sound.
- When you apply a smart filter effect while you are recording a video, the recording speed will be set to $\frac{15}{1}$ and the recording resolution will be set to less than **640**.
- If you set Smart Filter effects, you cannot use the Face Detection options, photo style options, ACB, burst options, Image Adjustment options or Tracking AF.

Adjusting your photos

Adjust the contrast, sharpness, and saturation of your photos.

- 1 In Shooting mode, press [**MENU**].
- 2 Select **Shooting** → **Image Adjust**.
- 3 Select an adjustment option.
 - Contrast
 - Sharpness
 - Saturation
- 4 Select a value to adjust the selected item.

Contrast option	Description
-	Decrease the color and brightness.
+	Increase the color and brightness.

Sharpness option	Description
-	Soften the edges on your photos. Suitable for editing the photos on your computer.
+	Sharpen the edges to improve the clarity of your photos. This may also increase the noise on your photos.

Saturation option	Description
-	Decrease the saturation.
+	Increase the saturation.



- Select **0** if you do not want to apply any effects (suitable for printing).
- If you use this function, you cannot set the photo style and smart filter effects.

Playback/Editing

Learn how to play back photos, videos, or voice memos and edit photos or videos. You will also learn how to connect your camera to your photo printer or TV.

Playing back	54	Transferring files to your Windows computer ...	68
Starting Playback mode	54	Transferring files using Intelli-studio	70
Viewing photos	58	Transferring files by connecting the camera as a removable disk	72
Playing a video	59	Disconnecting the camera (for Windows XP) ...	73
Playing voice memos	60	Transferring files to your Mac computer ...	74
Editing a photo	62	Printing photos with a PictBridge photo printer	75
Resizing photos	62		
Rotating a photo	62		
Applying photo styles	63		
Applying smart filter effects	64		
Correcting exposure problems	65		
Creating a print order (DPOF)	66		
Viewing files on a TV	67		

Playing back

Learn how to play back photos, videos, or voice memos, and manage files.

Starting Playback mode

View photos or play videos and voice memos stored in your camera.

- 1 Press [▶].
 - The most recent file will be displayed.
 - If the camera is off, it will turn on and display the most recent file.
- 2 Press [⚡] or [☺] to scroll through files.
 - Press and hold to scroll through files quickly.



- If you want to view files stored in the internal memory, remove your memory card.
- The camera will not properly play back files that are too large or those taken with cameras from other manufacturers.

Display in Playback mode

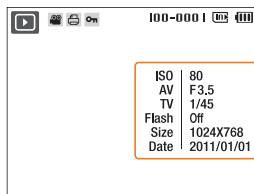

Icon	Description
	Photo includes a voice memo
	Video file
	Print order has been set (DPOF)
	Protected file
100-0001	Folder name – File name



To display file information on the screen, press [DISP].

Viewing files by category in Smart Album

View and manage files by categories, such as date, file type, or week.

- 1 In Playback mode, rotate [Zoom] left.
- 2 Press [MENU].
- 3 Select a category.

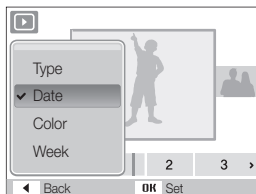

Option	Description
Type	View files by file type.
Date	View files by the date they were saved.
Color	View files by the dominant color of the image.
Week	View files by the weekday they were saved.



- When selecting **Color, Etc** is shown if color is not extracted.
- It may take some time for the camera to open Smart Album or to change the category and recognize files.

- 4 Press [⏪] or [⏩] to scroll through files.
 - Press and hold to scroll through files quickly.
- 5 Press [OK] to return to the normal view.

Viewing files as thumbnails

Scan thumbnails of files.



In Playback mode, rotate **[Zoom]** left to display 9 or 20 thumbnails. Rotate **[Zoom]** right to return to the previous mode.

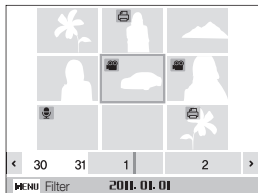

To	Do this
Scroll through files	Press [DISP] , [↓] , [↶] or [↷] .
Delete files	Press [Fn] , and then select Yes .

Protecting files

Protect your files from accidental deletion.

- 1 In Playback mode, press **[MENU]**.
- 2 Select **File Options** → **Protect** → **Select**.
- 3 To protect all files, select **All** → **Lock**.
- 4 To protect a single file, select the file you want to protect, and then press **[OK]**.
 - Press **[OK]** again to cancel your selection.

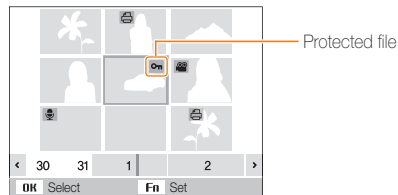

- 5 Repeat Step 4 to protect additional files individually.
- 6 Press **[Fn]**.



You cannot delete or rotate a protected file.

Deleting files

Delete single files or all files at once. You cannot delete protected files.

To delete a single file,

- 1 In Playback mode, select a file, and then press [**Fn**].
- 2 Select **Yes** to delete the file.

To delete multiple files,

- 1 In Playback mode, press [**Fn**].
- 2 Select **Multiple Delete**.
- 3 Select the files you want to delete, and then press [**OK**].
 - Press [**OK**] again to cancel your selection.
- 4 Press [**Fn**].
- 5 Select **Yes**.

To delete all files,

- 1 In Playback mode, press [**MENU**].
- 2 Select **File Options** → **Delete** → **All** → **Yes**.

Copying files to the memory card

You can copy files from the internal memory to a memory card.

- 1 In Playback mode, press [**MENU**].
- 2 Select **File Options** → **Copy to Card**.
- 3 Select **Yes** to copy files.

Viewing photos

Zoom in on part of a photo or view photos in a slide show.

Enlarging a photo

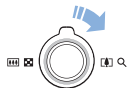

In Playback mode, rotate **[Zoom]** right to enlarge a photo. Rotate **[Zoom]** left to shrink a photo.

The enlarged area and zoom ratio are indicated on the top of the screen. The maximum zoom ratio may vary depending on the resolution.

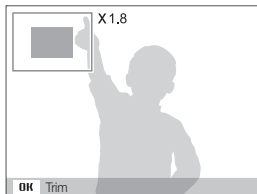

To	Do this
Move the enlarged area	Press [DISP] , [↓] , [↶] or [↷] .
Trim the enlarged photo	Press [OK] . The trimmed photo is saved as a new file.

Starting a slide show

You can apply effects and add audio to your slide show.

- 1 In Playback mode, press **[MENU]**.
- 2 Select **Multi Slide Show**.
- 3 Select a slide show effect option.
 - Skip to step 5 to start a slide show with no effects.

Option	Description
Start	Set whether or not to repeat the slide show. (Play, Repeat)
Images	Select the photos you want to view as a slide show. <ul style="list-style-type: none"> • All: View all photos in a slide show. • Date: View photos captured on a specific date in a slide show. • Select: View selected photos in a slide show.
Interval	<ul style="list-style-type: none"> • Set the interval between photos. • This is available when you select Off in the Effect option. See below.
Music	Select a background audio.
Effect	<ul style="list-style-type: none"> • Select a transition effect. • Select Off for no effects.

4 Set the slide show effect.

5 Select **Start** → **Play**.

- To loop the slide show, select **Repeat**.
- Press [**OK**] to pause or resume the slide show.



To stop the slide show and switch to Playback mode, press [**OK**], and then [**⏮**] or [**⏭**].

Playing a video

You can play a video, capture an image from a video, or crop a video.

1 In Playback mode, select a video, and then press [**OK**].



2 Use the following buttons to control playback.

Press	To
[⏮]	Scan backward.
[OK]	Pause or resume playback.
[⏭]	Scan forward.
[Zoom] left or right	Adjust the volume level.

Trimming a video during playback

- 1 Press **[OK]** at the point where you want the new video to begin, and then rotate **[Zoom]** right.
- 2 Press **[OK]** to resume playback.
- 3 Press **[OK]** at the point where you want the new video to end, and then rotate **[Zoom]** right.
- 4 Select **Yes**.



- The original video must be at least 10 seconds long.
- The camera saves the edited video as a new file.

Capturing an image during playback

- 1 Press **[OK]** at the point where you want to save a still image.
- 2 Press **[👉]**.



A captured image has the same resolution as the original video file and is saved as a new file.

Playing voice memos

Playing a voice memo

- 1 In Playback mode, select a voice memo, and then press **[OK]**.
- 2 Use the following buttons to control playback.

Press	To
[⏮]	Scan backward.
[OK]	Pause or resume playback.
[⏭]	Scan forward.
[👉]	Stop playback.
[Zoom] left or right	Adjust the volume level.

Adding a voice memo to a photo

- 1 In Playback mode, select a photo, and then press **[MENU]**.
- 2 Select **File Options** → **Voice memo** → **On**.
- 3 Press **[Shutter]** to record a short voice memo (10 seconds maximum).
 - Press **[Shutter]** to stop recording a voice memo.



You cannot add a voice memo to protected files.

Playing a voice memo added to a photo

- In Playback mode, select a photo that includes a voice memo, and then press **[OK]**.
- Press **[OK]** to pause or resume playback.

Editing a photo

Perform photo editing tasks, such as resizing, rotating, eliminating red-eyes, and adjusting brightness, contrast, or saturation.

- The camera saves edited photos as new files.
- When you edit photos, the camera will automatically convert them to a lower resolution. Photos that you rotate or resize manually are not automatically converted to a lower resolution.

Resizing photos

- 1 In Playback mode, select a photo, and then press **[MENU]**.
- 2 Select **Edit** → **Resize** → an option.
 - Select  to save the photo as a start image. (p. 78)

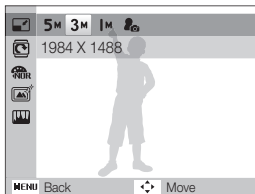

- Available options differ depending on the size of the selected photo.

Rotating a photo

- 1 In Playback mode, select a photo, and then press **[MENU]**.
- 2 Select **Edit** → **Rotate** → an option.

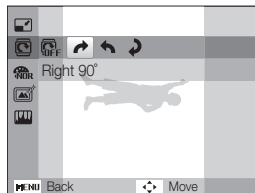

- The rotated photo will be saved as the same file, not a new file.

Applying photo styles

Apply a different photo style to the photo, such as Soft, Vivid, or Forest.



Soft



Vivid



Forest

- 1 In Playback mode, select a photo, and then press **[MENU]**.
- 2 Select **Edit** → **Photo Style Selector** → an option.
 - Select **Custom RGB** to define your own RGB tone.

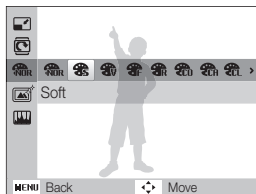

Defining your own RGB tone

- 1 In Playback mode, select a photo, and then press **[MENU]**.
- 2 Select **Edit** → **Photo Style Selector** → **Custom RGB**.
- 3 Select a color (R: Red, G: Green, B: Blue).

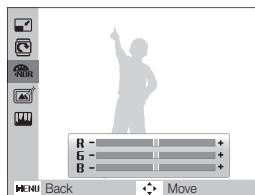

- 4 Adjust the amount of the selected color.
(-: less or +: more)

Applying smart filter effects

Apply various filter effects to your photos to create unique images.



Miniature



Vignetting



Fish-eye



Sketch

- 1 In Playback mode, select a photo and press [**MENU**].
- 2 Select **Edit** → **Smart Filter**.
- 3 Select an effect.

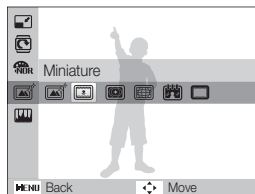

Correcting exposure problems

Adjust ACB (Auto Contrast Balance), brightness, contrast, or saturation; remove red-eye; hide facial imperfections; or add noise to the photo.

Adjusting ACB (Auto Contrast Balance)

- 1 In Playback mode, select a photo, and then press **[MENU]**.
- 2 Select **Edit** → **Image Adjust** → **ACB**.

Removing red-eye



- 1 In Playback mode, select a photo, and then press **[MENU]**.
- 2 Select **Edit** → **Image Adjust** → **Red-eye Fix**.

Hiding facial imperfections

- 1 In Playback mode, select a photo, and then press **[MENU]**.
- 2 Select **Edit** → **Image Adjust** → **Face Retouch**.

- 3 Select a level.
 - As the number increases, the face becomes clearer.

Adjusting brightness/contrast/saturation

- 1 In Playback mode, select a photo, and then press **[MENU]**.
- 2 Select **Edit** → **Image Adjust**.
- 3 Select an adjustment option.
 - : Brightness
 - : Contrast
 - : Saturation
- 4 Select a value to adjust the selected item.
(-: less or +: more)

Adding noise to the photo

- 1 In Playback mode, select a photo, and then press **[MENU]**.
- 2 Select **Edit** → **Image Adjust** → **Add Noise**.

Creating a print order (DPOF)

Select photos to be printed and set options, such as the number of copies or paper size.



- You can take the memory card to a print shop that supports DPOF (Digital Print Order Format) or you can print photos directly through a DPOF-compatible printer at home.
- Wide photos may print with the left and right edges cut off, so be aware of the dimensions of your photos.
- You cannot set the DPOF for the photos stored in the internal memory.

- 1 In Playback mode, press [**MENU**].
- 2 Select **File Options** → **DPOF** → **Standard** → an option.

Option	Description
Select	Print the selected photos.
All	Print all photos.
Reset	Reset to the default settings.

- 3 If you select **Select**, scroll to a photo, and then rotate [**Zoom**] left or right to select the number of copies. Repeat for the photos you want to print, and then press [**Fn**].
 - If you select **All**, press [**DISP**] or [OK].

- 4 Press [**MENU**].
- 5 Select **File Options** → **DPOF** → **Size** → an option.

Option	Description
Select	Specify the print size for the selected photo.
All	Specify the print size for all photos.
Reset	Reset to the default settings.

- 6 If you select **Select**, scroll to a photo, and then rotate [**Zoom**] left or right to select the print size. Repeat for the photos you want to print, and then press [**Fn**].
 - If you select **All**, press [**DISP**] or [OK].

Printing photos as thumbnails

Print photos as thumbnails to check all the photos at once.

- 1 In Playback mode, press [**MENU**].
- 2 Select **File Options** → **DPOF** → **Index** → **Yes**.



If you specify the print size, you can print photos only with DPOF 1.1-compatible printers.

Viewing files on a TV

Play back photos or videos by connecting your camera to a TV using the A/V cable.

- 1 In Shooting or Playback mode, press **[MENU]**.
- 2 Select **Settings** → **Video Out**.
- 3 Select a video signal output according to your country or region.
- 4 Turn off your camera and TV.
- 5 Connect your camera to your TV using the A/V cable.

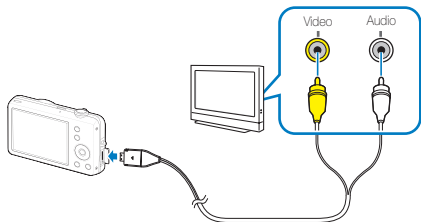

- On some TVs, digital noise may occur or part of an image may not appear.
- Images may not appear centered on the TV screen depending on your TV settings.
- You can capture photos or videos while the camera is connected to a TV.

- 6 Turn on your TV, and then select the video output mode using the TV remote control.
- 7 Turn on your camera, and then press **[▶]**.
- 8 View photos or play videos using the buttons on your camera.

Transferring files to your Windows computer

Transfer files by connecting your camera to your Windows PC.

Requirements for Intelli-studio

Item	Requirements
CPU	Intel Pentium 4, 3.2 GHz or higher/ AMD Athlon™ FX 2.6 GHz or higher
RAM	Minimum 512 MB RAM (1 GB and above recommended)
OS	Windows XP SP2/Vista/7
Hard disk capacity	250 MB or more (1 GB or more recommended)
Others	<ul style="list-style-type: none">• CD-ROM drive• nVIDIA Geforce 7600GT or higher/ATI X1600 series or higher• 1024 x 768 pixels, 16-bit color display compatible monitor (1280 x 1024 pixels, 32-bit color display recommended)• USB 2.0 port, Microsoft DirectX 9.0c or later

* The programs may not work properly on 64-bit Edition of Windows XP, Windows Vista and Windows 7.



- Intelli-studio may not perform correctly on some computers, even when the computer meets the requirements.
- If your computer does not meet the requirements, videos may not play correctly or it may take longer to edit videos.
- Install DirectX 9.0c or above before you use the program.
- Your computer must have Windows XP/Vista/7 or Mac OS 10.4 or later for you to connect the camera to the computer as a removable disk.



Using a self-assembled PC or a PC and OS that are not supported may void your warranty.

Installing Intelli-studio

- 1 Insert the installation CD in a compatible CD-ROM drive.
- 2 When the setup screen is appears, click **Samsung Digital Camera Installer** to start installation.

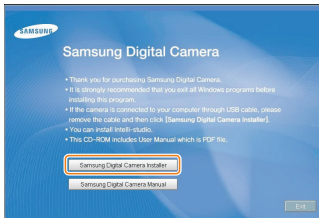

- 3 Select the programs to install, and then follow the onscreen instructions.
- 4 Click **Exit** to complete the installation, and then restart your computer.



Transferring files using Intelli-studio

You can easily transfer files on your camera to your computer by using Intelli-studio.

- 1 Turn off the camera.
- 2 Connect the camera to your computer with the USB cable.



You must plug the end of the cable with the indicator light (▲) into your camera. If the cable is reversed, it may damage your files. The manufacturer is not responsible for any loss of data.

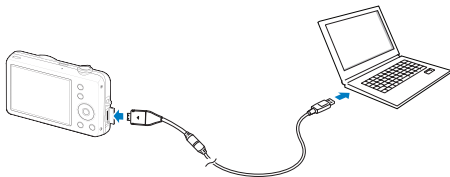

The battery charges while the camera is connected to a computer with the USB cable.

- 3 Run Intelli-studio on your computer.
- 4 Turn on the camera.
 - The computer recognizes the camera automatically.



If the camera fails to connect, a pop-up window will appear. Select **Computer**.

- 5 Select a folder on your computer to save new files to.
 - If your camera has no new files, the pop-up window for saving new files will not appear.
- 6 Select **Yes**.
 - New files are transferred to the computer.

Using Intelli-studio

The Intelli-studio allows you to play back and edit files. You can also upload files to websites, such as Flickr or YouTube. For details, select **Help** → **Help** in the program.

- To enjoy more features, such as creating slide shows with templates, install the full version of Intelli-studio by selecting **Web Support** → **Update Intelli-studio** → **Start Update** from the program toolbar.
- You cannot edit files directly on the camera. Transfer files to a folder on your computer before editing.
 - Videos: MP4 (Video: H.264, Audio: AAC), WMV (WMV 7/8/9), AVI (MJPEG)
 - Photos: JPG, GIF, BMP, PNG, TIFF



Icon	Description
1	Open menus
2	Display files in the selected folder
3	Change to the Photo edit mode
4	Change to the Video edit mode
5	Change to the Sharing mode (You can send files by email or upload files to websites, such as Flickr or YouTube.)
6	Enlarge or reduce the thumbnails in the list
7	Select a file type
8	View files of the selected folder on your computer
9	Show or hide files of the connected camera
10	View files of the selected folder on the camera
11	View files as thumbnails or on a map
12	Browse folders in the connected device
13	Browse folders in your computer
14	Move to the previous or next folder
15	Print files, view files on a map, store files in My Folder, or register faces

Transferring files by connecting the camera as a removable disk

Connect the camera to your computer as a removable disk.

- 1 Turn off the camera.
- 2 Connect the camera to your computer with the USB cable.



You must plug the end of the cable with the indicator light (▲) into your camera. If the cable is reversed, it may damage your files. The manufacturer is not responsible for any loss of data.

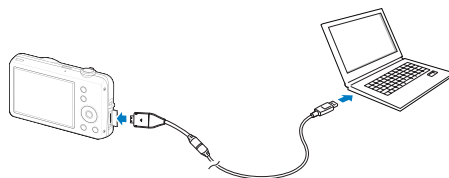

- 3 Turn on the camera.
 - The computer recognizes the camera automatically.



If the camera fails to connect, a pop-up window will appear.
Select **Computer**.

- 4 On your computer, select **My Computer** → **Removable Disk** → **DCIM** → **100PHOTO**.
- 5 Select the files you want and drag or save them to your computer.

Disconnecting the camera (for Windows XP)

The way to disconnect the USB cable for Windows Vista/7 is similar.

- 1 If the status lamp on your camera is blinking, wait until it stops.
- 2 Click  on the tool bar at the bottom right of your PC screen.



- 3 Click the pop-up message.
- 4 Click the message box indicating safely removed.
- 5 Remove the USB cable.



The camera may not be removed safely when Intelli-studio is running.
End the program before disconnecting the camera.

Transferring files to your Mac computer

When you connect the camera to a Macintosh computer, the computer recognizes the camera automatically. You can transfer files directly from the camera to the computer without installing any programs.



Mac OS 10.4 or later is supported.

- 1 Turn off the camera.
- 2 Connect your camera to a Macintosh computer with the USB cable.



You must plug the end of the cable with the indicator light (▲) into your camera. If the cable is reversed, it may damage your files. The manufacturer is not responsible for any loss of data.

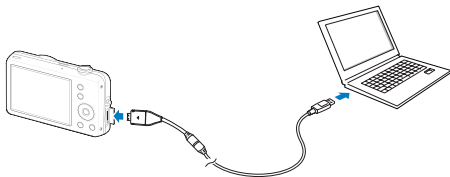

- 3 Turn on the camera.
 - The computer recognizes the camera automatically and displays a removable disk icon.



If the camera fails to connect, a pop-up window will appear. Select **Computer**.

- 4 Double-click the removable disk icon.
- 5 Transfer photos or videos to the computer.

Printing photos with a PictBridge photo printer

Print photos with a PictBridge-compatible printer by connecting your camera directly to the printer.



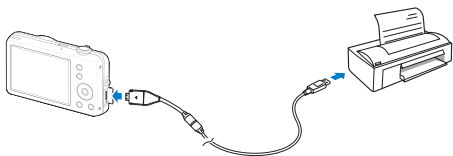



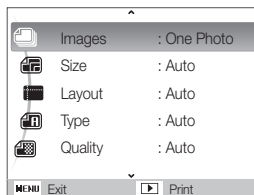

- 1 In Shooting or Playback mode, press [**MENU**].
- 2 Select **Settings** → **USB**.
- 3 Select **Printer**.
- 4 With the printer on, connect your camera to the printer with the USB cable.



- 5 Turn on your camera.
 - The printer recognizes the camera automatically.
- 6 Press [**⚡**] or [**☺**] to select a photo.
 - Press [**MENU**] to set printing options. See "Configuring print settings".
- 7 Press [**OK**] to print.
 - Printing starts. Press [**⚡**] to cancel printing.

Configuring print settings



Option	Description
	Images: Select whether to print the current photo or all photos.
	Size: Specify the size of the print.
	Layout: Create thumbnail prints.
	Type: Select the type of paper.
	Quality: Set the printing quality.
	Date: Set to print the date.
	File Name: Set to print the name of the file.
	Reset: Reset the print options.



Some options are not supported by some printers.

Settings

Refer to options to configure your camera's settings.

Camera settings menu	77
Accessing the settings menu	77
Sound	78
Display	78
Settings	79



Camera settings menu

Learn about various options to configure your camera's settings.

Accessing the settings menu

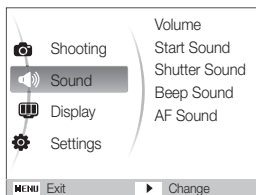
- 1 In Shooting or Playback mode, press [**MENU**].
- 2 Select a menu.



Menu	Description
	Sound: Set various camera sounds and the volume. (p. 78)
	Display: Customize the display settings, such as start image and brightness. (p. 78)
	Settings: Change the settings for the camera system, such as memory format, default file name, and USB mode. (p. 79)

- 3 Select an option and save your settings.

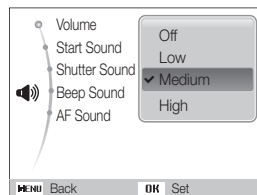

- 4 Press [**MENU**] to return to the previous screen.



Sound

* Default

Item	Description
Volume	Adjust the volume of any sound. (Off , Low , Medium* , High)
Start Sound	Select the sound the camera emits when you turn it on. (Off* , 1 , 2 , 3)
Shutter Sound	Select the sound the camera emits when you press the shutter button. (Off , 1* , 2 , 3)
Beep Sound	Select the sound the camera emits when you press buttons or switch modes. (Off , 1* , 2 , 3)
AF Sound	Select the sound the camera emits when you half-press the shutter button. (Off , On*)

Display

* Default

Item	Description
Function Description	Display a brief description of an option or menu. (Off , On*)
Start Image	<p>Set a start image to display when the camera turns on.</p> <ul style="list-style-type: none"> • Off*: Display no start image. • Logo: Display a default image stored in the internal memory. • User Image: Display the image you want. (p. 62) <p> Only one user image will be saved in the memory.</p> <ul style="list-style-type: none"> • if you select a new photo as a user image or reset your camera, the current image will be deleted.
Display Brightness	<p>Adjust the brightness of the screen. (Auto*, Dark, Normal, Bright)</p> <p> Normal is fixed in Playback mode even if you have selected Auto.</p>
Quick View	<p>Set the duration for reviewing a captured image before returning to the Shooting mode. (Off, 0.5 sec*, 1 sec, 3 sec)</p>

* Default

Item	Description
Power Save	<p>If you perform no operations for 30 seconds, the camera automatically switches to Power save mode (press any button to deactivate the Power save mode). (Off*, On)</p> <p> If the Power save mode is deactivated, the main display will dim to save battery life when you perform no operations for about 30 seconds.</p>

Settings



* Default

Item	Description
Format	<p>Format the internal memory and the memory card. Format deletes all files, including protected files. (Yes, No)</p> <p> If you use a memory card used with cameras from different manufacturers or a memory card reader, or one formatted on a computer, your camera may read the card incorrectly. Format the card before using it.</p>
Reset	<p>Reset menus and shooting options. Date and time, language, and video output settings are not reset. (Yes, No)</p>
Language	Select a language for the display text.
Time Zone	Select a region and set the daylight-saving time (DST).
Date/Time Set	Set the date and time.
Date Type	Select a date format. (YYYY/MM/DD, MM/DD/YYYY, DD/MM/YYYY, Off*)

* Default

Item	Description
File No.	<p>Specify how to name files.</p> <ul style="list-style-type: none"> • Reset: Set the file number to start from 0001 when inserting a new memory card, formatting a memory card, or deleting all files. • Series*: Set the file number to follow the previous file number when inserting a new memory card, formatting a memory card, or deleting all files. <p> • The default name of the first folder is 100PHOTO and the default name of the first file is SAM_0001.</p> <ul style="list-style-type: none"> • The file number increases one at a time from SAM_0001 to SAM_9999. • The folder number increases one at a time from 100PHOTO to 999PHOTO. • The maximum number of files that can be stored in one folder is 9999. • The camera defines file names according to the Digital rule for Camera File system (DCF) standard. If you change the names of files intentionally, the camera may not play back the files.

* Default

Item	Description
Imprint	<p>Select whether to display the date and time on your photos when printing. (Off*, Date, Date & Time)</p> <p> • The date and time is displayed on the bottom-right corner of the photo in yellow.</p> <ul style="list-style-type: none"> • Some printer models may not print the date and time. • If you select Text in  mode, the camera will not display the date and time.
Auto Power Off	<p>Set the camera to turn off automatically when you are not using it. (Off, 1 min, 3 min*, 5 min, 10 min)</p> <p> • Your settings will not change after replacing the battery.</p> <ul style="list-style-type: none"> • The camera will not automatically turn off when: <ul style="list-style-type: none"> - it is connected to a computer or printer - you are playing a slide show or videos - you are recording a voice memo
AF Lamp	<p>Turn on an assistant light to help you focus in dark places. (Off, On*)</p>
Video Out	<p>Set the video signal output according to your region.</p> <ul style="list-style-type: none"> • NTSC*: USA, Canada, Japan, Korea, Taiwan, Mexico. • PAL (supports only BDGHI): Australia, Austria, Belgium, China, Denmark, Finland, Germany, England, Italy, Kuwait, Malaysia, New Zealand, Singapore, Spain, Sweden, Switzerland, Thailand, Norway.

* Default

Item	Description
USB	<p>Select the function to use when you connect the camera to a computer or printer using a USB cable.</p> <ul style="list-style-type: none">• Auto*: Set your camera to select a USB mode automatically.• Computer: Connect your camera to a computer for transferring files.• Printer: Connect your camera to a printer for printing files.

Appendixes

Refer to error messages, specifications, and maintenance tips.

Error messages	83
Camera maintenance	84
Cleaning your camera	84
Using or storing the camera	85
About memory cards	86
About the battery	88
Before contacting a service center	92
Camera specifications	95
Glossary	99
FCC notice	103
Index	104

Error messages

When the following error messages appear, try these remedies.

Error message	Suggested remedies
Card Error	<ul style="list-style-type: none">• Turn off your camera, and then turn it on again.• Remove your memory card, and insert it again.• Format your memory card. (p. 79)
Card not supported.	The inserted memory card is not compatible with your camera. Insert a microSD, microSDHC memory card.
DCF Full Error	File names do not match the DCF standard. Transfer the files on the memory card to your computer, and then format the card. (p. 79)
File Error	Delete the damaged file or contact a Samsung service center.
Low Battery	Insert a charged battery or recharge the battery.
Memory Full	Delete unnecessary files or insert a new memory card.
No Image File	Take photos or insert a memory card that has some photos.

Camera maintenance

Cleaning your camera

Camera lens and display

Use a blower brush to remove dust, and then wipe the lens gently with a soft cloth. If any dust remains, apply lens cleaning liquid to a piece of lens cleaning paper, and then wipe gently.

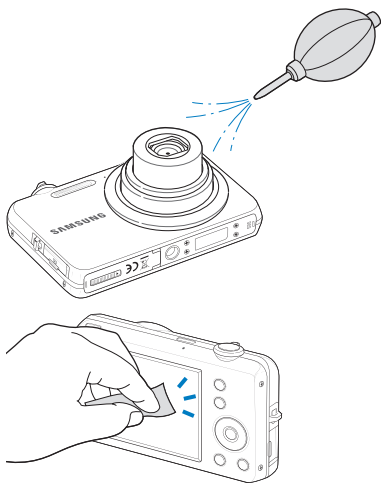

Camera body

Wipe gently with a soft, dry cloth.

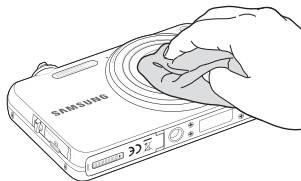

- Never use benzene, thinners, or alcohol to clean the device. These solutions can damage the camera or cause it to malfunction.
- Do not press on the lens cover or use a blower brush on the lens cover.

Using or storing the camera

Inappropriate places to use or store the camera

- Avoid exposing the camera to very cold or very hot temperatures.
- Avoid using your camera in areas with extremely high humidity, or where the humidity changes drastically.
- Avoid exposing the camera to direct sunlight and storing it in hot, poorly-ventilated areas, such as in a car during summer time.
- Protect your camera and the display from impact, rough handling, and excessive vibration to avoid serious damage.
- Avoid using or storing your camera in dusty, dirty, humid, or poorly-ventilated areas to prevent damage to moving parts and internal components.
- Do not use your camera near fuels, combustibles, or flammable chemicals. Do not store or carry flammable liquids, gases, or explosive materials in the same compartment as the camera or its accessories.
- Do not store the camera where there are mothballs.

Using on beaches or shores

- Protect your camera from sand and dirt when you use it on beaches or in other similar areas.
- Your camera is not waterproof. Do not handle the battery, adapter, or memory card with wet hands. Operating the camera with wet hands may cause damage to your camera.

Storing for extended period of time

- When you store the camera for an extended period, place it in a sealed container with an absorbent material, such as silica gel.
- Remove the batteries from your camera when storing it for an extended period. Installed batteries may leak or corrode over time and cause serious damage to your camera.
- Over time, unused batteries will discharge and must be recharged before use.

Use the camera with caution in humid environments

When you transfer the camera from a cold environment to a warm one, condensation can form on the lens or internal components of the camera. In this situation, turn off the camera and wait for at least 1 hour. If condensation forms on the memory card, remove the memory card from the camera and wait until all moisture has evaporated before reinserting it.

Other cautions

- Do not swing your camera by the strap. This may cause injury to yourself or others or damage to your camera.
- Do not paint your camera, as paint can clog moving parts and prevent proper operation.
- Turn off the camera while not in use.
- Your camera consists of delicate parts. Avoid impacts to the camera.
- Protect the display from external force by keeping it in the case when not in use. Protect the camera from scratches by keeping it away from sand, sharp implements, or loose change.
- Do not expose the lens to direct sunlight, as this may discolor the image sensor or cause it to malfunction.
- Protect your lens from fingerprints and scratches. Clean your lens with a soft, clean, debris-free lens cloth.
- The camera may turn off if impacted from the outside. This is to protect the memory card. Turn on the camera to use it again.
- While you use the camera, it may heat up. This is normal and should not affect your camera's lifespan or performance.
- When you use the camera in low temperatures, it may take some time to turn on, the color may be changed temporarily, or after-images may appear. These conditions are not malfunctions and they will correct themselves when the camera is returned to normal temperatures.
- Paint or metal on the outside of the camera may cause allergies, itchy skin, eczema, or swelling for people with sensitive skin. If you experience any of these symptoms, stop using the camera immediately and consult a doctor.

- Do not insert foreign objects into any of your camera's compartments, slots, or access points. Damage due to improper use may not be covered by your warranty.
- Do not allow unqualified personnel to service the camera or attempt to service the camera yourself. Any damage that results from unqualified service is not covered by your warranty.

About memory cards

Supported memory cards



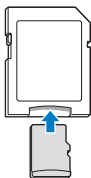

Your camera supports microSD (Secure Digital) or microSDHC (Secure Digital High Capacity) memory cards.



To read data with a PC or memory card reader, insert the memory card into a memory card adapter.

Memory card capacity

The memory capacity may differ depending on the scenes you shoot or the shooting conditions. These capacities are based on a 1 GB microSD card:

	Size	Super Fine	Fine	Normal	60 FPS	30 FPS	24 FPS	15 FPS
P h o t o s	14M	138	272	401	-	-	-	-
	 12M	160	315	464	-	-	-	-
	12M	162	318	468	-	-	-	-
	 10M	191	374	549	-	-	-	-
	8M	239	465	678	-	-	-	-
	5M	373	714	1,025	-	-	-	-
	 2M	851	1,539	2,108	-	-	-	-
	1M	1,913	3,091	3,889	-	-	-	-
* V i d e o s	 1200 HD	-	-	-	-	-	Approx. 05' 32"	Approx. 08' 49"
	640	-	-	-	-	Approx. 13' 10"	-	Approx. 25' 52"
	320	-	-	-	Approx. 13' 50"	Approx. 27' 10"	-	Approx. 52' 20"

* Available recording time may vary if you use the zoom.
Several videos were recorded in succession to determine the total recording time.

Cautions when using memory cards

- Insert a memory card in the correct direction. Inserting a memory card in the wrong direction may damage your camera and memory card.
- Do not use memory cards that have been formatted by other cameras or by a computer. Reformat the memory card with your camera.
- Turn off the camera when you insert or remove the memory card.
- Do not remove the memory card or turn off your camera while the lamp is blinking, as this may damage your data.
- When the lifespan of a memory card has expired, you cannot store any more photos on the card. Use a new memory card.
- Do not bend, drop, or subject memory cards with heavy impact or pressure.
- Avoid using or storing memory cards near strong magnetic fields.
- Avoid using or keeping memory cards in areas with high temperature, high humidity, or corrosive substances.
- Prevent memory cards from making contact with liquids, dirt, or foreign substances. If dirty, wipe the memory card clean with a soft cloth before you insert the memory card in your camera.
- Do not allow liquids, dirt, or foreign substances to come in contact with memory cards or the memory card slot. Doing so may cause memory cards or the camera to malfunction.
- When you carry a memory card, use a case to protect the card from electrostatic discharges.

- Transfer important data to other media, such as a hard disk, CD, or DVD.
- When you use the camera for an extended period, the memory card may become warm. This is normal and does not indicate a malfunction.



The manufacturer is not responsible for any loss of data.

About the battery

Use only Samsung-approved batteries.

Battery specifications

Specification	Description
Model	BP70A
Type	Lithium-ion battery
Cell capacity	740 mAh (Minimum 700 mAh)
Voltage	3.7 V
Charging time* (when the camera is switched off)	Approximately 150 min

* Charging the battery by connecting it to a computer may take longer.

Battery life

Average shooting time / Number of photos	Shooting conditions (when the battery was fully charged)
<p>Photos</p> <p>Approximately 90 min / Approximately 180</p>	<p>The battery life was measured under the following conditions: in the  mode, 14M resolution, and Fine quality.</p> <p>Test Procedure:</p> <ol style="list-style-type: none"> 1. Set the flash option to Off, take a single shot, and zoom in or out. 2. Set the flash option to Fill in, take a single shot, and zoom in or out. 3. Perform steps 1 and 2 for 30 seconds and repeat for 5 minutes. Then turn off the camera for 1 minute. 4. Repeat steps 1 to 3.
<p>Videos</p> <p>Approximately 60 min</p>	<p>Record videos at 1280 X 720 HQ resolution and 24 FPS.</p>

- The figures above are based on Samsung's standards. Your results may differ depending on your actual usage.
- Several videos were recorded in succession to determine the total recording time.

Low battery message

When the battery charge has fully discharged, the battery icon will turn red and the **Low Battery** message will appear.

Notes about using the battery

- Avoid exposing batteries or memory cards to very cold or very hot temperatures (below 0° C/32° F or above 40° C/104° F). Extreme temperatures can reduce the charging capacity of your batteries and can cause memory cards to malfunction.
- When you use the camera for an extended period, the area around the battery chamber may become warm. This does not affect the normal use of the camera.
- Do not pull the power supply cord to disconnect the plug from the power outlet, as this may cause a fire or electric shock.
- In temperatures below 0 °C, battery capacity and battery life may decrease.
- Battery capacity may decrease in low temperatures but will return to normal in milder temperatures.

Cautions about using the battery

Protect batteries, chargers, and memory cards from damage

Prevent batteries from making contact with metal objects, as this can create a connection between the + and – terminals of your battery and lead to temporary or permanent battery damage and may cause a fire or electric shock.

Notes about charging the battery

- If the indicator light is off, make sure that the battery is inserted correctly.
- If the camera is on while charging, the battery may not fully charge. Turn off the camera before charging the battery.
- Do not use your camera when you charge the battery. This may cause a fire or electric shock.
- Do not pull the power supply cord to disconnect the plug from the power outlet, as this may cause a fire or electric shock.
- Wait to turn on the camera until after the battery has charged for at least 10 minutes.
- If you connect the camera to an external power source while the battery is depleted, using some high energy-consuming functions will cause the camera to turn off. To use the camera normally, recharge the battery.
- The battery cannot be recharged when the temperature is below 0 °C or above 40 °C.

- Using the flash or recording videos depletes the battery quickly. Charge the battery until the indicator light turns green.
- If the indicator light blinks in orange or does not illuminate, reconnect the cable, or remove the battery and insert it again.
- If you charge the battery when the cable is overheated or the temperature is too high, the indicator light may turn orange. Charging will start when the battery cools down.
- Overcharging batteries may shorten battery life. After charging is finished, disconnect the cable from your camera.
- Do not bend or place heavy objects on the AC cable. Doing so may damage the cable.

Notes about charging with a computer connected

- Use only the provided USB cable.
- The battery may not charge when:
 - you use a USB hub
 - other USB devices are connected to your computer
 - you connect the cable to the port on the front side of your computer
 - the USB port of your computer does not support the power output standard (5V, 500mA)

Handle and dispose of batteries and chargers with care

- Never dispose of batteries in a fire. Follow all local regulations when you dispose of used batteries.
- Never place batteries or cameras on or in heating devices, such as microwave ovens, stoves, or radiators. Batteries may explode when they are overheated.



Personal injury or death can occur if the battery is handled carelessly or improperly. For your safety, follow these instructions for proper battery handling:

- The battery can ignite or explode if not handled properly. If you notice any deformities, cracks, or other abnormalities in the battery, immediately discontinue use of the battery and contact a service center.
- Use only authentic, manufacturer-recommend battery chargers and adapters and charge the battery only by the methods described in this user manual.
- Do not place the battery near heating devices or expose it to excessively warm environments, such as the inside of an enclosed car in the summertime.
- Do not place the battery in a microwave oven.
- Avoid storing or using the battery in hot, humid places, such as spas or shower enclosures.
- Do not rest the device on flammable surfaces, such as bedding, carpets, or electric blankets for a prolonged period.
- When the device is switched on, do not leave it in any confined space for a prolonged period.
- Do not allow the battery terminals to come in contact with metallic objects, such as necklaces, coins, keys, or watches.
- Use only authentic, manufacturer-recommended, Lithium-ion replacement batteries.

- Do not disassemble or puncture the battery with any sharp object.
- Avoid exposing the battery to high pressure or crushing forces.
- Avoid exposing the battery to major impacts, such as dropping it from high places.
- Do not expose the battery to temperatures of 60 °C (140° F) or above.
- Do not allow the battery to come in contact with moisture or liquids.
- Do not expose the battery to direct sunlight, fire, or any other source of excessive heat.

Disposal guidelines

- Dispose of the battery with care.
- Do not dispose of the battery in a fire.
- Disposal regulations may differ by country or region. Dispose of the battery in accordance with all local and federal regulations.

Guidelines for charging the battery

Charge the battery only by the method described in this user manual. The battery can ignite or explode if not charged properly.

Before contacting a service center

If you are having trouble with your camera, try these troubleshooting procedures before contacting a service center. If you have attempted the troubleshooting solution and are still having problems with your device, contact your local dealer or service center.



When you leave your camera at a service center, be sure to also leave the other components that may have contributed to the malfunction, such as the memory card and battery.

Situation	Suggested remedies
Cannot turn on the camera	<ul style="list-style-type: none">• Make sure that the battery is inserted.• Make sure that the battery is inserted correctly.• Charge the battery.
The power turns off suddenly	<ul style="list-style-type: none">• Charge the battery.• Your camera may be in Power save mode. (p. 79)• The camera may turn off to prevent the memory card from being damaged due to an impact. Turn on your camera again.
The camera is losing battery power quickly	<ul style="list-style-type: none">• The battery may lose power more quickly in low temperatures (below 0° C). Keep the battery warm by putting it into your pocket.• Using the flash or recording videos depletes the battery quickly. Recharge if needed.• Batteries are consumable parts that must be replaced over time. Get a new battery if the battery life is diminishing quickly.

Situation	Suggested remedies
Cannot take photos	<ul style="list-style-type: none">• There is no space on the memory card. Delete unnecessary files or insert a new card.• Format the memory card. (p. 79)• The memory card is defective. Get a new memory card.• Make sure that the camera is switched on.• Charge the battery.• Make sure that the battery is inserted correctly.
The camera freezes	Remove the battery and insert it again.
The camera heats up	While you use the camera, it may heat up. This is normal and should not affect your camera's lifespan or performance.
The flash does not work	<ul style="list-style-type: none">• The flash option may be set to Off. (p. 38)• You cannot use the flash in some modes.
The flash fires unexpectedly	The flash may fire due to static electricity. This is not a malfunction.

Situation	Suggested remedies
The date and time are incorrect	Set the date and time in the display settings menu. (p. 79)
The display or buttons do not work	Remove the battery and insert it again.
The camera screen works poorly	If you use your camera at low temperatures, it can cause the camera screen to malfunction or discolor. For better performance of your camera screen, use your camera at normal temperatures.
The memory card has an error	The memory card has not been reset. Format the card. (p. 79)
Cannot play back files	If you change the name of a file, your camera may not play the file. (Note: File names should meet the DCF standard.) If you encounter this situation, play back the files on your computer.
The photo is blurry	<ul style="list-style-type: none"> • Make sure that the focus option you set is suitable for close-up shots. (p. 40) • Make sure that the lens is clean. If not, clean the lens. (p. 84) • Make sure that the subject is within range of the flash. (p. 95)

Situation	Suggested remedies
The colors in the photo do not match the actual scene	An incorrect white balance can create unrealistic color. Select the proper white balance option to suit the light source. (p. 47)
The photo is too bright	<ul style="list-style-type: none"> • Turn off the flash. (p. 38) • Your photo is overexposed. Adjust the exposure value. (p. 46)
The photo is too dark	Your photo is underexposed. <ul style="list-style-type: none"> • Turn on the flash. (p. 38) • Adjust the ISO speed. (p. 39) • Adjust the exposure value. (p. 46)
The TV does not display your photos	<ul style="list-style-type: none"> • Make sure that the camera is correctly connected to the TV with the A/V cable. • Make sure that your memory card contains photos.
Your computer does not recognize your camera	<ul style="list-style-type: none"> • Make sure that the USB cable is connected correctly. • Make sure that your camera is switched on. • Make sure that you are using a supported operating system. (p. 68, 74)
Your computer disconnects the camera while transferring files	The file transmission may be interrupted by static electricity. Disconnect the USB cable and connect it again.

Situation	Suggested remedies
Your computer cannot play videos	<ul style="list-style-type: none">• Depending on the video player programs installed on your PC, video files captured by your camera may not play. To ensure the video files play on your computer, install and use the Intelli-studio. (p. 71)• Make sure that the USB cable is connected correctly.
Intelli-studio is not functioning properly	<ul style="list-style-type: none">• End Intelli-studio and restart the program.• You cannot use Intelli-studio on Macintosh computers.• Depending on your computer's specification and environments, the program may not launch automatically. In this case, click Start → My Computer → Intelli-studio → iStudio.exe on your computer.

Camera specifications

Image sensor													
Type	1/2.3" (Approx. 7.76 mm) CCD												
Effective pixels	Approx. 14.22 mega-pixels												
Total pixels	Approx. 14.54 mega-pixels												
Lens													
Focal length	Samsung 5X Zoom Lens f = 4.9 - 24.5 mm (35 mm film equivalent: 27 - 135 mm)												
F-stop range	F3.5 (W) - F5.9 (T)												
Digital zoom	<ul style="list-style-type: none"> • Still image mode: 1.0X - 3.0X • Play mode: 1.0X - 13.5X (depending on image size) 												
Display													
Type	TFT LCD												
Feature	2.7" (6.9 cm), 230 K												
Focusing													
Type	TTL auto focus (Multi AF, Center AF, Face Detection AF, Object Tracking AF)												
Range	<table border="1"> <thead> <tr> <th></th> <th>Wide (W)</th> <th>Tele (T)</th> </tr> </thead> <tbody> <tr> <td>Normal</td> <td>80 cm - infinity</td> <td>100 cm - infinity</td> </tr> <tr> <td>Macro</td> <td>5 cm - 80 cm</td> <td>100 cm - 150 cm</td> </tr> <tr> <td>Auto Macro</td> <td>5 cm - infinity</td> <td>100 cm - infinity</td> </tr> </tbody> </table>		Wide (W)	Tele (T)	Normal	80 cm - infinity	100 cm - infinity	Macro	5 cm - 80 cm	100 cm - 150 cm	Auto Macro	5 cm - infinity	100 cm - infinity
		Wide (W)	Tele (T)										
	Normal	80 cm - infinity	100 cm - infinity										
	Macro	5 cm - 80 cm	100 cm - 150 cm										
Auto Macro	5 cm - infinity	100 cm - infinity											

Shutter speed

- Smart Auto: 1/8 - 1/2,000 sec.
- Program: 1 - 1/2,000 sec.
- Night: 8 - 1/2,000 sec.
- Fireworks: 2 sec.

Exposure

Control	Program AE
Metering	Multi, Spot, Center-weighted, Face Detection AE
Compensation	±2EV (1/3EV steps)
ISO equivalent	Auto, 80, 100, 200, 400, 800, 1600, 3200 (Up to 5M Size)

Flash

Mode	Off, Auto, Red-eye, Fill in, Slow Sync, Red-eye Fix
Range	<ul style="list-style-type: none"> • WIDE: 0.4 m - 3.5 m (ISO Auto) • TELE: 0.5 m - 2.0 m (ISO Auto)
Recharging time	Approx. 4 sec. (depending on battery condition)

Shake reduction

Digital Image Stabilization (DIS)

Effect	
Shooting mode	<ul style="list-style-type: none"> • Photo Style Selector: Normal, Soft, Vivid, Forest, Retro, Cool, Calm, Classic, Negative, Custom RGB • Smart Filter: Normal, Miniature, Vignetting, Fish Eye, Sketch, Defog • Image Adjust: Sharpness, Contrast, Saturation
White Balance	
Auto WB, Daylight, Cloudy, Fluorescent_H, Fluorescent_L, Tungsten, Custom Set	
Date Imprinting	
Off, Date, Date & Time	
Shooting	
Photos	<ul style="list-style-type: none"> • Modes: Smart Auto (White, Macro Color, Portrait, Night Portrait, Backlight Portrait, Backlight, Landscape, Action, Tripod, Night, Macro, Macro Text, Blue Sky, Sunset, Natural Green), Program, DIS, Scene (Beauty Shot, Frame Guide, Night, Portrait, Children, Landscape, Close Up, Text, Sunset, Dawn, Backlight, Fireworks, Beach & Snow) • Drive: Single, Continuous, Motion Capture, AEB • Timer: Off, 10 Sec, 2 Sec, Double

Videos	<ul style="list-style-type: none"> • Format: AVI (MJPEG) • Size: 1280 X 720 HQ (Per one file: Max. 2GB), 640 X 480, 320 X 240 • Frame Rate: 60fps (320 X 240 Only), 30 fps, 24 fps (1280 X 720 HQ Only), 15 fps • Voice: On/Off/Zoom Mute • Video editing (embedded): Movie Stabilization, Pause during recording, Still image capture, Time trimming
Playback	
Type	Single image, Thumbnails, Multi Slide Show with Music and Effect, Movie clip, Smart Album* * Smart Album category: Type, Date, Color, Week
Edit	Resize, Rotate, Photo Style Selector, Image Adjust
Effect	<ul style="list-style-type: none"> • Photo Style Selector: Normal, Soft, Vivid, Forest, Retro, Cool, Calm, Classic, Negative, Custom RGB • Smart Filter: Normal, Miniature, Vignetting, Fish Eye, Sketch, Defog • Image Adjust: ACB, Red-eye Fix, Face Retouch, Brightness, Contrast, Saturation, Add Noise

Voice recording

- Voice Recording (Max 10 hours)
- Voice Memo in a photo (Max. 10 sec.)

Storage

Media	<ul style="list-style-type: none"> • Internal memory: Approx. 19 MB • External memory (Optional): <ul style="list-style-type: none"> - microSD card (up to 2 GB guaranteed) - microSDHC card (up to 8 GB guaranteed) <p>Internal memory capacity may not match these specifications.</p>
File format	<ul style="list-style-type: none"> • Photo: JPEG (DCF), EXIF 2.21, DPOF 1.1, PictBridge 1.0 • Video: AVI (MJPEG) • Audio: PCM

		For 1GB microSD			
		Super Fine	Fine	Normal	
Image size	14M	4320 X 3240	138	272	401
	12M	4224 X 2816	160	315	464
	12M	4000 X 3000	162	318	468
	11M	4224 X 2376	191	374	549
	8M	3264 X 2448	239	465	678
	5M	2592 X 1944	373	714	1,025
	2M	1920 X 1080	851	1,539	2,108
	1M	1024 X 768	1,913	3,091	3,889

These figures are measured under Samsung's standard conditions and may vary depending on shooting conditions and camera settings.

Interface

Digital output connector	USB 2.0
Audio output	Mono (Internal speaker), Mono (Microphone)
Video output	NTSC, PAL (selectable)
DC power input connector	4.2 V

Camera specifications

Power source

Rechargeable battery	Lithium-ion battery (BP70A) (740 mAh, Minimum 700 mAh)
----------------------	---

Connector Type	20 pin (USB/AV out)
----------------	---------------------

The power source may differ depending on your region.

Dimensions (W x H x D)

92.4 × 55.6 × 17.0 mm (excluding protrusions)

Weight

110 g (without battery and memory card)

Operating temperature

0 - 40°C

Operating humidity

5 - 85 %

Software

Intelli-studio

Specifications are subject to change without prior notice.

Glossary

ACB (Auto Contrast Balance)

This feature automatically improves the contrast of your images when the subject is backlit or when there is a high contrast between your subject and the background.

AEB (Auto Exposure Bracket)

This feature automatically captures several images at different exposures to help you capture a properly-exposed image.

AF (Auto Focus)

A system that automatically focuses the camera lens on the subject. Your camera uses the contrast to focus automatically.

Aperture

The aperture controls the amount of light that reaches the camera's sensor.

Camera shake (Blur)

If the camera is moved while the shutter is open, the entire image may appear blurred. This occurs more often when the shutter speed is slow. Prevent camera shake by raising the sensitivity, using the flash, or using a faster shutter speed. Alternately, use a tripod, the DIS function to stabilize the camera.

Composition

Composition in photography means arranging objects in a photo. Usually, abiding by the rule of thirds leads to a good composition.

DCF (Design rule for Camera File system)

A specification to define a file format and file system for digital cameras created by the Japan Electronics and Information Technology Industries Association (JEITA).

Depth of field

The distance between the nearest and farthest points that can be acceptably focused in a photograph. Depth of field varies with lens aperture, focal length, and distance from the camera to the subject. Selecting a smaller aperture, for example, will increase the depth of field and blur the background of a composition.

Digital zoom

A feature that artificially increases the amount of zoom available with zoom lens (optical zoom). When using the digital zoom, the image quality will deteriorate as the magnification increases.

DPOF (Digital Print Order Format)

A format for writing printing information, such as selected images and number of prints, on a memory card. DPOF-compatible printers, sometimes available at photo shops, can read the information from the card for convenient printing.

EV (Exposure Value)

All the combinations of the camera's shutter speed and lens aperture that result in the same exposure.

EV Compensation

This feature allows you to quickly adjust the exposure value measured by the camera, in limited increments, to improve the exposure of your photos. Set the EV compensation to -1.0 EV to adjust the value one step darker and 1.0 EV to one step brighter.

Exif (Exchangeable Image File Format)

A specification to define an image file format for digital cameras created by the Japan Electronic Industries Development Association (JEIDA).

Exposure

The amount of light allowed to reach the camera's sensor. Exposure is controlled by a combination of the shutter speed, the aperture value, and ISO sensitivity.

Flash

A speed light that helps to create adequate exposure in low-light conditions.

Focal length

The distance from the middle of the lens to its focal point (in millimeters). Longer focal lengths result in narrower angles of view and the subject is magnified. Shorter focal lengths result in wider angles of view.

Image sensor

The physical part of a digital camera that contains a photosite for each pixel in the image. Each photosite records the brightness of the light that strikes it during an exposure. Common sensor types are CCD (Charge-coupled Device) and CMOS (Complementary Metal Oxide Semiconductor).

ISO sensitivity

The sensitivity of the camera to light, based on the equivalent film speed used in a film camera. At higher ISO sensitivity settings, the camera uses a higher shutter speed, which can reduce blur caused by camera shake and low light. However, images with high sensitivity are more susceptible to noise.

JPEG (Joint Photographic Experts Group)

A lossy method of compression for digital images. JPEG images are compressed to reduce their overall file size with minimal deterioration of the image resolution.

LCD (Liquid Crystal Display)

A visual display commonly used in consumer electronics. This display needs a separate backlight, such as CCFL or LED, to reproduce colors.

Macro

This feature allows you to capture close-up photos of very small objects. When using the macro feature, the camera can maintain a sharp focus on small objects at a near life-size ratio (1:1).

Metering

The metering refers to the way in which the camera measures the quantity of light to set the exposure.

MJPEG (Motion JPEG)

A video format which is compressed as a JPEG image.

Noise

Misinterpreted pixels in a digital image that may appear as misplaced or random, bright pixels. Noise usually occurs when photos are shot with a high sensitivity or when a sensitivity is automatically set in a dark place.

Optical zoom

This is a general zoom which can enlarge images with a lens and does not deteriorate quality of images.

Quality

An expression of the rate of compression used in a digital image. Higher quality images have a lower rate of compression, which usually results in a larger file size.

Resolution

The number of pixels present in a digital image. High resolution images contain more pixels and typically show more detail than low resolution images.

Shutter speed

Shutter speed refers to the amount of time it takes to open and close the shutter, and it is an important factor in the brightness of a photo, as it controls the amount of light which pass through the aperture before it reaches the image sensor. A fast shutter speed allows less time to let light in and the photo becomes darker and more easily freezes subjects in motion.

Vignetting

A reduction of an image's brightness or saturation at the periphery (outer edges) compared to the center of the image. Vignetting can draw interest to subjects positioned in the center of an image.

White balance (color balance)

An adjustment of the intensities of colors (typically the primary colors red, green, and blue), in an image. The goal of adjusting the white balance, or color balance, is to correctly render the colors in an image.



Correct Disposal of This Product (Waste Electrical & Electronic Equipment)

 (Applicable in the European Union and other European countries with separate collection systems)

This marking on the product, accessories or literature indicates that the product and its electronic accessories (e.g. charger, headset, USB cable) should not be disposed of with other household waste at the end of their working life. To prevent possible harm to the environment or human health from uncontrolled waste disposal, please separate these items from other types of waste and recycle them responsibly to promote the sustainable reuse of material resources. Household users should contact either the retailer where they purchased this product, or their local government office, for details of where and how they can take these items for environmentally safe recycling. Business users should contact their supplier and check the terms and conditions of the purchase contract. This product and its electronic accessories should not be mixed with other commercial wastes for disposal.



Correct disposal of batteries in this product

(Applicable in the European Union and other European countries with separate battery return systems)

This marking on the battery, manual or packaging indicates that the batteries in this product should not be disposed of with other household waste at the end of their working life. Where marked, the chemical symbols Hg, Cd or Pb indicate that the battery contains mercury, cadmium or lead above the reference levels in EC Directive 2006/66. If batteries are not properly disposed of, these substances can cause harm to human health or the environment.

To protect natural resources and to promote material reuse, please separate batteries from other types of waste and recycle them through your local, free battery return system.

This Class [B] digital apparatus complies with Canadian ICES-003.



PlanetFirst represents Samsung Electronics' commitment to the sustainable development and social responsibility through eco-driven business and management activities.

FCC notice

- **NOTE:**

This equipment has been tested and found to comply with the limits for a Class B digital device, pursuant to part 15 of the FCC Rules. These limits are designed to provide reasonable protection against harmful interference in a residential installation. This equipment generates, uses and can radiate radio frequency energy and, if not installed and used in accordance with the instructions, may cause harmful interference to radio communications. However, there is no guarantee that interference will not occur in a particular installation. If this equipment does cause harmful interference to radio or television reception, which can be determined by turning the equipment off and on, the user is encouraged to try to correct the interference by one or more of the following measures:

- Reorientate, or relocate, the receiving antenna.
- Increase the distance between the equipment and receiver.
- Connect the equipment into an outlet on a circuit different from that to which the receiver is connected.
- Consult the dealer or an experienced radio / TV technician for help.

- **CAUTION:**

Changes or modifications not expressly approved by the manufacturer responsible for compliance could void the user's authority to operate the equipment.

- **Declaration of Conformity**

Trade Name	: Samsung Electronics America, Inc.
Model No.	: Samsung ST65
Responsible Party	: Samsung Electronics America, Inc.
Address	: 85 Challenger Road, Ridgefield Park, NJ 07660
Telephone No.	: 1-800-SAMSUNG (726-7864)

This device complies with Part 15 of the FCC Rules.

Operation is subject to the following two conditions:

- (1) This device may not cause harmful interference, and
- (2) this device must accept any interference received, including interference that may cause undesired operation.

Index

A

ACB

- in Playback mode 65
- in Shooting mode 46

Adjusting

- Brightness 65
- Contrast
 - in Playback mode 65
 - in Shooting mode 52
- Saturation
 - in Playback mode 65
 - in Shooting mode 52
- Sharpness 52

AF Lamp 80

AF Sound 78

Aperture 30

Auto Contrast Balance (ACB) 46

B

Battery

- Charging 89
- Life 88

Specifications 88

Beauty Shot mode 29

Blink detection 45

Burst

- Auto Exposure Bracket (AEB)
49
- Continuous 49
- Motion capture 49

C

Camera shake 24

Capturing an image from a video 60

Cleaning

- Body 84
- Display 84
- Lens 84

D

Date/Time Set 79

Date Type 79

Deleting files 57

Digital Image Stabilization 31

Digital zoom 23

Disconnecting the device 73

DIS mode 31

Display brightness 78

Display type 21

DPOF , 66

E

Editing 62

Enlarging 58

Error messages 83

Exposure 46

F

Face detection

- Blink Detection 45
- Normal 43
- Self-Portrait 44
- Smile Shot 44

Facial brightness 29

Facial imperfections 29

Flash

- Auto 39
- Fill in 39
- Off 38
- Red-eye 39
- Red-eye Fix 39
- Slow Sync 39

Focus area

- Center AF 42
- Multi AF 42
- Tracking AF 42

Focus distance

- Auto Macro 40
- Macro 40
- Normal (AF) 40

Format 79

Frame guide 30

Frame rate 32

Function button 14

Function description 78

G

Glossary 99

H

Half-pressing 6

I

Icons 18

Image adjust

- ACB 65
- add noise 65
- brightness 65
- contrast 65
- face retouch 65
- red-eye fix 65
- saturation 65

Imprint 80

Intelli-studio 71

ISO speed 39

L

Light source (White balance)
47

Long time shutter 30

M

Macro 40

Maintenance 84

Memory card

- Capacity 87
- microSD 86
- microSDHC 86

MENU button 14

Metering

- Center-weighted 47
- Multi 47
- Spot 47

MJPEG (Motion JPEG) 96

Mode button 14

Movie mode 32

Muting

Camera 16

Video 33

N

Navigation button 14

Night mode 30

P

Photo quality 36

Photo styles

- in Playback mode 63
- in Shooting mode 50

Pictbridge 75

Playback button 16

Playback mode 54

Printing photos 75

Print order 66

Program mode 32

Protecting files 56

Q

Quick View 78

R

Recording

- Video 32
- Voice memo 34

Red-eye

- in Playback mode 65
- in Shooting mode 38

Reset 79

Resizing 62

Resolution

- Photo 36
- Video 36

RGB tone

- in Playback mode 63
- in Shooting mode 50

Rotating 62

S

Scene mode 28

Self-Portrait 44

Service center 92

Settings

Accessing 77

Camera 79

Display 78

Sound 78

Shooting mode

DIS 31

Movie 32

Program 32

Scene 28

Smart Auto 27

Shutter speed 30

Slide show 58

Smart Album 55

Smart Auto mode 27

Smart button 14

Smart Filter

in Playback mode 64

in Shooting mode 51

Smile shot 44

Stabilizer 33

Start image 62, 78

T

Timer 37

Tracking focus 41

Transferring files

for Mac 74

for Windows 68

V

Video

Playing 59

Recording 32

Video Out 80

Viewing files

as thumbnails 56

by category 55

on TV 67

Slide show 58

Voice memo

Playing 60

Recording 34

Volume 78

W

White Balance 47

Z

Zoom button 13

Zooming 23



Please refer to the warranty that came with your product or visit our website <http://www.samsung.com/> for after-sales service or inquiries.

