

GXR

RICOH

GXR DIGITAL CAMERA BODY

Camera Body User Guide

The product serial number can be found on the bottom of the camera body.

Before You Begin

Before using your camera body, take a few moments to familiarize yourself with the controls and displays (pages 1–10). **Refer to this section as you read through the rest of the manual.**

Basic Photography and Playback

Read this section before using the camera for the first time. It covers the steps involved in readying the camera for use, taking photographs, and playing them back (pages 11–44).

Reference

Read this section for information on topics not covered in “Basic Photography and Playback.” It covers advanced shooting and playback options, and describes how to print photographs, customize camera settings, and copy pictures to a computer (pages 45–187).

The rechargeable battery needs to be charged before use. The battery is not charged at the time of purchase.

Package Contents

Confirm that the package contains the items listed below.

* The actual appearance of included items may differ.

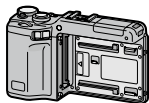

GXR camera body

The serial number can be found on the bottom of the camera body.



USB cable with mini-B connector

Connect the camera body to a computer or printer.



A/V cable

Connect the camera body to a TV.

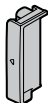

Connector Cap

The cap comes mounted on the camera body.



Hot shoe cover

The cover comes mounted on the hot shoe of the camera body.

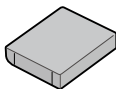

DB-90 rechargeable battery

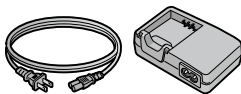

BJ-9 battery charger

- CD: Contains software and a *Software User Guide*.
- *Camera Body User Guide* (this manual)
- Neck strap
- Warranty

Tip: Attaching the Neck Strap

Put the ends of the neck strap through the strap eyelets on each side of the camera body, and thread the ends through the clips as shown.

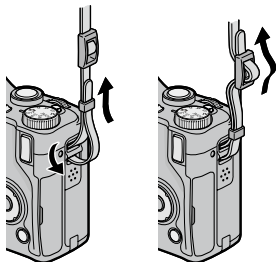

Notices

- **Safety precautions:** Read all safety precautions thoroughly to ensure safe use.
- **Test shots:** Take test shots to ensure that the camera is working properly before taking photos on important occasions.
- **Copyright:** Reproduction or alteration of copyrighted documents, magazines, and other materials, other than for personal, home, or other similarly limited purposes, without the consent of the copyright holder, is prohibited.
- **Exemption from liability:** Ricoh Co., Ltd. assumes no liability for failure to record or display images as a result of product malfunction.
- **Warranty:** This product is manufactured to local specifications and the warranty is valid within the country of purchase. The manufacturer assumes no responsibility for servicing the product in other countries or bearing any expense thereby incurred.
- **Radio interference:** Operating this product in the vicinity of other electronic equipment may adversely affect both the camera and the other device. Interference is particularly likely if the camera is used in close proximity to a radio or television. This can be resolved by moving the camera as far as possible from the other device, reorienting the radio or television antenna, or plugging the radio or television into a different outlet.

© 2009 RICOH CO., LTD. All rights reserved. This publication may not be reproduced in whole or in part without Ricoh's express written permission. Ricoh reserves the right to change the contents of this document at any time without prior notice.

Every effort has been made to ensure the accuracy of the information in this document. Should you nevertheless notice any errors or omissions, we would be grateful if you would notify us at the address listed on the back cover of this booklet.

Microsoft, Windows, Windows Vista, and Internet Explorer are registered trademarks of Microsoft Corporation in the United States of America and other countries. Macintosh and Mac OS are registered trademarks of Apple Inc. in the United States of America and other countries. Adobe, the Adobe logo, and Adobe Reader are trademarks of Adobe Systems Incorporated.



HDMI, the **HDMI** Logo and High-Definition Multimedia Interface are trademarks or registered trademarks of HDMI Licensing LLC.

All other trade names mentioned in this document are the property of their respective owners.







Safety Precautions

Warning Symbols

Various symbols are used throughout this instruction manual and on the product to prevent physical harm to you or other people and damage to property. The symbols and their meanings are explained below.



 Danger	This symbol indicates matters that may lead to imminent risk of death or serious injury if ignored or incorrectly handled.
 Warning	This symbol indicates matters that may lead to death or serious injury if ignored or incorrectly handled.
 Caution	This symbol indicates matters that may lead to injury or physical damage if ignored or incorrectly handled.

Sample Warnings

 The  symbol alerts you to actions that must be performed.
 The  symbol alerts you to prohibited actions. The  symbol may be combined with other symbols to indicate that a specific action is prohibited. Examples  Do not touch  Do not disassemble

Observe the following precautions to ensure safe use of this equipment.

Danger

-  Do not attempt to disassemble, repair or alter the equipment yourself. The high-voltage circuitry in the equipment poses significant electrical hazard.
-  Do not attempt to disassemble, alter or directly solder the battery.

-
-  Do not put the battery in a fire, attempt to heat it, use it in a high temperature environment such as next to a fire or inside a car, or abandon it. Do not put it into water or the sea or allow it to get wet.

 -  Do not attempt to pierce, hit, compress, drop, or subject the battery to any other severe impact or force.

 -  Do not use a battery that is significantly damaged or deformed.

Warning

-  Turn off the power immediately in the event of abnormalities such as smoke or unusual odors being emitted. Remove the battery as soon as possible, being careful to avoid electric shocks or burns. If you are drawing power from a household electrical outlet, be sure to unplug the power cord from the outlet to avoid fire or electrical hazards. Discontinue use of the equipment immediately if it is malfunctioning. Contact the nearest service center at your earliest convenience.

 -  Turn off the power immediately if any metallic object, water, liquid or other foreign object gets into the camera body. Remove the battery and memory card as soon as possible, being careful to avoid electric shocks or burns. If you are drawing power from a household electrical outlet, be sure to unplug the power cord from the outlet to avoid fire or electrical hazards. Discontinue use of the equipment immediately if it is malfunctioning. Contact the nearest service center at your earliest convenience.
-

-
-  Avoid any contact with the liquid crystal inside the picture display, should the monitor be damaged. Follow the appropriate emergency measures below.
- SKIN: If any of the liquid crystal gets on your skin, wipe it off and rinse the affected area thoroughly with water, then wash well with soap.
 - EYES: If it gets in your eyes, wash your eyes with clean water for at least 15 minutes and seek medical advice immediately.
 - INGESTION: If any of the liquid crystal is ingested, rinse the mouth out thoroughly with water. Have the person drink a large amount of water and induce vomiting. Seek medical assistance immediately.
-

-  Follow these precautions to prevent the battery from leaking, overheating, igniting or exploding.
- Do not use a battery other than those specifically recommended for the equipment.
 - Do not carry or store together with metal objects such as ballpoint pens, necklaces, coins, hairpins, etc.
 - Do not put the battery into a microwave or high pressure container.
 - If leakage of battery fluid or a strange odor, color change, etc. is noticed during use or during charging, remove the battery from the camera body or battery charger immediately and keep it away from fire.
-

-  Please observe the following in order to prevent fire, electrical shock or cracking of the battery while charging.
- Use only the indicated power supply voltage. Also avoid the use of multi-socket adapters and extension cords.
 - Do not damage, bundle or alter power cords. Also, do not place heavy objects on, stretch or bend power cords.
 - Do not connect or disconnect the power plug with wet hands. Always grip the plug section when disconnecting a power cord.
 - Do not cover equipment while charging.
-

 Keep the battery and SD memory card used in this equipment out of the reach of children to prevent accidental ingestion. Consumption is harmful to human beings. If swallowed, seek medical assistance immediately.

 Keep the equipment out of the reach of children.

 Do not touch the internal components of the equipment if they become exposed as a result of being dropped or damaged. The high-voltage circuitry in the equipment could lead to an electric shock. Remove the battery as soon as possible, being careful to avoid electric shocks or burns. Take the equipment to your nearest dealer or service center if it is damaged.

 Do not use the equipment in wet areas as this could result in fire or electric shock.

 Do not use the equipment near flammable gases, gasoline, benzene, thinner or similar substances to avoid the risk of explosion, fire or burns.

Do not use the equipment in locations where usage is restricted or prohibited as this may lead to disasters or accidents.

 Wipe off any dust that accumulates on the electrical plug as this may lead to fire.

 To avoid the risk of fire, electric shock or injury, do not use the battery charger with commercially available electronic transformers when traveling abroad.

Observe the following precautions to ensure safe use of this unit.

Caution

-  Contact with fluid leaking from a battery can lead to burns. If part of your body comes in contact with a damaged battery, rinse the area with water immediately. (Do not use soap.) If a battery starts to leak, remove it immediately from the equipment and wipe the battery chamber thoroughly before replacing it with a new battery.

-  Plug the power cords securely into the electrical outlets. Loose cords pose a fire hazard.

-  Do not allow the camera body to get wet. In addition, do not operate it with wet hands. Both pose the risk of electric shock.

-  Do not fire the flash at drivers of vehicles, as this may cause the driver to lose control and result in a traffic accident.

Safety Precautions for Accessories

When using optional products, carefully read the instructions provided with the product before using that product.

Product Manuals

The following manuals are provided with the GXR camera body:



Camera Body User Guide (this booklet)

This guide describes how to use your camera and install the supplied software.

* Read this guide along with the documentation provided with the camera unit.



Software User Guide (pdf file)

The *Software User Guide* describes how to copy pictures from your camera body to a computer for display and editing. It is available in several languages, each in its own folder in the “DC Manual” folder on the supplied CD.

For ease of reference, copy the pdf file from the CD to your computer hard disk.



“Irodio Photo & Video Studio” image viewing and editing software is also included with this product. For information on using this software, see the **Help** menu in Irodio Photo & Video Studio or telephone one of the following customer support centers:

- **North America (U. S. A.):** +1-800-458-4029 (toll free)
- **U. K., Germany, France, and Spain:** +800-1532-4865 (toll free)
- **Other European countries:** +44-1489-564-764
- **China:** +86-21-5385-3786
- **Other Asian countries:** +63-2-438-0090

Business hours: 9:00 AM to 5:00 PM

Table of Contents

Package Contents	ii
Notices	iii
Safety Precautions	iv
Product Manuals.....	ix

Before You Begin **1**

Read this section before using your camera body for the first time.

Introduction	2
Parts of the Camera Body	2

Basic Photography and Playback **11**

Read this section before using your camera for the first time.

First Steps..... **12**

Charging the Battery.....	12
Inserting the Battery	14
Inserting Memory Cards.....	15
Attaching the Camera Unit to the Camera Body.....	17
Turning the Power On and Off.....	18
Basic Setup.....	20

Taking Photographs..... **21**

Holding the Camera.....	21
Taking a Photograph.....	22
Zoom	26
Close-ups (Macro Mode).....	27
Flash Photography	28
Self-Timer	31
Tilt Indicator.....	32

Viewing and Deleting Photographs..... **34**

Viewing Photographs.....	34
Deleting Photographs.....	39
 (DISP) Button	42

Reference **45**

Read this section for more information on camera functions.

More on Photography	46
Mode P: Program Shift	46
Mode A: Aperture Priority	48
Mode S: Shutter Priority	49
Mode M: Manual Exposure	50
SCENE Mode: Settings for Various Scenes	52
"MY" Modes: Using Custom Settings.....	57
Shooting Menu	58
Playback Functions	94
Viewing Movies	94
Viewing MP Files	95
Playback Menu	101
Playback Menu	101
Viewing Pictures on TV	118
Printing Photographs	120
Connecting the Camera Body	120
Printing	122
Camera Settings	126
Key Custom Options	129
Setup.....	139
Copying Pictures to a Computer	151
Windows.....	151
Macintosh.....	162
Technical Notes	167
Troubleshooting	167
Specifications.....	175
Optional Accessories	178
Using the Product Abroad.....	183
Precautions for Use	183
Care and Storage.....	185
Warranty and Servicing	186
NOTICES	187
Index	188

Before You Begin

Read this section before using your camera body for the first time.

■ Introduction	2
----------------------	---

Introduction

This manual describes how to take pictures and play them back. To ensure that you get the most from this product, read this manual thoroughly before use and keep it handy when using the product.

Parts of the Camera Body

For more information, refer to the page number to the right of each item.

Front

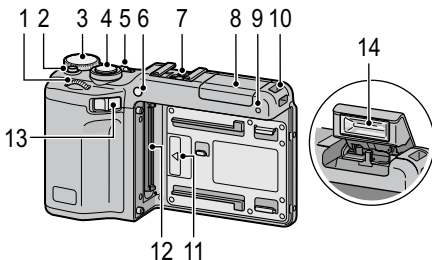

- | | | | |
|---------------------------------------|---------|---|----|
| 1 Up-down dial | 5 | 9 Microphone | - |
| 2 Mode dial lock release | 4 | 10 Strap eyelet | ii |
| 3 Mode dial | 4 | 11 Alignment mark for attaching
camera unit | 17 |
| 4 Shutter-release button | 21, 23 | 12 Connector | 17 |
| 5 Power switch | 18, 21 | 13 Camera unit release lever | 17 |
| 6 AF auxiliary light | 31, 140 | 14 Flash | 28 |
| 7 Hot shoe | 181 | | |
| 8 Flash cover | 29 | | |

Back

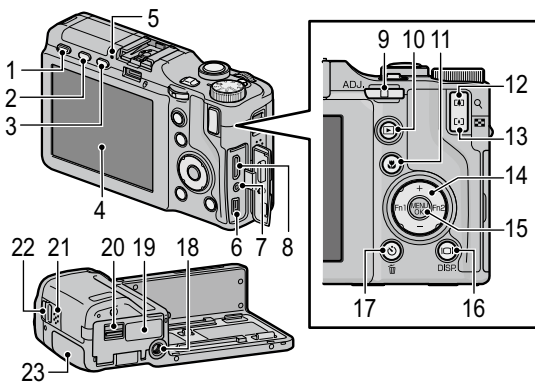

- | | | | |
|---|--------------------|---|--------------|
| 1 DIRECT button | 5 | 14 Directional pad..... | 37 |
| 2 OPEN/ (flash) button..... | 29 | + (▲)..... | 137 |
| 3 VF/LCD button..... | 42 | - (▼)..... | 137 |
| 4 Picture display | 8 | Fn1 (Function1) (◀)..... | 136 |
| 5 Autofocus/flash lamp | | Fn2 (Function2) (▶)..... | 136 |
| | 18, 22, 29, 141 | 15 MENU/OK button | |
| 6 Connector for USB cable | | | 58, 101, 126 |
| | 120, 159, 160, 162 | 16 (DISP.) button | 42 |
| 7 Connector for A/V cable..... | 118 | 17 (self-timer)/ (delete) button | |
| 8 Connector for HDMI mini cable... | 119 | | 31, 39 |
| 9 ADJ. lever | 5, 134 | 18 Tripod screw hole | 176 |
| 10 (playback) button | | 19 Battery/card cover..... | 14, 15 |
| | 19, 34, 94, 101 | 20 Release lever | 14, 15 |
| 11 (macro) button..... | 27 | 21 Speaker | - |
| 12 (telephoto)/ (enlarged | | 22 Strap eyelet | ii |
| view) button | 26, 36 | 23 Connector cover..... | 118, 121 |
| 13 (wide-angle)/ (thumbnail | | | |
| display) button..... | 26, 36 | | |

Mode Dial

Before shooting, press the mode dial lock release (①) and rotate the mode dial to choose a shooting mode (②).

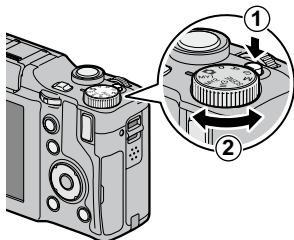

P (program shift):

You choose from combinations of shutter speed and aperture that produce the same exposure (page 46).

A (aperture priority):

You choose an aperture and let the camera adjust the shutter speed for optimal exposure (page 48).

S (shutter priority):

You choose a shutter speed and let the camera adjust aperture for optimal exposure (page 49).

 **(auto):** The camera sets shutter speed and aperture for optimal exposure (page 21).

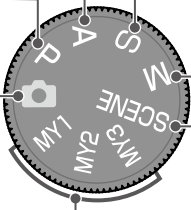

M (manual exposure):

You choose shutter speed and aperture (page 50).

MY1, MY2, MY3 ("my settings"): Recall settings saved using **Reg. My Settings** (pages 57, 129).

SCENE (scene):

Optimize settings for the current subject or scene, or shoot movies (page 52).

Up-down Dial and ADJ. Lever

When viewing pictures or navigating the menus, you can use the up-down dial in place of + and –, and the ADJ. lever in place of Fn1 and Fn2. The ADJ. lever and up-down dial can also be used to select shutter speed and aperture in P, A, S, and M modes.

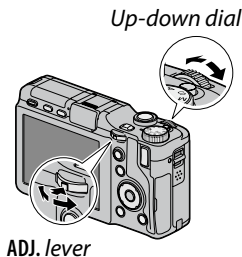

You can assign frequently-used shooting menu items to the ADJ. lever for easy access (page 134). To display a shooting menu item, center the ADJ. lever and press it in; you can then use the lever and up-down dial to select an option.

Note

The **M Mode Dial Options** and **Playback Mode Dial Options** items in the key custom options tab can be used to change the assigned functions of the up-down dial and ADJ. lever (page 138).

DIRECT Button

Press the **DIRECT** button in the shooting mode to display the current shooting settings.

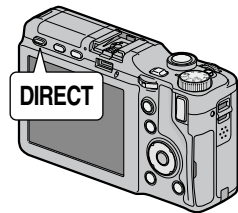

DIRECT screen

For more information, refer to the page number to the right of each item.

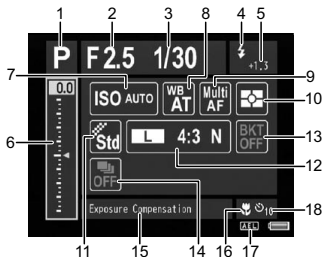

1 Shooting mode.....	4	10 Exposure metering	70
2 Aperture.....	46, 48, 50	11 Image settings	71
3 Shutter speed	46, 49, 50	12 Picture quality/size/movie size.....	61
4 Flash mode.....	28	13 Bracketing.....	75
5 Flash compensation/manual flash amount.....	78, 79	14 Continuous.....	73
6 Exposure compensation	85	15 Information area	7
7 ISO.....	90	16 Macro mode	27
8 White balance	86	17 AE Lock.....	136
9 Focus mode	64	18 Self-timer.....	31

Changing the Shooting Settings on the DIRECT screen

On the DIRECT screen, move the cursor using +, -, Fn1, Fn2 or the ADJ. lever (left and right) to highlight an item, and change the setting directly using the up-down dial. The exposure compensation can be adjusted using + and - instead of the up-down dial.

Displaying the Options for the Shooting Settings

Pressing the **ADJ.** lever when an item is highlighted on the **DIRECT** screen displays the options for the setting item. Select the desired option using + and –, or the up-down dial, and then press the **ADJ.** lever or the **MENU/OK** button to set the option.



Caution

The settings of shooting mode, macro mode, self-timer, and flash mode for built-in flash cannot be changed by selecting the item on the **DIRECT** screen. Change the settings using the mode dial or the buttons on the camera body.



Notes

- Pressing the **DISP.** button changes the setting of background image (page 140).
- Pressing **MENU/OK** on the **DIRECT** screen will display the shooting menu (page 59).
- After setting the exposure compensation, press **Fn1**, **Fn2**, or the **ADJ.** lever (left or right) to move the cursor to other items.
- When in manual exposure mode, the exposure indicator to achieve optical exposure will be displayed instead of the exposure compensation slider.
- When in program shift mode, the value of shutter speed and aperture will be changed at the same time to produce the same exposure.
- The item name of shooting menu corresponding to the selected item on the **DIRECT** screen will be displayed in the information area.

Displaying the Next or Previous Page

If the items displayed on a screen extends over multiple pages, you can display the next or previous page by pressing + or –, or rotating the up-down dial while pressing the **DIRECT** button.

Picture Display

The following indicators may be displayed during shooting and playback.

Shooting (still photography)

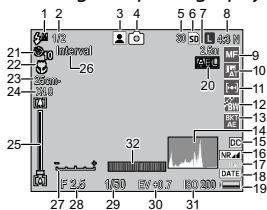

Shooting (movie mode)

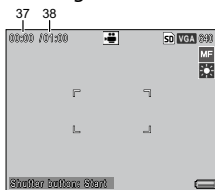

- | | | |
|---|--|--|
| 1 Flash mode..... 28 | 9 Focus mode/full press snap64, 69 | 18 Date imprint..... 84 |
| 2 Flash compensation/manual flash amount78, 79 | 10 White balance/white balance compensation ...86, 89 | 19 Battery level..... 10 |
| 3 Scene mode..... 52 | 11 Exposure metering 70 | 20 Autoexposure lock 136 |
| Continuous.....73 | 12 Image settings 71 | 21 Self-timer..... 31 |
| 4 Shooting mode..... 4 | 13 Bracketing..... 75 | 22 Macro mode 27 |
| 5 Number of exposures remaining* 177 | 14 Histogram 44 | 23 Minimum shooting distance..... 144 |
| 6 Destination..... 15 | 15 Distortion correction 81 | 24 Digital zoom ratio 26 |
| 7 Snap focus distance64, 68 | 16 Noise reduction 80 | 25 Zoom bar..... 26 |
| 8 Picture quality/size 61 | 17 Camera shake correction 92 | 26 Interval shooting... 83 |
| | | 27 Exposure indicator 50 |
| | | 28 Aperture.....46, 48, 50 |

- | | | |
|---------------------------------------|---------------------------------|----------------------------------|
| 29 Shutter speed | 32 Tilt indicator | 36 Focus bar |
| 46, 49, 50 | 33 Exposure warning..... | 37 Movie length |
| 30 Exposure compensation | 86 | 38 Time available * |
| 85 | 34 Blur warning ... | 55 |
| 31 ISO..... | 24, 93 | |
| 90 | 35 Depth of field | |
| | 64 | |

* Approximation only; actual capacity varies with shooting conditions and make of memory card. Display shows "9999" when memory remains for over 9,999 images.



Note

The shooting settings can be viewed by pressing the **DIRECT** button (page 5).

Playback (photographs)

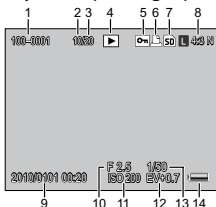

- | | |
|--|---------------------------------------|
| 1 File number | 8 Picture quality/size |
| 2 | 61 |
| 2 Current frame | 9 Date of recording |
| 3 | 20, 149 |
| 3 Total frames | 10 Aperture..... |
| 4 | 46, 48, 50 |
| 4 Playback mode indicator | 11 ISO..... |
| 5 | 90 |
| 5 Protected image.. | 12 Exposure compensation |
| 112 | 85 |
| 6 DPOF print indicator | 13 Shutter speed |
| 115 | 46, 49, 50 |
| 7 Source | 14 Battery level |
| 15 | 10 |

Playback (movies)

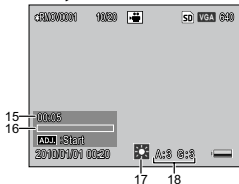

- | | |
|--|--|
| 15 Length/elapsed time | 16 Progress indicator.... |
| 15 | 17 |
| 15 Length/elapsed time | 17 White balance |
| 15 | 86 |
| 16 Progress indicator.... | 18 White balance compensation |
| 17 | 89 |
| 17 White balance | |
| 86 | |
| 18 White balance compensation | |
| 89 | |



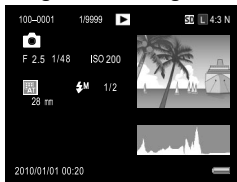

Notes

- The picture display may also display warnings and messages.
- Additional information can be viewed by pressing the **DISP.** button (page 42).



The Battery Level Indicator

Battery level is shown by the icon at the bottom right corner of the picture display.

Icon	Description
 (green)	Battery fully charged.
 (green)	Battery partially discharged.
 (orange)	Low battery. Charge or replace as soon as possible.

Basic Photography and Playback

Read this section before using your camera for the first time.

■ First Steps	12
■ Taking Photographs	21
■ Viewing and Deleting Photographs.....	34

First Steps

Prepare the camera for use.

Charging the Battery

The rechargeable battery (DB-90) supplied with the camera body is not charged at the time of purchase. Charge the battery in the supplied BJ-9 battery charger before use.

1 Place the battery in the charger.

Place the battery label up with the “+” and “-” labels oriented to match the labels on the charger.

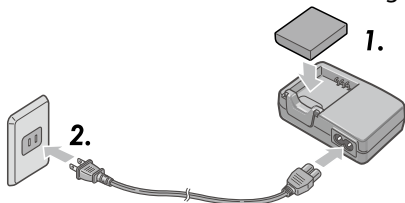

Caution

Be sure the battery is in the correct orientation.

2 Connect the power cord to the charger, and then plug in.

The charger lamp will light while the battery charges. An exhausted battery will recharge in about five hours at 25 °C.

Note

If the charger lamp blinks, a battery or charger fault may have occurred. Unplug the power cord and remove the battery from the charger.

3 Remove the battery.

Charging is complete when the charger lamp turns off. Unplug the power cord and remove the battery from the charger.



Cautions

- **Rechargeable Li-ion battery:** Use only a genuine DB-90 battery. Do not use a battery not specifically designated by Ricoh for use in this camera body.
- The battery may be hot immediately after use. Before removing the battery, turn the power off and wait for the battery to cool down.
- Remove the battery if the camera will not be used for extended periods.



Tip: Battery Capacity

The number of shots that can be taken with a fully-charged DB-90 battery differs depending on the camera unit. The tests are conducted according to CIPA standards under the following conditions: at the temperature of 23 °C (73 °F); with the picture display on; shoot every 30 seconds with flash fired every other shot; turn the camera off and on every 10 shots taken. See the documentation provided with the camera unit for details.

Inserting the Battery

Be sure the power is off before inserting or removing the battery.

1 Open the battery/card cover.

Unlatch (1) and open (2) the cover.

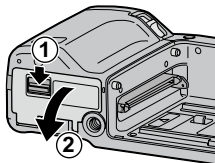

2 Insert the battery.

Using the battery to keep the battery latch pressed downward, slide the battery in. The latch will click into place when the battery is fully inserted.

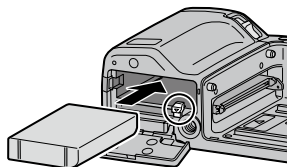

3 Close the battery/card cover.

Close (1) and latch (2) the cover.

Caution ~~~~~

Be sure the cover is latched.

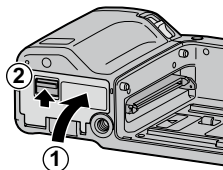

Removing the Battery

Unlatch and open the battery/card cover, press the latch downward to release it, and then remove the battery. Be careful not to drop the battery.

Caution ~~~~~

If the camera will not be used for an extended period, remove and store the battery in a cool dry place.

Inserting Memory Cards

Pictures can be stored in the camera body's 86 MB internal memory, or optional SD and SDHC memory cards. Internal memory is used if no card is inserted; if a card is inserted, the card will be used instead.

Be sure the power is off before inserting or removing a memory card.

1 Open the battery/card cover.

Unlatch (1) and open (2) the cover.

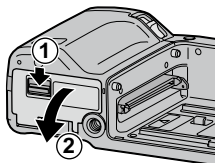

2 Insert the card.

Holding the memory card in the orientation as shown, slide it in until it clicks into place.

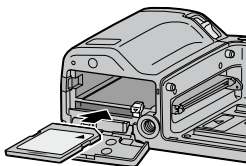

3 Close the battery/card cover.

Close (1) and latch (2) the cover.

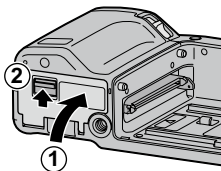

Removing Memory Cards

Unlatch and open the battery/card cover, and then press the memory card in to eject it. The card can then be removed.

Cautions

- Pictures will not be saved to internal memory when a memory card is inserted, even if the memory card is full.
- Keep the memory card contacts clean.

Tip: Write Protection

Slide the write-protection switch on memory card to “**LOCK**” to keep data from being written to or deleted from the card and to prevent the card from being formatted.

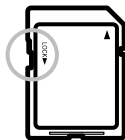

Pictures cannot be taken when the memory card is locked; lock the card only to prevent accidental loss of data and be sure to unlock the card before shooting.

Notes

- Format memory cards before first use or after they have been used in a computer or other device (page 139). Be sure to back up any important data before formatting.
- See page 177 for information on memory card capacity.
- Pictures can be copied to memory cards from internal memory (page 115).

Attaching the Camera Unit to the Camera Body

Be sure the power is off before attaching or removing the camera unit to/from the camera body.

Remove the connector caps from the camera body and camera unit respectively. Align the left side of the camera unit with the alignment mark on the camera body, and then slide the camera unit to the left until it clicks.

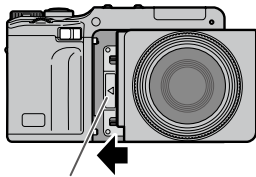

Alignment mark for attaching camera unit

Removing the Camera Unit from the Camera Body

Slide the camera unit release lever to the right, and remove the camera unit.

Be careful not to drop the camera body and camera unit when removing the camera unit from the camera body.

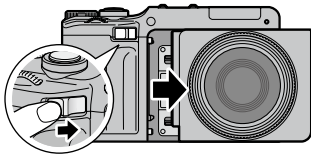

Turning the Power On and Off

Shooting Mode

Slide the power switch to **ON** to turn the camera on. The camera will play the start-up sound. The autofocus/flash lamp blinks for several seconds while the camera starts up.

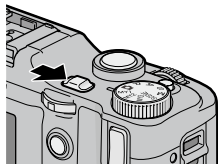

To turn the camera off, slide the power switch to **OFF**. The number of pictures taken so far that day will be displayed before the camera turns off (zero is displayed if the camera clock has not

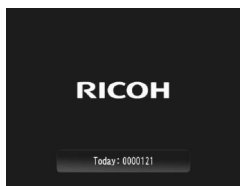



been set; if you turn the camera off after changing the clock (page 20), the camera will display the number of pictures taken after the clock setting was changed).

Caution

Changes to continuous (page 73), interval (page 83), and self-timer (page 31) settings are lost when the camera is turned off. Turning the camera off restores settings for **MY** modes to the values saved with **Reg. My Settings**. Other settings are unaffected.

Playback Mode

When the power is off, pressing the  button for about a second turns the camera on in playback mode. Press the  button again to turn the power off.

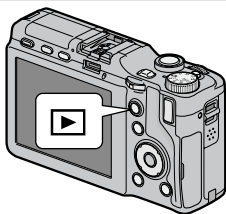

Tip: Sleep Mode and Auto Power Off

The camera will turn the display or power off automatically to save power if no operations are performed for the specified time in the **Sleep Mode** (page 141) and **Auto Power Off** (page 141).

Basic Setup

A language-selection dialog is displayed the first time the camera is turned on. Follow the steps below to choose a language and set the time and date. To exit before setup is complete, press the **DISP.** button. The language, time, and date can be changed at any time in the setup menu (page 149).

1 Select a language.

Press **+**, **-**, **Fn1**, or **Fn2** to highlight a language, and press **MENU/OK**.



2 Set the clock.

Press **Fn1** or **Fn2** to highlight the year, month, day, hour, minute, or date format, and then press **+** or **-** to change. After checking that the date is correct, press **MENU/OK**. A confirmation dialog will be displayed; press **MENU/OK** to set the clock.

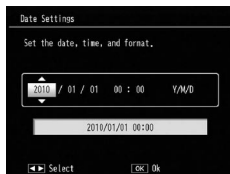

Notes

- If you leave the battery in the camera body for at least two hours, the clock and language settings are retained for about a week after the battery was removed.
- The time and date of recording can be imprinted on photographs (page 84).

Taking Photographs

After setting up the camera as described in “First Steps” (page 12), you are ready to take photographs. Slide the power switch to **ON** to turn the camera on, and rotate the mode dial to .

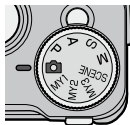

Holding the Camera

1 Hold the camera in both hands.

Hold the camera in both hands with your elbows lightly pressed against your body.



Caution

Be sure that your fingers, hair or the neck strap do not obstruct the lens or flash.

2 Get ready to shoot.

Rest the finger on the shutter-release button.



Taking a Photograph

1 Focus.

Frame your subject in the center of the picture display and press the shutter-release button halfway to set focus and exposure.

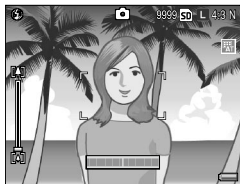

If the camera is able to focus, the focus frames for the objects in focus are displayed in green (up to nine frames).

If the camera is unable to focus, the focus frame blinks red and the autofocus/flash lamp blinks green.

Autofocus/flash lamp

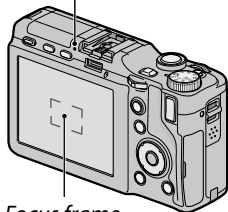

Focus frame

2 Take a picture.

Gently press the shutter-release button the rest of the way down to take the picture. The picture is displayed immediately after shooting for a few seconds (page 142), and saved to internal memory or memory card.



Tip: Shutter-Release Button

The camera has a two-stage shutter-release button. To focus, lightly press the shutter-release button until you feel resistance. This is called “pressing the shutter-release button halfway.” Press the shutter-release button the rest of the way down to shoot.



Tip: Focus

The autofocus/flash lamp and the focus frame show whether the subject is in focus.

Focus status	Focus frame	Autofocus/flash lamp
Before focusing	White	Off
Subject in focus	Green	On (green)
Unable to focus	Red (blinks)	Blinks (green)

The camera may be unable to focus on the following:

- Objects that lack contrast, such as the sky, a wall that is only one color, or the hood of a car
- Flat objects containing only horizontal lines
- Fast-moving objects
- Objects that are poorly lit
- Objects with bright reflections or backlighting
- Flickering objects, such as fluorescent lights
- Point light sources, such as light bulbs, spotlights, or LEDs



Note that one or more focus frames may be displayed in green even if the camera is unable to focus on the above subjects; check focus in the picture display before shooting. If the camera is unable to focus, lock focus on another object at the same distance from the camera as your subject, then recompose the photograph and take the picture (page 25).

**Tip: Avoiding Blurred Pictures**

To prevent blurring caused by the camera movement when the shutter is released (“camera shake”), press the shutter-release button smoothly and gently. Blurring is particularly likely to occur if:

- The flash is off and lighting is poor
- Using digital zoom (page 26)

In situations in which photographs are especially prone to blurring caused by camera shake, a  icon will be displayed in the picture display. Hold the camera steady and try focusing again, or attempt one of the followings:

- Turning the flash on () or using auto flash (; see page 28)
- Choosing a higher ISO (page 90)
- Using the self-timer (page 31)
- Using the camera shake correction (page 92)

**Notes**

- If the flash will fire when the picture is taken, a pre-flash will be emitted to assist focus and exposure.
- In the case of overexposure or underexposure, a  AE icon will be displayed.
- You can choose how long pictures are displayed in the picture display after shooting. If desired, photographs can be displayed until the shutter-release button is pressed halfway (page 142).

Focus Lock

Use focus lock to compose photographs in which the subject is not in the center of the frame. Focus lock can also be used if the camera is unable to focus.

1 Focus.

Position your subject in the center of the picture display and press the shutter-release button halfway to focus.

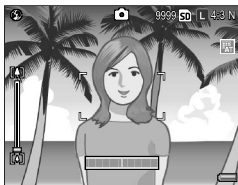

2 Recompose the photograph.

Keeping the shutter-release button pressed halfway to lock focus, recompose the photograph.

Final composition



Main subject



3 Take a picture.



Gently press the shutter-release button the rest of the way down to take the picture.



Caution

If the distance between the camera and subject changes while focus lock is in effect, focus again at the new distance.

Zoom

The  (telephoto) button can be used to zoom in and the  (wide-angle) button to zoom out.

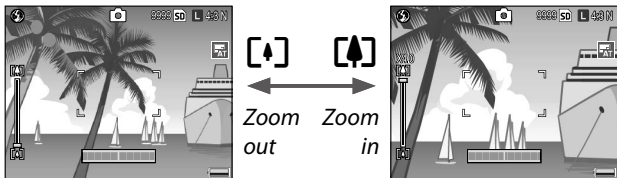

1 Frame the picture using the  and  buttons.

2 Focus.



Press the shutter-release button halfway.

3 Take a picture.

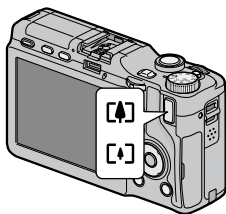
Gently press the shutter-release button the rest of the way down.





Notes

- If using the camera unit without optical zoom, digital zoom works instead of optical zoom.
- If using a camera unit equipped with optical and digital zoom, to switch from optical zoom to digital zoom, release the  button once at the maximum magnification by the optical zoom, and then press the  button again. To switch from digital zoom to optical zoom, press and hold the  button.
- You can check the amount of optical zoom with the zoom bar in the picture display. When using the digital zoom, the zoom ratio is displayed in the picture display.
- When **RAW** is selected for **Picture Quality/Size** (page 61), digital zoom cannot be used.

Close-ups (Macro Mode)

Use macro mode for close-ups of small objects.

1 Press the button.

A  icon will be briefly displayed in the center of the picture display.  will then appear at the upper left of the display.

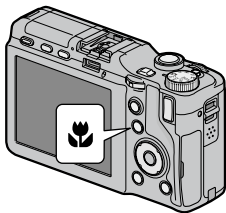

2 Focus.

Frame the subject in the picture display and press the shutter-release button halfway.

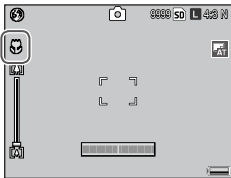

3 Take a picture.

Gently press the shutter-release button the rest of the way down.

To exit macro mode, press the  button again.









Note

Even if **Multi AF**, **Snap**, ∞ is selected for **Focus**, **Spot AF** is used in macro mode (page 64).

Flash Photography

The flash only fires when it is raised. Press the **OPEN/⚡** button to raise the flash, and press the button again to choose from the following flash modes:

Mode	Description
 Flash Off	The flash is off.
 Auto	The flash fires automatically when required.
 Red-Eye Flash	Reduces “red-eye” in portraits taken with the flash.
 Flash On	The flash fires with every shot.
 Flash Synchro.	Combines the flash with slow shutter speeds. Use when taking portraits that include details of the background or nightscape. Use of a tripod is recommended to prevent blur.
 Manual Flash	The flash fires with every shot. The amount of flash can be set in Manual Flash Amount (page 79).

Note =====

The effective range of the flash differs depending on the camera unit. See the documentation provided with the camera unit for details.

- 1 Raise the flash.**
Press the **OPEN/⚡** button.

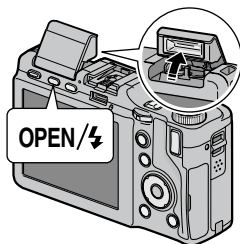

- 2 Select a flash mode.**
Press the **OPEN/⚡** button to select a flash mode. The flash mode icon appears at the top left corner of the display.

Notes

- The selected flash mode remains in effect until a new mode is chosen.
- The autofocus/flash lamp blinks while the flash charges. Photographs can be taken when the lamp stops blinking.

- 3 Focus and shoot.**
If the flash will fire when the picture is taken, a pre-flash will be emitted to assist focus and exposure.

**Notes**

- To close the flash when it is not in use, gently press the center of the flash cover down until it latches.
- The flash turns off automatically in movie, continuous, and bracketing modes.
- Do not use the built-in flash when an optional flash is attached. Failure to observe this precaution could cause damage to the product.

**Caution**

Do not use the flash unit in close proximity to your subject's eyes. Particular care should be observed when photographing infants. Do not direct the flash at the operator of a motor vehicle.

Self-Timer

Choose from ten-second, two-second, and custom setting timers. Use the two-second timer to prevent blur caused by camera movement when the shutter-release button is pressed. With the custom setting, a specified number of pictures can be taken at a specified interval. Set the shooting interval and number of pictures with **Custom Self-Timer** in the shooting menu (page 82).

1 Choose a self-timer mode.

Press the  button once to select the ten-second timer, twice to select the two-second timer, and three times to select the custom setting timer. Pressing the button the fourth time turns the timer off.

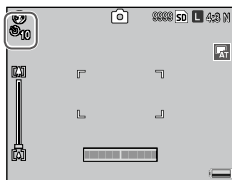

The current selection is displayed in the picture display.



Note

The selected self-timer mode remains in effect until a new mode is chosen.

2 Start the timer.

Press the shutter-release button to lock focus and start the timer. If the ten-second timer or custom setting timer is selected, the AF auxiliary light will light.



Note

Press **MENU/OK** to cancel the custom setting timer during shooting.

Tilt Indicator

Use the tilt indicator to level the camera when photographing buildings or landscapes. It is particularly useful for compositions in which the horizon is visible.

1 Display options.

Press and hold the  (DISP.) button until level setting options are displayed.

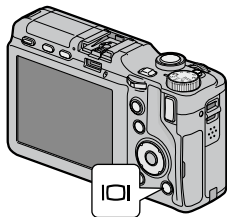

2 Select an option.

Press + or – to highlight an option, and press MENU/OK to select the highlighted option.

Option	Description
Off	Tilt indicator is not displayed.
Display	Tilt indicator is shown in the picture display. The amount and direction of tilt can be checked in the tilt indicator. The indicator turns green when the camera is level, orange when the camera is tilted, and red if the degree of tilt exceeds the maximum degree that can be displayed with the indicator. Tilt indicator is not shown if the display is off, indicators are hidden, or the framing grid is displayed (page 42).
Disp + Snd	Same as Display , except that a beep sounds periodically when the camera is level.
Sound	A beep sounds periodically when the camera is level. The tilt indicator is not displayed in the picture display.

Understanding the Tilt Indicator

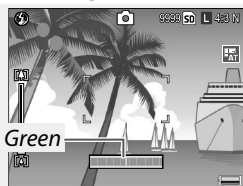

Camera level



Camera tilted left



Camera tilted too far to the right



Camera tilted 90° left



Note

Tilt indicator settings can also be adjusted in the setup menu (page 144).



Cautions

- The tilt indicator is not displayed when the camera is upside down, movies are being recorded, or the interval timer is on.
- The beep does not sound if the camera's volume is set off (page 142).
- The tilt indicator is intended as a guide only and should not be used as a spirit level or in other applications in which a high degree of precision is required. Accuracy drops when the camera is in motion or you are shooting on a vehicle or other moving platform.

Viewing and Deleting Photographs

Pictures can be viewed in the picture display.

Viewing Photographs

Press the  button in shooting mode to display the last photograph viewed.

Press the  button again to exit to shooting mode.

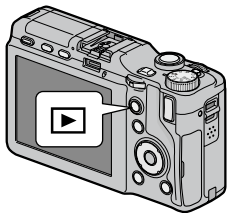

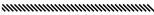
 **Tip: If the Camera Is Off** 

If the power is off, press the  button for about a second to turn the camera on in playback mode.

Press **Fn2** to view photographs in the recorded order, **Fn1** to view in reverse order. Press **-** to skip ten frames ahead, **+** to go back ten frames.

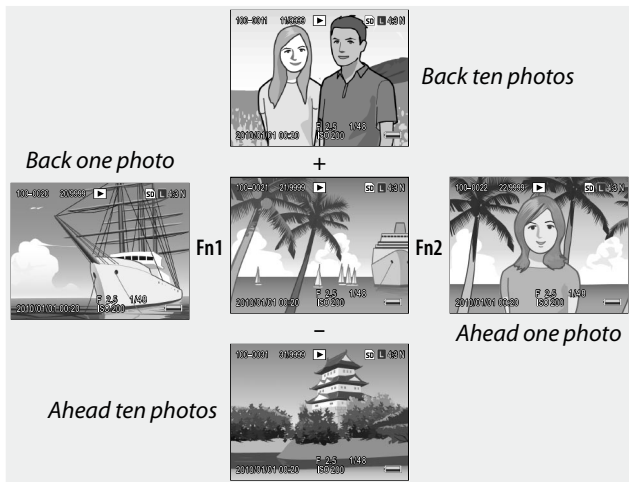

Caution

The camera records JPEG copies of RAW images for display in the picture display. When a RAW image is selected for playback, the camera shows the JPEG copy and a RAW indicator is displayed. If the JPEG copy has been deleted using a computer or other device, the camera will display a small preview of the RAW image, but you will not be able to view the image at larger magnifications. See pages 62, 63 for information on recording RAW images.

Tip: Viewing Pictures in Shooting Mode

Photographs are displayed in the picture display immediately after shooting. You can choose how long pictures are displayed using **LCD Confirmation Time** in the setup tab (page 142).



Tip: Viewing the Pictures in Internal Memory

If a memory card is inserted, the pictures on the memory card will be displayed; the pictures in internal memory cannot be viewed even if the memory card is empty. The pictures in internal memory will only be displayed if no card is inserted in the camera body.

Tip: Auto Rotate

If **On** is selected for **Auto Rotate** in the setup tab (page 143), pictures will be automatically displayed in the correct orientation in the picture display.

Viewing Multiple Photographs

Press the  or  button to choose the number of photographs to display from one, 20, and 81, or to choose to sort photographs by the date that photographs were taken.

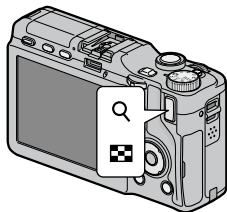

Single frame



20 frames

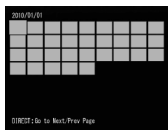

Sort by date

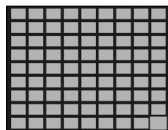

81 frames

Multi-frame views can be used to select images for display or deletion.

In multi-frame views, use the directional pad to highlight photographs.



Tip: Directional Pad

The cursor can be moved in an oblique direction by pressing the diagonal portions on the directional pad.





Notes

- To display a photograph full frame, press the **ADJ.** lever in multi-frame view.
- To display the photographs on the previous or next page in the multi-frame view:
 - In the 20- and 81-frame view, press +, -, **Fn1**, **Fn2**, or **ADJ.** lever (left or right), or rotating the up-down dial while pressing the **DIRECT** button.
 - In the sort by date view, pressing + or -, or rotating the up-down dial while pressing the **DIRECT** button displays the next or previous page. Pressing **Fn1**, **Fn2**, or **ADJ.** lever (left or right) while pressing the **DIRECT** button displays the photographs taken next or previous date. If pressing **Fn2**, or **ADJ.** lever to the right with the cursor at the last photograph, the photographs taken the next date is displayed.

Playback Zoom

Press the  button or rotate the up-down dial to the right to zoom in on the photograph currently displayed full frame. To zoom in to the magnification selected with **One Press Zoom Ratio** (page 143), press the **ADJ.** lever.

The following operations can be performed:

Use	To
	Zoom in.
Up-down dial	Rotate right to zoom in, left to zoom out.
MENU/OK	When an image is magnified, press to display the image in the magnification ratio selected for One Press Zoom Ratio . If an image is displayed at the magnification selected for One Press Zoom Ratio , pressing MENU/OK cancels zoom.
Directional pad	Move the areas to be displayed.
ADJ. lever	Press left or right to view other images at same zoom ratio.
	Zoom out.



Notes

- Maximum magnification varies with image size:

Image size	Maximum magnification
L, M, 5M, 3M	16×
1M	6.7×
VGA	3.4×

- Playback zoom is not available with movies or pictures taken using **M-Cont Plus**.
- If **Setting2** is selected for **Playback Mode Dial Options** in the key custom options tab (page 138), the **ADJ.** lever and up-down dial can be used to view other areas of the image.

Deleting Photographs

Follow the steps below to delete photographs.

Deleting Individual Photographs

- 1 Display a photograph.**
Display a photograph you want to delete in single-frame playback (page 34).
- 2 Press the  button.**
The options will be displayed (you can change the photograph by pressing Fn1 or Fn2).



- 3 Select Delete One.**
Press + or - to highlight **Delete One**, and press MENU/OK.
A message is displayed during deletion. Repeat steps 2 and 3 to delete additional photographs, or highlight **Cancel** and press MENU/OK to exit.

Deleting All Files

To delete all files, press the  button to display delete options as described above, and select **Delete All**. A confirmation dialog will be displayed; press Fn1 or Fn2 to highlight **Yes**, and press MENU/OK.

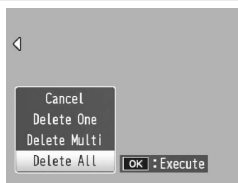

Deleting Multiple Files

Follow the steps below to delete multiple files.

1 Press the button.

In multi-frame playback, proceed to step 2. In single-frame playback, the options shown at right will be displayed. Highlight **Delete Multi** and press MENU/OK.



2 Select **Sel. Individ.** or **Sel. Range**.



To select images one at a time, highlight **Sel. Individ.**, press MENU/OK, and proceed to step 3. To select images by specifying ranges, highlight **Sel. Range**, press MENU/OK, and proceed to step 3.1. Press the DISP. button to exit at any time without deleting files.

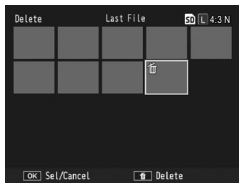

3 Select a photograph.

Use the directional pad (page 37) to highlight photographs, and press MENU/OK. Selected picture is marked with a  icon. To deselect a photograph, highlight it and press MENU/OK again.



 **Tip: Selecting Ranges** 

To switch from **Sel. Individ.** to **Sel. Range**, press the **ADJ.** lever and follow the steps below:

- 3.1** Use the directional pad to highlight the first image of a range, and press **MENU/OK** to select. The selected image is marked with a  icon. To deselect the image, press the **DISP.** button.

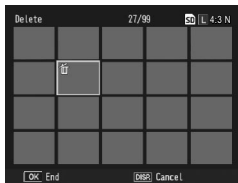

- 3.2** Use the directional pad to highlight the last image, and press **MENU/OK** to select. The selected images are marked with a  icon.

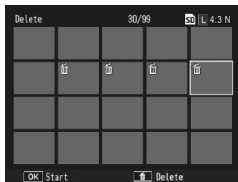

Repeat steps 3.1–3.2 to select additional ranges, or press the **ADJ.** lever to return to step 3 to select or deselect individual photographs.

- 4** Press the  button.
A confirmation dialog will be displayed.

- 5** Select **Yes**.
Press **Fn1** or **Fn2** to highlight **Yes**, and press **MENU/OK**.

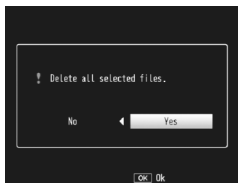

(DISP.) Button

Press the  (DISP.) button to display the information in the picture display in shooting and playback modes.

Turning the Picture Display On/Off

Pressing the **VF/LCD** button while the picture display is on turns the picture display off. Some camera operations are not available when the picture display is off. Pressing the **VF/LCD** button again turns the picture display on.

When a LCD viewfinder is attached, pressing the **VF/LCD** button switches between the LCD viewfinder and the picture display.

Shooting Mode

Press the  (DISP.) button to cycle through the following displays:

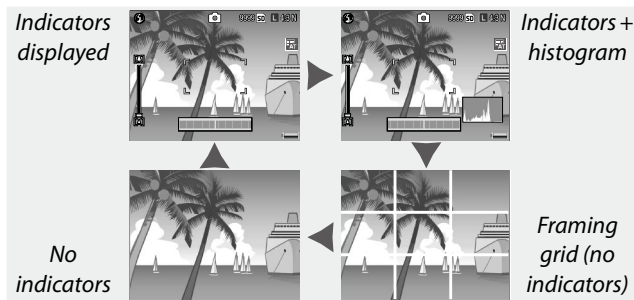

Tip: The Framing Grid

See page 144 on choosing a type of framing grid.

**Note**

If **Display** or **Disp + Snd** is selected for **Level Setting** (page 32), a tilt indicator appears when indicators are displayed.

Playback Mode

Press the  (**DISP.**) button to cycle through the following displays:

**Tip: Highlights**

The flashing portions of the highlights display indicate “washed out” areas in which details may have been lost to overexposure. Check images with the highlights display after shooting in direct sunlight or in other conditions in which parts of the image may be overexposed. If it seems important details may have been lost, choose a lower exposure compensation value and shoot again (page 85). Note that the display is intended only as a guide and may not be entirely accurate.



Tip: Histogram

The histogram is a graph showing the distribution of pixels of different brightness in the image. Brightness is plotted on the horizontal axis, with shadows at the left and highlights at the right. The vertical axis gives the number of pixels. The histogram can be used to assess exposure and check for loss of detail in highlights and shadows without the brightness of your surroundings affecting your judgement. A histogram in which pixels are clustered on the right indicates that the image may be overexposed, while a histogram in which pixels are clustered on the left indicates that the image may be underexposed.

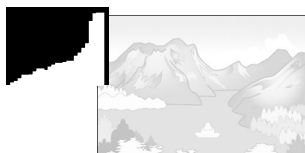

Overexposed



Underexposed

If the image appears to be incorrectly exposed, you may be able to use exposure compensation to correct exposure in subsequent photographs of the same subject (page 85; note that exposure compensation may be insufficient to produce the correct exposure in some cases). The histogram can also be used as a guide when adjusting contrast in photographs after shooting (page 107).

The histogram is intended as a guide only and may not be completely accurate, particularly in cases in which the flash is used or ambient lighting is poor.

Reference

Read this section for more information on camera functions.

■ More on Photography.....	46
■ Playback Functions.....	94
■ Playback Menu.....	101
■ Printing Photographs.....	120
■ Camera Settings.....	126
■ Copying Pictures to a Computer	151
■ Technical Notes	167

More on Photography

This section provides information on P, A, S, M, **SCENE**, and MY modes and on using shooting menu options.

Mode P: Program Shift

When the mode dial is rotated to P (program shift), you can use the up-down dial to choose from several combinations of shutter speed and aperture, all of which produced the same exposure.

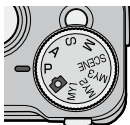

1 Choose mode P.

Rotate the mode dial to P. The shooting mode is shown by an icon in the picture display.



2 Measure exposure.

Press the shutter-release button halfway to measure exposure. The current shutter speed and aperture appear in the display.

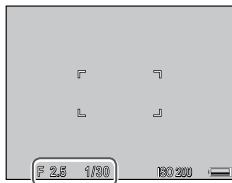

3 Choose shutter speed and aperture.

Release the shutter-release button and rotate the up-down dial to select a combination of shutter speed and aperture.

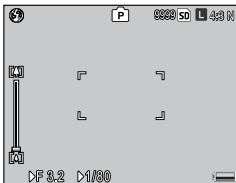

**Note**

Shutter speed and aperture can be adjusted for ten seconds after releasing the shutter-release button.

4 Take a picture.

Gently press the shutter-release button all the way down to take the photograph.

**Note**

The combinations of shutter speed and aperture available at each exposure value differ depending on the camera unit. See the documentation provided with the camera unit for details.

Mode A: Aperture Priority

In mode A (aperture priority), you choose the aperture and the camera selects the shutter speed. Choose large apertures (low f-numbers) to emphasize the main subject by blurring background and foreground details. Choose small apertures (high f-numbers) to bring both the background and main subject into focus.

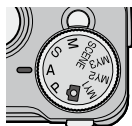

1 Choose mode A.

Rotate the mode dial to A. The current aperture is displayed in orange.

2 Choose an aperture.

Rotate the up-down dial to choose an aperture. Your selection only takes effect when the photograph is taken; the effect cannot be previewed in the picture display.

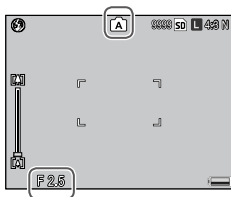

3 Press the shutter-release button halfway.

Press the shutter-release button halfway to set focus and exposure. The shutter speed selected by the camera will be displayed in the picture display.



4 Take a picture.

Gently press the shutter-release button the rest of the way down.

Note

If auto aperture shift is on (page 92), the camera will adjust aperture for optimal exposure.

Mode S: Shutter Priority

In mode S (shutter priority), you choose the shutter speed and the camera selects the aperture. Choose fast shutter speeds to “freeze” motion, slow shutter speeds to emphasize motion by blurring moving objects.

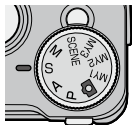

1 Choose mode S.

Rotate the mode dial to S. The current shutter speed is displayed in orange.

2 Choose shutter speed.

Rotate the up-down dial to choose a shutter speed.

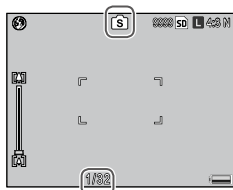

3 Press the shutter-release button halfway.

Press the shutter-release button halfway to set focus and exposure. The aperture selected by the camera will be displayed in the picture display.

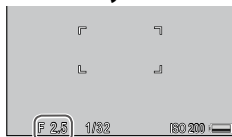

4 Take a picture.

Gently press the shutter-release button the rest of the way down to shoot.



Note

Maximum aperture (i.e., the lowest possible f-number) may not be selected at slow shutter speeds, even when the subject is poorly lit.

Mode M: Manual Exposure

In mode M (manual exposure), use the up-down dial to choose aperture and the **ADJ.** lever to select a shutter speed.

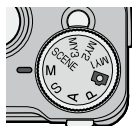

1 Choose mode M.

Rotate the mode dial to **M**.

The shooting mode, exposure indicator, and current aperture and shutter speed appear in the display.

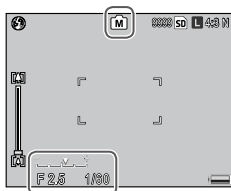

2 Choose an aperture and shutter speed.

Rotate the up-down dial to choose an aperture and press the **ADJ.** lever left or right to select a shutter

speed (if desired, the roles of the two controls can be reversed; see page 138). The effects can be previewed in the picture display and are reflected in the exposure indicator (if the image would be under- or over-exposed by more than 2 EV, the effects cannot be previewed and the indicator turns orange).

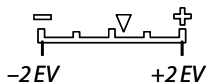

3 Take a picture.

Press the shutter-release button halfway to focus, and then gently press the shutter-release button the rest of the way down to shoot.







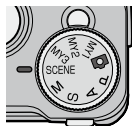

- The shutter speeds that can be set depend on the camera unit and the aperture setting. See the documentation provided with the camera unit for details.
- If **Auto** or **Auto-Hi** is selected for **ISO Setting** (page 90), ISO value will be fixed in manual exposure mode. The fixed value for ISO differs depending on the camera unit. See the documentation provided with the camera unit for details.
- Choose slower shutter speeds for longer exposure times. To reduce blur caused by camera shake, hold the camera steadily in both hands or use a tripod. The picture display turns off while the shutter is open. *At slow shutter speed, the camera automatically processes photographs to remove noise, increasing the time needed to record images to about twice the shutter speed.*
- Autoexposure (AE) lock is not available in manual exposure mode. If **AE Lock** is selected for **Set Fn1 Button** or **Set Fn2 Button** in the key custom options tab, pressing the assigned button in manual exposure mode will set shutter speed or aperture to a value close to that needed for optimal exposure. Similarly, if **Exposure Comp.** is selected for **+/- Button Settings** (page 137) in the key custom options tab, pressing the + and – buttons will not display exposure compensation options in manual exposure mode, but will instead set shutter speed or aperture to a value close to that needed for optimal exposure. This is useful when you want to use optimal exposure as a starting point for modifying exposure. The **One Press M Mode** (page 138) option in the key custom options tab determines whether shutter speed or aperture is altered to achieve optimal exposure.

SCENE Mode: Settings for Various Scenes

Select **SCENE** mode to shoot movies or to choose one of the options that are suitable for particular scenes. Camera settings are automatically optimized for the selected subject type.



The following is some of the options that can be selected in the **SCENE** mode.

Option	Description
 Movie	Shoot movies with sound (page 54).
 Portrait	Use when taking portrait pictures.
 Sports	Use when taking pictures of moving objects.
 Landscape	Use when taking scenery pictures with abundant greenery or blue sky.
 Nightscape	Use when shooting night scenes. In nightscape mode, the flash fires when all of the following conditions are satisfied: <ul style="list-style-type: none">• The flash is set to Auto.• The flash is determined to be necessary because it is dark.• There is a figure or another object nearby.
 Skew Correct Mode	Reduce the effects of perspective when photographing rectangular objects, such as message boards or business cards (page 56).

To select a scene mode option:

1 Rotate the mode dial to SCENE.

The option currently selected for **SCENE** mode appears in the display.

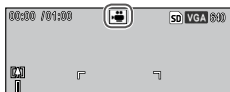

2 Press MENU/OK.

A menu for scene mode is displayed.



3 Select an option.

Press +, -, Fn1 or Fn2 to highlight an option and press MENU/OK to return to shooting mode with the selected option shown at the top of the display.

4 Take a picture.

- **Movie mode:** See page 54.
- **Skew correct mode:** See page 56.

**Tip: Using the Menus**

To access the shooting, key custom options and setup menus in **SCENE** mode, press **MENU/OK** to display the scene mode menu and press **Fn1** to highlight the mode tab. Press **+** or **-** to highlight the shooting menu tab (page 58), key custom options tab (page 127), or setup tab (page 128), and press **Fn2** to place the cursor in the selected menu. See page 59 for information on the shooting menu options available in each mode.



- ① *Mode tab*
- ② *Shooting menu tab*
- ③ *Key custom options tab*
- ④ *Setup tab*

Recording Movies

Shoot movies with sound. Movies are stored as AVI files.

1 Select  in SCENE mode.

Press **+** or **-** to highlight , and press **MENU/OK**.

The mode is shown by an icon in the picture display.

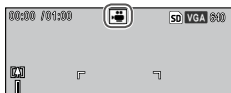
**2 Shoot.**

Press the shutter-release button to begin recording; press again to end. Recording ends automatically when memory is full.



Cautions

- A ●REC icon blinks, and the recording time and remaining available time are displayed during recording.
- Sounds made by the camera may be recorded with the movie.
- Movies may be up to 90 minutes in length or 4 GB in size. Depending on the type of memory card used, shooting may end before this length or size is reached. The maximum total length of all movie files that can be stored in internal memory or on a memory card varies with the options selected for **Movie Size** (page 61).



Notes

- The flash cannot be used in movie mode.
- The camera focuses when the shutter-release button is pressed to begin recording.
- The amount of time remaining is calculated based on the amount of memory available and may not diminish at an even rate.
- Shooting menu options differ from those available in other modes (page 60).
- Charge the battery before shooting. For long recordings, choose memory cards with high write speeds and check the amount of memory available before shooting.

SCENE Mode: Skew Correct

To take pictures in skew correct mode, frame the subject so that it occupies as much of the frame as possible and press the shutter-release button to take the photograph. If the camera detects an object of which perspective can be corrected, the object is shown surrounded by an orange frame. The camera can detect up to five objects; press **Fn2** to select a different object, or press **+** to record the photograph without correcting perspective. If the camera is unable to detect a suitable object, an error message will be displayed and the photograph will be recorded without modification.

**Caution**

The camera records two images: the unmodified photograph and a copy that has been processed to correct perspective. No photograph will be taken if memory is insufficient to record two images. The camera may be unable to correct perspective if:

- The subject is out of focus.
- The four edges of the subject are not clearly visible.
- There is little contrast between the subject and the background.
- The background contains many fine details.

**Tip: Skew Correction**

The **Skew Correction** in the playback menu can be used to correct perspective of saved photographs (page 110).

“MY” Modes: Using Custom Settings

To take photographs using settings saved in **MY1** option with **Reg. My Settings** in the key custom options tab (page 129), rotate the mode dial to **MY1**. Select **MY2** to take photographs using the settings saved with **MY2**, **MY3** to take photographs using the settings saved with **MY3**.

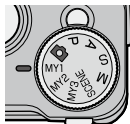

1 Rotate the mode dial to **MY1**, **MY2**, or **MY3**.

The shooting mode saved using **Reg. My Settings** will be displayed in the picture display.



Note

Settings can be adjusted in **MY** modes. The settings saved with **Reg. My Settings** are restored when another mode is selected or the camera is turned off.

Tip: Choosing a Shooting Mode

To choose a shooting mode in **MY** mode without changing other settings, use the **Switch Shooting Mode** option in the shooting menu (page 92). **Switch Shooting Mode** is not available for **MY** modes that a scene mode is assigned to.

2 Take a picture.

See the section on the selected shooting mode for more information.

Shooting Menu

Use the +, -, Fn1, Fn2, and MENU/OK buttons to navigate the menus.



Caution

The shooting menu is not displayed when the camera unit is not attached to the camera body.

1 Display the shooting menu.

In modes other than **SCENE**, pressing MENU/OK in shooting mode displays the shooting menu.



Tip: SCENE Mode

In **SCENE** mode, pressing MENU/OK displays the mode menu; press Fn1 to highlight the mode tab, press - to display the shooting menu, and Fn2 to place the cursor in the menu.

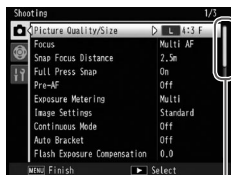

Scroll bar shows position in menu

2 Select a menu item.

Press + or - to highlight a menu item and press Fn2 to display options for the highlighted item.



Note

The items on the next page can be displayed by pressing - while pressing the **DIRECT** button.

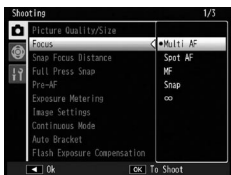

3 Select an option.

Press + or – to highlight an option. Press **MENU/OK** to select and exit to shooting mode, or press **Fn1** to select and return to the shooting menu.

The items available in the shooting menu differ depending on the shooting mode.

P, A, S, M, MY1, MY2 and MY3 Modes

Option	Default	Page	Option	Default	Page
Picture Quality/Size	L 4:3 N	61	Auto Macro	Off	81
Focus	Multi AF	64	Custom Self-Timer	2Pics, 5Sec.	82
Snap Focus Distance	2.5 m	68	Interval Shooting	—	83
Full Press Snap	On	69	Date Imprint	Off	84
Pre-AF	Off	70	Exposure Compensation* ¹	0.0	85
Exposure Metering	Multi	70	White Balance	Multi-P AUTO	86
Image Settings	Standard	71	White Balance Compensation	A: 0, G: 0	89
Continuous Mode	Off	73	ISO Setting	Auto	90
Auto Bracket	Off	75	Restore Defaults* ²	—	91
Flash Exposure Compensation	0.0	78	Auto Aperture Shift* ³	Off	92
Manual Flash Amount	1/2	79	Switch Shooting Mode* ⁴	—	92
Flash Synchro Settings	1st Curtain	79	Camera Shake Correction* ⁵	On	92
Noise Reduction	Off	80			
Noise Reduction ISO	Over ISO 401	80			
Distortion Correction	Off	81			

SCENE Mode: Movie

Option	Default	Page	Option	Default	Page
Movie Size	VGA640	61	White Balance	Auto	86
Focus	Multi AF	64	White Balance Compensation	A: 0, G: 0	89
Snap Focus Distance	2.5 m	68			
Pre-AF	Off	70			

SCENE Mode: Portrait/Sports/Nightscape

Option	Default	Page	Option	Default	Page
Picture Quality/Size	L 4:3 N	61	Distortion Correction	Off	81
Focus	Multi AF	64	Custom Self-Timer	2Pics, 5Sec.	82
Snap Focus Distance	2.5 m	68	Date Imprint	Off	84
Full Press Snap	On	69	Exposure Compensation	0.0	85
Pre-AF	Off	70	White Balance	Multi-P AUTO	86
Flash Exposure Compensation	0.0	78	Camera Shake Correction *5	On	92
Flash Synchro Settings	1st Curtain	79			

SCENE Mode: Landscape

Option	Default	Page	Option	Default	Page
Picture Quality/Size	L 4:3 N	61	White Balance	Multi-P AUTO	86
Distortion Correction	Off	81	Camera Shake Correction *5	On	92
Custom Self-Timer	2Pics, 5Sec.	82			
Date Imprint	Off	84			
Exposure Compensation	0.0	85			

SCENE Mode: Skew Correct

Option	Default	Page	Option	Default	Page
Picture Quality/Size	1M 4:3 F	61	Flash Synchro Settings	1st Curtain	79
Focus	Multi AF	64	Distortion Correction	Off	81
Snap Focus Distance	2.5 m	68	Date Imprint	Off	84
Full Press Snap	On	69	Exposure Compensation	0.0	85
Pre-AF	Off	70	White Balance	Multi-P AUTO	86
Exposure Metering	Multi	70	ISO Setting	Auto	90
Image Settings	Standard	71	Camera Shake Correction ^{*5}	On	92
Flash Exposure Compensation	0.0	78			

*¹ Not available in mode M.

*²  mode only.

*³ Mode A only.

*⁴ Mode MY1, MY2 or MY3 only.

*⁵ This function is not available depending on the type of camera unit.

Picture Quality/Size / Movie Size

Image size determines the number of photographs and movies that can be stored in internal memory or on a memory card.

For still images, the aspect ratio and picture quality can be selected for each option. The picture size differs depending on the combination of the selected option, aspect ratio and quality.

For movies, select the desired option.

For Still Images

Option	Aspect ratio	Compression rate	Description
RAW	16:9* ² , 4:3, 3:2* ² , 1:1* ³	FINE/NORMAL/ VGA* ¹	• Suitable for further image processing or editing on a computer.
L	16:9* ² , 4:3, 3:2* ² , 1:1* ³	FINE/NORMAL	• Suitable for printing at larger size or cropping the image on a computer.
M	16:9* ² , 4:3, 3:2* ² , 1:1* ³	FINE/NORMAL	
5M	4:3	FINE	• Suitable for printing.
3M	4:3	FINE	
1M* ⁴	4:3	FINE	• Suitable for taking large number of photographs.
VGA* ⁴	4:3	FINE	• Suitable for taking large number of photographs, attaching the images to e-mail or posting images on the web.

*¹The setting is applied for the JPEG copy.

*²The upper and lower parts on the display are blacked out.

*³The left and right sides on the display are blacked out.

*⁴**1M** and **VGA** are the options available in the Skew Correct mode.

Notes

- See the documentation provided with the camera unit for details on the picture size for each option.
- Options for **Picture Quality/Size** can be displayed by pressing the **ADJ.** lever (page 134).



Tip: Picture Quality

The camera supports the following picture qualities:

- **Normal:** JPEG compression is used to reduce file size.
- **Fine:** Compression rate is low to achieve high picture quality. File size becomes larger comparing to Normal quality.
- **RAW:** RAW image data are saved in DNG format; JPEG copies are also created. The camera displays only the JPEG copy; DNG files can be viewed and edited on a computer using the supplied Irodio Photo & Video Studio Software (Windows only) or commercially-available applications that support the DNG format.

Unlike normal- and fine-quality images, RAW images are not compressed. This increases file size but avoids the loss of quality associated with JPEG compression. Note the following when shooting RAW images:

- Some functions of the shooting menu are not available for shooting RAW images. See the description of each setting for details. **Image Settings** and **Date Imprint** options apply only to JPEG copies and have no effect on the DNG files.
- The number of RAW photographs that can be taken in a single burst in continuous mode differs depending on the camera unit and the settings of shooting menu.

For Movies

Option	Image size
VGA640	640×480
QVGA320	320×240







Notes

- The options for movies differ depending on the camera unit. See the documentation provided with the camera unit for details.
- Movies may be up to 90 minutes in length or 4 GB in size.

Focus

Choose how the camera focuses. By default, the camera uses autofocus.

Option	Description
 Multi AF*	The camera selects the focus area with the closest subject, preventing out-of-focus shots by keeping the camera from focusing on the background.
 Spot AF*	Focus on the subject in the center of the frame.
 MF (manual focus)	Focus manually (page 65).
 Snap	Focus is fixed at distance selected with Snap Focus Distance (page 68) for quick shutter response.
 ∞ (infinity)	Fix the focus distance at infinity when photographing distant scenes.

* The icon is displayed on the DIRECT screen only.

When **MF**, **Snap**, or **∞** is selected, the current selection is shown by an icon in the picture display.

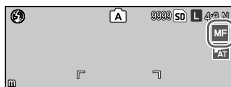

Tip: Depth of Field

Depth of field is the portion (range of distance) that appears sharp in an image. Small apertures (high f-numbers) increase depth of field, bringing more of the scene into focus; large apertures (low f-numbers) decrease depth of field, emphasizing the main subject by blurring the foreground and background. At settings of **MF**, **Snap**, and **∞**, the focus bar shows depth of field in shooting modes **M**, **A**, and **P** (in mode **P**, depth of field is only shown when the shutter-release button is pressed halfway and aperture values are displayed).

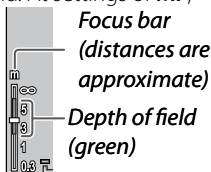



Notes

- **Fn1** and **Fn2** buttons can be used to switch back and forth between autofocus and manual or snap focus (page 136).
- To zoom in on the subject in the center of the picture display and check focus, press and hold **MENU/OK**. Press and hold the button again to return to the normal shooting display.

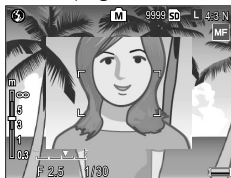

Focus: MF (Manual Focus)

Manual focus can be used to lock focus or to focus when the camera is unable to focus using autofocus.

1 Select MF (manual focus) in the Focus menu.

The focus mode and focus bar are displayed in the picture display.



2 Choose the focus distance.

While pressing the  button, rotate the up-down dial to focus. When using the camera unit with the focus ring, adjust the focus using the ring.

3 Take a picture.

See the section on the selected shooting mode for more information.



Note

In manual focus mode, the camera can focus on the subject at close range (macro) even if macro mode is not set.

Choosing the Focus and Metering Target

Target selection can be used to set focus and exposure for off-center subjects without moving the camera, making it easier to use a tripod.

1 Activate target selection.

Press the **ADJ.** lever in the focus modes other than **MF**, and then press the lever to the left or right to highlight . Press **+** or **-** to highlight one of the following options and press **MENU/OK** to select.



Option	Description
AE/AF	Spot metering and spot autofocus; choose the focus and exposure target.
AF	Spot autofocus; choose the focus target. Exposure is metered using the option selected for Exposure Metering (page 70).
AE	Spot metering; choose the metering target. Focus is set using the option selected for Focus (page 64).
off	Target selection is off.

2 Position the target.

Use the directional pad (page 37) to position the cross hairs over your subject, and press **MENU/OK**.

To return to the target selection menu, press the **DISP.** button.



3 Take a picture.

Press the shutter-release button halfway to set focus and/or exposure for the selected subject and then gently press the shutter-release button the rest of the way down to take the picture.



Notes

- Target selection is not available in manual focus mode (page 65).
- The selected target remains in effect until a new target is selected. Note that target will be reset if you choose a new option in the target-selection menu or select manual focus.
- When macro mode is on in **SCENE** mode, the focus target for macro mode can be selected by pressing the **ADJ.** lever, selecting , and using the directional pad to position the cross-hairs as described on page 68.
- The **Fn** buttons can be used for focus target selection in macro mode (page 68). Note that if the **Fn** buttons have been used to select the focus target, the **ADJ.** lever cannot be used for target selection until the target is reset.



Macro Target Selection

If **Macro Target** is assigned to the **Fn1** or **Fn2** button (page 136), you can select macro mode by pressing the assigned button in shooting mode. The cross-hairs shown at right will be displayed; use the directional pad (page 37) to position the cross-hairs over your



subject, and press **MENU/OK** (to exit without setting the target, press the **DISP.** button). Press the shutter-release button halfway to focus on the selected target, and then gently press the shutter-release button the rest of the way down to take the picture.

If the **ADJ.** lever has been used to select a focus target (page 66), you cannot select macro target mode by pressing **Fn1** and **Fn2** until the target is canceled.

Snap Focus Distance

Select the distance at which the camera focuses when **Snap** is selected for **Focus** (page 64) or **Full Press Snap** is on (page 69). Choose from 1 m (3.3 ft.), 1.5 m (4.9 ft.), 2 m (6.6 ft.), 2.5 m (8.2 ft.), 3 m (9.9 ft.), 3.5 m (11.5 ft.), 5 m (16.4 ft.), and ∞ (infinity).



Note

When **Snap** is selected for **Focus** or **Full Press Snap** is on, the snap focus distance can also be selected by rotating the up-down dial while pressing the  button.

Full Press Snap

Take photographs without pausing to focus the camera when **Multi AF** or **Spot AF** is selected for **Focus** (page 64).

Option	Description
Off	The function is off.
On	If the shutter-release is pressed all the way down in one motion, the camera will take a picture at the focus distance selected for Snap Focus Distance . Choose when quick shutter response is required.
Auto-Hi ISO	Same as On , except that ISO sensitivity is automatically set to Auto-Hi (page 90).



Note

The snap focus distance can be changed by rotating the up-down dial while pressing the  button.



Tip: Autofocus

The camera will focus normally if you press the shutter-release button halfway.



Cautions

- Full press snap is not available in macro mode or when **MF**, **Snap**, or ∞ is selected for **Focus** (page 64).
- Care is required to avoid blur caused by camera movement.

Pre-AF

If **On** is selected when **Multi AF** or **Spot AF** is selected for **Focus** (page 64), the camera will continue to focus even when the shutter-release button is not pressed halfway (the focus range is narrower than for normal focus). This may decrease the time needed to focus, potentially improving shutter response.





Cautions

- **Pre-AF** is not available when **MF**, **Snap**, or ∞ is selected for **Focus** (page 64).
- Using pre-AF increases the drain on the battery.

Exposure Metering

Choose how the camera measures light for exposure.

Option	Description
 Multi*	The camera measures light in 256 areas of the frame.
 Center	The camera measures light in the entire frame but assigns the greatest weight to the center. Use when the subject in the center of the frame is brighter or darker than the background.
 Spot	The camera measures light with the subject in the center of a frame, ensuring the optimal exposure even when it is markedly brighter or darker than the background.







* The icon is displayed on the DIRECT screen only.

When **Center** or **Spot** is selected, the current selection is shown by an icon in the picture display.



Image Settings

Adjust contrast, sharpness, and vividness (color depth) or take monochrome photographs.

Option	Description
 Vivid	Take vivid photographs with heightened contrast, sharpness, and vividness.
 Standard*	Normal contrast, sharpness, and vividness.
 Natural	Creates a softer image with decrease in contrast, sharpness, and vividness.
 Black & White	Take photographs in black and white. Contrast and sharpness can be adjusted manually.
 B&W (TE) (Toning Effect)	Creates monochrome photographs with a sepia, red, green, blue, or purple tint. Vividness, contrast, and sharpness can be adjusted manually.
 Setting 1  Setting 2	Make individual adjustments to vividness, contrast, sharpness, colors and hue to create custom settings that can be recalled as desired.

* The icon is displayed on the DIRECT screen only.

At settings other than **Standard**, the current selection is shown by an icon in the picture display.



To make individual adjustments to the settings for **Black & White**, **B&W (TE)**, **Setting 1**, or **Setting 2**, highlight the desired option and press **Fn2**.

1 Adjust custom color reproduction settings.

- **Black & White:** Press + and – to highlight an option and press **Fn1** and **Fn2** to change.

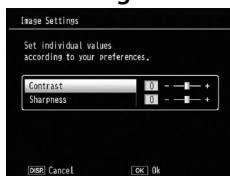

- **B&W (TE):** Adjust vividness, contrast, and sharpness as described above. To choose a tint, highlight **Toning Effect** and press **Fn2**. Press + and – to highlight an option and press **Fn1** to select.

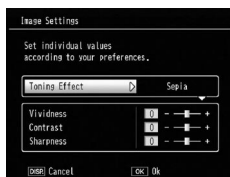

- **Setting1/Setting2:** Adjust vividness, contrast, and sharpness as described above. To adjust individual colors, highlight **Individual Color Settings** and press **Fn2**.

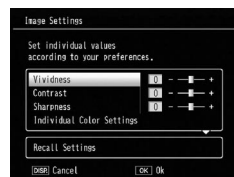

Press + and – to highlight an option and press **Fn1** and **Fn2** to change. Press **MENU/OK** to exit when settings are complete.

To call the registered settings, highlight **Recall Settings** and press **Fn2**. Press + or – button to highlight an option and press **MENU/OK**.

2 Return to the Image Settings menu.

Press **MENU/OK** when settings are complete.

3 Exit to shooting mode.

Press **MENU/OK**, or press **Fn1** and then press **MENU/OK**.

The option currently selected for **Image Settings** will be displayed in the picture display.

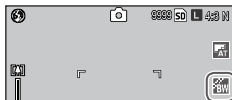

Note

Options for **Image Settings** can be displayed by pressing the **ADJ.** lever (page 134).

Continuous Mode

Shoot photographs in continuous sequence.

- **Continuous:** The camera shoots while the shutter-release button is pressed.

All the photographs taken in this mode are saved as individual still images.

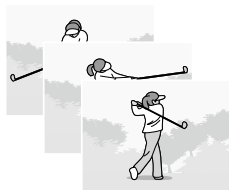

- **M-Cont Plus** (memory-reversal continuous plus): The camera shoots while the shutter-release button is pressed. Consecutive still images taken before releasing the shutter-release button are saved as one MP file (page 95).

M-Cont Plus can be selected from **M-Cont + (HI)** and **M-Cont + (LO)**.

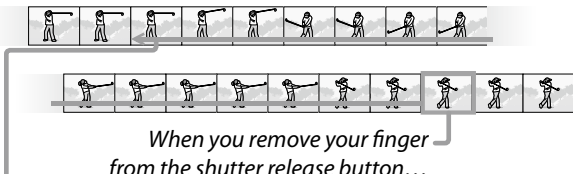

*When you remove your finger
from the shutter release button...
...the camera records consecutive still images.*

**Note**

For **M-Cont + (HI)** and **M-Cont + (LO)** options, image sizes and the number of images saved as one MP file differ depending on the camera unit. See the documentation provided with the camera unit for details.

At settings other than **Off**, the current selection is shown by an icon in the picture display.

**Caution**

Digital zoom is available at settings **M-Cont Plus** even if **Auto Resize** is selected for **Digital Zoom Image**.

**Notes**





- At settings other than **Off**, the flash turns off automatically, focus and exposure are fixed with the first shot in each series, and **Auto** white balance is used in place of **Multi-P AUTO** (page 86).
- If you release the shutter-release button before reaching the number of images that are saved as one MP file, the photographs taken while pressing the button will be saved as one MP file.

**Tip: MP file**

MP is a file format for recording a set of still images.

Auto Bracket

The camera records two or three copies of an image with variations in exposure, white balance or color.

Option	Description
 OFF*	Auto bracket function is off.
 AE-BKT	The camera records three copies of a photograph in the specified variation of exposure value.
 WB-BKT	<p>The camera records three copies of each photograph: one with a “warm,” reddish cast, a second at the white balance currently selected in the shooting menu (page 86), and a third with a “cool,” blueish cast. Choose when you find it difficult to select the correct white balance.</p> <div data-bbox="629 471 940 707" data-label="Image"> </div> <p><i>Display after shooting</i></p>
 CL-BKT	Record photographs in both black-and-white and color or in black-and-white, color, and tinted monochrome (page 77).

* The icon is displayed on the DIRECT screen only.

The current selection is shown by an icon in the picture display.

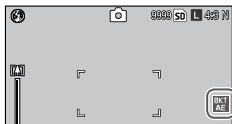

**Notes**

- Bracketing is not available when an option other than **Off** is selected for **Continuous Mode**. White balance bracketing is not available when shooting monochrome photographs.
- White balance bracketing and color bracketing are not available when **RAW** is selected for **Picture Quality/Size** (page 61).
- The flash turns off automatically when bracketing is in effect.
- **Auto** white balance is used in place of **Multi-P AUTO** when **AE-BKT** is selected.

AE-BKT: Exposure Bracketing

To specify variations for exposure value:

1 Select AE-BKT.

Highlight **AE-BKT** and then press **Fn2**.

2 Specify the exposure compensation value.

Move the cursor using **Fn1** or **Fn2**, press **+** or **-** to specify the compensation value, and then press **MENU/OK**.

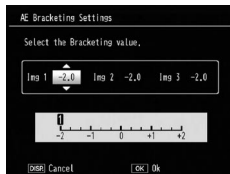
**3 Return to shooting mode.**

Press **MENU/OK**, or press **Fn1** and then press **MENU/OK**.

**Notes**

- If the same exposure compensation value is set, only one image will be displayed for the same value.
- The step value of the compensation can be set with **Exposure/Flash Comp. Step** in the setup tab (page 140).

CL-BKT: Color Bracketing

The number and type of photographs recorded when **CL-BKT** is selected for **Auto Bracket** depends on the option selected for **CL-BKT Black & White (TE)** in the setup tab (page 146):

- **Off:** The camera records two copies of each photograph, one in black and white and a second in color.
- **On:** The camera records three copies of each photograph, one in black and white, a second in color, and a third using the tint selected for **B&W (TE)** in the **Image Settings** menu (page 71).

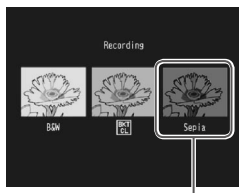
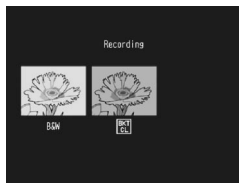

B&W (TE) copy

Tip: Contrast, Sharpness, and Color Depth

The contrast, sharpness, and vividness of the images in the bracketing sequence are determined by the options selected in the **Image Settings** menu (page 71). The black-and-white copy is recorded at the settings most recently selected for **Black & White**, the tinted monochrome copy at the settings most recently selected for **B&W (TE)**, and the color copy at the setting currently selected for **Image Settings** (if **Black & White** or **B&W (TE)** is selected, the color copy will be recorded at a setting of **Standard**).

Flash Exposure Compensation

Adjust flash amount between -2.0 to $+2.0$ in steps of $1/2$ or $1/3$ EV. Selecting **Flash Exposure Compensation** in the shooting menu displays the slider shown at right; press + or – to choose a flash exposure compensation value and press **MENU/OK**.

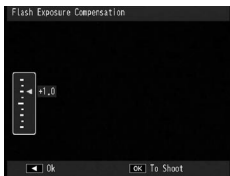

Flash exposure compensation is displayed in the picture display except when the flash is off.



Notes

- See page 28 for information on using the flash.
- The step value of the compensation can be set with **Exposure/Flash Comp. Step** in the setup tab (page 140).

Caution

Flash exposure compensation may have no effect outside the range of the flash. See the documentation provided with the camera unit for details on the range of flash.

Manual Flash Amount

Choose amount of light produced by the flash in manual flash mode (page 28). Flash amount is expressed as a fraction of full power (all values are approximate):

FULL 1/1.4 1/2 1/2.8 1/4 1/5.6 1/8 1/11 1/16 1/22 1/32 1/64

Flash level is displayed in the picture display in manual flash mode.



Note

Flash exposure compensation is not available in manual flash mode.



Caution

Do not direct the flash at a person operating a motor vehicle or use the flash close to the subject's eyes. Particular care should be observed when photographing infants.

Flash Synchro Settings

Choose how the flash synchronizes with the shutter.

- **1st Curtain:** The flash fires at the beginning of the exposure. Recommended in most situations.
- **2nd Curtain:** The flash fires at the end of the exposure. This option produces trails of light behind moving light sources.

Noise Reduction

Choose **Weak** or **Strong** to reduce noise (random variations in brightness and color) in photographs taken at high ISO sensitivities. The minimum ISO sensitivity at which noise reduction applies can be selected using **Noise Reduction ISO**.

NR is displayed when noise reduction is on.



Notes

- When **RAW** is selected for **Picture Quality/Size** (page 61), noise reduction applies only to the JPEG copy, not to the DNG file.
- The time needed to record photographs varies with the option selected for **Noise Reduction**.

Noise Reduction ISO

Select the minimum ISO sensitivity to apply noise reduction function to when **Weak** or **Strong** is selected for **Noise Reduction**. Choose from **All** (noise reduction applies at all ISO sensitivities), **Over ISO 201**, **Over ISO 401**, **Over ISO 801**, **Over ISO1601**, and **ISO3200**.

Distortion Correction

Set **Distortion Correction** to **On** to shoot by automatically correcting the distortion of the image.

 is displayed when distortion correction is on.



Cautions

- Even if **Distortion Correction** is set to **On**, the correction is not applied depending on the type of camera unit or when it is not necessary depending on the zoom position. However, the distortion correction symbol will appear in playback mode for the images without the correction applied.
- The distortion correction function is not available for DNG files, JPEG copies for raw data, MP files, and movies.
- When **Distortion Correction** is set to **On**, the angle of view will change.
- The corrected image will not be displayed in the picture display even if **Distortion Correction** is set to **On**.

Auto Macro

With **Auto Macro** set to **On**, the camera automatically switches to the macro mode when focusing on a subject close to the lens even if the camera is not in macro mode.

 is displayed when the camera switches to macro mode.

To set the number of photographs to take and the interval of shooting for the custom setting of the self-timer option, select **Custom Self-Timer** in the shooting menu and follow the steps below:

1 Choose the number of photographs to take and the interval of shooting.

Press Fn1 or Fn2 to highlight the numbers, and press + or – to change. Press **MENU/OK** to return to shooting mode.

2 Start shooting.

Press the shutter-release button. The specified number of photographs will be taken automatically at the selected interval.

Press **MENU/OK** to cancel the self-timer before finishing shooting the specified number of photographs.

Interval Shooting

To take photographs automatically at intervals of from five seconds to one hour, select **Interval Shooting** in the shooting menu and follow the steps below:

1 Choose an interval.

Press **Fn1** and **Fn2** to highlight hours, minutes, or seconds and press **+** and **-** to change. Press **MENU/OK** to return to shooting mode.

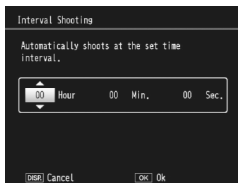

Interval is displayed in the picture display.



2 Start shooting.

Press the shutter-release button. Photographs will be taken automatically at the selected interval.

3 End shooting.

Press **MENU/OK** to end shooting.



Cautions

- The interval timer is not available in **SCENE** mode.
- The interval resets to zero when the camera is turned off.
- If the time needed to record photographs is longer than the selected interval, the next photograph will not be taken until recording is complete.
- The external flash unit will not fire in interval shooting mode. Use the built-in flash instead.

**Notes**

- Use a fully-charged battery and be sure that sufficient space remains in internal memory or on the memory card. Interval timer photography ends automatically when the internal memory or memory card becomes full.
- Photographs can be taken at any time by pressing the shutter-release button.
- If **Continuous** or **M-Cont Plus** is selected for **Continuous Mode**, continuous shooting turns off automatically.

Date Imprint

The camera imprints the shooting date on a picture. Select an option from **Date** (YY/MM/DD) and **Date and Time** (YY/MM/DD hh:mm).

DATE is displayed when date imprint is on.

**Notes**

- Date imprint is not available when the clock is not set. Set the clock (pages 20, 149) before using date imprint.
- The date cannot be imprinted on movies.
- When **RAW** is selected for **Picture Quality/Size**, the date is imprinted only on the JPEG copy, not the DNG file.
- The date is permanently imprinted on the image and cannot be removed.

Exposure Compensation

Exposure compensation may be required in the following situations:

- **Very bright backlighting:** Subjects that are very strongly backlit may be underexposed. Try increasing exposure compensation.
- **The frame is dominated by very bright objects:** The subject may be underexposed. Try increasing exposure compensation.
- **The frame is mostly dark** (for example, a spotlight subject on a darkened stage): The subject may be overexposed. Try reducing exposure compensation.

1 Display the exposure compensation slider.

Highlight **Exposure Compensation** in the shooting menu, and press **Fn2** to display the slider shown at right.

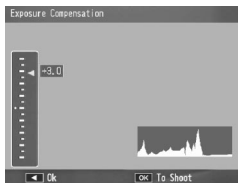

2 Adjust exposure compensation.

Press **+** or **-** to adjust an exposure compensation value. Press the shutter-release button to take a picture or press **MENU/OK** to return to shooting mode.

At settings other than **0.0**, exposure compensation is displayed in the picture display.



**Caution**









Exposure compensation is not available in mode **M**.

**Note**

The step value of the compensation can be set with the **Exposure/Flash Comp. Step** option in the setup tab (page 140).

White Balance

At the default setting of **Multi-P AUTO**, the camera automatically adjusts white balance so that a white subject will appear white regardless of the color of the light source. It may however be necessary to match white balance to the light source under mixed lighting or when photographing a subject that is a solid color.

Option	Description
 Auto*	The camera adjusts white balance automatically.
 Multi-P AUTO	The camera adjusts white balance to account for differences in lighting in separate areas of the frame (in continuous mode, this option is equivalent to Auto).
 Outdoors	Use when shooting in daylight under clear skies.
 Cloudy	Use when shooting in daylight under cloudy skies.
 Incandescent Lamp	Use with incandescent lighting.
 Fluorescent Lamp	Use with fluorescent lighting.
 Manual Settings	Measure white balance manually (page 88).
 Detail	Make fine adjustments to white balance (page 88).

* The icon is displayed on the DIRECT screen only.

At settings other than **Auto**, the current selection is shown by an icon in the picture display.



Cautions

- Auto white balance may not produce the desired results in scenes without white objects. This can be corrected by adding a white object to the scene before shooting.
- Options other than **Auto** may not produce the desired results when the flash is used. Select **Auto** when using the flash.

1 Display white balance options.

Highlight **White Balance** in shooting menu, and press **Fn2** to display options.

2 Select an option.

Press **+** or **-** to select an option.

Press the shutter-release button to take a picture or press the **ADJ.** lever or **MENU/OK** to return to shooting mode.

Note

Options for **White balance** can be displayed by pressing the **ADJ.** lever (page 134).

Manual: Measuring White Balance

To measure a value for white balance:

1 Select Manual Settings.

Highlight **WB M** Manual Settings in the white balance menu.

2 Measure white balance.

Frame a blank piece of paper or other white object so that it fills the frame and press the **DISP.** button. Repeat steps 1 and 2 until the desired effect is achieved.



3 Return to shooting mode.

Press **MENU/OK** to return to shooting mode.



Note

Selecting an option other than **Manual Settings** resets manual white balance.

Detail: Making Fine Adjustments to White Balance

To make fine adjustments to white balance:

1 Select Detail.

Highlight **WB CT** Detail in the white balance menu and press the **DISP.** button.



2 Choose a setting.

Press + or – to choose a white balance. Press **MENU/OK** when settings are complete.



3 Return to shooting mode.

Press **MENU/OK** to return to shooting mode.



Note

Selecting an option other than **Detail** resets detail white balance.

White Balance Compensation

Compensate for color casts by modifying white balance on the green-magenta or blue-amber axis. The modifications apply to the option currently selected for white balance and to all options selected while the modifications are in effect.

Selecting **White Balance Compensation** in the shooting menu (page 58) displays the controls shown at right. Choose white balance compensation using the directional pad (page 37). Press the **DISP.** button to reset white balance compensation to a neutral value. Press **MENU/OK** to save changes and exit, or press the **DISP.** button twice to cancel.

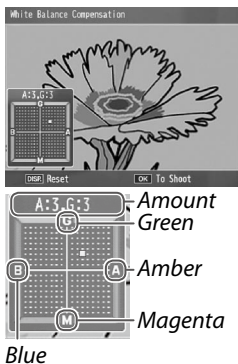

White balance compensation is shown in the picture display.



Notes

- White balance compensation can be assigned to the **ADJ.** lever (page 134). To reset, highlight **Reset** and press **MENU/OK**.
- White balance compensation can also be assigned to the **Fn** buttons (page 136).
- When the mode dial is rotated to **SCENE**, white balance compensation is only available in movie mode.
- The **White Balance Compensation** option in the playback menu (page 109) does not use the same values as the shooting menu option.



ISO Setting

Adjust the camera's sensitivity to light. Higher values can be used for faster shutter speeds when the subject is poorly lit, preventing blur.

- **Auto:** The camera automatically adjusts sensitivity according to brightness, the distance to the subject, the options selected for macro mode, and picture quality and size.
- **Auto-Hi** (high sensitivity auto): The camera automatically adjusts sensitivity according to shooting conditions. Comparing to the **Auto** setting, higher sensitivities can be selected for the subject poorly lit. The maximum sensitivity can be selected with **ISO Auto-High Settings** in the setup tab (page 140).

- **ISO (value):** The camera shoots with the selected ISO value. Available ISO values differ depending on the camera unit. See the documentation provided with the camera unit for details.

The current sensitivity is shown in the picture display (if **Auto** or **Auto-Hi** is selected, the sensitivity selected by the camera is shown when the shutter-release button is pressed halfway).



1 Select an ISO sensitivity option.

Press + or – to select an option.

2 Shoot or return to the shooting mode.

Press the shutter-release button to take a picture, or press **MENU/OK** to return to shooting mode.

Notes

- Options for **ISO setting** can be displayed by pressing the **ADJ.** lever (page 134).
- The sensitivity when using the flash and the range of available sensitivities differ depending on the camera unit. See the documentation of the camera unit for details.
- “Noise” (random variations in brightness and color) may appear in photographs taken at high sensitivities.

Restore Defaults

To restore default shooting menu settings (page 59), rotate the mode dial to  and select **Restore Defaults** in the shooting menu. A confirmation dialog will be displayed; highlight **Yes** and press **MENU/OK** to restore default values and exit to shooting mode.

Auto Aperture Shift

When **On** is selected, the camera will automatically adjust aperture to prevent overexposure in the aperture priority mode.



Note

Auto aperture shift is available only in the aperture priority mode.

Switch Shooting Mode

When the mode dial is rotated to a **MY** mode (page 57), you can use this option to switch between , P, A, S, and M modes without rotating the mode dial to a new setting. This option is only available in **MY** modes, however, it is not available if a scene mode is assigned to **MY** mode.

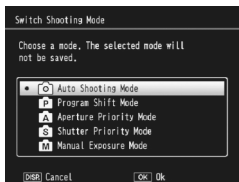



Camera Shake Correction

Select **Camera Shake Correction** to **On** to prevent blur caused by camera shake.



 is displayed when camera shake correction is on.

**Cautions**

- This function is not available depending on the camera unit.
- The camera shake correction function is not available in movie mode, continuous mode, or when the shutter speed is set to 1 or more seconds in manual exposure mode. If the function is set on in continuous mode or when the shutter speed is set to 1 or more seconds in manual exposure mode,  changes to , and in the movie mode,  disappears.
- The camera shake correction function cannot prevent the blur caused by the movement of the subject (caused by wind, etc.).
- Effects of the camera shake correction function differ depending on the surroundings.

**Note**

 appears in the picture display when camera shake is likely to occur.

Playback Functions

This section describes how to view movies and MP files.

Viewing Movies

Follow the steps below to view movies.

1 Press the button.

Press the  button to display pictures in the picture display.







2 Display the movie.

Press +, -, Fn1, and Fn2 (page 34) to scroll through pictures until the first frame of the movie is displayed. Movies are indicated by a  icon.



3 Start playback.

Press the ADJ. lever to start playback. Progress is shown in the playback display. The following operations can be performed:

To	Press	Description
Advance/ rewind	 / 	Hold the  button to fast forward, and the  button to rewind. If movie is paused, press the  or  button to advance or rewind one frame; keep the button pressed for slow advance or rewind.
Pause/ resume	ADJ.	Press the ADJ. lever to pause; press again to resume.
Adjust volume	+/-	Press + to increase volume, - to decrease.

Viewing MP Files

When you shoot images with M-Cont Plus, the images are recorded as one MP file. Follow the steps below to view MP files.



Note

Images shot in normal continuous mode can be played back in the same way as normal still images.

1 Press the button.

2 Display the MP file.

The MP file is displayed with the symbol. The display changes as follows.



Display for step 2

- Press the DISP. button to change between “Normal” and “No Display”.
- The images cannot be enlarged even if the Q button is pressed. The images are displayed in thumbnail view.
- The other operations are the same as those for normal still images.

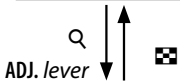

Thumbnail view

- The MP file images are displayed in thumbnail view.
- Use the directional pad (page 37) to select a frame.
- The DISP. button is disabled.

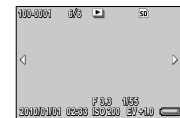
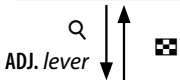

Single frame view

- Single frame selected on the thumbnail view is displayed.
- Press the Q button to enlarge the image.





Slide Show

- Images are displayed automatically in the order they were consecutively shot, starting with the displayed frame.

The operations during slide show are shown below.

Pause/Playback	Press the ADJ. lever.
Fast Forward	Press and hold Q during playback.
Rewind	Press and hold ⏮ during playback.
Slow Playback	Press and hold Q during pause.
Slow Rewind	Press and hold ⏮ during pause.
Next Frame	Press Q during pause.
Previous Frame	Press ⏮ during pause.
First Frame	Press the ADJ. lever to the left during pause.
Last Frame	Press the ADJ. lever to the right during pause.



Cautions

- The **DPOF**, **Trim**, **Resize**, **Skew Correction** (playback mode), **Level Compensation**, and **White Balance Compensation** functions are not available for MP files.
- **Flag Function Setting** and **Protect** cannot be set for individual frames in an MP file. If **Flag Function Setting** or **Protect** is set when the thumbnail view or single image view is displayed, the setting will be applied to the MP file instead of an individual frame.
- Individual frame of an MP file cannot be deleted.

Exporting MP Files

Follow the steps below to extract specific frames from an MP file and save each frame as an individual still image.



Notes

- The extracted image is saved in the same size as the original.
- The original files will be retained after extraction.

1 Press the button.

2 Display the MP file you want to export.

The MP file is displayed with the symbol.

To export multiple frames, you can also press the button to display thumbnail view, and then go to step 3.

3 Press MENU/OK.

The playback menu appears.

4 Press + or - to select **Export Still Images**, and then press Fn2.

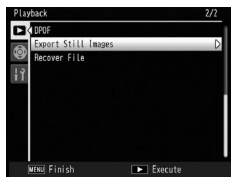

Selecting One Frame

5 Press + or – to select **1 Frame**.

Press Fn1 or Fn2 to select the frame.

6 Press MENU/OK.



Specifying Multiple Frames Separately

5 Press + or – to select **Sel Mult**, and then press MENU/OK.

If thumbnail view was displayed in step 2 on page 97, skip step 5.

6 Press + or – to select **Sel. Indiv.**, and then press MENU/OK.



7 Select the frame, and then press MENU/OK.

Press the ADJ. lever to switch to the display for specifying a range of frames. See step 7 and beyond on page 99.

8 Repeat step 7 to select all the frames.

To deselect a frame, highlight the frame and press MENU/OK.

9 Press the button.

10 Select **Yes**, and then press MENU/OK.

Specifying a Range of Multiple Frames

- 5** Press + or – to select **Sel Mult**, and then press MENU/OK.

If thumbnail view was displayed in step 2 on page 97, skip step 5.



- 6** Press + or – to select **Sel. Range**, and then press MENU/OK.

- 7** Select the starting point for the range of frames you want to specify, and press MENU/OK.

If you make a mistake when selecting the starting point for the range of frames, press the **DISP.** button to return to the screen for selecting the starting point.

Press the **ADJ.** lever to switch to the display for specifying frames separately. See step 7 and beyond on page 98.

- 8** Select the ending point for the range of frames you want to specify, and press MENU/OK.

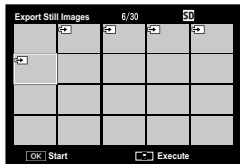

- 9** Repeat steps 7 and 8 to specify all ranges.

- 10** Press the **☛** button.

- 11** Select **Yes**, and then press MENU/OK.

Selecting All Frames

- 5 Press + or - to select **All Frames**, and press MENU/OK.
- 6 Select **Yes**, and then press MENU/OK.



Playback Menu

This section details the options in the playback menu and describes how to view pictures on a TV.

Playback Menu

Press the  button in shooting mode and follow the steps below.

- 1 Display the playback menu.**
Press MENU/OK.

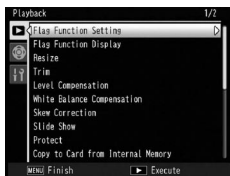

- 2 Select a menu item.**
Press + or - to scroll through the menu and press Fn2 to display options for the highlighted item.



Note

The items on the next page can be displayed by pressing - while pressing the **DIRECT** button.

The playback menu contains the following options:

Option	Page	Option	Page
Flag Function Setting	102	Slide Show	111
Flag Function Display	103	Protect	112
Resize	104	Copy to Card from Internal Memory	115
Trim	105	DPOF	115
Level Compensation	106	Export Still Images	97
White Balance Compensation	109	Recover File	117
Skew Correction	110		



Note

The menus for camera setup can be accessed from the playback menu (page 126).

Flag Function Setting

Register the frequently viewed image files to **Flag Function Setting** (up to 20 files) to recall the images easily by selecting **Flag Function Display** at a later time.

Setting/Canceling One File at a Time

To set or cancel one file at a time, play the picture back and press **MENU/OK**. Highlight **Flag Function Setting** in the playback menu and press **Fn2** button. Highlight **Set** or **Cancel**, and then press **MENU/OK**.



Notes

- When a file is set, the symbol appears on the screen.
- If 20 files have already been set, no more files can be set. Cancel some files and set desired files.

Setting/Canceling Multiple files at a Time

Follow the steps below to set or cancel multiple files at a time.

- 1 Display the thumbnail view.**
Press the **Q** button in playback mode.
- 2 Select a picture.**
Highlight a picture and press **MENU/OK**.
- 3 Select **Flag Function Setting** and then press **Fn2**.**
Selected pictures are marked with the **P** icon.

4 Select additional photographs.

Press **Fn1** or **Fn2** to highlight additional photographs and press **MENU/OK**. Repeat this procedure to set or cancel all the desired files. To cancel the selected photographs, press **MENU/OK** when the file is selected.

Cautions

- If the name of the file set to **Flag Function Setting** is changed using a computer, **Flag Function Setting** is canceled for the file.
- When the contents of the internal memory are copied to an SD memory card, **Flag Function Setting** that have been set for the files in the internal memory is canceled.
- When a file in an SD memory card is set to **Flag Function Setting**, [CLIPINFO] folder and CLIP.CLI file are created on the SD memory card. If these are deleted, **Flag Function Setting** is canceled for the corresponding files.
- If the name of a file is changed using a computer, **Flag Function Setting** may not be able to be set to the files.
- Only images taken using this camera body can be set to **Flag Function Setting**.

Flag Function Display

To display the images set to **Flag Function Setting**, select **Flag Function Display** in the playback menu.

Notes

- The file set to **Flag Function Setting** with the smallest file number is displayed.
- Pressing the shutter - release button or the  button switches to shooting mode.

- If no files are set to **Flag Function Setting**, a message appears and the display returns to the playback menu.
- If multiple files are set to **Flag Function Setting**, pressing the  button displays the image with the smallest file number.
- When a file set to **Flag Function Setting** is displayed in the full frame, pressing the +, -, **Fn1** or **Fn2** buttons switches to the previous or next image.

Resize

To create a small copy of a photograph, select **Resize** in the playback menu (page 101) and choose a size. The photographs taken in **L**, **M**, **5M** or **3M** size (page 61) can be copied in **1M** or **VGA** size, and the photographs taken in **1M** can be copied in **VGA**. Movies and RAW-quality photographs cannot be resized.

Notes

- The images are copied in the aspect ratio of 4:3. If the aspect ratio of original photograph is 16:9, 3:2, or 1:1, the left and right, or the upper and lower parts of images are trimmed and displayed with black border on the screen.
- See page 61 for information on choosing the size of photographs during shooting.

Follow the steps below to trim a still image and then save it as a separate file.

1 Display a photograph.

Display the photograph to be copied in playback mode.

2 Select Trim.

Press **MENU/OK** to display the playback menu, highlight **Trim**, and press **Fn2**. To cancel trimming, press the **DISP.** button.

3 Trim the photograph.

Set the size of the trimming frame with the **Q** or **☒** button, and the position of the trimming frame with the directional pad (page 37), and then press **MENU/OK**.

⚠ Cautions

- Only images taken using this camera body can be trimmed.
- Movies and MP files cannot be trimmed.
- For RAW images (page 61), trimming function applies only to the JPEG copy.
- Images can be trimmed repeatedly, however, the quality of the image will be degraded each time by recompression.

📌 Notes

- If an image is trimmed, the compression rate changes to Fine. For images in other sizes, the compression rate will be the same as the original's.
- The available settings for the trimming frame size differ depending on the original image size. Each time you press the **Q** button, the trimming frame decreases in size by one level, at the maximum of 13 levels.

- The trimmed image size differs depending on the image's original size and the trimming level (the size of trimming frame).

Level Compensation

Create copies that have been processed to adjust brightness and contrast. Correct brightness and contrast automatically or make manual adjustments using a histogram.

Auto: Automatic Level Compensation

1 Display a photograph.

Display the photograph to be copied in playback mode.

2 Select Level Compensation.

Press MENU/OK to display the playback menu, highlight **Level Compensation**, and press Fn2.

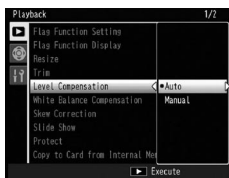

3 Select Auto.

Highlight **Auto** and press Fn2. If the camera is able to create a copy, a preview will be displayed with the original image displayed at upper left, the corrected copy at right. If the camera cannot create a copy, an error message will be displayed and the camera will exit to the playback menu.

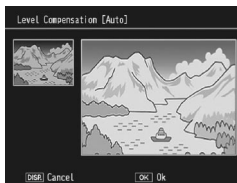

4 Copy the image.

Press **MENU/OK**. To exit without creating a copy, press the **DISP.** button. A message will be displayed while the camera copies the photograph.

Manual: Manual Level Compensation

Display the photograph to be copied and select **Manual** for **Level Compensation** in the playback menu to display a preview as described on the preceding page, then follow the steps below.

1 Select the black point, white point, or mid-point.

The manual preview contains a histogram showing how pixels of different brightnesses are distributed in the image, with dark pixels (shadows) on the left and bright pixels (highlights) on the right. Press the **ADJ.** lever in to cycle through the black point, mid-point, and white point and press **Fn1** or **Fn2** to position the selected point for enhanced brightness and contrast as described on the following page. For help, press the  button; press the button again to return to the preview display.



*From left to right:
black point, mid-
point, white point*

2 Copy the image.

Press **MENU/OK**. To exit without creating a copy, press the **DISP.** button. A message will be displayed while the camera copies the photograph.

Tip: Choosing the Black Point, White Point, and Mid-Point

- **Adjusting brightness:** To make the image brighter, move the mid-point to the left. Moving the mid-point to the right makes the image darker.
- **Correcting exposure:** If the image is overexposed, move the black point to the right until it lines up with the darkest pixel in the histogram (see right). If the image is underexposed, move the white point to the left until it lines up with the brightest pixel. You can then move the mid-point left or right to adjust brightness.
- **Increasing contrast:** To increase contrast, align the black point and white point with the darkest and brightest pixels as shown at right. You can then move the mid-point left or right to adjust brightness.

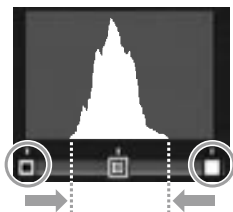
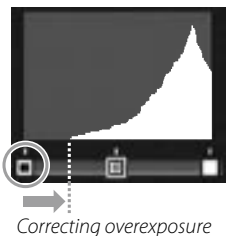

Cautions

- Level compensation is available only with still images taken using this camera body. It is not available with movies or pictures taken using **M-Cont Plus**. The desired results may not be achieved with monochrome images.
- Level compensation can be applied multiple times, however, the quality of the image will be degraded each time by recompression.

White Balance Compensation

Create copies with modified white balance.

1 Display a photograph.

Display the photograph to be copied in playback mode.

2 Select **White Balance Compensation**.

Press **MENU/OK** to display the playback menu, highlight **White Balance Compensation**, and press **Fn2**.

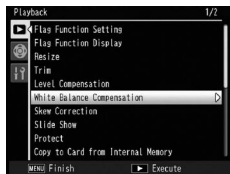

3 Adjust white balance.

Choose white balance compensation using the directional pad (page 37). Press the **DISP.** button to reset white balance compensation to a neutral value.

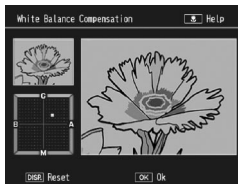

4 Press **MENU/OK**.

Press **MENU/OK** to copy the image (to exit without creating a copy, press **DISP.** twice). A message will be displayed while the camera copies the photograph.



Cautions

- White balance compensation is available only with still images taken using this camera body. It is not available with movies or pictures taken using **M-Cont Plus**. The desired results may not be achieved with monochrome images.
- White balance compensation can be applied multiple times, however, the quality of the image will be degraded each time by recompression.

Skew Correction

Create copies that have been processed to reduce the effects of perspective on rectangular objects, such as message boards or business cards.

1 Display a photograph.

Display the photograph to be copied in playback mode.

2 Select Skew Correction.

Press **MENU/OK** to display the playback menu, highlight **Skew Correction**, and press **Fn2**. If the camera is able to detect an object that can be used to correct perspective,

a message will be displayed with the object shown by an yellow frame. The camera can detect up to five objects; to select a different object, press **Fn2**, or press **+** to exit without correcting perspective. If the camera is unable to detect a suitable subject, an error message will be displayed.

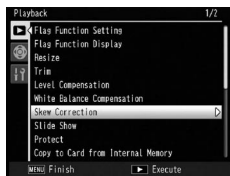

3 Press MENU/OK.

A message will be displayed while the camera copies the photograph. Copying takes from about 2 to 46 seconds, depending on image size.



Caution

Skew correction is available only with still images taken using this camera body. It is not available with movies or pictures taken using **M-Cont Plus**. For RAW images (page 61), skew correction applies only to the JPEG copy.



Notes

- The copy is the same size as the original. More time is needed to create a copy for larger image sizes:

Size	Time (approx.)	Size	Time (approx.)
L	24 sec.	3M	8 sec.
M	18 sec.	1M	5 sec.
5M	12 sec.	VGA	2 sec.

To reduce the time required, create a small copy of the original using **Resize** (page 104) and perform skew correction on the copy.

- The time required for skew correction differs depending on the camera unit.
- Skew correction can also be performed during shooting (page 56).

Slide Show

Selecting this option starts an automated slide show. Pictures are displayed at three second intervals in the recorded order. When a movie is displayed, movie playback begins automatically.

The slide show repeats until stopped; press any button to end the slide show.

Protect

Protect pictures from accidental deletion. Protected files are indicated by the icon shown at right.



Caution

Formatting erases all files, including protected files.

Protecting Individual Pictures

To protect or remove protection from individual files, play the picture back, select **Protect** in the playback menu, and press **Fn2** to display the options shown at right (if the desired image is not displayed, press **Fn1** or **Fn2** to view other pictures). Highlight **1 File** and press **MENU/OK**.

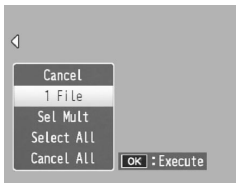

Changing the Protect Status of Multiple Files

Follow the steps below to change the protect status of multiple selected files.

1 Select **Protect** in the playback menu, and press Fn2.

In multi-frame playback, proceed to step 2. In single-frame playback, the options shown at right will be displayed. Highlight **Sel Mult** and press MENU/OK.

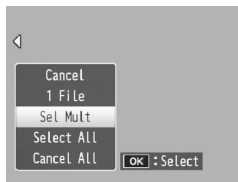

2 Select **Sel. Individ.** or **Sel. Range**.

Select **Protect** in the playback menu, and press Fn2 to display the options shown at right. To select images one at a time, highlight **Sel. Individ.**, press MENU/OK, and proceed to step 3. To select images by specifying ranges highlight **Sel. Range**, press MENU/OK, and proceed to step 3.1.



3 Select a photograph.

Use the directional pad (page 37) to highlight a photograph, and press MENU/OK. Protected pictures are marked with a  icon. To remove protection from a photograph, highlight it and press MENU/OK again.



 **Tip: Selecting Ranges** 

To switch from **Sel. Indiv.** to **Sel. Range**, press the **ADJ.** lever and follow the steps below:

3.1 Use the directional pad to highlight the first image of the range, and press **MENU/OK** to select. The selected image is marked with an icon. To deselect the image, press the **DISP.** button.



3.2 Use the directional pad to highlight the last image, and press **MENU/OK** to select. The selected images will be marked with a  icon.



Repeat steps 3.1–3.2 to select additional ranges, or press the **ADJ.** lever to select or deselect individual photographs as described in step 3.

4 Press the button.

A message will be displayed while the camera protects the selected files. The camera will then return to normal playback.

Protecting or Removing Protection from All Files

To protect all files, select **Protect** and press **Fn2**. Highlight **Select All** and press **MENU/OK**. To remove protection from all files, highlight **Cancel All** and press **MENU/OK**.

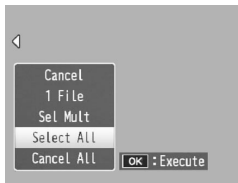

Copy to Card from Internal Memory

To copy all files from internal memory to a memory card, insert the memory card in the camera body and select **Copy to Card from Internal Memory** in the playback menu. A message will be displayed while copying is in progress; the camera will return to playback when copying is complete.



Notes

- If the space available on the memory card is insufficient to copy all the files in internal memory, a message will be displayed. To copy only those files that will fit in the space available, highlight **Yes** and press **MENU/OK**; to exit without copying any files, select **No**.
- Files cannot be copied to internal memory from a memory card.

DPOF

To request professional prints of the photographs on a memory card, first use this option to create a digital “print order” listing the photographs you wish to print and the number of prints, and then take the memory card to a digital print service center that supports the DPOF standard.



Note

If a RAW file is selected for printing, only the JPEG copy will be printed.



Tip: DPOF

DPOF (**D**igital **P**rint **O**rders **F**ormat) is a standard used to specify the photographs to be printed and the number of prints. Photographs selected for printing are marked with a DPOF print indicator (page 9).

Selecting Individual Photographs for Printing

To add a photograph to or remove it from the print order, play the picture back, select **DPOF** in the playback menu, and press **Fn2** to display the options shown at right (if the desired image is not displayed, press **Fn1** or **Fn2** to view other pictures). Highlight **1 File** and press **MENU/OK**.

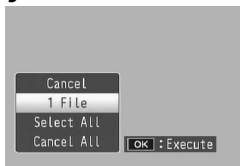

Selecting All Photographs for Printing

To select all photographs for printing, select **DPOF**, press **Fn2**, highlight **Select All**, and press **MENU/OK**. To remove all photographs from the print order, highlight **Cancel All** and press **MENU/OK**.

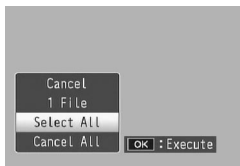

Selecting Multiple Photographs for Printing

To select multiple photographs for printing:

1 Select **DPOF**.

Press **MENU/OK** in multi-frame playback to display the playback menu. Highlight **DPOF** and press **Fn2**.

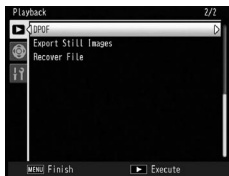

2 Select photographs and choose the number of prints.

Press **Fn1** or **Fn2** to highlight additional photographs and **+** or **-** to choose the number of prints. To remove a photograph from the print order, press **-** until zero is displayed.

3 Press MENU/OK.

A message will be displayed while the camera creates the print order. The camera will then return to multi-frame playback.

Recover File

To restore all the deleted files, select **Recover File** in playback menu, and then press **Fn2**. The confirmation message appears. Select **Yes** and then press **MENU/OK**.



Note

If there are no files to be restored, a message appears.



Cautions

The files cannot be restored after performing any of the following operations.

- Turning the camera off
- Switching from playback mode to shooting mode
- Using **DPOF**, **Resize**, **Copy to Card from Internal Memory**, **Skew Correction**, **Level Compensation**, **White Balance Compensation** or **Trim** function.
- Deleting files with DPOF settings
- Initializing Internal memory or SD memory card
- Setting or canceling files for **Flag Function Setting**
- Exporting MP files using **Export Still Images**

Viewing Pictures on TV

To view pictures on a TV, connect the camera body using the supplied A/V cable.

1 Turn the camera body off.

Be sure the power is off before connecting or disconnecting the A/V cable.

2 Connect the A/V cable to the TV.

Insert the white plug into the audio input connector, the yellow plug into the video input connector. Be sure the plugs are securely connected. *Do not use force.*

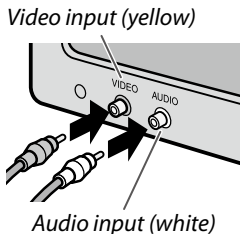

3 Connect the camera body.

Open the connector cover and plug the cable into the A/V cable connector. *Do not use force.*

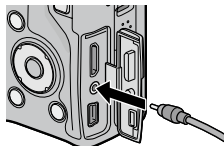

4 Tune the television to the video channel.

Select video input. See the television manual for details.

5 Turn the camera body on.

Press the  button for about a second to turn the camera body on in playback mode. The camera body's picture display and speaker will turn off, and photographs and movies will be played back on the TV.



Caution

Do not use force or tug the A/V cable when handling the camera body with the A/V cable connected.



Notes

- The camera body can be connected to the video input connector on a video recorder, and pictures can be recorded to video or DVD.
- The camera body can be connected to TVs that support HDMI using an HDMI mini cable (sold separately). See the documentation provided with TVs for details.
- If connecting or disconnecting the HDMI mini cable, the display switches to single-frame view. When the menu is displayed, it will not switch to single-frame view even if connecting or disconnecting the HDMI mini cable.
- When connecting the camera body to a TV using an HDMI mini cable, the operational sounds turn off.
- The camera body supports the following video standards: NTSC (used in North America, the Caribbean, parts of Latin America, and some East Asian countries) and PAL (used in the United Kingdom and much of Europe, Australia, New Zealand, and parts of Asia and Africa). SECAM is not supported. Where possible, it is set to the standard used in your country or region before shipment; before connecting the camera body to a device that uses a different video standard, choose the appropriate video mode (page 149).

Printing Photographs

The camera body can be connected to a printer via the supplied USB cable, and photographs can be printed directly from the camera body without using a computer.



Caution

Movies cannot be printed. If a RAW file is selected for printing, only the JPEG copy will be printed.



Note

The camera body conforms to PictBridge, a standard widely used for direct printing, and direct printing is consequently only available with PictBridge-compliant printers. See the documentation provided with your printer for information on whether it supports PictBridge.

Connecting the Camera Body

Connect the power to the printer using the supplied USB cable.

1 Turn the camera body off.

Be sure that the power is off before connecting or disconnecting the USB cable.

2 Connect the USB cable to the printer.

Connect the USB cable to the printer and turn the printer on.

3 Connect the camera body.

Open the connector cover and plug the cable into the USB cable connector.

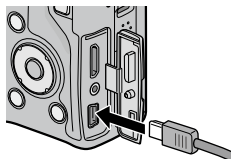

Press the **ADJ.** lever. The camera body will turn on and the message shown at right will be displayed; press the **ADJ.** lever again immediately.



Note

If you do not press the **ADJ.** lever while the above message is displayed, it may in some cases be replaced after two seconds by a message stating that the camera body is connecting to a computer. Turn the camera body off and press the **ADJ.** lever again.

The message will be replaced by the PictBridge playback display (if the PictBridge playback display does not appear, the camera body is still establishing a connection to the printer).



Caution

Do not use force when connecting the USB cable or when handling the camera body with the cable connected.

Printing

Photographs can be printed one at a time or multiple photographs can be selected for printing. If a memory card is inserted, the pictures will be printed from the memory card; otherwise pictures will be printed from internal memory.



Caution

Do not disconnect the USB cable while printing is in progress.



Note

If an error is displayed during printing, check the printer and take the appropriate action.

Printing Photographs One at a Time

To print a selected photograph:

1 Select a Photograph.

Press Fn1 or Fn2 until the desired Photograph is shown in the PictBridge playback display and press the ADJ. lever. The menu shown at right will be displayed; highlight **1 File** and press MENU/OK.

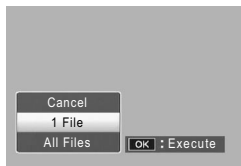

Tip: Printing One Copy of All Photographs

To print one copy of all Photographs, press the ADJ. lever to display the options shown above and select **All Files**.

2 Adjust printer settings.

The menu shown at right will be displayed; highlight an item and press **Fn2** to view the options available, or choose **Printer Select** to use the default setting for

the current printer (the options available vary with the type of printer; items not supported by the connected printer cannot be selected). Press **+** or **-** to highlight an option and press **MENU/OK** to select and return to the direct print menu.

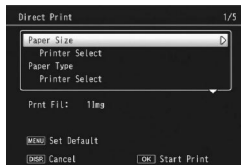

Item	Description
Paper Size	Choose the paper size.
Paper Type	Choose the paper type.
Layout	Choose the number of pictures per page.
Date Print	Include the time and date of recording. See pages 20 and 149 for information on selecting the order in which the time and date are displayed. If the picture was taken using Date Imprint (page 84), only the imprinted date will be printed.
File Name Print	Include the file name.
Optimize Image	Choose whether the printer optimizes photo data.
Print Size	Choose the print size.
Print Quality	Choose the print quality.
Report Print*	Print a report.
Printing Quantity	Choose the number of copies.
Toner Saving*	Use less toner during printing.
1-Side/2-Sides*	Print on one or both sides of the paper.

* Ricoh printers only. Visit <http://www.ricoh.com/> for details.



Note

To select the highlighted option as the default for the current printer when the camera body is connected, press the **ADJ.** lever. The menu shown at right will be displayed; highlight **Set** and press **MENU/OK**. Select **Cancel** to exit without changing the default setting.

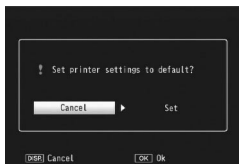

3 Start printing.

To start printing, press **MENU/OK** when the direct print menu shown in step 2 is displayed. A message is displayed during printing; to exit before printing is complete, press the **DISP.** button. The PictBridge playback display will appear when printing is complete.

Printing Multiple Photographs

To print multiple photographs:

1 Press the  button.

Photographs will be displayed in multi-frame playback.

2 Select a picture.

Highlight a picture and press MENU/OK.

3 Choose the number of prints.

Press + or – to choose the number of prints. Selected pictures are marked with a  icon; to deselect a photograph, press – until zero is display.

4 Select additional Photographs.

Press Fn1 or Fn2 to highlight additional photographs and press + or – to choose the number of prints.

5 Adjust printer settings.

Press MENU/OK to display the direct print menu. Adjust settings as described on page 123.

6 Start printing.

To start printing, press MENU/OK when the direct print menu is displayed. A message is displayed during printing; to exit before printing is complete, press the DISP. button. The PictBridge playback display will appear when printing is complete.

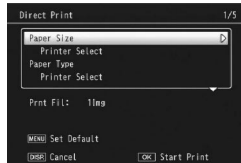
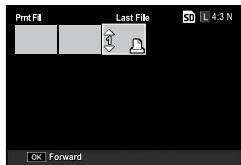

Camera Settings

The menus for modifying the camera settings can be accessed from the shooting and playback menus (pages 58 and 101).

1 Display the menus.

Press **MENU/OK** to display the menu for the current mode on page 58 (in scene mode, a **MODE** tab will be displayed).

2 Select a tab.

Press **Fn1** to highlight the tab for the current menu and press **+** or **-** to highlight the key custom options tab (page 127) or the setup tab (page 128). Press **Fn2** to place the cursor in the selected tab.

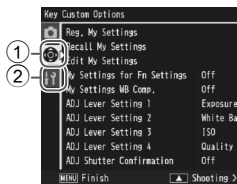

① *Key custom options tab*

② *Setup tab*

3 Select a menu item.

Press **+** or **-** to highlight a menu item and press **Fn2** to display options for the highlighted item.

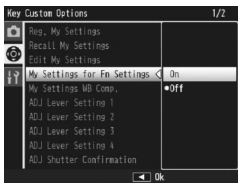

4 Select an option.

Press **+** or **-** to highlight an option and press **MENU/OK** to select and exit (the procedure may differ for some items; see the page for the item).

The key custom options tab contains the following options.

Option	Default	Page	Option	Default	Page
Reg. My Settings	—	129	ADJ Shutter Confirmation	Off	135
Recall My Settings	—	131	Set Fn1 Button	AF/MF	136
Edit My Settings	—	132	Set Fn2 Button	Manual Flash	136
My Settings for Fn Settings	Off	133	+/- Button Settings	Exposure Comp.	137
My Settings WB Comp.	Off	133	Playback Mode Dial Options	Setting1	138
ADJ Lever Setting 1	White Balance	134	M Mode Dial Options	Setting1	138
ADJ Lever Setting 2	ISO	134	One Press M Mode	Aprtr Priority	138
ADJ Lever Setting 3	Quality	134			
ADJ Lever Setting 4	Image Settings	134			

The setup tab contains the following options:

Option	Default	Page	Option	Default	Page
Format [Card]	—	139	Level Setting	Display	144
Format [Internal Memory]	—	139	Grid Guide Display Options		144
LCD Brightness	—	139	Fn Button Display	On	145
DIRECT Screen Transparency	Normal	140	Show My Setting Name	Off	145
Exposure/Flash Comp. Step	1/3EV	140	Shooting Info. Display Frame	Off	145
ISO Auto-High Settings	AUTO 400	140	CL-BKT Black & White (TE)	On	146
AF Auxiliary Light	On	140	Color Space Set	sRGB	146
Sleep Mode	5 minutes	141	Digital Zoom Image	Normal	147
Auto Power Off	5 minutes	141	Store Menu Cursor Position	Off	147
Playback Screen	LCD	141	Card Sequence No.	On	148
LCD Auto Dim	On	142	Date Settings	—	149
LCD Confirmation Time	0.5 seconds	142	Language/言語	(Varies*)	149
Operation Sounds	All	142	Video Out Mode	(Varies*)	149
Volume Settings	    (medium)	142	HDMI Output	AUTO	149
One Press Zoom Ratio	9.8×	143	Start Settings Readout	Body	150
Auto Rotate	On	143	* Varies with country or region of purchase.		
Minimum Shooting Distance	Show	144			



Cautions

- The options displayed in the key custom options tab and setup tab may differ depending on whether the camera unit is attached to the camera body.
- The options displayed in the key custom options tab and setup tab may differ depending on the camera unit.

Key Custom Options

Reg. My Settings

Settings saved using **Reg. My Settings** can be recalled by rotating the mode dial to **MY1**, **MY2**, or **MY3**, allowing you to easily create and recall up to six sets of frequently-used shooting settings.

1 Adjust settings.

Set the camera to the desired settings. The following is some of the settings that can be saved in **MY** settings:

- **Camera settings:** Shooting mode (📷, **P**, **A**, **S**, **M**, or **SCENE** mode), zoom position (in **SCENE** mode), aperture (in **A** and **M** modes), shutter speed (in **S** and **M** modes), manual focus, macro, flash, self-timer and display modes.
- **Shooting menu options:** All options except **Interval Shooting**, **Auto Aperture Shift**, and **Switch Shooting Mode**. White balance compensation can be assigned if **My Settings WB Comp.** is on (page 133).
- **Setup options:** **Set Fn1 Button/Set Fn2 Button** (if **My Settings for Fn Settings** is on; see page 133), **+/- Button Settings**, **ISO Auto-High Settings**, **Exposure/Flash Comp. Step**, **Minimum Shooting Distance**, **Level Setting**, **Grid Guide Display Options**, **Shooting Info. Display Frame**, **CL-BKT Black & White (TE)**, and **Digital Zoom Image**.



Note

The settings that can be saved in **MY** settings differ depending on the camera unit. See the documentation provided with the camera unit for details.

2 Select **Reg My Settings**.

Highlight **Reg. My Settings** in the key custom options tab, and press **Fn2**.

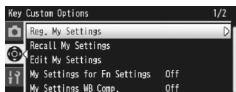

3 Save settings.

To assign the settings to **MY1**, **MY2**, or **MY3** on the mode dial, highlight **MY1**, **MY2**, or **MY3**, and press **MENU/OK** (to exit without saving settings, press the **DISP.** button).

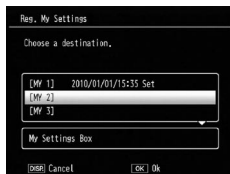

To save the settings to a “box” to be recalled and assigned to the mode dial at a later date (page 131), select **My Settings Box** and press **Fn2**. Highlight the desired box and press **MENU/OK**.

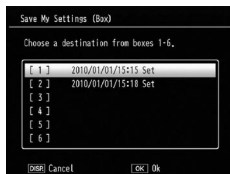

Unnamed boxes will be named using the current date. If the box has already been assigned a name, the dialog shown at right will be displayed. Select **Yes** to use the current name, **No** to use a name based on the current date.



Recall My Settings

Copy settings from a “box” to MY1, MY2, or MY3.

Select **Recall My Settings** in the key custom options tab, press **Fn2**, and follow the steps below.

1 Select a destination.

Highlight the destination for the stored settings (**MY1**, **MY2**, or **MY3**) and press **Fn2**.

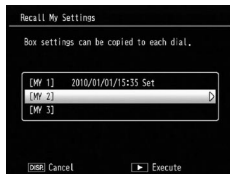

2 Select the source.

Highlight the settings that will be assigned to the selected position on the mode dial and press **MENU/OK**.



To exit without assigning settings to the mode dial, press the **DISP.** button.



Caution

If **Edit My Settings** is used to edit boxes that are currently assigned to the mode dial, the changes will be reflected when the mode dial is rotated to the position assigned to the box. Changes to settings assigned directly to **MY1**, **MY2**, or **MY3** are not however reflected in the boxes currently assigned to the mode dial, and if the boxes are subsequently changed, these changes will not be reflected in the settings assigned to **MY1**, **MY2**, or **MY3**.

Edit and rename settings saved with **Reg. My Settings**.

Select **Edit My Settings** in the key custom options tab, press **Fn2**, and follow the steps below.

1 Select a setting.

To edit the settings assigned to **MY1**, **MY2**, or **MY3** on the mode dial, highlight **MY1**, **MY2**, or **MY3** and press **Fn2**.

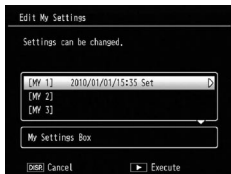

To edit “box” settings, select **My Settings Box** and press **Fn2**. Highlight the desired box and press **Fn2**.

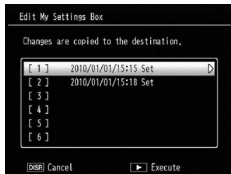

2 Edit settings.

Press **+** or **-** to highlight items and press **Fn2** to edit (see the section for each item in this manual for more information). After editing each item, press **Fn1** to return to the settings list, where you can edit additional settings.



3 Save changes and exit.

Press **MENU/OK** to save changes and exit (to exit without saving changes, press the **DISP.** button).



Tip: Naming My Settings

Select **Name** in step 2 to rename the setting. The current name is highlighted in the name area; to edit the current name, press **Fn1** or **Fn2** to position the cursor in the name area and press **-** to place the cursor in the keyboard area (to delete the current name, press **-** while the name is highlighted). Highlight characters using **+**, **-**, **Fn1**, or **Fn2**, and press **MENU/OK** to enter the highlighted character at the current cursor position (to delete the character at the current cursor position, select **[Delete]**). Press the **⌂** button to switch between upper and lower case. Names can be up to 32 characters long. Press the **ADJ.** lever to exit, or press the **DISP.** button to exit without renaming the settings.

Name area



Keyboard area

My Settings for Fn Settings

Select **On** to save the settings assigned to the **Fn** buttons (page 136) to **MY** settings saved in **Reg. My Settings**.

My Settings WB Comp.

Select **On** to save the white balance compensation setting (page 89) to **MY** settings saved in **Reg. My Settings**.

ADJ Lever Setting

Assign up to four frequently-used options to the **ADJ.** lever for quick access in , **P**, **A**, **S**, and **M** modes. At default, the **ADJ.** lever can be used for white balance (page 86), ISO setting (page 90), picture quality (page 61), and image setting (page 71). The following functions can also be assigned; white balance compensation (page 89), focus (page 64), metering (page 70), continuous (page 73), bracketing (page 75), flash compensation (page 78), manual flash amount (page 79), and exposure compensation (page 85).

In **SCENE** mode, the **ADJ.** lever can be used to select white balance and exposure compensation (exposure compensation is not available for Movie mode).

Using the ADJ. Lever

To select an option currently assigned to the ADJ. lever:

1 Display options.

Press the ADJ. lever in shooting mode, and press the lever to the left or right, or press Fn1 or Fn2 to view the options assigned to the lever.

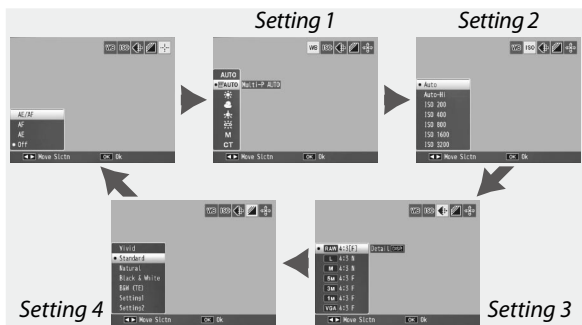

2 Select an option.

Press + or - to highlight an option, and press the ADJ. lever or press MENU/OK.



Tip

Press and hold the ADJ. lever to page rapidly through the available options.

ADJ Shutter Confirmation

Select On to use the shutter-release button to select the highlighted option in the ADJ. mode.

Set Fn1/Fn2 Button

Choose the functions assigned to the Fn1 and Fn2 buttons with **Set Fn1/Fn2 Button** in the key custom options tab.

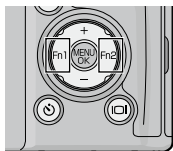

The following is some of the functions that can be assigned to the **Fn1** and **Fn2** buttons.

Option	Description
AF/MF	Switch between multi AF or spot AF and manual focus (page 64). ^{*1,3}
AF/Snap	Switch between multi AF or spot AF and snap focus (page 64). ^{*4}
AE Lock	Lock exposure. ^{*2,5}
JPEG>RAW^{*10}	If options other than RAW is selected for Picture Quality/Size , pressing the Fn button selects a RAW option with the same aspect ratio (page 61). ^{*5,6}
Color>B&W	Select Black & White for Image Settings (page 71). ^{*7}
Color>TE	Select B&W (TE) for Image Settings (page 71). ^{*7}
Exposure Comp.	Display the exposure compensation slider (page 85). ^{*5}
White Balance	Display white balance options (page 86).
WB Correction	Display white balance compensation controls (page 89). ^{*9}
ISO	Display ISO sensitivity options (page 90). ^{*7}
Quality	Display picture quality/size options (page 61).
Focus	Display focus options (page 64). ^{*4}
Image Settings	Display image setting options (page 71). ^{*7}
Expo. Metering	Display exposure metering options (page 70). ^{*7}
Cont. Mode	Display continuous shooting options (page 73). ^{*8}
Auto Bracket	Display bracketing options (page 75). ^{*8}
Macro Target	Position the focus target in macro mode (page 68). ^{*3}
Flash Comp.	Display the flash compensation slider (page 78). ^{*4,5}

Option	Description
--------	-------------

Flash Amount	Adjust manual flash output (page 79). ^{*8}
---------------------	---

^{*1} If focus is locked in autofocus mode (page 64), selecting manual focus sets the focus distance to the distance at which focus is locked.

^{*2} Exposure cannot be locked in mode **M**. Pressing the **Fn** button in mode **M** sets shutter speed and aperture to values close to those needed for optimal exposure.

^{*3} Not available when Portrait, Sports, Landscape or Nightscape is selected in **SCENE** mode.

^{*4} Not available when Landscape is selected in **SCENE** mode.

^{*5} Not available when Movie is selected in **SCENE** mode.

^{*6} Not available when Skew Correction is selected in **SCENE** mode.

^{*7} Not available in **SCENE** mode other than Skew Correction.

^{*8} Not available in **SCENE** mode.

^{*9} Not available in **SCENE** mode other than Movie.

^{*10} The image sizes of the files switched to RAW differ depending on the settings selected in **Picture Quality/Size**.

Settings in Picture Quality/Size	Sizes in RAW Data
L (16:9), M (16:9), 5M, 3M, 1M, VGA	RAW (16:9)
L (4:3), M (4:3)	RAW (4:3)
L (3:2), M (3:2)	RAW (3:2)
L (1:1), M (1:1)	RAW (1:1)

By default, **AF/MF** is assigned to the **Fn1** button and **Flash Amount** to the **Fn2** button.

+/- Button Settings

Choose the functions to assign to the + and – buttons. Choose from **Off**, **Flash Comp.** (page 78), **Flash Amount** (page 79), and **Exposure Compensation** (page 85).

Playback Mode Dial Options/M Mode Dial Options

Choose the functions to assign to the ADJ. lever and up-down dial for playback zoom and in mode M.

	Playback Mode Dial Options		M Mode Dial Options	
	Setting1	Setting2	Setting1	Setting2
ADJ. lever	Next/previous frame	Scroll left/right	Shutter speed	Aperture
Up-down dial	Zoom in/out	Scroll up/down	Aperture	Shutter speed

One Press M Mode

When exposure compensation is assigned to the + and – buttons (page 137) or AE lock is assigned to the Fn1 and Fn2 button (page 136), pressing the assigned button in manual exposure mode sets shutter speed and/or aperture to values close to those needed for optimal exposure. Select a setting from the following options.

- **Aprrtr Priority:** Aperture remains at the selected value; shutter speed is adjusted for optimal exposure.
- **Shtrr Priority:** Shutter speed remains at the selected value; aperture is adjusted for optimal exposure.
- **Program:** Both aperture and shutter speed are adjusted for optimal exposure.

Note

In manual exposure mode, exposure compensation cannot be performed with the + and – buttons, nor can AE lock be performed with the Fn buttons.

Setup

Format [Card]/Format [Internal Memory]

Select **Format [Card]** to format the memory card before first use, after using it in another device, or if a card error is displayed when the card is inserted in the camera body. Select **Format [Internal Memory]** if a message is displayed prompting you to format internal memory.

Cautions

- *Formatting permanently deletes all data on the card or in internal memory.* Before formatting, copy any data you wish to keep to a computer (page 151).
- Selecting **Format [Card]** when no memory card is inserted displays an error message. Turn the power off and insert a memory card.

Tip: Write Protection

To prevent memory cards from being formatted, slide the write-protect switch to the “LOCK” position (page 16). Restore the switch to its original position to resume normal operation.

LCD Brightness

Selecting this option displays the control shown at right. Press + or – to adjust picture display brightness, and press **MENU/OK** to return to the setup menu. Press **MENU/OK** again to exit to shooting or playback mode.



**Note**

The brightness display shows the view through the lens (shooting mode) or the most recently viewed picture (playback mode; if no picture is available for playback, no image will be shown in the brightness display).

DIRECT Screen Transparency

Choose the density of the background image displayed on the DIRECT screen from **Dark, Normal, Light, or Image OFF**.

Exposure/Flash Comp. Step

Choose the step value for the exposure compensation and flash compensation. Choose from the value of **1/2EV or 1/3EV**.

**Note**

In the shutter priority mode, step value is set to **1/3EV** even if **1/2EV** is selected for **Exposure/Flash Comp. Step**.

ISO Auto-High Settings

Choose the maximum sensitivity selected by the camera when **Auto-Hi** is selected for **ISO Setting** in the shooting menu (page 90). Choose from settings of ISO 200 (**AUTO 200**), 400 (**AUTO 400**), 800 (**AUTO 800**), 1600 (**AUTO 1600**) or 3200 (**AUTO3200**).

**Note**

Noise (random variations in brightness and color) may appear in photographs taken at high sensitivities.

AF Auxiliary Light

If **On** is selected, the AF auxiliary light will light to assist the focus operation when the subject is poorly lit.

Sleep Mode

Choose the delay before the picture display enters sleep mode. Choose from **Off**, **1 minute**, **5 minutes** or **30 minutes**. Autofocus/flash lamp lights in sleep mode. Press any button to cancel the sleep mode.



Cautions

- The camera body does not enter sleep mode when:
 - Shooting, playback, key custom options or setup menu is displayed.
 - The camera body is turned on by pressing the  button with the power switch at OFF position.
- The lens of camera unit is not retracted in the sleep mode.

Auto Power Off

Choose the delay before the camera turns off automatically to save power when no operations are performed. Select from **Off** (the camera does not turn off automatically), **1 minute**, **5 minutes**, and **30 minutes**.



Note

When **Sleep** and **Auto Power Off** are set, **Auto Power Off** works after the specified time for **Sleep** has elapsed.

Playback Screen

Choose the screen to display playback images from **LCD** (picture display) or **VF** (viewfinder) for when the LCD viewfinder (VF-2) is attached to the camera body.

When the viewfinder is not attached, the playback images are displayed in the picture display regardless of the setting for **Playback Screen**.

LCD Auto Dim

If **On** is selected, the picture display dims to save power when the camera is not moved for approximately five seconds in shooting mode. Move the camera or press any button to return to the original picture display brightness.

LCD Confirmation Time

Choose how long photographs are displayed in the picture display immediately after shooting. Select from 0.5, 1, 2, and 3 seconds, **Hold** (photograph is displayed until shutter-release button is pressed halfway and can be viewed with playback zoom or deleted; see pages 38 and 39), and **Off** (photographs are not displayed in the picture display after shooting).

Operation Sounds

Choose when the camera plays a sound.

Option	Description
All	Sounds are played at startup, when the shutter is released, when the camera focuses, and when an error occurs. If Sound or Disp + Snd is selected for Level Setting (page 32), the camera will also beep at regular intervals when the camera is level.
Level Sound	If Sound or Disp + Snd is selected for Level Setting , the camera will beep at regular intervals when the camera is level.
Shutter Sounds	Sounds are played when the shutter is released or an error occurs. If Sound or Disp + Snd is selected for Level Setting , the camera will beep at regular intervals when the camera is level.

Volume Settings

Select the volume for the sounds described in "Operation Sounds." Choose from $\blacktriangle \times \square \square \square$ (off), $\blacktriangle \blacksquare \square \square$ (low), $\blacktriangle \blacktriangleright \blacksquare \square$ (medium), and $\blacktriangle \blacktriangleright \blacksquare \blacksquare$ (high).

One Press Zoom Ratio

Select the magnification at which pictures are displayed when zoomed in using the **MENU/OK** button or **ADJ.** lever (page 38). Choose from 5.7×, 9.8×, and 16×.



Notes

- Maximum magnification ratio differs depending on the image size (page 38).
- If the maximum magnification ratio of an image size is smaller than the setting specified in **One Press Zoom Ratio**, the image can be magnified at the maximum ratio for the image size (page 38).

Auto Rotate

Select **On** to automatically display pictures in the correct orientation during playback.



Caution

Movies, pictures taken using **M-Cont Plus** (page 73), and pictures taken with the camera upside down or tilted sharply forward or back are not rotated for display. Pictures are not rotated when the camera unit is not attached to the camera body, during slide shows, in multi-frame playback, or when displayed on a TV, nor are they rotated when the camera is upside down or if the camera is rotated during playback zoom or while skew correction is in progress.



Note

During bracketing or when taking pictures using **Continuous**, the camera only records the orientation for the first photograph in each series. The remaining photographs will not be displayed in the correct orientation if the camera was rotated during shooting.

Minimum Shooting Distance

Select **Show** to display the minimum shooting distance in the picture display.

Level Setting

The camera uses a tilt indicator and sounds to let you know whether the image is level during shooting. Choose tilt indicator settings (page 32).

Grid Guide Display Options

Choose the type of framing grid available in shooting mode (page 42).

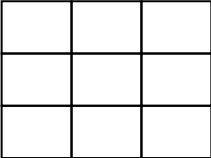
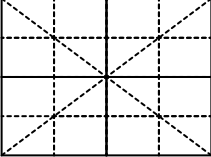
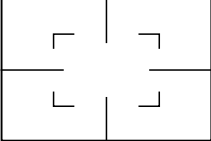
Item	Description
	A three-by-three grid for “rule of thirds” composition.
	A four-by-four grid with diagonal lines running from corner to corner makes it easy to find the center of the subject. Use for architectural photography or photographing products for display.
	A two-by-two grid with the center of the frame left clear to make it easier to view the subject. Use if your subject is in motion.

Fn Button Display

Select **On** to display the options currently assigned to the Fn buttons when the camera is turned on, shooting mode is selected, or a new mode is selected with the mode dial.

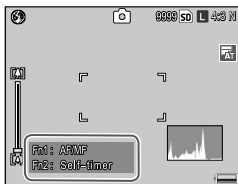

Show My Setting Name

Select **On** to display the name of the settings assigned to the current position on the mode dial when the dial is rotated to MY1, MY2, or MY3.



Shooting Info. Display Frame

Select **On** to display shooting icons in a frame surrounding the view through the lens (page 8), making it easier to frame photographs in the picture display. The frame is not displayed in movie mode.



CL-BKT Black & White (TE)

Choose the number and type of copies created with color bracketing (page 77). Select **On** to record three copies of each shot (one in black and white, a second in color, and a third using a monochrome tint), **Off** to record two copies (one in black and white and the second in color).



Note

Regardless of the selected setting, three copies of each photograph will be recorded if **B&W (TE)** is selected for **Image Settings**.

Color Space Setting

Choose the color space used to record photographs. **sRGB** is widely used to reproduce digital images but offers a smaller gamut of colors than **AdobeRGB**.



Caution

The Adobe RGB color space was developed by Adobe Systems, Inc., and is compatible with the default color space used in Adobe Photoshop and other image editing software. Note, however, that colors will only be reproduced correctly in software that supports the Adobe RGB color space. Also note that specialized equipment is required to print the full range of colors in the Adobe RGB gamut; when printed using consumer household printers or digital photo print services, colors will generally be less vivid than in photographs that use the sRGB color space.

Digital Zoom Image

Choose how the image taken using the digital zoom will be saved.

- **Normal:** Normal digital zoom. It crops a portion of an image and enlarges the portion back to the size selected in **Picture Quality/Size**, resulting in lower image quality.
- **Auto Resize:** It crops a portion of an image and save the image in the cropped size. It keeps from decreasing the image quality, however, the image size becomes smaller. The sizes of cropped image differ depending on the zoom ratio. See the documentation provided with the camera unit.

Auto Resize zoom is available only when 4:3 for L is selected for **Picture Quality/Size** (page 61).

The current picture size is displayed in the picture display when the camera is zoomed in.

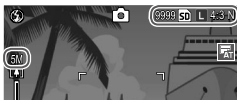

Caution

Auto Resize has no effect when **M-Cont Plus** or **Skew Correction** is selected in **SCENE** mode, or when **RAW** is selected for **Picture Quality/Size**.

Store Menu Cursor Position

If **On** is selected, the most-recently accessed item will be highlighted when menus are displayed.

Card Sequence No.

Choose how the camera names image files when saving photographs to a memory card.

- **On:** File names consist of “R” followed by a seven-digit number (e.g., “R0010001.jpg”), assigned in ascending order from 0010001 to 9999999. When a new memory card is inserted, file numbering continues from the last number used.
- **Off:** File names consist of “RIMG” followed by a four-digit number (e.g., “RIMG0001.jpg”), assigned in ascending order from 0001 to 9999. When a new memory card is inserted, file numbering is reset to 0001.



Notes

- This option applies only to memory cards. The names of Photographs in internal memory consist of “RIMG” and a four-digit number.
- Photographs copied to a computer using DL-10 (page 151) are given new names consisting of “RIMG” and a four-digit number.
- Photographs taken with **AdobeRGB** selected for **Color Space Setting** (page 146) are indicated by file names beginning with an underscore (e.g., “_R010001.jpg” or “_RIMG001.jpg”).



Caution

When **On** is selected, no further photographs can be stored if the memory card contains a folder numbered 999 and a file name ending in 9999; when **Off** is selected, no further photographs can be stored if the memory card contains a file numbered 9999. To take additional Photographs, format the card after copying its contents to a computer.

Date Settings

Set the camera clock (page 20).



Note

If you leave the battery in the camera body for at least two hours, the battery can be removed for about a week without resetting the clock.

Language/言語

Choose the language in which camera messages and menus are displayed.

Option	Description	Option	Description
日本語	Japanese	Русский	Russian
English	English	简体中文	Simplified Chinese
Deutsch	German	繁体中文	Traditional Chinese
Français	French	한국어	Korean
Italiano	Italian	ไทย	Thai
Español	Spanish		

Video Out Mode

When connecting the camera body to a TV or VCR (page 118), choose a video out mode that matches the standard used in the device. The camera body supports NTSC and PAL; SECAM is not supported.

HDMI Output

Choose the resolution of image output using an HDMI mini cable. Choose the setting from **AUTO** or **Manual**.



Note

Normally, select **AUTO**. If the resolution of image displayed on TV is low with the **Auto** setting, select **Manual**. The image may be improved.

Start Settings Readout

When the camera turns off, the settings are saved both in camera body and camera unit.

Choose the destination to read out the settings from **Body** or **Camera Unit**.

Copying Pictures to a Computer

This section describes how to copy pictures from the camera body to your computer. Instructions for Windows may be found below; those for the Macintosh begin on page 162.



Note

The dialogs shown in this section may differ from those displayed by your computer.

Windows

You can copy pictures to your computer by either of the following methods:

- Install the supplied DL-10 software (page 153) and use it to copy pictures as described on page 159.
- Copy pictures without using DL-10 or other image copy software. (page 160).



Note

Detailed instructions may be found in the *Software User Guide* on the supplied CD (page ix).

System Requirements

Before using the supplied CD, check that your computer meets the following requirements. See the documentation provided with your computer for details.

OS	Windows 2000 Professional SP 4, Windows XP Home Edition/Professional SP 3, Windows Vista SP 2
CPU	Windows 2000/Windows XP: Pentium® III 500 MHz or faster Windows Vista: Pentium® III 1 GHz or faster
RAM	Windows 2000/Windows XP: 256 MB or more Windows Vista: 512 MB or more
Free disk space	A minimum of 160 MB required for installation
Video	1024 × 768 pixels or more with 16-bit color or better
Miscellaneous	<ul style="list-style-type: none">• Compatible CD-ROM drive• Compatible USB port

Cautions

- 64-bit operating systems are not supported. Operating systems that have been upgraded from an earlier version are not supported, as USB may fail to function as expected. The supplied software may not function as expected with systems that have been patched or updated with Service Pack releases.
- Connect the camera body directly to a built-in USB port. USB ports added via PCI-bus or other extension boards or cards are not supported. The camera body may not function as expected when connected via a USB hub or keyboard.
- More RAM may be required when handling movies and other large files.

Supplied CD

Inserting the supplied CD in a CD-ROM drive displays the dialog shown at right.

- **Installing the software:** Install the following software.



DL-10: Copy pictures to the computer in a single operation.

Irodio Photo & Video Studio: View, manage, edit pictures on the computer. For more information, see the **Help** menu in Irodio Photo & Video Studio or visit the following website: http://www.pixela.co.jp/oem/irodio/e/irodio_digitalphoto_videostudio/

USB driver: Connect earlier Ricoh cameras to computers running Windows 98, Windows 98 SE, Windows Me, or Windows 2000. Not required for this product.

WIA driver: Connect earlier Ricoh cameras to computers running Windows XP or Windows Vista. Not required for this product.

- **Browse User's Manual (Software Version):** View the *Software User Guide* in pdf format (page ix). Acrobat Reader or Adobe Reader is required; if necessary, install Adobe Reader as described on page 156.
- **Browse CD-ROM Content:** View the contents of the CD, which include Adobe Reader (page 156). To install Irodio Photo & Video Studio without installing other software, open the "Irodio Photo & Video Studio" folder and double-click **Irodio Photo & Video Studio.exe**.

Installing the Software

Follow the steps on the next page to install the supplied software. Illustrations are from Windows XP.

Cautions

- If the camera body is connected to the computer, disconnect the camera body before beginning installation.
- Users of existing “Caplio” software should note that the “DC” software supplied with the camera body replaces the following items in the Caplio software package:

Caplio software	DC software
RICOH Gate La	DL-10
Caplio Viewer	DU-10*
Caplio Server	SR-10*
Caplio Setting	ST-10*

* Not used by this product.

If the above Caplio software is currently installed, you will be prompted to uninstall it before installing the supplied DC software. Follow the on-screen instructions. Installing the DC software replaces Caplio Viewer, Caplio Server, and Caplio Setting with the software listed above, which can be used in the same way as the Caplio versions (note that those software will not be installed if you uninstalled the Caplio software as described on page 158 before installing the DC software). Note that uninstalling the software for earlier Ricoh cameras may reset user preferences for DL-10 or RICOH Gate La.

- Administrator privileges are required for installation.
- DL-10 is for use in a stand-alone environment and cannot be run over a network.

1 Insert the supplied CD.

Turn the computer on and insert the supplied CD in a CD-ROM drive.

- **Windows Vista:** An Autorun dialog will be displayed. Click **Run Autorun.exe** to display the installer dialog.
- **Other versions of Windows:** The installer dialog will be displayed automatically.



2 Click **Installing the software**.

- **Windows Vista:** A “User Account Control” dialog will be displayed. Click **Allow** to display a language-selection dialog.
- **Other versions of Windows:** A language-selection dialog will be displayed.

3 Select a language and click **OK**.

The dialog shown at right will be displayed. Click **Next**.

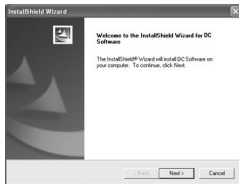

4 Select a destination.

The supplied software will be installed to the folder shown under **Destination Folder**. Click **Next**.

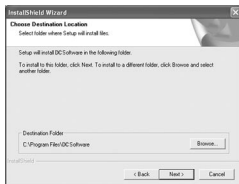

5 Confirm the destination location and then click [Next].

The Irodio Photo & Video Studio installer will start (depending on your computer, the splash screen at right may be displayed for some time before installation begins). Follow the on-screen instructions to install the supplied software.

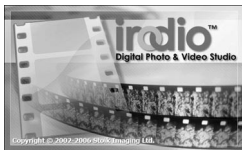
**6 Click Finish.**

The dialog shown at right will be displayed when installation is complete. Click **Finish**.

**7 Restart the computer.**

A message will be displayed prompting you to restart your computer. Select **Yes, I want to restart my computer now** and click **Finish** to restart the computer.

8 Unblock DL-10.

A Windows security dialog will be displayed when the computer restarts. Click **Unblock** for DL-10.

**Note**

See page 158 for information on uninstalling the software.

Installing Adobe Reader

Adobe Reader is required to view the *Software User Guide*. If Adobe Reader is not already installed, it can be installed from the supplied CD as described below.

**Cautions**

- Disconnect the camera body before beginning installation.
- Administrator privileges are required for installation.

1 Insert the supplied CD.

Turn the computer on and insert the supplied CD in a CD-ROM drive.

- **Windows Vista:** An Autorun dialog will be displayed. Click **Run Autorun.exe** to display the installer dialog.
- **Other versions of Windows:** The installer dialog will be displayed automatically.



2 Click **Browse CD-ROM Content**.

The contents of the CD will be displayed.

3 Install Adobe Reader.

Double-click the “Adobe Reader” folder and then double-click the folder for the language of your choice. Double-click the file beginning with “AdbeRdr910” and follow the on-screen instructions. If a “User Account Control” dialog is displayed, click **Continue**.



Notes

- See the Adobe Reader **Help** menu for information on Adobe Reader.
- Installation of Adobe Reader 9.1 requires MSI (Microsoft Windows Installer) version 3.1 or later and either Microsoft Internet Explorer 6.0 or later or Firefox 2.0 or later. Microsoft Internet Explorer and Microsoft Windows Installer are available via Microsoft Update.

Uninstalling the Software

Follow the steps below to uninstall DC software or Irodio Photo & Video Studio.



Cautions

- Administrator privileges are required for uninstallation.
- Exit any applications that may be running before proceeding.

1 Open the “Add/Remove Programs” Control Panel.
Open the Windows “Start” menu and select **Control Panel** (Windows XP or Windows Vista) or **Settings > Control Panel**. Double-click **Add/Remove Programs**.

2 Uninstall the software.
Select the software you wish to uninstall (**DC Software** or **Irodio Photo & Video Studio**) and click **Change/Remove**. A confirmation dialog will be displayed; click **OK**. If a message appears warning that a shared file has been detected, select **Don’t display this message again** and click **Yes**.

Close any open windows when the uninstall process is complete. After uninstalling Irodio Photo & Video Studio, restart the computer.

Copying Pictures Using DL-10

After installing DC software, follow the steps below to copy pictures to your computer.

- 1 Turn the camera body off.**
- 2 Connect the supplied USB cable.**
Connect the cable to the computer USB port.



Cautions

- Do not use force when connecting the cable or when handling the camera body with the cable connected.
- Do not move the camera body with the cable connected.

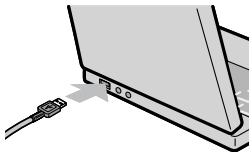

Connect the cable to the camera body as shown. The camera body will turn on, DL-10 will start, and transfer will begin automatically. Pictures are copied to folders in the

“Digital Camera” folder in “My Documents” (if you were previously using Caplio software, pictures will instead be copied to folders in the “Caplio” folder). Pictures are sorted into separate folders by date of recording; make sure the camera clock is set to the correct date and time before shooting.

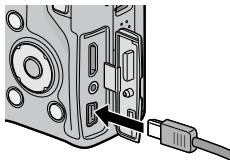

- 3 Disconnect the cable when transfer is complete.**
See page 161 for more information.



Note

If transfer does not begin automatically, try the following procedures. Click **Save** in the DL-10 window.

Check that **Saves automatically when connected to USB** is selected in the DL-10 "Option Settings" dialog.

Restart the computer and repeat the above steps.

Copying Pictures Without Using DL-10

If DL-10 is not installed, you can copy pictures to the computer as described below. The illustrations in this section are from Windows XP.

1 Turn the camera body off.

2 Connect the supplied USB cable.

Connect the cable to the computer USB port and then to the camera body. The camera body will turn on automatically.

3 Copy files from the camera body to the computer.

The camera body will be listed as a removable drive in "My Computer" with pictures stored in folders as shown at right. If a memory card is inserted in the camera body, the drive will be

named as shown at right and the contents of the memory card will be displayed. If no memory card is inserted, the drive will be named "RICOHDCI" and the contents of internal memory will be displayed. Copy pictures to the desired location on your computer.

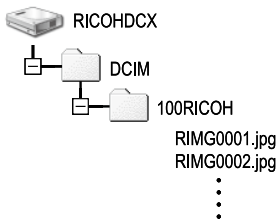

Cautions

- Do not turn the power off or disconnect the USB cable until copying is complete.
- Files in the destination folder with the same name as the pictures being copied will be overwritten. If necessary, rename files before copying begins.
- Do not use a computer to view or edit pictures on a memory card. Pictures that have been viewed or modified on a computer can no longer be displayed on the camera body. Copy pictures to the computer for viewing and editing.

Disconnecting the Camera Body

Before disconnecting the camera body from the computer, click the “Safely Remove Hardware” or “Unplug or Eject Hardware” icon in the taskbar (the illustration above shows the icon for Windows XP) and select **Safely Remove USB Mass Storage Device** or **Stop USB Mass Storage Device** from the menu that appears. You can then disconnect the USB cable.



Notes

- A warning may be displayed if the USB cable is disconnected without first removing the camera body from the system as described above. Be sure to remove the camera body from the system before disconnecting the cable.
- Confirm that transfer is complete before removing the camera body from the system and disconnecting the cable.

Macintosh

The camera body can be used with Mac OS X versions 10.4–10.5.7.

Caution

The VM-1 software (page 164) and Software Users Guide (only on computers with Acrobat installed) can be used with Macintosh computers.

Copying Pictures to a Macintosh

- 1 Turn the camera body off.**
- 2 Connect the supplied USB cable.**
Connect the cable to the computer USB port.

Cautions

- Do not use force when connecting the cable or when handling the camera body with the cable connected.
- Do not move the camera body with the cable connected.

Connect the cable to the camera body as shown. The camera body will turn on automatically.

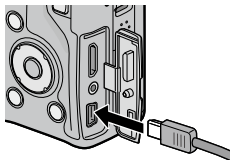
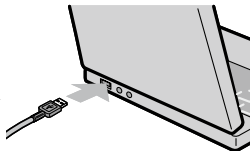

3 Copy files from the camera body to the computer.

The camera body will appear as a volume on the desktop with pictures stored in folders as shown at right. If a memory card is inserted in the camera body, the drive will be named as shown at right and the contents of the memory card will be displayed. If no memory card is inserted, the drive will be named "RICOHDCI" and the contents of internal memory will be displayed. Copy pictures to the desired location on your computer.

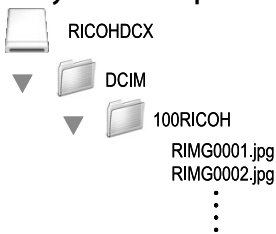

Disconnecting the Camera Body

Before disconnecting the camera body from the computer, drag the camera body volume into the Trash or select the camera body volume and choose **Eject** from the **File** menu. You can then disconnect the USB cable.

Notes

- A warning may be displayed if the USB cable is disconnected without first removing the camera body from the system as described above. Be sure to remove the camera body from the system before disconnecting the cable.
- Confirm that transfer is complete before removing the camera body from the system and disconnecting the cable.
- Connecting the camera body to a Macintosh computer may result in the creation of "FINDER.DAT" or ".DS_Store" files that will be listed by the camera body as unmatched files. These files can be deleted without risk.

Using the MP File Viewer

When you shoot images with M-Cont Plus, the images are recorded as one MP file. By using the VM-1 MP file viewer, you can play back MP files on your Macintosh computer and export still images.

This section explains how to install and uninstall the VM-1 software that is included on the supplied CD-ROM. For details on how to play back MP files on your computer or export still images from MP files using the MP file viewer, see the "Software User Guide" available from the supplied CD-ROM.

System Requirements for Using the Supplied MP file viewer

The following environments are necessary for using the supplied MP file viewer.

Please check your computer, or the computer's user manual.

Operating Systems Supported	Mac OS X 10.4 to 10.5.7
Macintosh computer	Apple Inc. Macintosh Series
Internal Memory	Mac OS X 10.4 256 MB or more Mac OS X 10.5 512 MB or more
Hard Disk Available Memory	5 MB or more
CD-ROM Drive	A CD-ROM drive compatible with the above-mentioned Macintosh computer



Note

VM-1 supports Japanese, English, French and Chinese (Simplified).

Installing VM-1

1 Insert the supplied CD.

Turn on the Macintosh computer and insert the supplied CD in a CD-ROM drive.

2 Select the disk for installation.

Double-click the **RICOH** icon > **VM-1** folder > **VM-1 Installer.pkg** icon. The **Install VM-1** window will be displayed; click **Continue**. When the window for selecting the installation location appears, select the disk for installation, and then click **Continue**.

3 Install VM-1.

Click **Install** and enter your name and password, and then click **OK**. A message that the installation is complete will be displayed; click **Close**.

To change the installation location, click **Change Install Location....**

To upgrade VM-1, click **Upgrade**.

Uninstalling VM-1



Cautions

- If you have any other software applications running or data that has not been saved, quit the other software applications and save the data before uninstalling VM-1.
- If an error occurs during the uninstallation process, update your Mac OS to the latest version.

1 Open the VM-1 utility folder.

Open the **Applications** folder > Utilities folder > VM-1 Utility folder.

2 Double-click the VM-1 Uninstaller icon.

The uninstall confirmation dialog will be displayed. Click **OK**.

3 Enter your name and password, and then click **OK**.

A message that the uninstallation is complete will be displayed; click **OK**.

Troubleshooting

Error Messages



If an error message is displayed, take the steps listed below.





Message	Solution	Page
Insert card	No memory card is inserted. Insert card.	15
Set date.	Camera clock is not set. Set camera clock.	20, 149
File Number Over Limit	Camera is out of file numbers. Insert another card.	15, 148
Unmatched File	Camera cannot display file. Use computer to check file contents and delete file.	—
Insufficient memory. Continue?	Space on memory card is insufficient to copy all files. Insert another card.	15
Protected	File is protected and cannot be deleted.	112
Card Is Write-Protected.	Card is write protected (locked). Unlock card.	16
Print settings cannot be set for this file.	File is a movie or other file that cannot be selected for printing.	—
Insufficient Memory/ Capacity short	Insufficient memory to store additional files. Delete existing files or increase amount of memory available.	39, 139
	Maximum number of images selected for printing. Set number of prints for other images to zero.	125
Format internal memory.	Internal memory is not correctly formatted. Format internal memory.	139
Format card.	Card is not correctly formatted. Format card in camera body.	139
Card Error	Format card. If message persists, card is faulty; discontinue use.	139
Writing Data	Camera is saving data. Wait until save is complete.	—
No File	No files available for playback.	—
Cannot Record	Memory is full. Use another card or remove card and use internal memory.	15

Power Supply

Problem	Cause	Solution	Page
The camera does not turn on.	Battery is exhausted or not inserted.	Check that battery is correctly inserted. Charge battery (rechargeable battery only).	12, 14
	Battery is incompatible.	Use supplied battery.	13
	Battery is not in correct orientation.	Insert battery in correct orientation.	14
The camera turns off during use.	Camera has turned off automatically to save power.	Turn camera on.	18
	Battery is exhausted.	Charge battery (rechargeable battery only).	12
	Battery is incompatible.	Use supplied battery.	13
The camera does not turn off.	Camera malfunction.	Remove and reinsert battery.	14
Low battery indicator displayed or camera turns off when battery has charge remaining.	Battery is incompatible.	Use supplied battery.	13
Battery cannot be charged.	Battery has reached end of charging life.	Replace with a new battery.	14
Battery is quickly exhausted.	Ambient temperature is very high or very low.	—	—
	Poor lighting requires extensive use of flash.	—	—

Shooting

Problem	Cause	Solution	Page
No picture taken when shutter-release button is pressed.	Battery is exhausted.	Charge battery (rechargeable battery only).	12
	Power is off or not in shooting mode.	Slide the power switch to ON to turn camera on or press  to select shooting mode.	18, 34
	Camera is in playback mode.	Press  to select shooting mode.	34
	Shutter-release button was not fully pressed.	Press shutter-release button all the way down.	22
	Memory card is not formatted.	Format card.	139
	Memory card is full.	Insert new card or delete files.	15, 39
	Memory card has reached end of working life.	Insert new card.	15
	Flash is charging.	Wait until flash lamp stops blinking.	29
	Memory card is locked.	Unlock card.	16
	Memory card contacts are dirty.	Clean with soft, dry cloth.	—
Cannot view Photographs after shooting.	Display time is too short.	Choose longer display time.	142
Picture display is blank.	Power is off or picture display is dark.	Turn camera on or adjust picture display brightness.	18, 139
	Picture display is off.	Press the VF/LCD button to turn picture display on.	42
	Display has been switched to the LCD viewfinder.	Press the VF/LCD button to switch to the picture display.	42
	A/V cable is connected.	Disconnect cable.	118
Camera unable to focus in autofocus mode.	Lens is dirty.	Clean with soft, dry cloth.	—
	Subject is not at center of frame.	Use focus lock.	25
	Subject not suitable for autofocus.	Use focus lock or manual focus.	25, 65
	Subject is too close.	Use macro mode or move away from subject.	27

Problem	Cause	Solution	Page
Pictures are blurred. 	Camera moved during shooting.	Use a tripod. Use the camera shake correction function. Press elbows against your body.	21, 92
	Lighting is poor and shutter speeds are slow.	Use the flash. Choose higher ISO setting. Use the camera shake correction function.	29, 90, 92
Flash does not fire or will not charge.	Flash is not raised.	Press OPEN/  button (flash open/setting) to open the flash.	29
	Flash cover is not fully open.	Do not obstruct flash cover.	—
	The flash cannot be used in the following cases: • When exposure bracket, white balance bracket, or color bracket is set • In continuous mode • In movie mode	Change camera settings.	54, 73, 75
	Flash is off.	Open the flash. Press OPEN/  button (flash open/setting) to cancel flash off.	29
	Battery is exhausted.	Charge battery (rechargeable battery only).	12
	Flash does not illuminate subject.	The distance to the subject exceeds the flash range.	Move closer to subject.
Subject is dark.		Increase flash output.	78
Flash output is too low.		Increase flash output.	78
Flash cover is not fully open.		Do not obstruct flash cover.	—
Photographs are too bright.	Flash output is too high.	Reduce flash output, move away from subject, or use different light source.	78
	Photograph is overexposed.	Use exposure compensation or choose faster shutter speed.	50, 85
	Picture display is too bright.	Adjust picture display brightness.	139
Photographs are too dark.	Flash is off and subject is poorly lit.	Press OPEN/  button (flash open/setting) to open the flash.	29
	Photograph is underexposed.	Use exposure compensation or choose slower shutter speed.	50, 85
	Picture display is too dark.	Adjust picture display brightness.	139

Problem	Cause	Solution	Page
Colors are unnatural.	Camera unable to adjust white balance for shooting conditions using auto white balance.	Include white object in Photograph or choose another white balance option.	86
Photograph information not displayed.	Indicators are hidden.	Press DISP. to display indicators.	42
Picture display brightness changes during focusing.	Ambient lighting is poor or differs from that used for autofocus.	This is normal and does not indicate a malfunction.	—
Vertical streaks ("smear") appear in photographs.	Subject is bright.	This is normal and does not indicate a malfunction.	—
Tilt indicator is not displayed.	Off or Sound selected for Level Setting.	Choose Display or Disp + Snd.	32
	Indicators are hidden.	Press DISP. to display indicators.	42
	The camera is upside down.	Hold the camera in the correct orientation.	21
Photograph is not level, although tilt indicator showed that camera was level.	Camera was moving when Photograph was taken.	Do not take pictures from moving objects.	—
	Subject is not level.	Check the subject.	—

Playback/Deletion

Problem	Cause	Solution	Page
Cannot play pictures back.	Camera is not in playback mode.	Press [▶] .	19, 34
	A/V cable incorrectly connected.	Reconnect A/V cable.	118
	Video mode does not match TV.	Choose another video mode.	149
	The playback screen displays in the LCD viewfinder.	Set Playback Screen to LCD .	141

Problem	Cause	Solution	Page
Cannot view pictures on memory card.	Memory card empty or not inserted.	Insert card that has been formatted in camera body and contains pictures recorded with camera body.	15, 139
	Card was not formatted in camera body.		
	Pictures were created with other device.		
	Memory card contacts are dirty.	Clean with soft, dry cloth.	—
	Card malfunction.	Insert another card. If you can view pictures on second card, first card has probably malfunctioned; discontinue use.	—
Picture display has turned off.	Battery is exhausted.	Charge battery (rechargeable battery only).	12
	Camera has turned off automatically to save power.	Turn camera on.	18
Cannot delete file.	File is protected.	Remove protection.	112
	Memory card is locked.	Unlock memory card.	16
Cannot format card.	Card is locked.		

Miscellaneous

Problem	Cause	Solution	Page
Cannot insert memory card.	Card is not in correct orientation.	Insert in correct orientation.	15
Camera controls have no effect.	Battery is exhausted.	Charge battery (rechargeable battery only).	12
	Camera malfunction.	Turn camera off and then on again.	18
		Remove and reinsert battery.	14
Date is incorrect.	Clock is not set correctly.	Set clock to correct date and time.	20, 149
Date has been reset.	Battery has not been inserted for about a week.	Set clock to correct date and time.	20, 149
Camera does not turn off automatically.	Off is selected for Auto Power Off .	Choose another setting.	141
Camera does not beep.	Beep is muted.	Choose another option for Volume Settings .	32, 142

Problem	Cause	Solution	Page
Pictures are not displayed on TV.	Video mode does not match TV.	Choose another video mode.	149
	A/V cable not connected.	Connect A/V cable.	118
	TV is not tuned to VIDEO IN channel.	Tune TV to VIDEO IN channel.	—

Computer-Related Problems

For more information, refer to the *Software User Guide*, available in pdf format on the supplied CD.

Security Alerts (Windows Vista/Windows XP)

Consult the following if Windows XP Service Pack 3 or Windows Vista Service Pack 2 displays a security alert when the camera body is connected or DL-10 starts. The illustrations in this section are from Windows XP.

If a security alert is displayed, confirm that the program is from a reliable source and click **Unblock**.



Caution

If you cannot identify the program and source, click **Keep Blocking** to prevent your computer from being affected by virus or malware.

If you clicked **Keep Blocking** to block a Ricoh application, you can remove the block in Windows Firewall.

1 Open the “Windows Firewall” Control Panel.

Open the “Start” menu and select **Control Panel**, then double-click **Windows Firewall** (if Windows Firewall is not listed, click **Switch to Classic View** at the top left corner of the Control Panel window).



2 Allow the Ricoh application Internet access.

In the “Windows Firewall” dialog, click the **Exceptions** tab and check whether DL-10 is listed under “Programs and Services.” If it is, place a check in the check box next to DL-10 and click **OK**. If it is not listed, click **Add Program...** to add DL-10 to the list of exceptions.

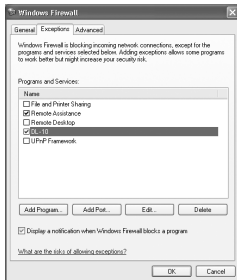

If you clicked **Ask Me Later** to block DL-10, a security alert will be displayed the next time the program starts. Click **Unblock** to remove the block.

Specifications

Flash	Mode	Auto (flash fires when lighting is poor or subject is backlit), red-eye, on, slow sync, manual, off
	Range (built-in flash)	See the documentation provided with the camera unit.
	Flash compensation	± 2.0 EV in increments of 1/2EV or 1/3EV
	Manual flash amount	FULL, 1/1.4, 1/2, 1/2.8, 1/4, 1/5.6, 1/8, 1/11, 1/16, 1/22, 1/32, 1/64
Picture display		3.0" transparent LCD; approx. 920,000 pixels
Shooting mode		Auto, program shift, aperture priority, shutter priority, manual, scene, "My Settings"
Picture quality		Fine, Normal, RAW (DNG) * ¹
Storage		SD/SDHC memory card, internal memory (approx. 86 MB)
File size * ² (approx.)	5M	FINE: approx. 2287KB/frame
	3M	FINE: approx. 1474KB/frame
	1M	FINE: approx. 812KB/frame
	VGA	FINE: approx. 197KB/frame
File format	Photographs	JPEG (Exif Ver. 2.21) * ³ , RAW (DNG)
	Movies	AVI * ⁴ (OpenDML Motion JPEG compliant)
	Compression	JPEG baseline compliant (photographs and movies)
Other shooting options		Continuous shooting (continuous, M-Cont Plus); self-timer (shutter release delay of approx. 10 s or 2 s, or custom setting); interval timer (intervals of 5 s to 1 hour in increments of 5 s) * ⁵ ; color bracketing; B&W (TE); color space selection; noise reduction; histogram display; framing grid; depth-of-field indicator; tilt indicator; hot shoe
Other playback options		Auto image rotation; multi-frame playback; playback zoom (up to 16 \times); resize
Interface		USB 2.0 (High-Speed) Mini-B connector; Mass Storage * ⁶ ; audio output 1.0Vp-p (75 Ω), HDMI mini cable connector (Type C)
Video signal format		NTSC, PAL
Power source		DB-90 rechargeable battery (3.6V)
Battery life (based on CIPA standard) * ⁷		See the documentation provided with the camera unit.

Dimensions (W × H × D)	113.9 mm × 70.2 mm × 28.9 mm (excluding projections)
Weight (approx.)	<ul style="list-style-type: none"> • Camera body (excluding battery, memory card, neck strap, and connector cap): 160 g • Battery, neck strap, and connector cap: 66 g
Tripod screw hole	1/4-20UNC
Date storage time	Approx. 1 week
Operating temperature	0 °C to 40 °C
Operating humidity	85% or less
Storage temperature	-20 °C to 60 °C

*¹ A JPEG file is also recorded (the JPEG file may be a fine- or normal-quality file with the dimensions as the RAW file or a VGA file). RAW files use the standard DNG format promoted by Adobe Systems, Inc.

*² For details on RAW, L, M sizes, see the documentation provided with the camera unit.

*³ Compatible with the **D**esign rule for **C**amera **F**ile system (DCF, a JEITA standard) and DPOF. Full compatibility with other devices is not guaranteed.

*⁴ Audio: PCM 32 kHz, 16 bit monaural

*⁵ Flash off.

*⁶ Mass Storage is supported under Windows 2000, Windows XP, Windows Vista, and Mac OS X 10.4–10.5.7.

*⁷ Measured according to CIPA standard. For reference only; actual number of shots varies greatly according to how camera is used.

Internal Memory/Memory Card Capacity

The approximate number of frames or length of movies that can be stored in internal memory or on a memory card at different settings varies depending on the type of camera unit. See the documentation provided with the camera unit.



Notes

- Each movie can be up to 90 minutes long (4GB in size).
- The maximum number of shots that can be taken in a single burst is 999. If memory remains for more than 999 exposures, "999" is shown in the display.
- Depending on the subject, the number of pictures that can be taken may differ from the number of exposures remaining.
- Capacity varies with shooting conditions and the make of memory card.
- Use a high-speed memory card when shooting for extended periods.

Optional Accessories

The GXR camera body can be used with the following optional accessories:



Camera unit

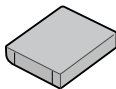

DB-90 rechargeable battery

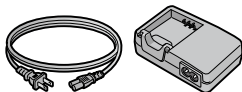

BJ-9 battery charger

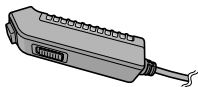

CA-1 cable switch

A wired remote shutter release that attaches to the USB connector of the camera body.

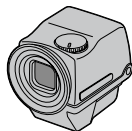

VF-2 LCD viewfinder

An electrical viewfinder that attaches to the hot shoe of the camera body. This offers viewfinder coverage of 100% and can be adjusted up to 90° without any parallax, and enables easy low-angle shooting.



GF-1 external flash

An external flash that is developed for digital camera with TTL auto-flash system.

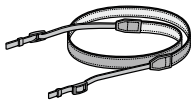

ST-3 neck strap

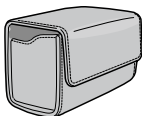

SC-55S soft case

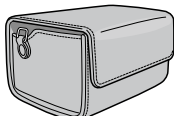

SC-55L soft case



Notes

- Before using optional accessories, read the manual provided with the product.
- For the latest information on optional accessories, visit the Ricoh website (<http://www.ricohpmmc.com/>).

Camera System and Accessories

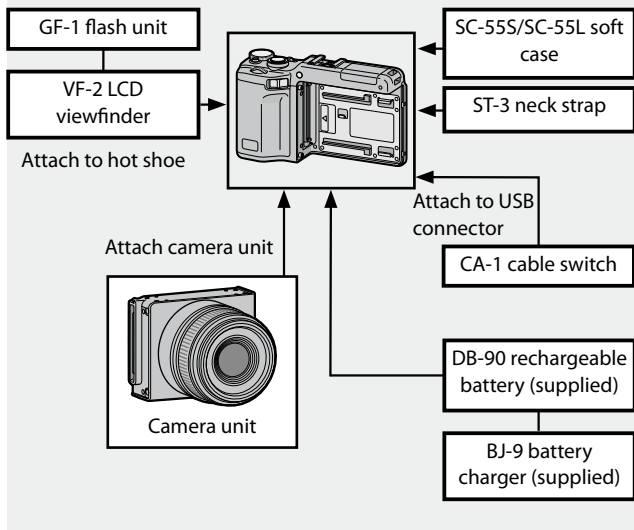

The GF-1 Flash Unit (Optional)

An optional GF-1 flash unit can be connected to the hot shoe.

1 Close the flash cover (page 2).

2 Attach the flash.

Turn the camera and the GF-1 off and attach the GF-1 to the hot shoe.

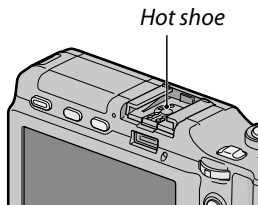

3 Turn the flash and camera on.

4 Press the DIRECT button.

5 Select the optional flash mode item.

Move the cursor using +, -, Fn1, Fn2 or the ADJ. lever (left and right) to highlight the item.

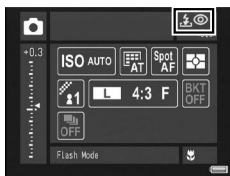

6 Select a flash mode.

Rotate the up-down dial to select a flash mode.



Note

- The optional flash mode item is not displayed when the GF-1 is turned off.
- Turn the GF-1 off to shoot without the flash.
- If the optional flash mode item is not displayed, turn the GF-1 and camera off and then remove and reattach flash.

Other Flash Units

Use only flash units with one signal terminal, which must be an X-contact with a positive voltage of no more than 20V. Use a flash that covers the angle of view of the lens.

1 Close the flash cover (page 2).

2 Attach the flash.

Turn the camera and the optional flash unit off and attach the flash to the hot shoe.

3 Set aperture manually.

Turn the camera on, select mode **A** or **M**, and choose an aperture (pages 18, 48, 50).

4 Choose a manual ISO sensitivity setting.

Select an option other than **Auto** for ISO sensitivity (page 90).

5 Turn the flash on.

Turn the flash on and set it to auto mode. Set aperture and ISO sensitivity to the values selected with the camera. Take a test shot and adjust flash aperture and ISO settings as necessary.

Turn the optional flash unit off before removing it from the camera.

Cautions

- If the external flash is on, it will fire with every shot regardless to the flash mode selected with the camera. Turn the flash unit off to shoot without the flash.
- Optional flash units are in principle for use at ranges that exceed the range of the built-in flash. Using an optional flash unit at shorter ranges may result in overexposure.

Using the Product Abroad

Using BJ-9 Battery Charger

This product is for use with currents of 100–240V and 50 or 60 Hz. Before travelling, purchase a travel adapter for connection to the type of outlets used at your destination. Do not use these products with electrical transformers, as this could damage the product.

Warranty

This product was manufactured for use in the country of purchase, and the warranty is not valid in other countries. Should the product fail or malfunction while out of the country, the manufacturer assumes no responsibility for servicing the product locally or bearing any expenditure incurred thereby.

Television Playback

The supplied A/V cable can be used to connect this product to televisions and monitors equipped with a video input terminal. This product supports the NTSC and PAL video formats; before connecting the product to a video device, select the appropriate video output mode.

Precautions for Use

- The warranty is not valid in other countries. Should the product fail or malfunction while out of the country, the manufacturer assumes no responsibility for servicing the product locally or bearing any expenditure incurred thereby.

- Do not drop this product or subject it to physical shocks. When carrying the product, be careful that it does not strike other objects. Particular care is required to protect the picture display.
- The flash may overheat if fired many times in succession. Do not use the flash more than necessary. Do not use the flash in close contact with your body or other objects. Failure to observe these precautions could result in burns or fire.
- Using the flash unit in close proximity to your subject's eyes could cause temporary visual impairment. Particular care should be observed when photographing infants. Do not direct the flash at the operator of a motor vehicle.
- Battery may become hot with extended use. Wait for the battery to cool before removing it from this product.
- The picture display may be difficult to read in direct sunlight.
- You may notice that picture display varies in brightness or contains pixels that do not light or that are always lit. This is common to all LCD monitors and does not indicate a malfunction.
- Do not apply force to the picture display.
- Abrupt changes in temperature may cause condensation, resulting in visible condensation inside this product, or malfunction. This can be avoided by placing this product in a plastic bag to slow the temperature change, and removing it only after the air in the bag has reached the same temperature as its surroundings.
- To prevent damage to the product, do not insert objects into the holes in the microphone and speaker coverings.
- Keep the terminals of the connector free of dust.
- Keep this product dry and avoid handling it with wet hands. Failure to observe these precautions could result in product malfunction or electric shock.
- Take a test shot to ensure that this product is functioning properly before using it on important occasions such as travel or weddings. We recommend that you keep this manual and spare batteries at hand.



Tip: Avoiding Condensation

Condensation is particularly likely to occur if you move to an area with a sharply different temperature, if humidity is high, in a cold room after the heater has come on, or where this product is exposed to cold air from an air conditioner or other device.

Care and Storage

Caring for this product

- Clean the picture display by wiping it with a soft cloth dampened with a small amount of any monitor cleaner that does not contain organic solvents.
- Clean this product thoroughly after using it at the beach or handling cosmetics. Do not expose this product to volatile substances such as thinner, benzene, or pesticides. Failure to observe this precaution could result in damage to this product or its finish.
- In the unlikely event of malfunction, visit a Ricoh Repair Center.
- This product contains high-voltage circuits. Do not disassemble.
- The picture display is easily scratched; avoid touching it with hard objects.

Storage

- Do not store this product where it will be exposed to: extreme heat or humidity; large changes in temperature or humidity; dust, dirt, or sand; severe vibration; prolonged contact with chemicals, including mothballs and other insect repellent, or with vinyl or rubber products; strong magnetic fields (for example, in the vicinity of a monitor, transformer, or magnet).
- Remove the battery if the product will be left unused for a long period of time.

Before Cleaning

Turn the power off and remove the battery.

Warranty and Servicing

1. This product is backed by a limited warranty. During the warranty period mentioned in the Warranty supplied with this product, any defective parts will be repaired free of charge. In the event of a malfunction, contact the dealer from which you purchased this product or your nearest Ricoh Repair Center. Please note that you will not be reimbursed for the cost of bringing this product to the Ricoh Repair Center.
2. This warranty does not cover any damage resulting from:
 - 1 failure to follow the instructions in the instruction manual;
 - 2 repair, modification or overhaul not conducted by an authorized service center listed in the instruction manual;
 - 3 fire, natural disaster, act of God, lightning, abnormal voltage, etc.;
 - 4 improper storage (noted in the "Camera Body User Guide"), leaking of battery and other fluids, mold, or otherwise insufficient care of this product.
 - 5 submergence in water (flooding), exposure to alcohol or other beverages, infiltration of sand or mud, physical shock, dropping of this product, or pressure on this product, and other unnatural causes.
3. After the warranty period has passed, you will be liable for all repair fees, including those incurred at an authorized service center.
4. You will be liable for all repair fees, even within the warranty period, if the warranty card is not attached or if the distributor's name or the purchase date have been changed or are not indicated on the card.
5. Expenses for overhaul and thorough inspection by special request of the customer will be charged to the customer, whether or not they are incurred during the warranty period.
6. This warranty only applies to this product and not to the accessories, such as the case and strap, nor does it apply to the battery and other consumables provided.
7. Any consequential damages arising from failure of this product, such as expenses incurred in taking pictures or loss of expected profit, will not be reimbursed whether they occur during the warranty period or not.
8. The warranty is only valid in the country in which this product was purchased.
 - * The above provisions refer to repairs offered free of charge, and do not limit your legal rights.
 - * The intention of the above provisions is also described in the warranty card provided with this product.
9. Parts essential to the servicing of this product (that is, components required to maintain the functions and quality of the product) will be available for a period of five years after this product is discontinued.
10. Please note that if this product is seriously damaged by flooding, submergence, infiltration of sand or mud, violent shocks or dropping, it may not be repairable, and restoration to its original condition may be impossible.



Notes

- Before sending this product in for repair, check the battery and read the instruction manual again to ensure proper operation.
- Some repairs require a significant amount of time to complete.
- When sending this product to a service center, please include a note which describes the defective part and the problem as precisely as possible.
- Remove all accessories not related to the problem before sending this product to the service center.
- This warranty does not apply to data stored on memory cards or in internal memory.

NOTICES

USA FCC Part 15 Class B

The equipment has been tested and found to comply with the limits for a Class B digital device, pursuant to part 15 of the FCC Rules. These limits are designed to provide reasonable protection against harmful interference in a residential installation. This equipment generates, uses, and can radiate radio frequency energy and if not installed and used in accordance with the instructions, may cause harmful interference to radio communications. However, there is no guarantee that interference will not occur in a particular installation. If this equipment does cause harmful interference to radio or television reception, which can be determined by turning the equipment off and on, then user is encouraged to try to correct the interference by one or more of the following measures:

- Reorient or relocate the receiving antenna.
- Increase the separation between the equipment and receiver.
- Connect the equipment to an outlet on a circuit different from that to which the receiver is connected.
- Consult the dealer or an experienced radio/TV technician for help. (FCC 15.105B)

Changes or modifications not expressly approved by the party responsible for compliance could void the user's authority to operate the equipment. (FCC 15.21)

Properly shielded and grounded cables and connectors must be used for connection to a host computer in order to comply with FCC emission limits. (FCC 15.27)

COMPLIANCE INFORMATION STATEMENT

Product Name: CAMERA BODY

Model Number: GXR

This device complies with Part 15 of the FCC Rules.

Operation is subject to the following two conditions:

- (1) This device may cause harmful interference, and
- (2) This device must accept any interference received, including interference that may cause undesired operation.

RICOH AMERICAS CORPORATION

5 Dedrick Place, West Caldwell NJ, 07006 Tel.: 1-800-225-1899

Note to Users in Canada

Note: This Class B digital apparatus complies with Canadian ICES-003

Remarque Concernant les Utilisateurs au Canada

Avertissement: Cet appareil numérique de la classe B est conforme a la norme NMB-003 du Canada.

IMPORTANT SAFETY INSTRUCTIONS—SAVE THESE INSTRUCTIONS
DANGER—TO REDUCE THE RISK OF FIRE OR ELECTRIC SHOCK, CAREFULLY FOLLOW THESE INSTRUCTIONS.

Index

Symbols

- (auto) mode..... 4, 21
- (delete) button..... 3, 39
- (DISP.) button..... 3, 42
- (macro) button 3, 27
- OPEN/ (flash) button..... 3, 29
- (playback) button..... 3, 19, 94, 101
- (Self-Timer) 3, 31
- /Q button..... 3, 26, 36, 38
- / button..... 3, 26, 36, 38

A

- A (aperture priority) mode..... 4, 48
- A/V cable ii, 118
- ADJ. lever..... 3, 5, 134
- ADJ Shutter Confirmation 135
- Adobe Reader 156
- AF auxiliary light..... 2, 31, 140
- Alert..... 173
- Aperture..... 46, 48, 50
- Aperture Shift 92
- Autofocus..... 22, 64
- Autofocus/flash lamp
..... 3, 18, 22, 29, 141
- Auto Power Off..... 141
- Auto Rotate..... 143

B

- Backlighting 85
- Battery..... 12
- Battery/card cover..... 3, 14, 15
- Battery charger..... 12, 183
- Battery level..... 10
- Black & White 71, 75
- Blur..... 24
- Bracketing 75
- Brightness 44, 106, 139

C

- Cable switch 178

- Camera shake correction..... 92
- Caplio..... 154
- Card Sequence No. 148
- CD..... ix, 153, 155, 157
- CL-BKT Black & White (TE) 146
- Clock..... 20, 149
- Close-up..... 27
- Color..... 71, 75, 86, 89
- Color Space Setting 146
- Computer 151
- Connector cover 3
- Connector for A/V cable..... 3
- Continuous Mode 73
- Contrast..... 71, 106
- Copy to Card from Internal Memory
..... 115

D

- Date Imprint 84
- Defaults 59, 127, 128
- Deleting Photographs 39
- Depth of Field 64
- Digital zoom 26
- Digital Zoom Image..... 147
- DIRECT button 3, 5
- DL-10..... 153, 159
- DNG 63
- DPOF 115

E

- Edit My Settings 132
- Error Messages 167
- Exposure 50, 85
- Exposure Metering..... 70

F

- Flash, optional 181
- Flash amount 79
- Flash compensation 136
- Flash cover 2

Flash Exposure Compensation	78
Flash mode	28
Flash Synchro Settings	79
Fn1, Fn2 button.....	3, 136
Fn Button Display	145
Focus	64
Focus Lock.....	25
Focus target.....	66
Format [Card]	139
Format [Internal Memory].....	139
Full Press Snap	69

G

Grid	42, 144
------------	---------

H

HDMI	119, 149
Highlights.....	43
Histogram.....	44, 108
Hot shoe	2, 181, 182

I

Image Settings	71
Interval Shooting.....	83
Irodio Photo & Video Studio.....	153
ISO Auto-High Settings	140
ISO Setting	90

J

JPEG.....	63
-----------	----

K

Key custom options.....	127
-------------------------	-----

L

Language/言語	149
LCD Brightness	139
LCD Confirmation Time	142
Level Compensation.....	106
Level Setting.....	144

M

M (manual exposure) mode	4, 50
--------------------------------	-------

Macintosh.....	162
Macro Mode	27
Manual Focus.....	65
Memory, internal	15, 139
Memory card.....	15, 139
MENU/OK button.....	3, 58, 101, 126
Metering	66
Microphone	2
M Mode Dial Options	138
Mode dial.....	2, 4
Monochrome	71, 75
Movie mode	54
Movie size.....	63
Multi-frame playback.....	36
MY modes	4, 57
My Settings for Fn Settings.....	133
My Settings WB Comp.	133

N

Neck strap	ii, 179
Noise Reduction.....	80
Noise Reduction ISO.....	80
NTSC.....	149, 183

O

One Press M Mode	138
One Press Zoom Ratio	143
Operation Sounds	142
Optional accessories	178

P

P(program shift) mode	4, 46
PAL	149, 183
PictBridge.....	120
Picture display	3, 8, 42
Picture Quality/Size	61
Playback, movies	94
Playback, photographs.....	34
Playback, TV.....	118
Playback Menu	101
Playback Mode Dial Options	138
Playback Zoom.....	38
Power switch.....	2, 18

Pre-AF	70
Printing.....	122
Protect.....	112

R

RAW	62
Recall My Settings.....	131
Reg. My Settings	129
Restore Defaults.....	91
RICOH Gate La.....	154

S

S(shutter priority) mode	4, 49
SCENE mode	4, 52
SD, SDHC.....	15
Setup.....	128
Sharpness.....	71
Shooting Info. Display Frame	145
Shooting Menu	58
Show My Setting Name.....	145
Shutter-release button	2, 23
Shutter speed	46, 49
Skew correction	56, 110
Slide Show.....	111
Snap Focus Distance	68
Software.....	154
Speaker	3
Start Settings Readout	150
Store Menu Cursor Position.....	147
Switch Shooting Mode.....	92

T

Tilt Indicator	32
Tripod screw hole	3
TV	118

U

Up-down dial	2, 5
USB cable.....	120, 159, 160, 162

V

Video Out Mode.....	149
Viewing Photographs	34

VM-1	165, 166
Volume	94, 142

W

White Balance	86
White Balance Compensation	89

Z

Zoom.....	26
-----------	----

Telephone Support Numbers in Europe

UK	(from within the UK)	02073 656 580
	(from outside of the UK)	+44 2073 656 580
Deutschland	(innerhalb Deutschlands)	06331 268 438
	(außerhalb Deutschlands)	+49 6331 268 438
France	(à partir de la France)	0800 88 18 70
	(en dehors de la France)	+33 1 60 60 19 94
Italia	(dall'Italia)	02 696 33 451
	(dall'estero)	+39 02 696 33 451
España	(desde España)	91 406 9148
	(desde fuera de España)	+34 91 406 9148

<http://www.service.ricohpmmc.com/>

From environmental friendliness to environmental conservation and to environmental management

Ricoh is aggressively promoting environment-friendly activities and also environment conservation activities to solve the great subject of management as one of the citizens on our precious earth.

To reduce the environmental loads of digital cameras, Ricoh is also trying to solve the great subjects of "Saving energy by reducing power consumption" and "Reducing environment-affecting chemical substances contained in products".



If You Encounter a Problem with This Product

See "Troubleshooting" (page 167) in this manual. If the problem persists, contact a Ricoh office.

Ricoh offices	
RICOH COMPANY, LTD.	3-2-3, Shin-Yokohama Kouhoku-ku, Yokohama City, Kanagawa 222-8530, Japan http://www.ricoh.com/r_dc
RICOH AMERICAS CORPORATION	5 Dedrick Place, West Caldwell, New Jersey 07006, U.S.A. 1-800-22RICOH http://www.ricoh-usa.com/
RICOH INTERNATIONAL B.V. (EPMCC)	Oberrather Str. 6, 40472 Düsseldorf, GERMANY (innerhalb Deutschlands) 06331 268 438 (außerhalb Deutschlands) +49 6331 268 438 http://www.ricohpmcc.com/
RICOH UK LTD. (PMMC UK)	(from within the UK) 02073 656 580 (from outside of the UK) +44 2073 656 580
RICOH FRANCE S.A.S. (PMMC FRANCE)	(à partir de la France) 0800 88 18 70 (en dehors de la France) +33 1 60 60 19 94
RICOH ESPANA, S.A. (PMMC SPAIN)	(desde España) 91 406 9148 (desde fuera de España) +34 91 406 9148
RICOH ITALIA S.p.A. (PMMC ITALY)	(dall'Italia) 02 696 33 451 (dall'estero) +39 02 696 33 451
RICOH ASIA PACIFIC OPERATIONS LIMITED	21/F, One Kowloon, 1 Wang Yuen Street, Kowloon Bay, Hong Kong
Support for Irodio Photo & Video Studio	
North America (U. S. A.)	+1-800-458-4029 (toll free)
Europe	UK, Germany, France and Spain: +800-1532-4865 (toll free) Other countries: +44-1489-564-764
Asia	+63-2-438-0090
China	+86-21-5385-3786
Business hours: 9:00 AM to 5:00 PM	

Ricoh Company, Ltd.

Ricoh Building, 8-13-1, Ginza, Chuo-ku, Tokyo

104-8222, Japan

2009 December

