

CX5

Camera User Guide

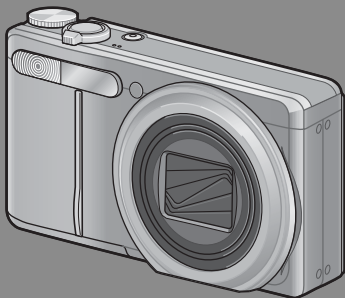

The serial number of this product is given on the bottom face of the camera.

Basic Operations

If you are using the camera for the first time, read this section.

This section provides a basic overview of how to turn on the camera, take pictures and play back pictures.

Advanced Operations

Read this section when you want to learn more about the different camera functions.

This section provides more detailed information about the functions used to take pictures and play back pictures, as well as information on how to customize the camera settings, print pictures, and use the camera with a computer.

The rechargeable battery needs to be charged before use. The battery is not charged at the time of purchase.

Preface

This manual provides information on how to use the shooting and playback functions of this product, as well as warnings on its use.

To make the best use of this product's functions, read this manual thoroughly before use. Please keep this manual handy for ease of reference.

Ricoh Co., Ltd.

Safety Precautions	Read all safety precautions thoroughly to ensure safe use.
Test Shooting	Please be sure to do some test shooting to make sure it is recording properly before normal use.
Copyright	Reproduction or alteration of copyrighted documents, magazines, music and other materials, other than for personal, home or similarly limited purposes, without the consent of the copyright holder is prohibited.
Exemption from Liability	Ricoh Co., Ltd. assumes no liability for failure to record or play back images caused by malfunction of this product.
Warranty	This product is manufactured to local specifications and the warranty is valid within the country of purchase. Should the product fail or malfunction while you are abroad, the manufacturer assumes no responsibility for servicing the product locally or bearing the expenditure incurred thereof.
Radio Interference	<p>Operating this product in the vicinity of other electronic equipment may adversely affect the performance of both devices. In particular, operating the camera close to a radio or television may lead to interference. If interference occurs, follow the procedures below.</p> <ul style="list-style-type: none">• Move the camera as far away as possible from the TV, radio or other device.• Reorient the TV or radio antenna.• Plug the devices into separate electrical outlets.

© 2011 RICOH CO., LTD. All rights reserved. This publication may not be reproduced in whole or in part without Ricoh's express written permission. Ricoh reserves the right to change the contents of this document at any time without prior notice.

Every effort has been made to ensure the accuracy of the information in this document. Should you nevertheless notice any errors or omissions, we would be grateful if you would notify us at the address listed on the back cover of this booklet.

Microsoft, Windows, Windows Vista®, Windows 7™, and Internet Explorer are registered trademarks of Microsoft Corporation in the United States of America and other countries. Macintosh and Mac OS are registered trademarks of Apple Inc. in the United States of America and other countries. Adobe, the Adobe logo, and Adobe Reader are trademarks of Adobe Systems Incorporated in the United States and other countries. MediaBrowser™ is a trademark of Pixela Corporation.

HDMI, the HDMI logo and High-Definition Multimedia Interface are trademarks or registered trademarks of HDMI Licensing LLC.

Eye-Fi, the Eye-Fi logo and Eye-Fi connected are trademarks of Eye-Fi, Inc.

PhotoSolid® is registered trademark of Morpho, Inc.

All other trade names mentioned in this document are the property of their respective owners.

Safety Precautions

Warning Symbols

Various symbols are used throughout this instruction manual and on the product to prevent physical harm to you or other people and damage to property. The symbols and their meanings are explained below.



Danger

This symbol indicates matters that may lead to imminent risk of death or serious injury if ignored or incorrectly handled.



Warning

This symbol indicates matters that may lead to death or serious injury if ignored or incorrectly handled.



Caution

This symbol indicates matters that may lead to injury or physical damage if ignored or incorrectly handled.

Sample Warnings



The  symbol alerts you to actions that must be performed.



The  symbol alerts you to prohibited actions.

The  symbol may be combined with other symbols to indicate that a specific action is prohibited.

● Examples

 Do not touch  Do not disassemble

Observe the following precautions to ensure safe use of this equipment.

Danger



● Do not attempt to disassemble, repair or alter the equipment yourself. The high-voltage circuitry in the equipment poses significant electrical hazard.



● Do not attempt to disassemble, alter or directly solder the battery.



● Do not put the battery in a fire, attempt to heat it, use it in a high temperature environment such as next to a fire or inside a car, or abandon it. Do not put it into water or the sea or allow it to get wet.



● Do not attempt to pierce, hit, compress, drop, or subject the battery to any other severe impact or force.



● Do not use a battery that is significantly damaged or deformed.

Warning



- Turn off the power immediately in the event of abnormalities such as smoke or unusual odors being emitted. Remove the battery as soon as possible, being careful to avoid electric shocks or burns. If you are drawing power from a household electrical outlet, be sure to unplug the power cord from the outlet to avoid fire or electrical hazards. Discontinue use of the equipment immediately if it is malfunctioning. Contact the nearest service center at your earliest convenience.



- Turn off the power immediately if any metallic object, water, liquid or other foreign object gets into the camera. Remove the battery and memory card as soon as possible, being careful to avoid electric shocks or burns. If you are drawing power from a household electrical outlet, be sure to unplug the power cord from the outlet to avoid fire or electrical hazards. Discontinue use of the equipment immediately if it is malfunctioning. Contact the nearest service center at your earliest convenience.



- Avoid any contact with the liquid crystal inside the picture display, should the monitor be damaged. Follow the appropriate emergency measures below.
- SKIN: If any of the liquid crystal gets on your skin, wipe it off and rinse the affected area thoroughly with water, then wash well with soap.
- EYES: If it gets in your eyes, wash your eyes with clean water for at least 15 minutes and seek medical advice immediately.
- INGESTION: If any of the liquid crystal is ingested, rinse the mouth out thoroughly with water. Have the person drink a large amount of water and induce vomiting. Seek medical assistance immediately.



- Follow these precautions to prevent the battery from leaking, overheating, igniting or exploding.
- Do not use a battery other than those specifically recommended for the equipment.
- Do not carry or store together with metal objects such as ballpoint pens, necklaces, coins, hairpins, etc.
- Do not put the battery into a microwave or high pressure container.
- If leakage of battery fluid or a strange odor, color change, etc. is noticed during use or during charging, remove the battery from the camera or battery charger immediately and keep it away from fire.



- Please observe the following in order to prevent fire, electrical shock or cracking of the battery while charging.
- Use only the indicated power supply voltage. Also avoid the use of multi-socket adapters and extension cords.
- Do not damage, bundle or alter power cords. Also, do not place heavy objects on, stretch or bend power cords.
- Do not connect or disconnect the power plug with wet hands. Always grip the plug section when disconnecting a power cord.
- Do not cover equipment while charging.



- Keep the battery and SD memory card used in this equipment out of the reach of children to prevent accidental ingestion. Consumption is harmful to human beings. If swallowed, seek medical assistance immediately.



- Keep the equipment out of the reach of children.



- Do not touch the internal components of the equipment if they become exposed as a result of being dropped or damaged. The high-voltage circuitry in the equipment could lead to an electric shock. Remove the battery as soon as possible, being careful to avoid electric shocks or burns. Take the equipment to your nearest dealer or service center if it is damaged.



- Do not use the equipment in wet areas as this could result in fire or electric shock.



- Do not use the equipment near flammable gases, gasoline, benzene, thinner or similar substances to avoid the risk of explosion, fire or burns.
- Do not use the equipment in locations where usage is restricted or prohibited as this may lead to disasters or accidents.



- Wipe off any dust that accumulates on the electrical plug as this may lead to fire.
- Use only the specified AC adapter in household electrical outlets. Other adapters pose the risk of fire, electric shock or injury.



- To avoid the risk of fire, electric shock or injury, do not use the battery charger or AC adapter with commercially available electronic transformers when traveling abroad.

Observe the following precautions to ensure safe use of this unit.

Caution



- Contact with fluid leaking from a battery can lead to burns. If part of your body comes in contact with a damaged battery, rinse the area with water immediately. (Do not use soap.)
If a battery starts to leak, remove it immediately from the equipment and wipe the battery chamber thoroughly before replacing it with a new battery.



- Plug the power cords securely into the electrical outlets. Loose cords pose a fire hazard.



- Do not allow the camera to get wet. In addition, do not operate it with wet hands. Both pose the risk of electric shock.





- Do not fire the flash at drivers of vehicles, as this may cause the driver to lose control and result in a traffic accident.

Safety Precautions for Accessories

When using optional products, carefully read the instructions provided with the product before using that product.

Using the Manuals

The following two manuals are included with your CX5.

	<p>"Camera User Guide" (This booklet)</p> <p>This guide explains the usage and functions of the camera. It also explains how to install the camera's built-in software on your computer.</p>
	<p>"Software User Guide" (PDF file)</p> <p>This guide explains how to download images from the camera to your computer.</p> <p>The "Software User Guide" is available in the [MANUAL] folder in the internal memory of the camera.</p> <div data-bbox="600 594 906 856"></div> <p>Each language has its own "Software User Guide".</p> <p>To copy the User Guide onto your computer, connect the camera to the computer using the supplied USB cable. See P.123 for more information.</p>

"MediaBrowser" image viewing and editing software (for Windows only) is also included in the internal memory of the camera. You can download the information on how to use MediaBrowser from the displayed "Help". For more information on MediaBrowser, contact the Customer Support Center below.

North America (U.S.)

TEL: (Toll Free) +1-800-458-4029

Europe

UK, Germany, France and Spain:

TEL: (Toll Free) +800-1532-4865

Other Countries:

TEL: +44-1489-564-764

Asia

TEL: +63-2-438-0090

China

TEL: +86-21-5385-3786

Business hours: 9:00 AM to 5:00 PM

Quick Q & A Index

 See these pages for information on camera settings
 See these pages for explanations of camera features

First Steps

How do I set the clock?

Setting the clock  P.28, 109;  P.114

How do I charge the battery?

Charging the battery  P.26

How do I format internal memory or a memory card?

Formatting  P.24, 109;  P.110

Taking Photographs

“Point-and-Shoot” Photography

Can the camera choose settings automatically?

Auto shooting mode   P.30

Can the camera match settings to the scene?

Scene mode  P.62;  P.59

Can the camera automatically identify the scene?

Scene auto mode   P.38

Preventing Blur

Can focus track moving subjects?

Subject tracking AF  P.78;  P.80, 86

Can focus respond to subject movement?

Pre-AF  P.78;  P.80

How do I prevent blur caused by camera shake?

Camera Shake Correction  P.78;  P.84

How do I prevent blur at slow shutter speeds?

ISO setting  P.78;  P.84, 92

Creative Photography

How do I shoot close-ups?

Macro mode   P.34

How do I shoot high-contrast scenes?

Dynamic range double shot  P.69;  P.68, 70

How do I create a soft focus effect?

Soft focus  P.69;  P.68

Can I take shots that look like photos taken with a toy camera?

Toy camera  P.69;  P.68

Can I take shots that look like pictures of miniatures?

Miniaturize  P.69;  P.68, 71

Can I take high-contrast photos in black and white?

High contrast B&W  P.69;  P.68

How do I make creative use of color?

Cross process  P.69;  P.68

Advanced Settings

How do I take photos at different sizes?

Picture quality/size  P.78;  P.79

How do I take monochrome photos?

Image settings  P.78;  P.81

How do I reduce image noise?

Noise reduction  P.78;  P.82

How do I stamp the date on photos?

Date imprint  P.78;  P.84

How do I adjust exposure?

Exposure compensation  P.78;  P.84, 90

How do I compensate for colored light sources?

White balance  P.78;  P.84, 91

Can I take several photos in one burst?

Continuous mode  P.65;  P.64

Movies

How do I shoot movies?

Movie mode   P.73

How do I view movies?

Viewing movies   P.74

Playback

Can I create resized copies of photos?

Resize  P.93;  P.94

How do I delete unwanted photos?

Deleting files   P.42

How do I view slide shows?

Slide shows  P.93;  P.95

Can I protect images from accidental deletion?

Protect  P.93, 104;  P.95

Can I view my pictures on a TV?

Viewing pictures on TV  P.107

Miscellaneous

How do I keep the flash from firing?

Using the flash   P.35

How do I keep the beep from sounding?

Volume settings  P.109;  P.111

Can I copy my pictures to a computer?

Downloading images  P.123

Can I print images without a computer?

Direct printing  P.118



Contents

Safety Precautions	2
Using the Manuals	5
Quick Q&A Index	6
Contents	8

Basic Operations

13

Packing List	14
Optional Accessories	14
Dial and Button Operation	15
How to Use the Mode Dial	15
How to Use the ADJ./OK Button	16
Names of Parts	17
Picture Display	19
Getting Ready	23
About the Battery	23
About the SD Memory Card (available in stores)	24
Charging the Rechargeable Battery	26
Loading the Rechargeable Battery and SD Memory Card	27
Turning the Power On/Off	28
Setting the Language, Date and Time	28
Basic Shooting	30
Shooting in Auto Shooting Mode (Focus and Shoot)	30
Using the Zoom Function	33
Shooting Close-Ups (Macro Shooting)	34
Using the Flash	35
Using the Self-timer	37
Shooting in Scene Auto Mode	38
Playing Back Images	39
Viewing Your Images	39
Thumbnail View	39
Enlarging Images	41
Deleting Files	42
Deleting a File or All Files	42
Deleting Multiple Files	43
Changing the Display with the DISP. Button	45
About the Electronic Level	48
About the Histogram Display	50

1	ADJ. Button Functions	52
	Selecting Shooting Menu Options Assigned to the ADJ./OK Button.....	52
	Shifting the AE and AF Targets.....	53
2	Using the Fn (Function) Button	55
	Assigning a Role to the Fn Button	56
	Shifting the AF Target for Macro Shooting.....	56
	Locking the Exposure	57
	Choosing a Focus Setting	58
3	Shooting Mode Types	59
	Scene Mode (SCENE).....	59
	Selecting a Scene Mode	62
	Using Skew Correction Mode.....	63
	Continuous Mode ().....	64
	Taking Pictures in Continuous Mode.....	65
	M-Cont Plus (10M).....	66
	M-Cont Plus (2M).....	67
	Speed Cont (Low)/Speed Cont (High).....	67
	Creative Shooting Mode ().....	68
	Taking Pictures in Creative Shooting Mode.....	69
	Dynamic Range Double Shot.....	70
	Shooting in Miniaturization Mode	71
	Plus Normal Shooting.....	72
	Movie Mode ()	73
	Shooting Movies.....	73
4	Playback Functions	74
	Playing Back Movies.....	74
	Playing Back MP Files.....	74
	Exporting MP Files	76
5	Shooting Menu	78
	Using the Menu	78
	Shooting Menu Options.....	79
	Dynamic Range Expansion.....	79
	Soft Focus Options.....	79
	Hue.....	79
	Vignetting.....	79
	Toy Color	79
	Plus Normal Shooting.....	79
	Picture Quality/Size	79
	Movie Size	80

Density	80
Size	80
Focus.....	80
Pre-AF.....	80
Exposure Metering.....	81
Image Settings	81
Super Resolution.....	82
Noise Reduction.....	82
Flash Exposure Compensation.....	82
Auto Bracket.....	82
Time Exposure	82
Custom Self-Timer.....	83
Interval Shooting	83
Camera Shake Correction.....	84
Slow Shutter Limit.....	84
Date Imprint.....	84
Exposure Compensation.....	84
White Balance	84
ISO Setting	84
Maximum ISO for ISO Auto.....	85
Restore Defaults.....	85
Focus	86
Subject Tracking AF.....	86
Multi-Target AF.....	86
Manual Focus (MF).....	87
Auto Bracketing.....	88
Auto Bracket.....	88
White Balance Bracketing (WB-BKT).....	88
Color Bracketing (CL-BKT)	89
Focus Bracketing (FOCUS-BKT).....	89
Exposure Compensation	90
White Balance.....	91
Manual.....	92
ISO Setting.....	92

6 Playback Menu 93

Using the Menu	93
Playback Menu Options.....	94
Flag Function Setting.....	94
Flag Function Display.....	94
Export Still Images.....	94
Resize.....	94
Trim.....	94
Level Compensation.....	94
White Balance Compensation	94

Skew Correction.....	94
Change Grid Point.....	94
Protect.....	95
Slide Show.....	95
Copy to Card from Internal Memory.....	95
DPOF.....	95
Recover File.....	95
Flag Function Setting.....	96
Setting/Canceling One File at a Time.....	96
Setting/Canceling Multiple Files at One Time.....	96
Trim.....	97
Level Compensation.....	100
Correcting Images Automatically.....	100
Correcting Images Manually.....	100
White Balance Compensation.....	102
Skew Correction.....	103
Protect.....	104
DPOF.....	106
Viewing Pictures on TV.....	107
7 Setup Menu.....	109
Using the Menu.....	109
Setup Menu Options.....	110
Format [Card].....	110
Format [Internal Memory].....	110
LCD Brightness.....	110
Reg. My Settings.....	110
Step Zoom.....	110
Set Fn Button.....	110
ADJ Button Setting 1–4.....	111
AF Auxiliary Light.....	111
Operation Sounds.....	111
Volume Settings.....	111
LCD Confirmation Time.....	111
Auto Power Off.....	111
LCD Auto Dim.....	112
Digital Zoom Image.....	112
Level Setting.....	112
Grid Guide Display Options.....	112
Function Guide.....	112
Shooting Info. Display Frame.....	112
Minimum Distance.....	113
Auto Rotate.....	113
White Saturation Display.....	113
Card Sequence No.	113

USB Connection Type	113
Date Settings	114
Language/言語*1	114
Video Out Mode*1	114
HDMI Output	114
Sleep Mode	114
Confirm Firmware Version	114
Eye-Fi Connection Settings*2	114
Eye-Fi Connection Display*2	114
Reg. My Settings	115
Digital Zoom Image	117
8 Direct Printing	118
About the Direct Print Function	118
Connecting the Camera to a Printer	118
Printing Still Images	119
Printing One or All Still Images	119
Printing Several Still Images	122
9 Downloading Images to Your Computer	123
For Windows	123
System Requirements for Using the Built-in Software	123
Installing Software	124
Copying Pictures to Your Computer	128
For Macintosh	130
System Requirements for Using the Built-in Software	130
Copying Pictures to Your Computer	131
Using the MP File Viewer	132
Installing Software	132
10 Appendices	134
Troubleshooting	134
Error Messages	134
Camera Troubleshooting	135
Available Settings	140
Specifications	144
Number of Images That Can Be Stored	147
Defaults Settings/Functions Whose Defaults Are Restored	
When the Camera Is Turned Off	149
Using Your Camera Abroad	151
Cautions on Use	151
Care and Storage	153
Warranty and Servicing	154
Index	156

Basic Operations

If you are using the camera for the first time, read this section.

Packing List	14
Dial and Button Operation	15
Names of Parts	17
Picture Display	19
Getting Ready	23
Basic Shooting	30
Playing Back Images	39
Deleting Files	42
Changing the Display with the DISP. Button	45

Packing List

Open the package and make sure all the items are included.

* The actual appearance of items included may differ.

- **CX5**

The serial number of the camera is provided on the bottom face of the camera.

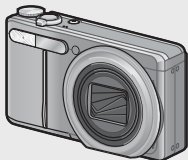

- **USB Cable**
- **AV Cable**
- **Handstrap**

- **Rechargeable Battery**



- **Battery Charger**

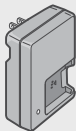

- **Warranty**
- **Camera User Guide**

Optional Accessories

- **Soft Case (SC-90)**

Used to store your camera.

- **Rechargeable Battery (DB-100)**

- **Battery Charger (BJ-10)**

- **HDMI Cable (HC-1)**

Used to connect your camera to a television compatible with HDMI.

- **Neck Strap (ST-2)**

A double-loop neck strap with embroidered RICOH logo.



Note

Attaching the Handstrap/Neck Strap to the Camera

Thread the small end of the strap through the strap eyelet on the camera and loop the ends. Remove the end of the neck strap from the buckle and attach it as shown in the illustration.

- For the latest information on optional accessories, see the Ricoh website (<http://www.ricohpmmc.com/>).

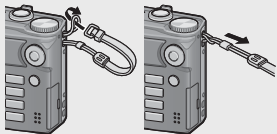

Dial and Button Operation



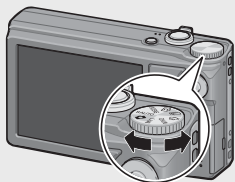

How to Use the Mode Dial

Set the mode dial to the desired mode before shooting still images or movies.



If you are using the camera for the first time, read this section.

Mode Dial Symbols and Descriptions

Symbol	Function	Description	Refer to
	Auto Shooting Mode	Automatically sets the optimal aperture value and shutter speed depending on the subject.	P.30
MY1, MY2	My Settings Mode	You can shoot using the settings registered in [Reg. My Settings].	P.115
	Movie Mode	Allows you to shoot movies.	P.73
	Continuous Mode	You can shoot with various continuous shooting functions.	P.64
	Creative Shooting Mode	Shoot with a variety of effects.	P.68
SCENE	Scene Mode	Allows you to shoot with settings optimized for the shooting scene.	P.59
S-AUTO	Scene Auto Mode	The camera automatically selects the optimal scene mode for simple point-and-shoot photography.	P.38

How to Use the ADJ./OK Button

- To select or enter the selection, use the ADJ./OK button ▲▼⬅️⚡️.
- Instructions in this manual to “Push the ADJ./OK button ▲▼⬅️⚡️” indicate that you should press the ADJ./OK button in the up, down, left or right direction.
- Instructions to “Press the ADJ./OK button” indicate that you should press directly down on the button.

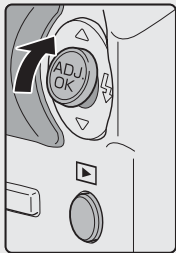

Example: Pushing the ADJ./OK button ▲

If you are using the camera for the first time, read this section.

Names of Parts

Camera

Front View

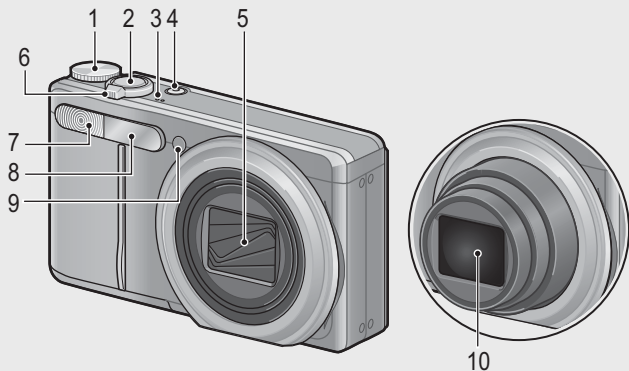

	Item Name	Refer to
1	Mode Dial	P.15, 30, 38, 62, 65, 68, 69, 73
2	Shutter Release Button	P.30
3	Microphone	P.73
4	POWER Button	P.28
5	Lens Cover	—
6	Zoom Lever (Telephoto)/ (Wide-angle) (Enlarged View)/ (Thumbnail View)	P.33, 39, 41
7	Flash	P.35
8	AF Window	—
9	AF Auxiliary Light/Self-Timer Lamp	P.37, 111
10	Lens	—

If you are using the camera for the first time, read this section.

Rear View

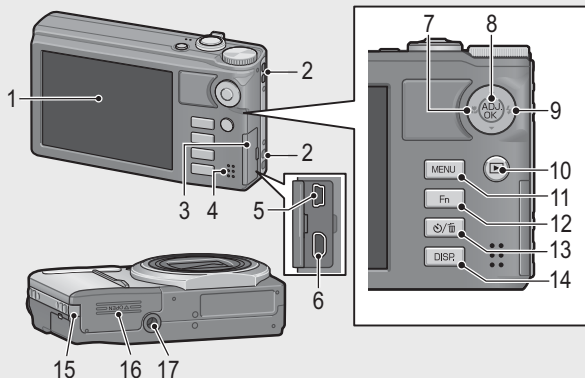

	Item Name	Refer to
1	Picture Display	P.19
2	Strap Eyelet	P.14
3	Terminal Cover	P.107, 114, 128, 131
4	Speaker	P.74
5	Common Terminal for USB Port/AV Output	P.107, 114, 128, 131
6	HDMI Micro Output Terminal (Type D)	P.107
7	(Macro)	P.34
8	ADJ./OK Button	P.52
9	(Flash)	P.35
10	(Playback) Button	P.39
11	MENU Button	P.62, 65, 69, 78, 93, 109
12	Fn (Function) Button	P.55
13	(Self-timer)/ (Delete) Button	P.37, 42
14	DISP. Button	P.41, 45, 48
15	Power (DC input) Cable Cover	—
16	Battery/Card Cover	P.27
17	Tripod Screw Hole	P.146

	Item Name	Refer to		Item Name	Refer to
27	Zoom Bar	P.33	33	Eye-Fi Connection	P.114
28	Interval Shooting	P.83	34	Level Indicator	P.49
29	Aperture	P.144	35	AF Frame	P.30
30	Shutter Speed	P.84	36	S-AUTO	P.38
31	Exposure Compensation	P.90	37	Exposure Warning Indicator	P.90
32	ISO Setting	P.92	38	Camera Shake Warning Symbol	P.32, 84

Movie Mode

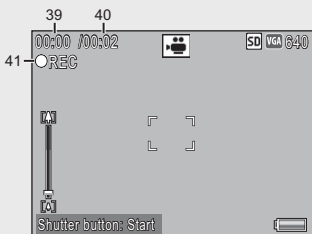

	Item Name	Refer to		Item Name	Refer to
39	Recording Time	P.148	41	Movie Recording Indicator	P.73
40	Remaining Recording Time	P.148			



Note

When the number of remaining shots is 10,000 or more, "9999" is displayed.

Example of Picture Display During Playback

Still Image Mode

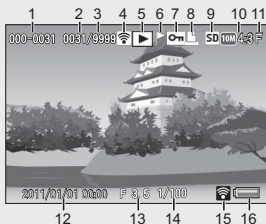

Movie Mode



	Item Name	Refer to		Item Name	Refer to
1	File Number	—	11	Picture Quality	P.79
2	Number of Playback Files	—	12	Date at Shooting	P.29
3	Total Number of Files	—	13	Aperture	P.144
4	Eye-Fi Transferred Images	P.114	14	Shutter Speed	P.84
5	Mode Types	—	15	Eye-Fi Connection	P.114
6	Flag Function Setting	P.96	16	Battery Symbol	P.22
7	Protect	P.104	17	Recording Time or Lapsed Time	—
8	DPOF	P.106	18	Indicator	—
9	Playback Data Source	P.24			
10	Image Size	P.79			



Note

- The picture display may display messages to inform you of operational instructions or the camera's status while in use.
- Additional information can be viewed by pressing the DISP. button. (P.45)

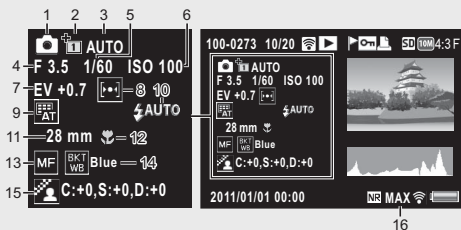







- When you change the color for [Cooking] option in scene mode, the color information ("R:X" or "B:X") is displayed on the right of the [White Balance] icon (shown as "9" on the above).

If you are using the camera for the first time, read this section.



	Item Name	Refer to		Item Name	Refer to
1	Shooting Mode	—	8	Exposure Metering	P.81
2	Plus Normal Shooting	P.72	9	White Balance	P.91
3	Dynamic Range Expansion/ Soft Focus Options/Hue/ Vignetting/Toy Color	P.70, 79	10	Flash Mode	P.35
			11	Focal Length of the Zoom	P.33
			12	Macro Shooting	P.34
4	Aperture	P.144	13	Focus Mode	P.80
5	Shutter Speed	P.84	14	Auto Bracket	P.88
6	ISO Setting	P.92	15	Image Settings	P.81
7	Exposure Compensation	P.90	16	Noise Reduction	P.81

- When using Eye-Fi cards (P.24), connection status will be displayed on the picture display during shooting or playback.

Symbol	Status
	Not connected
	Connecting
	Waiting for data transfer
	Transferring
	Connection stopped
	Transferred images
	Eye-Fi card information acquisition error • Turn the camera back on. If the issues still persist, there may be something wrong with the card.

Battery Level Indication

A battery symbol appears at the lower right of the picture display to indicate the battery level. Recharge the battery before it is depleted.

Battery Symbol	Description
 Green	Battery is sufficiently charged.
 Green	Battery partially discharged. Recharging is recommended.
 Orange	Battery level is low. Recharge the battery.

Getting Ready

Turn the power on and get ready to shoot.



Note

- Be sure the camera is off before removing the battery.
- For information on how to turn the camera off, see P.28.

About the Battery

This camera uses the rechargeable battery DB-100, a dedicated lithium-ion battery supplied with the camera. The rechargeable battery needs to be charged before use. The battery is not charged at the time of purchase.



Number of shots you can take

Approximate number of shots you can take on a single charge: Approx. 280

- Based on CIPA standard. (Temperature: 23 degrees Celsius, picture display on, 30 seconds between shots, changing the zoom setting from telephoto to wide-angle or wide-angle to telephoto for each shot, 50% flash usage, turning the power off after each 10 shots)
- Set the camera to synchro-monitor mode (👉 P.45) or sleep mode (👉 P.114) to increase the number of shots you can take.
- The number of shots is for reference only. If the camera is used for long periods of time for setting and playback, the shooting time (the number of shots) will decrease. If you intend to use the camera for a long period of time, we recommend carrying a spare battery.



Caution

- The battery may become very hot immediately after operation. Turn the camera off and leave it to cool down sufficiently before removing the battery.
- Please remove the battery if you are not going to use the camera for a long period of time.
- When using a lithium-ion battery, use only the specified rechargeable lithium-ion battery (DB-100). Do not use any other battery.
- Batteries should be disposed of under rules appointed by the government or the local authorities.

If you are using the camera for the first time, read this section.

About the SD Memory Card (available in stores)

Pictures can be stored in the camera's 40 MB internal memory or on SD or SDHC memory cards (hereafter referred to as "memory cards") available separately from third-party suppliers.



About Formatting

Before using a memory card for the first time or after using a memory card in other devices, be sure to format it with this camera. Memory cards can be formatted using the [Format [Card]] item (☞ P.110) in the setup menu (☞ P.109).



Where images are recorded

When no SD memory card is loaded, the camera records images to the internal memory (IN); when an SD memory card is loaded, it records images to the SD memory card (SD).



Where images are played back from

When no SD memory card is loaded, the camera plays back from the internal memory (IN). When an SD memory card is loaded, it plays back from the SD memory card (SD).



SDXC Memory Cards

SDXC memory cards can not be used.



Eye-Fi Cards

Eye-Fi X2 series cards (SD memory cards with built-in wireless LAN function) can be used. For more information on Eye-Fi cards, access the Web page of Eye-Fi (<http://www.eye.fi/>).

If you are using the camera for the first time, read this section.



Caution

- If an SD memory card is loaded, the camera does not record to the internal memory, even if the card is full.
- Take care not to get the contacts of the card dirty.
- This product is not guaranteed to support Eye-Fi card functions (including wireless transfer). In case of an issue with an Eye-Fi card, please check with the card manufacturer. Also, Eye-Fi cards can only be used in the country in which the cards were purchased. If it is unclear whether the card has been approved for use in the area, please check with the card manufacturer.



Write-protecting your images

Move the write-protection switch on the SD memory card to LOCK to prevent your still images from being accidentally erased or the card from being formatted.

Note that you cannot shoot images on a locked card because no data can be recorded to the card. Unlock the card before shooting.

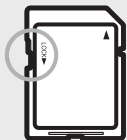

Note

- The [Copy to Card from Internal Memory] item (👉 P.95) in the playback menu (👉 P.93) can be used to copy the pictures in internal memory to a memory card.
- A Speed Class 6 memory card is recommended when recording movies with [HD 1280] selected for [Movie Size].

Charging the Rechargeable Battery

The rechargeable battery needs to be charged before use.

- 1 Insert the battery into the battery charger, making sure that the ⊕ and ⊖ markings on the battery match those on the battery charger.**

- The battery label should face up.

⚠ **Caution**

Be careful not to reverse the ⊕ and ⊖ sides.

- 2 Plug the battery charger into an outlet.**

- Use the battery charger (BJ-10) to recharge the battery. With the charger other than BJ-10, the charging cannot be performed.
- Charging starts. Charging status is indicated by the charger lamp as shown in the table below. Once charging has finished, unplug the battery charger from the power outlet.

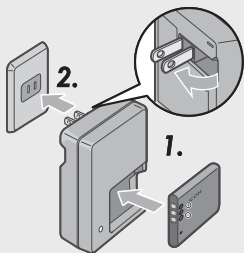

Charger Lamp	Description
Lit	Charging
Off	Charging complete
Flashing	The battery charger terminal may be soiled or the battery charger/battery may be faulty. Unplug the battery charger from the power outlet, and remove the battery.

- The estimated battery charging time is shown below. Depending on the battery level, the charging time differs.

Rechargeable Battery Charging Time	
DB-100	Approx. 180 min. (25 °C)

Loading the Rechargeable Battery and SD Memory Card

After recharging the rechargeable battery, load the battery and the SD memory card. Be sure the camera is off before removing the battery or the SD memory card.

1 Open the battery/card cover.



2 Insert the rechargeable battery and SD memory card.

- Make sure the SD memory card is facing the right way and then push the card all the way in until it clicks.
- When the rechargeable battery is loaded in place, it is locked with the hook shown in the figure.

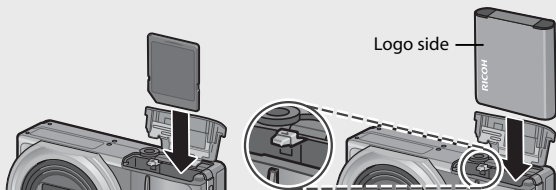

- If the battery is not inserted in the correct orientation, the camera will not turn on. Reinsert the battery in the correct orientation.

3 Close the battery/card cover and slide it back into place.



Removing the Rechargeable Battery

Open the battery/card cover. Release the hook that locks the rechargeable battery. The battery is ejected. Pull the battery out of the camera. Be careful not to drop the battery when removing it from the camera.

Removing the SD Memory Card

Open the battery/card cover. Push in the SD memory card and gently release to eject it. Pull the card out of the camera.

If you are using the camera for the first time, read this section.

Turning the Power On/Off

Press the POWER button to turn the camera on or off.

When the camera is turned on, a start-up sound plays and the picture display turns on.

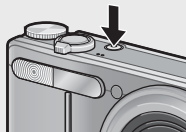

If the POWER button is pressed when the camera is on, the number of files recorded on that day is displayed, and then the camera turns off.

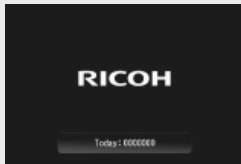



Note

- If you adjust the clock before turning the camera off, the camera will display the number of shots taken since the clock was set.
- A zero is displayed if the clock is not set.



Using the Camera in Playback Mode

Pressing and holding the  (Playback) button turns on the camera in playback mode, allowing you to start playback at once.

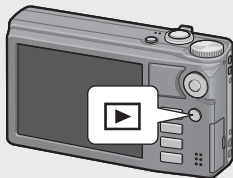
When the camera has been turned on with the  button, pressing the  button again turns the camera off.



Sleep Mode and Auto Power Off

- If the camera goes unused for a set period of time, it automatically dims (Sleep Mode) or turns itself off (Auto Power Off) to save power.
- The sleep mode setting ( P.114) and the auto power off setting ( P.111) can be changed.

Setting the Language, Date and Time

When the power is turned on for the first time, the language setting screen appears (for the picture display language). After setting the language, go on to the date/time setting (for printing the date and time on your photos).

Setting the Language

1 Push the ADJ./OK button ▲▼⏏⚡ to select a language.

- When the DISP. button is pressed, the language setting is canceled and the date/time setting screen appears.



2 Press the ADJ./OK button.

- The display language is set, and the date/time setting screen appears.

Setting the Date and Time

1 Push the ADJ./OK button ▲▼⏏⚡ to set the year, month, date, time and format.

- Change the setting with ▲▼ and move the item with ⏏⚡.
- You can cancel the setting by pressing the DISP. button.
- For information on how to use the ADJ./OK Button, see P.16.

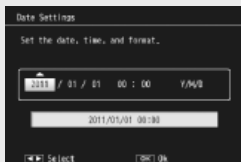

2 Check the information on the screen and then press the ADJ./OK button.

- The confirmation screen appears.

3 Press the ADJ./OK button.

- The date and time are set.
- The language, date, and time can be changed at any time using the [Language/言語] and [Date Settings] items (⏏⚡ P.114) in the setup menu (⏏⚡ P.109).



Note

- The [Date Imprint] item (⏏⚡ P.84) in the shooting menu (⏏⚡ P.78) can be used to stamp photographs with the date and time of recording.
- To retain the date and time settings, load a battery with adequate remaining power for more than two hours.
- If the battery is removed for more than one week, the date and time settings will be lost. These settings must be made again.

If you are using the camera for the first time, read this section.

Basic Shooting

Now you are ready.

Shooting in Auto Shooting Mode (Focus and Shoot)

Turn the mode dial to  to shoot with auto shooting mode.

The shutter release button works in two steps. When you press the shutter release button halfway (Half-press), the auto-focus function is triggered to determine the focal distance. Next, press it all the way down (Full-press) to shoot.

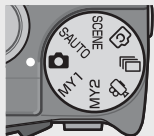

When your subject is not in the center of your composition, compose your photo after focusing (Focus Lock).

1 Hold the camera with both hands and lightly press both elbows against your body.



2 Put your finger on the shutter release button.

3 Frame the picture with your subject in the AF frame in the center of the screen and press the shutter release button halfway.



- The camera focuses on the subject and the exposure and white balance are fixed.
- The focal distance is measured at a maximum of nine points. Green frames appear to indicate the positions that are in focus.

If you are using the camera for the first time, read this section.

- 4** To take a picture with the subject in the foreground in focus against a background, half-press the shutter release button to focus on the subject, and then compose your shot.

Subject to be focused

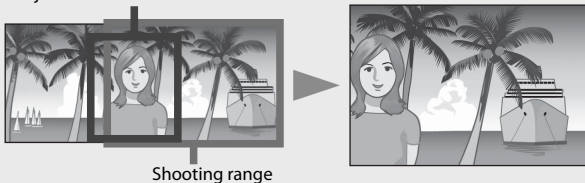

- 5** Gently press the shutter release button all the way.

- The still image you have taken appears momentarily on the picture display and is recorded to the internal memory or the SD memory card.

Caution-----

- When you are shooting, be careful not to obstruct the lens, flash, or AF window with your fingers, hair, or the strap.
- Do not hold the lens unit. Zoom and focusing will not be performed properly.

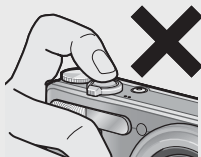

If you are using the camera for the first time, read this section.



About Focusing

- The color of the frame in the center of the picture display indicates whether the subject is in or out of focus.









Focus Status	Frame Color
Before focusing	White
Subject in focus	Green
Subject not in focus	Red (Flashing)

- It may be impossible to bring the following subjects into focus, or they may not be in focus even when the frame color is green.
 - Objects that lack contrast, such as the sky, a wall that is only one color, or the hood of a car.
 - Flat two-dimensional objects with only horizontal lines and no significant protrusions.
 - Quickly moving objects.
 - Things in poorly lit places.
 - Areas with strong backlighting, or reflections.
 - Things that flicker, such as fluorescent lights.
 - Point light sources, such as light bulbs, spotlights, or LEDs.

When you want to shoot subjects like this, first focus on an object the same distance as your subject and then shoot.



Preventing Camera Shake

- Press the shutter release button gently to prevent camera shake.
- If you move the camera when pressing the shutter release button, the still image might not come out clearly due to camera shake. Camera shake tends to occur in the following cases:
 - When shooting in a dark place without using the flash
 - When using the zoom function
 - When [Time Exposure] ( P.82) is selected in the shooting menu ( P.78)
- When the  symbol appears on the picture display, this indicates that camera shake may occur. To prevent camera shake, try any of the following.
 - Selecting [On] for [Camera Shake Correction] ( P.84) in the shooting menu ( P.78)
 - Setting the flash to [Auto] or [Flash On] ( P.35)
 - Raising the ISO setting ( P.92)
 - Using the self-timer ( P.37)

Using the Zoom Function

Turning the zoom lever toward **[T]** (Telephoto) allows you to take a close-up picture of the subject. Turning the zoom lever toward **[W]** (Wide-angle) allows you to take a wide-angle picture. The amount of zoom is shown by the zoom bar and the zoom ratio in the picture display.

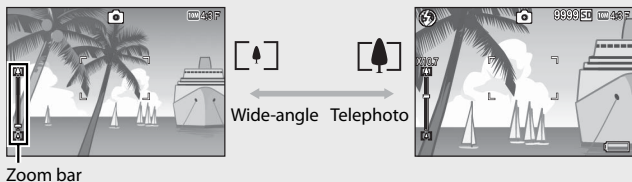
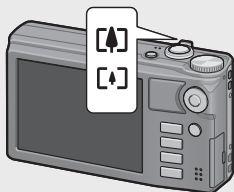

The white part of the zoom bar indicates the optical zoom (up to 10.7 \times); the green part of the zoom bar indicates the super resolution zoom (up to 2.0 \times).

When using the super resolution zoom, the **[SR]** symbol appears on the picture display and the zoom ratio is displayed in green.



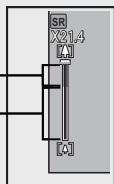

The super resolution zoom allows you to enlarge the subject with less image deterioration.

Super resolution zoom

Optical zoom



Note

- The [On] option ( P.110) selected for [Step Zoom] in the setup menu ( P.109) allows optical zoom to be adjusted in eight discrete steps, and super resolution zoom to be adjusted in two discrete steps.
- The super resolution zoom is enabled when the [Normal] option is selected for [Digital Zoom Image] ( P.112) in the setup menu ( P.109).
- The super resolution zoom function cannot be used in movie mode, continuous mode, or creative shooting mode.

If you are using the camera for the first time, read this section.



Using the Digital Zoom

While you can use the super resolution zoom to enlarge the subject, the digital zoom allows you to enlarge the subject still further (up to another 4.8× for still images, 2.8× for movies with a frame size of 1280, or 4.0× for movies with a frame size of 640 or 320).

To use the digital zoom, turn and hold the zoom lever toward **[A]** until the maximum magnification is reached on the zoom bar, then momentarily release the zoom lever, and then turn the zoom lever again toward **[A]**.

When using the digital zoom, the **DZ** symbol appears on the picture display and the zoom ratio is displayed in yellow. If [Picture Quality/Size] is set to **10M 4 : 3 F** or **10M 4 : 3 N**, you can also set [Digital Zoom Image] to [Auto Resize] (☞ P.117).

Depending on the shooting mode or the settings in the shooting menu, the digital zoom cannot be used (☞ P.140).

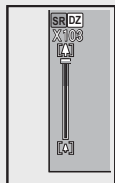

Shooting Close-Ups (Macro Shooting)

The macro shooting function lets you take shots of subjects that are very close to the camera. To shoot close-ups, push the ADJ./OK button toward **🌸** (Macro). Pushing the ADJ./OK button toward **🌸** (Macro) again cancels macro mode.

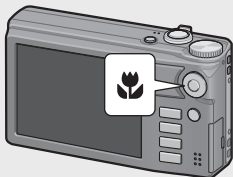

Note

- During macro shooting, the minimum shooting distance changes depending on the zoom position. To display the minimum shooting distance on the screen, set [Minimum Distance] to [Show] (☞ P.113).
- [Focus] (☞ P.84) is set to [Spot AF].
- Macro mode is not available in some shooting modes (☞ P.140).
- To take a further close-up picture during macro shooting, use [Zoom Macro] (☞ P.60) in scene mode.

- The minimum shooting distance and shooting range when using the zoom are shown below.

Zoom position	Focal Length*	Minimum Shooting Distance (from the front of the lens)	Shooting Range
Wide-angle	31 mm	Approx. 1 cm	Approx. 28 mm × 21 mm
Telephoto	300 mm	Approx. 28 cm	Approx. 45 mm × 34 mm (when super resolution zoom/ digital zoom is not used)
	600 mm	Approx. 28 cm	Approx. 22 mm × 17 mm (when 2.0× super resolution zoom/digital zoom is not used)
	2880 mm	Approx. 28 cm	Approx. 5 mm × 4 mm (when 2.0× super resolution zoom/4.8× digital zoom is used)

* Equivalent to that on a 35 mm camera

Using the Flash

You can select the flash mode that best suits your shot. At the time of purchase, the camera is set to [Auto].

1 Push the ADJ./OK button toward ⚡ (flash).

- The list of the flash modes symbol is displayed on the picture display.

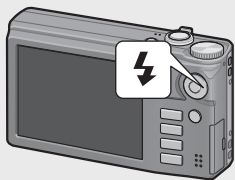

	Flash Off	The flash will not fire.
	Auto	The flash fires automatically when the subject is poorly lit or backlit.
	Anti Red-eye	Reduces the red-eye phenomenon, in which people's eyes appear red in pictures.
	Flash On	The flash fires regardless of the lighting conditions.
	Flash Synchro.	The flash fires with the shutter speed slowed. This is useful when taking portrait pictures in a nightscape. Camera shake may occur, so the use of a tripod is recommended.

If you are using the camera for the first time, read this section.

2 Push the ADJ./OK button ▲▼ to select the flash mode.

- The flash mode symbol is displayed at the upper left of the picture display.
- The flash mode symbol blinks at the upper left of the picture display when the flash is charging. Once the flash is charged, the symbol stops blinking and lights steadily and the camera is ready to shoot.



Caution

- You cannot shoot when the flash is charging (approx. 5 seconds).
- After the camera is turned on, it may take longer for the camera to become ready for shooting when using the flash.



Note

- The flash mode setting is retained until you push the ADJ./OK button toward ⚡ (Flash) again.
- The flash does not fire when the following mode, option, or function is selected.
 - Movie mode
 - Continuous mode
 - [Dynamic range double shot] option in creative shooting mode
 - [Landscape], [Discreet Mode], [Pets], [Night Landscape Multi-shot], [Fireworks], or [Golf Swing Continuous Mode] option in scene mode
 - Multi-target AF
 - Bracket shooting
- Flash level can be adjusted using the [Flash Exposure Compensation] item (👉 P.82) in the shooting menu (👉 P.78).
- The auxiliary flash fires to increase the AE accuracy.
- The flash can not be used in some shooting modes or with some shooting menu options (👉 P.140).

Using the Self-timer

You can set the self-timer to shoot after either two or ten seconds, or you can select [Custom Self-Timer] (👉 P.83) to customize the self-timer setting.

1 With the camera ready to shoot, press the (Self-timer) button.

- A list of self-timer mode settings appears on the picture display.

2 Push the ADJ./OK button to select the mode.

- The self-timer symbol and the number of seconds are displayed at the upper left of the picture display.

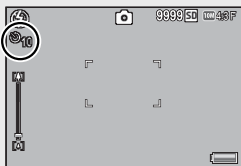

3 Press the shutter release button.

- When set to [10], the self-timer lamp lights for 8 seconds when the self-timer starts and then blinks for the final 2 seconds before the picture is taken.
- When set to [Custom Self-Timer], the self-timer lamp blinks for 2 seconds before each picture is taken, and pictures are taken at the set shooting interval. The focus position is set for the first shot.
- When set to [Custom Self-Timer], press the MENU button to cancel the self-timer during shooting.



Note

- The camera remains in self-timer mode even after the image is shot. To cancel the self-timer, press the  button and change the self-timer setting to [Self-Timer Off].
- When the self-timer is set to 2 seconds, the self-timer lamp does not light or blink.
- When the self-timer is set, the [Interval Shooting] setting is disabled.

If you are using the camera for the first time, read this section.

Shooting in Scene Auto Mode

In scene auto mode, the camera selects the optimal scene mode (👉 P.59) automatically.

The following scene modes can be selected.

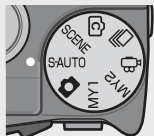

Scene Mode	Refer to	Scene Mode	Refer to
Portrait	P.59	Landscape	P.59
Night. Port.	P.59	Nightscape	—
Sports	P.60	Macro Mode	P.34

The icon of the selected scene mode is shown in the display. If macro mode is selected, an icon will be displayed on the picture display.

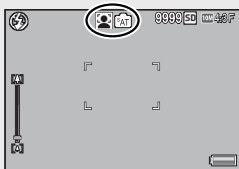

Nightscape Mode

This scene is available only in scene auto mode. The flash will fire only if all the following conditions are met:



- The flash is set to [Auto].
- The flash is determined to be necessary because it is dark.
- There is a figure or another object nearby.



Note

- For information on the options available in the shooting menu when scene auto mode is selected, see P.140.
- If the camera is unable to select a scene, focus, exposure, and white balance will respectively be set to multi AF, multi AE, and multi-pattern auto.

Playing Back Images

Viewing Your Images

To select playback mode, press the  (Playback) button. When the camera is off, pressing and holding the  (Playback) button longer than 1 second turns the camera on in playback mode.

Push the ADJ./OK button  to display the previous file or the next file. Push the button  to display the file 10 frames forward or backward.

To switch the camera from playback mode to shooting mode, press the  button again.

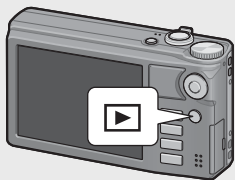

The images played back in playback mode

For information on how to play back files with  symbol, see P.74.

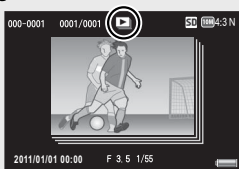

Thumbnail View

20 Frames

If the zoom lever is turned toward  (Thumbnail View), the screen is divided into 20 frames and thumbnails are displayed.

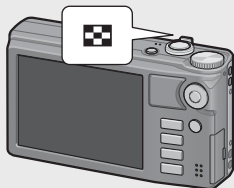

Press the DISP. button to change between the thumbnail list and page list. In the page list, push the ADJ./OK button  to select the page.

If you are using the camera for the first time, read this section.

To view an image full frame, select it in the thumbnail list and press the ADJ./OK button or turn the zoom lever once toward \mathcal{Q} (Enlarged View).

81 Frames

If the zoom lever is turned toward \mathcal{Q} when 20 frames are displayed, the screen is divided into 81 frames and thumbnails are displayed.

Press the DISP. button to change between the thumbnail list and page list. In the page list, push the ADJ./OK button $\blacktriangle \nabla \updownarrow \mathcal{Q}$ to select the page.

To switch to Single-Picture Display, select the file in the thumbnail list and press the ADJ./OK button or turn the zoom lever twice toward \mathcal{Q} (Enlarged View).

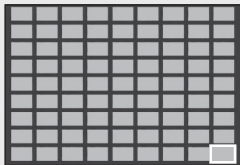

Thumbnail list

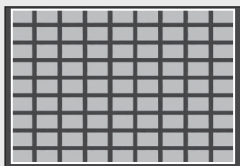

Page list

Date of Recording

If the zoom lever is turned toward \mathcal{Q} again when 81 frames are displayed, the thumbnails are listed by date of recording.

Press the DISP. button to change between the thumbnail list and date list. In the date list, push the ADJ./OK button $\updownarrow \mathcal{Q}$ to select the date, or push the ADJ./OK button $\blacktriangle \nabla$ to select the page.

To switch to Single-Picture Display, select the file in the thumbnail list and press the ADJ./OK button or turn the zoom lever 3 times toward \mathcal{Q} (Enlarged View).

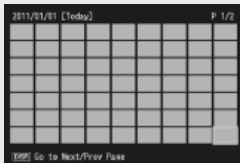

Thumbnail list

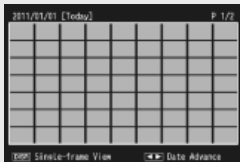

Date list

Enlarging Images





Turn the zoom lever toward  (Enlarged View) to zoom in on the selected still image. The magnification varies depending on the image size.

Image Size	Enlarged View (maximum magnification)
VGA 4:3 F	3.4×
1M 4:3 F	6.7×
Image sizes other than those above	16×



Pressing the DISP. button at this point changes the display as follows.



Pushing the ADJ./OK button    at this point moves the area displayed.

DISP. button
↔





Pushing the ADJ./OK button    at this point moves the area displayed.

Pressing and holding the DISP. Button



Pressing and holding the DISP. Button

Pushing the ADJ./OK button  at this point displays the previous or next image enlarged. When an MP file or a movie is displayed, the display returns to the normal size.

Turn the zoom lever toward  (Thumbnail View) to return to the original size.

Note

- Movies cannot be enlarged.
- For information on how to enlarge MP files, see P.74–75.
- Cropped copies ( P.97) can not be zoomed in to the magnifications stated above.

If you are using the camera for the first time, read this section.

Deleting Files

You can delete files from the SD memory card or internal memory.



Note

The [Recover File] item (P.95) in the playback menu (P.93) can be used to recover files that have been deleted accidentally. Note, however, that files cannot be recovered if, for example, the camera has been turned off or shooting mode has been selected since the files were deleted.

Deleting a File or All Files



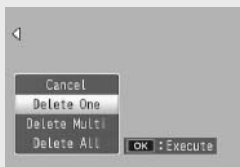

- 1 Press the (Playback) button.**
 - The last file recorded is displayed.
- 2 Push the ADJ./OK button to display the file you want to delete.**
 - To delete multiple files, you can also turn the zoom lever toward (Thumbnail View) to display thumbnail view, and then go to Step 3.
- 3 Press the (Delete) button.**
- 4 Push the ADJ./OK button to select [Delete One] or [Delete All].**
 - You can change the image for deletion with the ADJ./OK button .
- 5 Press the ADJ./OK button.**
 - If [Delete All] is selected, push the ADJ./OK button to select [Yes] and then press the ADJ./OK button.



Deleting Multiple Files

You can select multiple files for simultaneous deletion either individually or by selecting one or more ranges consisting of two images and all photographs between them. To delete multiple files, press the  (Delete) button in playback mode and follow the steps below (to exit at any time without deleting images, press DISP).

Specifying Multiple Files Separately

- 1** Push the ADJ./OK button  to select [Delete Multi] and then press the ADJ./OK button.
 - Omit this step if the camera is already in multi-frame view.
- 2** Push the ADJ./OK button  to select [Sel. Individ.] and then press the ADJ./OK button.
- 3** Push the ADJ./OK button  to select the file you want to delete and press the ADJ./OK button.
 - The trash symbol is displayed in the upper left corner of the file.
 - Press the MENU button to switch to the display for specifying a range of files. See Step 3 and beyond on P.44.
- 4** Repeat Step 3 to select all the files you want to delete.
 - If you selected a file by mistake, you can deselect it by selecting the file and pressing the ADJ./OK button.
 - Press DISP. to cancel and return to Step 2.
- 5** Press the  (Delete) button.
- 6** Push the ADJ./OK button  to select [Yes] and then press the ADJ./OK button.

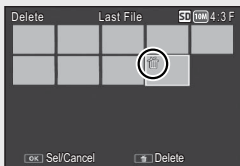

If you are using the camera for the first time, read this section.

Specifying a Range of Multiple Files

- 1** Push the ADJ./OK button ▲▼ to select [Delete Multi] and then press the ADJ./OK button.
 - Omit this step if the camera is already in multi-frame view.
- 2** Push the ADJ./OK button ▲▼ to select [Sel. Range] and then press the ADJ./OK button.
- 3** Push the ADJ./OK button ▲▼🗑️ to select the starting point of the range of files you want to delete and press the ADJ./OK button.
 - If you make a mistake when selecting the starting point for the range of files, press the DISP. button to return to the screen for selecting the starting point.
 - Press the MENU button to switch to the display for specifying files separately. See Step 3 and beyond on P.43.
- 4** Push the ADJ./OK button ▲▼🗑️ to select the ending point of the range of files you want to delete and press the ADJ./OK button.
 - The trash symbol is displayed in the upper left corner of the specified files.
 - Press DISP. to cancel and return to Step 2.
- 5** Repeat Steps 3 and 4 to specify all the ranges of files you want to delete.
- 6** Press the 🗑️ (Delete) button.
- 7** Push the ADJ./OK button 🗑️⚡ to select [Yes] and then press the ADJ./OK button.

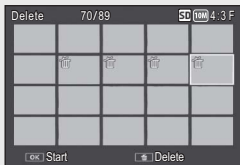
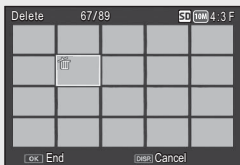

Changing the Display with the DISP. Button

Pressing the DISP. button allows you to change the screen display mode and toggle the information displayed on the picture display.

During Shooting Mode

Normal Symbol Display



Histogram Display



Grid Guide Display



Picture Display Off
(Synchro-Monitor Mode)



No Display



Grid Guide Display-----

- This displays auxiliary lines on the picture display to help you compose your picture. These lines are not recorded with images.
- Use [Grid Guide Display Options] on the setup menu to select the grid.
( P.112)



Synchro-Monitor Mode-----

This turns the picture display off except when the camera is operated. This is effective for saving power consumption. In this mode, pressing the shutter release button halfway turns the picture display on. Subsequently, pressing the shutter release button fully displays the shot image on the picture display and then turns the picture display off. (This setting is different from [LCD Auto Dim] in the setup menu.)

If you are using the camera for the first time, read this section.



Note

- When [Shooting Info. Display Frame] is set to [On] in the setup menu, the shooting information display frame can be displayed for normal symbol display and histogram display (👉 P.112).
- Histograms are not displayed in movie mode. A blinking [●REC] icon, the recording time, and the time available are displayed during recording even when indicators are hidden or the grid guide is displayed.
- When [Level Setting] is set to [Display] or [Display+Sound] (👉 P.48), the level indicator is displayed during normal symbol display and histogram display (👉 P.49).
- If any of the following operations is performed, the picture display turns on even when it is turned off.
 - When the ADJ./OK button, MENU button, DISP. button, or  (Playback) button is pressed.
 - When the zoom lever is turned.
- Changing the display with the DISP. button is not available when scene auto mode is selected.

During Playback Mode

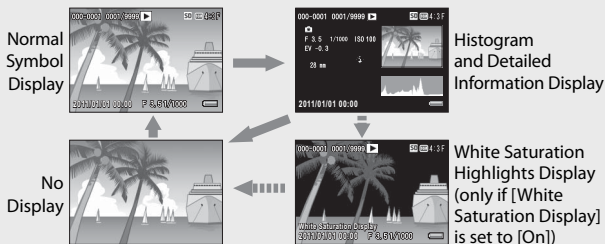

White Saturation Highlights Display-----

- If [White Saturation Display] is set to [On] in the setup menu (☞ P.113), pressing the DISP. button while the histogram and detailed information are displayed switches to the highlight display.
- The white saturation areas of the image flash in black. White saturation is the loss of tone that indicates the color shading in an image in which very bright areas of the subject are rendered in white. An image with a loss of image tone cannot be edited later. It is recommended that you shoot another image by changing the composition or by setting the exposure level lower (-) (☞ P.90).
- The white saturation highlights display is for reference only.

If you are using the camera for the first time, read this section.

About the Electronic Level

When [Level Setting] is turned on in the setup menu or by pressing and holding the DISP. button, the camera uses a level indicator and level sound to let you know whether the image is level during shooting. The level indicator is displayed during normal symbol display and histogram display.

This is useful for keeping the image level when taking pictures of scenery or buildings. This is also very useful for taking pictures with the horizon visible.

Available Settings	Description
Off	The level indicator will not display. The level sound will not emit.
Display	The level indicator will display. The level sound will not emit.
Display + Sound	The level indicator appears on the screen and a level sound is emitted when the image is level.
Sound	The level indicator will not display. A level sound is emitted when the image is level.

1 Select [Level Setting] in the setup menu (P.109) and push the ADJ./OK button ↵.

- You can also press and hold the DISP. button in shooting mode to display the setting menu.

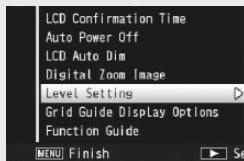

2 Push the ADJ./OK button ▲▼ to select the setting and then press the ADJ./OK button.

If you are using the camera for the first time, read this section.

Level indicator display

When level:

The level indicator becomes green, indicating that the scale is in the middle.

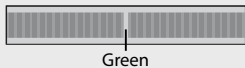

When tilted to the right or left:

The mark on the level indicator becomes orange, indicating the opposite side of the direction in which the camera is tilted.

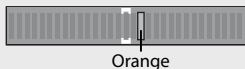

When the camera is tilted too far to the right or left:

Half of the level indicator on the opposite side of the direction in which the camera is tilted becomes red. The mark on the level indicator is not displayed.

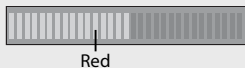

When the camera is tilted too far forward or backward, or it cannot be determined whether the camera is level:

The top and bottom of the level indicator become red. The mark on the level indicator is not displayed.

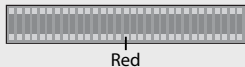

When the camera is held vertically:

When shooting with the camera positioned vertically, the level function can be used to determine whether the image is vertically level (the level indicator appears in a different place).

Caution

- During grid guide display, no display, or when the picture display is turned off (P.45), the level sound is emitted, but the level indicator is not displayed. When [Level Setting] is set to [Display+Sound], only the level sound is emitted.
- The level function is not available if the camera is held upside down, when recording movies, and during interval shooting.
- The level function becomes less accurate when the camera is moving or when shooting in an environment subject to moving, such as on an amusement ride.
- No level sound is emitted when [Level Setting] is set to [Display+Sound] or [Sound] and [Volume Settings] is set to [□□□] (Mute) (P.111).
- Use this function as a reference to see if images are level when shooting images. The accuracy of the level when using the camera as a level cannot be guaranteed.

About the Histogram Display

When Histogram is on, a histogram appears in the lower right corner on the picture display. A histogram is a graph indicating the number of pixels on the vertical axis and the brightness on the horizontal axis (from left to right, shadows (dark areas), midtones, and highlights (bright areas)).

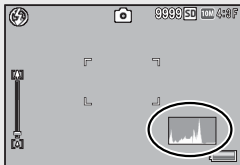

By using the histogram, you can determine the brightness of an image without being affected by the brightness around the picture display. This also helps you correct for areas that are overly bright or dark.

If the histogram has only peaks on the right side, this picture is overexposed with too many pixels only for highlight sections.



If the histogram has only peaks on the left side without anything else, this picture is underexposed with too many pixels only for shadow sections. Refer to this histogram when correcting the exposure.



Note

- The histogram displayed on the picture display is for reference only.
- After taking a picture, you can correct its brightness and contrast by making adjustments to the histogram (👉 P.100).
- Depending on the shooting conditions (use of the flash, dark surrounding light, etc.), the exposure level indicated in the histogram may not correspond to the brightness of the shot image.
- Exposure compensation has its limitation. It does not necessarily achieve the best possible result.
- A histogram with peaks in the center may not necessarily provide the best result to suit your particular requirements. For example, an adjustment is required if you want to underexpose or overexpose the image.
- For information on how to correct the exposure compensation, see P.90.

Advanced Operations

Read this section when you want to learn more about the different camera functions.

1	ADJ. Button Functions	52
2	Using the Fn (Function) Button	55
3	Shooting Mode Types.....	59
4	Playback Functions	74
5	Shooting Menu.....	78
6	Playback Menu	93
7	Setup Menu	109
8	Direct Printing.....	118
9	Downloading Images to Your Computer	123
10	Appendices.....	134

1

2

3

4

5

6

7

8

9

10

1 ADJ. Button Functions

The ADJ./OK button has the following functions. For the operating procedure of each function, see the corresponding reference page.

- ① Assigning four functions from the shooting menu
- ② Shifting the AE and AF targets

1

ADJ. Button Functions

Selecting Shooting Menu Options Assigned to the ADJ./OK Button

You can assign four functions from the shooting menu to the ADJ./OK button. The fifth function is fixed to AE/AF target shift (P.53) and cannot be changed.

By using the ADJ./OK button, you can make settings with fewer button operations and without displaying the shooting menu. This is convenient for frequently used functions.

1 Set the functions you want to assign to the ADJ./OK button with [ADJ Button Setting 1/2/3/4] on the setup menu.

- At the time of purchase, four of the functions are assigned. You can change the assigned functions.

2 Press the ADJ./OK button in shooting mode.

- The ADJ. mode screen appears.



3 Push the ADJ./OK button to select the desired item.

4 Push the ADJ./OK button to select the setting and then press the ADJ./OK button to confirm the setting.

Note

- For functions that can be assigned to the ADJ./OK button, see P.142.
- Press the MENU button in the ADJ. mode to display the shooting menu.

Shifting the AE and AF Targets





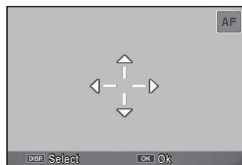

You can shift the target for automatic exposure (AE) and/or auto focus (AF).

Available Setting	Description
AE/AF	AE and AF are set to Spot AE and Spot AF respectively and the target can be moved for both simultaneously. (The targets for Spot AE and Spot AF occupy the same position.)
AF	The AF is set to Spot AF and the target can be moved. The exposure metering is set to the mode selected in [Exposure Metering] in the shooting menu (P.81).
AE	The AE is set to Spot AE and the target can be moved. The focus is set to the mode selected in [Focus] in the shooting menu (P.80).

- 1 Turn the mode dial to / / and then press the ADJ./OK button.
- 2 Push the ADJ./OK button to select .
- 3 Push the ADJ./OK button to select the setting and then press the ADJ./OK button.
 - The target shift screen appears.
- 4 Push the ADJ./OK button to position the target over the subject that will be used to set focus or exposure.
 - Pressing the DISP. button returns the display to the screen in Step 2.
- 5 Press the ADJ./OK button.
- 6 Press the shutter release button halfway and then gently press it the rest of the way down.



**Note**

- With the [Cooking]/[Zoom Macro] option in scene mode, or choosing macro mode by pushing the ADJ./OK button  (macro) while in movie mode, or in the [High Sens], [Skew Correct Mode], or [Text Mode] option in scene mode, the target icon () changes to .
- The macro target shift function is not available when the [Miniaturize] or [Toy Camera] option is selected in creative shooting mode.
- If the macro target shift function is activated using the Fn button ( P.55) and not canceled,  will not be displayed.
- This function is available when [Focus] ( P.80) is set to [Multi AF], [Spot AF], [Snap], or [∞ (Infinity)].

2 Using the Fn (Function) Button

Simply press the Fn button to quickly access the function assigned to it using the [Set Fn Button] option in the setup menu (🔧 P.56).

The function assigned to the Fn button can be selected from the options below.

Available Setting	Description	Refer to
Macro Target	Moves the AF target without moving the camera to shoot close-ups.	P.56
AE Lock	Locks the exposure.	P.57
AF/Face Pr.	Switches between autofocus* ¹ and face-priority multi AF.	P.58
AF/Subj.Trckng	Switch between autofocus* ² and subject tracking AF.	P.58
AF/Multi Trgt	Switches between auto focus* ³ and multi-target AF.	P.58
AF/MF	Switches between auto focus* ³ and manual focus.	P.58
AF/Snap	Switches between auto focus* ³ and snap mode.	P.58
Step Zoom, AT-BKT, WB-BKT, CL-BKT, FOCUS-BKT	Switches between on and off for each function.	P.111 P.88

*1 [Multi AF], [Spot AF] or [Subj. Tracking]

*2 [Multi AF], [Spot AF] or [Face Pr. Multi]

*3 [Multi AF], [Spot AF], [Face Pr. Multi] or [Subj. Tracking]



Note

- For information on the items that can be assigned in each shooting mode, see P.140.
- The Fn button can not be used to access the listed function when [Miniaturize] (🔧 P.71) is selected in creative shooting mode.
- Pressing the Fn button in playback mode displays the image assigned with [Flag Function Setting]. For the operating procedure, see P.96.
- Selecting [Trim], [Level Compensation] (when [Manual] is selected), or [White Balance Compensation] on the playback menu, and pressing the Fn button displays the screen that describes the operating procedure (🔧 P.97, 100, 102).

Assigning a Role to the Fn Button

To assign functions to the Fn button, follow the steps below.

- 1 Select [Set Fn Button] in the setup menu (☞ P.109) and push the ADJ./OK button .
- 2 Select the setting and then press the ADJ./OK button.

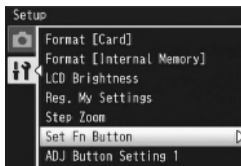



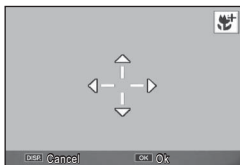

Shifting the AF Target for Macro Shooting

You can select the focus target for close-ups.

- 1 Set [Set Fn Button] to [Macro Target] on the setup menu.
- 2 With the camera ready to shoot, press the Fn button.
 - The macro target shift screen appears.



- 3 Push the ADJ./OK button  to move the cross-mark to the desired target position.
- 4 Press the ADJ./OK button.
 - Pressing the DISP. button cancels the macro target shift function.
- 5 Press the shutter release button halfway and then gently press it the rest of the way down.
 - The camera focuses on the area at the position of the cross-mark.
 - Pushing the ADJ./OK button toward  (Macro) cancels the macro target shift function.



Note

If the AE/AF target shift function is activated using the ADJ./OK button (☞ P.53) and not canceled, the macro target shift function cannot be used by pressing the Fn button.

Locking the Exposure

Assigning [AE Lock] to the Fn button (P.56) and then pressing the Fn button during shooting allows you to lock or cancel the exposure.

- 1 Set [Set Fn Button] to [AE Lock] on the setup menu.**
 - For the operating procedure, see P.56.
- 2 With the camera ready to shoot, position subject in the center of the picture display and press the Fn button.**

- The exposure is locked and the AEL mark, aperture value, and shutter speed appear on the screen.
- Pressing the Fn button again cancels the AE lock.

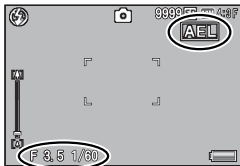

Note

- The AE lock function cannot be used in movie mode.
- The AE lock function can only be used when [Time Exposure] is set to [Off].

Choosing a Focus Setting

If any of the following functions is assigned to the Fn button (👉 P.56), you can change the focus setting during shooting by pressing the Fn button.

Available Setting	Description
AF/Face Pr.	Switch between multi, spot, or subject tracking AF and face-priority multi AF (👉 P.80).
AF/Subj.Trckng	Switch between multi, spot, or face-priority multi AF and subject tracking AF.
AF/Multi Trgt	Switch between multi, spot, face-priority multi, or subject tracking AF and multi-target AF.
AF/MF	Switch between multi, spot, face-priority multi, or subject tracking AF and manual focus.
AF/Snap	Switch between multi, spot, face-priority multi, or subject tracking AF and snap focus.



Caution

The Fn button only be used to switch between the listed modes. If another focus mode is selected, pressing the Fn button has no effect.



















3 Shooting Mode Types

Scene Mode (SCENE)

In scene mode, you can choose from one of the following 14 subject types. Camera settings are automatically optimized for the selected subject type.

Scene Modes

	Portrait	<p>Use for portraits. The camera automatically detects up to eight faces, and adjusts focus, exposure, and white balance. The faces detected by the camera are shown by square borders.</p>	
	Landscape	<p>Use when taking scenery pictures with abundant greenery or blue sky.</p>	
	Discreet Mode	<p>Use where lights and sounds emitted by the camera may be unwelcome. The flash (P.35), AF auxiliary light (P.111), and speaker (P.111) turn off and flash, AF auxiliary light, and sound settings can not be adjusted.</p>	
	Night. Port.	<p>Use when taking portrait pictures against a nightscape. The flash fires automatically. The shutter speed slows down, so be careful of camera shake.</p>	

 Night Landscape Multi-shot	Use for night scenes. Blur caused by camera shake is reduced even in handheld shots. Four shots are taken in succession and combined to create a single image, increasing the time needed to record photographs in comparison to other modes. The  icon is always displayed when the shutter-release button is pressed halfway.
 Fireworks	Use for fireworks scenes. Focus, ISO sensitivity, and white balance are locked to ∞ (Infinity), ISO 100, and AUTO respectively. Pressing the Fn button allows you to toggle the exposure time from [2 seconds], [4 seconds] (the default option), and [8 seconds]. Hold the camera steady by using a tripod when shooting.
 Cooking	Use when taking cooking pictures. Macro mode is selected automatically. Pressing the Fn button displays the screen for cooking picture settings. Push the ADJ./OK button ▲▼ to adjust the brightness; push the button  to adjust the color.
 Sports	Use when taking pictures of moving objects.
 Pets	Use to photograph cats and other pets. The flash ( P.35), AF auxiliary light ( P.111), and speaker ( P.111) turn off and flash, AF auxiliary light, and sound settings can not be adjusted.
 Golf Swing Continuous Mode	Use when checking golf swings, etc. The camera shoots in M-Cont Plus (2M) ( P.67). The grid line is displayed when shooting and for playback. Pressing the Fn button displays the screen for grid line settings. Push the ADJ./OK button ▲▼  to change the grid point; press the  (Delete) button to change the grid type (If the grid point is changed with the [Change Grid Point] option in the playback menu ( P.93), the grid type cannot be changed with the  (Delete) button).
 Zoom Macro	The camera automatically zooms to the optimal zoom position to shoot at a higher magnification than in normal macro shooting. Optical zoom can not be used. Macro mode is selected automatically.
 High Sens	Use when taking pictures in dimly lit places. The picture display also becomes brighter.



Skew Correct
Mode

Reduce the effects of perspective when photographing rectangular objects, such as message boards or business cards. For detailed operations, see P.63.



Image size can be set to [TM 4 : 3 F] or [VGA 4 : 3 F] using the [Picture Quality/Size] option (P.79) in the shooting menu (P.78).



Text Mode

Use when capturing text images, for example notes written on a whiteboard at a meeting. Images are captured in black and white. Image size can be set to [10M 4 : 3] or [3M 4 : 3] using the [Size] option (P.80) in the shooting menu (P.78).



Caution

- In [Discreet Mode] or [Pets]:
 - The beep does not sound.
 - Pushing the ADJ./OK button to ⚡ (flash) does not change the flash mode (P.31).
 - The self-timer lamp will not blink and a beep will not sound in self-timer mode (P.32).



Note

- When using [Zoom Macro], you can shoot close-ups within the following distances:

Focal Length*	Minimum Shooting Distance (from the front of the lens)	Shooting Range
70 mm	Approx. 1 cm	Approx. 19 mm × 14 mm (when super resolution zoom/digital zoom is not used)
140 mm	Approx. 1 cm	Approx. 9 mm × 7 mm (when 2.0× super resolution zoom/digital zoom is not used)
672 mm	Approx. 1 cm	Approx. 2 mm × 1 mm (when 2.0× super resolution zoom/4.8× digital zoom is used)

* Equivalent to that on a 35 mm camera

- The image stabilization technology utilized in the Night landscape multi-shot is PhotoSolid®, a product of Morpho, Inc.

Selecting a Scene Mode

1 Turn the mode dial to SCENE.

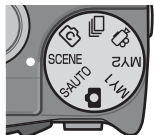

- The camera is ready to shoot and the selected scene mode is displayed at the top of the picture display.

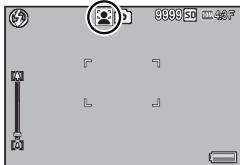

2 Press the MENU button to change the scene mode.

- The scene mode selection screen appears.





3 Select a scene mode.

4 Press the ADJ./OK or Fn button.



- Pressing ADJ./OK button returns the camera to shooting mode with the selected option shown at the top of the picture display.
- Pressing Fn button selects the highlighted option and displays the shooting menu (P.78).

5 Press the shutter release button to shoot the picture.

Changing the shooting menu or setup menu setting in scene mode ----

After pressing the MENU button in shooting mode to display the menus, push the ADJ./OK button  to select the [MODE] tab. You can then push  once to display the shooting menu or twice to display the setup menu.

Using Skew Correction Mode

- 1 Select [Skew Correct Mode] in the scene mode menu and press the ADJ./OK button.**
- 2 Press the shutter release button to shoot the picture.**
 - The display indicates that the image is being processed, and then the area recognized as the correction range is displayed with an orange frame. Up to five areas can be recognized.
 - If the target area cannot be detected, an error message appears. The original image remains unchanged.
 - To select another correction area, move the orange frame to the target area by pushing the ADJ./OK button .
 - To cancel skew correction, push the ADJ./OK button . Even if you cancel skew correction, the original image remains unchanged.
- 3 Press the ADJ./OK button.**
 - The display indicates that the image is being corrected, and then the corrected image is recorded. The original image remains unchanged.



Note

You can also correct the skew of a previously shot still image ( P.103).



Caution











When [Skew Correct Mode] is selected, note the following:

- To shoot the subject as large as possible, position it so that the entire portion of the subject is visible on the picture display.
- The camera may fail to recognize the subject in the following cases:
 - When the image is out of focus
 - When four edges of the subject are not clearly visible
 - When it is hard to distinguish between the subject and background
 - When the background is complicated
- Two images, one before correction and the other after correction, are recorded. If the number of remaining shots is less than two, you cannot shoot the subject.
- The correction area may not be detected properly if the [Date Imprint] function is activated.

Continuous Mode ()

Turn the mode dial to  to use the various continuous shooting functions. Continuous mode can be selected from the continuous mode selection dialog displayed when the MENU button is pressed.

Continuous Modes

 Continuous Mode	This is the normal continuous mode. Pictures continue to be taken for as long as you hold down the shutter release button. Images are recorded one at a time, just as in normal shooting. The number of images that can be shot in continuous mode depends on the image size setting ( P.79).
 M-Cont Plus (10M)	The camera shoots while the shutter-release button is pressed, but only the last 15 frames (about the last three seconds of shooting) are recorded to create a single multi-picture (MP) file ( P.66).
 M-Cont Plus (2M)	The camera shoots while the shutter-release button is pressed, but only the last 26 frames (about the last 0.9 seconds of shooting) are recorded to create a single multi-picture (MP) file ( P.67).
 Speed Cont (Low)	While the shutter-release button is pressed, the camera shoots up to 120 frames at about 60 frames per second and groups them together in a single MP file. About 2 s are required to shoot the entire sequence ( P.67).
 Speed Cont (High)	While the shutter-release button is pressed, the camera shoots up to 120 frames at about 120 frames per second and groups them together in a single MP file. About 1 s is required to shoot the entire sequence ( P.67).



MP file

MP is a file format for recording a set of still images.



Caution

Recording times may increase when internal memory is used.

Taking Pictures in Continuous Mode

- 1 Turn the mode dial to .

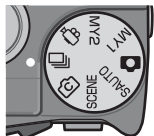

- The camera enters shooting mode with the current continuous mode shown at the top of the picture display.

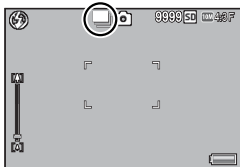

- 2 Press the MENU button.

- To choose a different continuous mode, press the MENU button to display continuous mode options.

- 3 Select the desired option.

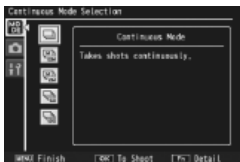



- 4 Press the ADJ./OK or Fn button.

- Pressing ADJ./OK button returns the camera to shooting mode with the selected option shown at the top of the picture display. Pressing Fn button selects the highlighted option and displays the shooting menu ( P.78).

- 5 Press the shutter release button to shoot the picture.



Accessing the Shooting and Setup Menus-----

After pressing the MENU button in shooting mode to display the menus, push the ADJ./OK button  to select the [MODE] tab. You can then push the  button once to display the shooting menu or twice to display the setup menu.

**Note**

- Focus, exposure value, and white balance are locked.
- ISO sensitivity is raised.
- Flickering may be recorded as horizontal bands when pictures are taken under fluorescent lights.
- When [Card Sequence No.] is set to [On] (P.113) and the last four digits of the file number exceed "9999" during continuous shooting, a separate folder is created in the SD memory card and successive pictures taken in continuous mode are stored in this folder.

M-Cont Plus (10M)

The camera shoots while the shutter release button is pressed all the way down, but only the last 15 frames (about the last three seconds of shooting) are recorded, creating a single multi-picture (MP) file.

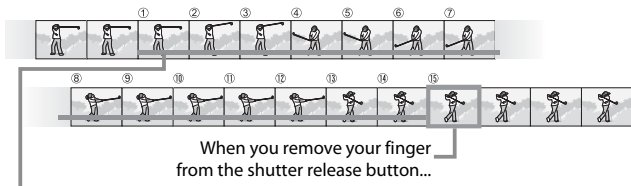

...the camera records the 15 frames taken in the last 3 s of shooting.

**Caution**

The time needed to record 15 frames may increase if lighting is poor.

**Note**

- The image size is fixed at **10M** 4 : 3 N.
- The time for each shot in the sequence is recorded separately.

M-Cont Plus (2M)

The camera shoots while the shutter release button is pressed all the way down, but only the last 26 frames (about the last 0.9 seconds of shooting) are recorded, creating a single multi-picture (MP) file.



...the camera records the 26 frames taken in the last 0.9 seconds of shooting.



Caution

When shooting a fast-moving subject, the subject may be distorted in the recorded image.



Note

- The image size is fixed at **2M** 4 : 3 N.
- The time at which you remove your finger from the shutter release button is recorded as the time of shooting for all photographs in the sequence.

Speed Cont (Low)/Speed Cont (High)

120 consecutive images are recorded in one second (Speed Cont (High)) or two seconds (Speed Cont (Low)).



Caution

When shooting a fast-moving subject, the subject may be distorted in the recorded image.



Note





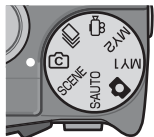

- The image size is fixed at **VGA** 4 : 3 N.
- The time at which you remove your finger from the shutter release button is recorded as the time of shooting for all photographs in the sequence.

Creative Shooting Mode (📷)

Choose from six creative photographic effects.



Creative Shooting Mode Options

 Dynamic Range	Create images with natural contrast, reducing loss of detail in shadows and highlights. For detailed operations, see P.70.
 Miniaturize	Use to create pictures that appear to be photos of dioramas. For detailed operations, see P.71.
 High Contrast B&W	Use to create black-and-white images with higher contrast than those normally produced using black and white (📷 P.81). Produces grainy images similar to those taken with highly sensitive film or high gain film processing.
 Soft Focus	Choose for soft focus effects similar to those created by soft focus lenses. The amount of softening can be selected using the [Soft Focus Options] item in the shooting menu (📷 P.79).
 Cross Process	Take photographs with colors that differ markedly from those of the actual subject. The colors can be selected using the [Hue] option in the shooting menu (📷 P.79).
 Toy Camera	Take photographs with the high contrast, saturated colors, distortion, and vignetting associated with toy cameras. Use the [Vignetting] option in the shooting menu (📷 P.79) to choose the amount of vignetting, the [Toy Color] option (📷 P.79) to choose the amount of saturation.

Taking Pictures in Creative Shooting Mode

- 1 Turn the mode dial to .

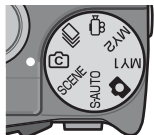

- The camera enters shooting mode with the current creative shooting mode option shown at the top of the picture display.

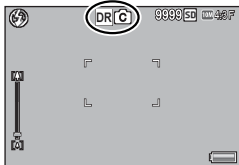

- 2 Press the MENU button.

- To choose a different creative shooting mode, press the MENU button to display creative shooting mode options.

- 3 Select the desired mode.

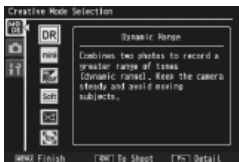



- 4 Press the ADJ./OK or Fn button.

- Pressing ADJ./OK button returns the camera to shooting mode with the selected option shown at the top of the picture display.
- Pressing Fn button selects the highlighted option and displays the shooting menu ( P.78).

- 5 Press the shutter release button to shoot the picture.



Accessing the Shooting and Setup Menus-----

After pressing the MENU button in shooting mode to display the menus, push the ADJ./OK button  to select the [MODE] tab. You can then push the  button once to display the shooting menu or twice to display the setup menu.

Dynamic Range Double Shot



“Dynamic range” refers to the range of brightnesses (tone levels) that can be expressed by the camera. Dynamic range double shot creates a smooth transition from highlights to shadows for natural contrast.

Note

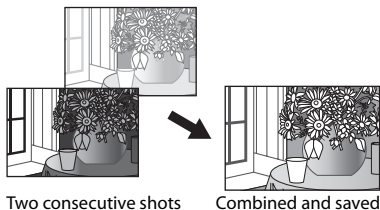
With dynamic range double shot, two consecutive pictures are taken with different exposures and then the areas with the appropriate exposure are combined together. This mode uses a longer shooting time than other modes, so be careful of camera shake when taking pictures. The  symbol is always displayed.



Caution

- Dynamic range double shot may not be effective if the shooting location is overly bright or dark.
- We recommend that you select [Multi] for [Exposure Metering] ( P.70) in the shooting menu ( P.78) when using dynamic range double shot.
- When shooting a fast-moving subject, the subject may be distorted in the recorded image.
- Flicker from fluorescent lights may appear as horizontal bands. Fluorescent lighting may also affect colors and brightness.

Dynamic Range Expansion Effect

The [Dynamic Range Expansion] option in the shooting menu offers five levels of dynamic range expansion: [AUTO], [Very Weak], [Weak], [Medium], and [Strong]. The stronger the expansion effect, the wider the range of brightnesses processed by the camera.

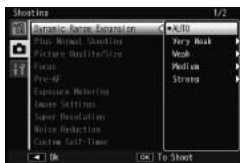

The effect can be chosen using the [Dynamic Range Expansion] option when [Dynamic Range] is selected in creative shooting mode.

If an option other than [AUTO] is highlighted when you push the ADJ./OK button , the menu shown at right will be displayed. Choose the tone range given priority for expanded dynamic range from [Highlights], [Shadows], and [Off].

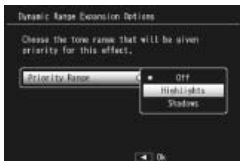

Shooting in Miniaturization Mode

This mode creates pictures that appear to be photos of dioramas. It is most effective when pictures are taken from a high vantage point.

- 1 Select [Miniaturize] in the creative shooting mode menu and press the ADJ./OK button.
- 2 Press the Fn button.
 - The miniaturization setting screen appears.
 - The areas that will not be in focus in the final photograph are shown in gray.
 - Press the DISP. button to cancel the setting.

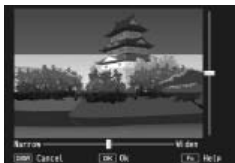

Note

When the camera is held vertically, the area that will be in focus is shown in horizontal orientation. Press the  button to re-orient the area that will be in focus.



- 3** Push the ADJ./OK button ▲▼ to reposition the area that will be in focus.

- For help, press the Fn button. Press the Fn button again to clear help from the display.



- 4** Push the ADJ./OK button ↶↷ to choose the width of the area that will be in focus.

- 5** Press the ADJ./OK button.



- 6** Frame a picture and press the shutter release button halfway to focus, then press the shutter release button the rest of the way down to take the picture.

Caution-----

The focus of the final image differs slightly from that in the image displayed immediately after shooting.

Plus Normal Shooting

When [On] is selected for [Plus Normal Shooting] in the shooting menu, the camera will record two copies of each photo taken in creative shooting mode: one processed according to options selected for creative shooting mode and a second, unprocessed copy. The two copies are shown in the picture display after shooting, with the unprocessed image on the right and the modified copy on the left.

To turn this option on or off, turn the mode dial to  and then select an option for [Plus Normal Shooting] in the shooting menu.

Note-----

In the case of photographs taken with dynamic range double shot, histograms are included for both images when the pictures are displayed after shooting. When [LCD Confirmation Time] is set to [Hold] ( P.111), the confirmation screen remains displayed so you can confirm the histograms and easily compare the images.

Movie Mode (📹)

Shooting Movies

Rotate the mode dial to 📹 to record movies with sound. Frame size can be selected using the [Movie Size] item (👉 P.80) in the shooting menu. Each movie you shoot is recorded as an AVI file.

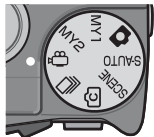

Press the shutter release button halfway to focus and the rest of the way down to start recording. The [●REC] icon blinks while recording is in progress and the recording time and time available are shown in the picture display. Press the shutter release button halfway or all the way down to end recording.

⚠ Caution

- While shooting movies, operation sounds may be recorded.
- Movies may be up to 4GB in size. The maximum length is 12 minutes for movies recorded at a [Movie Size] of [HD 1280] and 29 minutes for movies recorded at [VGA 640] or [QVGA 320]. Depending on the type of memory card used, shooting may end before this length is reached. The maximum total length of all movie files that can be stored depends on the capacity of the memory card (👉 P.148).
- When shooting a fast-moving subject, the subject may be distorted in the recorded image.
- Flickering may be recorded as a horizontal band when shooting under fluorescent lights.

📌 Note

- During recording, the zoom lever can be used for digital zoom (👉 P.34).
- Subject tracking AF can not be used.
- The camera shoots movies at 30 frames per second.
- The remaining recording time may not change uniformly because it is recalculated from the remaining memory capacity during movie recording.
- Depending on the remaining battery level, the battery may become depleted during movie shooting. Use of a battery with adequate remaining power is recommended.
- A Speed Class 6 memory card is recommended when recording movies with [HD 1280] selected for [Movie Size].

4 Playback Functions

Playing Back Movies

To play back movies, follow the steps below.

1 Select the movie you want to play back in playback mode.

2 Press the ADJ./OK button.

- Playback begins. The elapsed playback indicator or the elapsed time is displayed on the screen.



Fast Forward	Turn the zoom lever toward [A] during playback.
Rewind	Turn the zoom lever toward [B] during playback.
Pause/Playback	Press the ADJ./OK button.
Slow Playback	Turn and hold the zoom lever toward [A] during pause.
Slow Rewind	Turn and hold the zoom lever toward [B] during pause.
Next Frame	Turn the zoom lever toward [A] during pause.
Previous Frame	Turn the zoom lever toward [B] during pause.
Volume Adjustment	Push the ADJ./OK button ▲▼ during playback.

Playing Back MP Files

When you shoot one still image with M-Cont Plus, Speed Cont, or Multi-trgt AF, the image is recorded as one MP file. Use the following method to play back MP files.



Note

- Images shot in normal continuous mode can be played back in the same way as normal still images.
- The focus position is displayed for multi-target AF shooting.
- The grid line is displayed when shooting with the [Golf Swing Continuous Mode] option in scene mode.

1 Display the MP file you want to play back in playback mode.

- The MP file is displayed with the  symbol.



2 The display changes as follows.

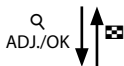

Display for Step 1

- Press the DISP. button to change between “Normal” and “No Display”.
- The images cannot be enlarged even if the zoom lever is turned toward (Enlarged View). The images are displayed in thumbnail view.
- The other operations are the same as those for normal still images.

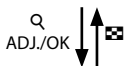

Thumbnail view

- The MP file images are displayed in thumbnail view.
- Push the ADJ./OK button to select a frame.
- The DISP. button is disabled.



Single frame view

- This displays the frame selected on the thumbnail view.
- Turn the zoom lever toward (Enlarged View) to display enlarged view.



Displaying Slide Shows

- Images are displayed automatically in the order they were consecutively shot, starting with the displayed frame.

- The operations during slide show are shown below.

Pause/Playback	Press the ADJ./OK button.
Fast Forward	Turn and hold the zoom lever toward during playback.
Rewind	Turn and hold the zoom lever toward during playback.
Slow Playback	Turn and hold the zoom lever toward during pause.
Slow Rewind	Turn and hold the zoom lever toward during pause.
Next Frame	Turn the zoom lever toward during pause.
Previous Frame	Turn the zoom lever toward during pause.
First Frame	Push the ADJ./OK button .
Last Frame	Push the ADJ./OK button .

3 To play back files other than MP files, return to Step 1 and push the ADJ./OK button .

**Caution**

- The [DPOF], [Trim], [Resize], [Skew Correction] (playback mode), [Level Compensation], and [White Balance Compensation] functions are not available for MP files.
- [Flag Function Setting] and [Protect] cannot be set for individual frames in an MP file. If [Flag Function Setting] or [Protect] is set when the thumbnail view or single image view is displayed, the setting will be applied to the MP file instead of an individual frame.
- The individual images in a MP file can not be deleted separately.

**MP file**

MP is a file format for recording a set of still images.

Exporting MP Files

You can extract selected frames from an MP file and save each frame as an individual still image.

**Note**

- The MP file is displayed with the  symbol.
- The images are saved in the same sizes used for shooting.
- The original files will be retained after extraction.
- The focus positions for images shot using multi-target AF or the grid line using the [Golf Swing Continuous Mode] option in scene mode will not be displayed on extracted images.

To export MP files, display the MP file which you want to export in playback mode, and then press the MENU button to display the playback menu and select [Export Still Images].

If [1 Frame] is selected, you can select a frame for export by pushing the ADJ./OK button .

Select [All Frames] to export all frames in the selected MP file.

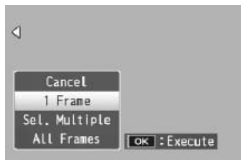

Selecting Multiple Frames

If [Sel. Multiple] is selected, select multiple individual frames or a range of frames.

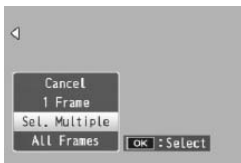

To select multiple individual frames:

- 1** Select [Sel. Individ.] and press the ADJ./OK button.
- 2** Select a frame and press the ADJ./OK button.
 - Press the MENU button to switch to the display for specifying a range of frames.
 - If you selected a frame by mistake, you can deselect it by selecting the frame and pressing the ADJ./OK button.
 - Select all the frames which you want to export.
- 3** Press the Fn button, select [Yes] and press the ADJ./OK button.

To select two frames and all frames between them:

- 1** Select [Sel. Range] and press the ADJ./OK button.
- 2** Select the first frame and press the ADJ./OK button.
 - Press the MENU button to switch to the display for specifying frames separately.
- 3** Select the last frame and press the ADJ./OK button.
 - Repeat Steps 2 and 3 to select multiple ranges.



- 4** Press the Fn button, select [Yes] and press the ADJ./OK button.



Note



[Sel. Individ.] and [Sel. Range] can be selected directly if [Export Still Images] is chosen in thumbnail view.

5 Shooting Menu

The shooting menu is used to adjust camera settings when taking pictures. To display the shooting menu, press the MENU button when the camera is in shooting mode.

Using the Menu

1 Press the MENU button in shooting mode.

- The shooting menu is displayed.
- To display the shooting menu in scene, continuous, or creative shooting mode, push the ADJ./OK button  to select the [MODE] tab and then push the button  once.



Indicates the range of displayed screens.

2 Push the ADJ./OK button to select the desired menu item.

- If the DISP. button is pressed at this point, the cursor moves to the shooting menu tab.
- Push the ADJ./OK button  at the bottom item to display the next screen.

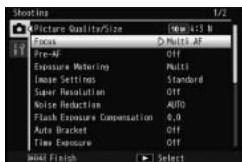

3 Push the ADJ./OK button .

- The menu item settings are displayed.

4 Push the ADJ./OK button to select the setting.

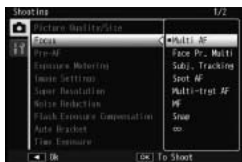

5 Press the ADJ./OK button.

- The setting is confirmed, the shooting menu disappears and the camera is ready to shoot.
- To select the highlighted option and return to the menu shown in Step 2, push the ADJ./OK button .

Shooting Menu Options

Dynamic Range Expansion

 P.70

Select the dynamic range expansion effects.

Soft Focus Options

 P.68

Choose the amount of softening produced by the [Soft Focus] option in creative shooting mode. Select from [Weak] and [Strong].

Hue

 P.68

Choose the hue of photographs created using the [Cross Process] option in creative shooting mode. Select from [Basic], [Magenta], or [Yellow].



Caution

Depending on exposure and the option selected for white balance, [Magenta] and [Yellow] may not produce the desired results.

Vignetting

 P.68

Choose the amount of vignetting produced by the [Toy Camera] option in creative shooting mode. Select from [Weak], [Strong], and [Off].

Toy Color

 P.68

Select [On] to increase saturation in photographs taken using the [Toy Camera] option in creative shooting mode.

Plus Normal Shooting

 P.72

Record unprocessed copies of photographs taken in creative shooting mode.

Picture Quality/Size

Adjust picture quality and size when taking pictures.

10M 4 : 3 F/ 10M 4 : 3 N	3648 × 2736	9M 3 : 2 F	3648 × 2432
7M 1 : 1 F	2736 × 2736	7M 16 : 9 F	3648 × 2048
5M 4 : 3 F	2592 × 1944	3M 4 : 3 F	2048 × 1536
1M 4 : 3 F	1280 × 960	VGA 4 : 3 F	640 × 480



Note

Lower compression ratio and less image deterioration are available with F (Fine), but the file size is larger than with N (Normal).



Shooting menu options

The options in the shooting menu vary with the selected shooting mode. In scene and creative shooting modes, the options available vary with the scene or creative shooting mode option selected. See P.140 for more information.

Movie Size  P.148

Choose the movie frame size.

Density

Adjust contrast when using the [Text Mode] option in scene mode.

Size  P.148

Choose the size of pictures taken using the [Text Mode] option in scene mode.

Focus  P.86

Choose a focusing mode.

**Multi AF**

Measures the distances from nine AF areas and focuses to the nearest AF area. Choose to prevent out-of-focus photos.

**Face Pr. Multi**

The camera automatically detects and focuses on faces. If no faces are detected, the camera focuses using multi AF.

**Subj. Tracking**

The camera focuses when the shutter release button is pressed halfway and tracks the selected subject until a picture is taken or you remove your finger from the shutter release button ( P.86).

**Spot AF**

Selects one AF area at the center of the picture display to allow the camera to focus on this area automatically.

**Multi-trgt AF**

Takes five consecutive pictures while shifting the focus to multiple positions. ( P.86)

**MF**

Enables you to adjust the focus manually ( P.87).

**Snap**

Fixes the shooting distance to a short distance (approx. 2.5 m (8.2 ft.)).

**∞ (Infinity)**

Fixes the shooting distance to infinity. It is useful for shooting distant scenes.

Pre-AF

If [On] is selected when [Multi AF], [Face Pr. Multi], [Subj. Tracking], [Spot AF], or [Multi-trgt AF] is selected for [Focus], the camera will continue to focus even when the shutter-release button is not pressed halfway. This may decrease the time needed to focus when a picture is taken, potentially improving shutter response.

Exposure Metering

You can change the metering method (the range to use for metering) used to determine the exposure value.



Multi

The entire shooting range is divided into 256 partitions, and each is metered to determine the overall exposure value.



Center

The entire image is metered, with emphasis on the center, to determine the exposure value. Use this when the brightness of the center and surroundings are different.



Spot

Only the center of the image is metered to determine the exposure value. Use this setting when you want to use the brightness at the center. This is useful if there is a marked difference in contrast or backlighting.

Image Settings

You can change the picture quality of an image, including the contrast, sharpness, color and vividness.



Vivid

Take strong, vivid photos with higher contrast and sharpness and maximum vividness.



Standard

Creates an image with normal picture quality.



Cust. Settings

You can select from five [Contrast], [Sharpness], and [Vividness] levels.

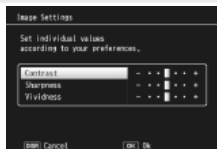

Black & White

Creates a black and white picture.



Sepia

Creates a sepia-toned picture.

Super Resolution

The super resolution process applies to still images to enhance picture resolution. Select the level from [Off], [Weak], and [Strong] for this process. The processing time vary depending on the selected level.

**Note**

With super resolution, the camera uses the [Auto] option for noise reduction, and the default setting value for sharpness.

Noise Reduction

Perform noise reduction when taking photographs. Choose from [Off], [Auto], [Weak], [Strong], or [MAX]. The time required to record images varies with the option selected.

**Note**

When selecting super resolution, the noise reduction option is fixed to [Auto].

Flash Exposure Compensation

You can adjust the light intensity of the flash. You can set the light intensity from -2.0 EV to $+2.0$ EV in increments of $1/3$ EV.

**Caution**

Flash exposure compensation may not work outside the flash range (👉 P.144).

Auto Bracket

👉 P.88

Vary exposure, white balance, color, or focus over a series of pictures.

Time Exposure

Use time exposures to capture fireworks as they rise into the air and explode, to create trails of light behind cars and other moving objects, or to shoot night scenery. Choose the exposure time from [Off], [1 second], [2 seconds], [4 seconds], and [8 seconds].

**Note**

- The shutter speed may slow down and images may be blurred. Hold the camera steady by using a tripod when shooting.
- The picture display turns off while shooting.
- Long time-exposures are processed to reduce noise. The time required for processing is roughly equivalent to the exposure time.
- ISO sensitivity is restricted to values between ISO 100 and ISO 400. If the value currently selected by the user is between ISO 800 and ISO 3200, the camera will automatically set ISO sensitivity to ISO 400 (👉 P.92).

Custom Self-Timer

Set the shooting interval and the number of pictures when you want to shoot several pictures with the self-timer (👉 P.37).

Available Settings	Description
Pictures	Set this between one and ten pictures. The default setting is [2 Pics].
Interval	Set this between five and ten seconds. The default setting is [5 Sec.].



Note

- The camera takes pictures at the specified interval; the self-timer lamp blinks for two seconds before each shot. Focus is locked at the setting for the first shot in the sequence.
- Press the MENU button to cancel self-timer shooting.

Interval Shooting

You can set the camera to automatically take pictures at fixed intervals. You can set the shooting interval from five seconds to one hour in increments of five seconds.



Hours Minutes Seconds



Caution

- The interval shooting setting is cleared when the camera is turned off.
- The time until the next picture can be taken according to the shooting menu setting may be longer than the time set for interval shooting. If this is the case, the shooting interval becomes longer than the set time.



Note

- Depending on the remaining battery level, the battery may become depleted during interval shooting. Use of a battery with adequate remaining power is recommended.
- If you press the shutter release button during interval shooting, the camera shoots as usual.
- A high speed memory card or a SD memory card with sufficient memory is recommended.

Camera Shake Correction

Select [On] to reduce the effects of camera shake.



Caution

- The camera shake correction function cannot prevent movement of the shooting subject (caused by wind, etc.).
- Results vary with shooting conditions.



Note

The symbol appears when camera shake is likely to occur (P.19).

Slow Shutter Limit

The maximum shutter speed can be limited to the following: 1/8 second, 1/4 second, and 1/2 second. When this function is set to [Off], the maximum shutter speed varies depending on the ISO setting.



Note

- When time exposure is set, priority is given to time exposure.
- When scene mode is set to [Night. Port.] or [Night Landscape Multi-shot], the maximum shutter speed for [Night. Port.] or [Night Landscape Multi-shot] is given priority.
- When the flash is set to [Flash Synchro.], the longest shutter speed is one second.
- When using the slow shutter limit, the light quantity may be insufficient depending on the brightness of the subject, resulting in a dark image. In this case, try the following:
 - Selecting a greater slow shutter limit.
 - Raising the ISO setting (P.92).
 - Using the flash (P.35).

Date Imprint

You can insert the date (YY/MM/DD) or the date and time (YY/MM/DD hh:mm) at the lower right of a still image. Select [Off] to turn date imprint off.



Note

- Make the date and time settings in advance (P.29).
- [Date Imprint] cannot be used with movies.
- The date imprinted in an image cannot be deleted.

Exposure Compensation P.90

Choose exposure compensation.

White Balance P.91

Adjust the white balance.

ISO Setting P.92

Adjust ISO sensitivity.

Maximum ISO for ISO Auto

Select the maximum value chosen by the camera when [Auto] is selected for [ISO Setting]. Use to prevent ISO sensitivity from being raised too high.

Restore Defaults

Select [Yes] and press the ADJ./OK button to restore shooting menu settings to their default values.

Focus

Subject Tracking AF

When you press the shutter-release button halfway, the camera will focus on the subject in the focus frame at the center of the monitor and a green target icon will be displayed (the target icon will be displayed in red if the camera is unable to locate a subject to track). The camera will track the subject while the shutter-release button is pressed halfway (if the subject leaves the frame, the target icon will blink red and tracking will end). Tracking ends automatically when you remove your finger from the shutter-release button or a picture is taken.

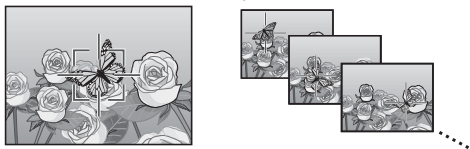

Caution



The camera may be unable to track subjects that are fast moving or poorly lit.

5

Multi-Target AF

When you half-press the shutter release button, the camera automatically determines multiple focus positions. When you then press the shutter release button all the way down, the camera shifts among the different focus positions, taking five consecutive pictures. The five still images are grouped together as a set and are recorded as an MP file. This function is especially useful for telephoto shooting and shooting with macro mode.



A  icon will be displayed if the camera is able to focus. If the camera is unable to focus, the  icon will blink. The focus positions selected by the camera are only displayed during playback ( P.74).

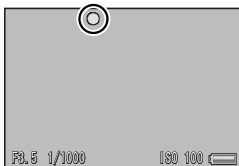



MP file

MP is a file format for recording a set of still images.



Caution

- The flash cannot be used.
- The [Time Exposure] setting is disabled (👉 P.82).
- The camera shake correction function cannot be used. If [Multi-trgt AF] is set while the camera shake correction function is turned on, (👉) changes to (👉).



Note

- If this function is turned on when using the digital zoom, the digital zoom is disabled and shooting is performed at the maximum magnification for the optical zoom (10.7×).
- [White Balance] functions according to the [Auto] setting even if it is set to [Multi-P AUTO].

Manual Focus (MF)

Manual focus (MF) can be used to focus at a selected distance when the camera is unable to focus using autofocus. A focus bar is displayed in the picture display.



5

Shooting Menu

1 Press and hold the ADJ./OK button as required.

- Pressing and holding the ADJ./OK button increases the magnification only at the center of the screen.
- Pressing and holding the ADJ./OK button again returns from enlarged view to normal view.

2 Adjust the zoom position with the zoom lever as required.

3 Push the ADJ./OK button ▲▼ to adjust the focus.

- Pushing the ADJ./OK button ▲ adjusts the focus to farther objects and pushing the ADJ./OK button ▼ adjusts the focus to closer objects.

4 Press the shutter release button to shoot the picture.



Note

You can also use manual focus to focus on objects within the macro shooting range.

Auto Bracketing

Choose the type of bracketing performed.



Note

Assigning [AT-BKT], [WB-BKT], [CL-BKT], or [FOCUS-BKT] to the Fn (Function) button with [Set Fn Button] allows you to switch between on and off by pressing the Fn button (👉 P.55).

Auto Bracket

If [On] is selected, the camera will take three photos each time the shutter-release button is pressed: one underexposed by 0.5 EV, a second at current exposure settings, and a third overexposed by 0.5 EV.

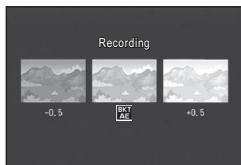

An icon is displayed when [On] is selected.



Note

- The exposure compensation can be changed using the shooting menu (👉 P.90).
- [White Balance] functions according to the [Auto] setting even if it is set to [Multi-P AUTO].

5

Shooting Menu

White Balance Bracketing (WB-BKT)

The white balance bracket function automatically records three images—a reddish image, a bluish image, and an image of the current white balance.

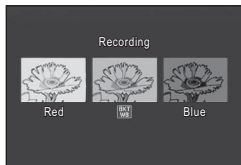

An icon is displayed when [WB-BKT] is selected.



Note

- The white balance can be changed using the shooting menu (👉 P.91).
- If [Image Settings] is set to [Black & White] or [Sepia], the white balance bracket function can be set but it does not operate.

Color Bracketing (CL-BKT)

With color bracketing, three images, a black-and-white, a color, and a sepia image, are recorded.

An icon is displayed when [CL-BKT] is selected.

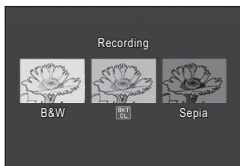



Contrast, Sharpness and Vividness During Color Bracket Shooting -----

During color bracket shooting, the contrast, sharpness, and vividness values set in [Image Settings] are applied. However, the values for [Standard] in [Image Settings] are applied when [Image Settings] is set to [Black & White] or [Sepia].

Focus Bracketing (FOCUS-BKT)

Choose this option to automatically vary focus by a selected amount over a series of five photographs.

- 1** Select [FOCUS-BKT] and push the ADJ./OK button .
- 2** Push the ADJ./OK button  to choose the focus interval and then press the ADJ./OK button twice.
 - The symbol appears on the screen.
- 3** Half-press the shutter release button.
 - The camera focuses according to the [Focus] setting.
- 4** Press the shutter release button all the way down.
 - The camera takes five consecutive pictures based on the focus position in Step 3.

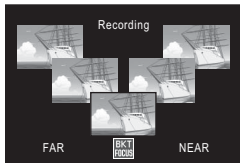



Note

- When [Focus] is set to [MF], the first picture is taken at the set focus position without being measured.
- [White Balance] functions according to the [Auto] setting even if it is set to [Multi-P AUTO].
- Photographs are taken and recorded in the following order:

Focus position	Fore	←	Center*	→	Back
Shooting order	5	4	1	3	2
Recording order	5	4	3	2	1

* Focus set using the option currently selected for [Focus] (P.80).

Exposure Compensation

Use exposure compensation to vary exposure from the value selected by the camera. Choose from values between -2 and $+2$; negative values produce darker pictures, positive values brighter pictures. Exposure compensation may be required in the following situations:

For backlighting

When the background is particularly bright, the subject will appear dark (underexposed). In this case, set the exposure level higher (+).

When your subject is whitish

The entire picture will turn out dark (underexposed). Set the exposure level higher (+).

When your subject is darkish

The entire picture will turn out bright (overexposed). Set the exposure level lower (-). The same happens when you take a photo of a subject in a spotlight.

Push the ADJ./OK button ▲▼ to choose a exposure value and press the ADJ./OK button. The selected value is displayed in the picture display.



Note

[! AE] is displayed if the subject is too bright or too dark for exposure compensation.

White Balance

Adjust the white balance so that a white subject will appear white. At purchase, the white balance mode is set to [Multi-P AUTO]. Change the setting in situations where the white balance is difficult to adjust effectively, such as when shooting an object of a single color or when shooting under multiple light sources.

AUTO

Auto

Adjusts the white balance automatically.



Multi-P AUTO

The camera automatically selects the optimal white balance according to the conditions of sun and shade or the flash illumination range.



Outdoors

Select this when shooting outdoors (sunny) and white balance fails to adjust properly.



Cloudy

Select this when shooting in cloudy weather or shade and the white balance fails to adjust properly.



Incandescent 1

Select this when shooting under incandescent light and white balance fails to adjust properly.



Incandescent 2

Select this when shooting under incandescent light (more reddish, compared with [Incandescent 1]).



Fluorescent

Select this when shooting under fluorescent light and white balance fails to adjust properly.



Manual

Adjust the white balance manually.

5

Shooting Menu



Note-----

- The white balance may not be adjusted correctly for a subject that is mostly dark. In this case, add something white to the subject.
- When shooting with the flash, the white balance may not be adjusted correctly if [Auto] is not selected. In this case, switch to [Auto] to shoot with the flash.

Manual

- 1 Select [Manual].
- 2 Frame a piece of paper or other white object under the lighting that will be used in the final photograph and press DISP.
 - The white balance is set.
- 3 Press the ADJ./OK button.
 - The symbol appears on the screen.
 - The effect of the selected white balance setting can be previewed in the picture display. Repeat the above steps until the desired effect is achieved.



Note

To cancel [Manual], select a setting other than [Manual].

ISO Setting

ISO sensitivity indicates how sensitive film is to light. A greater value means higher sensitivity. High sensitivity is suitable for shooting an object in a dark place or a fast-moving object while minimizing blurring. When ISO setting is set to [Auto], the camera automatically changes the sensitivity according to the distance, brightness, zoom, macro settings, and picture quality/size. Choose settings other than [Auto] to fix ISO sensitivity at the selected value.

The upper limit for auto ISO sensitivity can be selected using the [Maximum ISO for ISO Auto] in the shooting menu (P.85). If ISO sensitivity is assigned to the ADJ./OK button (P.52), the upper limit for auto ISO sensitivity can be chosen by pressing the DISP. Button when [Auto] is selected.





Note

- When [Auto] is selected for ISO sensitivity, the camera will select an ISO sensitivity between 100 and the value selected for [Maximum ISO for ISO Auto].
- If the flash is set to [Auto], the flash will fire if optimal exposure can not be achieved at the sensitivity selected for [Maximum ISO for ISO Auto].
- Images shot with a higher sensitivity may appear grainy.
- When [Auto] is selected for ISO sensitivity, the ISO value displayed when the shutter release button is pressed halfway may in some instances (for example, when the flash is used) differ from the value selected when the shutter is released.

6 Playback Menu



The options in the playback menu can be used to perform a variety of operations on existing pictures. To display the playback menu, select playback mode and press the MENU button.

Using the Menu

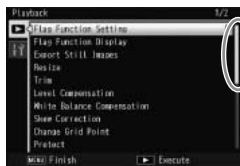
- 1 Press the  (Playback) button to select the playback mode.
- 2 Push the ADJ./OK button  to display the desired file.
 - For [Flag Function Display] ( P.94), [Slide Show] ( P.95), [Copy to Card from Internal Memory] ( P.95), or [Recover File] ( P.95), skip this step.
- 3 Press the MENU button.
 - The playback menu appears.



Indicates the range of displayed screens.

- 4 Push the ADJ./OK button  to select the desired item.
 - If the DISP. button is pressed at this point, the cursor moves to the playback menu tab.
 - Push the ADJ./OK button  at the bottom item to display the next screen.
- 5 Push the ADJ./OK button .
 - The screen for the selected menu item appears.

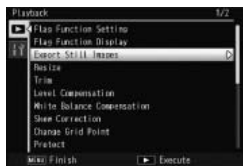

Playback Menu Options

Flag Function Setting

 P.96

Flag up to 20 files for quick access.

Flag Function Display

Displays images flagged with [Flag Function Setting]. Fn button can be used for the same purpose.



Note

The file set to [Flag Function Setting] with the smallest file number is displayed.













Export Still Images

 P.76

Export selected images from a MP file.

Resize

Create resized copies of photos or other still images produced with the camera.

Original	Resized
 4:3 F/  4:3 N/  3:2 F/  1:1 F/  16:9 F/	 4:3 F/  4:3 F
 4:3 F/  4:3 F/  4:3 F/  4:3 N	
 4:3 F	 4:3 F



Caution

Movies or MP files cannot be resized.

Trim

 P.97

This function allows you to trim a still image you have shot and then save it as a separate file.

Level Compensation

 P.100

Create copies of photographs with modified brightness and contrast.

White Balance Compensation

 P.102

Create copies of photographs with modified white balance.

Skew Correction

 P.103

Create copies that have been processed to reduce the effects of perspective on rectangular objects.

Change Grid Point

 P.60

Change grid settings for [Golf Swing Continuous Mode] in scene mode.

Protect



Protect images from accidental deletion.

Slide Show

You can display the recorded still images and movie files sequentially on the screen.



Note

- Each still image is displayed for three seconds.
- For movies and MP files, all the images you shot are played back.

Copy to Card from Internal Memory

Copy all data from internal memory to a memory card in a single operation.



Note

- If there is not enough space available on the destination memory card, a warning will be displayed. Select [Yes] to copy only those files for which there is sufficient space.
- It is not possible to copy the contents of an SD memory card to the internal memory.
- When the contents of the internal memory are copied to an SD memory card, the files saved to [Flag Function Setting] in the internal memory are canceled.

DPOF



Select pictures for printing.

Recover File

Restore deleted files.



Caution

Deleted files cannot be restored after performing any of the following operations.

- Turning the camera off
- Switching from playback mode to shooting mode
- Using DPOF, Resize, Copy to Card from Internal Memory, Skew Correction, Level Compensation, White Balance Compensation or Trim
- Files with DPOF settings are deleted
- Internal memory or SD memory card is initialized
- Setting or canceling files for [Flag Function Setting]
- Changing the magnification ratio or magnified area of files for [Flag Function Setting]
- Exporting MP files using [Export Still Images]

Flag Function Setting

Flag images for quick access during playback. Flagged images can be displayed by pressing the Fn button.

Setting/Canceling One File at a Time

To flag or remove flag marking from the current image, select [Flag Function Setting] in single-image playback. Flagged files are indicated by an icon.



Note

If an enlarged still image is set, the magnification ratio and magnified area are saved and the enlarged image can be displayed as is.

Setting/Canceling Multiple Files at One Time

To flag or remove flag marking from multiple selected images, select [Flag Function Setting] in thumbnail view, highlight images, and press the ADJ./OK button to add or remove flag marking. Press DISP. when the operation is complete.

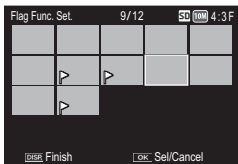

Caution

- If the name of the file set to [Flag Function Setting] is changed using a computer, the file is canceled from [Flag Function Setting].
- Copying images from internal memory to a memory card removes flag marking from the images in internal memory.
- When a file in an SD memory card is set to [Flag Function Setting], [CLIPINFO] folder and CLIPCLI file are created on the SD memory card. If these are deleted, the corresponding file is canceled from [Flag Function Setting].
- If the name of an image file is changed using a computer, the file may not be able to be set to [Flag Function Setting].
- Only images taken using this camera can be set to [Flag Function Setting].

Trim

Create a cropped copy of the current photograph.

Turn the zoom lever toward \times or \square to adjust the crop size and push the ADJ./OK button \blacktriangle \blacktriangledown \blacklozenge \blackleftarrow to position the crop.





Press the ADJ./OK button to save the cropped image to a separate file.

Caution-----

- You can only trim still images shot using this camera.
- You cannot trim movies or MP files.
- While you can trim an image repeatedly, the image is recompressed each time and there will be some decline in image quality.

Note-----

- To cancel, press the DISP. button.
- To view help, press the Fn button while the crop display is shown in the picture display. Press the Fn button again to exit help.
- To choose the aspect ratio, press the  button in the crop display. Choose from aspect ratios of 4 : 3 and 1 : 1. Aspect ratios of 3 : 2 and 16 : 9 are not supported.
- If an image is trimmed, the compression ratio changes to Fine.
- The available settings for the trimming frame size differ depending on the original image size.

- The size of the image after cropping depends on the size of the original and the size of the crop (the first crop shown in the trimming display is the second largest crop; to display the largest crop, select  with the zoom lever).

Aspect ratio 4 : 3

Original image size	Trimming level	Trimmed image size
10M 4 : 3 F / 10M 4 : 3 N (3648 × 2736)	1	3072 × 2304
	2, 3	2592 × 1944
	4 to 6	2048 × 1536
	7 to 9	1280 × 960
	10 to 13	640 × 480
9M 3 : 2 F (3648 × 2432)	1	3072 × 2304
	2, 3	2592 × 1944
	4 to 6	2048 × 1536
	7 to 9	1280 × 960
	10 to 13	640 × 480
7M 1 : 1 F (2736 × 2736)	1, 2	2592 × 1944
	3 to 5	2048 × 1536
	6 to 8	1280 × 960
	9 to 12	640 × 480
7M 16 : 9 F (3648 × 2048)	1, 2	2592 × 1944
	3 to 5	2048 × 1536
	6 to 8	1280 × 960
	9 to 12	640 × 480
5M 4 : 3 F (2592 × 1944)	1	2592 × 1944
	2, 3	2048 × 1536
	4 to 7	1280 × 960
	8 to 12	640 × 480
3M 4 : 3 F (2048 × 1536)	1, 2	2048 × 1536
	3 to 6	1280 × 960
	7 to 10	640 × 480
2M 4 : 3 F / 2M 4 : 3 N (1728 × 1296)	1	1728 × 1296
	2 to 5	1280 × 960
	6 to 9	640 × 480
1M 4 : 3 F (1280 × 960)	1 to 3	1280 × 960
	4 to 8	640 × 480
VGA 4 : 3 F / VGA 4 : 3 N (640 × 480)	1 to 4	640 × 480

Aspect ratio 1 : 1

Original image size	Trimming level	Trimmed image size
10M 4 : 3 F / 10M 4 : 3 N (3648 × 2736)	1 to 3	2304 × 2304
	4 to 6	1536 × 1536
	7 to 9	960 × 960
	10 to 13	480 × 480
9M 3 : 2 F (3648 × 2432)	1, 2	2304 × 2304
	3 to 5	1536 × 1536
	6 to 9	960 × 960
	10 to 13	480 × 480
7M 1 : 1 F (2736 × 2736)	1 to 3	2304 × 2304
	4 to 6	1536 × 1536
	7 to 9	960 × 960
	10 to 13	480 × 480
7M 16 : 9 F (3648 × 2048)	1 to 3	1536 × 1536
	4 to 7	960 × 960
	8 to 11	480 × 480
5M 4 : 3 F (2592 × 1944)	1 to 3	1536 × 1536
	4 to 7	960 × 960
	8 to 11	480 × 480
3M 4 : 3 F (2048 × 1536)	1, 2	1536 × 1536
	3 to 6	960 × 960
	7 to 10	480 × 480
2M 4 : 3 F / 2M 4 : 3 N (1728 × 1296)	1 to 4	960 × 960
	5 to 8	480 × 480
1M 4 : 3 F (1280 × 960)	1 to 3	960 × 960
	4 to 8	480 × 480
VGA 4 : 3 F / VGA 4 : 3 N (640 × 480)	1 to 4	480 × 480

Level Compensation

Create copies that have been processed to adjust brightness and contrast.

Correcting Images Automatically

Select [Auto] and push the ADJ./OK button . A preview will be displayed with the original image at upper left and the corrected copy on the right.

Press the ADJ./OK button to copy the image.

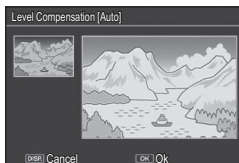

Correcting Images Manually

Select [Manual] and push the ADJ./OK button . A preview will be displayed with the original image at upper left, a histogram and black-, mid-, and white-point controls at lower left, and the corrected copy on the right.

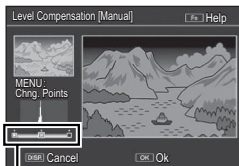

Control points

Press MENU to cycle through the control points and push the ADJ./OK button to position the selected point for enhanced brightness and contrast as described below.

Point	Effect
Black point	If the image is overexposed, move the black point to the right until it lines up with the darkest pixel in the histogram.
Mid-point	To make the image brighter, move the mid-point to the right. Moving the mid-point to the left makes the image darker.
White point	If the image is underexposed, move the white point to the left until it lines up with the brightest pixel.

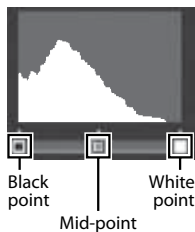

- To increase contrast, align the black point and white point with the darkest and brightest pixels.
- For help, press the Fn button; press the button again to return to the preview display.

Press the ADJ./OK button to create the corrected copy.



Caution-----

- If the camera can not create a corrected copy, an error message will be displayed and the camera will exit to the playback menu.
- To cancel level compensation, press the DISP. button.
- You can only use level compensation for still images shot using this camera.
- You cannot use level compensation for movies or MP files.
- This function may not have any effect for images shot using [Text Mode] in scene mode, or images shot when [Image Settings] is set to [Black & White] or [Sepia].
- While you can use level compensation repeatedly, the image is recompressed each time and there will be some decline in image quality.

White Balance Compensation

Create copies with modified white balance.

A preview will be displayed with the original image at upper left, white balance controls at lower left, and the corrected copy on the right. Push the ADJ./OK button  to adjust white balance on the **Green-Magenta** and **Blue-Amber** axes.

Press the ADJ./OK button in to record the modified copy.

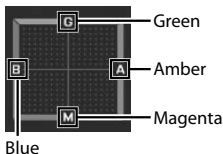
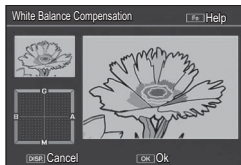

Caution

- You can only use white balance compensation for still images shot using this camera.
- You cannot correct the white balance for movies or MP files.
- This function may not have any effect for images shot using [Text Mode] in scene mode, or images shot when [Image Settings] is set to [Black & White] or [Sepia].
- While you can use white balance compensation repeatedly, the image is recompressed each time and there will be some decline in image quality.

Note

- To cancel, press the DISP. button.
- Press the  button to reset white balance.
- For help, press the Fn button; press the button again to return to the preview display.

Skew Correction

Create copies that have been processed to reduce the effects of perspective on rectangular objects, such as message boards or business cards.

Caution

- You can only use skew correction for still images shot with this camera.
- You cannot use skew correction for movies or MP files.

Note















- If the camera is able to detect an object that can be used to correct perspective, a message will be displayed with the object shown by an orange frame. The camera can detect up to five objects.
- If the target area cannot be detected, an error message appears. The original image remains unchanged.
- To select another correction area, move the orange frame to the target area by pushing the ADJ./OK button .
- To cancel skew correction, push the ADJ./OK button . Even if you cancel skew correction, the original image remains unchanged.
- The image size does not change for skew corrected images.
- The time for skew correction increases with image size. To reduce the time required, perform skew correction on small copies created with the [Resize] option ( P.94).
- The following table shows the approximate time required for skew correction.

Image Size	Correction time	Image Size	Correction time
 4 : 3 F	Approx. 23 seconds	 4 : 3 F	Approx. 12 seconds
 4 : 3 N	Approx. 22 seconds	 4 : 3 F	Approx. 8 seconds
 3 : 2 F	Approx. 17 seconds	 4 : 3 F	Approx. 3 seconds
 1 : 1 F	Approx. 13 seconds	 4 : 3 F	Approx. 1 seconds
 16 : 9 F	Approx. 13 seconds		

- When scene mode is set to [Skew Correct Mode], you can shoot an image and then immediately correct any skew in the image ( P.63).

Protect

[Protect] allows you to protect files from being accidentally deleted.

If [1 File] is selected, you can protect or unprotect the file selected by pushing the ADJ./OK button .

If [Select All] or [Cancel All] is selected, you can protect or unprotect all files.

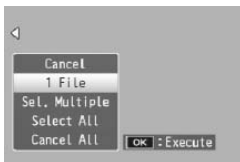

Selecting Multiple Files

Select [Sel. Multiple] to change the protect status of multiple individual files or of all files in a selected range.

To select multiple individual frames:

- 1 Select [Sel. Individ.] and press the ADJ./OK button.
- 2 Select a frame and press the ADJ./OK button.
 - Press the MENU button to switch to the display for specifying a range of files.
 - If you selected a file by mistake, you can deselect it by selecting the file and pressing the ADJ./OK button.
 - Select all files you want to protect.
- 3 Press the Fn button.

To select two frames and all frames between them:

- 1 Select [Sel. Range] and press the ADJ./OK button.
- 2 Select the first frame and press the ADJ./OK button.
 - Press the MENU button to switch to the display for specifying files separately.
 - If you make a mistake when selecting the starting point for the range of files, press the DISP. button to return to the screen for selecting the starting point.

3 Select the last frame and press the ADJ./OK button.

- Repeat Steps 2 and 3 to select multiple ranges.

4 Press the Fn button.

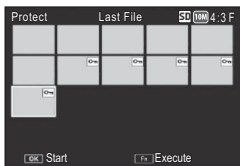

Note-----

[Sel. Individ.] and [Sel. Range] can be selected directly if [Protect] is chosen in thumbnail view.

Caution-----

Note that formatting deletes all files, including protected files.

DPOF

To request professional prints of the photographs on a memory card, first use this option to create a digital “print order” listing the photos you wish to print and the number of prints, and then take the memory card to a digital print service center that supports the DPOF standard.

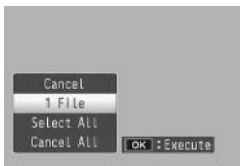



To add a photo to or remove it from the print order, select [1 File] and push the ADJ./OK button  to display the desired file.

Select [Select All] to add all photos to the print order, or [Cancel All] to remove all files from the print order.

Selecting Multiple Files

To change the print status of multiple individual files, select [DPOF] in thumbnail view.

Select photos and push the ADJ./OK button  to choose the number of prints; push the ADJ./OK button  to increase the number of copies, or push the ADJ./OK button  to decrease the number of copies.

Press the ADJ./OK button to exit when settings are complete.



Note

To remove the DPOF settings for multiple still images, follow the same steps described above to set the number of copies to print to [0] for each image, and then press the ADJ./OK button.

Viewing Pictures on TV

To view pictures on a TV, connect the camera using the supplied AV cable.

1 Securely connect the AV cable to the Video In terminal on the television.

- Connect the white plug of the AV cable to the audio input terminal (white) of the TV unit and the yellow plug to the video input terminal (yellow).

Video Input Terminal (yellow)

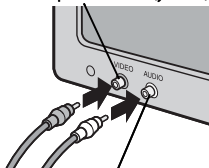

2 Turn the camera off and securely connect the cable to the common terminal for USB port/AV output (gray) of the camera.

Audio Input Terminal (white)

3 Set the television to Video mode (Set the input to Video).

- For details, see the documentation that came with the television.

4 Press the POWER button, or press and hold the  (Playback) button to turn the camera on.

⚠ Caution-----

- Always connect the dedicated cable to the common terminal for USB port/AV output and the HDMI micro output terminal respectively. Using other cables to connect or connecting to the terminal other than specified can result in malfunction.
- When the AV cable is connected to the camera, the picture display and the speaker output turn off.
- Do not force the AV cable into the terminal.
- Do not apply excessive force with the AV cable connected.
- When using the AV cable, do not move the camera with the AV cable.



Note

- You can connect the AV cable to the Video In terminal on your video recorder and record what you have shot to a video recorder.
- The camera supports the following video standards: NTSC and PAL. Where possible, the camera is set to the standard used in your country or region before shipment; before connecting the camera to a device that uses a different video standard, choose the appropriate video mode (☞ P.114).
- The camera body can be connected to TVs that support HDMI using an HDMI cable (optional). See the documentation provided with TVs for details.
- If connecting or disconnecting the HDMI cable in multi-frame views of the playback mode, the display switches to single frame view. When the menu is displayed, it will not switch to single-frame view even if connecting or disconnecting the HDMI cable.
- When connecting the camera body to a TV using a HDMI cable, the operational sounds turn off.
- The resolution for HDMI output is set to [AUTO]. If the video resolution actually shown on the display is low, change the [HDMI Output] settings in the setup menu (☞ P.114).

7 Setup Menu

You can change the camera settings by displaying the setup menu from the shooting menu (👉 P.78) or playback menu (👉 P.93).

Using the Menu

- 1 Press the MENU button.**
 - The shooting menu (or the playback menu) appears.
- 2 Push the ADJ./OK button 🍃.**
- 3 Push the ADJ./OK button ▼.**
 - The setup menu appears.
 - In scene, continuous, or creative shooting mode, push the button ▼ twice.
- 4 Push the ADJ./OK button ⚡.**
- 5 Push the ADJ./OK button ▲▼ to select the desired item.**
 - If the DISP. button is pressed at this point, the display returns to the screen shown in Step 3.
 - Push the ADJ./OK button ▼ at the bottom item to display the next screen.
- 6 Push the ADJ./OK button ⚡.**
 - The menu item settings are displayed.
- 7 Push the ADJ./OK button ▲▼ to select the setting.**

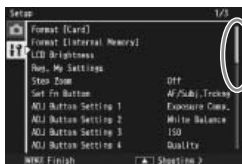

Indicates the range of displayed screens.

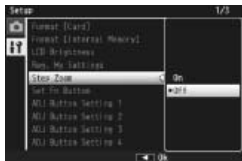
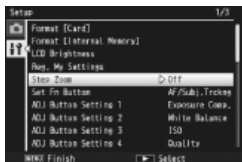

8 Press the ADJ./OK button.

- The setup menu disappears and the camera is ready for shooting or playback.
- The setup menu may appear depending on the setting. In this case, press the MENU button or the ADJ./OK button to return to the shooting or playback screen.
- Pushing the ADJ./OK button  in Step 8 confirms the setting and the display returns to the screen shown in Step 5.



Note

For some functions, the setting selection method may differ from what is explained here. For detailed operation, see the explanation of each function.

Setup Menu Options

Format [Card]

Select [Yes] and press the Fn button to format the memory card.



Caution

When using Eye-Fi cards, install the software in the Eye-Fi card to your computer and then format the card.

Format [Internal Memory]

Select [Yes] and press the Fn button to format internal memory. If you have images in the internal memory that you do not want to delete, copy the images to the SD memory card before formatting the internal memory ( P.95).

LCD Brightness

Push the ADJ./OK button   to adjust the brightness of the picture display.

Reg. My Settings P.115

Save current camera settings.

Step Zoom

Select [On] to allow optical zoom to be adjusted in eight discrete steps that on a 35-mm camera would be equivalent to focal lengths of 28 mm, 35 mm, 50 mm, 85 mm, 105 mm, 135 mm, 200 mm, and 300 mm; select [On] to allow super resolution zoom to be adjusted in two discrete steps that on a 35-mm camera would be equivalent to focal lengths of 450 mm, and 600 mm. In macro mode, the step zoom focal lengths are roughly equivalent to 31, 35, 50, 85, 105, 135, 200 and 300 mm on a 35-mm camera.

Set Fn Button P.56

Choose the role performed by the Fn button.

ADJ Button Setting 1–4



Choose the role performed by the ADJ./OK button.

AF Auxiliary Light

If [On] is selected, the AF auxiliary light will light to assist autofocus.

Operation Sounds

Choose the sounds made by the camera.

Available Settings	Description
All	All sounds on.
Level Sound	Only the level sound is emitted.
Shutter Sounds	Only the shutter sound and level sound are emitted.



Note

- If you try to perform an operation that cannot be performed, the beep sound is emitted regardless of the [Operation Sounds] setting.
- Regardless of the option selected, no sound is emitted when [Discreet Mode] or [Pets] is selected in scene mode.

Volume Settings

The operation sound volume can be changed.



Note

- When [Volume Settings] is set to [□□□] (Mute), the level sound is not emitted even when [Level Setting] is set to [Display+Sound] or [Sound].
- Regardless of the option selected, no sound is emitted when [Discreet Mode] or [Pets] is selected in scene mode.

LCD Confirmation Time

Choose how long photos are displayed after shooting. Choose [Hold] to display photos until the shutter release button is pressed halfway. Photos displayed after shooting can be viewed using zoom (P.41) or deleted (P.42). Depending on the option selected for [Noise Reduction] (P.82), photos may be displayed longer than the time selected.

Auto Power Off

Choose how long the camera remains on when no operations are performed. The camera will not turn off automatically if [Off] is selected, during interval timer photography (P.83), or when the camera is connected to a computer or printer, or while transferring images using Eye-Fi cards.

LCD Auto Dim

If [On] is selected, the picture display will automatically dim to save power if no operations are performed for about five seconds. This feature is not available in synchro-monitor mode (👉 P.45) or sleep mode (👉 P.114).

Digital Zoom Image

👉 P.117

Choose [Auto Resize] to record pictures taken with digital zoom at actual size, [Normal] to enlarge image data from the center of the frame using both the digital zoom and the super resolution zoom.

Level Setting

👉 P.48

Adjust level indicator and level sound settings.

Grid Guide Display Options

👉 P.45

Choose the type of framing grid available in shooting mode.

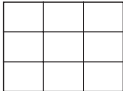
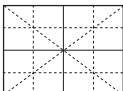
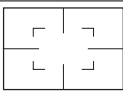
Available Settings	Description
	A three-by-three grid for "rule of thirds" composition.
	A four-by-four grid with diagonal lines running from corner to corner makes it easy to find the center of the subject. Use for architectural photography or photographing products for display.
	A two-by-two grid with the center of the frame left clear to make it easier to view the subject. Use if your subject is in motion.

Function Guide

If [On] is selected, help will be displayed when you turn the mode dial or use controls such as the ⚡ (flash), 📷 (macro), and ⌚ (self-timer) buttons.

Shooting Info. Display Frame

Select [On] to display shooting icons in a frame surrounding the view through the lens (👉 P.45). Shooting information display frame cannot be used in movie mode.

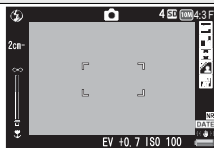

Minimum Distance

Select [Show] to display the minimum focus distance for the current zoom position. The minimum focus distance is not displayed in scene auto mode.

Auto Rotate

Select [On] to automatically display pictures in the correct orientation during playback.

White Saturation Display

 P.47

If [On] is selected, highlights can be viewed in playback mode by pressing the DISP. button.

Card Sequence No.

When you switch SD memory cards, you can set your camera to continue consecutive numbering from the previously loaded card.

Available Settings	Description
On (Continue numbering)	Files names consist of "R" followed by a seven-digit number (e.g., "R0010001.jpg"), assigned in ascending order from 0010001 to 9999999. When a new memory card is inserted, file numbering continues from the last number used.
Off (Do not continue numbering)	File numbering is assigned, from RIMG0001.jpg to RIMG9999.jpg, for each SD memory card. When the file name reaches RIMG9999, no more data can be recorded to that card.



Note

- This option applies only to memory cards. The names of photos in internal memory consist of "RIMG" and a four-digit number.
- When images are transferred to a computer using DL-10 ( P.128), the file being transferred is renamed and saved.



Caution

When the file name reaches RIMG9999 or R9999999, no more files can be saved. In this case, move image data from the SD memory card to the memory of the computer or a storage medium, and then format the SD memory card.

USB Connection Type

Choose a connection type ([Mass Storage] or [PTP]) before connecting the camera to other devices via USB.

Date Settings P.29

Set the camera clock.

**Note**

- If the battery is removed for more than one week, the date and time settings will be lost. These settings must be made again.
- To retain the date and time settings, load a battery with adequate remaining power for more than two hours.

Language/言語*1 P.29

You can change the language displayed on the screen.

Video Out Mode*1

You can view your still images and movies on a television screen by connecting your camera to a television with the AV cable that came with your camera. Select from NTSC (used in North America, the Caribbean, parts of Latin America, and some East Asian countries) and PAL (used in the United Kingdom and much of Europe, Australia, New Zealand, and parts of Asia and Africa). SECAM is not supported.

HDMI Output

You can select the resolution from [AUTO], [1080i], [720p], and [480p] for video output using the optional HDMI cable. For normal use, choose the [AUTO] option. If the video resolution actually shown on the display is low with the [AUTO] option, choose [1080i] or [720p] to achieve the better possible quality.

Sleep Mode

Choose how long the picture display remains lighted before it will automatically dim to save power. This feature is not available during the connection using AV cable or HDMI cable.

**Note**

With Sleep Mode set, [LCD Auto Dim] option is not available.

Confirm Firmware Version

Display the firmware version of the camera. When the SD memory card contains the file for updating the firmware, the camera rewrites the program.

Eye-Fi Connection Settings*2

When using the SD memory card with wireless LAN function built-in (i.e., Eye-Fi card), the [On] option turns wireless LAN function on; the [Off] option turns wireless LAN function off and the SD memory card can be used without wireless LAN function. For more information on wireless LAN settings or Eye-Fi cards, please check the user manual, etc. for the devices using Eye-Fi cards.

Eye-Fi Connection Display*2

When the Eye-Fi card is in use, display the destination SSID.

*1 The default setting varies depending on where you purchased the camera.

*2 These settings are only displayed when using Eye-Fi card.

Reg. My Settings

Save current camera settings in [MY1] or [MY2]. Settings saved in [MY1] are recalled when the mode dial is rotated to **MY1**, those saved in [MY2] when the mode dial is rotated to **MY2**.

- 1 Set the camera to the desired settings.**
- 2 Select [Reg. My Settings] in the setup menu (P.109) and push the ADJ./OK button .**
 - A confirmation message appears.
- 3 Select [MY1] or [MY2] and press the ADJ./OK button.**
 - The current camera settings are registered and the display returns to the setup menu.
 - If you do not want to register them, press the DISP. button.

Settings Saved in [Reg. My Settings]

Shooting mode (scene auto mode excluded)	Time Exposure
Focus position for manual focus	Custom Self-Timer
Dynamic Range Expansion	Camera Shake Correction
Soft Focus Options	Slow Shutter Limit
Hue	Date Imprint
Vignetting	Exposure Compensation
Toy Color	White Balance
Plus Normal Shooting	ISO Setting
Picture Quality/Size	Step Zoom
Density	Digital Zoom Image
Pre-AF	Level Setting
Focus	Grid Guide Display Options
Exposure Metering	Function Guide
Image Settings	Shooting Info. Display Frame
Super Resolution	Minimum Distance
Noise Reduction	USB Connection Type
Flash Exposure Compensation	Zoom position
Auto Bracket	Macro
WB-BKT	Flash Mode
CL-BKT	Self-Timer
FOCUS-BKT	DISP. mode

Exposure Time ([Fireworks] in scene mode)

Grid Settings Value ([Golf Swing Continuous Mode] in scene mode)

Brightness/Color ([Cooking] in scene mode)

Digital Zoom Image

If [Normal] (the default option) is selected for [Digital Zoom Image], digital zoom will enlarge image data from the center of the frame to create a picture at the current image size, creating a slightly grainy image. To record pictures taken with digital zoom at actual size, select [Auto Resize]. The size at which the image will be recorded varies with the zoom ratio.

To use auto resize zoom, hold the zoom lever at **[▲]** (Telephoto) until the camera is zoomed all the way in, then briefly release the zoom lever and turn it to **[▲]** again.

Image size changes each time the zoom lever is turned to **[▲]**. The current size is displayed above the zoom bar.

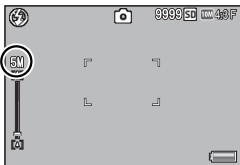

The auto resize zoom is enabled when **10M** 4 : 3 F or **10M** 4 : 3 N is selected for [Picture Quality/Size] (P.79), and the digital zoom is enabled in other cases.

Zoom Magnification and Recorded Image Size

Picture Quality/Size	Zoom Magnification	Focal Length*
10M 4 : 3 F / 10M 4 : 3 N	1.0×	300 mm
5M 4 : 3 F	1.4×	420 mm
3M 4 : 3 F	1.8×	530 mm
1M 4 : 3 F	2.9×	850 mm
VGA 4 : 3 F	5.7×	1710 mm

* Equivalent to that on a 35 mm camera



Caution

- [Auto Resize] has no effect when [Skew Correct Mode] is selected in scene mode or [Toy Camera] is selected in creative shooting mode.
- Fine picture quality is used for all photographs recorded using [Auto Resize], regardless of the option currently selected for [Picture Quality/Size].

8 Direct Printing

About the Direct Print Function

The Direct Print standard enables direct printing from a camera to a printer by connecting them via a USB cable. Photos can be printed quickly and easily from your digital camera without using a computer.



Caution

You cannot print AVI files (movies) or MP files with this function.



Note

- This camera uses PictBridge, an industry standard for Direct Printing.
- Your printer must be compatible with PictBridge to use the Direct Print function. For support information, see the documentation that came with the printer.

Connecting the Camera to a Printer

Connect your camera to a printer using the USB cable provided.

1 Make sure that the camera power is off.

2 Connect the common terminal for USB port/AV output of your camera (gray) to a printer using the USB cable provided.

- Turn on the printer if it is not already on.
- Your camera turns on automatically.

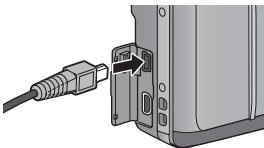

Caution

- Do not force the USB cable into the terminal, or apply excessive force with the USB cable connected. Also, when using the USB cable, do not move the camera with the USB cable.
- Do not disconnect the USB cable with the camera power on.
- Do not connect other cable other than the USB cable provided.

Printing Still Images

You can print still images from the camera with a PictBridge-compatible printer. If a memory card is inserted, the pictures will be printed from the memory card; otherwise pictures will be printed from internal memory.

⚠ **Caution**

After making sure that the printing completes and the camera turns off, disconnect the USB cable to end the connection between the camera and the printer.

📌 **Note**

- If a [Printer error.] message appears during image transfer, check the printer status and take the appropriate action.
- If a computer connection message appears even though the camera is connected to the printer, reconnect the camera and press the ADJ./OK button within two seconds.
- Before connecting to some printers, you may need to select [PTP] for [USB Connection Type] (👉 P.113) in the setup menu (👉 P.109).

Before printing, connect the camera to the printer. The message [Connecting...] shown at right will be displayed if the printer is ready; press ADJ./OK to view the Direct Print playback display.



Printing One or All Still Images

- 1** Select an image for printing and press the ADJ./OK button.
- 2** Select [1 File] or [All Files] and press the ADJ./OK button.
 - The Direct Print menu appears.

3 Select an item and push the ADJ./OK button to view the options available.

- When [Connecting...] is displayed, the connection to the printer is not yet established. When a connection is established, [Connecting...] disappears and [Direct Print] appears. Proceed with this step after the connection is established.
- The following items can be selected. Each item is available only when supported by the printer connected to the camera.

Item Name	Description
Paper Size	Sets the paper size.
Paper Type	Sets the paper type.
Layout	Sets the number of images printed on a sheet of paper. The number of images that can be laid out on a sheet of paper varies depending on the connected printer.
Date Print	Selects whether to print the date (shooting date). The date format can be set using the date/time option in the setup menu. If the picture was taken using [Date Imprint] ( P.84), only the imprinted date will be printed.
File Name Print	Selects whether to print the file name.
Optimize Image	Selects whether to optimize the image data (still image) prior to printing on the printer.
Print Size	Sets the print image size.
Print Quality	Sets the print quality.
Report Print*	Prints on forms.
Printing Quantity	Sets the print quantity.
Toner Saving*	Selects whether to conserve toner by using less ink during printing.
1-Side/2-Sides*	Selects whether to print on both sides of the paper. During duplex printing, one copy is printed for each still image. Only one copy is printed even if you selected more than one copy to print in Step 3 on P.122.

* Each item is available only when supported by the Ricoh printer connected to the camera.



Note

- To specify the settings as the default settings next time the camera is connected to the printer, press the MENU button when the screen in Step 3 is displayed. Select [Yes] in the display at right and press the ADJ./OK button.
- To use the settings last set the next time the camera is connected to the printer, select [No].









4 Select an option and press the ADJ./OK button.

- The display returns to the Direct Print menu.
- Repeat Steps 3 and 4 to change other settings as required.



5 Press the ADJ./OK button.

- The selected still images are sent to the printer and the [Sending...] screen appears.
- Pressing the DISP. button cancels the operation.
- When the images have been sent to the printer, the display returns to the Direct Print playback mode screen and printing starts.

Printing Several Still Images

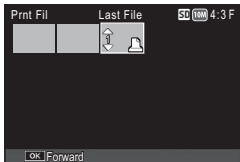
- 1 Turn the zoom lever toward  (Thumbnail View) to display the thumbnail view.
- 2 Select an image and press the ADJ./OK button.
- 3 Push the ADJ./OK button   to set the number of copies to print.
 - Push the ADJ./OK button  to increase the number of copies, or push the ADJ./OK button  to decrease the number of copies.
 - Repeat Steps 2 and 3 to select additional images.
- 4 Press the ADJ./OK button.
 - The Direct Print menu appears.
- 5 Select an item and push the ADJ./OK button  to view the options available.
 - See Steps 3 and following on P.120.



-  **Note**-----
- Only images with a printer symbol () are printed. If you cancel printing and then try to print again, make sure that the printer symbol is on the images you want to print.
 - The same still image can also be printed several times on a single sheet.
 - The available items vary depending on the functions of the printer.
 - To print images using the printer's default settings, select [Printer Select] on the detailed options screen.

9 Downloading Images to Your Computer

The screen images shown here may differ from the images displayed on your computer depending on your computer OS.

For Windows

You can copy pictures to your computer with or without DL-10 software, which is available in the internal memory of the camera. The following software are installed with the DL-10 installation.

Software	Description
DL-10	Downloads images collectively to your computer.
MediaBrowser	Display, manage, and edit existing images.

Caution-----

- Administrator privileges are required for installation.
- DL-10 is not network-compatible. Use as a stand-alone application.

System Requirements for Using the Built-in Software

The following environments are necessary for using the built-in software. Please check your computer, or the computer's user manual.

Operating Systems Supported	Windows XP Home Edition Service Pack 3/Professional Service Pack 3 Windows Vista Service Pack 2 Windows 7 (32- and 64-bit)
CPU	Pentium® IV: 1.6 GHz or faster Pentium® M: 1.4 GHz or faster Core™ 2 Duo: 1.5 GHz or faster
Memory	Windows XP: 512 MB or more Windows Vista/Windows 7: 1 GB or more
Hard drive space required for installation	300 MB or more
Display Resolution	1024 × 768 pixels or greater
Display Colors	65,000 colors or greater
USB Port	A USB port compatible with the above-mentioned computer

⚠ Caution-----

- Windows XP 64-bit and Windows Vista 64-bit are not supported.
- If your computer has an upgraded OS, the USB function may not work normally, so it will not be supported.
- The provided software may not operate properly if changes are made to the operating system, such as with patches and service package releases.
- The camera does not support connection to a USB port added by using an extension function (PCI bus or other).
- If used in conjunction with a hub or other USB devices, the software may not work properly.
- When dealing with movies and other large files, a larger memory environment is recommended.

Installing Software

Install the supplied software to your computer.

⚠ Caution-----

- Before proceeding, confirm that [Mass Storage] is selected for [USB Connection Type] (☞ P.113) in the setup menu (☞ P.109).
- If you install the DC Software 2 with the DC Software having been already installed, DL-10 for the DC Software 2 is added to the Start-up folder.

1 Turn the camera power off, and pull the SD memory card out of the camera.

- With SD memory card in the camera, the software cannot be installed.

2 Connect the supplied USB cable to the computer.

3 Connect the USB cable to the common terminal for USB port/ AV output of the camera (gray).

- The camera turns on automatically when a connection is established.
- [RICOHDCI(E:)] screen is displayed (E indicates the drive name).

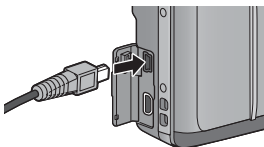

4 Click [Start the digital camera software installer], and then click the [OK] button.

- [Digital camera software installer] screen appears.

Windows 7

- Click [Open folder to view files] and double-click [AUTORUN.EXE] from the displayed files.

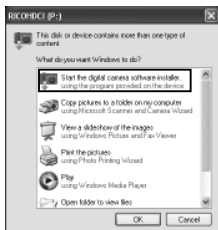

Use this button to install software required for batch downloading and editing of images.

Click this to display the Website for user registration.



5 Click [Installing the software].

Windows XP

- After a while, the [Choose Setup Language] screen appears.

Windows Vista/Windows 7

- If a [User Account Control] dialog is displayed, select [Yes] (Windows 7) or [Allow] (Windows Vista). If an icon appears on the task bar, click the icon to display the dialog. After a short pause, the [Choose Setup Language] dialog will be displayed.

6 Select a language and follow the on-screen instructions to complete installation.

- The MediaBrowser installer will start. To install MediaBrowser, accept the license agreement and follow the on-screen instructions.

7 Click [Unblock] for DL-10.

- For Windows 7, click [Allow access].

8 When a message appears asking you to restart your computer, select [Yes, I want to restart my computer now.] and then click [Finish].

- Your computer will restart automatically.
- After your computer restarts, a Windows security warning message appears.



Caution-----

- Do not force the USB cable into the terminal, or apply excessive force with the USB cable connected. Also, when using the USB cable, do not move the camera with the USB cable.
- Do not disconnect the USB cable with the camera power on.
- Do not connect other cable other than the USB cable provided.



Uninstalling the Software-----

- DC Software 2 and MediaBrowser can be uninstalled from [Control Panel] > [Programs and Features] (Windows 7 and Windows Vista; in category or home view, select [Control Panel] > [Programs] > [Uninstall a program]), or [Add or Remove Programs] (Windows XP).
- Administrator privileges are required.
- Quit any other programs that may be running before uninstalling the software.
- If you uninstall the DC Software 2 with the DC Software and the DC Software 2 have been already installed, DL-10 added to the Start-up folder can be deleted.

Viewing Software Manual

In the internal memory of the camera, "Software User Guide" (PDF file) is available. This guide explains how to download images from the camera to your computer. To view the guide, copy the guide onto your computer.

1 Open [My computer] with the camera connected to the computer.

- The internal memory of the camera appears as the drive.

2 Open [MANUAL] folder.

- Each language has its own "Software User Guide" (PDF file).

3 Copy the PDF file for your language directly to your hard disk.



Note

- Adobe Reader is required to display the operation manual (PDF file). Acrobat Reader or Adobe Reader need to be installed from the Adobe website if not installed on your computer.
- When the DL-10 Software has already been installed from the camera, select [Start] > [DC Software 2] > [Adobe Reader Download] to display the website for downloading.
- For details about Adobe Reader, see Help for Adobe Reader.

Copying Pictures to Your Computer

Follow the steps below to copy pictures to your computer.



Caution

To copy pictures stored in the SD memory card, insert the card first and then connect the camera to the computer.

1 Connect the common terminal for USB port/AV output of the camera (gray) to the computer using the supplied USB cable.

- Turn the camera off before connecting the USB cable.
- The camera turns on automatically when a connection is established.

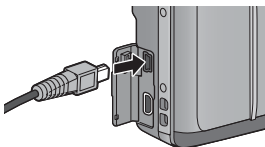

2 Copy photos to the computer.

If DL-10 is installed:

- DL-10 starts and image transfer begins automatically.
- Pictures are copied to the [Digital Camera] folder in [My Documents], where they are sorted into separate folders by date of recording. See the "Software User Guide" (PDF file) for more information.

If DL-10 is not installed:

- Copy files from the camera to the desired location.
- When an SD memory card is loaded, its files are displayed. Otherwise, files in the internal memory are displayed.
- When [Digital camera software installer] screen appears, click [x].

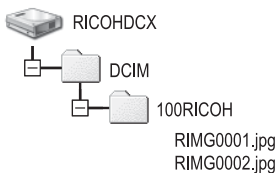

Example of the display
in Windows XP

3 Disconnect the USB cable when transfer is complete.

- Click the [Safely Remove Hardware] or [Unplug or Eject Hardware] icon in the taskbar (the illustration above shows the icon for Windows XP) and select [Safely Remove USB Mass Storage Device] or [Stop USB Mass Storage Device] from the menu that appears. You can then disconnect the USB cable.



- If the remove hardware icon is not displayed in Windows 7, click the  button in the taskbar.



Caution-----

Do not turn off the camera or disconnect the USB cable during image transfer.

Note-----

- “MediaBrowser” image viewing and editing software (for Windows only) is also included in the internal memory of the camera. You can download the information on how to use MediaBrowser from the displayed “Help”.
- For the latest information about MediaBrowser, access the Web page of Pixela Co., Ltd. (<http://www.pixela.co.jp/oem/mediabrowser/e/>).

For Macintosh

This camera supports the following Macintosh operating systems.

- Mac OS X 10.1.2 to 10.6.4

Caution

- VM-1 software and the “Software User Guide” (PDF file) can be used on Macintosh computers.
- In the internal memory of the camera, “Software User Guide” (PDF file) is available. To view the guide, copy the guide onto your computer. See P.127 for more information.

System Requirements for Using the Built-in Software

The following environments are necessary for using the built-in software. Please check your computer, or the computer’s user manual.

Operating Systems Supported	Mac OS X 10.4 to 10.6.4
Macintosh computer	Apple Inc. Macintosh Series
Internal Memory	Mac OS X 10.4 256 MB or more
	Mac OS X 10.5 512 MB or more
	Mac OS X 10.6 1GB or more
Hard Disk Available Memory	5 MB or more

Note

VM-1 supports Japanese, English, French and Chinese (Simplified).

Copying Pictures to Your Computer

Follow the steps below to copy pictures to your computer.



Caution

To copy pictures stored in the SD memory card, insert the card first and then connect the camera to the computer.

1 Connect the common terminal for USB port/AV output of the camera (gray) to the computer using the supplied USB cable.

- Turn the camera off before connecting the USB cable.
- The camera turns on automatically when a connection is established.

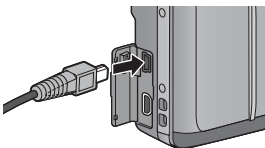

2 Copy photos to the computer.

- Copy files from the camera to the desired location.
- When an SD memory card is loaded, its files are displayed. Otherwise, files in the internal memory are displayed.

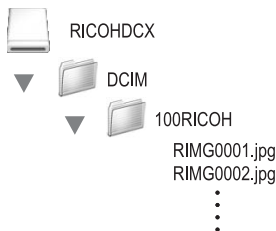

3 Disconnect the USB cable when transfer is complete.

- Drag the camera volume into the Trash and then disconnect the USB cable.



Caution

- Do not turn off the camera or disconnect the USB cable during image transfer.
- You can also click [Eject] on the [File] menu to cancel the connection.
- If the USB cable is disconnected without disabling the connection, the Unsafe Removal of Device screen may be displayed. Be sure to stop the connection before removing the USB cable.
- When you connect your camera to a Macintosh computer, a file called "FINDER.DAT" or ".DS_Store" may be created in your SD memory card, which will appear as [Unmatched File] on your camera. You can delete this file from the SD memory card if you wish.

Using the MP File Viewer

When you shoot one still image with M-Cont Plus, Speed Cont, or Multi-trgt AF, the image is recorded as one MP file.

By using the VM-1 MP file viewer, you can play back MP files on your Macintosh computer and export still images.

This section explains how to install and uninstall the VM-1 software. For details on how to play back MP files on your computer or export still images from MP files using the MP file viewer, see the "Software User Guide" (PDF file).

Installing Software



Caution

Before proceeding, confirm that [Mass Storage] is selected for [USB Connection Type] (👉 P.113) in the setup menu (👉 P.109).

1 Turn the camera power off, and pull the SD memory card out of the camera.

- With SD memory card in the camera, the software cannot be installed.

2 Connect the common terminal for USB port/AV output of the camera (gray) to the computer using the supplied USB cable.

- When a connection is established, the camera turns on automatically and the internal memory of the camera appears as the [RICOHDCI] drive.

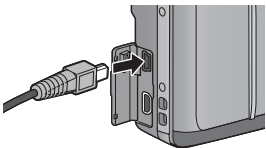

3 Double-click [RICOHDCI], [MAC], [MAC_DATA.DMG], and [VM1 installer.pkg].

- The [Install VM-1] window is displayed.

4 Follow the on-screen instructions to complete installation.



Deleting (Uninstalling) VM-1 -----

- Double-click [Applications], [Utilities], [VM-1 Utility], and [VM-1 Uninstaller] and follow the on-screen instructions.
- If you have any other software applications running or data that has not been saved, quit the other software applications and save the data before uninstalling the software.
- If an error occurs during the uninstallation process, update your Mac OS to the latest version.

Troubleshooting

Error Messages

If an error message is displayed on the screen, check the information on the reference page and take the corresponding action.

Error Message	Cause and Solution	Refer to
Insert card.	No card is loaded. Insert a card.	P.27
Set date.	The date is not set. Set the date.	P.114
The file number limit has been exceeded.	The file number limit has been exceeded. Use another card.	P.114
Unmatched File	This file cannot be displayed on the camera. Check the file contents on your computer, and then delete the file.	—
Insufficient memory. Continue?	All the files cannot be copied because there is insufficient memory on the card. Use another card.	—
Protected	The file selected for deletion is protected.	P.104
Card Is Write-Protected.	The card is locked (write-protected). Unlock the card.	P.25
Print settings cannot be applied to this file.	This file (movie or other file) cannot be selected for printing.	—
Insufficient Memory	Files cannot be stored. Make sure there is sufficient memory or delete unwanted files.	P.42, P.110
	The image print number limit has been exceeded. Select an image and set the number to 0.	P.122
Format internal memory.	The internal memory requires formatting.	P.110
Format card.	The card is not formatted. Format the card with this camera.	P.110
Card Error	SDXC cards can not be used. If the card is not an SDXC card, format the card; if the message persists, the card may be faulty and should not be used.	P.110
Writing Data	Writing file to memory. Wait until writing finishes.	—
No file	There are no files that can be played back.	—
Out of memory. cannot record.	The number of remaining shots is 0. Switch to another card or the internal memory.	P.25
No files to restore.	There are no files to restore.	P.95
Can not —.*	Selected option can not be applied to image more than once, or image was created with different make of camera. If image was created with different make of camera, process image using original make of camera.	—





* "—" indicates the name of the process that can not be applied.

Camera Troubleshooting

Power Supply

Problem	Cause	Solution	Refer to
The camera does not turn on.	The battery is exhausted or not inserted.	Load the rechargeable battery correctly, or charge the battery.	P.27, P.26
	An unacceptable battery is used.	Use the dedicated rechargeable battery. Never use any other battery.	P.23
	The camera is automatically turned off by auto power off.	Turn the camera back on.	P.28
	The battery is loaded in wrong direction.	Load correctly.	P.27
	Because the camera overheated, the power was automatically turned off.	Wait until the temperature of the camera returns to normal. Do not attempt to cool the camera suddenly.	—
The camera turns off during use.	The camera was left unattended and unused, so auto power off turned it off.	Turn the camera back on.	P.28
	Battery is exhausted.	Charge the rechargeable battery.	P.26
	An unacceptable battery is used.	Use the dedicated rechargeable battery. Never use any other battery.	P.23
The camera does not turn off.	Camera malfunction	Remove the battery and load it again.	P.27
The battery has been fully charged, but: <ul style="list-style-type: none">• The battery symbol is displayed, indicating a low battery level.• The camera turns off.	A (manganese dry cell or other) unacceptable battery is used.	Use the dedicated rechargeable battery. Never use any other battery.	P.23
Cannot charge the battery.	Battery has reached the end of its useful life.	Replace with a new rechargeable battery.	P.27
Battery runs out quickly.	It is being used at extreme high or low temperatures.	—	—
	Many shots are being taken in dark places or other location requiring extensive use of flash.	—	—

Shooting

Problem	Cause	Solution	Refer to
The camera does not shoot even if you press the shutter release button.	Battery is exhausted.	Charge the rechargeable battery.	P.26
	The camera is not on.	Press the POWER button to turn the camera on.	P.28
	The camera is in playback mode.	Press the  (Playback) button to select the shooting mode.	P.28
	The shutter release button is not pressed all the way.	Press the shutter release button all the way.	P.30
	The SD memory card is not formatted.	Format the card.	P.110
	The SD memory card is full.	Load a new card, or delete unwanted files.	P.27, P.42
	The SD memory card has reached the end of its useful life.	Load a new SD memory card.	P.27
	The flash is charging.	Wait until the flash mode symbol stops blinking.	P.35
	The SD memory card is locked.	Unlock the card.	P.25
	The contact surface of the SD memory card is dirty.	Wipe with a soft, dry cloth.	—
Unable to view the shot image.	The image confirmation time is too short.	Lengthen the image confirmation time.	P.111
Images do not appear on the picture display.	The camera is not on, or the picture display is dark.	Turn the camera on, or adjust the brightness of the picture display.	P.28, P.110
	The VIDEO/AV cable is connected.	Disconnect the VIDEO/AV cable.	—
	The screen display is in synchronizer mode.	Press the DISP. button to change the display.	P.45
Although the camera is set to auto focus, it is unable to focus.	The lens is dirty.	Wipe clean with a soft, dry cloth.	—
	The subject is not in the center of the shooting range.	Shoot with focus lock.	P.30
	It is a hard-to-focus subject.	Shoot with focus lock or manual focus.	P.30, P.87
Although the camera is not in focus, the green frame appears in the center of the picture display.	The camera incorrectly focused because the distance to the subject is too close.	Shoot with macro mode, or move away from the subject.	P.34
The picture is blurred. (The    symbol appears.)	You moved the camera when pressing the shutter release button.	Hold camera in both hands with your elbows pressed lightly against your torso. Use a tripod. Use the camera shake correction function.	P.30 P.84
	When shooting in a dark place (such as indoors), the shutter speed slows down and pictures become easily blurred.	Use the flash. Raise the ISO setting. Use the camera shake correction function.	P.35 P.92 P.84

Problem	Cause	Solution	Refer to
The flash does not fire. Or, the flash cannot charge.	The flash cannot be used in the following cases: <ul style="list-style-type: none"> • In bracket shooting • In continuous mode • In movie mode • In discreet mode • In pets mode In some scene modes, the flash is disabled by default.	To shoot with the flash, change the settings or mode.	P.59, P.140
	The flash is set to flash off.	Cancel Flash Off.	P.35
	Battery is exhausted.	Charge the rechargeable battery.	P.26
Even though the flash fired, the picture is dark.	The distance to the subject exceeds the flash range.	Get closer to your subject and shoot. Change the flash mode or the ISO setting.	P.92
	The subject is dark.	Correct the exposure. (Exposure compensation also changes the light intensity of the flash.)	P.90
	The light intensity of the flash is not appropriate.	Adjust the light intensity of the flash.	P.82
The image is too bright.	The light intensity of the flash is not appropriate.	Adjust the light intensity of the flash. Alternatively, move a little away from the subject or illuminate the subject with another light source instead of using the flash.	P.35, P.82
	Subject is overexposed. (The [!AE] symbol appears.)	Correct the exposure. Cancel exposure time.	P.90 P.82
	The brightness of the picture display is not appropriate.	Adjust the brightness of the picture display.	P.110
The image is too dark.	The shot was taken in a dark place while set to flash off.	Cancel Flash Off.	P.35
	The subject is underexposed. (The [!AE] symbol appears.)	Correct the exposure. Set the long exposure time.	P.90 P.82
	The brightness of the picture display is not appropriate.	Adjust the brightness of the picture display.	P.110
The image lacks natural color.	The picture was shot in conditions that made it difficult for auto white balance to adjust the white balance.	Add a white object to the composition, or use a white balance setting other than auto.	P.91
The date or recording information does not appear on the screen.	The screen display function is set to no display.	Press the DISP. button to change the display.	P.45
The brightness of the picture display changes during AF.	Ambient lighting is poor or differs from that used for autofocus..	This is normal.	—

Problem	Cause	Solution	Refer to
The level indicator is not displayed.	[Level Setting] is set to [Off] or [Sound].	Set [Level Setting] to [Display] or [Display+Sound].	P.48
	The display is set to a setting other than normal symbol display or histogram.	Press the DISP. button to change the display to normal symbol display or histogram.	P.45
	The camera is upside down (The shutter release button is on the bottom).	Hold the camera correctly.	—
The image is tilted even though it was shot with the level indicator in the middle or while the level sound was sounding.	You shot the image while moving, such as on an amusement ride.	Shoot in an environment that is not moving.	—
	The subject is not level.	Check the subject.	—
Self timer lamp does not light.	[Discreet Mode] or [Pets] is selected in scene mode.	Choose another mode.	P.59, P.60

Playback/Deleting

Problem	Cause	Solution	Refer to
Cannot play back, or the playback screen does not appear.	The camera is not in playback mode.	Press the  (Playback) button.	P.37
	The HDMI/AV cable is not connected properly.	Connect properly.	P.107
	The [Video Out Mode] setting is incorrect.	Set it to the correct format.	P.114
The contents of the SD memory card cannot be played back, or the playback screen does not appear.	No SD memory card is loaded, or an SD memory card with no stored images is loaded.	Load a card with stored images.	—
	You played back an SD memory card that was not formatted with this device.	Load a card that was formatted and recorded with this device.	P.27, P.110
	You played back an SD memory card that was not recorded normally.	Load a normally recorded card.	P.27
	The contact surface of the SD memory card is dirty.	Wipe with a soft, dry cloth.	—
	There is something wrong with the SD memory card.	Play back images from another card and if there is nothing wrong with the card, the camera is okay. There may be something wrong with the card, so do not use it.	—
The picture display turned off.	Battery is exhausted.	Charge the rechargeable battery.	P.26
	The camera was left unattended and unused, so auto power off turned it off.	Turn the camera back on.	P.28

Problem	Cause	Solution	Refer to
Part of the screen flashes in black.	The screen is highlighted due to an overly bright area.	It is recommended that you shoot another image while avoiding direct sunlight and setting the exposure level lower (-).	P.47, P.90
A file cannot be deleted.	The file is protected.	Unprotect the file.	P.104
	The SD memory card is locked.	Unlock the card.	P.25
Cannot format the SD memory card.	The SD memory card is locked.	Unlock the card.	P.25

Other Problems

Problem	Cause	Solution	Refer to
Cannot load the SD memory card.	The card is facing the wrong way.	Load correctly.	P.27
The camera does not operate even when the buttons are pressed.	Battery is exhausted.	Charge the rechargeable battery.	P.26
	Camera malfunction	Press the POWER button to turn the camera off, and then press the POWER button to turn the camera on again.	P.28
		Remove the battery and load it again.	P.27
The date is incorrect.	The correct date/time are not set.	Set the correct date/time.	P.114
The set date disappeared.	The battery was removed.	If the battery is removed for more than one week, the date setting will be lost. Make the settings again.	P.114
Auto power off does not work.	Auto power off is set to [Off].	Set the time for auto power off.	P.111
The operation sound cannot be heard.	[Discreet Mode] or [Pets] is selected in scene mode.	Choose another mode.	P.59, P.60
	The operation sound volume is turned off.	Use [Volume Settings] to set the volume to a setting other than mute.	P.111
Images do not appear on the TV.	The [Video Out Mode] setting is incorrect.	Set it to the correct format.	P.114
	The AV cable is not connected.	Connect the AV cable properly.	P.107
	The TV is not correctly set to VIDEO IN.	Check that the TV is correctly set to VIDEO IN.	—

Available Settings

The following table lists the settings available in each shooting mode.

(Macro) *1		✓	✓	✓	✓	✓	✓	✓	✓	✓	✓
(Flash)		✓	—	—	—	—	—	—	—	✓	✓
(Self-timer) *5		✓	—	—	—	—	—	—	✓	✓	✓
Digital Zoom		✓	✓*7	✓	✓	✓	✓	✓	—	✓	✓
Dynamic Range Expansion		—	—	—	—	—	—	—	✓	—	—
Soft Focus Options		—	—	—	—	—	—	—	—	—	—
Vignetting		—	—	—	—	—	—	—	—	—	—
Toy Color		—	—	—	—	—	—	—	—	—	—
Hue		—	—	—	—	—	—	—	—	—	—
Plus Normal Shooting		—	—	—	—	—	—	—	✓	✓	✓
Picture Quality/Size		✓	—	✓	—	—	—	—	✓	✓	✓
Movie Size		—	✓	—	—	—	—	—	—	—	—
Density		—	—	—	—	—	—	—	—	—	—
Size		—	—	—	—	—	—	—	—	—	—
Shooting Menu	Focus	Multi AF *8	✓	✓	✓	✓	✓	✓	✓	✓	✓
		Face Pr. Multi *10	✓	✓	✓	✓	✓	✓	—	—	—
		Subj. Tracking	✓	—	—	—	—	—	—	—	—
		Spot AF	✓	✓	✓	✓	✓	✓	✓	✓	✓
		Multi-trgt AF *11	✓	—	—	—	—	—	—	—	—
		AF	—	—	—	—	—	—	—	—	—
		MF	✓	—	✓	✓	✓	✓	✓	—	—
		Snap	✓	—	✓	✓	✓	✓	✓	✓	✓
		∞	✓	✓	✓	✓	✓	✓	✓	✓	✓
		Pre-AF *12	✓	✓	✓	✓	✓	✓	✓	✓	✓
Exposure Metering		✓	—	✓	✓	✓	✓	✓	✓	✓	✓
Image Settings		✓	—	✓	✓	✓	✓	✓	✓*13	✓*13	—
Noise Reduction		✓	—	—	—	—	—	—	✓	—	—
Super Resolution		✓	—	—	—	—	—	—	✓	—	—
Flash Exposure Compensation		✓	—	—	—	—	—	—	—	✓	✓
Auto Bracket *14		✓	—	—	—	—	—	—	—	—	—
Time Exposure *15		✓	—	—	—	—	—	—	—	—	—

*1 [Focus] is set to [Spot AF]. Disabled when [MF] is selected for [Focus].

*2 Only [Anti Red-eye] or [Flash Synchro.] can be selected.

*3 [Anti Red-eye] is not available.

*4 Only [Flash Off] or [Auto] can be selected.

*5 Self-timer disabled when [Interval Shooting] is in effect. [Custom Self-Timer] is not available when [Focus] is set to [Multi-trgt AF] or [Subj. Tracking].

*6 Only digital zoom (1280: up to 2.8x; 640 or 320: up to 4.0x) can be used.

*7 Only [1M 4 : 3 F] or [VGA 4 : 3 F] is available.

*8 [Spot AF] used when digital zoom is in effect.

*9 Available, but menu is not displayed and setting can not be changed.

📷			SCENE														S-AUTO
Soft	📷	Toy	👤	🏔️	📷	👤*	🏠*	🌿	🍴	🏹	🐾	🎨	👤	👤	📄	AUTO	
✓	✓	✓	—	—	✓	—	—	—	✓*9	—	—	✓	✓	✓	✓	—	
✓	✓	✓	✓	—	—	✓*2	—	—	✓*3	✓	—	—	✓	✓	✓	✓*4	
✓	✓	✓	✓	✓	✓	✓	✓	✓	✓	✓	✓	—	✓	✓	✓	✓	
✓	✓	✓	✓	✓	✓	✓	✓	✓	✓	✓	✓	✓	✓	✓	✓	✓	
—	—	—	—	—	—	—	—	—	—	—	—	—	—	—	—	—	
✓	—	—	—	—	—	—	—	—	—	—	—	—	—	—	—	—	
—	—	✓	—	—	—	—	—	—	—	—	—	—	—	—	—	—	
—	—	✓	—	—	—	—	—	—	—	—	—	—	—	—	—	—	
—	✓	—	—	—	—	—	—	—	—	—	—	—	—	—	—	—	
✓	✓	✓	—	—	—	—	—	—	—	—	—	—	—	—	—	—	
✓	✓	✓	✓	✓	✓	✓	✓	✓	✓	✓	✓	—	✓	✓	✓*8	✓	
—	—	—	—	—	—	—	—	—	—	—	—	—	—	—	—	—	
—	—	—	—	—	—	—	—	—	—	—	—	—	—	—	✓	—	
—	—	—	—	—	—	—	—	—	—	—	—	—	—	—	✓	—	
✓	✓	✓	—	—	✓	✓	✓	—	—	✓	—	✓	—	✓	✓	✓*9	
✓	—	—	—	—	✓	✓	—	—	—	✓	—	✓	—	✓	—	—	
—	—	—	—	—	✓	—	—	—	—	—	—	—	—	—	—	—	
✓	✓	✓	—	—	✓	✓	✓	—	—	✓	—	✓	—	✓	✓	—	
—	—	—	—	—	✓	—	—	—	—	—	—	—	—	—	—	—	
—	—	—	—	—	✓	—	—	—	—	—	—	—	—	—	—	—	
—	—	—	—	—	✓	—	—	—	—	—	—	—	—	—	—	—	
—	—	—	—	—	✓	—	—	—	—	—	—	—	—	—	—	—	
✓	✓	✓	—	—	✓	✓	✓	—	—	✓	—	✓	—	✓	—	—	
✓	✓	✓	—	—	✓	✓	✓	—	—	✓	—	✓	—	✓	—	—	
✓	✓	✓	—	—	✓	✓	✓	—	—	✓	—	✓	—	✓	—	—	
✓	✓	✓	—	—	✓	—	—	—	—	✓	—	✓	—	✓	—	—	
✓*13	—	✓*13	—	—	✓	—	—	—	—	✓	—	✓	—	✓	—	—	
—	—	—	—	✓	✓	✓	✓*9	—	—	—	—	—	✓	✓	—	—	
—	—	—	—	✓*9	✓	—	—	—	—	—	—	—	✓	—	—	—	
✓	✓	✓	✓	—	✓	—	—	—	—	✓	—	—	✓	✓	✓	—	
—	—	—	—	—	✓	—	—	—	—	—	—	—	✓	—	—	—	
—	—	—	—	—	✓	—	—	—	—	—	—	—	✓	—	—	—	
—	—	—	—	—	✓	—	—	—	—	—	—	—	✓	—	—	—	

*10 Camera selects optimal white balance; no icon is displayed. Equivalent to multi-pattern auto if no face is detected.

*11 The flash cannot be used. The custom self-timer is not available. Digital zoom, [Time Exposure], [Custom Self-Timer], [Interval Shooting], and [Camera Shake Correction] are disabled. [Auto] is used for [White Balance].

*12 Not available when [MF], [Snap], or [∞] is selected for [Focus].

*13 Only [Color], [Black & White] or [Sepia] can be selected.

*14 The flash turns off automatically and [Time Exposure] and [Subj. Tracking] are disabled. Not available when [Focus] is set to [Multi-trgt AF].

*15 [Camera Shake Correction] is disabled.

Shooting Menu	Custom Self-Timer	✓	—	—	—	—	—	✓	✓	✓	
	Interval Shooting *16	✓	—	—	—	—	—	✓	✓	✓	
	Camera Shake Correction *17	✓	—	—	—	—	—	✓	✓	✓	
	Slow Shutter Limit	✓	—	✓	—	—	—	—	✓	✓	
	Date Imprint	✓	—	✓	✓	✓	✓	✓	✓	✓	
	Exposure Compensation	✓	—	✓	✓	✓	✓	✓	✓	✓	
	White Balance *18	Multi-P AUTO	✓	—	—	—	—	—	✓	✓	—
		Other than those above	✓	✓	✓	✓	✓	✓	✓	✓	—
	ISO Setting	✓	—	✓	✓	✓	✓	✓	✓	✓	
	Maximum ISO for ISO Auto	✓	—	✓	✓	✓	✓	✓	✓	✓	
Restore Defaults	✓	—	—	—	—	—	—	—	—		
Setup Menu	Step Zoom	✓	✓	✓	✓	✓	✓	✓	✓	✓	
	Set Fn Button *19	Macro Target *20	✓	✓	✓	✓	✓	✓	✓	—*21	✓
		Step Zoom	✓	✓	✓	✓	✓	✓	✓	—*21	✓
		AE Lock	✓	—*21	✓	✓	✓	✓	✓	—*21	✓
		AF/Face Pr.	✓	✓	✓	✓	✓	✓	—*21	*21	*21
		AF/Subj.Trckng	✓	—*21	—*21	—*21	—*21	—*21	—*21	*21	*21
		AF/Multi Trgt	✓	—*21	—*21	—*21	—*21	—*21	—*21	*21	*21
		AF/MF	✓	—*21	✓	✓	✓	✓	✓	—*21	*21
		AF/Snap	✓	—*21	✓	✓	✓	✓	✓	—*21	✓
		AT-BKT	✓	—*21	*21	*21	*21	*21	*21	*21	*21
		WB-BKT	✓	—*21	*21	*21	*21	*21	*21	*21	*21
		CL-BKT	✓	—*21	*21	*21	*21	*21	*21	*21	*21
		FOCUS-BKT	✓	—*21	*21	*21	*21	*21	*21	*21	*21
		ADJ Button Setting 1–4	Off	✓	—*21	✓	✓	✓	✓	✓	✓
	Exposure Comp.		✓	—*21	✓	✓	✓	✓	✓	✓	✓
	White Balance		✓	✓	✓	✓	✓	✓	✓	✓	—*21
	ISO		✓	—*21	✓	✓	✓	✓	✓	✓	✓
	Quality		✓	✓	✓	—*21	*21	*21	*21	✓	✓
	Focus		✓	✓	✓	✓	✓	✓	✓	✓	✓
	Image		✓	—*21	✓	✓	✓	✓	✓	✓	—*21
Expo. Metering	✓		—*21	✓	✓	✓	✓	✓	✓	✓	
Auto Bracket	✓		—*21	*21	*21	*21	*21	*21	*21	*21	
Flash Comp.	✓		—*21	*21	*21	*21	*21	*21	✓	✓	
Density	—	—	—	—	—	—	—	—	—		
Digital Zoom Image	✓	✓	✓	✓	✓	✓	✓	✓	✓		
Grid Guide Display Options	✓	✓	✓	✓	✓	✓	✓	✓	✓		
Minimum Distance	✓	✓	✓	✓	✓	✓	✓	✓	✓		
White Saturation Display	✓	✓	✓	✓	✓	✓	✓	✓	✓		
Other than those above	✓	✓	✓	✓	✓	✓	✓	✓	✓		

*16 When the self-timer is set, [Interval Shooting] and [Subj. Tracking] are disabled. Not available when [Focus] is set to [Multi-trgt AF].

*17 Not available if [Focus] is set to [Multi-trgt AF] or when using [Time Exposure].

*18 Not available when [Image Settings] is set to [Black & White] or [Sepia].

Specifications

No. of effective pixels (camera)		Approx. 10.00 million effective pixels
Image Sensor		1/2.3" CMOS (Approx. 10.60 total million pixels)
Lens	Focal Length	4.9 mm to 52.5 mm (equivalent to 28 mm to 300 mm on a 35-mm camera)
	F-aperture	F3.5 to F5.6
	Shooting Distance	Normal shooting: Approx. 30 cm to ∞ (Wide-angle) or 1.5 m to ∞ (Telephoto) (from the front of the lens)
		Macro shooting: Approx. 1 cm to ∞ (Wide-angle), 28 cm to ∞ (Telephoto) or 1 cm to ∞ (Zoom macro mode) (from the front of the lens)
Lens Construction	10 elements in 7 groups (4 aspherical lens elements with 5 surfaces)	
Zoom Magnification		Optical zoom at 10.7×, Super resolution zoom at 2.0×, Digital zoom at 4.8×, Auto resize zoom at approx. 5.7× (VGA image)
Focus Modes		Multi AF (Contrast AF method)/Spot AF (Contrast AF method)/Face-Priority Multi AF/Subject tracking AF/Multi-target AF/MF/Snap/∞ (with AF Auxiliary Light)
Blur Reduction		Image Sensor Shift Image Stabilizer
Shutter Speed	Still Image	8, 4, 2, 1 to 1/2000 seconds (The upper and lower limits differ for each shooting mode and flash mode.)
	Movie	1/30 to 1/2000 seconds
Exposure Control	Exposure Metering Mode	Multi Light Metering (256 segments)/Center-weighted Light Metering/Spot Metering
	Exposure Mode	Program AE
	Exposure Compensation	Manual exposure compensation (+2.0 to -2.0 EV in 1/3 EV Steps), Auto bracket function (-0.5 EV, ±0, +0.5 EV)
	Exposure Range (auto mode, center-weighted metering)	Wide angle: 3.2 – 16.2 EV Telephoto: 4.6 – 18.4 EV (Exposure range for auto ISO calculated using values for ISO 100.) Note: At 6.0 EV or lower, each drop of 1.0 EV is associated with a 0.5 EV drop in brightness. Brightness drops by no more than -1.0 EV.
ISO Sensitivity (Standard Output Sensitivity)		Auto/ISO 100/ISO 200/ISO 400/ISO 800/ISO 1600/ISO 3200
White Balance Mode		Auto/Multi-pattern Auto/Outdoors/Cloudy/Incandescent 1/Incandescent 2/Fluorescent/Manual, White balance bracket function
Flash	Flash Mode	Auto flash (fires automatically in low-light conditions and when the subject is backlit)/Anti Red-eye/Flash On/Flash Synchro./Flash Off
	Built-in flash Range	Approx. 20 cm – 4.0 m (Wide-angle) or 28 cm – 3.0 m (Telephoto) (auto ISO with a maximum of ISO 1600, measured from the front of the lens)
	Flash Compensation	±2.0 EV (1/3 EV Steps)
	Charging Time	Approx. 5 seconds
Picture Display		3.0" Transmissive LCD, approx. 920,000 dots









Shooting Mode		Auto shooting mode/My settings mode/Movie mode/Continuous mode/ Creative Shooting Mode (Dynamic Range/Miniaturize/High Contrast B&W/Soft Focus/Cross Process/Toy Camera)/Scene mode (Portrait/Landscape/Discreet Mode/Night. Port./Night Landscape Multi-shot/Fireworks/Cooking/Sports/ Pets/Golf Swing Continuous Mode/Zoom Macro/High Sens/Skew Correct Mode/Text Mode)/Scene auto mode
Picture Quality Mode * ¹		F (Fine), N (Normal)
Number of Recorded Pixels	Still Image	3648 × 2736, 3648 × 2432, 2736 × 2736, 3648 × 2048, 2592 × 1944,
	Multi-Picture	2048 × 1536, 1728 × 1296 (Multi-Picture only), 1280 × 960, 640 × 480
	Movie	1280 × 720, 640 × 480, 320 × 240
	Text	3648 × 2736, 2048 × 1536
Recording Media		SD memory card, SDHC memory card (up to 32 GB), Internal Memory (approx. 40 MB)
Recording Data Capacity	3648 × 2736	N: approx. 2173 KB/Screen, F: approx. 3708 KB/Screen
	3648 × 2432	F: approx. 3298 KB/Screen
	2736 × 2736	F: approx. 2788 KB/Screen
	3648 × 2048	F: approx. 2783 KB/Screen
	2592 × 1944	F: approx. 2291 KB/Screen
	2048 × 1536	F: approx. 1477 KB/Screen
	1728 × 1296	N: approx. 607 KB/Screen
	1280 × 960	F: approx. 816 KB/Screen
640 × 480	F: approx. 200 KB/Screen	
Recording File Format	Still Image	JPEG (ExifVer. 2.3)* ²
	Multi-Picture	Compliant with CIPA DC-007-2009 Multi Picture Format
	Movie	AVI (Open DML Motion JPEG Format Compliant)
	Compression Format	JPEG Baseline Format Compliant (Still image, movie)
Other Major Shooting Functions		Continuous mode, Self-timer (operation time: approx. 10 seconds, approx. 2 seconds, Custom), Interval shooting (shooting interval: 5 seconds to 1 hour, in increments of 5 seconds)* ³ , Color bracket, Focus bracket, AE/AF target shift, Histogram display, Grid guide display, Electronic level
Other Major Playback Functions		Thumbnail view, Enlarged view (maximum ×16), Resize, Level Compensation, White Balance Compensation, Skew Correction, Trim, Flag Function, Slide show, DPOF
Interface		USB2.0 (High-Speed USB) Mini-B, Mass storage-compatible * ⁴ , AV output 1.0Vp-p (75 Ω), HDMI Micro Output Terminal (Type D)
Video Signal Format		NTSC, PAL
Power Supply		Rechargeable Battery (DB-100): 3.7 V
Battery Consumption * ⁵		Usage time of DB-100: approx. 280 pictures (When [Sleep Mode] is set to [Off] * ⁶)
Dimensions (W × H × D)		101.5 mm × 58.6 mm × 29.4 mm (excluding projections; measured according to CIPA guidelines)
Weight		Approx. 197 g (including memory card and supplied battery) Approx. 176 g (camera only)

Tripod Hole Shape	1/4-20UNC
Date Maintain Time	Approx. 1 week
Operating Temperature	0 °C to 40 °C
Operating Humidity	90% or less
Storage Temperature	-20 °C to 60 °C

- *1 The picture quality mode that can be set varies depending on the image size.
- *2 Compatible with DCF and DPOF. DCF is the abbreviation for "Design rule for Camera File system," a JEITA standard. (Full compatibility with other devices is not guaranteed.)
- *3 When the flash is set to [Flash Off].
- *4 Mass storage mode is supported by Windows XP, Windows Vista, Windows 7 and Mac OS X 10.1.2–10.6.4.
- *5 The number of remaining shots is based on the CIPA standard and may vary depending on usage conditions. This is for reference only.
- *6 You can take approximately 300 shots when [Sleep Mode] is set to [10 seconds].

Number of Images That Can Be Stored

The following table shows the approximate number of images that can be recorded in the internal memory and onto an SD memory card at various image size and picture quality settings.

Mode	Image Size	Internal Memory	1GB	2GB	4GB	8GB	16GB	32GB
 SCENE (other than Golf Swing Continuous Mode, Text Mode) S-AUTO  (Continuous Mode) 	10M 4:3 F	10	241	491	965	1973	3953	7930
	10M 4:3 N	17	411	830	1631	3333	6678	13396
	9M 3:2 F	11	271	548	1077	2202	4412	8851
	7M 1:1 F	13	321	653	1284	2624	5257	10546
	7M 16:9 F	13	321	653	1284	2624	5257	10546
	5M 4:3 F	15	370	749	1471	3008	6026	12089
	3M 4:3 F	24	575	1159	2277	4654	9324	18704
	1M 4:3 F	43	1041	2118	4160	8505	17039	34181
	VGA 4:3 F	169	4028	7681	15082	30828	61759	123888
	 (When [Focus] is set to [Multi-trgt AF])	10M 4:3 F	10	239	487	957	1957	3922
10M 4:3 N		17	405	819	1609	3289	6589	13217
9M 3:2 F		11	268	543	1068	2183	4373	8772
7M 1:1 F		13	318	647	1270	2596	5202	10435
7M 16:9 F		13	318	647	1270	2596	5202	10435
5M 4:3 F		15	366	740	1454	2972	5954	11943
3M 4:3 F		23	564	1138	2235	4568	9151	18357
1M 4:3 F		41	1006	2047	4022	8221	16471	33042
VGA 4:3 F		149	3554	6827	13407	27404	54898	110125
		HD 1280		3 min. 7 s	6 min. 14 s	12 min. 14 s	25 min. 1 s	50 min. 7 s
	VGA 640		8 min. 22 s	18 min. 8 s	35 min. 38 s	72 min. 50 s	145 min. 54 s	292 min. 41 s
	QVGA 320		21 min. 54 s	44 min. 39 s	86 min. 2 s	176 min. 28 s	354 min. 44 s	710 min. 3 s
 (M-Cont Plus (10M))	10M 4:3 N	17	411	830	1631	3333	6678	13396
 (M-Cont Plus (2M)) SCENE (Golf Swing Continuous Mode)	2M 4:3 N	58	1404	2792	5484	11211	22460	45056
 (Speed Cont)	VGA 4:3 N	283	6714	12288	24129	49319	98801	198192
SCENE (Text Mode)	10M 4:3	17	411	830	1631	3333	6678	13396
	3M 4:3	43	1059	2118	4160	8505	17039	34181



Note

- The maximum recording time is the estimated total recording time. Movies may be up to 4GB in size. The maximum length is 12 minutes for movies recorded at a [Movie Size] of [**HD** 1280] and 29 minutes for movies recorded at [**VGA** 640] or [**VGA** 320].
- A Speed Class 6 memory card is recommended when recording movies with [**HD** 1280] selected for [Movie Size].
- The maximum number of consecutive shots that can be taken using continuous mode is 999. When the number of remaining shots is 1000 or more, "999" is displayed on the picture display.
- The maximum numbers of shots for M-Cont Plus (2M)/M-Cont Plus (10M) and Speed Cont are the estimated total numbers of shots that can be recorded. The maximum number of shots that can be taken consecutively at one time is 26 for M-Cont Plus (2M) and 15 for M-Cont Plus (10M) and 120 for Speed Cont.
- The maximum number of shots for Multi-trgt AF is the estimated total number of shots that can be recorded. The number of shots that can be recorded at one time is five. When the number of remaining shots is 9999 or more, "9999" is displayed on the picture display.
- The number of remaining shots displayed on the picture display may differ from the actual number of shots, depending on the subject.
- Movie recording time and the maximum number of still pictures may vary depending on the capacity of the recording destination (internal memory or SD memory card), shooting conditions, and the type and manufacturer of the SD memory card.
- Choose image size according to how the picture will be used:

Image Size	Description
10M 4 : 3 F/ 10M 4 : 3 N/ 9M 3 : 2 F/ 7M 1 : 1 F/ 7M 16 : 9 F	<ul style="list-style-type: none"> • For creating large prints. • For downloading to a computer for trimming and other processes.
5M 4 : 3 F/ 3M 4 : 3 F	<ul style="list-style-type: none"> • For creating prints.
1M 4 : 3 F	<ul style="list-style-type: none"> • For shooting a large number of pictures.
VGA 4 : 3 F	<ul style="list-style-type: none"> • For shooting a large number of pictures. • For attaching to e-mail. • For posting on a website.

Defaults Settings/Functions Whose Defaults Are Restored When the Camera Is Turned Off

Turning the camera off may reset some function settings to their defaults. The table below indicates whether or not the function is reset to its default when the camera is turned off.

○: setting is saved ×: setting is reset

	Function		Default Settings
Shooting	Dynamic Range Expansion	○	AUTO
	Soft Focus Options	○	Strong
	Vignetting	○	Weak
	Toy Color	○	On
	Hue	○	Basic
	Plus Normal Shooting	○	Off
	Picture Quality/Size	○	10M 4 : 3 N
	Density	○	Normal
	Size (Text Mode)	○	10M 4 : 3
	Movie Size	○	HD 1280
	Focus	○	Multi AF
	Pre-AF	○	Off
	Exposure Metering	○	Multi
	Image Settings	○	Standard
	Super Resolution	○	Off
	Noise Reduction	○	Auto
	Flash Exposure Compensation	○	0.0
	Auto Bracket	○	Off
	Time Exposure	○	Off
	Custom Self-Timer	○	Pictures: 2 Pics, Interval: 5 Sec.
	Interval Shooting	×	0 Sec.
	Camera Shake Correction	○	On
	Slow Shutter Limit	○	Off
	Date Imprint	○	Off
	Exposure Compensation	○	0.0
	White Balance	○	Multi-P AUTO
	ISO Setting	○	Auto
	Maximum ISO for ISO Auto	○	AUTO 1600
	Macro	○	Macro Off

○: setting is saved ×: setting is reset

	Function		Default Settings
Shooting	Flash	○	Auto
	Self-Timer	×	Self-Timer Off
Playback	Volume Adjustment	○	—
Setup	LCD Brightness	○	—
	Reg. My Settings	○	—
	Step Zoom	○	Off
	Set Fn Button	○	AF/Subj.Trckng
	ADJ Button Setting 1	○	Exposure Comp.
	ADJ Button Setting 2	○	White Balance
	ADJ Button Setting 3	○	ISO
	ADJ Button Setting 4	○	Quality
	AF Auxiliary Light	○	On
	Operation Sounds	○	All
	Volume Settings	○	■ ■ □ (Medium)
	LCD Confirmation Time	○	0.5 seconds
	Auto Power Off	○	5 minutes
	LCD Auto Dim	○	On
	Digital Zoom Image	○	Normal
	Level Setting	○	Display
	Grid Guide Display Options	○	
	Function Guide	○	On
	Shooting Info. Display Frame	○	Off
	Minimum Distance	○	Show
	Auto Rotate	○	On
	White Saturation Display	○	Off
	Card Sequence No.	○	Off
	USB Connection Type	○	Mass Storage
	Date Settings	○	—
	Language/言語	○	*1
	Video Out Mode	○	*1
	HDMI Output	○	AUTO
	Sleep Mode	○	Off
	Confirm Firmware Version	—	—
	Eye-Fi Connection Settings	○	On
Eye-Fi Connection Display	—	—	

*1 The default setting varies depending on where you purchased the camera.

Using Your Camera Abroad

Battery Charger (Model BJ-10)

The battery charger can be used in regions with a current of 100-240V, 50 Hz/60 Hz. If you are going to travel to a country that uses a different shaped wall outlet/plug, please consult your travel agent on a plug adapter suitable for wall outlets in your country of destination.

Do not use electrical transformers. It may damage the camera.

Warranty

This product was manufactured for use in the country in which it was purchased. The warranty is only valid in the country in which the camera was purchased. Should the product fail or malfunction while you are abroad, the manufacturer assumes no responsibility for servicing the product locally or bearing the expenditure incurred therefore.

Playback on Television in Other Regions

Playback is possible on televisions (or monitors) equipped with a video input terminal. Please use the AV cable provided.

This camera is compatible with both NTSC and PAL television formats. Set the video format on the camera to match that of the television you are using.

When you go abroad, set your camera to the local video format.

Cautions on Use

Cautions on Use

- This product was manufactured for use in the country in which it was purchased. The warranty is only valid in the country in which the camera was purchased.
- Should the product fail or malfunction while you are abroad, the manufacturer assumes no responsibility for servicing the product locally or bearing the expenditure incurred therefore.
- Be sure not to drop or apply any sudden force to the camera.
- While you are carrying the camera, be careful not to hit it against other objects. Take special care to not hit the lens and picture display.
- Firing the flash consecutively may heat the firing unit. Do not fire it consecutively more than necessary.
- Do not touch the flash and keep foreign objects away from the firing unit. Doing so can cause burns and fires.
- Do not fire the flash near eyes. It could cause visual impairment (particularly for infants).
- Do not fire the flash near the driver of a vehicle to avoid causing accidents.

- The battery may become hot after extended use. Touching the battery immediately after use could result in burns to your fingers.
- If the picture display or panel is exposed to sunlight, they may become washed out and images may become hard to view.
- The picture display and panel may contain some pixels that do not remain lit up continually in part or at all. Also, the brightness may become uneven because of the characteristics of LCDs. These are not failures.
- Do not forcefully press the surface of the picture display.
- In an environment where the temperature changes suddenly, condensation may occur in the camera, resulting in troubles such as fogging of the glass surface or malfunctions of the camera. If this occurs, place the camera in a bag to slow the temperature change as much as possible. Take it out of the bag after the temperature difference from the atmosphere has decreased to a fairly small amount. If condensation occurs, remove the battery and memory card, and wait until the moisture has dried before using the camera.
- To avoid damaging the connectors, do not put any objects into the camera's microphone or speaker holes.
- Do not get the camera wet. Do not operate the camera with wet hands. This can result in malfunction or an electrical shock.
- Before taking any important pictures (such as at weddings, on trips abroad, etc.), test the camera to check operation and ensure proper functioning. We recommend that you keep this manual and spare battery on hand.



Conditions in which condensation may easily occur: -----

- When the camera is moved to an environment where the temperature differs greatly.
- In humid places.
- In a room immediately after being heated, or when the camera is exposed directly to cooled air from an air-conditioner or another similar appliance.

Care and Storage

Care

- Please note that if fingerprints, dirt, etc. get onto the lens, picture quality will suffer.
- When dust or dirt does get on the lens, do not touch it directly with your fingers, and either use a blower (available in stores) to blow it off, or a soft cloth to gently dust it off. Special care should be taken for the lens barrel.
- After use at the beach or around chemicals, wipe it off particularly carefully.
- In the unlikely event that your camera fails to work properly, please consult your Ricoh Repair Center.
- There are high voltage circuits in this camera. As this is dangerous, do not dismantle this camera under any circumstances.
- Do not get volatile substances, such as thinner, benzene, or pesticides on your camera. This may cause a change in quality, paint to peel, etc.
- As the surface of the picture display is easily scratched, do not rub hard objects against it.
- Clean the surface of the picture display by wiping gently with a soft cloth containing a small amount of display cleaner (that does not contain organic solvents) sold in stores.

Use and Storage

- Please avoid using or storing your camera in the following kinds of places, as this may damage the camera.
 - In high heat and humidity, or where there is severe change in temperature or humidity.
 - Places with a lot of dust, dirt or sand.
 - Places with severe vibration.
 - Places where it is in direct contact with vinyl or rubber products or chemicals, including mothballs or other insect repellent, for long periods of time.
 - Places with strong magnetic fields (near a monitor, transformer, magnet, etc.).
- Store your camera in a dust-free camera bag, etc. to prevent dust or dirt from getting on the camera. Also, avoid carrying the camera without a case (in your pocket, etc.) to help to keep free from dust or fiber particles.
- Remove the battery if you are not going to use the camera for a long period of time.

Precautions regarding care of your camera

1. Be sure to turn the power off.
2. Remove the batteries before caring for your camera.

Warranty and Servicing

1. This product is backed by a limited warranty. During the warranty period mentioned in the Warranty supplied with your camera, any defective parts will be repaired free of charge. In the event of a camera malfunction, contact the dealer from which you purchased the camera or your nearest Ricoh Repair Center. Please note that you will not be reimbursed for the cost of bringing the camera to the Ricoh Repair Center.
2. This warranty does not cover any damage resulting from:
 - ① failure to follow the instructions in the instruction manual;
 - ② repair, modification or overhaul not conducted by an authorized service center listed in the instruction manual;
 - ③ fire, natural disaster, act of God, lightning, abnormal voltage, etc.;
 - ④ improper storage (noted in the "Camera User Guide"), mold, or otherwise insufficient care of the camera.
 - ⑤ submergence in water (flooding), exposure to alcohol or other beverages, infiltration of sand or mud, physical shock, dropping of the camera, or pressure on the camera, and other unnatural causes.
3. After the warranty period has passed, you will be liable for all repair fees, including those incurred at an authorized service center.
4. You will be liable for all repair fees, even within the warranty period, if the warranty card is not attached or if the distributor's name or the purchase date have been changed or are not indicated on the card.
5. Expenses for overhaul and thorough inspection by special request of the customer will be charged to the customer, whether or not they are incurred during the warranty period.
6. This warranty only applies to the camera and not to the accessories, such as the case and strap, nor does it apply to the battery and other consumables provided.
7. Any consequential damages arising from failure of the camera, such as expenses incurred in taking pictures or loss of expected profit, will not be reimbursed whether they occur during the warranty period or not.
8. The warranty is only valid in the country in which the camera was purchased.
 - * The above provisions refer to repairs offered free of charge, and do not limit your legal rights.
 - * The intention of the above provisions is also described in the warranty card provided with this camera.
9. Parts essential to the servicing of the camera (that is, components required to maintain the functions and quality of the camera) will be available for a period of five years after the camera is discontinued.
10. Please note that if the camera is seriously damaged by flooding, submergence, infiltration of sand or mud, violent shocks or dropping, it may not be repairable, and restoration to its original condition may be impossible.



Note

- Before sending the camera in for repair, check the battery and read the instruction manual again to ensure proper operation.
- Some repairs require a significant amount of time to be completed.
- When sending the camera to a service center, please include a note which describes the defective part and the problem as precisely as possible.
- Remove all accessories not related to the problem before sending the camera to the service center.
- This warranty does not apply to data stored on an SD memory card or in internal memory.

INFORMATION TO THE USER

USA FCC Part 15 Class B

This equipment has been tested and found to comply with the limits for a Class B digital device, pursuant to part 15 of the FCC Rules. These limits are designed to provide reasonable protection against harmful interference in a residential installation. This equipment generates, uses and can radiate radio frequency energy and if not installed and used in accordance with the instructions, may cause harmful interference to radio communications. However, there is no guarantee that interference will not occur in a particular installation. If this equipment does cause harmful interference to radio or television reception, which can be determined by turning the equipment off and on, the user is encouraged to try to correct the interference by one or more of the following measures:

- Reorient or relocate the receiving antenna.
- Increase the separation between the equipment and receiver.
- Connect the equipment into an outlet on a circuit different from that to which the receiver is connected.
- Consult the dealer or an experienced radio/TV technician for help. (FCC 15.105B)

Changes or modifications not expressly approved by the party responsible for compliance could void the user's authority to operate the equipment. (FCC 15.21)

Properly shielded and grounded cables and connectors must be used for connections to host computer in order to comply with FCC emission limits. (FCC 15.27)

An AC adapter with a ferrite core must be used for RF interference suppression.

COMPLIANCE INFORMATION STATEMENT

Product Name: DIGITAL CAMERA

Model Number: CX5

This device complies with Part 15 of the FCC Rules.

Operation is subject to the following two conditions:

- (1) This device may not cause harmful interference, and
- (2) This device must accept any interference received, including interference that may cause undesired operation.

RICOH AMERICAS CORPORATION

5 Dedrick Place, West Caldwell NJ, 07006 Tel.: 1-800-225-1899

Note to Users in Canada

Note: This Class B digital apparatus complies with Canadian ICES-003

Remarque Concernant les Utilisateurs au Canada

Avertissement : Cet appareil numérique de la classe B est conforme à la norme NMB-003 du Canada

IMPORTANT SAFETY INSTRUCTIONS-SAVE THESE INSTRUCTIONS

DANGER-TO REDUCE THE RISK OF FIRE OR ELECTRIC SHOCK, CAREFULLY FOLLOW THESE INSTRUCTIONS.

Index

A

ADJ./OK Button	16, 18, 52
ADJ Button Setting	52, 111
Adobe Reader	127
AE/AF Target Shift	53
AE Lock	57
AF Auxiliary Light	17, 111
AF Window	17
Auto Bracket	82, 88
Auto Power Off	28, 111
Auto Rotate	113
Auto Shooting Mode	15, 30
AV Cable	107

B

Battery	26, 27
Battery/Card Cover	18, 27
Battery Charger	14, 26

C

Camera Shake	32
Camera Shake Correction	84
Card Sequence No.	113
Change Grid Point	94
Color Bracket (CL-BKT)	89
Common Terminal for USB Port/AV Output	18, 107, 118, 124, 131
Confirm Firmware Version	114
Continuous Mode	15, 64
Cooking	60
Copy to Card from Internal Memory	95
Creative Shooting Mode	15, 68
Cross Process	68
Custom Self-Timer	83

D

Date Imprint	84
Date Settings	28, 114
Delete	42
Delete Button	18, 42
Density	80
Digital Zoom	34, 117
Digital Zoom Image	34, 112, 117
Direct Print	118
Discreet Mode	59
DISP. Button	18, 45
DL-10	123

DPOF	95, 106
Dynamic Range Double Shot	68, 70
Dynamic Range Expansion	70, 79

E

Enlarged View	41
Error Messages	134
Export Still Images	76, 94
Exposure Compensation	84, 90
Exposure Metering	81
Eye-Fi	114
Eye-Fi Cards	24

F

Fireworks	60
Flag Function Display	94
Flag Function Setting	94, 96
Flash	17, 18, 35
Flash Exposure Compensation	82
Fn (Function) Button	18, 55
Focus	80, 86
Focus Bracket (FOCUS-BKT)	89
Format [Card]	110
Format [Internal Memory]	110
Function Guide	112

G

Golf Swing Continuous Mode	60
Grid Guide Display	45
Grid Guide Display Options	112

H

Hand strap	14
HDMI Micro Output Terminal (Type D)	18
HDMI Output	114
High Contrast B&W	68
High Sens	60
Histogram Display	50
Hue	79

I

Image Settings	81
Internal Memory	147
Interval Shooting	83
ISO Setting	84, 92

L

Landscape	59
Language/言語	114
LCD Auto Dim	112
LCD Brightness	110

LCD Confirmation Time	111
Lens	17
Lens Cover	17
Level Compensation	94, 100
Level Indicator	48
Level Setting	48, 112

M

M-Cont Plus (10M)	64, 66
M-Cont Plus (2M)	64, 67
Macro	18, 34
Macro Target	56
Manual Focus (MF)	87
Maximum ISO for ISO Auto	85
MediaBrowser	123
MENU Button	18, 78, 93, 109
Microphone	17
Miniaturize	68, 71
Minimum Distance	113
Mode Dial	15, 17
Movie Mode	15, 73
Movie Size	80
MP File	74
Multi-Target AF	86
My Settings Mode (MY)	15, 115

N

Night. Port.	59
Night Landscape Multi-shot	60
Nightscape	38
Noise Reduction	82

O

Operation Sounds	111
------------------------	-----

P

Pets	60
PictBridge	118
Picture Display	18, 19
Picture Quality/Size	79
Playback Button	18, 28, 39, 93
Playback Menu	93
Playback Mode	28, 39
Plus Normal Shooting	72, 79
Portrait	59
Power	28
POWER Button	17, 28
Pre-AF	80
Protect	95, 104

R

Rechargeable Battery	26, 27
Recover File	95
Reg. My Settings	110, 115
Resize	94
Restore Defaults	85

S

Scene Auto Mode (S-AUTO)	15, 38
Scene Mode (SCENE)	15, 59
SD Memory Card	24, 27, 147
Self-timer	18, 37
Self-Timer Lamp	17
Set Fn Button	55, 110
Setup Menu	109
Shooting Info. Display Frame	112
Shooting Menu	78
Shutter Release Button	17, 30
Size	80
Skew Correction	94, 103
Skew Correct Mode	61, 63
Sleep Mode	114
Slide Show	95
Slow Shutter Limit	84
Soft Focus	68
Soft Focus Options	79
Speaker	18
Speed Cont (High)	64, 67
Speed Cont (Low)	64, 67
Sports	60
Step Zoom	110
Subject Tracking AF	86
Super Resolution	82
Super Resolution Zoom	33
Synchro-Monitor Mode	45

T

Text Mode	61
Thumbnail View	39
Time Exposure	82
Toy Camera	68
Toy Color	79
Trim	94, 97
Tripod Screw Hole	18

U

USB cable	118, 124, 131
USB Connection Type	113

V

Video Out Mode.....	114
Vignetting.....	79
VM-1.....	132
Volume Settings.....	111

W

White Balance	84, 91
White Balance Bracket (WB-BKT).....	88
White Balance Compensation.....	94, 102
White Saturation Display	47, 113
White Saturation Highlights Display....	47

Z

Zoom.....	33
Zoom Lever.....	17, 33
Zoom Macro.....	60

Telephone Support Numbers in Europe

UK	(from within the UK) (from outside the UK)	0203 239 6327 +44 203 239 6327
Deutschland	(innerhalb Deutschlands) (außerhalb Deutschlands)	06331 268 438 +49 6331 268 438
France	(à partir de la France) (en dehors de la France)	0800 88 18 70 +33 1 60 60 19 94
Italia	(dall'Italia) (dall'estero)	02 4004 7319 +39 02 4004 7319
España	(desde España) (desde fuera de España)	900984912 +49 6331 268 440

<http://www.service.ricohpmmc.com/>

From environmental friendliness to environmental conservation and to environmental management

Ricoh is aggressively promoting environment-friendly activities and also environment conservation activities to solve the great subject of management as one of the citizens on our precious earth.



To reduce the environmental loads of digital cameras, Ricoh is also trying to solve the great subjects of "Saving energy by reducing power consumption" and "Reducing environment-affecting chemical substances contained in products".

If a problem arises

First of all, see "Troubleshooting" (☞ P.134) in this manual. If the issues still persist, please contact a Ricoh office.

Ricoh Offices	
RICOH COMPANY, LTD.	3-2-3, Shin-Yokohama Kouhoku-ku, Yokohama City, Kanagawa 222-8530, JAPAN http://www.ricoh.com/r_dc/
RICOH AMERICAS CORPORATION	5 Dedrick Place, West Caldwell, New Jersey 07006, U.S.A. 1-800-22RICOH http://www.ricoh-usa.com/
RICOH INTERNATIONAL B.V. (EPMCM)	Oberrather Straße 6, D-40472 Düsseldorf, GERMANY (innerhalb Deutschlands) 06331 268 438 (außerhalb Deutschlands) +49 6331 268 438 http://www.ricoh.com/r_dc/
RICOH ASIA PACIFIC OPERATIONS LIMITED	21/F, One Kowloon, 1 Wang Yuen Street, Kowloon Bay, Hong Kong
About MediaBrowser	
North America (U.S.)	(Toll Free) +1-800-458-4029
Europe	UK, Germany, France and Spain: (Toll Free) +800-1532-4865 Other Countries: +44-1489-564-764
Asia	+63-2-438-0090
China	+86-21-5385-3786
Business hours: 9:00 AM to 5:00 PM	

Ricoh Company, Ltd.
Ricoh Building, 8-13-1, Ginza, Chuo-ku, Tokyo
104-8222, Japan
2011 February

En EN (USA) GB (GB) AE (AE)
Printed in China



* L 7 6 1 2 9 7 1 *