

RICOH

CX3

Camera User Guide

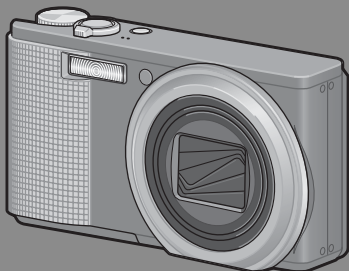

The serial number of this product is given on the bottom face of the camera.

Basic Operations

If you are using the camera for the first time, read this section.

This section provides a basic overview of how to turn on the camera, take pictures and play back pictures.

Advanced Operations

Read this section when you want to learn more about the different camera functions.

This section provides more detailed information about the functions used to take pictures and play back pictures, as well as information on how to customize the camera settings, print pictures, and use the camera with a computer.

The rechargeable battery needs to be charged before use. The battery is not charged at the time of purchase.

Preface

This manual provides information on how to use the shooting and playback functions of this product, as well as warnings on its use.

To make the best use of this product's functions, read this manual thoroughly before use. Please keep this manual handy for ease of reference.

Ricoh Co., Ltd.

Safety Precautions	For the safe use of your camera, be sure to read the safety precautions thoroughly.
Test Shooting	Please be sure to do some test shooting to make sure it is recording properly before normal use.
Copyright	Reproduction or alteration of copyrighted documents, magazines, music and other materials, other than for personal, home or similarly limited purposes, without the consent of the copyright holder is prohibited.
Exemption from Liability	Ricoh Co., Ltd. assumes no liability for failure to record or play back images caused by malfunction of this product.
Warranty	This product is manufactured to local specifications and the warranty is valid within the country of purchase. Should the product fail or malfunction while you are abroad, the manufacturer assumes no responsibility for servicing the product locally or bearing the expenditure incurred thereof.
Radio Interference	Operating this product in the vicinity of other electronic equipment may adversely affect the performance of both devices. In particular, operating the camera close to a radio or television may lead to interference. If interference occurs, follow the procedures below. <ul style="list-style-type: none">• Move the camera as far away as possible from the TV, radio or other device.• Reorient the TV or radio antenna.• Plug the devices into separate electrical outlets.

© 2010 RICOH CO., LTD. All rights reserved. This publication may not be reproduced in whole or in part without Ricoh's express written permission. Ricoh reserves the right to change the contents of this document at any time without prior notice.

Every effort has been made to ensure the accuracy of the information in this document. Should you nevertheless notice any errors or omissions, we would be grateful if you would notify us at the address listed on the back cover of this booklet.

Microsoft, Windows, Windows Vista, Windows 7™, and Internet Explorer are registered trademarks of Microsoft Corporation in the United States of America and other countries. Macintosh and Mac OS are registered trademarks of Apple Inc. in the United States of America and other countries. Adobe, the Adobe logo, and Adobe Reader are trademarks of Adobe Systems Incorporated in the United States and other countries. All other trade names mentioned in this document are the property of their respective owners.

Safety Precautions

Warning Symbols

Various symbols are used throughout this instruction manual and on the product to prevent physical harm to you or other people and damage to property. The symbols and their meanings are explained below.



Danger

This symbol indicates matters that may lead to imminent risk of death or serious injury if ignored or incorrectly handled.



Warning

This symbol indicates matters that may lead to death or serious injury if ignored or incorrectly handled.



Caution

This symbol indicates matters that may lead to injury or physical damage if ignored or incorrectly handled.

Sample Warnings



The  symbol alerts you to actions that must be performed.



The  symbol alerts you to prohibited actions.

The  symbol may be combined with other symbols to indicate that a specific action is prohibited.

● Examples

 Do not touch  Do not disassemble

Observe the following precautions to ensure safe use of this equipment.

Danger



● Do not attempt to disassemble, repair or alter the equipment yourself. The high-voltage circuitry in the equipment poses significant electrical hazard.



● Do not attempt to disassemble, alter or directly solder the battery.



● Do not put the battery in a fire, attempt to heat it, use it in a high temperature environment such as next to a fire or inside a car, or abandon it. Do not put it into water or the sea or allow it to get wet.



● Do not attempt to pierce, hit, compress, drop, or subject the battery to any other severe impact or force.



● Do not use a battery that is significantly damaged or deformed.

Warning



- Turn off the power immediately in the event of abnormalities such as smoke or unusual odors being emitted. Remove the battery as soon as possible, being careful to avoid electric shocks or burns. If you are drawing power from a household electrical outlet, be sure to unplug the power cord from the outlet to avoid fire or electrical hazards. Discontinue use of the equipment immediately if it is malfunctioning. Contact the nearest service center at your earliest convenience.



- Turn off the power immediately if any metallic object, water, liquid or other foreign object gets into the camera. Remove the battery and memory card as soon as possible, being careful to avoid electric shocks or burns. If you are drawing power from a household electrical outlet, be sure to unplug the power cord from the outlet to avoid fire or electrical hazards. Discontinue use of the equipment immediately if it is malfunctioning. Contact the nearest service center at your earliest convenience.



- Avoid any contact with the liquid crystal inside the picture display, should the monitor be damaged. Follow the appropriate emergency measures below.
- SKIN: If any of the liquid crystal gets on your skin, wipe it off and rinse the affected area thoroughly with water, then wash well with soap.
- EYES: If it gets in your eyes, wash your eyes with clean water for at least 15 minutes and seek medical advice immediately.
- INGESTION: If any of the liquid crystal is ingested, rinse the mouth out thoroughly with water. Have the person drink a large amount of water and induce vomiting. Seek medical assistance immediately.



- Follow these precautions to prevent the battery from leaking, overheating, igniting or exploding.
- Do not use a battery other than those specifically recommended for the equipment.
- Do not carry or store together with metal objects such as ballpoint pens, necklaces, coins, hairpins, etc.
- Do not put the battery into a microwave or high pressure container.
- If leakage of battery fluid or a strange odor, color change, etc. is noticed during use or during charging, remove the battery from the camera or battery charger immediately and keep it away from fire.



- Please observe the following in order to prevent fire, electrical shock or cracking of the battery while charging.
- Use only the indicated power supply voltage. Also avoid the use of multi-socket adapters and extension cords.
- Do not damage, bundle or alter power cords. Also, do not place heavy objects on, stretch or bend power cords.
- Do not connect or disconnect the power plug with wet hands. Always grip the plug section when disconnecting a power cord.
- Do not cover equipment while charging.



- Keep the battery and SD memory card used in this equipment out of the reach of children to prevent accidental ingestion. Consumption is harmful to human beings. If swallowed, seek medical assistance immediately.



- Keep the equipment out of the reach of children.



- Do not touch the internal components of the equipment if they become exposed as a result of being dropped or damaged. The high-voltage circuitry in the equipment could lead to an electric shock. Remove the battery as soon as possible, being careful to avoid electric shocks or burns. Take the equipment to your nearest dealer or service center if it is damaged.



- Do not use the equipment in wet areas as this could result in fire or electric shock.



- Do not use the equipment near flammable gases, gasoline, benzene, thinner or similar substances to avoid the risk of explosion, fire or burns.
- Do not use the equipment in locations where usage is restricted or prohibited as this may lead to disasters or accidents.



- Wipe off any dust that accumulates on the electrical plug as this may lead to fire.
- Use only the specified AC adapter in household electrical outlets. Other adapters pose the risk of fire, electric shock or injury.



- To avoid the risk of fire, electric shock or injury, do not use the battery charger or AC adapter with commercially available electronic transformers when traveling abroad.

Observe the following precautions to ensure safe use of this unit.

Caution



- Contact with fluid leaking from a battery can lead to burns. If part of your body comes in contact with a damaged battery, rinse the area with water immediately. (Do not use soap.)
If a battery starts to leak, remove it immediately from the equipment and wipe the battery chamber thoroughly before replacing it with a new battery.



- Plug the power cords securely into the electrical outlets. Loose cords pose a fire hazard.



- Do not allow the camera to get wet. In addition, do not operate it with wet hands. Both pose the risk of electric shock.





- Do not fire the flash at drivers of vehicles, as this may cause the driver to lose control and result in a traffic accident.

Safety Precautions for Accessories

When using optional products, carefully read the instructions provided with the product before using that product.

Using the Manuals

The following two manuals are included with your CX3.

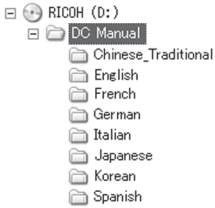
	<p>"Camera User Guide" (This booklet)</p> <p>This guide explains the usage and functions of the camera. It also explains how to install the provided software on your computer.</p>
	<p>"Software User Guide" (PDF file)</p> <p>The "Software User Guide" is available in the following folders on the provided CD-ROM. This guide explains how to download images from the camera to your computer.</p> <p>Each language has its own "Software User Guide" in the respective folder.</p>  <p>To copy the User Guide onto your hard disk, copy the PDF file from the respective folder directly to your hard disk.</p>

"Irodio Photo & Video Studio" image viewing and editing software (for Windows only) is also included with the camera. For how to use Irodio Photo & Video Studio, see the displayed "Help". For more information on Irodio Photo & Video Studio, contact the Customer Support Center below.

North America (U.S.)

TEL: (Toll Free) +1-800-458-4029

Europe

UK, Germany, France and Spain:

TEL: (Toll Free) +800-1532-4865

Other Countries:

TEL: +44-1489-564-764

Asia

TEL: +63-2-438-0090

China

TEL: +86-21-5385-3786

Business hours: 9:00 AM to 5:00 PM

Contents

Safety Precautions	1
Using the Manuals	4
Contents	5

Basic Operations **11**

Packing List	12
Optional Accessories	12
How to Use the Mode Dial	13
Names of Parts	14
Picture Display	16
Getting Ready	19
About the Battery	19
About the SD Memory Card (available in stores)	20
Charging the Rechargeable Battery	21
Loading the Rechargeable Battery and SD Memory Card	22
Turning the Power On/Off	23
Setting the Language, Date and Time	23
Basic Shooting	25
Shooting in Auto Shooting Mode (Focus and Shoot)	25
Using the Zoom Function	27
Shooting Close-Ups (Macro Shooting)	28
Using the Flash	29
Using the Self-timer	30
Shooting in Scene Auto Mode	31
Playing Back Images	32
Viewing Your Images	32
Thumbnail View	32
Enlarging Images	34
Deleting Files	35
Deleting a File or All Files	35
Specifying Multiple Files Separately	36
Specifying a Range of Multiple Files	37
Changing the Display with the DISP. Button	38
About the Electronic Level	40
About the Histogram Display	42

1 ADJ. Button Functions 44

- Selecting Shooting Menu Options Assigned to the ADJ/OK Button..... 44
- Shifting the AE and AF Targets..... 45

2 Using the Fn (Function) Button 46

- Assigning a Role to the Fn Button 47
- Shifting the AF Target for Macro Shooting 47
- Locking the Exposure 48
- Choosing a Focus Setting 49

3 Shooting Mode Types 50

- Scene Mode (SCENE) 50
 - Selecting a Scene Mode 52
 - Shooting in Miniaturization Mode 53
 - Using Skew Correction Mode 55
- Dynamic Range Double Shot Mode (DR) 56
 - Dynamic Range Expansion Effect 57
 - Dynamic Range Expansion Plus Normal Shooting 57
- Continuous Mode (C) 58
 - M-Cont Plus (10M) 59
 - M-Cont Plus (2M) 60
 - Speed Cont (Low)/Speed Cont (High) 60
- Movie Mode (M) 61
 - Shooting Movies 61

4 Playback Functions 62

- Playing Back Movies 62
- Playing Back MP Files 62
 - Exporting MP Files 64

5 Shooting Menu 66

- Using the Menu 66
- Shooting Menu Options 67
 - Dynamic Range Expansion: Dynamic Range Expansion Effects 67
 - Plus Normal Shooting: Recording Un-enhanced Copies of Enhanced Photographs 67
 - Picture Quality/Size: Choosing Size and Compression Options for Photographs 67

Movie Size: Choosing a Frame Size for Movies.....	67
Density: Adjusting Contrast in Text Mode	67
Size: Choosing the Size of Photographs Taken in Text Mode	67
Focus: Choosing How the Camera Focuses.....	67
Pre-AF: Improving Shutter Response	68
Exposure Metering: Choosing How the Camera Sets Exposure	68
Image Settings: Adjusting Contrast, Sharpness, Color, and Vividness.....	68
Noise Reduction: Controlling Image "Noise"	69
Flash Exposure Compensation: Adjusting Flash Level.....	69
Auto Bracket: Varying Settings over a Series of Photographs	69
Time Exposure: Creating Light Trails	69
Custom Self-Timer: Taking a Series of Pictures with the Self-Timer.....	69
Interval Shooting: Interval Timer Photography	70
Camera Shake Correction: Reducing Blur Caused by Camera Shake	70
Slow Shutter Limit: Choosing the Slowest Available Shutter Speed.....	71
Date Imprint: Imprinting the Time and Date of Recording on Photographs....	71
Exposure Compensation: Adjusting Exposure.....	71
White Balance: Adjusting Colors According to the Light Source	71
ISO Setting: Controlling the Camera's Sensitivity to Light.....	71
Restore Defaults: Restoring Default Shooting Menu Settings	71
Focus	72
Multi-Target AF: Varying the Focus Position over a Series of Photographs... 72	
Manual Focus (MF): Focusing Manually.....	73
Auto Bracketing.....	73
Auto Bracket: Varying Exposure over a Series of Photographs.....	74
White Balance Bracket (WB-BKT): Creating Photographs with Varying White Balance	74
Color Bracketing (CL-BKT): Creating Photographs with Varying Color Settings	74
Focus Bracketing (FOCUS-BKT): Varying Focus Distance over a Series of Photographs	75
Exposure Compensation	76
White Balance.....	77
Manual Settings: Measuring White Balance.....	78
ISO Setting: ISO Sensitivity.....	78

6 Playback Menu 79

Using the Menu	79
Playback Menu Options.....	80
Flag Function Setting: Flagging Images	80

Flag Function Display: Viewing Flagged Images	80
Export Still Images: Exporting Selected Images from an MP File	80
Resize: Creating Small Copies of Images	80
Trim: Creating Cropped Copies	80
Level Compensation: Creating Copies with Modified Brightness and Contrast.....	80
White Balance Compensation: Creating Copies with Modified White Balance	80
Skew Correction: Reducing the Effects of Perspective.....	80
Protect: Protecting Images from Accidental Deletion	80
Slide Show: Automatic Playback	80
Copy to Card from Internal Memory: Copying Pictures from Internal Memory to a Memory Card.....	81
DPOF: Selecting Pictures for Printing	81
Recover File: Restoring Deleted Files.....	81
Flag Function Setting.....	82
Setting/Canceling One File at a Time.....	82
Setting/Canceling Multiple Files at One Time	82
Trim	83
Level Compensation.....	85
Correcting Images Automatically.....	86
Correcting Images Manually.....	86
White Balance Compensation.....	87
Skew Correction.....	88
Protect.....	89
DPOF	90
Viewing Pictures on TV	91

7 Setup Menu 92

Using the Menu	92
Setup Menu Options.....	93
Format [Card]: Formatting Memory Cards.....	93
Format [Internal Memory]: Formatting Internal Memory	93
LCD Brightness: Adjusting the Picture Display Brightness.....	93
Reg. My Settings: Saving Camera Settings	93
Step Zoom: Adjusting Zoom in Discrete Steps	93
Set Fn Button: Choosing a Role for the Fn Button.....	93
ADJ Button Setting 1–4: Choosing Roles for the ADJ. Button.....	93
Maximum ISO for ISO Auto: Choosing an Upper Limit for Auto ISO Sensitivity.....	93

AF Auxiliary Light: Assisting Autofocus	93
Operation Sounds: Choosing the Sounds Made by the Camera.....	94
Volume Settings: Controlling Volume	94
LCD Confirmation Time: Displaying Photos After Shooting	94
Auto Power Off: Camera Power Saving	94
LCD Auto Dim: Picture Display Power Saving.....	94
Digital Zoom Image: Recording Photos Taken with Digital Zoom at Actual Size	94
Level Setting: Adjusting Tilt Indicator Settings	94
Grid Guide Display Options: Choosing a Framing Guide.....	95
Shooting Info. Display Frame: Viewing Settings at a Glance.....	95
Minimum Distance: Displaying the Minimum Focus Distance.....	95
Auto Rotate: Rotating Pictures for Playback.....	95
White Saturation Display: Viewing Image Highlights	95
Card Sequence No.: File Numbering Options.....	96
Date Settings: Setting the Camera Clock	96
Language/言語: Choosing a Language.....	96
Video Out Mode: Choosing a Video Format.....	96
Reg. My Settings.....	97
Digital Zoom Image.....	98

8 Direct Printing 99

About the Direct Print Function	99
Connecting the Camera to a Printer	99
Printing Still Images	100
Printing One or All Still Images	100
Printing Several Still Images.....	102

9 Downloading Images to Your Computer 103

For Windows	103
System Requirements for Using the Supplied CD-ROM.....	103
CD-ROM Setup.....	104
Copying Pictures to Your Computer.....	107
For Macintosh.....	109
Copying Pictures to Your Computer.....	109
Using the MP File Viewer	110

Troubleshooting.....	112
Error Messages	112
Camera Troubleshooting.....	113
Available Settings	118
Specifications	122
Number of Images That Can Be Stored.....	124
Defaults Settings/Functions Whose Defaults Are Restored When the Camera Is Turned Off.....	126
Using Your Camera Abroad	128
Cautions on Use.....	129
Care and Storage.....	130
Warranty and Servicing	131
Index.....	133

Basic Operations

If you are using the camera for the first time, read this section.

Packing List	12
How to Use the Mode Dial	13
Names of Parts	14
Picture Display	16
Getting Ready	19
Basic Shooting	25
Playing Back Images	32
Deleting Files	35
Changing the Display with the DISP. Button	38

Packing List

Open the package and make sure all the items are included.

* The actual appearance of items included may differ.

• CX3

The serial number of the camera is provided on the bottom face of the camera.

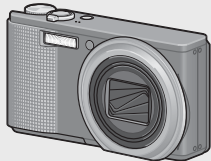

- USB Cable (Mini B cable)
- AV Cable
- Handstrap

• Rechargeable Battery



• Battery Charger

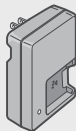

- Warranty
- Camera User Guide
- CD-ROM (P.103)

Optional Accessories

• Soft Case (SC-90)

Used to store your camera.

• Rechargeable Battery (DB-100)

• Battery Charger (BJ-10)

• Cable Switch (CA-1)

A switch that connects to the camera's USB terminal to operate the shutter.

• Neck Strap (ST-2)

A double-loop neck strap with embroidered RICOH logo.



Note

Attaching the Handstrap/Neck Strap to the Camera

Thread the small end of the strap through the strap eyelet on the camera and loop the ends. Remove the end of the neck strap from the buckle and attach it as shown in the illustration.

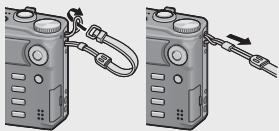



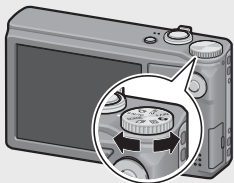

- For the latest information on optional accessories, see the Ricoh website (<http://www.ricohpmmc.com/>).

How to Use the Mode Dial

Set the mode dial to the desired mode before shooting still images or movies.



Mode Dial Symbols and Descriptions

Symbol	Function	Description	Refer to
	Auto Shooting Mode	Automatically sets the optimal aperture value and shutter speed depending on the subject.	P.25
MY1, MY2	My Settings Mode	You can shoot using the settings registered in [Reg. My Settings].	P.97
	Movie Mode	Allows you to shoot movies.	P.61
S-AUTO	Scene Auto Mode	The camera automatically selects the optimal scene mode for simple point-and-shoot photography.	P.31
SCENE	Scene Mode	Allows you to shoot with settings optimized for the shooting scene.	P.50
	Continuous Mode	You can shoot with various continuous shooting functions.	P.58
	Dynamic Range Double-shot Mode	Allows you to shoot images that look natural even in the dark areas and bright areas of scenes with high contrast.	P.56

If you are using the camera for the first time, read this section.



Names of Parts

Camera

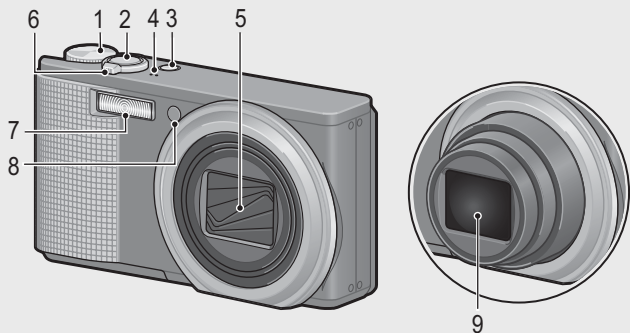
Front View



If you are using the camera for the first time, read this section.

	Item Name	Refer to
1	Mode Dial	P.13, 25, 31, 52, 56, 58, 61
2	Shutter Release Button	P.25
3	POWER Button	P.23
4	Microphone	P.61
5	Lens Cover	—
6	Zoom Lever  (Telephoto)/  (Wide-angle) Q (Enlarged View)/  (Thumbnail View)	P.27, 32, 34
7	Flash	P.29
8	AF Auxiliary Light/Self-Timer Lamp	P.30, 93
9	Lens	—

Rear View

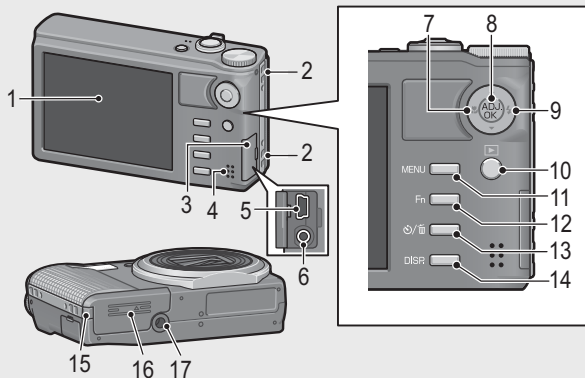

	Item Name	Refer to
1	Picture Display	P.16
2	Strap Eyelet	P.12
3	Terminal Cover	P.91, 99, 107, 109
4	Speaker	P.62
5	USB Terminal	P.99, 107, 109
6	AV Output Terminal	P.91
7	🌸 (Macro)	P.28
8	ADJ./OK Button (*)	P.44
9	⚡ (Flash)	P.29
10	▶ (Playback) Button	P.32
11	MENU Button	P.52, 66, 79, 92
12	Fn (Function) Button	P.46
13	⌚ (Self-timer)/🗑️ (Delete) Button	P.30, 35
14	DISP. Button	P.34, 38, 40
15	Power (DC input) Cable Cover	—
16	Battery/Card Cover	P.22
17	Tripod Screw Hole	P.123

(*) Instructions in this manual to "Press the ADJ./OK button ▲▼⬅️➡️" indicate that you should press the ADJ./OK button in the up, down, left or right direction. Instructions to "Press the ADJ./OK button" indicate that you should press directly down on the button.

If you are using the camera for the first time, read this section.

Picture Display

Example of Picture Display when Shooting Pictures

Still Image Mode

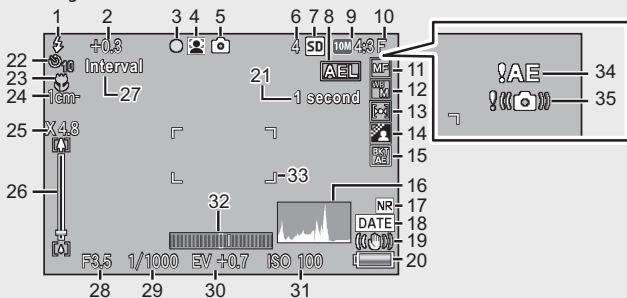

Item Name	Refer to	Item Name	Refer to
1 Flash Mode	P.29	19 Camera Shake Correction	P.70
2 Flash Exposure Compensation	P.69	20 Battery Symbol	P.18
3 Multi-Target AF Focus Mark	P.72	21 Time Exposure	P.69
4 Scene Mode/Plus Normal Shooting/Continuous Mode	P.50, 57, 58	22 Self-timer	P.30
5 Shooting Mode Types	P.13	23 Macro Shooting	P.28
6 Remaining Number of Still Images	P.124	24 Minimum Shooting Distance	P.95
7 Recording Destination	P.20	25 Digital Zoom Magnification/ Auto Resize Zoom	P.28, 98
8 AE Lock	P.48	26 ZOOM Bar	P.27
9 Image Size	P.67	27 Interval Shooting	P.70
10 Picture Quality	P.67	28 Aperture	P.122
11 Focus Mode	P.67	29 Shutter Speed	P.71
12 White Balance	P.77	30 Exposure Compensation	P.76
13 Exposure Metering	P.68	31 ISO Setting	P.78
14 Image Settings	P.68	32 Level Indicator	P.41
15 Bracket Shooting	P.73	33 AF Frame	P.25
16 Histogram	P.42	34 Exposure Warning Indicator	P.76
17 Noise Reduction	P.69	35 Camera Shake Warning Symbol	P.27, 70
18 Date Imprint	P.71		

If you are using the camera for the first time, read this section.

Movie Mode

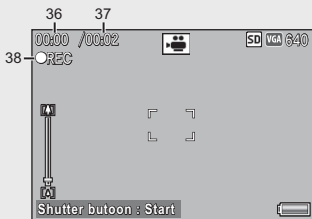

	Item Name	Refer to		Item Name	Refer to
36	Recording Time	P.124	38	Movie Recording Indicator	P.61
37	Remaining Recording Time	P.124			



Note

When the number of remaining shots is 10,000 or more, "9999" is displayed.

Example of Picture Display During Playback

Still Image Mode

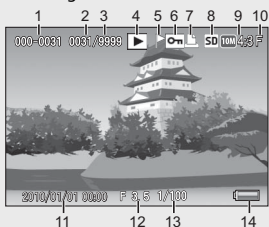

Movie Mode



	Item Name	Refer to		Item Name	Refer to
1	File Number	—	9	Image Size	P.67
2	Number of Playback Files	—	10	Picture Quality	P.67
3	Total Number of Files	—	11	Date at Shooting	P.24
4	Mode Types	—	12	Aperture	P.122
5	Flag Function Setting	P.82	13	Shutter Speed	P.71
6	Protect	P.89	14	Battery Symbol	P.18
7	DPOF	P.90	15	Recording Time or Lapsed Time	—
8	Playback Data Source	P.20	16	Indicator	—



Note

- The picture display may display messages to inform you of operational instructions or the camera's status while in use.
- Additional information can be viewed by pressing the DISP. button. (👉 P.38)

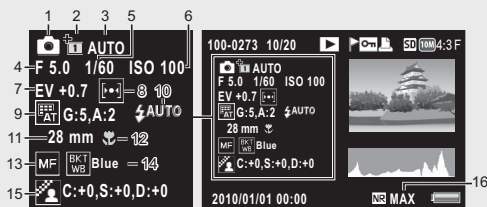

If you are using the camera for the first time, read this section.

	Item Name	Refer to		Item Name	Refer to
1	Shooting Mode	—	9	White Balance /White Balance Compensation	P.77, P.87
2	Plus Normal Shooting	P.57	10	Flash Mode	P.29
3	Dynamic Range Expansion	P.57	11	Focal Length of the Zoom	P.27
4	Aperture	P.122	12	Macro Shooting	P.28
5	Shutter Speed	P.71	13	Focus Mode	P.67
6	ISO Setting	P.78	14	Auto Bracket	P.73
7	Exposure Compensation	P.76	15	Image Settings	P.68
8	Exposure Metering	P.68	16	Noise Reduction	P.69

Battery Level Indication

A battery symbol appears at the lower right of the picture display to indicate the battery level. Recharge the battery before it is depleted.

Battery Symbol	Description
Green	Battery is sufficiently charged.
	Battery partially discharged. Recharging is recommended.
	Battery level is low. Recharge the battery.

Getting Ready

Turn the power on and get ready to shoot.



Note

- Be sure the camera is off before removing the battery.
- For information on how to turn the camera off, see P.23.

About the Battery

This camera uses the rechargeable battery DB-100, a dedicated lithium-ion battery supplied with the camera. The rechargeable battery needs to be charged before use. The battery is not charged at the time of purchase.



Number of shots you can take

Approximate number of shots you can take on a single charge: Approx. 310

* When [LCD Auto Dim] (👉 P.94) is set to [On].

- Based on CIPA standard. (Temperature: 23 degrees Celsius, picture display on, 30 seconds between shots, changing the zoom setting from telephoto to wide-angle or wide-angle to telephoto for each shot, 50% flash usage, turning the power off after each 10 shots)
- You can take approximately 290 shots when [LCD Auto Dim] is set to [Off].
- Set the camera to synchro-monitor mode to increase the number of shots you can take. (👉 P.38)
- The number of shots is for reference only. If the camera is used for long periods of time for setting and playback, the shooting time (the number of shots) will decrease. If you intend to use the camera for a long period of time, we recommend carrying a spare battery.



Caution

- The battery may become very hot immediately after operation. Turn the camera off and leave it to cool down sufficiently before removing the battery.
- Please remove the battery if you are not going to use the camera for a long period of time.
- When using a lithium-ion battery, use only the specified rechargeable lithium-ion battery (DB-100). Do not use any other battery.

If you are using the camera for the first time, read this section.

About the SD Memory Card (available in stores)

You can store images you have taken either in the camera's internal memory or on an SD memory card (available in stores). The internal memory capacity is approximately 88 MB.



About Formatting

Before using a memory card for the first time or after using a memory card in other devices, be sure to format it with this camera. (☞ P.93)



Where images are recorded

When no SD memory card is loaded, the camera records images to the internal memory; when an SD memory card is loaded, it records images to the SD memory card.



Where images are played back from

When no SD memory card is loaded, the camera plays back from the internal memory. When an SD memory card is loaded, it plays back from the SD memory card.



Caution

- If an SD memory card is loaded, the camera does not record to the internal memory, even if the card is full.
- Take care not to get the contacts of the card dirty.



Write-protecting your images

Move the write-protection switch on the SD memory card to LOCK to prevent your still images from being accidentally erased or the card from being formatted.

Note that you cannot shoot images on a locked card because no data can be recorded to the card. Unlock the card before shooting.

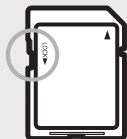

Note

You can copy images recorded in the internal memory to the SD memory card. (☞ P.81)

Charging the Rechargeable Battery

The rechargeable battery needs to be charged before use.

1 Insert the battery into the battery charger, making sure that the ⊕ and ⊖ markings on the battery match those on the battery charger.

- The battery label should face up.

⚠ Caution

Be careful not to reverse the ⊕ and ⊖ sides.

2 Plug the battery charger into an outlet.

- Use the battery charger (BJ-10) to recharge the battery.
- Charging starts. Charging status is indicated by the charger lamp as shown in the table below. Once charging has finished, unplug the battery charger from the power outlet.

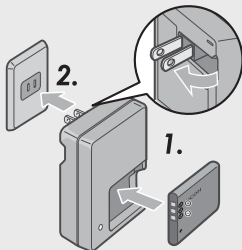

Charger Lamp	Description
Lit	Charging
Off	Charging complete
Flashing	The battery charger terminal may be soiled or the battery charger/battery may be faulty. Unplug the battery charger from the power outlet, and remove the battery.

- The estimated battery charging time is shown below. Depending on the battery level, the charging time differs.

Rechargeable Battery Charging Time	
DB-100	Approx. 180 min. (25 °C)

If you are using the camera for the first time, read this section.

Loading the Rechargeable Battery and SD Memory Card

After recharging the rechargeable battery, load the battery and the SD memory card. Be sure the camera is off before removing the battery or the SD memory card.

1 Open the battery/card cover.



2 Insert the rechargeable battery and SD memory card.

- Make sure the SD memory card is facing the right way and then push the card all the way in until it clicks.
- When the rechargeable battery is loaded in place, it is locked with the hook shown in the figure.

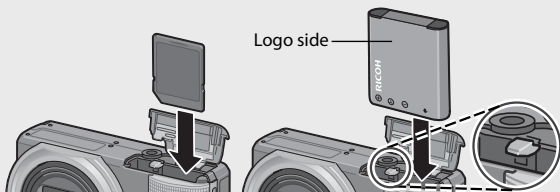

3 Close the battery/card cover and slide it back into place.



Removing the Rechargeable Battery

Open the battery/card cover. Release the hook that locks the rechargeable battery. The battery is ejected. Pull the battery out of the camera. Be careful not to drop the battery when removing it from the camera.

Removing the SD Memory Card

Open the battery/card cover. Push in the SD memory card and gently release to eject it. Pull the card out of the camera.

Turning the Power On/Off

Press the POWER button to turn the camera on or off.

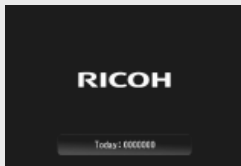
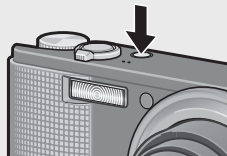

When the camera is turned on, a start-up sound plays and the picture display turns on.

If the POWER button is pressed when the camera is on, the number of files recorded on that day is displayed, and then the camera turns off. If the date is not set, the number of files recorded is displayed as [0]. If the date is changed, only the number of files recorded after the date change is displayed.



Using the Camera in Playback Mode

Pressing and holding the  (Playback) button turns on the camera in playback mode, allowing you to start playback at once.

When the camera has been turned on with the  button, pressing the  button again switches playback mode to shooting mode.

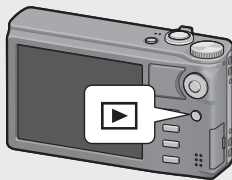

About Auto Power Off

- If the camera goes unused for a set period of time, it automatically turns itself off to save power. (Auto Power Off)
- The auto power off setting can be changed. ( P.94)

Setting the Language, Date and Time

When the power is turned on for the first time, the language setting screen appears (for the picture display language). After setting the language, go on to the date/time setting (for printing the date and time on your photos).

If you are using the camera for the first time, read this section.

Setting the Language

1 Press the ADJ./OK button ▲▼⬇️⚡ to select a language.

- When the DISP. button is pressed, the language setting is canceled and the date/time setting screen appears.



2 Press the ADJ./OK button.

- The display language is set, and the date/time setting screen appears.

Setting the Date and Time

1 Press the ADJ./OK button ▲▼⬇️⚡ to set the year, month, date, time and format.

- Change the setting with ▲▼ and move the item with ⬇️⚡.
- You can cancel the setting by pressing the DISP. button.

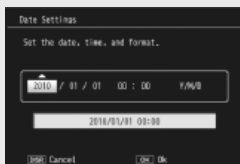

2 Check the information on the screen and then press the ADJ./OK button.

- The confirmation screen appears.

3 Press the ADJ./OK button.

- The date and time are set.



Note

- If the battery is removed for more than one week, the date and time settings will be lost. These settings must be made again.
- To retain the date and time settings, load a battery with adequate remaining power for more than two hours.
- The language, time and date can be changed at any time in the setup menu. (👉 P.96)
- The date and time can be inserted into images. (👉 P.71)

Basic Shooting

Now you are ready.

Shooting in Auto Shooting Mode (Focus and Shoot)

Turn the mode dial to  to shoot with auto shooting mode.

The shutter release button works in two steps. When you press the shutter release button halfway (Half-press), the auto-focus function is triggered to determine the focal distance. Next, press it all the way down (Full-press) to shoot.



When your subject is not in the center of your composition, compose your photo after focusing. (Focus Lock)

1 Hold the camera with both hands and lightly press both elbows against your body.



2 Put your finger on the shutter release button.

3 Frame the picture with your subject in the AF frame in the center of the screen and press the shutter release button halfway.



- The camera focuses on the subject and the exposure and white balance are fixed.
- The focal distance is measured at a maximum of nine points. Green frames appear to indicate the positions that are in focus.

If you are using the camera for the first time, read this section.

- 4 To take a picture with the subject in the foreground in focus against a background, half-press the shutter release button to focus on the subject, and then compose your shot.**

Subject to be focused

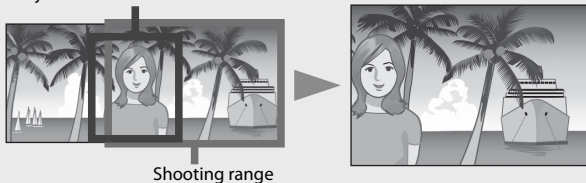

- 5 Gently press the shutter release button all the way.**

- The still image you have taken appears momentarily on the picture display and is recorded to the internal memory or the SD memory card.



Caution-----

- When you are shooting, be careful not to obstruct the lens or flash with your fingers, hair, or the strap.
- Do not hold the lens unit. Zoom and focusing will not be performed properly.



About Focusing-----

The color of the frame in the center of the picture display indicates whether the subject is in or out of focus.

Focus Status	Frame Color
Before focusing	White
Subject in focus	Green
Subject not in focus	Red (Flashing)

It may be impossible to bring the following subjects into focus, or they may not be in focus even when the frame color is green.

- Objects that lack contrast, such as the sky, a wall that is only one color, or the hood of a car.
- Flat two-dimensional objects with only horizontal lines and no significant protrusions.
- Quickly moving objects.
- Things in poorly lit places.
- Areas with strong backlighting, or reflections.
- Things that flicker, such as fluorescent lights.
- Point light sources, such as light bulbs, spotlights, or LEDs.



When you want to shoot subjects like this, first focus on an object the same distance as your subject and then shoot.



Preventing Camera Shake

- Press the shutter release button gently to prevent camera shake.
- If you move the camera when pressing the shutter release button, the still image might not come out clearly due to camera shake. Camera shake tends to occur in the following cases:
 - When shooting in a dark place without using the flash
 - When using the zoom function
 - When shooting using time exposure (👉 P.69)
- When the  symbol appears on the picture display, this indicates that camera shake may occur. To prevent camera shake, try any of the following.
 - Using the camera shake correction function (👉 P.70)
 - Setting the flash to [Auto] or [Flash On] (👉 P.29)
 - Raising the ISO setting (👉 P.78)
 - Using the self-timer (👉 P.30)

Using the Zoom Function

Turning the zoom lever toward  (Telephoto) allows you to take a close-up picture of the subject. Turning the zoom lever toward  (Wide-angle) allows you to take a wide-angle picture. The amount of zoom is shown by the zoom bar in the picture display.

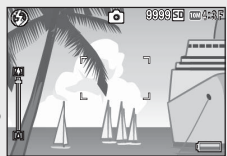
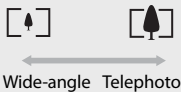
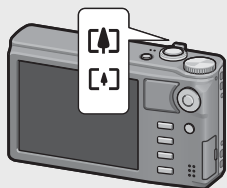

Zoom bar



Note

You can also set the focal length of the optical zoom so that it stops at eight levels. (👉 P.93)

If you are using the camera for the first time, read this section.



Using the Digital Zoom

While you can use the normal zoom to enlarge the subject up to 10.7×, digital zooming allows you to enlarge the subject still further (up to another 4.8× for still images, 2.8× for movies with a frame size of 1280, or 4.0× for movies with a frame size of 640 or 320).

To use digital zooming, turn and hold the zoom lever toward **[A]** until the maximum magnification is reached on the zoom bar, then momentarily release the zoom lever, and then turn the zoom lever again toward **[A]**.

If [Picture Quality/Size] is set to **10M 4 : 3 F** or **10M 4 : 3 N**, you can also set [Digital Zoom Image] to [Auto Resize]. (👉 P.94)

Depending on the shooting mode or the settings in the shooting menu, the digital zoom cannot be used. (👉 P.118)

Shooting Close-Ups (Macro Shooting)

The macro shooting function lets you take shots of subjects that are very close to the camera. To shoot close-ups, press the ADJ./OK button toward **🌸** (Macro). Pressing the ADJ./OK button toward **🌸** (Macro) again cancels macro mode.

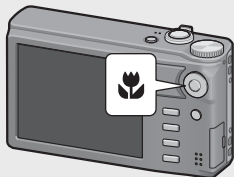

Note

- During macro shooting, the minimum shooting distance changes depending on the zoom position. To display the minimum shooting distance on the screen, set [Minimum Distance] to [Show]. (👉 P.95)
- [Focus] (👉 P.67) is set to [Spot AF].
- Macro mode is not available in some shooting modes. (👉 P.118)
- To take a further close-up picture during macro shooting, use [Zoom Macro] in scene mode. (👉 P.51)
- The minimum shooting distance and shooting range when using the zoom are shown below.

Zoom position	Focal Length (*)	Minimum Shooting Distance (from the front of the lens)	Shooting Range
Wide-angle	31 mm	Approx. 1 cm	Approx. 28 mm × 21 mm
Telephoto	300 mm	Approx. 28 cm	Approx. 45 mm × 34 mm (when digital zoom is not used)
	1440 mm	Approx. 28 cm	Approx. 9.4 mm × 7.0 mm (when 4.8× digital zoom is used)

(*) Equivalent to that on a 35 mm camera





Using the Flash

You can select the flash mode that best suits your shot. At the time of purchase, the camera is set to [Auto].

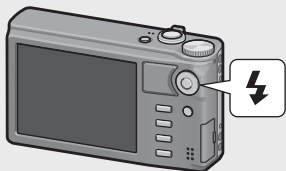
1 Press the ADJ./OK button toward ⚡ (flash).

- The list of the flash modes symbol is displayed on the picture display.



	Flash Off	The flash will not fire.
	Auto	The flash fires automatically when the subject is poorly lit or backlit.
	Red-Eye Flash	Reduces the red-eye phenomenon, in which people's eyes appear red in pictures.
	Flash On	The flash fires regardless of the lighting conditions.
	Flash Synchro.	The flash fires with the shutter speed slowed. This is useful when taking portrait pictures in a nightscape. Camera shake may occur, so the use of a tripod is recommended.

2 Press the ADJ./OK button ▲▼ to select the flash mode.

- The flash mode symbol is displayed at the upper left of the picture display.
- The flash mode symbol blinks at the upper left of the picture display when the flash is charging. Once the flash is charged, the symbol stops blinking and lights steadily and the camera is ready to shoot.

Caution-----

- You cannot shoot when the flash is charging (approx. 5 seconds).
- After the camera is turned on, it may take longer for the camera to become ready for shooting when using the flash.

If you are using the camera for the first time, read this section.

**Note**

- The flash mode setting is retained until you press the ADJ./OK button toward (Flash) again.
- The flash does not fire when shooting movies, in continuous mode, in multi-target AF, in dynamic range double-shot, and in bracket shooting.
- You can adjust the light intensity of the flash. (P.69)
- The auxiliary flash fires to increase the AE accuracy.
- The flash can not be used in some shooting modes or with some shooting menu options. (P.118)

Using the Self-timer

You can set the self-timer to shoot after either two or ten seconds, or you can select [Custom Self-Timer] (P.69) to customize the self-timer setting.

1 With the camera ready to shoot, press the (Self-timer) button.

- A list of self-timer mode settings appears on the picture display.

2 Press the ADJ./OK button ▲▼ to select the mode.

- The self-timer symbol and the number of seconds are displayed at the upper left of the picture display.

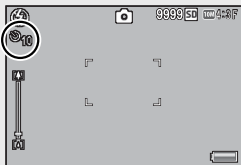

3 Press the shutter release button.

- When set to [10], the self-timer lamp lights for 8 seconds when the self-timer starts and then blinks for the final 2 seconds before the picture is taken.
- When set to [Custom Self-Timer], the self-timer lamp blinks for 2 seconds before each picture is taken, and pictures are taken at the set shooting interval. The focus position is set for the first shot.
- When set to [Custom Self-Timer], press the MENU button to cancel the self-timer during shooting.

**Note**

- The camera remains in self-timer mode even after the image is shot. To cancel the self-timer, press the button and change the self-timer setting to [Self-Timer Off].
- When the self-timer is set to 2 seconds, the self-timer lamp does not light or blink.
- When the self-timer is set, the [Interval Shooting] setting is disabled.

Shooting in Scene Auto Mode

In scene auto mode, the camera selects the optimal scene mode (P.50) automatically.

The following scene modes can be selected.

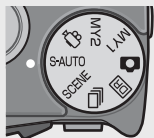

Scene Mode	Refer to	Scene Mode	Refer to
Portrait	P.50	Nightscape	P.50
Sports	P.50	Landscape	P.51
Night. Port.	P.50	Macro Mode	P.28

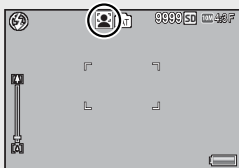

The icon of the selected scene mode is shown in the display. If macro mode is selected, an icon will be displayed at upper left in the picture display.



**Note**

- For information on the options available in the shooting menu when scene auto mode is selected, see P.118.
- If the camera is unable to select a scene, focus, exposure, and white balance will respectively be set to multi AF, multi AE, and multi-pattern auto.

Playing Back Images

Viewing Your Images

To select playback mode, press the  (Playback) button. When the camera is off, pressing and holding the  (Playback) button longer than 1 second turns the camera on in playback mode.

Press the ADJ./OK button  to display the previous file or the next file. Press the button  to display the file 10 frames forward or backward.

To switch the camera from playback mode to shooting mode, press the  button again.

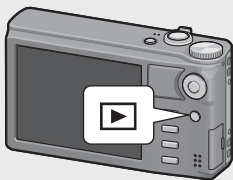

The images played back in playback mode

For information on how to play back files with  symbol, see P.62.

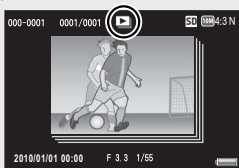

Thumbnail View

20 Frames

If the zoom lever is turned toward  (Thumbnail View), the screen is divided into 20 frames and thumbnails are displayed.

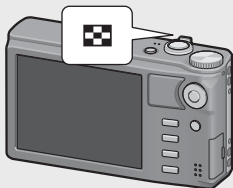

Press the DISP. button to change between the thumbnail list and page list. In the page list, press the ADJ./OK button  to select the page.

To view an image full frame, select it in the thumbnail list and press the ADJ./OK button or turn the zoom lever once toward \mathcal{Q} (Enlarged View).

81 Frames

If the zoom lever is turned toward \mathcal{Q} when 20 frames are displayed, the screen is divided into 81 frames and thumbnails are displayed.

Press the DISP. button to change between the thumbnail list and page list. In the page list, press the ADJ./OK button $\blacktriangle \blacktriangledown \blacklozenge \blacklightning$ to select the page.

To switch to Single-Picture Display, select the file in the thumbnail list and press the ADJ./OK button or turn the zoom lever twice toward \mathcal{Q} (Enlarged View).

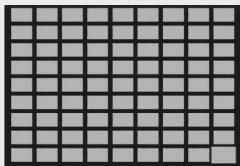

Thumbnail list

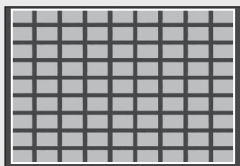

Page list

Date of Recording

If the zoom lever is turned toward \mathcal{Q} again when 81 frames are displayed, the thumbnails are listed by date of recording.

Press the DISP. button to change between the thumbnail list and date list. In the date list, press the ADJ./OK button $\blacklozenge \blacklightning$ to select the date, or press the ADJ./OK button $\blacktriangle \blacktriangledown$ to select the page.

To switch to Single-Picture Display, select the file in the thumbnail list and press the ADJ./OK button or turn the zoom lever 3 times toward \mathcal{Q} (Enlarged View).



Thumbnail list

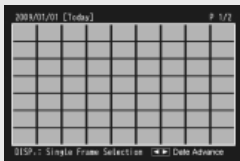

Date list

If you are using the camera for the first time, read this section.

Enlarging Images

Turn the zoom lever toward  (Enlarged View) to zoom in on the selected still image. The magnification varies depending on the image size.





Image Size	Enlarged View (maximum magnification)
VGA 4:3 F	3.4×
1M 4:3 F	6.7×
Image sizes other than those above	16×



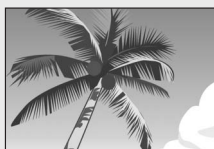

Pressing the DISP. button at this point changes the display as follows.



DISP. button
↔



Pressing the ADJ./OK button     at this point moves the area displayed.

Pressing the ADJ./OK button     at this point moves the area displayed.

Pressing and holding the DISP. Button

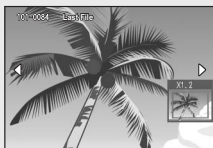

Pressing and holding the DISP. Button

Pressing the ADJ./OK button  at this point displays the previous or next image enlarged. When an MP file or a movie is displayed, the display returns to the normal size.

Turn the zoom lever toward  (Thumbnail View) to return to the original size.

Note

- Movies cannot be enlarged.
- For information on how to enlarge MP files, see P.62–63.
- Cropped copies ( P.83) can not be zoomed in to the magnifications stated above.

Deleting Files

You can delete files from the SD memory card or internal memory.



Note

You can use the [Recover File] function to restore needed files that you accidentally deleted. (P.81)

- 1 Press the (Playback) button.
 - The last file recorded is displayed.
- 2 Press the ADJ./OK button to display the file you want to delete.
 - To delete multiple files, you can also turn the zoom lever toward (Thumbnail View) to display thumbnail view, and then go to Step 3.
- 3 Press the (Delete) button.

Deleting a File or All Files

- 4 Press the ADJ./OK button to select [Delete One] or [Delete All].
 - You can change the image for deletion with the ADJ./OK button .

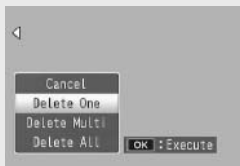

- 5 Press the ADJ./OK button.
 - If [Delete All] is selected, press the ADJ./OK button to select [Yes] and then press the ADJ./OK button.

If you are using the camera for the first time, read this section.

Specifying Multiple Files Separately

- Press the ADJ./OK button ▲▼ to select [Delete Multi] and then press the ADJ./OK button.
 - If thumbnail view was displayed in Step 2 on P.35, skip Step 4.
- Press the ADJ./OK button ▲▼ to select [Sel. Individ.] and then press the ADJ./OK button.
- Press the ADJ./OK button ▲▼👉👈 to select the file you want to delete and press the ADJ./OK button.
 - The trash symbol is displayed in the upper left corner of the file.
 - Press the MENU button to switch to the display for specifying a range of files. See Step 6 and beyond on P.37.
- Repeat Step 6 to select all the files you want to delete.
 - If you selected a file by mistake, you can deselect it by selecting the file and pressing the ADJ./OK button.
- Press the 🗑️ (Delete) button.
- Press the ADJ./OK button 👉👈 to select [Yes] and then press the ADJ./OK button.

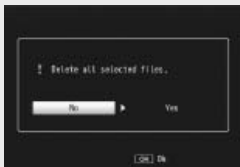
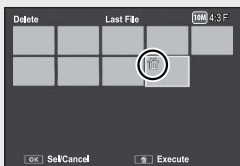

If you are using the camera for the first time, read this section.

Specifying a Range of Multiple Files

- 4** Press the ADJ./OK button ▲▼ to select [Delete Multi] and then press the ADJ./OK button.

• If thumbnail view was displayed in Step 2 on P.35, skip Step 4.

- 5** Press the ADJ./OK button ▲▼ to select [Sel. Range] and then press the ADJ./OK button.

- 6** Press the ADJ./OK button ▲▼👉👈 to select the starting point of the range of files you want to delete and press the ADJ./OK button.

• If you make a mistake when selecting the starting point for the range of files, press the DISP. button to return to the screen for selecting the starting point.

• Press the MENU button to switch to the display for specifying files separately. See Step 6 and beyond on P.36.

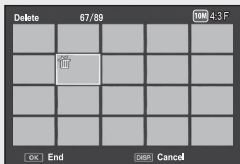

- 7** Press the ADJ./OK button ▲▼👉👈 to select the ending point of the range of files you want to delete and press the ADJ./OK button.

• The trash symbol is displayed in the upper left corner of the specified files.



- 8** Repeat Steps 6 and 7 to specify all the ranges of files you want to delete.

- 9** Press the 🗑️ (Delete) button.

- 10** Press the ADJ./OK button 👉👈 to select [Yes] and then press the ADJ./OK button.

If you are using the camera for the first time, read this section.

Changing the Display with the DISP. Button

Pressing the DISP. button allows you to change the screen display mode and toggle the information displayed on the picture display.

During Shooting Mode

Normal Symbol Display



Histogram Display



Grid Guide Display

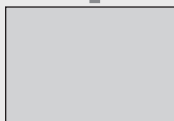

Picture Display Off
(Synchro-Monitor Mode)



No Display

If you are using the camera for the first time, read this section.



Grid Guide Display

- This displays auxiliary lines on the picture display to help you compose your picture. These lines are not recorded with images.
- Use [Grid Guide Display Options] on the setup menu to select the grid.
(P.95)



Synchro-Monitor Mode

This turns the picture display off except when the camera is operated. This is effective for saving power consumption. In this mode, pressing the shutter release button halfway turns the picture display on. Subsequently, pressing the shutter release button fully displays the shot image on the picture display and then turns the picture display off. (This setting is different from [LCD Auto Dim] in the setup menu.)

**Note**

- When [Shooting Info. Display Frame] is set to [On] in the setup menu, the shooting information display frame can be displayed for normal symbol display and histogram display. (👉 P.95)
- Histograms are not displayed in movie mode. A blinking [● REC] icon, the recording time, and the time available are displayed during recording even when indicators are hidden or the grid guide is displayed.
- When [Level Setting] is set to [Display] or [Display+Sound] (👉 P.40), the level indicator is displayed during normal symbol display and histogram display. (👉 P.41)
- If any of the following operations is performed, the picture display turns on even when it is turned off.
 - When the ADJ./OK button, MENU button, DISP. button, or (Playback) button is pressed.
 - When the zoom lever is turned.
 - When the ADJ./OK button is pressed during manual focus. (👉 P.73)

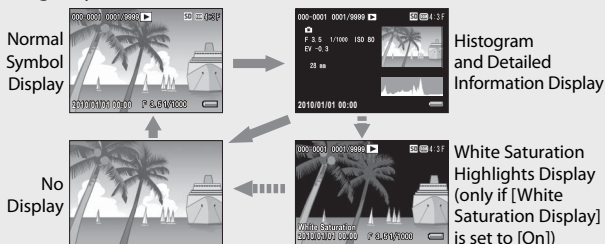
During Playback Mode**White Saturation Highlights Display**

- If [White Saturation Display] is set to [On] in the setup menu (👉 P.95), pressing the DISP. button while the histogram and detailed information are displayed switches to the highlight display.
- The white saturation areas of the image flash in black. White saturation is the loss of tone that indicates the color shading in an image in which very bright areas of the subject are rendered in white. An image with a loss of image tone cannot be edited later. It is recommended that you shoot another image by changing the composition or by setting the exposure level lower (-). (👉 P.76)
- The white saturation highlights display is for reference only.

About the Electronic Level

When [Level Setting] is turned on in the setup menu or by pressing and holding the DISP. button, the camera uses a level indicator and level sound to let you know whether the image is level during shooting. The level indicator is displayed during normal symbol display and histogram display.

This is useful for keeping the image level when taking pictures of scenery or buildings. This is also very useful for taking pictures with the horizon visible.

Available Settings	Description
Off	The level indicator will not display. The level sound will not emit.
Display *Default setting	The level indicator will display. The level sound will not emit.
Display + Sound	The level indicator appears on the screen and a level sound is emitted when the image is level.
Sound	The level indicator will not display. A level sound is emitted when the image is level.

1 Select [Level Setting] in the setup menu (☞ P.92) and press the ADJ./OK button ⚡.

- You can also press and hold the DISP. button in shooting mode to display the setting menu.

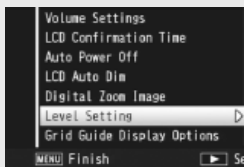

2 Press the ADJ./OK button ▲▼ to select the setting and then press the ADJ./OK button.

If you are using the camera for the first time, read this section.

Level indicator display

When level:

The level indicator becomes green, indicating that the scale is in the middle.

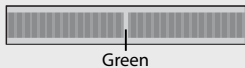

When tilted to the right or left:

The mark on the level indicator becomes orange, indicating the opposite side of the direction in which the camera is tilted.

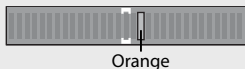

When the camera is tilted too far to the right or left:

Half of the level indicator on the opposite side of the direction in which the camera is tilted becomes red. The mark on the level indicator is not displayed.

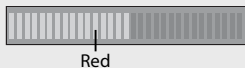

When the camera is tilted too far forward or backward, or it cannot be determined whether the camera is level:

The top and bottom of the level indicator become red. The mark on the level indicator is not displayed.

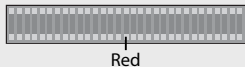

When the camera is held vertically:

When shooting with the camera positioned vertically, the level function can be used to determine whether the image is vertically level (the level indicator appears in a different place).

Caution

- During grid guide display, no display, or when the picture display is turned off (P.38), the level sound is emitted, but the level indicator is not displayed. When [Level Setting] is set to [Display+Sound], only the level sound is emitted.
- The level function is not available if the camera is held upside down, when recording movies, and during interval shooting.
- The level function becomes less accurate when the camera is moving or when shooting in an environment subject to moving, such as on an amusement ride.
- No level sound is emitted when [Level Setting] is set to [Display+Sound] or [Sound] and [Volume Settings] is set to [□□□] (Mute). (P.94)
- Use this function as a reference to see if images are level when shooting images. The accuracy of the level when using the camera as a level cannot be guaranteed.

About the Histogram Display

When Histogram is on, a histogram appears in the lower right corner on the picture display. A histogram is a graph indicating the number of pixels on the vertical axis and the brightness on the horizontal axis (from left to right, shadows (dark areas), midtones, and highlights (bright areas)).

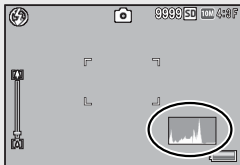

By using the histogram, you can determine the brightness of an image without being affected by the brightness around the picture display. This also helps you correct for areas that are overly bright or dark.

If the histogram has only peaks on the right side, this picture is overexposed with too many pixels only for highlight sections.



If the histogram has only peaks on the left side without anything else, this picture is underexposed with too many pixels only for shadow sections. Refer to this histogram when correcting the exposure.



Note

- The histogram displayed on the picture display is for reference only.
- After taking a picture, you can correct its brightness and contrast by making adjustments to the histogram. (P.86)
- Depending on the shooting conditions (use of the flash, dark surrounding light, etc.), the exposure level indicated in the histogram may not correspond to the brightness of the shot image.
- Exposure compensation has its limitation. It does not necessarily achieve the best possible result.
- A histogram with peaks in the center may not necessarily provide the best result to suit your particular requirements. For example, an adjustment is required if you want to underexpose or overexpose the image.
- For information on how to correct the exposure compensation, see P.76.

Advanced Operations

Read this section when you want to learn more about the different camera functions.

1	ADJ. Button Functions	44
2	Using the Fn (Function) Button	46
3	Shooting Mode Types.....	50
4	Playback Functions	62
5	Shooting Menu.....	66
6	Playback Menu	79
7	Setup Menu	92
8	Direct Printing.....	99
9	Downloading Images to Your Computer	103
10	Appendices.....	112

Instructions in this manual to "Press the ADJ./OK button " indicate that you should press the ADJ./OK button in the up, down, left or right direction. Instructions to "Press the ADJ./OK button" indicate that you should press directly down on the button.

1

2

3

4

5

6

7

8

9

10

1 ADJ. Button Functions

The ADJ./OK button has the following functions. For the operating procedure of each function, see the corresponding reference page.

- ① Assigning four functions from the shooting menu
- ② Shifting the AE and AF targets

1

ADJ. Button Functions

Selecting Shooting Menu Options Assigned to the ADJ./OK Button

You can assign four functions from the shooting menu to the ADJ./OK button. The fifth function is fixed to AE/AF target shift (P.45) and cannot be changed.

By using the ADJ./OK button, you can make settings with fewer button operations and without displaying the shooting menu. This is convenient for frequently used functions.

1 Set the functions you want to assign to the ADJ./OK button with [ADJ Button Setting 1/2/3/4] on the setup menu.

- At the time of purchase, four of the functions are assigned. You can change the assigned functions.

2 Press the ADJ./OK button in shooting mode.

- The ADJ. mode screen appears.

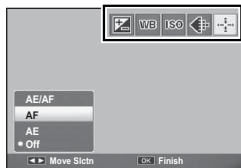

3 Press the ADJ./OK button to select the desired item.

4 Press the ADJ./OK button to select the setting and then press the ADJ./OK button to confirm the setting.

Note

- For functions that can be assigned to the ADJ./OK button, see P.120.
- Press the MENU button in the ADJ. mode to display the shooting menu.

Shifting the AE and AF Targets

You can shift the target for automatic exposure (AE) and/or auto focus (AF).

Available Setting	Description
AE/AF	AE and AF are set to Spot AE and Spot AF respectively and the target can be moved for both simultaneously. (The targets for Spot AE and Spot AF occupy the same position.)
AF	The AF is set to Spot AF and the target can be moved. The exposure metering is set to the mode selected in [Exposure Metering] in the shooting menu. (☞ P.68)
AE	The AE is set to Spot AE and the target can be moved. The focus is set to the mode selected in [Focus] in the shooting menu. (☞ P.67)

- 1 Turn the mode dial to / / and then press the ADJ./OK button.
- 2 Press the ADJ./OK button to select .
- 3 Press the ADJ./OK button to select the setting and then press the ADJ./OK button.
 - The target shift screen appears.
- 4 Press the ADJ./OK button to position the target over the subject that will be used to set focus or exposure.
 - Pressing the DISP. button returns the display to the screen in Step 2.
- 5 Press the ADJ./OK button.
- 6 Press the shutter release button halfway and then gently press it the rest of the way down.

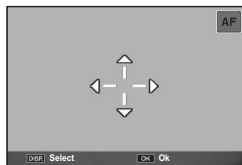

Note

- In scene mode or movie mode, you can select the macro target. changes to the .
- If the macro target shift function is activated using the Fn button (☞ P.47) and not canceled, will not be displayed.
- This function is available when [Focus] (☞ P.67) is set to [Multi AF] or [Spot AF].

2 Using the Fn (Function) Button

When a function is assigned to the Fn (Function) button with [Set Fn Button] on the setup menu (🔧 P.47), you can easily switch from one function to another simply by pressing the Fn button.

The following functions can be assigned to the Fn button. For the operating procedure of each function, see the corresponding reference page.

Available Setting	Description	Refer to
Macro Target	Moves the AF target without moving the camera to shoot close-ups.	P.47
AE Lock	Locks the exposure.	P.48
AF/Face Pr. AF	Switches between autofocus ^{(*)1} and face-priority AF.	P.49
AF/Cont. AF	Switches between auto focus ^{(*)2} and continuous AF.	P.49
AF/M-trgt AF	Switches between auto focus ^{(*)3} and multi-target AF.	P.49
AF/MF	Switches between auto focus ^{(*)3} and manual focus.	P.49
AF/Snap	Switches between auto focus ^{(*)3} and snap mode.	P.49
Step Zoom, AT-BKT, WB-BKT, CL-BKT, FOCUS-BKT	Switches between on and off for each function.	—

(*)1 [Multi AF], [Spot AF] or [Continuous AF]

(*)2 [Multi AF], [Spot AF] or [Face-Pri. AF]

(*)3 [Multi AF], [Spot AF], [Face-Pri. AF] or [Continuous AF]



Note

- For information on the items that can be assigned in each shooting mode, see P.120.
- The Fn button can not be used for the selected function when [Miniaturize] (🔧 P.53) is selected in scene mode.
- Pressing the Fn button in playback mode displays the image assigned with [Flag Function Setting]. For the operating procedure, see P.82.
- Selecting [Trim], [Level Compensation] (when [Manual] is selected), or [White Balance Compensation] on the playback menu, and pressing the Fn button displays the screen that describes the operating procedure. (🔧 P.83, 85, 87)

Assigning a Role to the Fn Button

To assign functions to the Fn button, follow the steps below.

- 1 Select [Set Fn Button] in the setup menu (☞ P.92) and press the ADJ./OK button ⚡.
- 2 Select the setting and then press the ADJ./OK button.

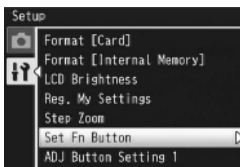

Shifting the AF Target for Macro Shooting

You can select the focus target for close-ups.

- 1 Set [Set Fn Button] to [Macro Target] on the setup menu.
- 2 With the camera ready to shoot, press the Fn button.
 - The macro target shift screen appears.
- 3 Press the ADJ./OK button ▲▼⬅️⚡ to move the cross-mark to the desired target position.
- 4 Press the ADJ./OK button.
 - Pressing the DISP. button cancels the macro target shift function.
- 5 Press the shutter release button halfway and then gently press it the rest of the way down.
 - The camera focuses on the area at the position of the cross-mark.
 - Pressing the ADJ./OK button toward 🌻 (Macro) cancels the macro target shift function.



Note

If the AE/AF target shift function is activated using the ADJ./OK button (☞ P.45) and not canceled, the macro target shift function cannot be used by pressing the Fn button.

Locking the Exposure

Assigning [AE Lock] to the Fn button (P.47) and then pressing the Fn button during shooting allows you to lock or cancel the exposure.

- 1 Set [Set Fn Button] to [AE Lock] on the setup menu.**
 - For the operating procedure, see P.47.
- 2 With the camera ready to shoot, position subject in the center of the picture display and press the Fn button.**

- The exposure is locked and the AEL mark, aperture value, and shutter speed appear on the screen.
- Pressing the Fn button again cancels the AE lock.

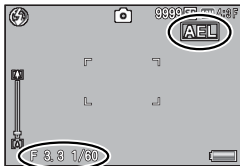

Note

- The AE lock function cannot be used in movie mode.
- The AE lock function can only be used when [Time Exposure] is set to [Off].

Choosing a Focus Setting

If any of the following functions is assigned to the Fn button (👉 P.47), you can change the focus setting during shooting by pressing the Fn button.

Available Setting	Description
AF/Face Pr. AF	Switch between multi, spot, or continuous AF and face-priority AF (👉 P.67).
AF/Cont. AF	Switch between multi, spot, or face-priority AF and continuous AF.
AF/M-trgt AF	Switch between multi, spot, face-priority, or continuous AF and multi-target AF.
AF/MF	Switch between multi, spot, face-priority, or continuous AF and manual focus.
AF/Snap	Switch between multi, spot, face-priority, or continuous AF and snap AF.



Caution

The Fn button only be used to switch between the listed modes. If another focus mode is selected, pressing the Fn button has no effect.

3 Shooting Mode Types

Scene Mode (SCENE)

In scene mode, you can choose from one of the following 13 subject types. Camera settings are automatically optimized for the selected subject type.

Scene Modes



Portrait

Use for portraits. The camera automatically detects up to eight faces, and adjusts focus, exposure, and white balance. The faces detected by the camera are shown by square borders.

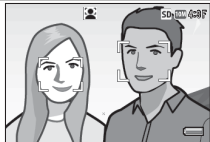

The camera may not be able to recognize faces in the following cases:

- When the face is side-view, tilted, or moving
- When the camera is tilted or upside down (the shutter release button is facing down)
- When the face is partially hidden or at the edge of the frame
- When the face is not clearly visible because of dark surroundings
- When the subject is too far away (Make sure that the face appearing in the picture display is vertically longer than one block marked by the grid guide.  P.38)





Sports

Use when taking pictures of moving objects.



Pets

Use to photograph cats and other pets. The flash ( P.29), AF auxiliary light ( P.93), and speaker ( P.94) turn off and flash, AF auxiliary light, and sound settings can not be adjusted.



Night. Port.









Use when taking portrait pictures against a nightscape. The flash fires automatically. The shutter speed slows down, so be careful of camera shake.





Nightscape

Use when shooting night scenes. In nightscape mode, the flash fires when all of the following conditions are satisfied:

- The flash is set to [Auto].
- The flash is determined to be necessary because it is dark.
- There is a figure or another object nearby.

 Miniaturize	Use to create pictures that appear to be photos of dioramas. For detailed operations, see P.53.
 Landscape	Use when taking scenery pictures with abundant greenery or blue sky.
 High Sens	Use when taking pictures in dimly lit places. The picture display also becomes brighter.
 High Contrast B&W	Use to create black-and-white images with higher contrast than those normally produced using black and white (P.68). Produces grainy images similar to those taken with highly sensitive film or high gain film processing.
 Discreet Mode	Use where lights and sounds emitted by the camera may be unwelcome. The flash (P.29), AF auxiliary light (P.93), and speaker (P.94) turn off and flash, AF auxiliary light, and sound settings can not be adjusted.
 Zoom Macro	The camera automatically zooms to the optimal zoom position to shoot at a higher magnification than in normal macro shooting. Optical zoom can not be used. Macro mode is selected automatically.
 Text Mode	Use when capturing text images, for example notes written on a whiteboard at a meeting. Images are captured in black and white. You can set the image size to either [10M 4 : 3] or [3M 4 : 3]. (P.67)
 Skew Correct Mode	<p>Reduce the effects of perspective when photographing rectangular objects, such as message boards or business cards. For detailed operations, see P.55.</p> <div data-bbox="401 972 801 1108" data-label="Diagram"> </div> <p>In skew correction mode, choose from [1M 4 : 3] or [VGA 4 : 3 F] for [Picture Quality/Size]. (P.67)</p>

Caution

- In [Pets] or [Discreet Mode]:
 - The beep does not sound.
 - Pressing the ADJ./OK button to  (flash) does not change the flash mode. ( P.29)
 - The self-timer lamp will not blink and a beep will not sound in self-timer mode. ( P.30)
- When using [Zoom Macro], you can shoot close-ups within the following distances:

Focal Length (*)	Minimum Shooting Distance (from the front of the lens)	Shooting Range
70 mm	Approx. 1 cm	Approx. 19 mm × 14 mm (when digital zoom is not used)
335 mm	Approx. 1 cm	Approx. 4.0 mm × 3.0 mm (when 4.8× digital zoom is used)

(*) Equivalent to that on a 35 mm camera

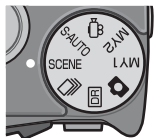
Selecting a Scene Mode**1 Turn the mode dial to SCENE.**

- The camera is ready to shoot and the selected scene mode is displayed at the top of the picture display.

**2 Press the MENU button to change the scene mode.**

- The scene mode selection screen appears.

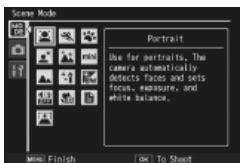
**3 Select a scene mode.**

4 Press the ADJ./OK button.

- The scene mode type is displayed at the top of the picture display.

5 Press the shutter release button to shoot the picture.



Changing the shooting menu or setup menu setting in scene mode ----

Press the MENU button in shooting mode and then press the ADJ./OK button  to select [MODE] tab.

Shooting in Miniaturization Mode

This mode creates pictures that appear to be photos of dioramas. It is most effective when pictures are taken from a high vantage point.

1 Select [Miniaturize] in the scene mode menu and press the ADJ./OK button.

2 Press the Fn button.

- The miniaturization setting screen appears.
- The areas that will not be in focus in the final photograph are shown in gray.
- Press the DISP. button to exit without taking a picture.

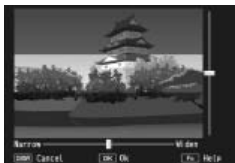

Note

When taking pictures in tall orientation, press the  button to re-orient the area that will be in focus.



3 Press the ADJ./OK button ▲▼ to reposition the area that will be in focus.

- For help, press the Fn button. Press the Fn button again to clear help from the display.

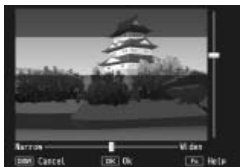

- 4 Press the ADJ./OK button  to choose the width of the area that will be in focus.
- 5 Press the ADJ./OK button.





- 6 Frame a picture and press the shutter release button halfway to focus, then press the shutter release button the rest of the way down to take the picture.

**Caution**-----

The focus of the final image differs slightly from that in the image displayed immediately after shooting.

Using Skew Correction Mode

- 1 Select [Skew Correct Mode] in the scene mode menu and press the ADJ./OK button.**
- 2 Press the shutter release button to shoot the picture.**
 - The display indicates that the image is being processed, and then the area recognized as the correction range is displayed with an orange frame. Up to five areas can be recognized.
 - If the target area cannot be detected, an error message appears. The original image remains unchanged.
 - To select another correction area, move the orange frame to the target area by pressing the ADJ./OK button .
 - To cancel skew correction, press the ADJ./OK button . Even if you cancel skew correction, the original image remains unchanged.
- 3 Press the ADJ./OK button.**
 - The display indicates that the image is being corrected, and then the corrected image is recorded. The original image remains unchanged.



Note

You can also correct the skew of a previously shot still image. (P.88)



Caution

When [Skew Correct Mode] is selected, note the following:

- To shoot the subject as large as possible, position it so that the entire portion of the subject is visible on the picture display.
- The camera may fail to recognize the subject in the following cases:
 - When the image is out of focus
 - When four edges of the subject are not clearly visible
 - When it is hard to distinguish between the subject and background
 - When the background is complicated
- Two images, one before correction and the other after correction, are recorded. If the number of remaining shots is less than two, you cannot shoot the subject.
- The correction area may not be detected properly if the [Date Imprint] function is activated.

Dynamic Range Double Shot Mode (DR)

The "dynamic range" of a digital camera refers to the range of brightness that can be processed by the camera.

When you set the mode dial to DR and shoot, the scene is reproduced with a smooth transition from the bright areas to the dark areas, allowing you to capture a more natural-looking image.

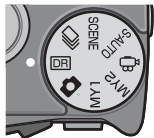

Note

With dynamic range double shot, two consecutive pictures are taken with different exposures and then the areas with the appropriate exposure are combined together. This mode uses a longer shooting time than other modes, so be careful of camera shake when taking pictures. The  symbol is always displayed.

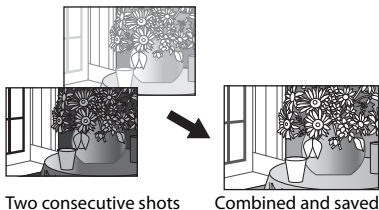

Two consecutive shots

Combined and saved

Caution

- Dynamic range double shot may not be effective if the shooting location is overly bright or dark.
- [Multi] metering is recommended. (P.68)
- When shooting a fast-moving subject, the subject may be distorted in the recorded image.
- Flicker from fluorescent lights may appear as horizontal bands. Fluorescent lighting may also affect colors and brightness.

Dynamic Range Expansion Effect

The [Dynamic Range Expansion] option in the shooting menu offers five levels of dynamic range expansion: [Auto], [Very Weak], [Weak], [Medium], and [Strong]. The stronger the expansion effect, the wider the range of brightnesses processed by the camera.

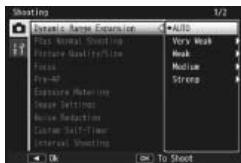

To adjust dynamic range expansion settings, turn the mode dial to **DR** and then select an option for [Dynamic Range Expansion] in the shooting menu.

If an option other than [Auto] is highlighted when you press the ADJ./OK button **⚡**, the menu shown at right will be displayed. Choose the tone range given priority for expanded dynamic range from [Highlights], [Shadows], and [Off].



Dynamic Range Expansion Plus Normal Shooting

When [On] is selected for [Plus Normal Shooting] in the shooting menu, the camera will record two copies of each photo: one with an expanded dynamic range and the other with normal exposure. The two copies are displayed in the picture display after shooting, with the unmodified copy on the right and the copy with an expanded dynamic range of the left.

To turn this option on or off, turn the mode dial to **DR** and then select an option for [Plus Normal Shooting] in the shooting menu.



Note







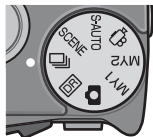



Histograms of the images are displayed after shooting. When [LCD Confirmation Time] is set to [Hold] (P.94), the confirmation screen remains displayed so you can confirm the histograms and easily compare the images.

Continuous Mode ()

Turn the mode dial to  to use the various continuous shooting functions. Continuous mode can be selected from the continuous mode selection dialog displayed when the MENU button is pressed.



Continuous Modes

 Normal Continuous Mode	This is the normal continuous mode. Pictures continue to be taken for as long as you hold down the shutter release button. Images are recorded one at a time, just as in normal shooting. The number of images that can be shot in continuous mode depends on the image size setting ( P.67).
 M-Cont Plus (10M)	The camera shoots while the shutter-release button is pressed, but only the last 15 frames (about the last three seconds of shooting) are recorded to create a single multi-picture (MP) file. ( P.59)
 M-Cont Plus (2M)	The camera shoots while the shutter-release button is pressed, but only the last 26 frames (about the last 0.9 seconds of shooting) are recorded to create a single multi-picture (MP) file. ( P.60)
 Speed Cont (Low)	While the shutter-release button is pressed, the camera shoots up to 120 frames at about 60 frames per second and groups them together in a single MP file. About 2 s are required to shoot the entire sequence. ( P.60)
 Speed Cont (High)	While the shutter-release button is pressed, the camera shoots up to 120 frames at about 120 frames per second and groups them together in a single MP file. About 1 s is required to shoot the entire sequence. ( P.60)



Caution

Recording times may increase when internal memory is used.



Changing settings on the shooting menu or setup menu during continuous mode

Press the MENU button in shooting mode and then press the ADJ./OK button  to select [MODE] tab.

**Note**

- The flash cannot be used.
- The camera shake correction function cannot be used. If you set the mode dial to while the camera shake correction function is enabled, disappears from the picture display.
- Focus, exposure value, and white balance are locked.
- ISO sensitivity is raised.
- Flickering may be recorded as horizontal bands when pictures are taken under fluorescent lights.
- When [Card Sequence No.] is set to [On] (P.96) and the last four digits of the file number exceed "9999" during continuous shooting, a separate folder is created in the SD memory card and successive pictures taken in continuous mode are stored in this folder.

**MP file**

MP is a file format for recording a set of still images.

M-Cont Plus (10M)

In this mode, the camera shoots while the shutter-release button is pressed, but only the last 15 frames (about the last three seconds of shooting) are recorded to create a single multi-picture (MP) file.

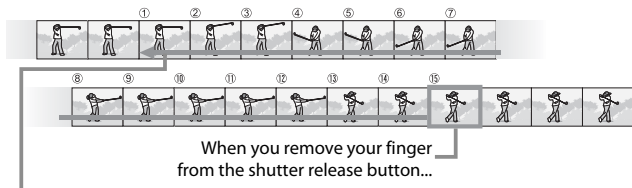

...the camera records the 15 frames taken in the last 3 s of shooting.

**Caution**

The time needed to record 15 frames may increase if lighting is poor.

**Note**

- The image size is fixed at 4 : 3 N.
- The date and orientation of each shot in the sequence are recorded separately.

M-Cont Plus (2M)

In this mode, the camera shoots while the shutter-release button is pressed, but only the last 26 frames (about the last 0.9 seconds of shooting) are recorded to create a single multi-picture (MP) file.



...the camera records the 26 frames taken in the last 0.9 seconds of shooting.

3

Shooting Mode Types



Caution

- When shooting a fast-moving subject, the subject may be distorted in the recorded image.
- Date imprint is not available.



Note

- The image size is fixed at **2M** 4 : 3 N.
- The date and orientation of the last shot in the sequence are also used for the remaining frames.

Speed Cont (Low)/Speed Cont (High)

120 consecutive images are recorded in one second (Speed Cont (High)) or two seconds (Speed Cont (Low)).



Caution

When shooting a fast-moving subject, the subject may be distorted in the recorded image.



Note

- The image size is fixed at **VGA** 4 : 3 N.
- The date and orientation of the last shot in the sequence are also used for the remaining frames.

Movie Mode (📹)

Shooting Movies

You can shoot movies with sound. You can select the frame size (👉 P.67). Each movie you shoot is recorded as an AVI file.

Press the shutter release button to start recording. The [● REC] icon will blink.

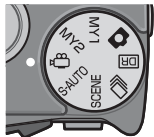

The recording time and time available are displayed during recording. Press the shutter release button again to end recording.

⚠ Caution

- While shooting movies, operation sounds may be recorded.
- Movies may be up to 29 minutes in length. Depending on the type of memory card used, shooting may end before this length is reached. The maximum total length of all movie files that can be stored depends on the capacity of the memory card. (👉 P.124)
- When shooting a fast-moving subject, the subject may be distorted in the recorded image.
- Flickering may be recorded as a horizontal band when shooting under fluorescent lights.

📌 Note

- The camera shoots movies at 30 frames per second.
- The remaining recording time may not change uniformly because it is recalculated from the remaining memory capacity during movie recording.
- Depending on the remaining battery level, the battery may become depleted during movie shooting. Use of a battery with adequate remaining power is recommended.
- Use of a high speed SD memory card with sufficient memory is recommended when shooting for long periods.

4 Playback Functions

Playing Back Movies

To play back movies, follow the steps below.

1 Select the movie you want to play back in playback mode.

2 Press the ADJ./OK button.

- Playback begins. The elapsed playback indicator or the elapsed time is displayed on the screen.

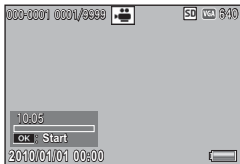

Fast Forward	Turn the zoom lever toward [A] during playback.
Rewind	Turn the zoom lever toward [B] during playback.
Pause/Playback	Press the ADJ./OK button.
Slow Playback	Turn and hold the zoom lever toward [A] during pause.
Slow Rewind	Turn and hold the zoom lever toward [B] during pause.
Next Frame	Turn the zoom lever toward [A] during pause.
Previous Frame	Turn the zoom lever toward [B] during pause.
Volume Adjustment	Press the ADJ./OK button ▲▼ during playback.

Playing Back MP Files

When you shoot one still image with M-Cont Plus, Speed Cont, or Multi-trgt AF, the image is recorded as one MP file. Use the following method to play back MP files.



Note

- Images shot in normal continuous mode can be played back in the same way as normal still images.
- The focus position is displayed for multi-target AF shooting.

1 Display the MP file you want to play back in playback mode.

- The MP file is displayed with the  symbol.

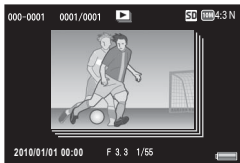

2 The display changes as follows.

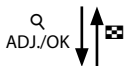

Display for Step 1

- Press the DISP. button to change between "Normal" and "No Display".
- The images cannot be enlarged even if the zoom lever is turned toward (Enlarged View). The images are displayed in thumbnail view.
- The other operations are the same as those for normal still images.

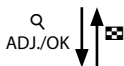

Thumbnail view

- The MP file images are displayed in thumbnail view.
- Press the ADJ./OK button to select a frame.
- The DISP. button is disabled.



Single frame view

- This displays the frame selected on the thumbnail view.
- Turn the zoom lever toward (Enlarged View) to display enlarged view.



Displaying Slide Shows

- Images are displayed automatically in the order they were consecutively shot, starting with the displayed frame.

- The operations during slide show are shown below.

Pause/Playback	Press the ADJ./OK button.
Fast Forward	Turn and hold the zoom lever toward during playback.
Rewind	Turn and hold the zoom lever toward during playback.
Slow Playback	Turn and hold the zoom lever toward during pause.
Slow Rewind	Turn and hold the zoom lever toward during pause.
Next Frame	Turn the zoom lever toward during pause.
Previous Frame	Turn the zoom lever toward during pause.
First Frame	Press the ADJ./OK button .
Last Frame	Press the ADJ./OK button .

3 To play back files other than MP files, return to Step 1 and press the ADJ./OK button .



Caution

- The [DPOF], [Trim], [Resize], [Skew Correction] (playback mode), [Level Compensation], and [White Balance Compensation] functions are not available for MP files.
- [Flag Function Setting] and [Protect] cannot be set for individual frames in an MP file. If [Flag Function Setting] or [Protect] is set when the thumbnail view or single image view is displayed, the setting will be applied to the MP file instead of an individual frame.
- The individual images in a MP file can not be deleted separately.



MP file

MP is a file format for recording a set of still images.

Exporting MP Files

You can extract selected frames from an MP file and save each frame as an individual still image.



Note

- The MP file is displayed with the  symbol.
- The images are saved in the same sizes used for shooting.
- The original files will be retained after extraction.
- The focus positions for images shot using multi-target AF will not be displayed on extracted images.

To export MP files, display the MP file which you want to export in playback mode, and then press the MENU button to display the playback menu and select [Export Still Images].

If [1 Frame] is selected, you can select a frame for export by pressing the ADJ./OK button .

Select [All Frames] to export all frames in the selected MP file.

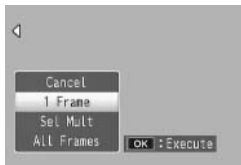

Selecting Multiple Frames

If [Sel Mult] is selected, select multiple individual frames or a range of frames.



To select multiple individual frames:

- 1** Select [Sel. Individ.] and press the ADJ./OK button.
- 2** Select a frame and press the ADJ./OK button.
 - Press the MENU button to switch to the display for specifying a range of frames.
 - If you selected a frame by mistake, you can deselect it by selecting the frame and pressing the ADJ./OK button.
 - Select all the frames which you want to export.
- 3** Press the Fn button, select [Yes] and press the ADJ./OK button.

To select two frames and all frames between them:

- 1** Select [Sel. Range] and press the ADJ./OK button.
- 2** Select the first frame and press the ADJ./OK button.
 - Press the MENU button to switch to the display for specifying frames separately.
 - If you make a mistake when selecting the starting point for the range of frames, press the ADJ./OK button to return to the screen for selecting the starting point.
- 3** Select the last frame and press the ADJ./OK button.
 - Repeat Steps 2 and 3 to select multiple ranges.

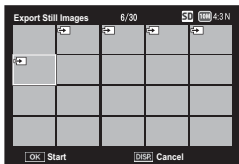

- 4** Press the Fn button, select [Yes] and press the ADJ./OK button.





Note-----
[Sel. Individ.] and [Sel. Range] can be selected directly if [Export Still Images] is chosen in thumbnail view.

5 Shooting Menu

The shooting menu is used to adjust camera settings when taking pictures. To display the shooting menu, press the MENU button when the camera is in shooting mode.

Using the Menu

1 Press the MENU button in shooting mode.

- The shooting menu is displayed.
- In scene mode or continuous mode, press the ADJ./OK button  to select [MODE] tab, and then press the ADJ./OK button . The shooting menu appears.

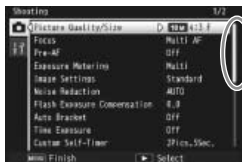

Indicates the range of displayed screens.

2 Press the ADJ./OK button to select the desired menu item.

- If the DISP. button is pressed at this point, the cursor moves to the shooting menu tab.
- Press the ADJ./OK button  at the bottom item to display the next screen.

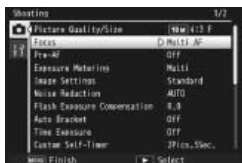

3 Press the ADJ./OK button .

- The menu item settings are displayed.

4 Press the ADJ./OK button to select the setting.

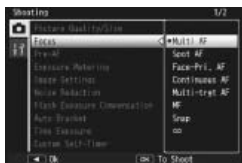

5 Press the ADJ./OK button.

- The setting is confirmed, the shooting menu disappears and the camera is ready to shoot.
- To select the highlighted option and return to the menu shown in Step 2, press the ADJ./OK button .

Shooting Menu Options

Dynamic Range Expansion

 P.57

Select the dynamic range expansion effects.

Plus Normal Shooting

 P.57

Choose whether to record both an enhanced and an unmodified copy when taking pictures with dynamic range expansion.

Picture Quality/Size

 P.124

Adjust picture quality and size when taking pictures.

Movie Size

 P.124

Choose the movie frame size.

Density

Adjust contrast when using the [Text Mode] option in scene mode.

Size

 P.124

Choose the size of pictures taken using the [Text Mode] option in scene mode.

Focus

 P.72

Choose a focusing mode.



Multi AF

Measures the distances from nine AF areas and focuses to the nearest AF area. Choose to prevent out-of-focus photos.



Spot AF

Selects one AF area at the center of the picture display to allow the camera to focus on this area automatically.



Face-Pri. AF

The camera automatically detects and focuses on faces.



Continuous AF

Measures the distance from the center AF area and focuses on the subject in the center area. If the subject moves while the shutter-release button is pressed halfway, the camera will track the subject while focusing continuously.



Multi-trgt AF

Takes five consecutive pictures while shifting the focus to multiple positions. ( P.72)



MF

Enables you to adjust the focus manually. ( P.73)



Snap

Fixes the shooting distance to a short distance (approx. 2.5 m (8.2 ft.)).



∞ (Infinity)

Fixes the shooting distance to infinity. It is useful for shooting distant scenes.

Pre-AF

If [On] is selected when [Multi AF], [Spot AF], [Face-Pri. AF], [Continuous AF], or [Multi-trgt AF] is selected for [Focus], the camera will continue to focus even when the shutter-release button is not pressed halfway. This may decrease the time needed to focus when a picture is taken, potentially improving shutter response.

Exposure Metering

You can change the metering method (the range to use for metering) used to determine the exposure value.

**Multi**

The entire shooting range is divided into 256 partitions, and each is metered to determine the overall exposure value.

**Center**

The entire image is metered, with emphasis on the center, to determine the exposure value. Use this when the brightness of the center and surroundings are different.

**Spot**

Only the center of the image is metered to determine the exposure value. Use this setting when you want to use the brightness at the center. This is useful if there is a marked difference in contrast or backlighting.

Image Settings

You can change the picture quality of an image, including the contrast, sharpness, color and vividness.

**Vivid**

Take strong, vivid photos with higher contrast and sharpness and maximum vividness.

**Standard**

Creates an image with normal picture quality.

**Cust. Settings**

You can select from five [Contrast], [Sharpness], and [Vividness] levels.

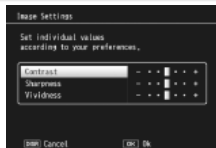
**Black & White**

Creates a black and white picture.

**Sepia**

Creates a sepia-toned picture.

Noise Reduction

Perform noise reduction when taking photographs. Choose from [Off], [Auto], [Weak], [Strong], or [MAX]. The time required to record images varies with the option selected.

Flash Exposure Compensation

You can adjust the light intensity of the flash. You can set the light intensity from -2.0 EV to $+2.0$ EV in increments of $1/3$ EV.

**Caution**

Flash exposure compensation may not work outside the flash range. (👉 P.122)

Auto Bracket

P.73

Vary exposure, white balance, color, or focus over a series of pictures.

Time Exposure

Use time exposures to capture fireworks as they rise into the air and explode, to create trails of light behind cars and other moving objects, or to shoot night scenery. Choose the exposure time from [Off], [1 second], [2 seconds], [4 seconds], and [8 seconds].

**Note**

- The shutter speed may slow down and images may be blurred. Hold the camera steady by using a tripod when shooting.
- The picture display turns off while shooting.
- Long time-exposures are processed to reduce noise. The time required for processing is roughly equivalent to the exposure time.
- ISO sensitivity is restricted to values between ISO 80 and ISO 400. If the value currently selected by the user is between ISO 800 and ISO 3200, the camera will automatically set ISO sensitivity to ISO 400 (👉 P.78).

Custom Self-Timer

P.30

Set the shooting interval and the number of pictures when you want to shoot several pictures with the self-timer.

Available Settings	Description
Pictures	Set this between one and ten pictures. The default setting is [2 Pics].
Interval	Set this between five and ten seconds. The default setting is [5 Sec.].

**Note**

- The camera takes pictures at the specified interval; the self-timer lamp blinks for two seconds before each shot. Focus is locked at the setting for the first shot in the sequence.
- Press the MENU button to cancel self-timer shooting.

Interval Shooting

You can set the camera to automatically take pictures at fixed intervals. You can set the shooting interval from five seconds to one hour in increments of five seconds.



Caution

- The interval shooting setting is cleared when the camera is turned off.
- The time until the next picture can be taken according to the shooting menu setting may be longer than the time set for interval shooting. If this is the case, the shooting interval becomes longer than the set time.

Note

- Depending on the remaining battery level, the battery may become depleted during interval shooting. Use of a battery with adequate remaining power is recommended.
- If you press the shutter release button during interval shooting, the camera shoots as usual.
- A high speed memory card or a SD memory card with sufficient memory is recommended.

5

Camera Shake Correction

Select [On] to reduce the effects of camera shake.

Caution

- The camera shake correction function cannot prevent movement of the shooting subject (caused by wind, etc.).
- Results vary with shooting conditions.

Note

The  symbol appears when camera shake is likely to occur. (P.16)

Slow Shutter Limit

The maximum shutter speed can be limited to the following: 1/8 second, 1/4 second, and 1/2 second. When this function is set to [Off], the maximum shutter speed varies depending on the ISO setting.



Note

- When time exposure is set, priority is given to time exposure.
- When scene mode is set to [Night. Port.] or [Nightscape], the maximum shutter speed for [Night. Port.] or [Nightscape] is given priority.
- When the flash is set to [Flash Synchro.], the longest shutter speed is one second.
- When using the slow shutter limit, the light quantity may be insufficient depending on the brightness of the subject, resulting in a dark image. In this case, try the following:
 - Selecting a greater slow shutter limit.
 - Raising the ISO setting. (👉 P.78)
 - Using the flash. (👉 P.29)

Date Imprint

You can insert the date (YY/MM/DD) or the date and time (YY/MM/DD hh:mm) at the lower right of a still image. Select [Off] to turn date imprint off.



Note

- Make the date and time settings in advance. (👉 P.96)
- [Date Imprint] cannot be used with movies.
- The date imprinted in an image cannot be deleted.

Exposure Compensation

👉 P.76

Choose exposure compensation.

White Balance

👉 P.77

Adjust the white balance.

ISO Setting

👉 P.78

Adjust ISO sensitivity.

Restore Defaults

Select [Yes] and press the ADJ./OK button to restore shooting menu settings to their default values.





Shooting menu options

The options displayed in the shooting menu vary with the selected shooting mode. In scene mode, the options displayed vary with the selected scene. See P.118 for more information.

Multi-Target AF

When you half-press the shutter release button, the camera automatically determines multiple focus positions. When you then press the shutter release button all the way down, the camera shifts among the different focus positions, taking five consecutive pictures. The five still images are grouped together as a set and are recorded as an MP file. This function is especially useful for telephoto shooting and shooting with macro mode.



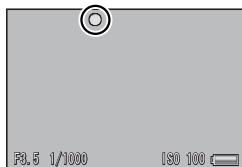

A  icon will be displayed if the camera is able to focus. If the camera is unable to focus, the  icon will blink. The focus positions selected by the camera are only displayed during playback ( P.62).

**MP file**

MP is a file format for recording a set of still images.

**Caution**

- The flash cannot be used.
- The [Time Exposure] setting is disabled. ( P.69)
- The camera shake correction function cannot be used. If [Multi-trgt AF] is set while the camera shake correction function is turned on,  changes to .

**Note**

- If this function is turned on when using the digital zoom, the digital zoom is disabled and shooting is performed at the maximum magnification for the optical zoom (10.7×).
- [White Balance] functions according to the [Auto] setting even if it is set to [Multi-P AUTO].

Manual Focus (MF)

Manual focus (MF) can be used to focus at a selected distance when the camera is unable to focus using autofocus. A focus bar is displayed in the picture display.



1 Press and hold the ADJ./OK button as required.

- Pressing and holding the ADJ./OK button increases the magnification only at the center of the screen.
- Pressing and holding the ADJ./OK button again returns from enlarged view to normal view.

2 Adjust the zoom position with the zoom lever as required.

3 Press the ADJ./OK button ▲▼ to adjust the focus.

- Pressing the ADJ./OK button ▲ adjusts the focus to farther objects and pressing the ADJ./OK button ▼ adjusts the focus to closer objects.

4 Press the shutter release button to shoot the picture.



Note

You can also use manual focus to focus on objects within the macro shooting range.

Auto Bracket

Choose the type of bracketing performed.



Note

Assigning [AT-BKT], [WB-BKT], [CL-BKT], or [FOCUS-BKT] to the Fn (Function) button with [Set Fn Button] allows you to switch between on and off by pressing the Fn button. (👉 P.46)

Auto Bracketing

If [On] is selected, the camera will take three photos each time the shutter-release button is pressed: one underexposed by 0.5 EV, a second at current exposure settings, and a third overexposed by 0.5 EV.

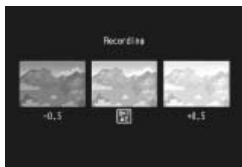

An icon is displayed when [On] is selected.



Note

- The exposure compensation can be changed using the shooting menu. (👉 P.76)
- [White Balance] functions according to the [Auto] setting even if it is set to [Multi-P AUTO].

White Balance Bracketing (WB-BKT)

The white balance bracket function automatically records three images—a reddish image, a bluish image, and an image of the current white balance.

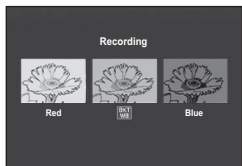

An icon is displayed when [WB-BKT] is selected.



Note

- The white balance can be changed using the shooting menu. (👉 P.77)
- If [Image Settings] is set to [Black & White] or [Sepia], the white balance bracket function can be set but it does not operate.

Color Bracketing (CL-BKT)

With color bracketing, three images, a black-and-white, a color, and a sepia image, are recorded.

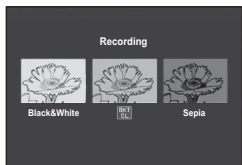

An icon is displayed when [CL-BKT] is selected.



Contrast, Sharpness and Vividness During Color Bracket Shooting -----

During color bracket shooting, the contrast, sharpness, and vividness values set in [Image Settings] are applied. However, the values for [Standard] in [Image Settings] are applied when [Image Settings] is set to [Black & White] or [Sepia].

Focus Bracketing (FOCUS-BKT)

Choose this option to automatically vary focus by a selected amount over a series of five photographs.

- 1** Select [FOCUS-BKT] and press the ADJ./OK button
- 2** Press the ADJ./OK button to choose the focus interval and then press the ADJ./OK button twice.
 - The symbol appears on the screen.
- 3** Half-press the shutter release button.
 - The camera focuses according to the [Focus] setting.
- 4** Press the shutter release button all the way down.
 - The camera takes five consecutive pictures based on the focus position in Step 3.

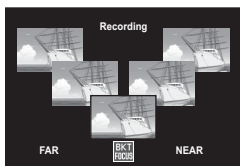

Note-----

- When [Focus] is set to [MF], the first picture is taken at the set focus position without being measured.
- [White Balance] functions according to the [Auto] setting even if it is set to [Multi-P AUTO].
- Photographs are taken and recorded in the following order:

Focus position	Fore	←	Center (*)	→	Back
Shooting order	2	3	1	4	5
Recording order	1	2	3	4	5

(*) Focus set using the option currently selected for [Focus]. (P.67)

Exposure Compensation

Use exposure compensation to vary exposure from the value selected by the camera. Choose from values between -2 and $+2$; negative values produce darker pictures, positive values brighter pictures. Exposure compensation may be required in the following situations:

For backlighting

When the background is particularly bright, the subject will appear dark (underexposed). In this case, set the exposure level higher (+).

When your subject is whitish

The entire picture will turn out dark (underexposed). Set the exposure level higher (+).

When your subject is darkish

The entire picture will turn out bright (overexposed). Set the exposure level lower (-). The same happens when you take a photo of a subject in a spotlight.

5

Shooting Menu

Press the ADJ./OK button ▲▼ to choose a exposure value and press the ADJ./OK button. The selected value is displayed in the picture display.



Note

If the subject is very bright or very dark, [IAE] will be displayed and exposure compensation will not be available.

White Balance

Adjust the white balance so that a white subject will appear white. At purchase, the white balance mode is set to [Multi-P AUTO]. Change the setting in situations where the white balance is difficult to adjust effectively, such as when shooting an object of a single color or when shooting under multiple light sources.

AUTO

Auto

Adjusts the white balance automatically.



Multi-P AUTO

The camera automatically selects the optimal white balance according to the conditions of sun and shade or the flash illumination range.



Outdoors

Select this when shooting outdoors (sunny) and white balance fails to adjust properly.



Cloudy

Select this when shooting in cloudy weather or shade and the white balance fails to adjust properly.



Incandescent Lamp

Select this when shooting under incandescent light and white balance fails to adjust properly.



Incandescent Lamp 2

Select this when shooting under incandescent light (more reddish, compared with [Incandescent Lamp]).



Fluorescent Lamp

Select this when shooting under fluorescent light and white balance fails to adjust properly.



Manual Settings

Adjust the white balance manually. (P.78)



Note

- The white balance may not be adjusted correctly for a subject that is mostly dark. In this case, add something white to the subject.
- When shooting with the flash, the white balance may not be adjusted correctly if [Auto] is not selected. In this case, switch to [Auto] to shoot with the flash.

Manual Settings

- 1 Select [Manual Settings] and press the ADJ./OK button.
- 2 Frame a piece of paper or other white object under the lighting that will be used in the final photograph and press DISP.
 - The white balance is set.
- 3 Press the ADJ./OK button.
 - The symbol appears on the screen.
 - The effect of the selected white balance setting can be previewed in the picture display. Repeat the above steps until the desired effect is achieved.



Note

To cancel [Manual Settings], select a setting other than [Manual Settings].

ISO Setting

ISO sensitivity indicates how sensitive film is to light. A greater value means higher sensitivity. High sensitivity is suitable for shooting an object in a dark place or a fast-moving object while minimizing blurring. When ISO setting is set to [Auto], the camera automatically changes the sensitivity according to the distance, brightness, zoom, macro settings, and picture quality/size. Choose settings other than [Auto] to fix ISO sensitivity at the selected value.



Note

- Use the [Maximum ISO for ISO Auto] option in the setup menu (P.93) to choose the upper limit for auto ISO sensitivity.
- If the flash is not used when ISO is set to [Auto], the camera will select an ISO sensitivity between 80 and the value selected for [Maximum ISO for ISO Auto]. If the flash is set to [Auto], the flash will fire if optimal exposure can not be achieved at the sensitivity selected for [Maximum ISO for ISO Auto].
- Images shot with a higher sensitivity may appear grainy.
- When [Auto] is selected for ISO sensitivity, the ISO value displayed when the shutter release button is pressed halfway may in some instances (for example, when the flash is used) differ from the value selected when the shutter is released.

6 Playback Menu



The options in the playback menu can be used to perform a variety of operations on existing pictures. To display the playback menu, select playback mode and press the MENU button.

Using the Menu

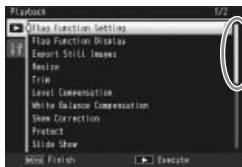
- 1 Press the  (Playback) button to select the playback mode.
- 2 Press the ADJ./OK button  to display the desired file.
 - For [Flag Function Display] ( P.80), [Slide Show] ( P.80), [Copy to Card from Internal Memory] ( P.81), or [Recover File] ( P.81), skip this step.
- 3 Press the MENU button.
 - The playback menu appears.



Indicates the range of displayed screens.

- 4 Press the ADJ./OK button  to select the desired item.
 - If the DISP. button is pressed at this point, the cursor moves to the playback menu tab.
 - Press the ADJ./OK button  at the bottom item to display the next screen.

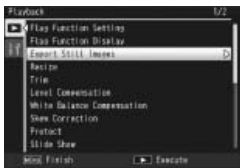

- 5 Press the ADJ./OK button .
 - The screen for the selected menu item appears.

Playback Menu Options

Flag Function Setting

P.82

Flag up to 20 files for quick access.

Flag Function Display

Displays images flagged with [Flag Function Setting]. Fn button can be used for the same purpose.



Note

The file set to [Flag Function Setting] with the smallest file number is displayed.

Export Still Images

P.64

Export selected images from a MP file.

Resize

You can reduce the image size of a shot still image to create a new file with a different image size.

Original		Resized	
4:3F/ 4:3N/ 3:2F/ 1:1F/ 16:9F/	4:3F	4:3F	
4:3F/ 4:3F/ 4:3F/ 4:3N			
4:3F		4:3F	



Caution

Movies or MP files cannot be resized.

Trim

P.83

This function allows you to trim a still image you have shot and then save it as a separate file.

Level Compensation

P.85

Create copies of photographs with modified brightness and contrast.

White Balance Compensation

P.87

Create copies of photographs with modified white balance.

Skew Correction

P.88

Create copies that have been processed to reduce the effects of perspective on rectangular objects.

Protect

P.89

Protect images from accidental deletion.

Slide Show

You can display the recorded still images and movie files sequentially on the screen.



Note

- Each still image is displayed for three seconds.
- For movies and MP files, all the images you shot are played back.

Copy to Card from Internal Memory

Copy all data from internal memory to a memory card in a single operation.



Note

- If there is not enough space available on the destination memory card, a warning will be displayed. Select [Yes] to copy only those files for which there is sufficient space.
- It is not possible to copy the contents of an SD memory card to the internal memory.
- When the contents of the internal memory are copied to an SD memory card, the files saved to [Flag Function Setting] in the internal memory are canceled.

DPOF



Select pictures for printing.

Recover File

Restore deleted files.



Caution

Deleted files cannot be restored after performing any of the following operations.

- Turning the camera off
- Switching from playback mode to shooting mode
- Using DPOF, Resize, Copy to Card from Internal Memory, Skew Correction, Level Compensation, White Balance Compensation or Trim
- Files with DPOF settings are deleted
- Internal memory or SD memory card is initialized
- Setting or canceling files for [Flag Function Setting]
- Changing the magnification ratio or magnified area of files for [Flag Function Setting]
- Exporting MP files using [Export Still Images]

Flag Function Setting

Flag images for quick access during playback. Flagged images can be displayed by pressing the Fn button.

Setting/Canceling One File at a Time

To flag or remove flag marking from the current image, select [Flag Function Setting] in single-image playback. Flagged files are indicated by an icon.



Note

If an enlarged still image is set, the magnification ratio and magnified area are saved and the enlarged image can be displayed as is.

Setting/Canceling Multiple Files at One Time

To flag or remove flag marking from multiple selected images, select [Flag Function Setting] in thumbnail view, highlight images, and press the ADJ./OK button to add or remove flag marking. Press DISP. when the operation is complete.

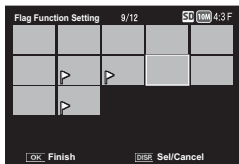

Caution

- If the name of the file set to [Flag Function Setting] is changed using a computer, the file is canceled from [Flag Function Setting].
- Copying images from internal memory to a memory card removes flag marking from the images in internal memory.
- When a file in an SD memory card is set to [Flag Function Setting], [CLIPINFO] folder and CLIPCLI file are created on the SD memory card. If these are deleted, the corresponding file is canceled from [Flag Function Setting].
- If the name of an image file is changed using a computer, the file may not be able to be set to [Flag Function Setting].
- Only images taken using this camera can be set to [Flag Function Setting].

Trim

Create a cropped copy of the current photograph.

Turn the zoom lever toward \mathcal{Q} or \mathcal{R} to adjust the crop size and press the ADJ./OK button $\blacktriangle\blacktriangledown\blacktriangleleft\blacktriangleright$ to position the crop.



Press the ADJ./OK button to save the cropped image to a separate file.

Caution-----

- You can only trim still images shot using this camera.
- You cannot trim movies or MP files.
- While you can trim an image repeatedly, the image is recompressed each time and there will be some decline in image quality.

Note-----

- To cancel, press the DISP. button.
- To view help, press the Fn button while the crop display is shown in the picture display. Press the Fn button again to exit help.
- To choose the aspect ratio, press the \mathcal{R} button in the crop display. Choose from aspect ratios of 4 : 3 and 1 : 1. Aspect ratios of 3 : 2 and 16 : 9 are not supported.
- If an image is trimmed, the compression ratio changes to Fine.
- The available settings for the trimming frame size differ depending on the original image size.

- The size of the image after cropping depends on the size of the original and the size of the crop (the first crop shown in the trimming display is the second largest crop; to display the largest crop, select  with the zoom lever).

Aspect ratio 4 : 3

Original image size	Trimming level	Trimmed image size
10M 4 : 3 F / 10M 4 : 3 N (3648 × 2736)	1	3072 × 2304
	2, 3	2592 × 1944
	4 to 6	2048 × 1536
	7 to 9	1280 × 960
	10 to 13	640 × 480
9M 3 : 2 F (3648 × 2432)	1	3072 × 2304
	2, 3	2592 × 1944
	4 to 6	2048 × 1536
	7 to 9	1280 × 960
	10 to 13	640 × 480
7M 1 : 1 F (2736 × 2736)	1, 2	2592 × 1944
	3 to 5	2048 × 1536
	6 to 8	1280 × 960
	9 to 12	640 × 480
7M 16 : 9 F (3648 × 2048)	1, 2	2592 × 1944
	3 to 5	2048 × 1536
	6 to 8	1280 × 960
	9 to 12	640 × 480
5M 4 : 3 F (2592 × 1944)	1	2592 × 1944
	2, 3	2048 × 1536
	4 to 7	1280 × 960
	8 to 12	640 × 480
3M 4 : 3 F (2048 × 1536)	1, 2	2048 × 1536
	3 to 6	1280 × 960
	7 to 10	640 × 480
2M 4 : 3 F / 2M 4 : 3 N (1728 × 1296)	1	1728 × 1296
	2 to 5	1280 × 960
	6 to 9	640 × 480
1M 4 : 3 F (1280 × 960)	1 to 3	1280 × 960
	4 to 8	640 × 480
VGA 4 : 3 F / VGA 4 : 3 N (640 × 480)	1 to 4	640 × 480

Aspect ratio 1 : 1

Original image size	Trimming level	Trimmed image size
10M 4 : 3 F / 10M 4 : 3 N (3648 × 2736)	1 to 3	2304 × 2304
	4 to 6	1536 × 1536
	7 to 9	960 × 960
	10 to 13	480 × 480
9M 3 : 2 F (3648 × 2432)	1, 2	2304 × 2304
	3 to 5	1536 × 1536
	6 to 9	960 × 960
	10 to 13	480 × 480
7M 1 : 1 F (2736 × 2736)	1 to 3	2304 × 2304
	4 to 6	1536 × 1536
	7 to 9	960 × 960
	10 to 13	480 × 480
7M 16 : 9 F (3648 × 2048)	1 to 3	1536 × 1536
	4 to 7	960 × 960
	8 to 11	480 × 480
5M 4 : 3 F (2592 × 1944)	1 to 3	1536 × 1536
	4 to 7	960 × 960
	8 to 11	480 × 480
3M 4 : 3 F (2048 × 1536)	1, 2	1536 × 1536
	3 to 6	960 × 960
	7 to 10	480 × 480
2M 4 : 3 F / 2M 4 : 3 N (1728 × 1296)	1 to 4	960 × 960
	5 to 8	480 × 480
1M 4 : 3 F (1280 × 960)	1 to 3	960 × 960
	4 to 8	480 × 480
VGA 4 : 3 F / VGA 4 : 3 N (640 × 480)	1 to 4	480 × 480

Level Compensation

Create copies that have been processed to adjust brightness and contrast.

Correcting Images Automatically

Select [Auto] and press the ADJ./OK button . A preview will be displayed with the original image at upper left and the corrected copy on the right.

Press the ADJ./OK button to copy the image.

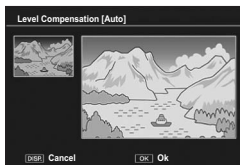

Correcting Images Manually

Select [Manual] and press the ADJ./OK button . A preview will be displayed with the original image at upper left, a histogram and black-, mid-, and white-point controls at lower left, and the corrected copy on the right.

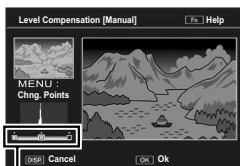

Control points

Press MENU to cycle through the control points and press the ADJ./OK button to position the selected point for enhanced brightness and contrast as described below.

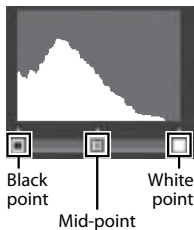

Point	Effect
Black point	If the image is overexposed, move the black point to the right until it lines up with the darkest pixel in the histogram.
Mid-point	To make the image brighter, move the mid-point to the right. Moving the mid-point to the left makes the image darker.
White point	If the image is underexposed, move the white point to the left until it lines up with the brightest pixel.

- To increase contrast, align the black point and white point with the darkest and brightest pixels.
- For help, press the Fn button; press the button again to return to the preview display.

Press the ADJ./OK button to create the corrected copy.



Caution

- If the camera can not create a corrected copy, an error message will be displayed and the camera will exit to the playback menu.
- To cancel level compensation, press the DISP. button.
- You can only use level compensation for still images shot using this camera.
- You cannot use level compensation for movies or MP files.
- This function may not have any effect for images shot using [Text Mode] in scene mode, or images shot when [Image Settings] is set to [Black & White] or [Sepia].
- While you can use level compensation repeatedly, the image is recompressed each time and there will be some decline in image quality.

White Balance Compensation

Create copies with modified white balance.

A preview will be displayed with the original image at upper left, white balance controls at lower left, and the corrected copy on the right. Press the ADJ./OK button  to adjust white balance on the **Green-Magenta** and **Blue-Amber** axes.

Press the ADJ./OK button in to record the modified copy.

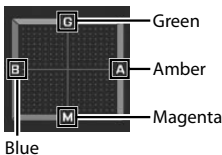
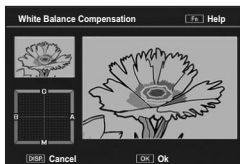

Caution

- You can only use white balance compensation for still images shot using this camera.
- You cannot correct the white balance for movies or MP files.
- This function may not have any effect for images shot using [Text Mode] in scene mode, or images shot when [Image Settings] is set to [Black & White] or [Sepia].
- While you can use white balance compensation repeatedly, the image is recompressed each time and there will be some decline in image quality.



Note

- To cancel, press the DISP. button.
- Press the button to reset white balance.
- For help, press the Fn button; press the button again to return to the preview display.

Skew Correction

Create copies that have been processed to reduce the effects of perspective on rectangular objects, such as message boards or business cards.



Caution

- You can only use skew correction for still images shot with this camera.
- You cannot use skew correction for movies or MP files.



Note

- If the camera is able to detect an object that can be used to correct perspective, a message will be displayed with the object shown by an orange frame. The camera can detect up to five objects.
- If the target area cannot be detected, an error message appears. The original image remains unchanged.
- To select another correction area, move the orange frame to the target area by pressing the ADJ./OK button .
- To cancel skew correction, press the ADJ./OK button . Even if you cancel skew correction, the original image remains unchanged.
- The image size does not change for skew corrected images.
- If the image size is large, skew correction will take time. Resize the image (P:80) before performing skew correction to speed up the process.
- The following table shows the approximate time required for skew correction.

Image Size	Correction time	Image Size	Correction time
4 : 3 F	Approx. 23 seconds	4 : 3 F	Approx. 12 seconds
4 : 3 N	Approx. 22 seconds	4 : 3 F	Approx. 8 seconds
3 : 2 F	Approx. 17 seconds	4 : 3 F	Approx. 3 seconds
1 : 1 F	Approx. 13 seconds	4 : 3 F	Approx. 1 seconds
16 : 9 F	Approx. 13 seconds		

- When scene mode is set to [Skew Correct Mode], you can shoot an image and then immediately correct any skew in the image. (P:55)

Protect

[Protect] allows you to protect files from being accidentally deleted.

If [1 File] is selected, you can protect or unprotect the file selected by pressing the ADJ./OK button .

If [Select All] or [Cancel All] is selected, you can protect or unprotect all files.

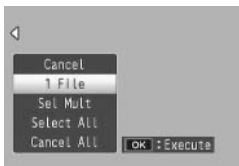

Selecting Multiple Files

Select [Sel Mult] to change the protect status of multiple individual files or of all files in a selected range.

To select multiple individual frames:

- 1 Select [Sel. Individ.] and press the ADJ./OK button.
- 2 Select a frame and press the ADJ./OK button.
 - Press the MENU button to switch to the display for specifying a range of files.
 - If you selected a file by mistake, you can deselect it by selecting the file and pressing the ADJ./OK button.
 - Select all files you want to protect.
- 3 Press the Fn button.

To select two frames and all frames between them:

- 1 Select [Sel. Range] and press the ADJ./OK button.
- 2 Select the first frame and press the ADJ./OK button.
 - Press the MENU button to switch to the display for specifying files separately.
 - If you make a mistake when selecting the starting point for the range of files, press the DISP. button to return to the screen for selecting the starting point.

3 Select the last frame and press the ADJ./OK button.

- Repeat Steps 2 and 3 to select multiple ranges.

4 Press the Fn button.



Note

[Sel. Individ.] and [Sel. Range] can be selected directly if [Protect] is chosen in thumbnail view.





Caution

Note that formatting deletes all files, including protected files.

DPOF

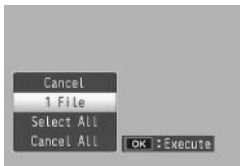
To request professional prints of the photographs on a memory card, first use this option to create a digital “print order” listing the photos you wish to print and the number of prints, and then take the memory card to a digital print service center that supports the DPOF standard.



To add a photo to or remove it from the print order, select [1 File] and press the ADJ./OK button  to display the desired file.

Select [Select All] to add all photos to the print order, or [Cancel All] to remove all files from the print order.

Selecting Multiple Files

To change the print status of multiple individual files or of all files in a selected range, select [DPOF] in thumbnail view.

Select photos and press the ADJ./OK button   to choose the number of prints; press the ADJ./OK button  to increase the number of copies, or press the ADJ./OK button  to decrease the number of copies.

Press the ADJ./OK button to exit when settings are complete.



Note

To remove the DPOF settings for multiple still images, follow the same steps described above to set the number of copies to print to [0] for each image, and then press the ADJ./OK button.

Viewing Pictures on TV

To view pictures on a TV, connect the camera using the supplied AV cable.

1 Securely connect the AV cable to the Video In terminal on the television.

- Connect the white plug of the AV cable to the audio input terminal (white) of the TV unit and the yellow plug to the video input terminal (yellow).

Video Input Terminal (yellow)

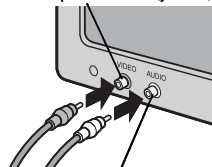

Audio Input Terminal (white)

2 Turn the camera off and securely connect the cable to the camera AV output terminal.

3 Set the television to Video mode (Set the input to Video).

- For details, see the documentation that came with the television.

4 Press the POWER button, or press and hold the (Playback) button to turn the camera on.



Caution

- When the AV cable is connected to the camera, the picture display and the speaker output turn off.
- Do not force the AV cable into the terminal.
- Do not apply excessive force with the AV cable connected.
- When using the AV cable, do not move the camera with the AV cable.



Note

- You can connect the AV cable to the Video In terminal on your video recorder and record what you have shot to a video recorder.
- The camera supports the following video standards: NTSC and PAL. Where possible, the camera is set to the standard used in your country or region before shipment; before connecting the camera to a device that uses a different video standard, choose the appropriate video mode. (P.96)

7 Setup Menu

You can change the camera settings by displaying the setup menu from the shooting menu (👉 P.66) or playback menu (👉 P.79).

Using the Menu

- 1 Press the MENU button.**
 - The shooting menu (or the playback menu) appears.
- 2 Press the ADJ./OK button 📁.**
- 3 Press the ADJ./OK button ▼.**
 - The setup menu appears.
 - In scene mode and continuous mode, press the button ▼ twice.
- 4 Press the ADJ./OK button ⚡.**

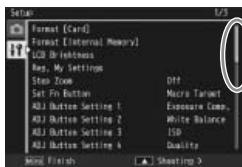

Indicates the range of displayed screens.

- 5 Press the ADJ./OK button ▲▼ to select the desired item.**
 - If the DISP. button is pressed at this point, the display returns to the screen shown in Step 3.
 - Press the ADJ./OK button ▼ at the bottom item to display the next screen.
- 6 Press the ADJ./OK button ⚡.**
 - The menu item settings are displayed.
- 7 Press the ADJ./OK button ▲▼ to select the setting.**

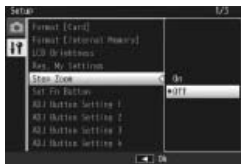
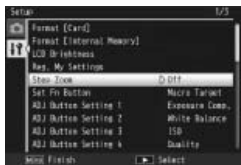

8 Press the ADJ./OK button.

- The setup menu disappears and the camera is ready for shooting or playback.
- The setup menu may appear depending on the setting. In this case, press the MENU button or the ADJ./OK button to return to the shooting or playback screen.
- Pressing the ADJ./OK button  in Step 8 confirms the setting and the display returns to the screen shown in Step 5.



Note

For some functions, the setting selection method may differ from what is explained here. For detailed operation, see the explanation of each function.

Setup Menu Options

Format [Card]

Select [Yes] and press the Fn button to format the memory card.

Format [Internal Memory]

Select [Yes] and press the Fn button to format internal memory. If you have images in the internal memory that you do not want to delete, copy the images to the SD memory card before formatting the internal memory. ( P.81)

LCD Brightness

Press the ADJ./OK button  to adjust the brightness of the picture display.

Reg. My Settings

 P.97

Save current camera settings.

Step Zoom

Select [On] to allow zoom to be adjusted in discrete steps that on a 35-mm camera would be equivalent to focal lengths of 28 mm, 35 mm, 50 mm, 85 mm, 105 mm, 135 mm, 200 mm, and 300 mm. In macro mode, the step zoom focal lengths are roughly equivalent to 31, 35, 50, 85, 105, 135, 200 and 300 mm on a 35-mm camera.

Set Fn Button

 P.47

Choose the role performed by the Fn button.

ADJ Button Setting 1–4

 P.44

Choose the role performed by the ADJ./OK button.

Maximum ISO for ISO Auto

Select the maximum value chosen by the camera when [Auto] is selected for [ISO Setting] ( P.78). Use to prevent ISO sensitivity from being raised too high.

AF Auxiliary Light

If [On] is selected, the AF auxiliary light will light to assist autofocus.

Operation Sounds

Choose the sounds made by the camera.

Available Settings	Description
All	All sounds on.
Level Sound	Only the level sound is emitted.
Shutter Sounds	Only the shutter sound and level sound are emitted.



Note

- If you try to perform an operation that cannot be performed, the beep sound is emitted regardless of the [Operation Sounds] setting.
- Regardless of the option selected, no sound is emitted when [Pets] or [Discreet Mode] is selected in scene mode.

Volume Settings

The operation sound volume can be changed.



Note

- When [Volume Settings] is set to [□□□] (Mute), the level sound is not emitted even when [Level Setting] is set to [Display+Sound] or [Sound].
- Regardless of the option selected, no sound is emitted when [Pets] or [Discreet Mode] is selected in scene mode.

LCD Confirmation Time

Choose how long photos are displayed after shooting. Choose [Hold] to display photos until the shutter release button is pressed halfway. When [LCD Confirmation Time] is set to [Hold], the displayed image can also be enlarged (P.34) or deleted (P.35).

Auto Power Off

Choose how long the camera remains on when no operations are performed. The camera will not turn off automatically if [Off] is selected, during interval timer photography (P.70), or when the camera is connected to a computer or printer.

LCD Auto Dim

If [On] is selected, the picture display will automatically dim to save power if no operations are performed for about five seconds. This feature is not available in synchro-monitor mode (P.38).

Digital Zoom Image

P.98

Choose [Auto Resize] to record pictures taken with digital zoom at actual size, [Normal] to enlarge image data from the center of the frame.

Level Setting

P.40

Adjust level indicator and level sound settings.

Choose the type of framing grid available in shooting mode.

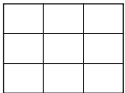
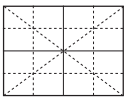
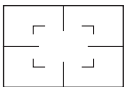
Available Settings	Description
	<p>A three-by-three grid for “rule of thirds” composition.</p>
	<p>A four-by-four grid with diagonal lines running from corner to corner makes it easy to find the center of the subject. Use for architectural photography or photographing products for display.</p>
	<p>A two-by-two grid with the center of the frame left clear to make it easier to view the subject. Use if your subject is in motion.</p>

Shooting Info. Display Frame

Select [On] to display shooting icons in a frame surrounding the view through the lens ( P.38). Shooting information display frame cannot be used in movie mode.



Minimum Distance

Select [Show] to display the minimum focus distance for the current zoom position. The minimum focus distance is not displayed in scene auto mode.

Auto Rotate

Select [On] to automatically display pictures in the correct orientation during playback.

White Saturation Display

If [On] is selected, highlights can be viewed in playback mode by pressing the DISP. button.

Card Sequence No.

When you switch SD memory cards, you can set your camera to continue consecutive numbering from the previously loaded card.

Available Settings	Description
On (Continue numbering)	Files names consist of "R" followed by a seven-digit number (e.g., "R0010001.jpg"), assigned in ascending order from 0010001 to 9999999. When a new memory card is inserted, file numbering continues from the last number used.
Off (Do not continue numbering)	File numbering is assigned, from RIMG0001.jpg to RIMG9999.jpg, for each SD memory card. When the file name reaches RIMG9999, no more data can be recorded to that card.



Note

- This option applies only to memory cards. The names of photos in internal memory consist of "RIMG" and a four-digit number.
- When images are transferred to a computer using DL-10 (P.107), the file being transferred is renamed and saved.



Caution

When the file name reaches RIMG9999 or R9999999, no more files can be saved. In this case, move image data from the SD memory card to the memory of the computer or a storage medium, and then format the SD memory card.

Date Settings



Set the camera clock.



Note

- If the battery is removed for more than one week, the date and time settings will be lost. These settings must be made again.
- To retain the date and time settings, load a battery with adequate remaining power for more than two hours.

Language/言語 (*)



You can change the language displayed on the screen.

Video Out Mode (*)

You can view your still images and movies on a television screen by connecting your camera to a television with the AV cable that came with your camera. Select from NTSC (used in North America, the Caribbean, parts of Latin America, and some East Asian countries) and PAL (used in the United Kingdom and much of Europe, Australia, New Zealand, and parts of Asia and Africa). SECAM is not supported.





(*) The default setting varies depending on where you purchased the camera.

Reg. My Settings

Save current camera settings in [MY1] or [MY2]. Settings saved in [MY1] are recalled when the mode dial is rotated to MY1, those saved in [MY2] when the mode dial is rotated to MY2.

- 1 Set the camera to the desired settings.**
- 2 Select [Reg. My Settings] in the setup menu (☞ P.92) and press the ADJ./OK button .**
 - A confirmation message appears.
- 3 Select [MY1] or [MY2] and press the ADJ./OK button.**
 - The current camera settings are registered and the display returns to the setup menu.
 - If you do not want to register them, press the DISP. button.

Settings Saved in [Reg. My Settings]

Shooting mode ( /  /MY1/MY2/ SCENE/  / 	Slow Shutter Limit
Picture Quality/Size	Date Imprint
Focus	Exposure Compensation
Pre-AF	White Balance
Focal distance used in Manual	ISO Setting
Exposure Metering	Zoom position
Image Settings	Macro
Flash Exposure Compensation	Flash Mode
Dynamic Range Expansion	Scene mode
Plus Normal Shooting	Self-Timer
Auto Bracket	DISP. mode
CL-BKT	Step Zoom
FOCUS-BKT	Digital Zoom Image
WB-BKT	Level Setting
Time Exposure	Grid Guide Display Options
Custom Self-Timer	Minimum Shooting Distance
Noise Reduction	Density
Camera Shake Correction	

Digital Zoom Image

If [Normal] (the default option) is selected for [Digital Zoom Image], digital zoom will enlarge image data from the center of the frame to create a picture at the current image size, creating a slightly grainy image. To record pictures taken with digital zoom at actual size, select [Auto Resize]. The size at which the image will be recorded varies with the zoom ratio.



To use auto resize zoom, hold the zoom lever at  (Telephoto) until the camera is zoomed all the way in, then briefly release the zoom lever and turn it to  again.

Image size changes each time the zoom lever is turned to . The current size is displayed above the zoom bar.



The auto resize zoom is enabled when **10M 4:3 F** or **10M 4:3 N** is selected for [Picture Quality/Size] (P.67), and the digital zoom is enabled in other cases.

Zoom Magnification and Recorded Image Size

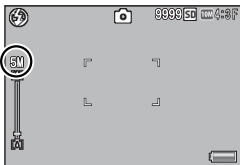
Picture Quality/Size	Zoom Magnification	Focal Length (*)
10M 4:3 F/ 10M 4:3 N	1.0×	300 mm
5M 4:3 F	1.4×	420 mm
3M 4:3 F	1.8×	530 mm
1M 4:3 F	2.9×	850 mm
VGA 4:3 F	5.7×	1710 mm

(*) Equivalent to that on a 35 mm camera



Caution

- Regardless of the option selected, normal digital zoom is used when [Skew Correct Mode] is selected in scene mode.
- Fine picture quality is used for all photographs recorded using [Auto Resize], regardless of the option currently selected for [Picture Quality/Size].

8 Direct Printing

About the Direct Print Function

The Direct Print standard enables direct printing from a camera to a printer by connecting them via a USB cable. Photos can be printed quickly and easily from your digital camera without using a computer.



Caution

You cannot print AVI files (movies) or MP files with this function.



Note

- This camera uses PictBridge, an industry standard for Direct Printing.
- Your printer must be compatible with PictBridge to use the Direct Print function. For support information, see the documentation that came with the printer.

Connecting the Camera to a Printer

Connect your camera to a printer using the USB cable provided.

1 Make sure that the camera power is off.

2 Connect your camera to a printer using the USB cable provided.

- Turn on the printer if it is not already on.
- Your camera turns on automatically.

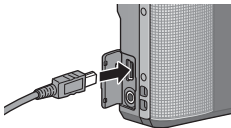

Note

To disconnect the camera from the printer, check that the camera is turned off after printing is finished, and disconnect the USB cable.



Caution

- Do not force the USB cable into the terminal.
- Do not apply excessive force with the USB cable connected.
- When using the USB cable, do not move the camera with the USB cable.

Printing Still Images

You can print still images from the camera with a PictBridge-compatible printer. If a memory card is inserted, the pictures will be printed from the memory card; otherwise pictures will be printed from internal memory.



Caution

Do not disconnect the USB cable during printing.



Note

- If a [Printer error.] message appears during image transfer, check the printer status and take the appropriate action.
- If a computer connection message appears even though the camera is connected to the printer, reconnect the camera and press the ADJ./OK button within two seconds.

Before printing, connect the camera to the printer. The message [Connecting...] shown at right will be displayed if the printer is ready; press ADJ./OK to view the Direct Print playback display.



Printing One or All Still Images

- 1 Select an image for printing and press the ADJ./OK button.
- 2 Select [1 File] or [All Files] and press the ADJ./OK button.
 - The Direct Print menu appears.
- 3 Select an item and press the ADJ./OK button  to view the options available.

- When [Connecting...] is displayed, the connection to the printer is not yet established. When a connection is established, [Connecting...] disappears and [Direct Print] appears. Proceed with this step after the connection is established.

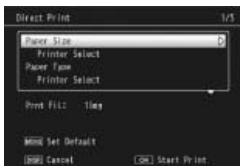

- The following items can be selected. Each item is available only when supported by the printer connected to the camera.

Item Name	Description
Paper Size	Sets the paper size.
Paper Type	Sets the paper type.
Layout	Sets the number of images printed on a sheet of paper. The number of images that can be laid out on a sheet of paper varies depending on the connected printer.
Date Print	Selects whether to print the date (shooting date). The date format can be set using the date/time option in the setup menu. If the picture was taken using [Date Imprint] (P.71), only the imprinted date will be printed.
File Name Print	Selects whether to print the file name.
Optimize Image	Selects whether to optimize the image data (still image) prior to printing on the printer.
Print Size	Sets the print image size.
Print Quality	Sets the print quality.
Report Print (*)	Prints on forms.
Printing Quantity	Sets the print quantity.
Toner Saving (*)	Selects whether to conserve toner by using less ink during printing.
1-Side/2-Sides (*)	Selects whether to print on both sides of the paper. During duplex printing, one copy is printed for each still image. Only one copy is printed even if you selected more than one copy to print in Step 3 on P.102.

(*) Each item is available only when supported by the Ricoh printer connected to the camera.



Note

- To specify the settings as the default settings next time the camera is connected to the printer, press the MENU button when the screen in Step 3 is displayed. Select [Yes] in the display at right and press the ADJ./OK button.
- To use the settings last set the next time the camera is connected to the printer, select [No].



4 Select an option and press the ADJ./OK button.

- The display returns to the Direct Print menu.
- Repeat Steps 3 and 4 to change other settings as required.

5 Press the ADJ./OK button.



- The selected still images are sent to the printer and the [Sending...] screen appears.
- Pressing the DISP. button cancels the operation.
- When the images have been sent to the printer, the display returns to the Direct Print playback mode screen and printing starts.

Printing Several Still Images

1 Turn the zoom lever toward (Thumbnail View) to display the thumbnail view.

2 Select an image and press the ADJ./OK button.

3 Press the ADJ./OK button to set the number of copies to print.

- Press the ADJ./OK button  to increase the number of copies, or press the ADJ./OK button  to decrease the number of copies.
- Repeat Steps 2 and 3 to select additional images.

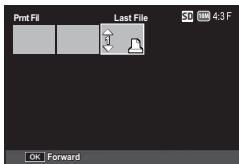

4 Press the ADJ./OK button.

- The Direct Print menu appears.

5 Select an item and press the ADJ./OK button to view the options available.

- See Steps 3 and following on P.100.



Note

- Only images with a printer symbol () are printed. If you cancel printing and then try to print again, make sure that the printer symbol is on the images you want to print.
- The same still image can also be printed several times on a single sheet.
- The available items vary depending on the functions of the printer.
- To print images using the printer's default settings, select [Printer Select] on the detailed options screen.

9 Downloading Images to Your Computer

The screen images shown here may differ from the images displayed on your computer depending on your computer OS.

For Windows

You can copy pictures to your computer with or without DL-10 software, which can be installed from the supplied CD.

System Requirements for Using the Supplied CD-ROM

The following environments are necessary for using the supplied CD-ROM. Please check your computer, or the computer's user manual.

Operating Systems Supported	Windows 2000 Professional Service Pack 4 Windows XP Home Edition Service Pack 3/Professional Service Pack 3 Windows Vista Service Pack 2 Windows 7
CPU	Windows 2000/Windows XP: Pentium® III 500 MHz or faster Windows Vista/Windows 7: Pentium® III 1 GHz or faster
Memory	Windows 2000/Windows XP: 256 MB or more Windows Vista: 512 MB or more Windows 7: 1 GB or more
Hard drive space required for installation	160 MB or more
Display Resolution	1024 × 768 pixels or greater
Display Colors	65,000 colors or greater
CD-ROM Drive	A CD-ROM drive compatible with the above-mentioned computer
USB Port	A USB port compatible with the above-mentioned computer



Caution

- The CD-ROM supports the following languages. Operations are not guaranteed on operating systems with languages other than those listed below. Japanese, English, French, German, Spanish, Italian, Chinese (Traditional, Simplified), Korean
- The supplied CD-ROM is not supported on 64-bit versions of the Windows operating system.
- If your computer has an upgraded OS, the USB function may not work normally, so it cannot be supported.
- The provided software may not operate properly if changes are made to the operating system, such as with patches and service package releases.
- The camera does not support connection to a USB port added by using an extension function (PCI bus or other).
- If used in conjunction with a hub or other USB devices, the software may not work properly.
- When dealing with movies and other large files, a larger memory environment is recommended.

CD-ROM Setup

Once you insert the supplied CD-ROM in the CD-ROM drive, the installer screen appears automatically.

Windows 2000/Windows XP

- The installer screen appears automatically.

Windows Vista/Windows 7

- If an Autorun dialog is displayed, select [Run Autorun.exe]. The installer will start automatically.

Use this button to install software required for batch downloading and editing of images.

Click this to display the "Software User Guide" (PDF).

Click this to display the list of files contained on the CD-ROM.



Installing Software

Click [Installing the software] to install the following software.

Software	Description
DL-10	Downloads images collectively to your computer.
Irodio Photo & Video Studio	Display, manage, and edit existing images. The Windows 7 Libraries are not supported.
USB Driver	Used to connect an earlier model Ricoh camera to a computer running Windows 98/Windows 98 SE/Windows Me/Windows 2000. Not used with this camera.
WIA Driver	Used to connect an earlier model Ricoh camera to a computer running Windows XP/Windows Vista/Windows 7. Not used with this camera.

Caution

- Do not install the software when the camera is connected to your computer with a USB cable.
- The names for DC Software items differ from the names for Caplio Software items provided with previous models as shown below.

Caplio Software	DC Software
RICOH Gate La	DL-10
Caplio Viewer	DU-10 (not used with this camera)
Caplio Server	SR-10 (not used with this camera)
Caplio Setting	ST-10 (not used with this camera)

If Caplio Software from a CD-ROM supplied with a previous model is already installed on your computer, a message asking you to uninstall the Caplio Software before installing DC Software will appear when you try to install the new software.

- Administrator privileges are required for installation.
- DL-10 is not network-compatible. Use as a stand-alone application.

1 Click [Installing the software].

Windows 2000/Windows XP

- After a while, the [Choose Setup Language] screen appears.

Windows Vista/Windows 7

- If a [User Account Control] dialog is displayed, select [Yes] (Windows 7) or [Allow] (Windows Vista). After a short pause, the [Choose Setup Language] dialog will be displayed.

2 Select a language and follow the on-screen instructions to complete installation.

- The Irodio Photo & Video Studio installer starts. Install Irodio Photo & Video Studio following the messages displayed on the screen.

3 When a message appears asking you to restart your computer, select [Yes, I want to restart my computer now.] and then click [Finish].

- Your computer will restart automatically.
- After your computer restarts, a Windows security warning message appears.

4 Click [Unblock] for DL-10.



Uninstalling the Software

- DC Software and Irodio Photo & Video Studio can be uninstalled from [Control Panel] > [Programs and Features] (Windows 7 and Windows Vista; in category or home view, select [Control Panel] > [Programs] > [Uninstall a program]), [Add or Remove Programs] (Windows XP), or [Add/Remove Programs] (Windows 2000).
- Administrator privileges are required.
- Quit any other programs that may be running before uninstalling the software.

Adobe Reader

Adobe Reader is required to display the operation manual (PDF file). Acrobat Reader or Adobe Reader need not be installed if already installed on your computer.



Note

- For details about Adobe Reader, see Help for Adobe Reader.
- To install Irodio Photo & Video Studio alone, double-click "Irodio Photo & Video Studio.exe" in the Irodio Photo & Video Studio folder.
- Installation of Adobe Reader 9.1 requires either Microsoft Internet Explorer 6.0 or later or Firefox 2.0 or later. Microsoft Internet Explorer is available via Microsoft Update.
- Installation of Adobe Reader 9.1 requires MSI (Microsoft Windows Installer) version 3.1 or later. Microsoft Windows Installer is available via Microsoft Update.



Caution

- Do not install the software when the camera is connected to your computer with a USB cable.
- Administrator privileges are required for installation.

- 1 Click [Browse CD-ROM Content].
 - The files on the CD-ROM are listed.
- 2 Double-click [Adobe Reader], [English], and [AdbeRdr910_en_US_Std] (AdbeRdr910_en_US_Std.exe).
 - A screen appears to confirm user account management for Windows Vista. Select [Continue].
- 3 Install Adobe Reader by following the messages displayed.

Copying Pictures to Your Computer

Follow the steps below to copy pictures to your computer.

- 1 **Connect the camera to the computer using the supplied USB cable.**
 - Turn the camera off before connecting the USB cable.
 - The camera turns on automatically when a connection is established.

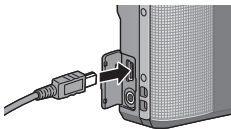

- 2 **Copy photos to the computer.**

If DL-10 is installed:

- DL-10 starts and image transfer begins automatically.
- Pictures are copied to the [Digital Camera] folder in [My Documents], where they are sorted into separate folders by date of recording. See the "Software User Guide" on the supplied CD for more information.

If DL-10 is not installed:

- Copy files from the camera to the desired location.
- When an SD memory card is loaded, its files are displayed. Otherwise, files in the internal memory are displayed.

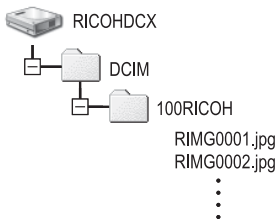

Example of the display
in Windows XP

3 Disconnect the USB cable when transfer is complete.

- Click the [Safely Remove Hardware] or [Unplug or Eject Hardware] icon in the taskbar (the illustration above shows the icon for Windows XP) and select [Safely Remove USB Mass Storage Device] or [Stop USB Mass Storage Device] from the menu that appears. You can then disconnect the USB cable.
- If the remove hardware icon is not displayed in Windows 7, click the  button in the taskbar.



Caution-----

- Do not turn off the camera or disconnect the USB cable during image transfer.
- Do not use force when connecting the cable or when handling the camera with the cable connected. Do not attempt to transport the camera while the USB cable is connected.

Note-----

The camera is provided with Irodio Photo & Video Studio software that allows you to display and edit images from your computer. For how to use Irodio Photo & Video Studio, see the displayed "Help".

For the latest information about Irodio Photo & Video Studio, access the Web page of Pixela Co., Ltd. (http://www.pixela.co.jp/oem/irodio/e/irodio_digitalphoto_videostudio/).

For Macintosh

This camera supports the following Macintosh operating systems.

- Mac OS 9.0 to 9.2.2
- Mac OS X 10.1.2 to 10.6.1

⚠ **Caution**

VM-1 software can be installed on Macintosh computers as described on P.111. More information is available in the "Software User Guide" (note that Acrobat Reader is required to view the "Software User Guide" under Mac OS 9).

Copying Pictures to Your Computer

Follow the steps below to copy pictures to your computer.

1 **Connect the camera to the computer using the supplied USB cable.**

- Turn the camera off before connecting the USB cable.
- The camera turns on automatically when a connection is established.

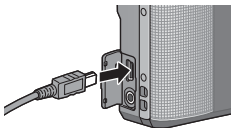

2 **Copy photos to the computer.**

- Copy files from the camera to the desired location.
- When an SD memory card is loaded, its files are displayed. Otherwise, files in the internal memory are displayed.

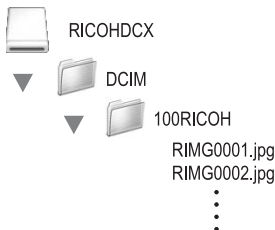

3 **Disconnect the USB cable when transfer is complete.**

- Drag the camera volume into the Trash and then disconnect the USB cable.



Caution

- Do not turn off the camera or disconnect the USB cable during image transfer.
- Do not use force when connecting the cable or when handling the camera with the cable connected. Do not attempt to transport the camera while the USB cable is connected.
- You can also click [Eject] on the [Special] menu in Mac OS 9 or the [File] menu in Mac OS X to cancel the connection.
- If the USB cable is disconnected without disabling the connection, the Unsafe Removal of Device screen may be displayed. Be sure to stop the connection before removing the USB cable.
- When you connect your camera to a Macintosh computer, a file called "FINDER.DAT" or ".DS_Store" may be created in your SD memory card, which will appear as [Unmatched File] on your camera. You can delete this file from the SD memory card if you wish.

Using the MP File Viewer

When you shoot one still image with M-Cont Plus, Speed Cont, or Multi-trgt AF, the image is recorded as one MP file.

By using the VM-1 MP file viewer, you can play back MP files on your Macintosh computer and export still images.

This section explains how to install and uninstall the VM-1 software included on the supplied CD-ROM. For details on how to play back MP files on your computer or export still images from MP files using the MP file viewer, see the "Software User Guide" available from the supplied CD-ROM.

System Requirements for Using the Supplied CD-ROM

The following environments are necessary for using the supplied CD-ROM. Please check your computer, or the computer's user manual.

Operating Systems Supported	Mac OS X 10.4 to 10.6.1
Macintosh computer	Apple Inc. Macintosh Series
Internal Memory	Mac OS X 10.4 256 MB or more Mac OS X 10.5 512 MB or more Mac OS X 10.6 1GB or more
Hard Disk Available Memory	5 MB or more
CD-ROM Drive	A CD-ROM drive compatible with the above-mentioned Macintosh computer



Note

VM-1 supports Japanese, English, French and Chinese (Simplified).

Installing VM-1

- 1 Start your Macintosh computer and insert the supplied CD-ROM in the CD-ROM drive.**
- 2 Double-click the [RICOH] icon, the [VM-1] folder, and the [VM-1 Installer.pkg] icon.**
 - The [Install VM-1] window is displayed.
- 3 Follow the on-screen instructions to complete installation.**



Deleting (Uninstalling) VM-1

- Double-click [Applications], [Utilities], [VM-1 Utility], and [VM-1 Uninstaller] and follow the on-screen instructions.
- If you have any other software applications running or data that has not been saved, quit the other software applications and save the data before uninstalling the software.
- If an error occurs during the uninstallation process, update your Mac OS to the latest version.

Troubleshooting

Error Messages

If an error message is displayed on the screen, check the information on the reference page and take the corresponding action.

Error Message	Cause and Solution	Refer to
Insert card.	No card is loaded. Insert a card.	P.22
Set date.	The date is not set. Set the date.	P.96
The file number limit has been exceeded.	The file number limit has been exceeded. Use another card.	P.96
Unmatched File	This file cannot be displayed on the camera. Check the file contents on your computer, and then delete the file.	—
Insufficient memory. Continue?	All the files cannot be copied because there is insufficient memory on the card. Use another card.	P.20
Protected	The file selected for deletion is protected.	P.89
Card Is Write-Protected.	The card is locked (write-protected). Unlock the card.	P.20
Print settings cannot be applied to this file.	This file (movie or other file) cannot be selected for printing.	—
Insufficient Memory	Files cannot be stored. Make sure there is sufficient memory or delete unwanted files.	P.35, P.93
	The image print number limit has been exceeded. Select an image and set the number to 0.	P.102
Format internal memory.	The internal memory requires formatting.	P.93
Format card.	The card is not formatted. Format the card with this camera.	P.93
Card Error	Reformat the card. If the error message still appears after that, the card may be faulty. Do not use the card.	P.93
Writing Data	Writing file to memory. Wait until writing finishes.	—
File not found	There are no files that can be played back.	—
Out of Memory. Cannot be stored.	The number of remaining shots is 0. Switch to another card or the internal memory.	P.20
No files to restore.	There are no files to restore.	P.81
Can not —.*	Selected option can not be applied to image more than once, or image was created with different make of camera. If image was created with different make of camera, process image using original make of camera.	—



* "—" indicates the name of the process that can not be applied.

Camera Troubleshooting

Power Supply

Problem	Cause	Solution	Refer to
The camera does not turn on.	The battery is exhausted or not inserted.	Load the rechargeable battery correctly, or charge the battery.	P.21, P.22
	An unacceptable battery is used.	Use the dedicated rechargeable battery. Never use any other battery.	P.19
	The camera is automatically turned off by auto power off.	Turn the camera back on.	P.23
	The battery is loaded in wrong direction.	Load correctly.	P.22
	Because the camera overheated, the power was automatically turned off.	Wait until the temperature of the camera returns to normal. Do not attempt to cool the camera suddenly.	—
The camera turns off during use.	The camera was left unattended and unused, so auto power off turned it off.	Turn the camera back on.	P.23
	Battery is exhausted.	Charge the rechargeable battery.	P.21
	An unacceptable battery is used.	Use the dedicated rechargeable battery. Never use any other battery.	P.19
The camera does not turn off.	Camera malfunction	Remove the battery and load it again.	P.22
The battery has been fully charged, but: <ul style="list-style-type: none">• The battery symbol is displayed, indicating a low battery level.• The camera turns off.	A (manganese dry cell or other) unacceptable battery is used.	Use the dedicated rechargeable battery. Never use any other battery.	P.19
Cannot charge the battery.	Battery has reached the end of its useful life.	Replace with a new rechargeable battery.	P.22
Battery runs out quickly.	It is being used at extreme high or low temperatures.	—	—
	Many shots are being taken in dark places or other location requiring extensive use of flash.	—	—

Shooting

Problem	Cause	Solution	Refer to
The camera does not shoot even if you press the shutter release button.	Battery is exhausted.	Charge the rechargeable battery.	P.21
	The camera is not on.	Press the POWER button to turn the camera on.	P.23
	The camera is in playback mode.	Press the  (Playback) button to select the shooting mode.	P.32
	The shutter release button is not pressed all the way.	Press the shutter release button all the way.	P.26
	The SD memory card is not formatted.	Format the card.	P.93
	The SD memory card is full.	Load a new card, or delete unwanted files.	P.22, P.35
	The SD memory card has reached the end of its useful life.	Load a new SD memory card.	P.22
	The flash is charging.	Wait until the flash mode symbol stops blinking.	P.29
	The SD memory card is locked.	Unlock the card.	P.20
	The contact surface of the SD memory card is dirty.	Wipe with a soft, dry cloth.	—
Unable to view the shot image.	The image confirmation time is too short.	Lengthen the image confirmation time.	P.94
Images do not appear on the picture display.	The camera is not on, or the picture display is dark.	Turn the camera on, or adjust the brightness of the picture display.	P.23, P.93
	The VIDEO/AV cable is connected.	Disconnect the VIDEO/AV cable.	—
	The screen display is in synchronizer mode.	Press the DISP. button to change the display.	P.38
Although the camera is set to auto focus, it is unable to focus.	The lens is dirty.	Wipe clean with a soft, dry cloth.	—
	The subject is not in the center of the shooting range.	Shoot with focus lock.	P.25
	It is a hard-to-focus subject.	Shoot with focus lock or manual focus.	P.25, P.73
Although the camera is not in focus, the green frame appears in the center of the picture display.	The camera incorrectly focused because the distance to the subject is too close.	Shoot with macro mode, or move away from the subject.	P.28
The picture is blurred. (The   symbol appears.)	You moved the camera when pressing the shutter release button.	Hold camera in both hands with your elbows pressed lightly against your torso. Use a tripod. Use the camera shake correction function.	P.25 P.70
	When shooting in a dark place (such as indoors), the shutter speed slows down and pictures become easily blurred.	Use the flash. Raise the ISO setting. Use the camera shake correction function.	P.29 P.78 P.70

Problem	Cause	Solution	Refer to
The flash does not fire. Or, the flash cannot charge.	The flash cannot be used in the following cases: <ul style="list-style-type: none"> • In bracket shooting • In continuous mode • In movie mode • In pets mode • In discreet mode In some scene modes, the flash is disabled by default.	To shoot with the flash, change the settings or mode.	P.29, P.118
	The flash is set to flash off.	Cancel Flash Off.	P.29
	Battery is exhausted.	Charge the rechargeable battery.	P.21
Even though the flash fired, the picture is dark.	The distance to the subject exceeds the flash range.	Get closer to your subject and shoot. Change the flash mode or the ISO setting.	P.78, P.122
	The subject is dark.	Correct the exposure. (Exposure compensation also changes the light intensity of the flash.)	P.76
	The light intensity of the flash is not appropriate.	Adjust the light intensity of the flash.	P.69
The image is too bright.	The light intensity of the flash is not appropriate.	Adjust the light intensity of the flash. Alternatively, move a little away from the subject or illuminate the subject with another light source instead of using the flash.	P.29, P.69
	Subject is overexposed. (The [!AE] symbol appears.)	Correct the exposure. Cancel exposure time.	P.76 P.69
	The brightness of the picture display is not appropriate.	Adjust the brightness of the picture display.	P.93
The image is too dark.	The shot was taken in a dark place while set to flash off.	Cancel Flash Off.	P.29
	The subject is underexposed. (The [!AE] symbol appears.)	Correct the exposure. Set the long exposure time.	P.76 P.69
	The brightness of the picture display is not appropriate.	Adjust the brightness of the picture display.	P.93
The image lacks natural color.	The picture was shot in conditions that made it difficult for auto white balance to adjust the white balance.	Add a white object to the composition, or use a white balance setting other than auto.	P.77
The date or recording information does not appear on the screen.	The screen display function is set to no display.	Press the DISP. button to change the display.	P.38
The brightness of the picture display changes during AF.	Ambient lighting is poor or differs from that used for autofocus..	This is normal.	—

Problem	Cause	Solution	Refer to
The level indicator is not displayed.	[Level Setting] is set to [Off] or [Sound].	Set [Level Setting] to [Display] or [Display+Sound].	P.40
	The display is set to a setting other than normal symbol display or histogram.	Press the DISP. button to change the display to normal symbol display or histogram.	P.38
	The camera is upside down (The shutter release button is on the bottom).	Hold the camera correctly.	—
The image is tilted even though it was shot with the level indicator in the middle or while the level sound was sounding.	You shot the image while moving, such as on an amusement ride.	Shoot in an environment that is not moving.	—
	The subject is not level.	Check the subject.	—
Self timer lamp does not light.	[Pets] or [Discreet Mode] is selected in scene mode.	Choose another mode.	P.50, P.52

Playback/Deleting

Problem	Cause	Solution	Refer to
Cannot play back, or the playback screen does not appear.	The camera is not in playback mode.	Press the  (Playback) button.	P.32
	The VIDEO/AV cable is not connected properly.	Connect properly.	P.91
	The [Video Out Mode] setting is incorrect.	Set it to the correct format.	P.96
The contents of the SD memory card cannot be played back, or the playback screen does not appear.	No SD memory card is loaded, or an SD memory card with no stored images is loaded.	Load a card with stored images.	—
	You played back an SD memory card that was not formatted with this device.	Load a card that was formatted and recorded with this device.	P.20, P.93
	You played back an SD memory card that was not recorded normally.	Load a normally recorded card.	—
	The contact surface of the SD memory card is dirty.	Wipe with a soft, dry cloth.	—
	There is something wrong with the SD memory card.	Play back images from another card and if there is nothing wrong with the card, the camera is okay. There may be something wrong with the card, so do not use it.	—













Problem	Cause	Solution	Refer to
The picture display turned off.	Battery is exhausted.	Charge the rechargeable battery.	P.21
	The camera was left unattended and unused, so auto power off turned it off.	Turn the camera back on.	P.23
Part of the screen flashes in black.	The screen is highlighted due to an overly bright area.	It is recommended that you shoot another image while avoiding direct sunlight and setting the exposure level lower (-).	P.39, P.76
A file cannot be deleted.	The file is protected.	Unprotect the file.	P.89
	The SD memory card is locked.	Unlock the card.	P.20
Cannot format the SD memory card.	The SD memory card is locked.	Unlock the card.	P.20

Other Problems

Problem	Cause	Solution	Refer to
Cannot load the SD memory card.	The card is facing the wrong way.	Load correctly.	P.22
The camera does not operate even when the buttons are pressed.	Battery is exhausted.	Charge the rechargeable battery.	P.21
	Camera malfunction	Press the POWER button to turn the camera off, and then press the POWER button to turn the camera on again. Remove the battery and load it again.	P.23 P.21
The date is incorrect.	The correct date/time are not set.	Set the correct date/time.	P.96
The set date disappeared.	The battery was removed.	If the battery is removed for more than one week, the date setting will be lost. Make the settings again.	P.24
Auto power off does not work.	Auto power off is set to [Off].	Set the time for auto power off.	P.94
The operation sound cannot be heard.	[Pets] or [Discreet Mode] is selected in scene mode.	Choose another mode.	P.50, P.52
	The operation sound volume is turned off.	Use [Volume Settings] to set the volume to a setting other than mute.	P.94
Images do not appear on the TV.	The [Video Out Mode] setting is incorrect.	Set it to the correct format.	P.96
	The AV cable is not connected.	Connect the AV cable properly.	P.91
	The TV is not correctly set to VIDEO IN.	Check that the TV is correctly set to VIDEO IN.	—

Available Settings

The following table lists the settings available in each shooting mode.

				S-AUTO	SCENE							
												
 (Macro) *1		✓	✓	—	—	—	—	—	—	✓	—	
 (Flash)		✓	—	✓*2	✓	✓	—	✓*3	✓*4	✓	—	
 (Self-timer) *5		✓	—	✓	✓	✓	✓	✓	✓	✓	✓	
Digital Zoom		✓	✓*6	✓	✓	✓	✓	✓	✓	✓	✓	
Shooting Menu	Dynamic Range Expansion	—	—	—	—	—	—	—	—	—	—	
	Plus Normal Shooting	—	—	—	—	—	—	—	—	—	—	
	Picture Quality/Size	✓	—	✓	✓	✓	✓	✓	✓	✓	✓	
	Movie Size	—	✓	—	—	—	—	—	—	—	—	
	Density	—	—	—	—	—	—	—	—	—	—	
	Size	—	—	—	—	—	—	—	—	—	—	
	Focus	Multi AF *8	✓	✓	—	—	✓	—	✓	✓	✓	—
		Spot AF	✓	✓	—	—	✓	—	✓	✓	✓	—
		Face-Pri. AF *9	✓	✓	—	—	✓	—	✓	✓	✓	—
		Continuous AF	✓	✓	—	—	✓	—	✓	✓	✓	—
		Multi-trgt AF *10	✓	—	—	—	—	—	—	—	—	—
		MF	✓	—	—	—	—	—	—	—	—	—
		Snap	✓	—	—	—	✓	—	✓	✓	✓	—
	∞	✓	✓	—	—	✓	—	✓	✓	✓	—	
	Pre-AF *11	✓	✓	—	—	✓	—	✓	✓	✓	—	
Exposure Metering	✓	—	—	—	—	—	—	—	—	—		
Image Settings	✓	—	—	—	—	—	—	—	—	—		
Noise Reduction	✓	—	—	—	—	—	✓	✓	—	✓		
Flash Exposure Compensation	✓	✓	—	✓	✓	—	—	✓	✓	—		
Auto Bracket *13	✓	—	—	—	—	—	—	—	—	—		
Time Exposure *14	✓	—	—	—	—	—	—	—	—	—		
Custom Self-Timer	✓	—	—	✓	✓	✓	✓	✓	✓	✓		
Interval Shooting *15	✓	—	—	—	—	—	—	—	—	—		

*1 [Focus] is set to [Spot AF]. Disabled when [MF] is selected for [Focus].

*2 Only [Flash Off] or [Auto] can be selected.

*3 Only [Red-Eye Flash] or [Flash Synchro.] can be selected.

*4 Only [Flash Off], [Auto] or [Flash Synchro.] can be selected.

*5 Self-timer disabled when [Interval Shooting] is in effect. [Custom Self-Timer] is not available when [Focus] is set to [Multi-trgt AF].

*6 Only digital zoom (1280: up to 2.8x; 640 or 320: up to 4.0x) can be used.

*7 Only [10M 4:3 F] or [3M 4:3 F] is available.

*8 [Spot AF] used when digital zoom is in effect.

*9 Camera selects optimal white balance; no icon is displayed. Equivalent to multi-pattern auto if no face is detected.

		SCENE											DR
(Macro) *1		✓	✓	✓	✓	✓	✓	✓	✓	✓	✓	✓	
(Flash)		✓	✓	—	✓	✓	—	—	—	—	—	—	
(Self-timer) *5		✓	✓	✓	✓	✓	—	—	—	—	—	✓	
Digital Zoom		✓	✓	✓	✓	✓	✓	✓	✓	✓	✓	—	
Shooting Menu	Dynamic Range Expansion	—	—	—	—	—	—	—	—	—	—	✓	
	Plus Normal Shooting	—	—	—	—	—	—	—	—	—	—	✓	
	Picture Quality/Size	✓	✓	✓	✓	—	✓*7	✓	—	—	—	✓	
	Movie Size	—	—	—	—	—	—	—	—	—	—	—	
	Density	—	—	—	—	✓	—	—	—	—	—	—	
	Size	—	—	—	—	✓	—	—	—	—	—	—	
	Focus	Multi AF *8	✓	✓	✓	✓	—	✓	✓	✓	✓	✓	✓
		Spot AF	✓	✓	✓	✓	—	✓	✓	✓	✓	✓	✓
		Face-Pri. AF *9	✓	✓	✓	—	—	✓	✓	✓	✓	✓	—
		Continuous AF	✓	✓	✓	✓	—	—	✓	✓	✓	✓	—
		Multi-trgt AF *10	—	—	✓	—	—	—	—	—	—	—	—
		MF	—	—	✓	✓	—	—	✓	✓	✓	✓	✓
		Snap	✓	✓	✓	—	—	—	✓	✓	✓	✓	✓
	∞	✓	✓	✓	—	—	—	✓	✓	✓	✓	✓	
	Pre-AF *11	✓	✓	✓	✓	—	✓	✓	✓	✓	✓	✓	
	Exposure Metering	—	—	✓	✓	—	✓	✓	✓	✓	✓	✓	
	Image Settings	—	—	✓	✓	—	✓	✓	✓	✓	✓	✓*12	
Noise Reduction	✓	—	✓	✓	—	—	—	—	—	—	✓		
Flash Exposure Compensation	✓	✓	✓	✓	—	✓	—	—	—	—	—		
Auto Bracket *13	—	—	✓	✓	—	—	—	—	—	—	—		
Time Exposure *14	—	—	✓	✓	—	—	—	—	—	—	—		
Custom Self-Timer	✓	✓	✓	✓	✓	—	—	—	—	—	✓		
Interval Shooting *15	—	—	✓	—	—	—	—	—	—	—	✓		

*10 The flash cannot be used. The custom self-timer is not available. Digital zoom, [Time Exposure], [Custom Self-Timer], [Interval Shooting], and [Camera Shake Correction] are disabled. [Auto] is used for [White Balance].

*11 Not available when [MF], [Snap], or [∞] is selected for [Focus].

*12 Only [Color], [Black & White] or [Sepia] can be selected.

*13 The flash cannot be used. [Time Exposure] is disabled. Not available when [Focus] is set to [Multi-trgt AF].

*14 [Camera Shake Correction] is disabled.

*15 When the self-timer is set, [Interval Shooting] is disabled. Not available when [Focus] is set to [Multi-trgt AF].

				S- AUTO	SCENE							
Shooting Menu	Camera Shake Correction *16	✓	—	—	✓	✓	✓	✓	✓	✓	✓	
	Slow Shutter Limit	✓	—	—	✓	✓	✓	✓	✓	✓	✓	
	Date Imprint	✓	—	—	✓	✓	✓	✓	✓	✓	✓	
	Exposure Compensation	✓	—	—	✓	✓	✓	✓	✓	✓	✓	
	White Balance *17	Multi-P AUTO	✓	—	—	✓	✓	✓	✓	✓	✓	✓
		Other than those above	✓	✓	—	—	✓	✓	✓	✓	✓	✓
	ISO Setting	✓	—	—	✓	—	✓	—	—	✓	—	
Restore Defaults	✓	—	—	—	—	—	—	—	—	—		
Setup Menu	Set Fn Button *18, 19	Macro Target	✓	✓	—	—	—	—	—	—	—	
		Step Zoom	✓	✓	—	✓	✓	✓	✓	✓	✓	
		AE Lock	✓	—	—	✓	✓	✓	✓	✓	✓	
		AF/Face Pr. AF	✓	✓	—	—	✓	—	✓	✓	—	
		AF/Cont. AF	✓	✓	—	✓	✓	✓	✓	✓	✓	
		AF/M-trgt AF	✓	—	—	—	—	—	—	—	—	
		AF/MF	✓	✓	—	—	—	—	—	—	—	
		AF/Snap	✓	✓	—	—	✓	✓	✓	✓	—	
		AT-BKT	✓	—	—	—	—	—	—	—	—	
		WB-BKT	✓	—	—	—	—	—	—	—	—	
		CL-BKT	✓	—	—	—	—	—	—	—	—	
	FOCUS-BKT	✓	—	—	—	—	—	—	—	—		
	ADJ Button Setting 1–4 *20	Exposure Comp.	✓	—	—	✓	✓	✓	✓	✓	✓	
		White Balance	✓	✓	—	—	✓	✓	✓	✓	✓	
		ISO	✓	—	—	—	—	—	—	—	—	
		Quality	✓	—	✓	—	—	—	—	—	—	
		Focus	✓	—	—	—	—	—	—	—	—	
		Image	✓	—	—	—	—	—	—	—	—	
		Expo. Metering	✓	—	—	—	—	—	—	—	—	
		Auto Bracket	✓	—	—	—	—	—	—	—	—	
Flash Comp.		✓	—	—	—	—	—	—	—	—		
Density	—	—	—	—	—	—	—	—	—			
Shooting Info. Display Frame	✓	—	✓	✓	✓	✓	✓	✓	✓	✓		
Other than those above	✓	✓	—	✓	✓	✓	✓	✓	✓	✓		

*16 Not available if [Focus] is set to [Multi-trgt AF] or when using [Time Exposure].

*17 Not available when [Image Settings] is set to [Black & White] or [Sepia].

*18 The Fn button can not be used for the selected function when [Miniaturize] is selected in scene mode.

*19 The functions not marked with a checkmark (✓) can also be assigned to the Fn button, but are not available in scene or movie mode.

*20 Settings other than [Discreet Mode] can not be changed in movie and scene modes.

		SCENE											DR	
Shooting Menu	Camera Shake Correction *16	✓	✓	✓	✓	✓	✓	—	—	—	—	—	✓	
	Slow Shutter Limit	✓	✓	✓	✓	✓	✓	✓	✓	✓	✓	✓	—	
	Date Imprint	✓	✓	✓	✓	✓	✓	✓	✓	—	✓	✓	✓	
	Exposure Compensation	✓	✓	✓	✓	—	✓	✓	✓	✓	✓	✓	✓	
	White Balance *17	Multi-P AUTO	✓	—	✓	✓	—	✓	—	—	—	—	✓	
		Other than those above	✓	—	✓	✓	—	✓	✓	✓	✓	✓	✓	
	ISO Setting	—	✓	✓	✓	—	✓	✓	✓	✓	✓	✓	✓	
Restore Defaults	—	—	✓	—	—	—	—	—	—	—	—	—		
Setup Menu	Set Fn Button *18, 19	Macro Target	✓	—	—	✓	✓	✓	✓	✓	✓	✓	✓	
		Step Zoom	✓	✓	✓	✓	✓	✓	✓	✓	✓	✓	✓	
		AE Lock	✓	✓	✓	✓	✓	✓	✓	✓	✓	✓	✓	
		AF/Face Pr. AF	✓	✓	✓	—	—	—	✓	✓	✓	✓	✓	—
		AF/Cont. AF	✓	✓	✓	✓	✓	✓	✓	✓	✓	✓	✓	—
		AF/M-trgt AF	—	—	✓	—	—	—	—	—	—	—	—	—
		AF/MF	—	—	✓	✓	—	✓	✓	✓	✓	✓	✓	✓
		AF/Snap	✓	✓	✓	—	—	✓	✓	✓	✓	✓	✓	✓
		AT-BKT	—	—	✓	✓	—	—	—	—	—	—	—	—
		WB-BKT	—	—	✓	✓	—	—	—	—	—	—	—	—
		CL-BKT	—	—	✓	✓	—	—	—	—	—	—	—	—
	FOCUS-BKT	—	—	✓	✓	—	—	—	—	—	—	—	—	
	ADJ Button Setting 1–4 *20	Exposure Comp.	✓	✓	✓	✓	—	✓	✓	✓	✓	✓	✓	✓
		White Balance	✓	—	✓	✓	—	✓	✓	✓	✓	✓	✓	✓
		ISO	—	—	✓	—	—	—	✓	✓	✓	✓	✓	✓
		Quality	—	—	✓	—	—	—	✓	—	—	—	—	✓
		Focus	—	—	✓	—	—	—	✓	✓	✓	✓	✓	✓
		Image	—	—	✓	—	—	—	✓	✓	✓	✓	✓	✓
		Expo. Metering	—	—	✓	—	—	—	✓	✓	✓	✓	✓	✓
Auto Bracket		—	—	✓	—	—	—	—	—	—	—	—	—	
Flash Comp.		—	—	✓	—	—	—	—	—	—	—	—	—	
Density	—	—	—	—	✓	—	—	—	—	—	—	—		
Shooting Info. Display Frame	✓	✓	✓	✓	✓	✓	✓	✓	✓	✓	✓	✓		
Other than those above	✓	✓	✓	✓	✓	✓	✓	✓	✓	✓	✓	✓		

Specifications

No. of effective pixels (camera)		Approx. 10.00 million effective pixels
Image Sensor		1/2.3" CMOS (Approx. 10.60 total million pixels)
Lens	Focal Length	4.9 mm to 52.5 mm (equivalent to 28 mm to 300 mm on a 35-mm camera)
	F-aperture	F3.5 to F5.6
	Shooting Distance	Normal shooting: Approx. 30 cm to ∞ (Wide-angle) or 1.5 m to ∞ (Telephoto) (from the front of the lens)
		Macro shooting: Approx. 1 cm to ∞ (Wide-angle), 28 cm to ∞ (Telephoto) or 1 cm to ∞ (Zoom macro mode) (from the front of the lens)
Lens Construction	10 elements in 7 groups (4 aspherical lens elements with 5 surfaces)	
Zoom Magnification		Optical zoom at 10.7×, Digital zoom at 4.8×, Auto resize zoom at approx. 5.7× (VGA image)
Focus Modes		Multi AF (Contrast AF method)/Spot AF (Contrast AF method)/Face-Priority AF/Continuous AF/Multi-target AF/MF/Snap/∞ (with AF Auxiliary Light)
Blur Reduction		Image Sensor Shift Image Stabilizer
Shutter Speed	Still Image	8, 4, 2, 1 to 1/2000 seconds (The upper and lower limits differ for each shooting mode and flash mode.)
	Movie	1/30 to 1/2000 seconds
Exposure Control	Exposure Metering Mode	Multi Light Metering (256 segments)/Center-weighted Light Metering/Spot Metering
	Exposure Mode	Program AE
	Exposure Compensation	Manual exposure compensation (+2.0 to -2.0 EV in 1/3 EV Steps), Auto bracket function (-0.5 EV, ±0, +0.5 EV)
ISO Sensitivity (Standard Output Sensitivity)		Auto/ISO 80/ISO 100/ISO 200/ISO 400/ISO 800/ISO 1600/ISO 3200
White Balance Mode		Auto/Multi-pattern Auto/Outdoors/Cloudy/Incandescent Lamp/Incandescent Lamp 2/Fluorescent Lamp/Manual Settings, White balance bracket function
Flash	Flash Mode	Auto flash (fires automatically in low-light conditions and when the subject is backlit)/Red-eye Flash/Flash On/Flash Synchro./Flash Off
	Built-in flash Range	Approx. 20 cm to 4.0 m (Wide-angle), approx. 28 cm to 4.0 m (Telephoto) (ISO AUTO/ISO 1600, from the front of the lens)
	Flash Compensation	±2.0 EV (1/3 EV Steps)
	Charging Time	Approx. 5 seconds
Picture Display		3.0" Transmissive LCD, approx. 920,000 dots
Shooting Mode		Auto shooting mode/Scene auto mode/Scene mode (Portrait/Sports/Pets/Night. Port./Nightscape/Miniaturize/Landscape/High Sens/High Contrast B&W/Discreet Mode/Zoom Macro/Text Mode/Skew Correct Mode)/My settings mode/Movie mode/Dynamic range double shot mode/Continuous mode
Picture Quality Mode *1		F (Fine), N (Normal)
Number of Recorded Pixels	Still Image	3648 × 2736, 3648 × 2432, 2736 × 2736, 3648 × 2048, 2592 × 1944,
	Multi-Picture	2048 × 1536, 1728 × 1296 (Multi-Picture only), 1280 × 960, 640 × 480
	Movie	1280 × 720, 640 × 480, 320 × 240
	Text	3648 × 2736, 2048 × 1536
Recording Media		SD memory card, SDHC memory card (up to 32 GB), Internal Memory (approx. 88 MB)

Recording Data Capacity	3648 × 2736	N: approx. 2169 KB/Screen, F: approx. 3704 KB/Screen
	3648 × 2432	F: approx. 3295 KB/Screen
	2736 × 2736	F: approx. 2784 KB/Screen
	3648 × 2048	F: approx. 2779 KB/Screen
	2592 × 1944	F: approx. 2287 KB/Screen
	2048 × 1536	F: approx. 1474 KB/Screen
	1728 × 1296	N: approx. 603 KB/Screen
	1280 × 960	F: approx. 812 KB/Screen
Recording File Format	640 × 480	F: approx. 197 KB/Screen
	Still Image	JPEG (Exif Ver. 2.21)*2
	Multi-Picture	Compliant with CIPA DC-007-2009 Multi Picture Format
	Movie	AVI (Open DML Motion JPEG Format Compliant)
	Compression Format	JPEG Baseline Format Compliant (Still image, movie)
Other Major Shooting Functions	Continuous mode, Self-timer (operation time: approx. 10 seconds, approx. 2 seconds, Custom), Interval shooting (shooting interval: 5 seconds to 1 hour, in increments of 5 seconds)*3, Color bracket, Focus bracket, AE/AF target shift, Histogram display, Grid guide display, Electronic level	
Other Major Playback Functions	Thumbnail view, Enlarged view (maximum ×16), Resize, Level Compensation, White Balance Compensation, Skew Correction, Trim, Flag Function, Slide show, DPOF	
Interface	USB2.0 (High-Speed USB) Mini-B, Mass storage-compatible *4, AV output 1.0Vp-p (75 Ω)	
Video Signal Format	NTSC, PAL	
Power Supply	Rechargeable Battery (DB-100): 3.7V	
Battery Consumption *5	Usage time of DB-100: approx. 310 pictures (When [LCD Auto Dim] is set to [On] *6)	
Dimensions (W × H × D)	101.5 mm × 58.3 mm × 29.4 mm (excluding projections; measured according to CIPA guidelines)	
Weight	Approx. 206 g (including memory card and supplied battery) Approx. 185 g (camera only)	
Tripod Hole Shape	1/4-20UNC	
Date Maintain Time	Approx. 1 week	
Operating Temperature	0 °C to 40 °C	
Operating Humidity	85% or less	
Storage Temperature	-20 °C to 60 °C	

*1 The picture quality mode that can be set varies depending on the image size.

*2 Compatible with DCF and DPOF. DCF is the abbreviation for "Design rule for Camera File system," a JEITA standard. (Full compatibility with other devices is not guaranteed.)

*3 When the flash is set to [Flash Off].









*4 Mass storage mode is supported by Windows 2000, Windows XP, Windows Vista, Windows 7, Mac OS 9.0-9.2.2, and Mac OS X 10.1.2-10.6.1.

*5 The number of remaining shots is based on the CIPA standard and may vary depending on usage conditions. This is for reference only.

*6 You can take approximately 290 shots when [LCD Auto Dim] is set to [Off].

Number of Images That Can Be Stored

The following table shows the approximate number of images that can be recorded in the internal memory and onto an SD memory card at various image size and picture quality settings.

Mode	Image Size	Internal Memory	1GB	2GB	4GB	8GB	16GB	32GB
 SCENE (other than Text Mode) S-AUTO  (Continuous Mode) 	10M 4:3 F	22	242	491	965	1973	3953	7930
	10M 4:3 N	38	414	842	1653	3379	6769	13579
	9M 3:2 F	25	272	553	1087	2222	4452	8930
	7M 1:1 F	30	323	653	1284	2624	5257	10546
	7M 16:9 F	30	323	653	1284	2624	5257	10546
	5M 4:3 F	34	373	758	1490	3045	6101	12238
	3M 4:3 F	54	581	1182	2321	4744	9503	19063
	1M 4:3 F	98	1059	2118	4160	8505	17039	34181
	VGA 4:3 F	402	4316	8778	17237	35231	70579	141581
 (When [Focus] is set to [Multi-trgt AF])	10M 4:3 F	22	240	487	957	1957	3922	7867
	10M 4:3 N	38	408	830	1631	3333	6678	13396
	9M 3:2 F	25	269	548	1077	2202	4412	8851
	7M 1:1 F	29	319	647	1270	2596	5202	10435
	7M 16:9 F	29	319	647	1270	2596	5202	10435
	5M 4:3 F	34	368	749	1471	3008	6026	12089
	3M 4:3 F	53	570	1159	2277	4654	9324	18704
	1M 4:3 F	94	1023	2047	4022	8221	16471	33042
	VGA 4:3 F	352	3776	7681	15082	30828	61759	123888
SCENE (Text Mode)	10M 4:3	38	414	842	1653	3379	6769	13579
	3M 4:3	99	1078	2194	4309	8809	17647	35402
	HD 1280	17 s	3 min. 3 s	6 min. 14 s	12 min. 14 s	25 min. 1 s	50 min. 7 s	100 min. 33 s
	VGA 640	50 s	8 min. 55 s	18 min. 8 s	35 min. 38 s	72 min. 50 s	145 min. 54 s	292 min. 41 s
	QVGA 320	2 min. 1 s	21 min. 39 s	44 min. 2 s	86 min. 28 s	176 min. 44 s	354 min. 3 s	710 min. 13 s
 (M-Cont Plus (10M))	10M 4:3 N	38	414	842	1653	3379	6769	13579
 (M-Cont Plus (2M))	2M 4:3 N	133	1438	2926	5746	11745	23530	47202
 (Speed Cont)	VGA 4:3 N	705	7553	15359	30159	61643	123489	247716



Note

- The maximum recording time is the estimated total recording time. The maximum recording time per shooting is 29 minutes.
- The maximum number of consecutive shots that can be taken using continuous mode is 999. When the number of remaining shots is 1000 or more, "999" is displayed on the picture display.
- The maximum numbers of shots for M-Cont Plus (2M)/M-Cont Plus (10M) and Speed Cont are the estimated total numbers of shots that can be recorded. The maximum number of shots that can be taken consecutively at one time is 26 for M-Cont Plus (2M) and 15 for M-Cont Plus (10M) and 120 for Speed Cont.
- The maximum number of shots for Multi-trgt AF is the estimated total number of shots that can be recorded. The number of shots that can be recorded at one time is five. When the number of remaining shots is 9999 or more, "9999" is displayed on the picture display.
- The number of remaining shots displayed on the picture display may differ from the actual number of shots, depending on the subject.
- Movie recording time and the maximum number of still pictures may vary depending on the capacity of the recording destination (internal memory or SD memory card), shooting conditions, and the type and manufacturer of the SD memory card.
- A high speed memory card is recommended when shooting for long periods.
- Choose image size according to how the picture will be used:

Image Size	Description
10M 4 : 3 F / 10M 4 : 3 N / 9M 3 : 2 F / 7M 1 : 1 F / 7M 16 : 9 F	• For creating large prints. • For downloading to a computer for trimming and other processes.
5M 4 : 3 F / 3M 4 : 3 F	• For creating prints.
1M 4 : 3 F	• For shooting a large number of pictures. • For shooting a large number of pictures.
VGA 4 : 3 F	• For attaching to e-mail. • For posting on a website.

Defaults Settings/Functions Whose Defaults Are Restored When the Camera Is Turned Off

Turning the camera off may reset some function settings to their defaults.

The table below indicates whether or not the function is reset to its default when the camera is turned off.

○: setting is saved ×: setting is reset

	Function		Default Settings
Shooting	Dynamic Range Expansion	○	Auto
	Plus Normal Shooting	○	Off
	Picture Quality/Size	○	10M 4 : 3 N
	Density	○	Normal
	Size (Text Mode)	○	10M 4 : 3
	Movie Size	○	HD 1280
	Focus	○	Multi AF
	Pre-AF	○	Off
	Exposure Metering	○	Multi
	Image Settings	○	Standard
	Noise Reduction	○	Auto
	Flash Exposure Compensation	○	0.0
	Auto Bracket	○	Off
	Time Exposure	○	Off
	Custom Self-Timer	○	Pictures: 2 Pics, Interval: 5 Sec.
	Interval Shooting	×	0 Sec.
	Camera Shake Correction	○	On
	Slow Shutter Limit	○	Off
	Date Imprint	○	Off
	Exposure Compensation	○	0.0
	White Balance	○	Multi-P AUTO
	ISO Setting	○	Auto
Macro	○	Macro Off	
Flash	○	Auto	
Self-Timer	×	Self-Timer Off	
Playback	Volume Adjustment	○	—

○: setting is saved ×: setting is reset

	Function		Default Settings
Setup	LCD Brightness	○	—
	Reg. My Settings	○	—
	Step Zoom	○	Off
	Set Fn Button	○	Macro Target
	ADJ Button Setting 1	○	Exposure Comp.
	ADJ Button Setting 2	○	White Balance
	ADJ Button Setting 3	○	ISO
	ADJ Button Setting 4	○	Quality
	Maximum ISO for ISO Auto	○	AUTO 1600
	AF Auxiliary Light	○	On
	Operation Sounds	○	All
	Volume Settings	○	■ ■ □ (Medium)
	LCD Confirmation Time	○	0.5 seconds
	Auto Power Off	○	5 minutes
	LCD Auto Dim	○	On
	Grid Guide Display Options	○	田田
	Digital Zoom Image	○	Normal
	Level Setting	○	Display
	Shooting Info. Display Frame	○	Off
	Minimum Distance	○	Show
	Auto Rotate	○	On
	White Saturation Display	○	Off
	Card Sequence No.	○	Off
	Date Settings	○	—
	Language/言語	○	(※1)
Video Out Mode	○	(※1)	

(※1) The default setting varies depending on where you purchased the camera.

Using Your Camera Abroad

Battery Charger (Model BJ-10)

The battery charger can be used in regions with a current of 100-240V, 50 Hz/60 Hz. If you are going to travel to a country that uses a different shaped wall outlet/plug, please consult your travel agent on a plug adapter suitable for wall outlets in your country of destination.

Do not use electrical transformers. It may damage the camera.

Warranty

This product was manufactured for use in the country in which it was purchased. The warranty is only valid in the country in which the camera was purchased. Should the product fail or malfunction while you are abroad, the manufacturer assumes no responsibility for servicing the product locally or bearing the expenditure incurred therefore.

Playback on Television in Other Regions

Playback is possible on televisions (or monitors) equipped with a video input terminal. Please use the AV cable provided.

This camera is compatible with both NTSC and PAL television formats. Set the video format on the camera to match that of the television you are using.

When you go abroad, set your camera to the local video format.

Cautions on Use

Cautions on Use

- This product was manufactured for use in the country in which it was purchased. The warranty is only valid in the country in which the camera was purchased.
- Should the product fail or malfunction while you are abroad, the manufacturer assumes no responsibility for servicing the product locally or bearing the expenditure incurred therefore.
- Be sure not to drop or apply any sudden force to the camera.
- While you are carrying the camera, be careful not to hit it against other objects. Take special care to not hit the lens and picture display.
- Firing the flash consecutively may heat the firing unit. Do not fire it consecutively more than necessary.
- Do not touch the flash and keep foreign objects away from the firing unit. Doing so can cause burns and fires.
- Do not fire the flash near eyes. It could cause visual impairment (particularly for infants).
- Do not fire the flash near the driver of a vehicle to avoid causing accidents.
- The battery may become hot after extended use. Touching the battery immediately after use could result in burns to your fingers.
- If the picture display or panel is exposed to sunlight, they may become washed out and images may become hard to view.
- The picture display and panel may contain some pixels that do not remain lit up continually in part or at all. Also, the brightness may become uneven because of the characteristics of LCDs. These are not failures.
- Do not forcefully press the surface of the picture display.
- In an environment where the temperature changes suddenly, condensation may occur in the camera, resulting in troubles such as fogging of the glass surface or malfunctions of the camera. If this occurs, place the camera in a bag to slow the temperature change as much as possible. Take it out of the bag after the temperature difference from the atmosphere has decreased to a fairly small amount. If condensation occurs, remove the battery and memory card, and wait until the moisture has dried before using the camera.
- To avoid damaging the connectors, do not put any objects into the camera's microphone or speaker holes.
- Do not get the camera wet. Do not operate the camera with wet hands. This can result in malfunction or an electrical shock.
- Before taking any important pictures (such as at weddings, on trips abroad, etc.), test the camera to check operation and ensure proper functioning. We recommend that you keep this manual and spare battery on hand.



Conditions in which condensation may easily occur: -----

- When the camera is moved to an environment where the temperature differs greatly.
- In humid places.
- In a room immediately after being heated, or when the camera is exposed directly to cooled air from an air-conditioner or another similar appliance.

Care and Storage

Care

- Please note that if fingerprints, dirt, etc. get onto the lens, picture quality will suffer.
- When dust or dirt does get on the lens, do not touch it directly with your fingers, and either use a blower (available in stores) to blow it off, or a soft cloth to gently dust it off.
- After use at the beach or around chemicals, wipe it off particularly carefully.
- In the unlikely event that your camera fails to work properly, please consult your Ricoh Repair Center.
- There are high voltage circuits in this camera. As this is dangerous, do not dismantle this camera under any circumstances.
- Do not get volatile substances, such as thinner, benzene, or pesticides on your camera. This may cause a change in quality, paint to peel, etc.
- As the surface of the picture display is easily scratched, do not rub hard objects against it.
- Clean the surface of the picture display by wiping gently with a soft cloth containing a small amount of display cleaner (that does not contain organic solvents) sold in stores.

Use and Storage

- Please avoid using or storing your camera in the following kinds of places, as this may damage the camera.
 - In high heat and humidity, or where there is severe change in temperature or humidity.
 - Places with a lot of dust, dirt or sand.
 - Places with severe vibration.
 - Places where it is in direct contact with vinyl or rubber products or chemicals, including mothballs or other insect repellent, for long periods of time.
 - Places with strong magnetic fields (near a monitor, transformer, magnet, etc.).
- Remove the battery if you are not going to use the camera for a long period of time.

Precautions regarding care of your camera

1. Be sure to turn the power off.
2. Remove the batteries before caring for your camera.

Warranty and Servicing

1. This product is backed by a limited warranty. During the warranty period mentioned in the Warranty supplied with your camera, any defective parts will be repaired free of charge. In the event of a camera malfunction, contact the dealer from which you purchased the camera or your nearest Ricoh Repair Center. Please note that you will be not be reimbursed for the cost of bringing the camera to the Ricoh Repair Center.
2. This warranty does not cover any damage resulting from:
 - ① failure to follow the instructions in the instruction manual;
 - ② repair, modification or overhaul not conducted by an authorized service center listed in the instruction manual;
 - ③ fire, natural disaster, act of God, lightning, abnormal voltage, etc.;
 - ④ improper storage (noted in the "Camera User Guide"), leaking of battery and other fluids, mold, or otherwise insufficient care of the camera.
 - ⑤ submergence in water (flooding), exposure to alcohol or other beverages, infiltration of sand or mud, physical shock, dropping of the camera, or pressure on the camera, and other unnatural causes.
3. After the warranty period has passed, you will be liable for all repair fees, including those incurred at an authorized service center.
4. You will be liable for all repair fees, even within the warranty period, if the warranty card is not attached or if the distributor's name or the purchase date have been changed or are not indicated on the card.
5. Expenses for overhaul and thorough inspection by special request of the customer will be charged to the customer, whether or not they are incurred during the warranty period.
6. This warranty only applies to the camera and not to the accessories, such as the case and strap, nor does it apply to the battery and other consumables provided.
7. Any consequential damages arising from failure of the camera, such as expenses incurred in taking pictures or loss of expected profit, will not be reimbursed whether they occur during the warranty period or not.
8. The warranty is only valid in the country in which the camera was purchased.
 - * The above provisions refer to repairs offered free of charge, and do not limit your legal rights.
 - * The intention of the above provisions is also described in the warranty card provided with this camera.
9. Parts essential to the servicing of the camera (that is, components required to maintain the functions and quality of the camera) will be available for a period of five years after the camera is discontinued.
10. Please note that if the camera is seriously damaged by flooding, submergence, infiltration of sand or mud, violent shocks or dropping, it may not be repairable, and restoration to its original condition may be impossible.



Note

- Before sending the camera in for repair, check the battery and read the instruction manual again to ensure proper operation.
- Some repairs require a significant amount of time to be completed.
- When sending the camera to a service center, please include a note which describes the defective part and the problem as precisely as possible.
- Remove all accessories not related to the problem before sending the camera to the service center.
- This warranty does not apply to data stored on an SD memory card or in internal memory.

INFORMATION TO THE USER

USA FCC Part 15 Class B

The equipment has been tested and found to comply with the limits for a Class B digital device, pursuant to part 15 of the FCC Rules. These limits are designed to provide reasonable protection against harmful interference in a residential installation. This equipment generates, uses, and can radiate radio frequency energy and if not installed and used in accordance with the instructions, may cause harmful interference to radio communications. However, there is no guarantee that interference will not occur in a particular installation. If this equipment does cause harmful interference to radio or television reception, which can be determined by turning the equipment off and on, then user is encouraged to try to correct the interference by one or more of the following measures:

- Reorient or relocate the receiving antenna.
- Increase the separation between the equipment and receiver.
- Connect the equipment to an outlet on a circuit different from that to which the receiver is connected.
- Consult the dealer or an experienced radio/TV technician for help. (FCC 15.105B)

Changes or modifications not expressly approved by the party responsible for compliance could void the user's authority to operate the equipment. (FCC 15.21)

Properly shielded and grounded cables and connectors must be used for connection to a host computer in order to comply with FCC emission limits. (FCC 15.27)

An AC adapter with a ferrite core must be used for RF interference suppression.

COMPLIANCE INFORMATION STATEMENT

Product Name: DIGITAL CAMERA

Model Number: CX3

This device complies with Part 15 of the FCC Rules.

Operation is subject to the following two conditions:

- (1) This device may cause harmful interference, and
- (2) This device must accept any interference received, including interference that may cause undesired operation.

RICOH AMERICAS CORPORATION

5 Dedrick Place, West Caldwell NJ, 07006 Tel.: 1-800-225-1899

Note to Users in Canada

Note: This Class B digital apparatus complies with Canadian ICES-003

Remarque Concernant les Utilisateurs au Canada

Avertissement : Cet appareil numérique de la classe B est conforme à la norme NMB-003 du Canada

IMPORTANT SAFETY INSTRUCTIONS-SAVE THESE INSTRUCTIONS

DANGER-TO REDUCE THE RISK OF FIRE OR ELECTRIC SHOCK, CAREFULLY FOLLOW THESE INSTRUCTIONS.

Index

A

ADJ./OK Button	15, 44
ADJ Button Setting	44, 93
Adobe Reader	106
AE/AF Target Shift	45
AE Lock	48
AF Auxiliary Light	14, 93
Auto Bracket	69, 73, 74
Auto Power Off	23, 94
Auto Rotate	95
Auto Shooting Mode	13, 25
AV Cable	12, 91
AV Output Terminal	15, 91

B

Battery	21, 22
Battery/Card Cover	15, 22
Battery Charger	12, 21

C

Camera Shake	27
Camera Shake Correction	70
Card Sequence No.	96
CD-ROM	12, 103
Color Bracket (CL-BKT)	74
Continuous Mode	13, 58
Copy to Card from Internal Memory	81
Custom Self-Timer	69

D

Date Imprint	71
Date Settings	23, 96
Delete	35
Delete Button	15, 35
Density	67
Digital Zoom	28, 98
Digital Zoom Image	28, 94, 98
Direct Print	99
Discreet Mode	51
DISP. Button	15, 38
DL-10	103, 105
DPOF	81, 90
Dynamic Range	
Double Shot Mode	13, 56
Dynamic Range Expansion	57, 67

E

Enlarged View	34
Error Messages	112
Export Still Images	64, 80
Exposure Compensation	71, 76
Exposure Metering	68

F

Flag Function Display	80
Flag Function Setting	80, 82
Flash	14, 15, 29
Flash Exposure Compensation	69
Fn (Function) Button	15, 46
Focus	67, 72
Focus Bracket (FOCUS-BKT)	75
Format [Card]	93
Format [Internal Memory]	93

G

Grid Guide Display	38
Grid Guide Display Options	95

H

Handstrap	12
High Contrast B&W	51
High Sens	51
Histogram Display	42

I

Image Settings	68
Internal Memory	20, 124
Interval Shooting	70
ISO Setting	71, 78

L

Landscape	51
Language/言語	96
LCD Auto Dim	94
LCD Brightness	93
LCD Confirmation Time	94
Lens	14
Lens Cover	14
Level Compensation	80, 85
Level Indicator	40
Level Setting	40, 94

M

M-Cont Plus (10M)	58, 59
M-Cont Plus (2M)	58, 60
Macro	15, 28
Macro Target	47
Manual Focus (MF)	73

Maximum ISO for ISO Auto	93	Shooting Menu.....	66
MENU Button	15, 66, 79, 92	Shutter Release Button	14, 25
Microphone	14	Size.....	67
Miniaturize	51, 53	Skew Correction.....	80, 88
Minimum Distance	95	Skew Correct Mode.....	51, 55
Mode Dial	14	Slide Show	80
Movie Mode.....	13, 61	Slow Shutter Limit.....	71
Movie Size	67	Speaker	15
MP File	62	Speed Cont (High)	58, 60
Multi-Target AF.....	72	Speed Cont (Low).....	58, 60
My Settings Mode (MY).....	13, 97	Sports.....	50
N		Step Zoom.....	93
Night. Port.....	50	Synchro-Monitor Mode	38
Nightscape	50	T	
Noise Reduction.....	69	Text Mode	51
Normal Continuous Mode.....	58	Thumbnail View.....	32
O		Time Exposure	69
Operation Sounds.....	94	Trim	80, 83
P		Tripod Screw Hole.....	15
Pets	50	U	
PictBridge	99	USB Cable	99, 107, 109
Picture Display.....	15, 16	USB Terminal.....	15
Picture Quality/Size	67	V	
Playback Button.....	15, 23, 32, 79	Video Out Mode.....	96
Playback Menu.....	79	VM-1	110
Playback Mode.....	23, 32	Volume Settings	94
Plus Normal Shooting.....	57, 67	W	
Portrait.....	50	White Balance	71, 77
POWER Button.....	14	White Balance Bracket (WB-BKT).....	74
Pre-AF.....	68	White Balance Compensation.....	80, 87
Protect	80, 89	White Saturation Display	39, 95
R		White Saturation Highlights Display.....	39
Rechargeable Battery.....	21, 22	Z	
Recover File	81	Zoom.....	27
Reg. My Settings.....	93, 97	Zoom Lever	14, 27
Resize	80	Zoom Macro	51
Restore Defaults	71		
S			
Scene Auto Mode (S-AUTO).....	13, 31		
Scene Mode (SCENE).....	13, 50		
SD Memory Card.....	20, 22, 124		
Self-timer	15, 30		
Self-Timer Lamp.....	14		
Set Fn Button.....	46, 93		
Setup Menu	92		
Shooting Info. Display Frame.....	95		

Telephone Support Numbers in Europe

UK	(from within the UK) (from outside the UK)	0207 365 6580 +44 207 365 6580
Deutschland	(innerhalb Deutschlands) (außerhalb Deutschlands)	06331 268 438 +49 6331 268 438
France	(à partir de la France) (en dehors de la France)	0800 88 18 70 +33 1 60 60 19 94
Italia	(dall'Italia) (dall'estero)	02 696 33 451 +39 02 696 33 451
España	(desde España) (desde fuera de España)	91 406 9148 +34 91 406 9148

<http://www.service.ricohpmmc.com/>

From environmental friendliness to environmental conservation and to environmental management

Ricoh is aggressively promoting environment-friendly activities and also environment conservation activities to solve the great subject of management as one of the citizens on our precious earth.

To reduce the environmental loads of digital cameras, Ricoh is also trying to solve the great subjects of "Saving energy by reducing power consumption" and "Reducing environment-affecting chemical substances contained in products".



If a problem arises

First of all, see "Troubleshooting" (☞ P.112) in this manual. If the issues still persist, please contact a Ricoh office.

Ricoh Offices	
RICOH COMPANY, LTD.	3-2-3, Shin-Yokohama Kouhoku-ku, Yokohama City, Kanagawa 222-8530, JAPAN http://www.ricoh.com/r_dc/
RICOH AMERICAS CORPORATION	5 Dedrick Place, West Caldwell, New Jersey 07006, U.S.A. 1-800-22RICOH http://www.ricoh-usa.com/
RICOH INTERNATIONAL B.V. (EPMMC)	Oberrather Straße 6, D-40472 Düsseldorf, GERMANY (innerhalb Deutschlands) 06331 268 438 (außerhalb Deutschlands) +49 6331 268 438 http://www.ricoh.com/r_dc/
RICOH UK LTD. (PMMC UK)	(from within the UK) 0207 365 6580 (from outside the UK) +44 207 365 6580
RICOH FRANCE S.A.S. (PMMC FRANCE)	(à partir de la France) 0800 88 18 70 (en dehors de la France) +33 1 60 60 19 94
RICOH ESPAÑA, S.A. (PMMC SPAIN)	(desde España) 91 406 9148 (desde fuera de España) +34 91 406 9148
RICOH ITALIA srl (PMMC ITALY)	(dall'Italia) 02 696 33 451 (dall'estero) +39 02 696 33 451
RICOH ASIA PACIFIC OPERATIONS LIMITED	21/F, One Kowloon, 1 Wang Yuen Street, Kowloon Bay, Hong Kong
About Irodio Photo & Video Studio	
North America (U.S.)	(Toll Free) +1-800-458-4029
Europe	UK, Germany, France and Spain: (Toll Free) +800-1532-4865 Other Countries: +44-1489-564-764
Asia	+63-2-438-0090
China	+86-21-5385-3786
Business hours: 9:00 AM to 5:00 PM	

Ricoh Company, Ltd.
Ricoh Building, 8-13-1, Ginza, Chuo-ku, Tokyo
104-8222, Japan
2010 February

En (USA) (GB) (GB) AE (AE)
Printed in China



* L 7 5 6 2 9 7 1 *