

# PENTAX



Digital Camera

# PENTAX Q

## Operating Manual

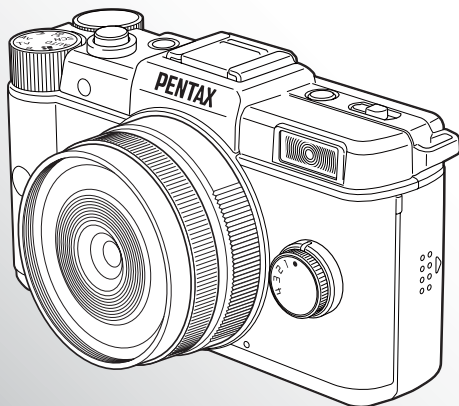

**SILKYPIX**<sup>®</sup>  
The Excellent digital development technology



**HDMI**<sup>™</sup>  
HIGH-DEFINITION MULTIMEDIA INTERFACE

To ensure the best performance from your camera, please read the Operating Manual before using the camera.

Thank you for purchasing this PENTAX Q Digital Camera. Please read this manual before using the camera in order to get the most out of all the features and functions. Keep this manual safe, as it can be a valuable tool in helping you to understand all the camera's capabilities.

### **Lenses you can use**

Lenses that can be used with this camera are Q-mount lenses.

### **Regarding copyrights**

Images taken with the PENTAX Q that are for anything other than personal enjoyment cannot be used without permission according to the rights as specified in the Copyright Act. Please take care, as there are cases where limitations are placed on taking pictures even for personal enjoyment during demonstrations, performances or of items on display. Images taken with the purpose of obtaining copyrights also cannot be used outside the scope of use of the copyright as laid out in the Copyright Act, and care should be taken here also.

### **Regarding trademarks**

PENTAX, PENTAX Q and smc PENTAX are trademarks of HOYA CORPORATION. Microsoft and Windows are registered trademarks of Microsoft Corporation in the United States and other countries. Windows Vista is either a registered trademark or trademark of Microsoft Corporation in the United States and/or other countries. Macintosh, Mac OS, and QuickTime are trademarks of Apple Inc., registered in the U.S. and other countries.

SDXC Logo is a trademark of SD-3C, LLC.

This product includes DNG technology under license by Adobe Systems Incorporated. The DNG logo is either registered trademarks or trademarks of Adobe Systems Incorporated in the United States and/or other countries.

HDMI, the HDMI logo and High-Definition Multimedia Interface are trademarks or registered trademarks of HDMI Licensing, LLC in the United States and/or other countries.

All other brands or product names are trademarks or registered trademarks of their respective companies. However, the TM or ® marks are not used in all cases in this manual.

This product supports PRINT Image Matching III. PRINT Image Matching enabled digital still cameras, printers and software help photographers to produce images more faithful to their intentions. Some functions are not available on printers that are not PRINT Image Matching III compliant.

Copyright 2001 Seiko Epson Corporation. All Rights Reserved. PRINT Image Matching is a trademark of Seiko Epson Corporation. The PRINT Image Matching logo is a trademark of Seiko Epson Corporation.

### To users of this camera

- Do not use or store this device in the vicinity of equipment that generates strong electromagnetic radiation or magnetic fields. Strong static charges or the magnetic fields produced by equipment such as radio transmitters could interfere with the monitor, damage the stored data, or affect the product's internal circuitry and cause camera misoperation.
- The liquid crystal panel used for the monitor is manufactured using extremely high precision technology. Although the level of functioning pixels is 99.99% or better, you should be aware that 0.01% or fewer of the pixels may not illuminate or may illuminate when they should not. However, this has no effect on the recorded image.
- There is a possibility that the illustrations and the display screen of the monitor in this manual are different from the actual ones.
- In this manual, the generic term "computer(s)" refers to either a Windows PC or a Macintosh hereafter.
- In this manual, the term "battery(ies)" refers to any type of batteries used for this camera and its accessories.

## For Using Your Camera Safely

We have paid close attention to the safety of this product. When using this product, we request your special attention regarding items marked with the following symbols.



### Warning

This symbol indicates that violating this item could cause serious personal injuries.



### Caution

This symbol indicates that violating this item could cause minor or medium personal injuries, or loss of property.

## About the Camera



### Warning

- Do not disassemble or modify the camera. High voltage areas are present inside the camera, with the risk of electric shock.
- If the camera interior is exposed due to dropping or otherwise damaging the camera, never touch the exposed portion. There is a risk of electric shock.
- Do not aim the camera at the sun or other intense sources of light when taking pictures or leave the camera sitting in direct sunlight with the lens cap off. Doing so may cause the camera to malfunction or cause a fire.
- Do not look through the lens while it is pointed at the sun. Doing so may lead to a loss of eyesight or cause vision to be impaired.
- If any irregularities occur during use, such as smoke or a strange odor, stop use immediately, remove the battery or the AC adapter, and contact your nearest PENTAX Service Center. Continuing to use the product can cause a fire or electrical shock.

- Do not place your finger over the flash when discharging the flash. You may burn yourself.
- Do not cover the flash with clothing when discharging the flash. Discoloration may occur.
- Some portions of the camera heat up during use. There is a risk of low temperature burns when holding such portions for long periods.
- Should the monitor be damaged, be careful of glass fragments. Also, be careful not to allow the liquid crystal to get on your skin or in your eyes or mouth.
- Depending on your individual factors or physical condition, the use of the camera may cause itching, rashes or blisters. In case of any abnormality, stop using the camera and get medical attention immediately.

---

## About the Battery Charger and AC Adapter



### Warning

- Always use the battery charger and AC adapter exclusively developed for this product, with the specified power and voltage. Using a battery charger or AC adapter not exclusive to this product, or using the exclusive battery charger or AC adapter with an unspecified power or voltage can cause a fire, electric shock, or camera breakdown. The specified voltage is 100 - 240V AC.
- Do not disassemble or modify the product. This can cause a fire or electrical shock.
- If the generation of smoke or strange odor from the product or other abnormality occurs, immediately discontinue using and consult a PENTAX Service Center. Continuing to use the product can cause a fire or electrical shock.
- If water should happen to get inside the product, consult a PENTAX Service Center. Continuing to use the product can cause a fire or electrical shock.
- If thunderstorm should be present during use of the battery charger and AC plug cord, unplug the power plug and discontinue use. Continuing to use the product can cause damage to the equipment, fire or electrical shock.
- Wipe off the power plug if it should become covered with dust. Accumulated dust may cause a fire.
- To reduce the risk of hazards, use only CSA/UL certified power supply cord set, cord is Type SPT-2 or heavier, minimum NO.18 AWG copper, one end with a molded-on male attachment plug cap (with a specified NEMA configuration), and the other is provided with a molded-on female connector body (with a specified IEC nonindustrial type configuration) or the equivalent.



### Caution

- Do not place or drop heavy objects on or forcefully bend the AC plug cord. Doing so may damage the cord. Should the AC plug cord be damaged, consult a PENTAX Service Center.
- Do not touch or short-circuit the terminal area of the AC plug cord while the cord is plugged in.
- Do not handle the power plug with wet hands. This can cause an electric shock.
- Do not drop the product, or subject it to violent impact. This can cause equipment breakdown.

- Do not use the battery charger to charge batteries other than the rechargeable lithium-ion battery D-LI68. Attempting to charge other types of batteries may cause an explosion or heating, or may damage the battery charger.

## About the Rechargeable Lithium-ion Battery

### **Warning**

- If any leakage from the battery should come in contact with your eyes, do not rub them. Flush your eyes with clean water and get medical attention immediately.

### **Caution**

- Only use the specified battery with this camera. Use of other batteries may cause an explosion or fire.
- Do not disassemble the battery. Disassembling the battery may cause an explosion or leakage.
- Remove the battery from the camera immediately if it becomes hot or begins to smoke. Be careful not to burn yourself during removal.
- Keep wires, hairpins, and other metal objects away from the + and - contacts of the battery.
- Do not short the battery or dispose of the battery in fire. This can cause an explosion or fire.
- If any leakage from the battery should come in contact with skin or clothes, it may cause irritation to the skin. Wash the affected areas thoroughly with water.
- Precautions for D-LI68 Battery Usage:  
USE SPECIFIED CHARGER ONLY.
  - DO NOT INCINERATE.
  - DO NOT DISASSEMBLE.
  - DO NOT SHORT CIRCUIT.
  - DO NOT EXPOSE TO HIGH TEMP. (140°F / 60°C)

## Keep the Camera and its Accessories out of the Reach of Small Children

### **Warning**

- Do not place the camera and its accessories within the reach of small children.
  1. If the product falls or is operated accidentally it may cause serious personal injuries.
  2. Wrapping the strap around a neck may cause suffocation.
  3. To avoid the risk of a small accessory such as the battery or SD Memory Cards from being swallowed by mistake, keep them out of the reach of small children. Seek medical attention immediately if an accessory is accidentally swallowed.

---

## Care to be Taken During Handling

---

### Before Using Your Camera

- When traveling, take the Worldwide Service Network listing that is included in the package. This will be useful if you experience problems abroad.
- When the camera has not been used for a long time, confirm that it is still working properly, particularly prior to taking important pictures (such as at a wedding or when traveling). Contents of the recording cannot be guaranteed if recording, playback or transferring your data to a computer, etc. is not possible due to a malfunction of your camera or recording media (SD Memory Card), etc.

---

### About the Battery and Charger

- Storing the battery fully charged may decrease the battery performance. Avoid storing in high temperatures.
- If the battery is left inserted and the camera is not used for a long time, the battery will over-discharge and shorten the battery's life.
- Charging the battery a day before use or on the day of use is recommended.
- The AC plug cord provided with this camera is developed exclusively for the battery charger D-BC68P. Do not use it with other devices.

---

### Precautions on Carrying and Using Your Camera

- Do not subject the camera to high temperatures or high humidity. Do not leave the camera in a vehicle, as the temperature can get very high.
- Do not subject the camera to strong vibrations, shocks, or pressure. Use a cushion to protect the camera from vibrations of motorcycles, automobiles, or ships.
- The temperature range for camera use is 0°C to 40°C (32°F to 104°F).
- The monitor may appear black at high temperatures, but will return to normal at normal temperatures.
- The monitor may respond more slowly at low temperatures. This is due to liquid crystal properties, and is not a malfunction.
- Sudden temperature changes will cause condensation on the inside and outside of the camera. Place the camera in your bag or a plastic bag, and remove the camera after temperature of the camera and surroundings are equalized.
- Avoid contact with garbage, mud, sand, dust, water, toxic gases, or salt. These could cause the camera to breakdown. Wipe the camera to dry off any rain or water drops.
- Please do not press forcefully on the monitor. This could cause it to break or malfunction.
- Be careful not to overtighten the screw in the tripod socket when using a tripod.

## Cleaning Your Camera

- Do not clean the product with organic solvents such as thinner, alcohol, or benzine.
- Use a lens brush to remove dust accumulated on the lens. Never use a spray blower for cleaning as it may damage the lens.
- Please contact a PENTAX Service Center for professional cleaning of the CMOS sensor. (This will involve a fee.)

## Storing Your Camera

- Do not store the camera with preservatives or chemicals. Storage in high temperatures and high humidity can cause mold to grow on the camera. Remove the camera from its case and store it in a dry and well-ventilated place.
- Avoid using or storing the camera where it may be exposed to static electricity or electrical interference.
- Avoid using or storing the camera in direct sunlight or in locations where it may be exposed to rapid changes in temperature or to condensation.
- Periodic inspections are recommended every one to two years to maintain high performance.

## Other Precautions

- The SD Memory Card is equipped with a write-protect switch. Setting the switch to LOCK prevents new data from being recorded on the card, the stored data from being deleted, and the card from being formatted by the camera or computer.
- The SD Memory Card may be hot when removing the card immediately after using the camera.
- Do not remove the SD Memory Card or turn off the power while the card is being accessed. This may cause the data to be lost or the card to be damaged.
- Do not bend the SD Memory Card or subject it to violent impact. Keep it away from water and store away from high temperatures.
- Do not remove the SD Memory Card while formatting. The card may be damaged and become unusable.
- Data on the SD Memory Card may be deleted in the following circumstances. We do not accept any liability for data that is deleted if
  1. the SD Memory Card is mishandled by the user.
  2. the SD Memory Card is exposed to static electricity or electrical interference.
  3. the SD Memory Card has not been used for a long time.
  4. the SD Memory Card or the battery is removed while the card is being accessed.
- If the SD Memory Card is not used for a long time, the data on the card may become unreadable. Be sure to regularly make a backup of important data on a computer.
- Format new SD Memory Cards. Also format SD Memory Cards used with other cameras.

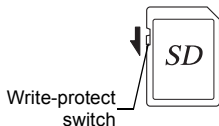

- Please note that deleting data stored on an SD Memory Card, or formatting an SD Memory Card does not completely erase the original data. Deleted files can sometimes be recovered using commercially available software. If you are going to discard, give away or sell your SD Memory Card, you should ensure that the data on the card is completely deleted or the card itself is destroyed if it contains any personal or sensitive information.
- The data on your SD Memory Card should be managed at your own risk.

**Regarding Product Registration**

In order to better serve you, we request that you complete the product registration, which can be found on the CD-ROM supplied with the camera or on the PENTAX website. Refer to p.209 for details. Thank you for your cooperation.



# Contents

For Using Your Camera Safely .....	1
Care to be Taken During Handling .....	4
Contents .....	7
Composition of the Operating Manual .....	13

## **Before Using Your Camera** **15**

---

### **Checking the Contents of the Package** .....16

### **Names and Functions of the Working Parts** .....17

Capture Mode .....	18
Playback Mode .....	20
Monitor Display .....	22

### **How to Change Function Settings** .....30

Using the Direct Keys .....	30
Using the Control Panel .....	31
Using the Menus .....	32

## **Getting Started** **35**

---

### **Attaching the Strap** .....36

### **Inserting the Battery** .....37

Charging the Battery .....	37
Inserting/Removing the Battery .....	38
Battery Level Indicator .....	39
Approximate Image Storage Capacity and Playback Time (when Using a Fully Charged Battery) .....	40
Using the AC Adapter (Optional) .....	40

### **Inserting/Removing an SD Memory Card** .....43

### **Attaching a Lens** .....45

### **Turning the Camera On and Off** .....47

### **Initial Settings** .....48

Setting the Display Language .....	48
Setting the Date and Time .....	50

## Basic Operations

53



---

<b>Basic Shooting Operation</b> .....	<b>54</b>
Letting the Camera Choose the Optimal Settings.....	54
<b>Using a Zoom Lens</b> .....	<b>56</b>
<b>Using the Built-in Flash</b> .....	<b>57</b>
Setting the Flash Mode .....	57
Shooting with the Flash.....	59
<b>Reviewing Images</b> .....	<b>61</b>
Playing Back Images .....	61
Deleting a Single Image.....	62

## Shooting Functions

63

---

<b>How to Operate the Shooting Functions</b> .....	<b>64</b>
Direct Keys Setting Items.....	64
Rec. Mode Menu Items .....	65
Movie Menu Items.....	67
Custom Setting Menu Items.....	68
<b>Selecting the Appropriate Capture Mode</b> .....	<b>69</b>
Auto Picture Modes.....	70
Scene Modes .....	71
Blur Control Mode .....	73
Exposure Modes .....	74
<b>Setting the Exposure</b> .....	<b>75</b>
Setting the Sensitivity.....	75
Changing the Exposure Mode .....	76
Adjusting the Exposure .....	79
Locking the Exposure Before Shooting (AE Lock).....	82
Selecting the Metering Method .....	84
Reducing Image Noise (Noise Reduction).....	85
<b>Focusing</b> .....	<b>86</b>
Setting the Focus Method .....	86
Setting the Autofocus Method .....	87
Focusing Using the  /  Button.....	90
Locking the Focus (Focus Lock).....	91
Adjusting the Focus Manually (Manual Focus).....	92

<b>Checking the Depth of Field (Preview)</b> .....	<b>94</b>
Assigning the Preview Function to the Green Button .....	94
Displaying the Preview .....	95
<b>Using the Shake Reduction Function to Prevent Camera Shake</b> .....	<b>96</b>
Taking Pictures Using the Shake Reduction Function .....	96
Shooting with Self-timer .....	98
Shooting with Remote Control (Optional) .....	100
<b>Taking Pictures Continuously</b> .....	<b>102</b>
Continuous Shooting .....	102
Interval Shooting .....	104
Multi-exposure .....	107
<b>Recording Movies</b> .....	<b>109</b>
Changing the Settings for Movie Recording .....	109
Recording Movies .....	111
Playing Back Movies .....	115
Editing Movies .....	117

## **Shooting Settings** **119**

---

<b>Setting a File Format</b> .....	<b>120</b>
File Format .....	121
Aspect Ratio .....	121
JPEG Recorded Pixels .....	122
JPEG Quality .....	123
Color Space .....	123
<b>Setting the White Balance</b> .....	<b>124</b>
Adjusting the White Balance Manually .....	125
Fine-tuning the White Balance .....	127
<b>Adjusting Brightness</b> .....	<b>128</b>
Highlight Correction .....	128
Shadow Correction .....	129
HDR Capture .....	130
<b>Setting the Image Finishing Tone</b> .....	<b>131</b>
Setting Custom Image .....	131
Setting the Digital Filter .....	135
Saving Frequently Used Functions to the Quick Dial .....	138
Setting the Smart Effect .....	140
Saving the Camera Settings .....	142

<b>Setting the Green Button and E-dial Functions.....</b>	<b>144</b>
Setting the Green Button Operation.....	144
Setting the E-dial Operation in <b>P</b> Mode .....	146
Setting the Green Button Operation in <b>M</b> Mode .....	147
<b>Setting the Lens Functions .....</b>	<b>148</b>
Setting the ND Filter.....	148
Correcting Lens Distortion .....	149

## **Playback Functions 151**

---

<b>Playback Functions Operation.....</b>	<b>152</b>
Playback Mode Palette Items .....	152
Playback Menu Items.....	153
<b>Setting the Playback Display Method.....</b>	<b>154</b>
<b>Enlarging Images.....</b>	<b>155</b>
<b>Displaying Multiple Images .....</b>	<b>156</b>
Multi-image Display Screen .....	156
Displaying Images by Folder.....	157
Displaying Images by Shooting Date (Calendar Display) .....	158
Comparing Images.....	159
Joining Multiple Images (Index) .....	160
<b>Playing Back Images Continuously.....</b>	<b>162</b>
Setting the Slideshow Display.....	162
Starting the Slideshow .....	163
<b>Displaying Rotated Images.....</b>	<b>164</b>
<b>Deleting Multiple Images .....</b>	<b>165</b>
Deleting Selected Images .....	165
Deleting a Folder.....	166
Deleting All Images .....	167
<b>Connecting the Camera to an AV Device .....</b>	<b>168</b>
Connecting the Camera to a Video Input Terminal or HDMI Input Terminal .....	168
Setting the Video/HDMI Output Format .....	169

## Editing Images 171

---

<b>Changing the Image Size</b> .....	<b>172</b>
Changing the Number of Recorded Pixels (Resize) .....	172
Cropping Out Part of the Image (Cropping) .....	173
<b>Processing Images</b> .....	<b>174</b>
Processing Images with Digital Filters .....	174
Editing Out the Unwanted Red-eye Effect .....	179
<b>Developing RAW Images</b> .....	<b>180</b>
Developing One RAW Image .....	180
Developing Multiple RAW Images .....	182

## Changing Additional Settings 183

---

<b>How to Operate the Set-up Menu</b> .....	<b>184</b>
Set-up Menu Items .....	184
<b>Camera Settings</b> .....	<b>186</b>
Setting the Sound Effects, Date and Time, and Display Language .....	186
Setting the Monitor and the Menu Display .....	190
Selecting Settings to Save in the Camera (Memory) .....	195
Resetting the Menus .....	196
Checking the Camera Version Information .....	197
<b>File Management Settings</b> .....	<b>198</b>
Formatting an SD Memory Card .....	198
Protecting Images from Deletion (Protect) .....	199
Changing the Naming System for Folders .....	200
Selecting the File Number Setting .....	200
Creating New Folders .....	201
Setting the DPOF Settings .....	201

## Connecting to a Computer 203

---

<b>Manipulating Captured Images on a Computer</b> .....	<b>204</b>
<b>Saving Images on a Computer</b> .....	<b>205</b>
Setting the USB Connection Mode .....	205
Connecting the Camera and a Computer .....	206
<b>Using the Provided Software</b> .....	<b>207</b>
Installing the Software .....	207
Screen of the SILKYPIX Developer Studio .....	208

## Using the Flash 211

---

<b>Using the Built-in Flash</b> .....	<b>212</b>
Flash Characteristics in Each Exposure Mode .....	212
Using the Slow-speed Sync .....	212
Using the Trailing Curtain Sync .....	213
Distance and Aperture when Using the Built-in Flash .....	213
Lens Compatibility with the Built-in Flash .....	214
<b>Using an External Flash (Optional)</b> .....	<b>215</b>
Using P-TTL Mode .....	216
Connecting an External Flash with an Extension Cord .....	217

## Appendix 219

---

<b>Default Settings</b> .....	<b>220</b>
<b>Functions Available with Various Lens Combinations</b> .....	<b>226</b>
<b>Cleaning the CMOS Sensor</b> .....	<b>227</b>
Removing Dust by Shaking the CMOS Sensor (Dust Removal) .....	227
<b>Optional Accessories</b> .....	<b>228</b>
<b>Error Messages</b> .....	<b>232</b>
<b>Troubleshooting</b> .....	<b>234</b>
<b>Main Specifications</b> .....	<b>237</b>
<b>Index</b> .....	<b>243</b>
<b>WARRANTY POLICY</b> .....	<b>249</b>

# Composition of the Operating Manual

This Operating Manual contains the following chapters.

## 1 Before Using Your Camera

Explains the provided accessories and the names and functions of various parts.

## 2 Getting Started

Explains your first steps from purchasing the camera to taking pictures. Be sure to read this chapter and follow the instructions.

## 3 Basic Operations

Explains the procedures for taking and playing back pictures.

## 4 Shooting Functions

Explains the shooting-related functions.

## 5 Shooting Settings

Explains the procedures for changing the shooting settings, such as the file format.

## 6 Playback Functions

Explains the procedures for playing back and deleting images.

## 7 Editing Images

Explains the procedures for processing images and developing images taken in RAW format.

## 8 Changing Additional Settings

Explains the general camera settings and file management settings such as the monitor display settings and the image folder naming system.

## 9 Connecting to a Computer

Explains how to connect the camera to a computer, and includes installation instructions and a general overview of the provided software.

## 10 Using the Flash

Explains how to use the built-in flash and external flashes.

## 11 Appendix

Explains troubleshooting, introduces optional accessories and provides various resources.

1

2

3

4

5

6

7



8

9

10

11

The symbols used in this Operating Manual are explained below.

	Indicates reference page number explaining a related operation.
	Indicates useful information.
	Indicates precautions to take when operating the camera.



# 1 Before Using Your Camera

---

Check the package contents and the names and functions of working parts before use.

<b>Checking the Contents of the Package .....</b>	<b>16</b>
<b>Names and Functions of the Working Parts .....</b>	<b>17</b>
<b>How to Change Function Settings .....</b>	<b>30</b>

# Checking the Contents of the Package

The following accessories are packaged with your camera.  
Check that all accessories are included.

1

Before Using Your Camera



Hot shoe cover Fk  
(Installed on camera)



Body mount cover  
(Installed on camera)

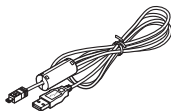

USB cable  
I-USB7

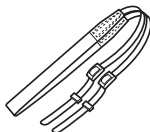

Strap  
O-ST115

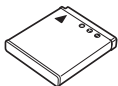

Rechargeable lithium-ion  
battery D-LI68



Battery charger  
D-BC68P



AC plug cord



Software (CD-ROM)  
S-SW115

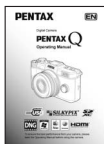

Operating Manual  
(this manual)



Quick Guide



Refer to p.228 for information on optional accessories.

# Names and Functions of the Working Parts

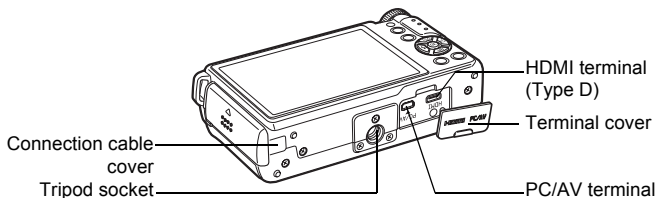
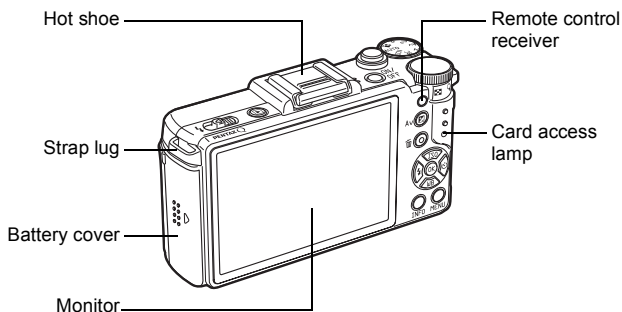
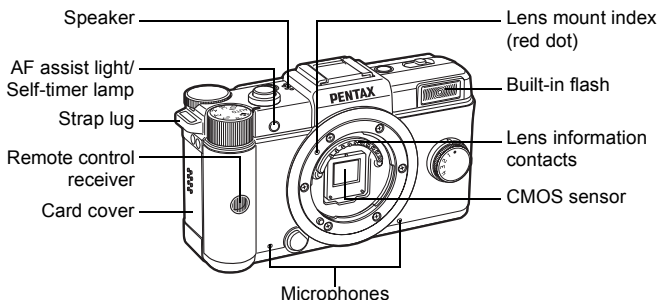

## Capture Mode

Here, you can learn which parts and how they work when shooting.





1

Before Using Your Camera

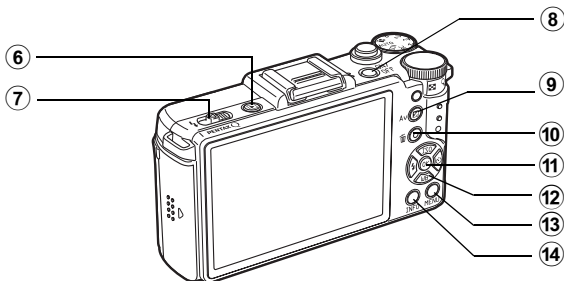
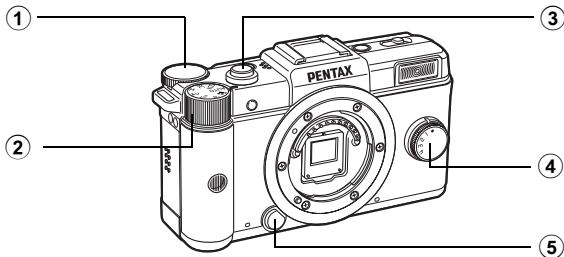

The factory default setting of each part is explained here, but some parts have multiple functions and work differently depending on the selected setting.



- ① **E-dial**  
Sets the shutter speed, aperture, and EV compensation values. (p.77)  
You can change the menu when a menu screen is displayed. (p.32)  
You can change the settings when the control panel is displayed. (p.32)
- ② **Mode dial**  
Changes Capture mode. (p.69)
- ③ **Shutter release button**  
Press to capture images. (p.55)
- ④ **Quick dial**  
You can save your preferred shooting settings and then retrieve them easily later on. (p.138)
- ⑤ **Lens unlock button**  
Press to detach a lens. (p.46)
- ⑥ ** button**  
Switches to Playback mode. (p.61)
- ⑦ **Flash pop-up switch**  
Slide to pop up the built-in flash. (p.59)
- ⑧ **Power switch**  
Press to turn the camera on and off. (p.47)
- ⑨ ** Av button**  
Press to set the EV compensation and aperture values. (p.77, p.79)
- ⑩ ** (Green/Delete) button**  
You can assign a function to this button. (p.144)
- ⑪ **OK button**  
When the control panel or a menu screen is displayed, press this button to confirm the selected item.
- ⑫ **Four-way controller (▲▼◀▶)**  
Displays the Sensitivity/White Balance/Flash Mode/Drive Mode setup menu. (p.64)  
When the control panel or a menu screen is displayed, use this to move the cursor or change items.
- ⑬ **MENU button**  
Displays the [ Rec. Mode 1] menu (p.65). Press this button while the menu is displayed to return to the previous screen. (p.32)
- ⑭ **INFO button**  
Changes the style of the display on the monitor. (p.22)

## Playback Mode

Here, you can learn which parts and how they work during playback.

1

Before Using Your Camera

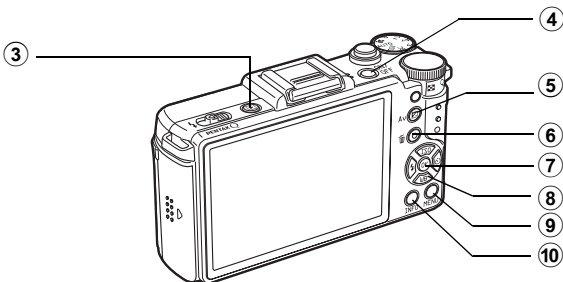
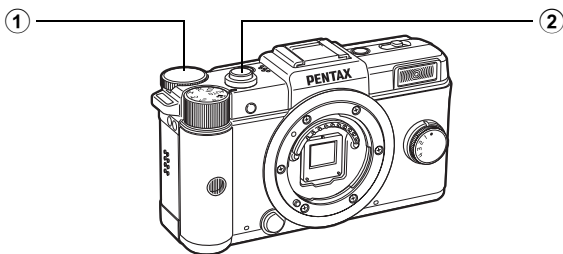

- ① **E-dial**  
Use this to enlarge an image (p.155) or display multiple images at the same time (p.156).
- ② **Shutter release button**  
Press halfway to switch to Capture mode.
- ③ **[▶] button**  
Switches to Capture mode.
- ④ **Power switch**  
Press to turn the camera on and off. (p.47)
- ⑤ **[Av] button**  
When the file format of the last captured image is JPEG, and its data still remains in the buffer memory, press this button to save the image in RAW format. (p.61)
- ⑥ **[●/🗑️] (Green/Delete) button**  
Press to delete images, or change the settings, such as resetting the values. (p.62, p.144)
- ⑦ **OK button**  
Confirms the setting you selected in the menu or playback screen.
- ⑧ **Four-way controller (▲▼◀▶)**  
Use this to move the cursor or change items in the menu or playback screen. Press the four-way controller (▼) to display the playback mode palette. (p.152)
- ⑨ **MENU button**  
Displays the [▶ Playback 1] menu (p.153).
- ⑩ **INFO button**  
Changes the style of the display on the monitor. (p.25)

## References to Button Names

In this Operating Manual, the buttons of the four-way controller are referred to in the following way.

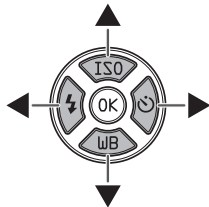

## Monitor Display

Various information appears on the monitor depending on the status of the camera.



The brightness level and the color of the monitor can be adjusted. (p.193)

### Capture Mode

While shooting, the current shooting function settings are displayed on the monitor. You can change the style of the display by pressing the **INFO** button.

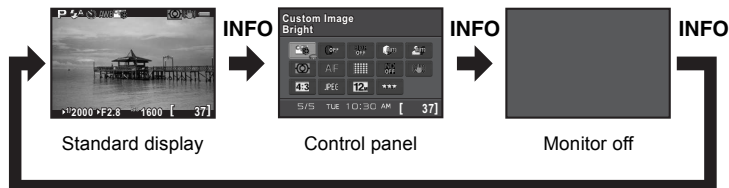

#### ● Standard display

(All items are displayed here for explanatory purposes. The actual display may differ.)

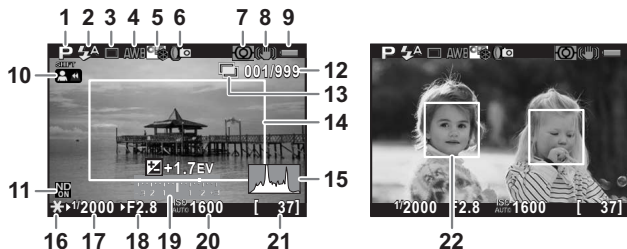

- 1 Capture Mode (p.69)
- 2 Flash Mode (p.57)
- 3 Drive Mode (p.64)
- 4 White Balance (p.124)

- 5 Custom Image (p.131)
- 6 Interval Shooting (p.104)/  
HDR Capture (p.130)/  
Digital Filter (p.135)



- |    |   |    |  |
|----|---|----|--|
| 7  | AE Metering (p.84)                                    | 15 | Histogram (p.28)   |
| 8  | Shake Reduction (p.96)/<br>Movie SR (p.110)           | 16 | AE Lock (p.82)   |
| 9  | Battery level (p.39)                                  | 17 | Shutter speed (p.77)   |
| 10 | Turning the focusing ring in<br><b>MF</b> mode (p.93) | 18 | Aperture value (p.77)  |
| 11 | ND Filter (p.148)                                     | 19 | EV bar (p.79)  |
| 12 | Number of shots using<br>Multi-exposure               | 20 | Sensitivity (p.75)   |
| 13 | Multi-exposure (p.107)                                | 21 | Image storage capacity   |
| 14 | AF frame (p.55)                                       | 22 | Face detection frame (when<br>[Autofocus Method] is set to<br>[Face Detection]) (p.87) |
- \* Indicator 14 is displayed in white. When the subject is in focus, a green square frame is displayed instead. It turns red when the subject is not in focus. It is not displayed when [Focus Method] is set to **MF**.
- \* For indicator 22, up to 12 face detection frames are displayed when [Autofocus Method] is set to [Face Detection]. A main face detection frame is displayed in yellow and other frames in white.

## ● Control panel

Press the **INFO** button in Capture mode to display the control panel and change settings.

### 📷 mode

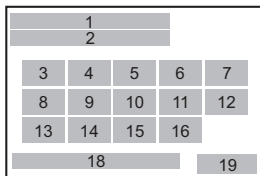

### 📷 mode

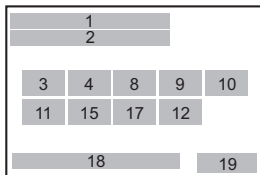
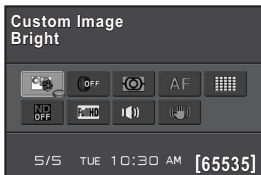

- |    |   |    |  |
|----|---|----|--|
| 1  | Function name                                   | 11 | ND Filter (p.148)  |
| 2  | Setting   | 12 | Shake Reduction (p.96)/<br>Movie SR (p.110)                    |
| 3  | Custom Image (p.131)/<br><b>SCN</b> mode (p.71) | 13 | Aspect Ratio (p.121)   |
| 4  | Digital Filter (p.135)                          | 14 | File Format (p.121)  |
| 5  | HDR Capture (p.130)                             | 15 | JPEG Recorded Pixels (p.122)/<br>Movie Recorded Pixels (p.109) |
| 6  | Highlight Correction (p.128)                    | 16 | JPEG Quality (p.123)   |
| 7  | Shadow Correction (p.129)                       | 17 | Sound (p.109)  |
| 8  | AE Metering (p.84)                              | 18 | Current date and time (p.50)                                   |
| 9  | Focus Method (p.86)                             | 19 | Image storage capacity   |
| 10 | Autofocus Method (p.87)                         |    |  |



- Settings that cannot be changed due to the current camera setup cannot be selected.
- If no operations are made within 30 seconds in the control panel, the standard display will reappear.
- The control panel for the **SCN** (Scene) mode is displayed when the mode dial is set to **SCN**. (p.72)
- For more information about the Capture mode display, refer to "Setting the Capture Mode Display Method" (p.191).

## Playback Mode

The camera switches the type of information displayed when you press the **INFO** button during playback.

Standard display	Captured image, file format and operation guide indicators are displayed.
Histogram display	Captured image and histogram (Brightness/RGB) are displayed. Not available during movie playback. (p.26)
Detailed information display	Detailed information on how and when the image was taken is displayed. (p.27)
No info. display	Only the captured image is displayed.

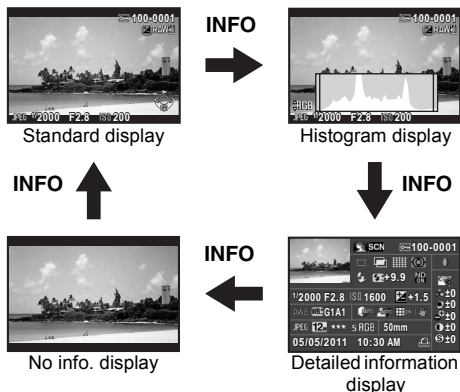

The type of information display that is shown first during playback is the same as that of the last playback in the previous session. If [Playback Info Display] is set to  (Off) in [Memory] (p.195) of the [Rec. Mode 3] menu, the Standard display always appears first when the camera is turned on.

## ● Histogram display

The following histograms can be displayed when playing back still pictures. The “Brightness histogram” shows the distribution of brightness and the “RGB histogram” shows the distribution of color intensity. Press the four-way controller (▲▼) to switch between “Brightness histogram” and “RGB histogram”.

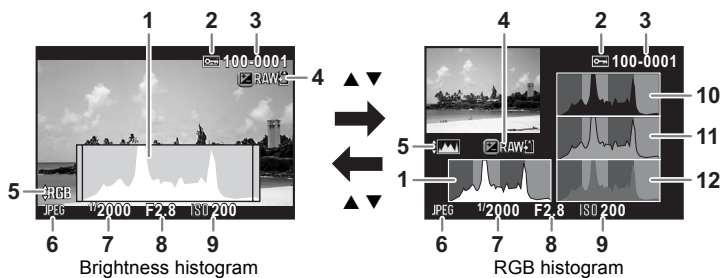

- |   |                  |
|---|------------------|
| 1 Histogram (Brightness)                        | 7 Shutter speed  |
| 2 Protect setting                               | 8 Aperture value |
| 3 Folder number-File number                     | 9 Sensitivity    |
| 4 Save the RAW file data                        | 10 Histogram (R) |
| 5 Switch RGB histogram/<br>Brightness histogram | 11 Histogram (G) |
| 6 File Format                                   | 12 Histogram (B) |

\* Indicator 2 appears only for protected images.

\* Indicator 4 appears only when the file format of the last captured image is JPEG, and the image can also be saved in RAW format. (p.61)



If [Bright/Dark Area] (p.154) of the [▶ Playback 1] menu is set to  (On), bright (overexposed) portions blink red and dark (underexposed) portions blink yellow (except when in RGB histogram display or Detailed information display).

## ● Detailed information display

### Still picture

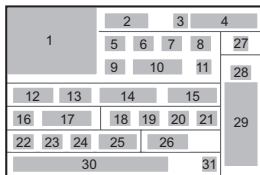

### Movie

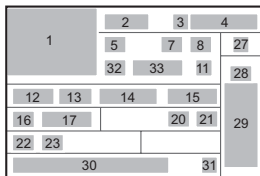

- |   |  |
|---|--|
| <ol style="list-style-type: none"> <li>1 Captured image</li> <li>2 Capture Mode (p.69)</li> <li>3 Protect setting (p.199)</li> <li>4 Folder number-File number (p.200)</li> <li>5 Drive Mode (p.64)</li> <li>6 HDR Capture (p.130)/ Multi-exposure (p.107)</li> <li>7 Autofocus Method (p.87)</li> <li>8 AE Metering (p.84)</li> <li>9 Flash Mode (p.57)</li> <li>10 Flash Exposure Compensation (p.58)</li> <li>11 ND Filter (p.148)</li> <li>12 Shutter speed (p.77)</li> <li>13 Aperture value (p.77)</li> <li>14 Sensitivity (p.75)</li> <li>15 EV Compensation (p.79)</li> <li>16 White Balance (p.124)</li> </ol> | <ol style="list-style-type: none"> <li>17 White Balance fine-tuning (p.127)</li> <li>18 Highlight Correction (p.128)</li> <li>19 Shadow Correction (p.129)</li> <li>20 Distortion Correction (p.149)</li> <li>21 Shake Reduction (p.96)/ Movie SR (p.110)</li> <li>22 File Format (p.121)</li> <li>23 JPEG Recorded Pixels (p.122)/ Movie Recorded Pixels (p.109)</li> <li>24 JPEG Quality (p.123)</li> <li>25 Color Space (p.123)</li> <li>26 Lens focal length</li> <li>27 Digital Filter (p.135)</li> <li>28 Image finishing tone (p.131)</li> <li>29 Custom Image parameters (p.132)</li> <li>30 Shooting date and time</li> <li>31 DPOF setting (p.201)</li> <li>32 Sound (p.109)</li> <li>33 Recording time</li> </ol> |
|---|--|

\* Indicators 9 and 10 appear only for images taken with the flash.

\* Indicators 6, 11, 17, 18, 19, 20, 26, 27, and 31 appear only for images taken with the corresponding functions enabled.

\* Indicators 23 and 24 do not appear for RAW images.

## Using the Histogram

A histogram shows the brightness distribution of an image.

The horizontal axis represents brightness (dark at the left and bright at the right) and the vertical axis represents the number of pixels.

The shape and the distribution of the histogram before and after shooting tells you whether the exposure level and contrast are correct or not, and lets you decide if you need to adjust the exposure and take a picture again.

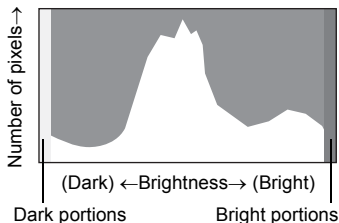

☞ Adjusting the Exposure (p.79)

☞ Adjusting Brightness (p.128)

## Understanding Brightness

When the brightness is correct and there are no overexposed or underexposed areas, the graph peaks in the middle. If the image is underexposed, the peak is on the left side, and if it is overexposed, the peak is on the right side.



Dark (underexposed)  
image



Image with few bright or  
dark areas



Bright (overexposed)  
image

When the image is underexposed, the part to the left is cut off (dark (underexposed) portions with no detail) and when the image is overexposed, the part to the right is cut off (bright (overexposed) portions with no detail).

This camera can be set so that it displays the Bright/Dark Area warning during Capture or Playback mode.

☞ Playing Back Images (p.61)

☞ Setting the Playback Display Method (p.154)

☞ Setting the Capture Mode Display Method (p.191)

☞ Setting the Display for Instant Review (p.192)

## Understanding Color Balance











Distribution of color intensity is displayed for each color in the RGB histogram. The right side of the graphs look similar for images that have the white balance adjusted well. If only one color is lopsided to the left, that color is too intense.

☞ Setting the White Balance (p.124)

## Guide Indicators

The following indicators appear on the monitor to indicate the keys, buttons and e-dial that can be operated at that time.

Example)

	Four-way controller (▲)		Shutter release button
	Four-way controller (▼)		<b>MENU</b> button
	Four-way controller (◀)		<b>INFO</b> button
	Four-way controller (▶)		Green/Delete button
	<b>OK</b> button		<b>Av</b> button
	E-dial		



- The image on the monitor may differ from the captured image if the brightness of the subject is low or high.
- If any changes occur in the light source during shooting, the image may flicker. You can cut down on flicker by setting the power frequency in [Flicker Reduction] (p.184) of the [Set-up 1] menu to that used in your region.
- If the camera position is changed rapidly during shooting, the image may not be displayed with the appropriate brightness. Wait for the display to become stable before shooting.
- Noise may appear on the monitor image when used in dark locations.
- If you continue shooting for a prolonged period, the internal temperature of the camera may increase, resulting in lower quality images. It is recommended that you turn off the camera when not shooting. To prevent the image quality from degrading, allow enough time for the camera to cool down while shooting with long exposures or recording movies.
- The higher the sensitivity, the more noise and color unevenness may occur in the monitor image and/or captured image.
- Images cannot be displayed on the monitor while data is being saved to an SD Memory Card.

Function settings can be changed using the direct keys, control panel or menus.

This section explains the basic ways to change function settings.

1

Before Using Your Camera

## Using the Direct Keys

In Capture mode, you can set Sensitivity, White Balance, Flash Mode and Drive Mode by pressing the four-way controller (▲▼◀▶). (p.64)  
Below, how to set [Flash Mode] is explained as an example.

### 1 Press the four-way controller (◀) in Capture mode.

The Flash Mode setting screen appears.

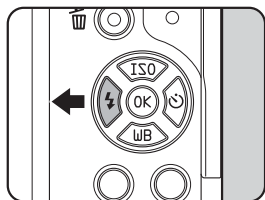

### 2 Use the four-way controller (◀▶) to select a flash mode.



### 3 Press the OK button.

The camera is ready to take a picture.

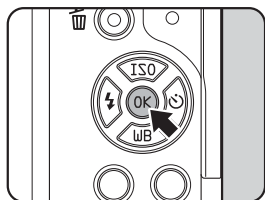



## Using the Control Panel

While shooting, the current settings can be checked on the monitor, and you can switch to the control panel and change settings. Below, how to set [JPEG Quality] is explained as an example.

1

Before Using Your Camera

### 1 Press the INFO button in Capture mode.

The control panel appears.

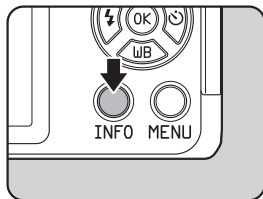

### 2 Use the four-way controller (▲▼◀▶) to select an item you want to change the setting for.

You cannot select items that cannot be changed as a result of current camera settings.

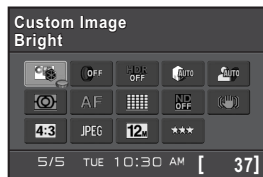

### 3 Press the OK button.

The setup screen of the selected item appears.



### 4 Use the four-way controller (◀▶) or e-dial to select a setting value.

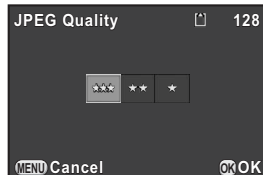

## 5 Press the OK button.

The camera returns to the control panel and is ready to take a picture.



You can also change the setting by turning the e-dial after selecting the item you want to change in Step 2. Detailed settings such as parameters can be changed after pressing the **OK** button.

## Using the Menus

This section explains how to use the following menus: [📷 Rec. Mode], [🎞️ Movie], [▶ Playback], [⚙️ Set-up] and [C Custom Setting]. Below, how to set [High-ISO NR] in the [📷 Rec. Mode 2] menu is explained as an example.

### 1 Press the MENU button in Capture mode.

The [📷 Rec. Mode 1] menu appears on the monitor.

The menus listed below are displayed in the following situations.

When the mode dial is set to 📷	[🎞️ Movie 1] menu
In Playback mode	[▶ Playback 1] menu

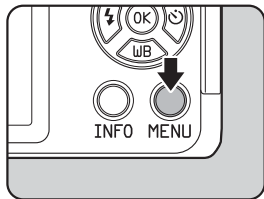

### 2 Press the four-way controller (▶).

Each time the four-way controller (▶) is pressed, the menu will change in the following sequence: [📷 Rec. Mode 2], [📷 Rec. Mode 3], [🎞️ Movie 1], [▶ Playback 1] ... [📷 Rec. Mode 1].

You can also change the menu by turning the e-dial.

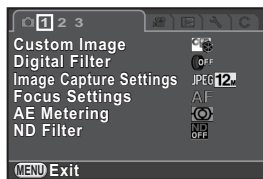

- 3** Use the four-way controller ( $\blacktriangle \blacktriangledown$ ) to select an item.

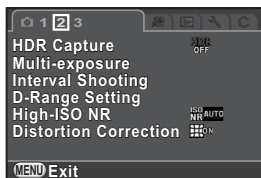

- 4** Press the four-way controller ( $\blacktriangleright$ ).

Available settings are displayed in the pop-up menu or submenu.

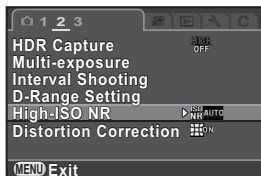

- 5** Use the four-way controller ( $\blacktriangle \blacktriangledown$ ) to select a setting.

Press the **MENU** button to cancel the pop-up menu, or return to the previous screen.

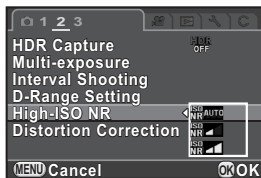

- 6** Press the OK button.

The setting is saved.

Press the **MENU** button if a submenu is displayed.

Next, set other items.

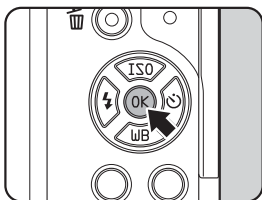

- 7** Press the MENU button.

The screen that was displayed before selecting the menu appears again.

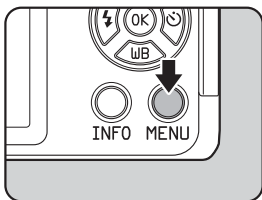



Even after you press the **MENU** button and close the menu screen, your settings will not be saved if the camera is turned off improperly (such as by removing the battery while the camera is on).



- You can select whether to display the menu tab selected the last time first, or to always display the [📷 Rec. Mode 1] menu first. (p.192)
- Refer to the following pages for details on each menu.
  - [📷 Rec. Mode] menu p.65
  - [🎬 Movie] Menu p.67
  - [▶ Playback] menu p.153
  - [⚙️ Set-up] menu p.184
  - [C Custom Setting] menu p.68
- Some shooting functions can be saved to the quick dial and loaded with the dial operation. (p.138)

# 2 Getting Started

---

This chapter explains your first steps from purchasing the camera to taking pictures. Be sure to read this and follow the instructions.

<b>Attaching the Strap .....</b>	<b>36</b>
<b>Inserting the Battery .....</b>	<b>37</b>
<b>Inserting/Removing an SD Memory Card .....</b>	<b>43</b>
<b>Attaching a Lens .....</b>	<b>45</b>
<b>Turning the Camera On and Off .....</b>	<b>47</b>
<b>Initial Settings .....</b>	<b>48</b>

## Attaching the Strap

- 1** Pass the end of the strap through the strap lug, then secure it on the inside of the clasp.

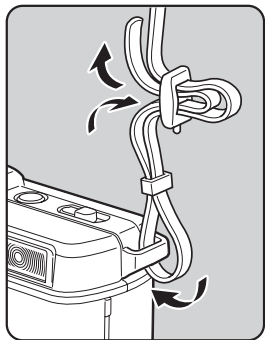

- 2** Attach the other end of the strap in the same manner as described above.

Insert the battery into the camera. Use the rechargeable lithium-ion battery D-LI68 exclusively developed for the PENTAX Q.

## Charging the Battery

When using the battery for the first time, or when the battery has not been used in a long time, or when [Battery depleted] appears, recharge the battery.

**Note:** AC plug cord “Listed, Type SPT-2 or NISPT-2, 18/2 flexible cord, rated 125 V, 7A, minimum 6ft (1.8m)”

- 1 Connect the AC plug cord to the battery charger.
- 2 Plug the AC plug cord into the power outlet.

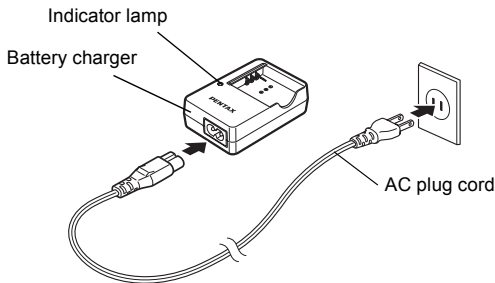

- 3 Face the ▲ mark on the battery up, and insert it into the battery charger.

The indicator lamp is lit while charging and turns off when the battery is fully charged.

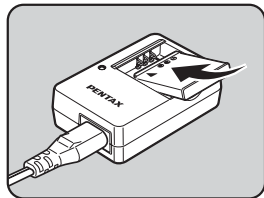

## 4 When the battery is fully charged, remove the battery from the battery charger.



- Do not use the provided Battery Charger D-BC68P to charge batteries other than rechargeable lithium-ion battery D-LI68. Charging other batteries may cause damage or heating.
- Replace the battery with a new one in the following cases:
  - If the indicator lamp blinks or does not light after the battery is inserted correctly
  - If the battery starts to run down more quickly even after being charged (the battery may have reached the end of its service life)



The maximum charging time is approximately 115 minutes (it depends on temperature and remaining battery power). Charge in a location where the temperature is between 0°C and 40°C.

## Inserting/Removing the Battery



- Insert the battery correctly. If the battery is inserted incorrectly, it may not be removed. Wipe the electrodes of the battery with a soft dry cloth before inserting.
- Do not open the battery cover or remove the battery while the power is on.
- Be careful as the camera or battery may become hot when the camera is used continuously for a long period of time.
- Remove the battery when you will not use the camera for a long while. The battery may leak.
- The date and time may be reset if you leave the battery out of the camera for long periods of time. If this occurs, follow the procedure described in “Setting the Date and Time” (p.50) to reset the date and time.

- ### 1 Slide the battery cover in the direction of the arrow, and then lift it to open (①→②).

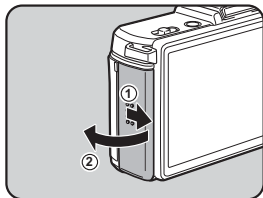



## 2 Insert the battery with the ▲ mark facing toward the lens.

To remove the battery, push the battery lock lever in the direction of the arrow (3) with your finger. Remove the battery when it pops out slightly.

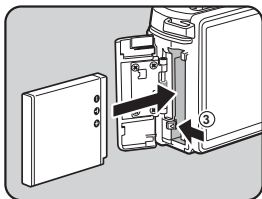

## 3 Close the battery cover, and then slide it in the direction of the arrow (4)→(5).

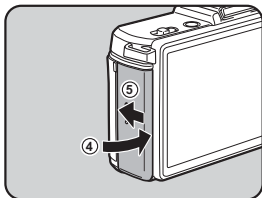

## Battery Level Indicator

You can confirm remaining battery level by checking the display on the monitor.

Monitor Display	Battery Level
(Green)	Battery is full.
(Green)	Battery is close to full.
(Yellow)	Battery is running low.
(Red)	Battery is almost empty.
[Battery depleted]	The camera turns off after displaying the message.



or (Red) may appear even when the battery level is sufficient if the camera is used at low temperatures or when performing continuous shooting for a long period of time. In this situation, turn the camera off and on again. If (Green) appears, you can use the camera.

## Approximate Image Storage Capacity and Playback Time (when Using a Fully Charged Battery)

Battery	Temperature	Normal Shooting	Flash Photography		Playback Time
			50% Use	100% Use	
D-LI68	23°C	250 images	230 images	210 images	160 minutes

The image storage capacity (normal recording and flash use 50%) is based on measuring conditions in accordance with CIPA standards, while other data is based on our measuring conditions. Some deviation from the above figures may occur in actual use depending on shooting mode and shooting conditions.



- Battery performance temporarily decreases as the temperature decreases. When using the camera in cold climates, have extra batteries at hand and keep them warm in your pocket. Battery performance will return to normal when returned to room temperature.
- Have extra batteries ready when traveling overseas, taking pictures in cold climates, or taking a lot of pictures.

## Using the AC Adapter (Optional)

We recommend the use of the AC adapter kit K-AC115 (optional) when using the monitor for a long time or when connecting the camera to a computer or AV device.

---

**1 Make sure that the camera is turned off.**

---

**2 Open the battery cover.**

Refer to Step 1 on p.38.

Remove the battery if it is inserted in the camera.

- 3** Pull down the connection cable cover (①) on the bottom side of the battery chamber, and insert the DC coupler into the battery chamber.

To remove the DC coupler, push the battery lock lever in the direction of the arrow (②) with your finger. Remove the DC coupler when it pops out slightly.

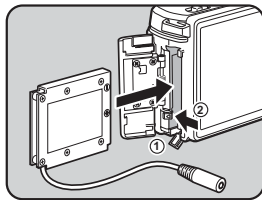

- 4** Close the battery cover.

Pull out the connection cable from the connection cable cover section.

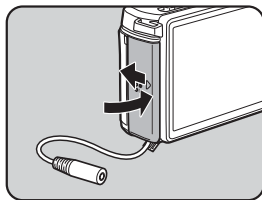

- 5** Connect the DC coupler and the AC adapter.

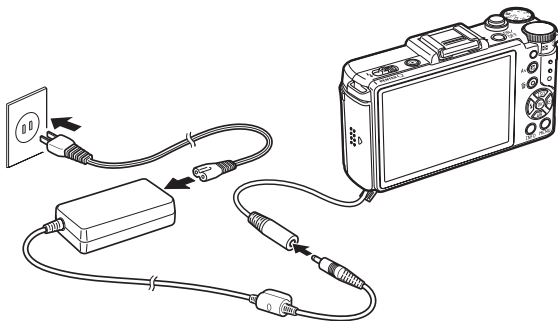

- 6** Connect the AC adapter to the AC plug cord.

## 7 Plug the AC plug cord into the power outlet.



- Make sure the camera is turned off before connecting or disconnecting the AC adapter.
- Make sure connections are secure between the terminals. SD Memory Card or data may be corrupted if disconnected while the card is being accessed.
- The connection cable will protrude from the battery cover while the AC adapter is in use. Be careful as you will not be able to set the camera upright on a table, etc.
- After removing the DC coupler, return the connection cable cover to its original location.



Be sure to read the manual of the AC adapter kit K-AC115 when using the AC adapter.

# Inserting/Removing an SD Memory Card

This camera uses a commercially available SD Memory Card, SDHC Memory Card, or SDXC Memory Card. (These cards are referred to as SD Memory Cards hereafter.)

Make sure the camera is turned off before inserting or removing the SD Memory Card.



- Do not remove the SD Memory Card while the card access lamp is lit.
- If the card cover is opened while the power is on, the camera will turn off. Do not open the cover while the camera is in use.
- Use this camera to format (initialize) an SD Memory Card that is unused or has been used on other devices. Refer to "Formatting an SD Memory Card" (p.198) for details on formatting.
- Use a high-speed memory card when recording movies. If a write speed cannot keep up with a recording speed, the writing may stop during recording.

**1** Make sure that the camera is turned off.

**2** Slide the card cover in the direction of the arrow, and then lift it to open (①→②).

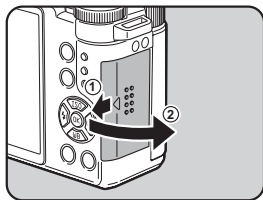

**3** Insert the card all the way with the SD Memory Card label facing toward the monitor.

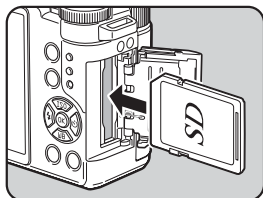

Push the SD Memory Card in once to remove.

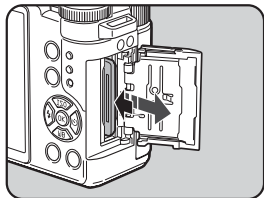

- 4** Close the card cover, and then slide it in the direction of the arrow (3 → 4).

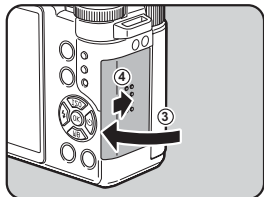

For details on the approximate number of images that can be recorded on an SD Memory Card, refer to "Approximate Image Storage Capacity" (p.242).

Attach a Q-mount lens to the camera's body.

The steps will be described here using a 01 STANDARD PRIME lens.



- When attaching/removing the lens, choose an environment that is relatively free of dirt and dust.
- Keep the body mount cover on the camera when a lens is not attached.
- Be sure to attach the lens mount cover and lens cap to the lens after removing it.
- Do not insert any fingers into the camera mount or touch the CMOS sensor.
- The camera body and lens mount incorporate lens information contacts. Dirt, dust, or corrosion may damage the electrical system. Please contact a PENTAX Service Center for professional cleaning.
- We assume no responsibility nor liability for accidents, damages and malfunctions resulting from the use of lenses made by other manufacturers.

## 1 Make sure that the camera is turned off.

## 2 Remove the body mount cover (①) and lens mount cover (②).

Be sure to put the lens down with the lens mount side facing upward to protect the lens mount from damage.

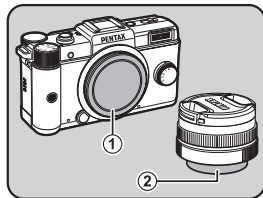

## 3 Align the Lens mount index (red dots: ③) on the camera and the lens, and secure by turning the lens clockwise until it clicks.

After attaching, turn the lens counterclockwise to check that the lens is locked in place.

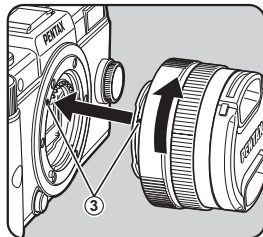

- 4** Remove the front lens cap by pushing the indicated portions inward.

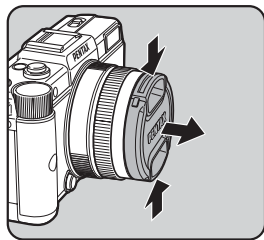

To remove the lens, attach the lens cap first, hold down the lens unlock button (4), and turn the lens counterclockwise.

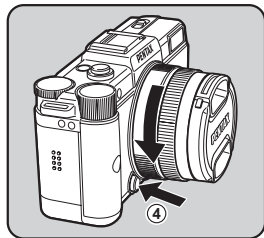

If the lens is removed while the power is on, the monitor will turn off, and the shutter release button will be locked. Do not remove the lens while the power is on.



## 1 Press the power switch.

The camera will turn on.

Press the power switch again to turn off the camera.

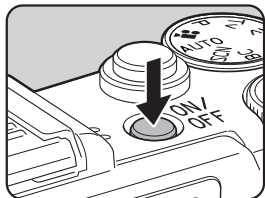

- Always turn the camera off when not in use.
- The power will automatically turn off when you do not perform any operations within a set period of time (Auto Power Off). By default, the camera is set to turn off automatically after 1 minute of inactivity. You can change the setting in [Auto Power Off] of the [Set-up 2] menu. (p.190)
- To turn the camera on in the playback mode, press the power switch while holding down the  button.

The first time the camera is turned on after purchasing, the [Language/言語] screen appears on the monitor. Follow the procedure below to set the language displayed on the monitor and the current date and time. Once these settings are made, you will not need to set them again the next time you turn on your camera.

If the [Date Adjustment] screen appears, set the date and time by following the procedure in “Setting the Date and Time” (p.50).

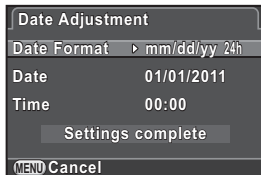
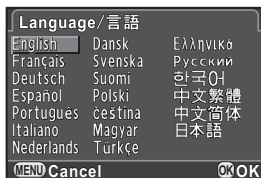

## Setting the Display Language

You can choose the language in which the menus, error messages, etc. are displayed from the following: English, French, German, Spanish, Portuguese, Italian, Dutch, Danish, Swedish, Finnish, Polish, Czech, Hungarian, Turkish, Greek, Russian, Korean, Traditional Chinese, Simplified Chinese and Japanese.

- 1 Use the four-way controller (▲▼◀▶) to select the desired language, and press the OK button.

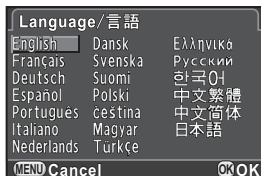

The [Initial Setting] screen appears in the selected language.

Proceed to Step 6 if  (Hometown) does not have to be changed.



- 2** Press the four-way controller (▼) to move the frame to , and press the four-way controller (▶).

The [ Hometown] screen appears.

- 3** Use the four-way controller (◀▶) to select a city.

Refer to “List of World Time Cities” (p.189) for cities that can be selected as a hometown.

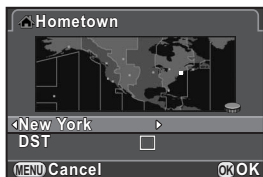

- 4** Press the four-way controller (▼) to select [DST] (daylight saving time), and use the four-way controller (◀▶) to select  or .

- 5** Press the OK button.

The camera returns to the [Initial Setting] screen.

- 6** Press the four-way controller (▼) to select [Settings complete], and press the OK button.

The [Date Adjustment] screen appears.



When the hometown and the date and time are not set, the [Initial Setting] screen or [Date Adjustment] screen will be displayed again the next time the camera is turned on.

## Setting the Date and Time

Set the current date and time and the display style.

- 1 Press the four-way controller (▶), and use the four-way controller (▲▼) to select the date format.

Choose [mm/dd/yy], [dd/mm/yy] or [yy/mm/dd].

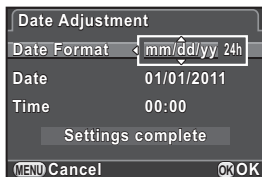

- 2 Press the four-way controller (▶), and use the four-way controller (▲▼) to select 24h (24-hour display) or 12h (12-hour display).

- 3 Press the four-way controller (▶).

The frame returns to [Date Format].

- 4 Press the four-way controller (▼), and press the four-way controller (▶).

The frame moves to the month if the date format is set to [mm/dd/yy].

- 5 Use the four-way controller (▲▼) to set the month.

Set the day and year in the same manner. Next, set the time.

If you select [12h] in Step 2, the camera switches between am and pm depending on the time.

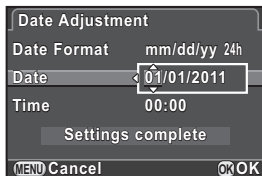

## 6 Press the four-way controller (▼) to select [Settings complete], and press the OK button.

The camera switches to Capture mode and is ready to take a picture.

If you set the date and time from the menu, the screen will return to the [↖ Set-up 1] menu. In this case, press the **MENU** button.

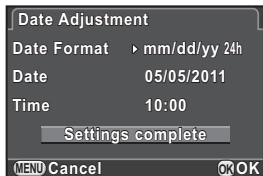

Pressing the **MENU** button while setting the date and time cancels the settings made up to that point and switches the camera to Capture mode. After initial settings are complete, if the camera power is turned off before the date and time settings are complete, the [Date Adjustment] screen will appear first the next time you turn the camera on. You can also set the date and time from the menu later. (p.187)



- When you press the **OK** button in Step 6, the seconds value is set to 0. To set the exact time, press the **OK** button when the time signal (on the TV, radio, etc.) reaches 0 seconds.
- You can change the language and date and time settings from the menu. (p.187, p.190)

**Memo**

# 3 Basic Operations

---

This chapter explains basic operations for shooting by setting mode dial to **AUTO** (Auto Picture) to have the camera select the optimum settings based on the subject. For information about advanced functions and settings for taking pictures, refer to chapter 4 and onward.

<b>Basic Shooting Operation .....</b>	<b>54</b>
<b>Using a Zoom Lens .....</b>	<b>56</b>
<b>Using the Built-in Flash .....</b>	<b>57</b>
<b>Reviewing Images .....</b>	<b>61</b>

## Letting the Camera Choose the Optimal Settings

This camera features various capture modes, focus modes, and drive modes. This section explains how to take pictures by simply pressing the shutter release button.

3

Basic Operations

### 1 Set the mode dial to AUTO.

The camera will select the optimal capture mode for the subject.

- ☛ Selecting the Appropriate Capture Mode (p.69)

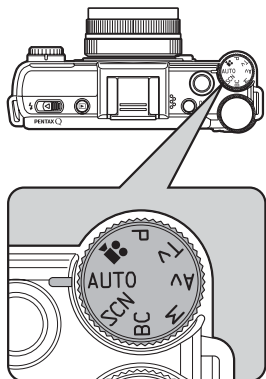

### 2 View the subject on the monitor.









A zoom lens can be used to change the size of the subject on the monitor. (p.56)



### 3 Position the subject inside the AF frame, and press the shutter release button halfway.

The autofocus system operates.

The AF frame turns green and you will hear a beep when the subject comes into focus.

When set to **AUTO** (Auto Picture) mode, the optimal capture mode is automatically selected from  (Standard),  (Portrait),  (Landscape),  (Macro),  (Night Scene Portrait),  (Sunset),  (Blue Sky) or  (Forest). (p.70)



AF frame

### 4 Press the shutter release button fully.

The picture is taken.

This action is referred to as “releasing the shutter” or “release”.

### 5 Review the captured image on the monitor.

The image appears for 1 second on the monitor shortly after capturing (Instant Review).

 Setting the Display for Instant Review (p.192)

You can enlarge the image during Instant Review with the e-dial. (p.155)

You can delete the image during Instant Review by pressing the  button.

 Deleting a Single Image (p.62)



- The shutter sound and the beep that sounds when the image is focused can be turned off. (p.186)
- You can set the camera so that pressing the  button will focus automatically, in the same way as pressing the shutter release button halfway. (p.90)
- You can preview the image on the monitor and check the depth of field before taking pictures. (p.94)

Enlarge the subject (telephoto) or capture a wider area (wide angle) with a zoom lens. Adjust the subject to the desired size and take pictures.

## 1 Turn the zoom ring to the right or left.

The angle of view changes.

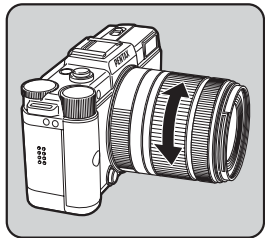

The following functions can be set on the camera depending on the lens being used.

- Setting whether to use the ND filter built-in to the lens (p.148).
- Correcting distortion (p.149)









Use the flash to take pictures in low light or backlit conditions.

The built-in flash is optimum for a subject at a distance from 0.7 m to 3 m. Exposure will not be properly controlled and vignetting (darkening of the corners of the image due to a lack of light) may occur when used at a distance closer than 0.7 m (this distance varies slightly depending on the lens being used and the sensitivity setting. (p.213))



For details on the built-in flash and instructions on how to take pictures with an external flash, refer to "Using the Flash" (p.211).

## Setting the Flash Mode





Flash Mode	Function
 Auto Flash Discharge	The camera automatically measures the ambient light and determines whether to use the flash.
 Auto Flash+Red-eye Reduction	Discharges a pre-flash for red-eye reduction before the automatic flash.
 Flash On	Discharges the flash for each picture.
 Flash On+Red-eye Reduction	Discharges a pre-flash for red-eye reduction before the main flash.
 Slow-speed Sync	Sets to a slow shutter speed depending on the brightness. When using this to shoot a portrait with the sunset in the background, both the person and the background are captured beautifully.
 Slow-speed Sync +Red-eye	Discharges a pre-flash for red-eye reduction before the main flash is discharged with Slow-speed Sync.
 Trailing Curtain Sync	Discharges the flash immediately before closing the shutter. Captures moving objects as if they are leaving a trail behind. (p.213)
 Flash Off	The flash is deactivated.



**1 Press the four-way controller (▼) in Step 2 on p.58.**

**2 Turn the e-dial.**

The flash compensation value is displayed.

Press the / button to reset the value to 0.0. (Available only when [Green Button] is assigned to the / button in [Green Button] of the [Rec. Mode 3] menu (p.144).)



- When the flash output exceeds its maximum amount, the compensation will not be effective even if the compensation value is set to the plus (+) side.
- Compensating to the minus (-) side may have no effect if the subject is too close, the aperture is set to a large opening, or sensitivity is high.
- The flash output compensation is also effective for external flash units which support P-TTL auto flash mode.

## Shooting with the Flash

**1 Select a flash mode.**

**2 Slide the flash pop-up switch in the direction of the arrow.**

The built-in flash pops up.

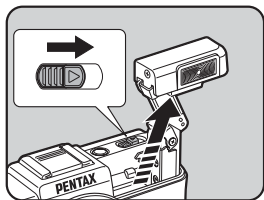

**3 Press the shutter release button halfway.**

The flash starts charging.

**4 Press the shutter release button fully.**

The picture is taken.

## 5 Push down in the direction of the arrow to retract the built-in flash.

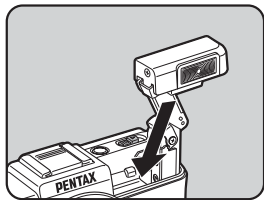

- The built-in flash discharges even when retracted, which may cause vignetting to occur depending on the lens being used. Vignetting may also occur at other times depending on the shooting conditions.
- Be sure to retract the built-in flash if not planning to use it. Be careful not to get your fingers pinched when retracting the flash.



- If you do not want to let the built-in flash discharge while it is retracted, set [10. Flash When Retracted] (p.68) to [Do Not Discharge Flash] in the [C Custom Setting 2] menu.
- You cannot take pictures while the built-in flash is being charged. If you want to take pictures while charging the built-in flash, set [11. Release While Charging] (p.68) to [On] in the [C Custom Setting 2] menu.

## Playing Back Images

You can play back captured images with the camera.

### 1 Press the button.

The camera enters Playback mode and the most recently captured image (image with the highest file number) is displayed on the monitor. (For movies, only the first frame is displayed on the monitor.)

Press the **INFO** button during playback to display the shooting information of the image. (p.25)

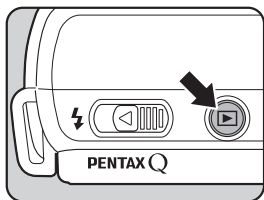

### 2 Press the four-way controller ( ).

- ◀: Displays the previous image.
- ▶: Displays the next image.

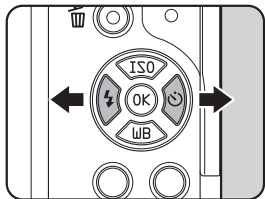

- Refer to “Playback Functions” (p.151) for details on the playback mode functions.
- When the file format of the last captured image is JPEG, and its RAW data still remains in the buffer memory, you can save the RAW image by pressing the  **Av** button during Instant Review or playback. If the image was shot using any of the following settings, the corresponding image listed is saved.
  - Digital Filter                      RAW image without a filter effect
  - Smart Effect                        RAW image with [Bright] image finishing tone

## Deleting a Single Image

You can delete images one by one.



- Deleted images cannot be restored.
- Protected images cannot be deleted. (p.199)

**1** Press the button, and use the four-way controller ( ) to select an image to delete.

**2** Press the button.

The delete confirmation screen appears.

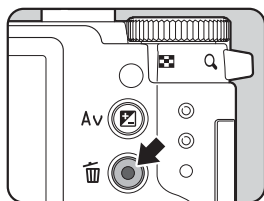

**3** Use the four-way controller ( ) to select [Delete].

Select a file format to delete for images saved in RAW+ format.

Delete JPEG	Deletes only the JPEG image.
Delete RAW	Deletes only the RAW image.
Delete RAW+JPEG	Deletes images in both file formats.

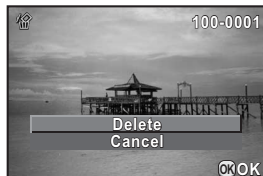

**4** Press the **OK** button.

The image is deleted.



You can delete multiple images at once. Refer to “Deleting Multiple Images” (p.165) for details.



# 4 Shooting Functions

---

This chapter describes the various basic and advanced shooting functions available with this camera.

<b>How to Operate the Shooting Functions .....</b>	<b>64</b>
<b>Selecting the Appropriate Capture Mode .....</b>	<b>69</b>
<b>Setting the Exposure .....</b>	<b>75</b>
<b>Focusing .....</b>	<b>86</b>
<b>Checking the Depth of Field (Preview) .....</b>	<b>94</b>
<b>Using the Shake Reduction Function to Prevent Camera Shake .....</b>	<b>96</b>
<b>Taking Pictures Continuously .....</b>	<b>102</b>
<b>Recording Movies .....</b>	<b>109</b>

# How to Operate the Shooting Functions

You can change capture-related settings using the direct keys, control panel, [📷 Rec. Mode] menu, [🎥 Movie] menu or [C Custom Setting] menu.



For details on how to use the menus, refer to "Using the Menus" (p.32).

## Direct Keys Setting Items

Press the four-way controller (▲▼◀▶) in Capture mode to set the following items.

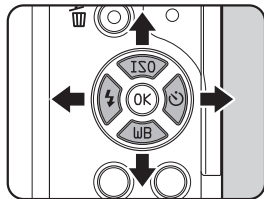

Key	Item	Function	Page
▲	Sensitivity	Sets the ISO sensitivity.	p.75
▼	White Balance	Adjusts the color balance to match the type of the light source illuminating the subject.	p.124
◀	Flash Mode	Sets the method of flash discharge.	p.57
▶	Drive Mode	Selects Continuous Shooting, Self-timer, Remote Control or Exposure Bracketing shooting.	p.102 p.98 p.100 p.80



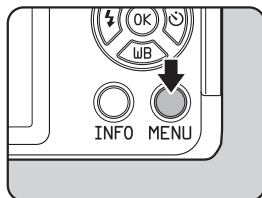

## Rec. Mode Menu Items

The following settings can be performed in the [📷 Rec. Mode 1-3] menus.

Press the **MENU** button in Capture mode to display the [📷 Rec. Mode 1] menu.







Menu	Item	Function	Page	
📷 1	Custom Image *1	Sets the image finishing tone such as color and contrast before shooting an image.	p.131	
	Digital Filter *1	Applies a digital filter effect when taking pictures.	p.135	
	Image Capture Settings	File Format *1	Sets the file format.	p.120
		Aspect Ratio *1	Sets the horizontal and vertical ratio of images.	
		JPEG Recorded Pixels *1	Sets the recording size of images saved in JPEG format.	
		JPEG Quality *1	Sets the quality of images saved in JPEG format.	
		Color Space	Sets the color space to use.	
	Focus Settings	Focus Method *1	Selects the autofocus or manual focus mode.	p.86
		Autofocus Method *1	Selects the autofocus method in <b>AF</b> mode.	p.87
		MF Assist	Enlarges the monitor display during manual focus and makes it easier to focus on the subject.	p.93
	AE Metering *1	Selects the part of the sensor to use for measuring brightness and determining exposure.	p.84	
	ND Filter *1	Sets whether to use the ND filter built-in to the lens.	p.148	

Menu	Item	Function	Page
 2	HDR Capture *1	Enables capturing images with high dynamic range.	p.130
	Multi-exposure	Creates a picture by taking multiple exposures and merging them into a single image.	p.107
	Interval Shooting	Takes pictures at a set interval from a set time.	p.104
	D-Range Setting *1	Expands the dynamic range and prevents bright and dark areas from occurring.	p.128 p.129
	High-ISO NR	Sets the Noise Reduction setting when shooting with a high ISO sensitivity.	p.85
	Distortion Correction	Reduces distortions occurring due to lens properties.	p.149
 3	Quick Dial	Assigns functions to the quick dial.	p.138
	Green Button	Assigns functions to the  /  button.	p.144
	LCD View Options	Sets the monitor display in Capture mode.	p.191
	Instant Review	Sets the Instant Review display settings.	p.192
	Memory	Determines which settings to save when the power is turned off.	p.195
	Shake Reduction *1	Activates the Shake Reduction function.	p.96

\*1 Can be also set through the control panel.

## Movie Menu Items

The following settings can be performed in the [ Movie 1] menu. Press the **MENU** button when the mode dial is set to  to display the [ Movie 1] menu.

Menu	Item	Function	Page
 1	Recorded Pixels *1	Sets the number of recorded pixels or size of the movie.	p.109
	Sound *1	Sets whether to record sound together with movies.	
	Exposure Setting	Sets whether to set the exposure manually.	
	Movie SR *1	Activates the Movie SR function.	
	Interval Movie	Takes still pictures at a set interval from a set time and records it as a single movie file.	p.113

\*1 Can be also set through the control panel.

## Custom Setting Menu Items

Set the [**C** Custom Setting 1-2] menus to fully use the functions of this camera.

Menu	Item	Function	Page
C1	1. AE-L with AF Locked	Sets whether to lock the exposure value when the focus is locked.	p.83
	2. Link AE to AF Point	Sets whether to link the exposure and AF point in the focusing area during multi-segment metering.	p.84
	3. Auto Bracketing Order	Sets the order for Exposure Bracketing shooting.	p.80
	4. Shake Reduction Options	Sets whether to use Shake Reduction during standby mode as well.	p.97
	5. WB When Using Flash	Sets the white balance setting when using flash.	p.125
	6. AWB in Tungsten Light	Sets whether to adjust the tungsten light color tone when the white balance is set to <b>AWB</b> (Auto White Balance).	—
	7. AF Release Options	Sets the action priority for when the shutter release button is fully pressed in <b>AF</b> mode.	p.88
C2	8. AF Assist Light	Sets whether to use the AF assist light when autofocusing in dark locations.	p.87
	9. AF with Remote Control	Sets whether to use autofocus when shooting with remote control.	p.101
	10. Flash When Retracted	Sets whether to discharge the built-in flash when retracted.	p.60
	11. Release While Charging	Sets whether to release the shutter while the built-in flash is charging.	p.60
	12. Save Menu Location	Sets whether to save the last menu tab displayed on the monitor and to display it again the next time the <b>MENU</b> button is pressed.	p.192
	13. Electronic Shutter	Sets whether to use the electronic shutter when using a lens that has a lens shutter.	p.226
	Reset Custom Functions	Resets all the settings in the [ <b>C</b> Custom Setting 1-2] menus to the defaults.	p.196

# Selecting the Appropriate Capture Mode

This camera features various shooting modes, enabling you to take pictures with settings suited for your photographic vision. In this manual, the capture modes are referred to as follows.

Capture Mode	Mode	Page
<b>AUTO</b> (Auto Picture) mode	The camera will automatically select the optimal capture mode for the subject.	p.70
<b>SCN</b> (Scene) mode	You can choose the capture mode from various scene styles.	p.71
<b>BC</b> (Blur Control) mode	Takes pictures while emphasizing a blur effect.	p.73
Exposure modes ( <b>P/Tv/Av/M</b> )	Changes the shutter speed and aperture value, and takes pictures.	p.74
 (Movie) mode	Records a movie.	p.111

- 1 Turn the mode dial to set the desired capture mode on the mode dial to the dial indicator.

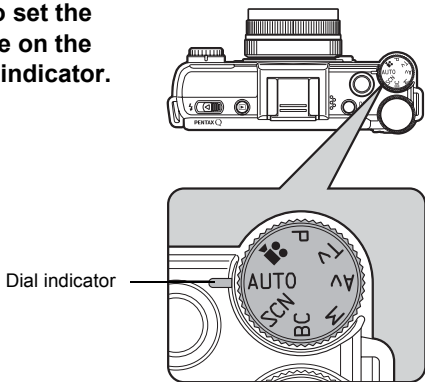

The selected shooting mode is displayed on the monitor (Guide Display).





- Set the guide display time in [Guide Display] of the [ Setup 1 ] menu. (p.191)
- The scene mode selection screen appears when the mode dial is set to **SCN** (p.72)

## Auto Picture Modes



















When set to **AUTO** (Auto Picture) mode, the camera automatically selects the optimal mode from the following capture modes for the subject.





Mode	Characteristics
Standard	This is selected when none of the following seven modes apply.
Portrait	For capturing portraits. Reproduces a healthy and bright skin tone.
Landscape	For capturing landscape views. Increases color saturation and produces a vivid color image
Macro	For capturing tiny objects at close focus range like flowers, coins, jewelry, and more
Night Scene Portrait	For capturing images of people in low light conditions, such as dusk or at night. Even though the flash is used, the camera will use slow shutter speeds so the background areas beyond the flash reach will also appear correctly exposed in the picture (Ⓜ Slow-speed Sync (p.212)). To prevent camera shake, either use the Shake Reduction function or mount the camera on a tripod.
Sunset	For capturing sunrises or sunsets in beautiful, vivid color
Blue Sky	For capturing images of blue sky. Produces a more impressive deep blue
Forest	Enhances colors of trees and sunbeams through foliage and produces a vivid color image











## Scene Modes

By setting the mode dial to **SCN** (Scene), you can choose from the following scene modes.

Mode	Characteristics
 Portrait	For capturing portraits. Reproduces a healthy and bright skin tone.
 Landscape	For capturing landscape views. Increases color saturation and produces a vivid color image
 Macro	For capturing tiny objects at close focus range like flowers, coins, jewelry, and more
 Moving Object	For capturing images of fast moving subjects, such as at sporting events. The drive mode is fixed to  (Continuous Shooting (Hi)).
 Night Scene Portrait	For capturing images of people in low light conditions, such as dusk or at night. Even though the flash is used, the camera will use slow shutter speeds so the background areas beyond the flash reach will also appear correctly exposed in the picture (  Slow-speed Sync (p.212)). To prevent camera shake, either use the Shake Reduction function or mount the camera on a tripod.
 Sunset	For capturing sunrises or sunsets in beautiful, vivid color
 Blue Sky	For capturing images of blue sky. Produces a more impressive deep blue
 Night Scene	Used for shooting at night. Use a tripod or flat surface to prevent camera shake blur
 Night Scene HDR	Generates a single HDR image with less noise from 3 images captured in dim lighting
 Night Snap	For taking snapshots in poorly lit place
 Food	For capturing images of food. Saturation will be rather high to make it look appetizing.
 Quick Macro	For quick capture of tiny objects at close focus range. This mode automatically adds Blur Control.
 Pet	For capturing moving pets. The drive mode is fixed to  (Continuous Shooting (Hi)).
 Kids	For capturing moving kids. Reproduces healthy and bright skin tone. The drive mode is fixed to  (Continuous Shooting (Hi)).
 Forest	Enhances colors of trees and sunbeams through foliage and produces a vivid color image

Mode	Characteristics
 Surf & Snow	For capturing images of dazzling backgrounds, such as snowy mountains
<b>HDR</b> HDR	Captures 3 images to generate a single HDR image and provides a wider dynamic range
 Backlight Silhouette	Produces a silhouette image of subject in backlight condition
 Candlelight	For capturing scenes in candlelight
 Stage Lighting	For capturing moving subjects in poorly lit place
 Museum	For capturing images in places where a flash is prohibited



The flash mode is fixed to  (Flash Off) in , , , **HDR**, , , , and . To prevent camera shake, either set [Shake Reduction] to  (On) or mount the camera on a tripod.

## Selecting a Scene Mode

### 1 Set the mode dial to **SCN**.

The camera switches to the **SCN** mode, and the scene mode selection screen appears.

### 2 Use the four-way controller (▲▼◀▶) or e-dial to choose a scene mode, and press the **OK** button.

The camera is ready to take a picture.

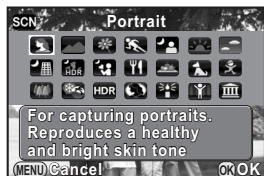

- To change the scene mode, press the **INFO** button, and select [Scene Mode] in the control panel.
- When the **MENU** button is pressed while the mode dial is set to **SCN**, the item [Scene Mode] appears on the [Rec. Mode 1] menu. Press the four-way controller (▶) to display the scene mode selection screen and you can select a scene mode in the same way as described in Step 2.

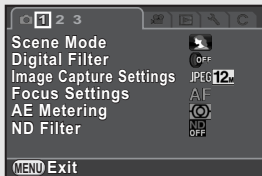

## Blur Control Mode

Blur Control enables you to create a picture that looks as if it was taken with a wide-open aperture and shallow depth of field, by shooting multiple images with different focus positions and merging them into a single image. This can produce a more noticeable blur effect that was difficult to achieve with conventional compact cameras.



In **BC** mode, images are captured using the following settings:

- Exposure control    Open aperture priority
- Sensitivity            Fixed to AUTO
- File Format            Fixed to JPEG

### 1 Set the mode dial to BC.

The camera switches to **BC** mode.

### 2 Turn the e-dial.

Select the level of blur from three levels while viewing the image on the monitor.

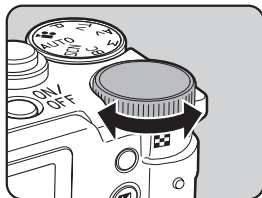



- Do not move the camera while taking a picture.
- If holding the camera by hand while shooting, set [Shake Reduction] to (On).
- The function may not work as effectively as expected if a lens other than an AF lens is used.
- The following functions are not available in this mode:
  - Continuous Shooting, Remote Continuous Shooting, or Exposure Bracketing
  - Multi-exposure
  - HDR Capture
  - Smart Effect
- The blur effect may not turn out as well as expected in the following situations:
  - when the contrast is low overall
  - with fountains and other objects that change color or shape constantly
  - with moving objects
  - with small objects
  - with objects at the edge of the screen
  - with backlit scenes and other similar conditions
  - when a special filter is used
  - with far-off objects (Shooting at distances that produce portrait images from the chest up is recommended)

## Exposure Modes

Use the exposure modes to change the shutter speed and aperture value and take pictures.

Mode	Characteristics	Page
<b>P</b> Program	Automatically sets the shutter speed and aperture value to obtain a proper exposure according to the Program line.	p.76
<b>Tv</b> Shutter Priority	Lets you set the desired shutter speed for expressing subject movement.	
<b>Av</b> Aperture Priority	Lets you set the desired aperture value for controlling the depth of field.	
<b>M</b> Manual	Lets you set the shutter speed and aperture value to match your photographic vision.	

## Setting the Sensitivity

You can set the sensitivity to suit the brightness of the surroundings. The sensitivity can be set to AUTO or within a sensitivity range equivalent to ISO 125 to 6400 in increments of 1/3 EV. The default setting is AUTO.

### 1 Press the four-way controller (▲) in Capture mode.

The Sensitivity setting screen appears.

### 2 Use the four-way controller (▲▼) to select [ISO AUTO] or [ISO].

ISO AUTO	Sets the range to be adjusted automatically.
ISO	Sets the fixed value.



### 3 Use the e-dial to change the sensitivity value.

### 4 Press the OK button.

The camera is ready to take a picture.



- When the capture mode is set to (Night Scene HDR)/ (Night Snap)/**HDR** (HDR)/ (Stage Lighting) of **SCN** (Scene) mode, the sensitivity is fixed to AUTO and cannot be changed.
- When the mode dial is set to **M** (Manual), [ISO AUTO] is not displayed. When the sensitivity is set to AUTO and the mode dial is set to **M**, the sensitivity is fixed to the last set value.
- The minimum sensitivity is ISO 250 when [Highlight Correction] (p.128) is set to [On].
- Captured images may show more noise if a higher sensitivity is set. You can change the setting in [High-ISO NR] of the [ Rec. Mode 2] menu. (p.85)

## Expanding the Dynamic Range

Dynamic range is the ratio that indicates the light level expressed by the CMOS sensor pixels from bright areas to dark areas. The larger it is, the better the whole range from dark to bright areas will appear in the picture.

By expanding the dynamic range, you can expand the light level expressed by the CMOS sensor pixels, making it more difficult for bright areas or dark areas to occur in the image.

To expand the dynamic range, make the settings in [D-Range Setting] of the [📷 Rec. Mode 2] menu. (p.128)

## Changing the Exposure Mode

This camera features the following four exposure modes. The settings available for each exposure mode are as follows.

✓ : Available # : Restricted × : Not available

Exposure Mode	EV Compensation	Change Shutter Speed	Change Aperture Value	Change Sensitivity
<b>P</b> Program	✓	# <sup>*1</sup>	# <sup>*1</sup>	✓
<b>Tv</b> Shutter Priority	✓	✓	×	✓
<b>Av</b> Aperture Priority	✓	×	✓	✓
<b>M</b> Manual	×	✓	✓	Other than AUTO

\*1 In [Green Button] of the [📷 Rec. Mode 3] menu, you can make the setting so that the shutter speed and/or aperture value can be changed by turning the e-dial. (p.146)

- 1 Set the mode dial to **P**, **Tv**, **Av** or **M**.

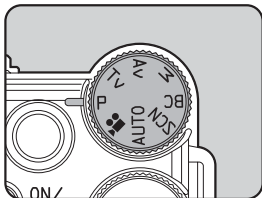

## 2 Turn the e-dial to adjust the value.

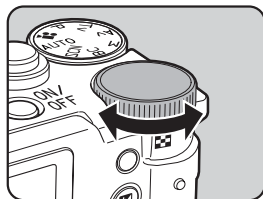

▶ appears on the monitor before the value that can be changed.

The following parameters can be changed depending on the selected exposure mode.



<b>P</b>	Item set in [Green Button] of the [📷 Rec. Mode 3] menu (p.146)
<b>Tv</b>	Shutter speed
<b>Av</b>	Aperture value
<b>M</b>	Shutter speed

## 3 When set to **M** mode, press the **Av** button (①), and then turn the e-dial (②) to change the aperture value.

The exposure compensation value can be adjusted by this operation in **P/Tv/Av** mode. (p.80)

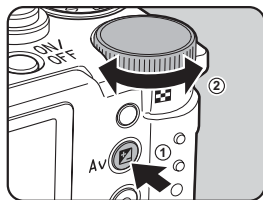

- A proper exposure may not be obtained with the selected shutter speed and aperture value when the sensitivity is set to the fixed value (p.75).
- Use an optional ND (Neutral Density) filter if the subject is too bright. Use a flash if it is too dark.
- In **M** mode, the difference from the proper exposure is displayed in a bar graph while the shutter speed or aperture value is adjusted. The exposure value is displayed in red when the difference from the proper exposure becomes  $\pm 3.0$  or larger.
- You can set the function of the button when the exposure mode is set to **M**. Set in [Green Button] of the [📷 Rec. Mode 3] menu. (p.147)
- Sensitivity values higher than ISO 1600 are not available when the shutter speed is set to 2 sec. or slower in **Tv/M** mode.

## Using the Bulb Shooting

This is useful when shooting night scenes and fireworks which require long exposures.

- 1 **Set the mode dial to M.**
- 2 **Turn the e-dial to the left (☒), and set the shutter speed to Bulb.**

**Bulb** appears after the slowest shutter speed.



- 3 **Press the shutter release button.**

The shutter remains open as long as the shutter release button is kept pressed.



- Bulb shooting is available only when using a lens that has a lens shutter.
- In Bulb shooting, the following functions are not available.
  - EV Compensation
  - Exposure Bracketing
  - AE Lock
  - Continuous Shooting
  - Interval Shooting
  - HDR Capture
  - Shake Reduction
- Bulb shooting ends compulsorily once the exposure time exceeds 32 seconds.



- Use a sturdy tripod to prevent camera shake during Bulb shooting.
- The upper sensitivity limit for Bulb shooting is ISO 1600.
- We recommend using the AC adapter kit K-AC115 (optional) when shooting with a long exposure setting as the battery drain is high during Bulb shooting. (p.40)



## Adjusting the Exposure

This allows you to deliberately overexpose (brighten) or underexpose (darken) your picture.

The compensation value can be set in increments of 1/3 EV or 1/2 EV between -3 and +3 depending on the lens being used.

Step Interval	Exposure Setting Value
1/3 EV	$\pm 0.3, \pm 0.7, \pm 1.0, \pm 1.3, \pm 1.7, \pm 2.0, \pm 2.3, \pm 2.7, \pm 3.0$
1/2 EV	$\pm 0.5, \pm 1.0, \pm 1.5, \pm 2.0, \pm 2.5, \pm 3.0$

### 1 Press the Av button (①), and then turn the e-dial (②).

The exposure is adjusted.

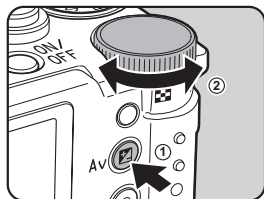





EV bar is displayed on the monitor during adjustment.

Press the  Av button to not show the bar.



EV bar



- EV Compensation is not available when the capture mode is set to **M** (Manual).
- The set compensation value is not canceled by turning the camera off or by switching to another capture mode.
- If [Green Button] is assigned to the  /  button in [Green Button] of the [Camera Rec. Mode 3] menu (p.144), the compensation value is reset to 0.0 when the  /  button is pressed.

## Changing the Exposure Automatically when Shooting (Exposure Bracketing)

You can take three consecutive images at three different exposure levels when the shutter release button is pressed. Three images are saved with each release.



Standard exposure



Underexposure



Overexposure

You can set the bracketing order in [3. Auto Bracketing Order] (p.68) of the [C Custom Setting 1] menu. By default, the first image is exposed with no compensation, the second image is underexposed (negative compensation), and the third image is overexposed (positive compensation).

1	0 - +	Standard → Underexposed → Overexposed (default setting)
2	- 0 +	Underexposed → Standard → Overexposed
3	+ 0 -	Overexposed → Standard → Underexposed
4	0 + -	Standard → Overexposed → Underexposed





- Exposure Bracketing is not available in the following situations.
  - when the capture mode is set to (Moving Object)/ (Night Scene HDR)/ (Pet)/ (Kids)/HDR (HDR) of SCN (Scene) mode
  - when the shutter speed is set to **Bulb**
  - when HDR Capture is set
- Exposure Bracketing cannot be used with Interval Shooting or Multi-exposure at the same time. (The function selected last is used.)



### 1 Press the four-way controller (▶) in Capture mode.

The Drive Mode setting screen appears.

### 2 Use the four-way controller (◀▶) to select .

- 3** Press the four-way controller (▼), and use the four-way controller (◀▶) to select  or .









 Exposure Bracketing	Takes pictures with the shutter release button.
 Exposure Bracket +Remote Ctrl	Takes pictures with an optional remote control unit. The remote control operates according to the Remote Control shooting (p.100) setting. The shutter is immediately released when set to  (Remote Continuous Shooting).

- 4** Press the four-way controller (▼), and turn the e-dial to set the bracket value.

The bracket value can be set in increments of 1/3 EV or 1/2 EV depending on the lens being used.

Step Interval	Bracket Value
1/3 EV	±0.3, ±0.7, ±1.0, ±1.3, ±1.7, ±2.0, ±2.3, ±2.7, ±3.0
1/2 EV	±0.5, ±1.0, ±1.5, ±2.0, ±2.5, ±3.0

#### Available operations

-  **Av** button Adjusts the EV compensation value (only when taking → e-dial underexposed or overexposed images).
-   button Resets the compensation value.  
(Available only when [Green Button] is assigned to the /  button in [Green Button] of the [ Rec. Mode 3] menu (p.144).)

- 5** Press the **OK** button.

The camera is ready to take a picture.



- When [Autofocus Method] (p.87) is set to [AF Select (25 Points)], [Select] or [Spot], the focus position is locked in the first image and is used for subsequent images.
- Switch to a mode other than or in the Drive Mode setting screen to cancel Exposure Bracketting. The setting is canceled when the camera is turned off if [Drive Mode] is set to  (Off) in [Memory] (p.195) of the [Rec. Mode 3] menu.
- You can combine Exposure Bracketting with the built-in flash or an external flash (P-TTL auto only) to change only the flash output continuously.

## Locking the Exposure Before Shooting (AE Lock)

AE Lock is a function that locks the exposure (brightness) prior to taking a picture. Use this when the subject is too small or is backlit and a proper exposure setting cannot be obtained.

First, assign the AE Lock function to the button.

- 1 Select [Green Button] in the [Rec. Mode 3] menu, and press the four-way controller (▶).**

The [Green Button] screen appears.

- 2 Press the four-way controller (▶), use the four-way controller (▲▼) to select [AE Lock], and press the OK button.**

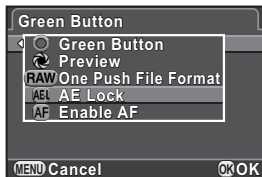

- 3 Press the MENU button twice.**



The AE Lock function is assigned to the button and the camera is ready to take a picture.

## 4 Set the exposure, and press the button.

The camera locks the exposure at that instant.

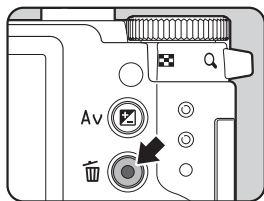

**\*** is displayed on the monitor while AE Lock is engaged.



- The exposure remains locked as long as the  button is kept pressed or the shutter release button is kept pressed halfway.
- You will hear a beep when AE Lock is activated. The beep can be turned off. (p.186)
- When any of the following operations are performed, AE Lock is canceled.
  - the  button is pressed again
  - the  button, **MENU** button, or power switch is pressed
  - the mode dial is turned
  - the lens is changed
- AE Lock is not available when the shutter speed is set to **Bulb**.
- The exposure is also locked when the focus is locked. If you do not want to lock the exposure when the focus is locked, set [1. AE-L with AF Locked] (p.68) of the [**C** Custom Setting 1] menu to [Off].
- When the shutter speed or aperture value is changed while AE Lock is engaged in **M** (Manual) mode, the combination of shutter speed and aperture value changes while the exposure remains the same. For example, when the shutter speed is 1/125 sec. and aperture is F4 and these settings are locked, the aperture automatically changes to F8 if the shutter speed is changed to 1/30 sec.
- When using a zoom lens whose maximum aperture varies depending on the focal length, the combination of shutter speed and aperture value changes depending on the zooming position even while AE Lock is engaged. However, the exposure value does not change and a picture is taken at a brightness level set when AE Lock is activated.

## Selecting the Metering Method

Choose the part of the sensor to use for measuring brightness and determining exposure. The following three methods are available.

 Multi-segment metering	The sensor meters the brightness in 16 different zones. (default setting) Even in backlit locations, this mode automatically determines what level of brightness is in which portion and automatically adjusts exposure.
 Center-weighted metering	Metering is weighted at the center of the sensor. The sensitivity increases at the center and no automatic adjustment is performed even during backlit scenes.
 Spot metering	The brightness is measured only within a limited area at the center of the sensor. You can use this in combination with the AE Lock function (p.82) when the subject is extremely small and a correct exposure is difficult to obtain.

### 1 Press the INFO button in Capture mode.

The control panel appears.

### 2 Use the four-way controller (▲▼◀▶) to select [AE Metering], and press the OK button.

The [AE Metering] screen appears.

### 3 Use the four-way controller (◀▶) to select a metering method, and press the OK button.

The camera returns to the control panel.



- You can also change the setting from the [Rec. Mode 1] menu.
- In [2. Link AE to AF Point] (p.68) of the [C Custom Setting 1] menu, you can link the exposure and AF point in the focusing area during multi-segment metering.

## Reducing Image Noise (Noise Reduction)

When shooting with a digital camera, image noise (image roughness or unevenness) becomes noticeable in the following situations.

- when shooting with a long exposure
- when shooting with a high sensitivity setting
- when the temperature of the CMOS sensor is high

You can reduce image noise by using Noise Reduction.

### High-ISO NR

Reduces noise at high sensitivity (ISO) settings.

**1** Select **[High-ISO NR]** in the **[📷 Rec. Mode 2]** menu, and press the four-way controller (▶).

**2** Use the four-way controller (▲▼) to select **[Auto]**, **[Low]** or **[High]**, and press the **OK** button.

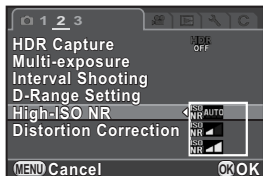

Auto	Applies Noise Reduction at optimally calculated levels throughout ISO range. (default setting)
Low/High	Applies Noise Reduction at constant chosen level throughout ISO range.

**3** Press the **MENU** button.

The camera is ready to take a picture.



The card access lamp blinks and the camera cannot be operated during Noise Reduction.

## Setting the Focus Method

You can focus with the following methods.

<b>AF</b> Autofocus	The camera automatically focuses on the subject when the shutter release button is pressed halfway.
<b>MF</b> Manual focus	Manually adjust the focus.

### 1 Press the **INFO** button in Capture mode.

The control panel appears.

### 2 Use the four-way controller (▲▼◀▶) to select [Focus Method], and press the **OK** button.

The [Focus Method] screen appears.

### 3 Use the four-way controller (◀▶) to select a focus method, and press the **OK** button.

The camera returns to the control panel.

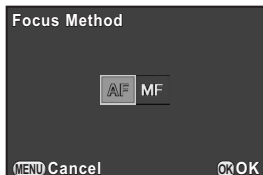

Refer to “Letting the Camera Choose the Optimal Settings” (p.54) for information on how to take pictures in **AF** mode.

Refer to “Adjusting the Focus Manually (Manual Focus)” (p.92) for information on how to take pictures in **MF** mode.





- You can also change the setting from the [Focus Settings] (p.65) of the [Camera Rec. Mode 1] menu.
- [Focus Method] is fixed to **AF** when the capture mode is set to **AUTO** (Auto Picture) or **BC** (Blur Control) mode, or (Moving Object)/ (Night Snap)/ (Quick Macro)/ (Pet)/ (Kids)/ (Stage Lighting) of **SCN** (Scene) mode.
- In **AF** mode, when the subject is in a dark location, the AF assist light is used when the shutter release button is pressed halfway. To not use the AF assist light, set [8. AF Assist Light] (p.68) to [Off] in the [Custom Setting 2] menu.

## Setting the Autofocus Method

You can choose from the following five autofocus methods in **AF** mode.

Face Detection	Detects and tracks faces of people. The faces of up to 12 people can be detected. The main face detection frame for autofocus and auto exposure is displayed in yellow. The shutter is released by pressing the shutter release button fully even if the subject is not in focus.
Tracking	Tracks the subject in focus when the shutter release button is pressed halfway. The shutter is released by pressing the shutter release button fully even if the subject is not in focus.
AF Select (25 Points)	Sets the focusing area to the desired area. (default setting) The sensor is divided into 25 areas (5 horizontal by 5 vertical), and you can select a wider or narrower focusing area by using 25, 9, 5, 3 or just 1 of those 25 areas available. (p.89)
Select	Sets the focusing area by the number of pixels. You can select a setting more detailed than [AF Select (25 Points)].
Spot	Sets the focusing area to a limited area at the center.

### 1 Press the **INFO** button in Capture mode.

The control panel appears.

### 2 Use the four-way controller ( ) to select [Autofocus Method], and press the **OK** button.

The [Autofocus Method] screen appears.

### 3 Use the four-way controller (◀▶) to select an autofocus method, and press the OK button.

The camera returns to the control panel.

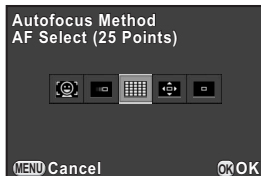

- You can also change the setting from the [Focus Settings] (p.65) of the [Camera Rec. Mode 1] menu.
- [Autofocus Method] is fixed to when the capture mode is set to **AUTO** (Auto Picture), or of **SCN** (Scene) mode.
- [Autofocus Method] is fixed to when the capture mode is set to (Moving Object)/ (Night Snap)/ (Pet)/ (Stage Lighting) of **SCN** (Scene) mode.
- In [AF Select (25 Points)], [Select] or [Spot] mode, you can take pictures by fully pressing the shutter release button only when the subject is in focus. To take pictures when the subject is not in focus, set [7. AF Release Options] (p.68) to [Release-priority] in the [C Custom Setting 1] menu.

## Selecting the Desired Focusing Area

You can set the position and range of the autofocusing area (AF area).

- 1 Select [AF Select (25 Points)] or [Select] in Step 3 on p.88, and press the OK button.**

The camera returns to the control panel.

- 2 Press the INFO button twice.**

The camera is ready to take a picture.

- 3 Press the OK button.**

The position and range of the AF area can be changed.

- 4 Select the AF area.**

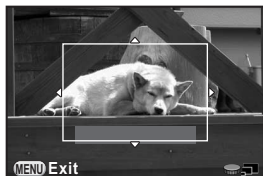

### Available operations

Four-way controller (▲▼◀▶)	Moves the AF area.
E-dial to the right (Q)	Increases the size of the AF area (when [AF Select (25 Points)] is selected).
E-dial to the left (M)	Reduces the size of the AF area (when [AF Select (25 Points)] is selected).
<b>OK</b> button	Returns the AF area to the center.



- 5 Press the MENU button.**



The AF area is set.



The set AF area remains in the memory even if the autofocus method is changed or the camera is turned off.

## Focusing Using the / Button

You can set the camera to perform focusing by pressing the / button. Use this setting when the autofocus by pressing the shutter release button halfway is not desired.

First, assign the Enable AF function to the / button.



- 1 **Select [Green Button] in the [CAMERA] menu, and press the four-way controller (▶).**

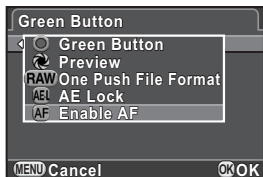

The [Green Button] screen appears.

- 2 **Press the four-way controller (▶), use the four-way controller (▲▼) to select [Enable AF], and press the OK button.**



- 3 **Press the MENU button twice.**

Enable AF is assigned to the / button and the camera is ready to take a picture.

- 4 **While viewing the subject on the monitor, press the / button.**

The autofocus system operates.

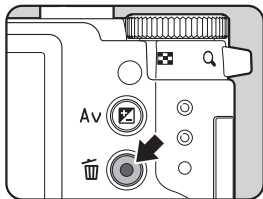

When Enable AF is assigned to the / button, the autofocus by pressing the shutter release button halfway is disabled.

## Locking the Focus (Focus Lock)

If the subject is outside the range of the focusing area, the camera cannot automatically focus on the subject. In this case, focus the camera on the subject in the focusing area, lock the focus at that position (Focus Lock), and then recompose your picture.

### 1 Set [Focus Method] to AF.

Refer to "Setting the Focus Method" (p.86) for details.

### 2 Set [Autofocus Method] to [AF Select (25 Points)], [Select], or [Spot].

Refer to "Setting the Autofocus Method" (p.87) for details.

### 3 Frame the desired composition for your picture on the monitor.

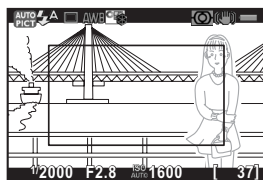

Example) The person is out of focus and the background is in focus instead.

### 4 Center the subject to focus on the monitor and press the shutter release button halfway.

The AF frame turns green when focused. The focus is locked while the AF frame is green.

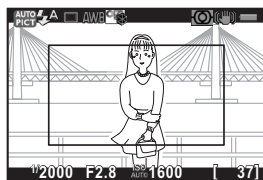

## 5 Recompose the picture while keeping the shutter release button pressed halfway.

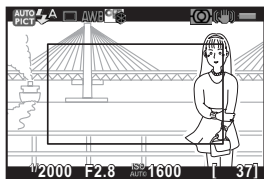

- Turning the zoom ring with the focus locked may cause the subject to be out of focus.
- You cannot lock the focus when the capture mode is set to (Moving Object)/ (Night Snap)/ (Pet)/ (Kids)/ (Stage Lighting) of **SCN** (Scene) mode. In such cases, the autofocus continues to focus on the subject until the shutter is released (Continuous Autofocus).

## Adjusting the Focus Manually (Manual Focus)

Manually adjust the focus.

### 1 Set [Focus Method] to MF.

Refer to "Setting the Focus Method" (p.86) for details.

### 2 While viewing the monitor, turn the focusing ring.

The shutter can be released by pressing the shutter release button fully even if the subject is not in focus.

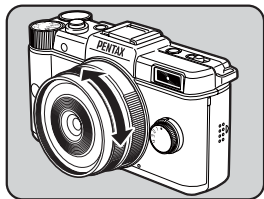

## Focusing with the Image Enlarged

You can more easily focus on the subject by enlarging the image in the center of the monitor during **MF** mode.

- 1 Select **[Focus Settings]** in the **[📷 Rec. Mode 1]** menu, and press the four-way controller (▶).

The [Focus Settings] screen appears.

- 2 Use the four-way controller (▲▼) to select **[MF Assist]**, and press the four-way controller (▶).

- 3 Set the magnification to **[Off]**, **[x2]**, or **[x4]**, and press the **OK** button.

The magnification can be changed with the e-dial while the image is enlarged.

- 4 Press the **MENU** button twice.

MF Assist is set and the camera is ready to take a picture.

- 5 Turn the focusing ring, or press the **OK** button.

The image on the monitor is enlarged.

- 6 Check that the subject is in focus.





### Available operations

E-dial to the right (Q)	Enlarges the image (up to 4 times).
E-dial to the left (☒)	Reduces the image (up to 1 times).
Four-way controller (▲▼◀▶)	Moves the area to enlarge.

If any button other than the four-way controller (▲▼◀▶) is pressed, or if no operations are made within 30 seconds, the camera returns to normal display.



You can check the depth of field by stopping down the aperture of the lens to the actually set value.

## Assigning the Preview Function to the Green Button

First, assign the Preview function to the / button.



- 1** Select [Green Button] in the [ Rec. Mode 3] menu, and press the four-way controller ().

The [Green Button] screen appears.

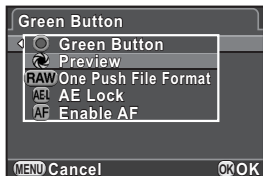
- 2** Press the four-way controller (), use the four-way controller (/) to select [Preview], and press the OK button.



- 3** Press the MENU button twice.

The Preview function is assigned to the / button and the camera is ready to take a picture.



## Displaying the Preview

- 1 View the subject on the monitor, and press the shutter release button halfway.**

The autofocus system operates.

- 2 Press the  button.**

You can check the depth of field on the monitor while the  button is pressed.

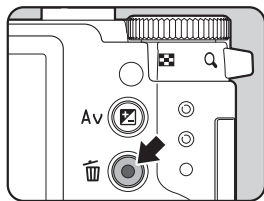

- 3 Take your finger off the  button.**

Preview is ended and the camera is ready to take a picture.

# Using the Shake Reduction Function to Prevent Camera Shake

## Taking Pictures Using the Shake Reduction Function

The Shake Reduction function reduces camera shake that occurs when the shutter release button is pressed. This is useful for taking pictures in situations where camera shake is likely to occur.

The Shake Reduction function works effectively when taking pictures in the following situations.

- When taking pictures in dimly lit locations, such as indoors, at night, on cloudy days and in the shade
- When taking telephoto pictures



- The Shake Reduction function does not compensate for blurring caused by subject movement. To take pictures of a moving subject, increase the shutter speed.
- The Shake Reduction function may not fully reduce camera shake when taking close-up shots. In this case, it is recommended to turn off the Shake Reduction function and use the camera with a tripod.
- The Shake Reduction function will not fully work when shooting with a very slow shutter speed, for example when panning or shooting night scenes. In this case, it is recommended to turn off the Shake Reduction function and use the camera with a tripod.

### **1** Press the **INFO** button in **Capture mode**.

The control panel appears.

### **2** Use the four-way controller (▲▼◀▶) to select [**Shake Reduction**], and press the **OK** button.

The [**Shake Reduction**] screen appears.

### 3 Use the four-way controller (◀▶) to select (☞) or (☞), and press the OK button.

The camera returns to the control panel.

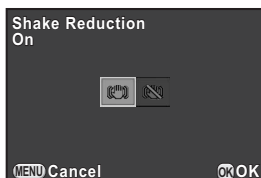

(☞)	Uses Shake Reduction. (default setting)
(☞)	Does not use Shake Reduction.

### 4 Press the shutter release button halfway.

(☞) appears on the monitor and the Shake Reduction function is activated.





Be sure to turn the Shake Reduction function off when using the camera with a tripod.





- You can also change the setting from the [Rec. Mode 3] menu (p.66).
- [Shake Reduction] is fixed to (☞) in the following situations.
  - Self-timer shooting
  - Remote Control shooting
  - when the shutter speed is set to **Bulb**
- [Shake Reduction] is fixed to (☞) when the capture mode is set to (🌃) (Night Scene HDR) or **HDR** (HDR) of **SCN** (Scene) mode.
- You can select whether to use the Shake Reduction function only when taking pictures or during standby mode as well with [4. Shake Reduction Options] (p.68) from the [C Custom Setting 1] menu.
- The Shake Reduction function will not fully work (for about 2 seconds) right after turning on the camera or restoring from Auto Power Off. Wait for the Shake Reduction function to work stably and properly, and then press the shutter button gently.
- The Shake Reduction function is available with any PENTAX Q-mount lens compatible with this camera.

## Shooting with Self-timer

This camera has the following two types of self-timers.



 Self-timer (12 sec.)	The shutter is released after about 12 seconds. Use this mode to include the photographer in the picture.
 Self-timer (2 sec.)	The shutter is released about 2 seconds after the shutter release button is pressed. Use this mode to avoid camera shake when the shutter release button is pressed.



The self-timer shooting is not available when the capture mode is set to  (Moving Object)/ (Pet)/ (Kids) of SCN (Scene) mode.

4

Shooting Functions

- 1** Mount the camera onto a tripod.
- 2** Press the four-way controller (▶) in Capture mode.  
The Drive Mode setting screen appears.
- 3** Use the four-way controller (◀▶) to select .
- 4** Press the four-way controller (▼), use the four-way controller (◀▶) to select  or , and press the OK button.

The camera is ready to take a picture.





- 5** Press the shutter release button halfway.

The autofocus system operates.



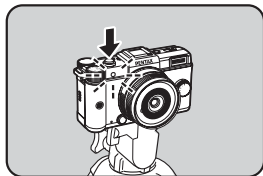

## 6 Press the shutter release button fully.

For , the self-timer lamp starts blinking slowly and then blinks rapidly 2 seconds before the shutter is released. The beep is heard and the rate increases. The shutter will be released about 12 seconds after the shutter release button is pressed fully.



For , the shutter will be released about 2 seconds after the shutter release button is pressed.





- Select a mode other than  or  in the Drive Mode setting screen to cancel the self-timer shooting. The setting is canceled when the camera is turned off if [Drive Mode] is set to  (Off) in [Memory] (p.195) of the  Rec. Mode 3] menu.
- The Shake Reduction function is automatically turned off when  or  is set.
- You can set the camera so that the beep does not sound. (p.186)

## Shooting with Remote Control (Optional)





The shutter can be released from a distance by using an optional remote control unit (p.230).

You can select from the following three shooting modes.

 Remote Control	The shutter is released immediately after the shutter release button on the remote control unit is pressed.
 Remote Control (3s delay)	The shutter is released about 3 seconds after the shutter release button on the remote control unit is pressed.
 Remote Continuous Shooting	Continuous shooting starts when the shutter release button on the remote control unit is pressed. Continuous shooting ends when the shutter release button on the remote control unit is pressed again.



The remote control shooting is not available in the following situations.

- when the capture mode is set to  (Moving Object)/ (Night Scene HDR)/ (Pet)/ (Kids)/**HDR** (HDR) or **SCN** (Scene) mode
- when the shutter speed is set to **Bulb**
- when HDR Capture is set

### 1 Mount the camera onto a tripod.

### 2 Press the four-way controller (▶) in Capture mode.

The Drive Mode setting screen appears.

### 3 Use the four-way controller (◀▶) to select .

### 4 Press the four-way controller (▼), use the four-way controller (◀▶) to select , or , and press the OK button.

The self-timer lamp on the front of the camera will blink and the camera is in a stand-by status.



### 5 Press the shutter release button halfway.

The autofocus system operates.

## 6 Point the remote control unit towards the remote control receiver on the front or back of the camera, and press the shutter release button on the remote control unit.

The maximum operating distance of the remote control unit is approximately 4 m from the front of the camera and approximately 5 cm from the back of the camera.

After a picture is taken, the card access lamp lights for 2 seconds and then returns to blinking.

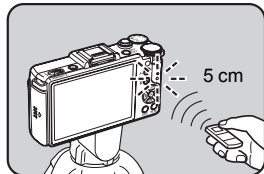
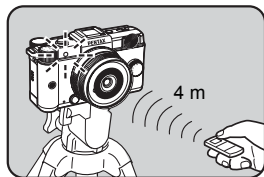



- By default, you cannot adjust the focus with the remote control unit. Focus on the subject first with the camera before operating with the remote control unit. When [9. AF with Remote Control] (p.68) is set to [On] in the [C Custom Setting 2] menu, you can use the remote control unit to adjust the focus.
- When using the Remote Control Waterproof O-RC1, the autofocus system can be operated with the  $\frac{1}{2}$  button. The **Fn** button cannot be used.
- Select a mode other than  $\bar{\bar{M}}$ ,  $\bar{\bar{S}}$  or  $\bar{\bar{A}}$  in the Drive Mode setting screen to cancel the remote control shooting. The setting is canceled when the camera is turned off if [Drive Mode] is set to  $\square$  (Off) in [Memory] (p.195) of the [Camera Rec. Mode 3] menu.
- The Shake Reduction function is automatically turned off when  $\bar{\bar{M}}$ ,  $\bar{\bar{S}}$  or  $\bar{\bar{A}}$  is set.
- The remote control shooting may not be available in backlit conditions.
- The Remote Control F can send a remote control signal about 30,000 times. Contact a PENTAX Service Center to replace the battery (this will involve a fee).



## Continuous Shooting

Pictures can be taken continuously while the shutter release button is kept pressed.

The following two types of continuous shooting are available.

 Continuous Shooting (Hi)	For JPEG images of $12\text{M}/\star\star\star$ , up to approximately 5 frames per second can be taken continuously. You can capture up to approximately 5 frames at once. Not available when [File Format] is set to [RAW] or [RAW+].
 Continuous Shooting (Lo)	For JPEG images of $12\text{M}/\star\star\star$ , up to approximately 1.5 frames per second can be taken continuously. You can capture up to approximately 100 frames at once.





- Continuous Shooting is not available in the following situations.
  - when the capture mode is set to  (Night Scene HDR) or **HDR** (HDR) or **SCN** (Scene) mode
  - when the shutter speed is set to **Bulb**
  - when HDR Capture is set
- You cannot save additional RAW images during Instant Review or playback when  or  is selected.
- The number of recordable images is reduced when [Aspect Ratio] is set to  $16:9$ ,  $3:2$ , or  $1:1$  instead of  $4:3$ .

### 1 Press the four-way controller (▶) in Capture mode.

The Drive Mode setting screen appears.

### 2 Use the four-way controller (◀▶) to select .



- 3** Press the four-way controller (▼), use the four-way controller (◀▶) to select  or , and press the OK button.

The camera is ready to take pictures continuously.











- 4** Press the shutter release button halfway.

The autofocus system operates.

- 5** Press the shutter release button fully.

Pictures are taken continuously while the shutter release button is fully pressed. Take your finger off the shutter release button to stop.



- The drive mode is fixed to  when the capture mode is set to  (Moving Object)/ (Pet)/ (Kids) of SCN (Scene) mode.
- The focus position is locked in the first frame.
- If [File Format] is changed to [RAW] or [RAW+] while  is selected, the shooting mode is temporarily changed to .
- The shutter cannot be released until charging is complete when using the built-in flash. You can set the camera to enable the shutter release before the built-in flash is ready in [11. Release While Charging] of the [C Custom Setting 2] menu. (p.60)
- Select a mode other than  or  in the Drive Mode setting screen to cancel the continuous shooting. The setting is canceled when the camera is turned off if [Drive Mode] is set to  (Off) in [Memory] (p.195) of the [Rec. Mode 3] menu.

## Interval Shooting

Takes pictures at a set interval from a set time.  
The following settings can be performed.

Interval	When taking two or more pictures, set the wait time until the next picture is taken from 1 second to 24 hours.
Number of Shots	Set the number of shots to be taken from 1 to 999. When [Start Interval] is set to [Now], you can select two or more pictures.
Start Interval	Select whether to take the first picture now or at a set time. Selecting [Now] starts recording immediately. When [Set Time] is selected, set [Start Time].
Start Time	Set the time at which to start shooting.

4



- Interval Shooting is not available in the following situations.
  - when the capture mode is set to (Movie) or **BC** (Blur Control) mode, or (Night Scene HDR)/ (Quick Macro)/**HDR** (HDR) of **SCN** (Scene) mode
  - when the shutter speed is set to **Bulb**
  - when Digital Filter is set
- Interval Shooting cannot be used with Exposure Bracketing or Multi-exposure at the same time. (The function selected last is used.)
- When HDR Capture (p.130) is set, the shooting interval cannot be set to 9 seconds or less.

**1** Select [Interval Shooting] in the [ Rec. Mode 2] menu, and press the four-way controller (▶).

The [Interval Shooting] screen appears.

**2** Use the four-way controller (▲▼) to select [Interval], and press the four-way controller (▶).

**3** Use the four-way controller (◀▶) to select hours, minutes, or seconds, and use the four-way controller (▲▼) to set the time.

Press the four-way controller (▶) to finish the setting.

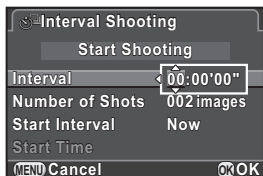

- 4** Use the four-way controller (▲▼) to select [Number of Shots], and press the four-way controller (▶).
- 5** Use the four-way controller (◀▶), and use the four-way controller (▲▼) to select the number of shots to be taken. Press the four-way controller (▶) to finish the setting.
- 6** Use the four-way controller (▲▼) to select [Start Interval], and press the four-way controller (▶).
- 7** Use the four-way controller (▲▼) to select [Now] or [Set Time], and press the OK button.  
If you selected [Now], proceed to Step 10.
- 8** Use the four-way controller (▲▼) to select [Start Time], and press the four-way controller (▶).
- 9** Use the four-way controller (◀▶) to select hours or minutes, and use the four-way controller (▲▼) to set the time.  
Press the four-way controller (▶) to finish the setting.
- 10** Use the four-way controller (▲▼) to select [Start Shooting], and press the OK button.  
The camera is ready to take a series of interval pictures.
- 11** Press the shutter release button halfway.  
The autofocus system operates.
- 12** Press the shutter release button fully.

When [Start Interval] is set to [Now], the first picture is taken. When set to [Set Time], shooting starts at the set time.

For shooting multiple pictures, pictures are taken at the interval set in Step 3.

After the set number of pictures is taken, the camera returns to normal Capture mode.





- Refer to “Interval Movie” (p.113) for information on how to perform interval shooting in (Movie) mode.
- If any of the following operations are performed while shooting, the pictures that have been already taken are saved and Interval Shooting is ended.
  - when the power switch is pressed
  - when the mode dial or quick dial is turned
- (Single Frame Shooting) is used regardless of the current drive mode setting.
- Although each shot taken is displayed on the monitor with Instant Review, they cannot be enlarged or deleted.
- If the Auto Power Off function turns the camera off before starting Interval Shooting, the camera automatically turns on again when the shooting time approaches.

## 4

## Shooting Functions



- When using Interval Shooting, use the AC adapter kit K-AC115 (optional) or install a fully charged battery. If the battery is not sufficiently charged, it may become depleted during Interval Shooting, and cause recording to stop.
- Interval Shooting is canceled when the SD Memory Card has no more available space.

## Multi-exposure

You can create a picture by taking multiple exposures and merging them into a single image.



- Multi-exposure is not available in the following situations.
  - when [File Format] is set to [RAW] or [RAW+]
  - when the capture mode is set to (Movie) or **BC** (Blur Control) mode, or (Night Scene HDR)/ (Quick Macro)/**HDR** (HDR) of **SCN** (Scene) mode
  - when Digital Filter or HDR Capture is set
- Multi-exposure cannot be used with Exposure Bracketing, Interval Shooting, or Distortion Correction at the same time. (The function selected last is used.)

**1** Select [Multi-exposure] in the [Rec. Mode 2] menu, and press the four-way controller (▶).

The [Multi-exposure] screen appears.

**2** Use the four-way controller (▲▼) to select [Number of Shots], and press the four-way controller (▶).

**3** Use the four-way controller (▲▼) to select the number of shots, and press the OK button.

Select from 2 to 9 shots.

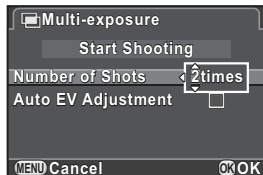



**4** Use the four-way controller (▲▼) to select [Auto EV Adjustment], and use the four-way controller (◀▶) to select  or .

When set to  (On), the exposure is adjusted automatically according to the number of shots.

**5** Use the four-way controller (▲▼) to select [Start Shooting], and press the OK button.

The camera is ready to take a series of interval pictures.



## 6 Take the picture.

The composite picture is displayed in Instant Review each time the shutter release button is pressed. Press the /  button during Instant Review to discard pictures taken up to that point and take pictures again from the first frame.

The pictures are saved when the set number of shots is taken, and then the screen in Step 3 appears again.



If any of the following operations are performed while shooting, the pictures that have been already taken are saved and Multi-exposure is ended.

- when the  button, **MENU** button, **INFO** button or four-way controller () is pressed
- when the mode dial or quick dial is turned

In this camera, you can record movies with the following format.

- Frame rate            30 fps
- Sound                 Monaural
- File format           MPEG-4 AVC/H.264

## Changing the Settings for Movie Recording

Settings for recording movies can be changed in the [ Movie] menu.

### 1 Set the mode dial to , and press the MENU button.

The [ Movie 1] menu appears.

Press the four-way controller (▶) once if you press the **MENU** button in any other capture mode.

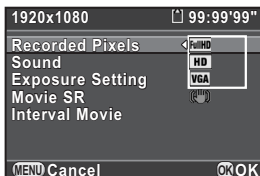

### 2 Press the four-way controller (▼), and then press the four-way controller (▶). Use the four-way controller (▲▼) to select the number of recorded pixels, and press the OK button.





Frame Size	Pixels	Aspect Ratio
(default setting)	1920×1080	
	1280×720	
	640×480	

When the number of recorded pixels is changed, the amount of recordable time for that setting appears at the top right of the screen.

### 3 Use the four-way controller (▲▼) to select [Sound], and press the four-way controller (▶).

- 4** Use the four-way controller (▲▼) to select  or , and press the OK button.



	Records sound. (default setting)
	Does not record sound.



- 5** Use the four-way controller (▲▼) to select [Exposure Setting], and press the four-way controller (▶).

- 6** Use the four-way controller (▲▼) to select [Auto] or [Manual], and press the OK button.

Auto	Takes pictures with auto exposure. (default setting)
Manual	Allows you to set the shutter speed, aperture value, and sensitivity.

- 7** Use the four-way controller (▲▼) to select [Movie SR], and press the four-way controller (▶).

- 8** Use the four-way controller (▲▼) to select  or , and press the OK button.

	Uses Shake Reduction. (default setting)
	Does not use Shake Reduction.

- 9** Press the MENU button.

The camera is ready to record a movie.



[Recorded Pixels], [Sound], and [Movie SR] can also be changed using the control panel.



## Recording Movies

### 1 Set the mode dial to .

The movie recording screen appears.



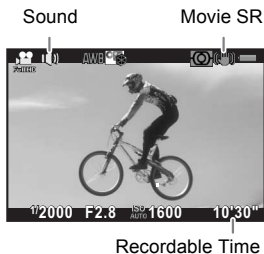

### 2 View the subject on the monitor.

Adjust the exposure when [Exposure Setting] is set to [Manual].



Recordable Time

#### Available operations

E-dial	Not available (when [Exposure Setting] is set to [Auto]) Adjusts the shutter speed (when [Exposure Setting] is set to [Manual]).
 Av button → e-dial	Adjusts the EV compensation value (when [Exposure Setting] is set to [Auto]). Adjusts the aperture value (when [Exposure Setting] is set to [Manual]).
 /  button	Calls the function set in [Green Button] of the [Rec. Mode 3] menu (p.144). Resets the exposure setting when [Exposure Setting] is set to [Manual] (if [Green Button] is assigned to the  /  button).

### 3 Press the shutter release button halfway.

The autofocus system operates.

When [Focus Method] is set to **MF**, turn the focusing ring until the subject is clearly visible on the focusing screen.

### 4 Press the shutter release button fully.

Movie recording starts.

### 5 Press the shutter release button again.

Movie recording stops.



- When [Sound] is set to (On), the camera operation sounds are also recorded. When recording a movie, mount the camera onto a tripod and do not operate the camera while recording.
- When recording a movie, regardless of the focus method setting, recording starts when the shutter release button is pressed fully even if the subject is not in focus.
- While recording a movie, the autofocus system does not operate.
- The flash is not available.
- When recording a movie using image processing, such as Digital Filter, some frames may be omitted from the recorded movie.
- If the internal temperature of the camera becomes high during movie recording, the recording may be terminated to protect the camera circuitry.



- You can record a movie continuously up to 4 GB or 25 minutes. When the SD Memory Card is full, recording stops and the movie is saved.
- The screen display in mode is set according to the [LCD View Options] (p.191) setting made in the [Rec. Mode 3] menu. However, the Bright/Dark Area warning is not displayed during movie recording.
- If you intend to record movies continuously for a long period, use of the AC adapter kit K-AC115 (optional) is recommended. (p.40)
- You can also use an optional remote control unit to record a movie. (p.100) Press the four-way controller ( ) in mode to display the screen for selecting on/off for the use of the remote control instead of the normal Drive Mode setting screen.

## Interval Movie

Takes still pictures one by one at a set interval from a set time and records them as a single movie file.

Perform the following settings.

Interval	Set the shooting interval to 1 sec., 5 sec., 10 sec., 30 sec., 1 min., 5 min., 10 min., 30 min., or 1 hour.
Recording Time	Set the time at which to start and stop recording from 5 seconds to 99 hours. The time that can be set varies depending on [Interval].
Start Interval	Select whether to take the first picture now or at a set time. Selecting [Now] starts recording immediately. When [Set Time] is selected, set [Start Time].
Start Time	Set the time at which to start shooting.



This mode is available only when the mode dial is set to .

- 1 Select [Interval Movie] in the [ Movie 1] menu, and press the four-way controller (▶).

The [Interval Movie] screen appears.

- 2 Use the four-way controller (▲▼) to select [Interval], and press the four-way controller (▶).

- 3 Use the four-way controller (▲▼) to select the shooting interval, and press the OK button.

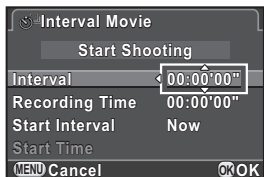

- 4 Use the four-way controller (▲▼) to select [Recording Time], and press the four-way controller (▶).

- 
- 5** Use the four-way controller (◀▶) to select hours, minutes, or seconds, and use the four-way controller (▲▼) to set the time.

Press the four-way controller (▶) to finish the setting.

- 
- 6** Use the four-way controller (▲▼) to select [Start Interval], and press the four-way controller (▶).

- 
- 7** Use the four-way controller (▲▼) to select [Now] or [Set Time], and press the OK button.

If you selected [Now], proceed to Step 10.

- 
- 8** Use the four-way controller (▲▼) to select [Start Time], and press the four-way controller (▶).

- 
- 9** Use the four-way controller (◀▶) to select hours or minutes, and use the four-way controller (▲▼) to set the time.

Press the four-way controller (▶) to finish the setting.

- 
- 10** Use the four-way controller (▲▼) to select [Start Shooting], and press the OK button.

After the message [Press the shutter release button to start interval shooting] appears, the monitor turns off.

- 
- 11** Press the shutter release button halfway.

The autofocus system operates.

- 
- 12** Press the shutter release button fully.

When [Start Interval] is set to [Now], a picture is taken immediately, Instant Review is displayed, and then the monitor display turns off. When the number of pictures set in [Number of Shots] has been taken, [Interval shooting complete] is displayed, and then the camera turns off.



- When recording with Interval Movie, use the AC adapter kit K-AC115 (optional) or install a fully charged battery. If the battery is not sufficiently charged, it may become depleted during recording and cause recording of the movie to stop.
- Interval Movie is canceled when the SD Memory Card has no more available space.

## Playing Back Movies

Recorded movies can be played back in Playback mode in the same manner as saved still pictures.

### 1 Use the four-way controller (◀▶) to select a movie to play back.

The first frame of the movie is displayed on the monitor.

### 2 Press the four-way controller (▲).

Movie playback starts.



#### Available operations

Four-way controller (▲)	Pauses/Resumes playback.
Four-way controller (▶)	Forwards a frame (when paused).
Press and hold four-way controller (▶)	Fast-forwards playback.
Four-way controller (◀)	Reverses a frame (when paused).
Press and hold four-way controller (◀)	Fast-reverses playback.
Four-way controller (▼)	Stops playback./ Displays the playback mode palette (when stopped). (p.152)
E-dial	Adjusts the volume (6 levels).
Av button	Saves the displayed image as a JPEG file (when paused) (p.116).

When the movie ends, playback stops and the first frame is displayed again.



- You can use the optional AV cable I-AVC7 or a commercially available HDMI cable to play back recorded movies on a TV screen or other AV devices. (p.168)
- QuickTime is required to play back movies transferred to a computer. (p.204)

## Capturing a Still Picture from a Movie

You can capture a single frame from a movie and save it as a JPEG still picture.

**1** Press the four-way controller (▲) in Step 2 on p.115.

**2** Use the four-way controller (◀▶) to display the frame to save as a still picture.

The frame number and total number of frames appear at the top right of the screen.

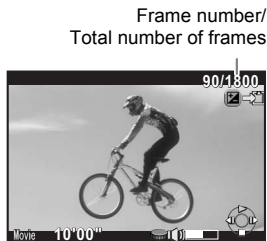

**3** Press the Av button.

The save confirmation screen appears.

**4** Use the four-way controller (▲▼) to select [Save as], and press the OK button.

The captured image is saved as a new image.

## Editing Movies

Movies can be divided and unwanted segments can be deleted.

- 1 In Playback mode, use the four-way controller (◀▶) to select a movie to edit.**

The first frame of the movie is displayed on the monitor.

- 2 Press the four-way controller (▼).**

The playback mode palette appears.

- 3 Use the four-way controller (▲▼◀▶) to select  (Movie Editing), and press the OK button.**

The movie editing screen appears.

- 4 Select point(s) where you want to divide the movie.**

The first frame at the dividing point is displayed at the top of the screen.

Up to four points can be selected.

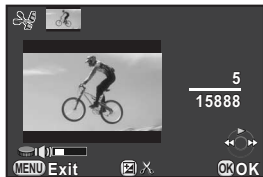

### Available operations

Four-way controller (▲)	Plays back/Pauses a movie.
Four-way controller (▶)	Forwards a frame (when paused).
Press and hold four-way controller (▶)	Fast-forwards playback.
Four-way controller (◀)	Reverses a frame (when paused).
Press and hold four-way controller (◀)	Fast-reverses playback.
E-dial	Adjusts the volume (6 levels).
 Av button	Confirms/cancels a dividing point.

Proceed to Step 8 if you do not delete any segment(s).

## 5 Press the button.

The screen to select segment(s) to delete is displayed.

## 6 Use the four-way controller ( ) to move the selection frame, and press the **OK** button.

The segment(s) to delete are specified.

Press the **OK** button again to cancel the selection.



## 7 Press the **MENU** button.

The screen that was displayed in Step 4 appears again.

## 8 Press the **OK** button.

The save confirmation screen appears.

## 9 Use the four-way controller ( ) to select [Save as], and press the **OK** button.

The movie is divided at the specified points and the unwanted segments are deleted from it. And then the divided movie is saved as separate files and displayed on the screen.

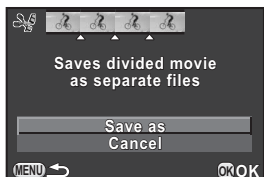

Specify the dividing points in chronological order from the beginning of the movie. When canceling the selected dividing points, cancel each of them in reverse order (from the end of the movie to the beginning). In an order other than specified, you can neither select the frames as a dividing point nor cancel the selections of the dividing point(s). You cannot, for example, select the frames prior to the last selected frame as a dividing point while specifying dividing point(s).



# 5 Shooting Settings

---

This chapter describes image file formats and camera operating settings in capture mode.

<b>Setting a File Format .....</b>	<b>120</b>
<b>Setting the White Balance .....</b>	<b>124</b>
<b>Adjusting Brightness .....</b>	<b>128</b>
<b>Setting the Image Finishing Tone .....</b>	<b>131</b>
<b>Setting the Green Button and E-dial Functions .....</b>	<b>144</b>
<b>Setting the Lens Functions .....</b>	<b>148</b>

# Setting a File Format

Set the aspect ratio, file format, number of recorded pixels, quality level, and color space of still pictures.

- 1** Select [Image Capture Settings] in the [Rec. Mode 1] menu, and press the four-way controller (▶).

The [Image Capture Settings] screen appears.

- 2** Use the four-way controller (▲▼) to select [Aspect Ratio], [File Format], [JPEG Recorded Pixels], [JPEG Quality] or [Color Space], and press the four-way controller (▶).

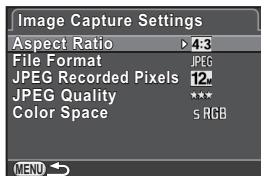

Refer to p.121 - p.123 for details about the settings.

- 3** Use the four-way controller (▲▼) to change the settings, and press the OK button.

- 4** Press the MENU button twice.



The screen that was displayed before selecting the menu appears again.





- The aspect ratio, file format, JPEG recorded pixels, and JPEG quality level can also be changed using the control panel.
- When the file format, JPEG recorded pixels, or JPEG quality level is changed, the number of images that can be recorded for that setting appears on the monitor.

## File Format





You can set the format of image files.

JPEG	Captures images in JPEG format. (default setting) You can change the number of recorded pixels in [JPEG Recorded Pixels], and the image quality level in [JPEG Quality].
RAW	The RAW format is a CMOS sensor output format saved without processing. RAW files are recorded with the general-purpose DNG (Digital Negative) format designed by Adobe Systems. Effects of White Balance, Custom Image and Color Space are not applied to the captured images, but they are saved as actual original information. When you perform the development process by using the RAW Development function (p.180), or using the provided software "SILKYPIX Developer Studio 3.0 for PENTAX" (p.208), you can create JPEG images with these effects.
RAW+	Captures images in both RAW and JPEG formats. When [One Push File Format] is assigned to the  button, you can press the  button to temporarily change the file format and save an image in both file formats. (p.145)







- When Digital Filter or HDR Capture is set, the file format is fixed to [JPEG] and cannot be changed. To change the file format, turn these functions off.
- When the capture mode is set to  (Night Scene HDR)/ (Quick Macro)/**HDR** (HDR) of **SCN** (Scene) mode, or **BC** (Blur Control) mode, the image is saved in JPEG format, regardless of the [File Format] setting.

## Aspect Ratio

Select the horizontal and vertical ratio of images from , ,  (default setting) or . The aspect ratio of the camera monitor is , so if a different aspect ratio is selected, the monitor display changes to match the set aspect ratio.



The number of recordable images available with continuous shooting is reduced when the aspect ratio is set to , , or  instead of .

## JPEG Recorded Pixels

Sets the recording size of images when [File Format] is set to [JPEG]. The selectable sizes vary according to the [Aspect Ratio] setting.

Aspect Ratio	Recorded Pixels	Pixels
16:9	9M	4000×2248 (default setting)
	6M	3456×1944
	4M	2688×1512
	2M	1920×1080
3:2	10M	4000×2664 (default setting)
	8M	3456×2304
	5M	2688×1792
	2M	1920×1280
4:3	12M	4000×3000 (default setting)
	9M	3456×2592
	5M	2688×2016
	3M	1920×1440
1:1	9M	2992×2992 (default setting)
	6M	2592×2592
	4M	2016×2016
	2M	1440×1440



- The more pixels there are, the bigger the file size. The file size will also vary according to the [JPEG Quality] setting.
- The quality of a captured image depends on the exposure control, resolution of the printer and a variety of other factors.

## JPEG Quality

You can set the image quality level (compression ratio). The default setting is ★★★ (Best).

★★★ Best		Quality: clearer    File size: larger
★★ Better		
★ Good		Quality: grainier    File size: smaller

## Color Space

You can select a color space to use.

sRGB	Mainly used for devices such as a computer. (default setting)
AdobeRGB	Covers a wider range of color than sRGB and is used for commercial uses such as industrial printing.



The file naming system changes depending on the color space setting as shown below.







For sRGB: IMGpxxxx.JPG

For AdobeRGB: \_IGPxxxx.JPG

"xxxx" indicates the file number and is displayed as a four-digit sequential number. (p.200)

# Setting the White Balance

White Balance is a function for adjusting the color of an image so that white objects appear white. Set the white balance if you are not satisfied with the color balance of pictures taken with white balance set to **AWB** (Auto), or to intentionally apply a creative effect to your images.

Item	Setting	Color Temperature *1
<b>AWB</b> Auto	Automatically adjusts the white balance. (default setting)	Approx. 4,000 to 8,000K
 Daylight	For use when taking pictures in sunlight.	Approx. 5,200K
 Shade	For use when taking pictures in the shade. It reduces the bluish color tones in a picture.	Approx. 8,000K
 Cloudy	For use when taking pictures on cloudy days.	Approx. 6,000K
 Fluorescent Light	For use when taking pictures under fluorescent lighting. Select the type of fluorescent light. <b>D</b> Fluorescent - Daylight Color <b>N</b> Fluorescent - Daylight White <b>W</b> Fluorescent - Cool White <b>L</b> Fluorescent - Warm White	Approx. 6,500K Approx. 5,000K Approx. 4,200K Approx. 3,000K
 Tungsten	For use when taking pictures under light bulbs or other tungsten light. It reduces the reddish color tones in a picture.	Approx. 2,850K
 <b>WB</b> Flash	For use when taking pictures using the built-in flash.	Approx. 5,400K
<b>CTE</b> *2	Use this to keep and strengthen the color tone of the light source in the image.	—
 Manual	Use this to manually adjust the white balance according to the lighting when taking pictures.	—

\*1 The color temperatures (K) shown above are all estimates. These do not indicate precise colors.

\*2 CTE = Color Temperature Enhancement



The white balance is fixed to **AWB** when the capture mode is set to **AUTO** (Auto Picture) or **SCN** (Scene) mode.

## 1 Press the four-way controller (▼) in Capture mode.

The White Balance setting screen appears.

After turning the power on, if you have taken any images before pressing the four-way controller (▼), the last image taken is displayed in the background.

## 2 Use the four-way controller (◀▶) to select the white balance.

When  (Fluorescent Light) is selected, press the four-way controller (▼) and use the four-way controller (◀▶) to select **D**, **N**, **W**, or **L**.



## 3 Press the OK button.

The camera is ready to take a picture.



Because the light source changes when a flash discharges, you can set the white balance for when the flash discharges. Select [Auto White Balance], [Unchanged] or [Flash] in [5. WB When Using Flash] (p.68) of the [C Custom Setting 1] menu.

## Adjusting the White Balance Manually

You can adjust the white balance depending on the light source when taking pictures. With the manual white balance, the camera can store delicate shades that cannot be precisely adjusted with the white balance preset values provided in the camera. This provides the optimum white balance for your surroundings.

## 1 Select in Step 2 on p.125.



**2** Under the light you wish to measure the white balance of, fully display a white sheet of paper on the monitor, or select a white area as the subject.

**3** Press the shutter release button fully.

Set [Focus Method] to **MF** when the shutter cannot be released.  
Adjust the white balance as necessary. (p.127)

**4** Press the **OK** button.

The camera is ready to take a picture.



- No image is recorded when the shutter release button is pressed to adjust the white balance.
- The message [The operation could not be completed correctly] appears when measuring is unsuccessful. Press the **OK** button while displayed to remeasure the white balance.
- If a picture is extremely overexposed or underexposed, the white balance may not be adjusted. In this case, adjust exposure to the correct exposure before adjusting the white balance.



## Fine-tuning the White Balance

You can fine-tune the white balance setting.

**1** Perform the desired setting in Step 2 on p.125.



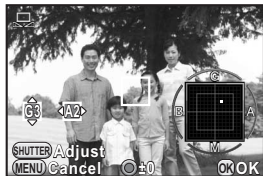

**2** Press the  **Av** button.

The fine-tuning screen appears.

**3** Fine-tune the white balance.



### Available operations

Four-way controller (▲▼)	Adjusts the tone of the colors between green (G) and magenta (M).
Four-way controller (◀▶)	Adjusts the tone of the colors between blue (B) and amber (A).
 /  button	Resets the adjustment value. (Available only when [Green Button] is assigned to the  /  button in [Green Button] of the  Rec. Mode 3] menu (p.144).)

**4** Press the **OK** button.

The camera returns to the White Balance setting screen.

**5** Press the **OK** button.

The camera is ready to take a picture.

Adjusts the brightness and reduces the occurrence of overexposed and underexposed areas.

## Highlight Correction

Expands the dynamic range and enables a wider range of tones by the CMOS sensor and reduces the occurrence of overexposed areas.

### 1 Press the INFO button in Capture mode.

The control panel appears.

### 2 Use the four-way controller (▲▼◀▶) to select [Highlight Correction], and press the OK button.

The [Highlight Correction] screen appears.

### 3 Use the four-way controller (◀▶) to select [Auto], [On] or [Off], and press the OK button.

The camera returns to the control panel.



- When [Highlight Correction] is set to [On], the minimum sensitivity is set to ISO 250.
- The selectable items are limited in the following shooting modes:
 

-  (Night Snap) or  (Stage Lighting)	
of SCN (Scene) mode	Fixed to [On]
- <b>M</b> (Manual) mode	[Auto] not available

## Shadow Correction

Expands the dynamic range and enables a wider range of tones by the CMOS sensor and reduces the occurrence of underexposed areas.

### 1 Press the INFO button in Capture mode.

The control panel appears.

### 2 Use the four-way controller (▲▼◀▶) to select [Shadow Correction], and press the OK button.

The [Shadow Correction] screen appears.

### 3 Use the four-way controller (◀▶) to select [Auto], [On] or [Off], and press the OK button.

The camera returns to the control panel.

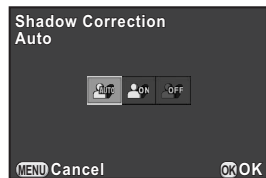

You can also set Highlight Correction and Shadow Correction in [D-Range Setting] (p.66) of the [Rec. Mode 2] menu.

## HDR Capture

Enables capturing images with high dynamic range. Takes three images (-3 EV underexposed, standard (proper exposure) and +3 EV overexposed) to create a single composite image with them.



- HDR Capture is not available in the following situations.
  - when [File Format] is set to [RAW] or [RAW+]
  - when the shutter speed is set to **Bulb**
  - when the capture mode is set to (Movie), **BC** (Blur Control) mode, or (Quick Macro) of **SCN** (Scene) mode
- When HDR Capture is set, the following functions are not available.
  - Continuous Shooting, Remote Continuous Shooting, or Exposure Bracketing
  - Flash modes other than (Flash Off)
  - Multi-exposure or Digital Filter (The function selected last is used)
- During HDR Capture, multiple images are combined together to create a single image, so it will take time to save an image.
- Make sure to hold the camera firmly so that it does not move while the three images are taken. If there is a great difference between the three images due to camera movement, the message [The operation could not be completed correctly] appears, and the image will not be saved.

### 1 Press the INFO button in Capture mode.

The control panel appears.

### 2 Use the four-way controller (▲▼◀▶) to select [HDR Capture], and press the OK button.

The [HDR Capture] screen appears.

### 3 Use the four-way controller (◀▶) to select [Off], [Auto], [HDR 1] or [HDR 2], and press the OK button.

The camera returns to the control panel.

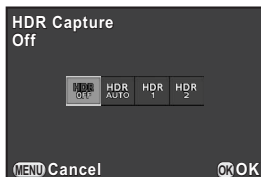

[HDR Capture] is fixed to [Auto] when the capture mode is set to (Night Scene HDR) or **HDR** (HDR) of **SCN** (Scene) mode.

Take pictures with settings to suit for your creative photographic vision.

## Setting Custom Image

Select the desired picture style from the following modes and enjoy taking pictures with a creative finishing tone.

Image Tone	Image
Bright	Saturation, hue, and contrast will be rather high to create a bright sharp image. (default setting)
Natural	Creates a natural look that is close to the actual color.
Portrait	Reproduces a healthy and bright skin tone.
Landscape	Increases color saturation, highlights shapes, and produces a vivid color image
Vibrant	Changes the color slightly to create an antique look.
Radiant	Emphasizes glossiness to produce a spectacular finish.
Muted	Reduces the saturation to create a soft look.
Bleach Bypass	Reduces the saturation and increases the contrast to create the look of an old picture.
Reversal Film	Creates a picture with strong image contrast as if taken with a reversal film.
Monochrome	Takes pictures using a B&W color filter.
Cross Processing	Intentionally changes the hue and contrast. The outcome varies each time a picture is taken.



Custom Image is not available when the capture mode is set to **SCN** (Scene) mode.

### 1 Press the **INFO** button in Capture mode.

The control panel appears.

- 2** Use the four way controller (▲▼◀▶) to select [Custom Image], and press the **OK** button.

The Custom Image setting screen appears.

After turning the power on, if you have taken any images before pressing the **OK** button, the last image taken is displayed in the background.

- 3** Use the four-way controller (▲▼◀▶) to select an image finishing tone.

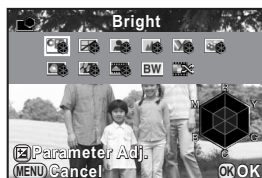

- 4** Press the **Av** button.

The screen to select a parameter appears.

- 5** Use the four-way controller (▲▼) to choose a parameter you want to change.



The following parameters can be changed according to the selected image finishing tone.

Image Tone	Parameter
Bright/Natural/Portrait/ Landscape/Vibrant/Radiant	Saturation: -4 to +4
	Hue: -4 to +4
	High/Low Key Adj: -4 to +4
	Contrast: -4 to +4
	Sharpness/Fine Sharpness: -4 to +4

Image Tone	Parameter
Muted/Bleach Bypass	Saturation: -4 to +4
	Toning: Off/Green/Yellow/Orange/Red/Magenta/Purple/Blue/Cyan
	High/Low Key Adj: -4 to +4
	Contrast: -4 to +4
	Sharpness/Fine Sharpness: -4 to +4
Reversal Film	Sharpness/Fine Sharpness: -4 to +4
Monochrome	Filter Effect: None/Green/Yellow/Orange/Red/Magenta/Blue/Cyan/Infrared Filter
	Toning: Off/Green/Yellow/Orange/Red/Magenta/Purple/Blue/Cyan
	High/Low Key Adj: -4 to +4
	Contrast: -4 to +4
	Sharpness/Fine Sharpness: -4 to +4
Cross Processing	Random/Preset 1-3/Favorite 1-3 *1

\*1 For [Favorite 1-3], you are required to save the settings of a cross processed image as a favorite in advance through the playback mode palette. (p.134)

## 6 Use the four-way controller (◀▶) to change the settings.

The background image changes according to the settings.  
You can check the saturation and hue with the radar chart.

### Available operations

E-dial	Switches between [Sharpness] and [Fine Sharpness]. (Not available in  mode.)
⊙/🗑️ button	Resets the set value.

## 7 Press the OK button.

The screen that was displayed in Step 3 appears again.

## 8 Press the OK button.

The camera returns to the control panel.



You can also change the settings from the [Rec. Mode 1] menu (p.65).

## Saving the Cross Processing Settings of a Captured Image

The outcome of cross processing varies each time a picture is taken. If you take a cross processed image that you like, you can save the Cross Processing settings used in that image. A total of three Cross Processing settings can be saved.

### 1 Press the four-way controller (▼) in Playback mode.

The playback mode palette appears.

### 2 Use the four-way controller (▲▼◀▶) to select (Save Cross Processing), and press the OK button.

The camera will search for cross processed images starting from the most recent image taken. (An hourglass icon is displayed while searching.) When a cross processed image is found, the screen to save the settings appears. If there are no cross processed images, the message [No cross processed image] appears.

### 3 Use the e-dial to select a cross processed image.



### 4 Use the four-way controller (▲▼) to select [Save as Favorite 1], [Save as Favorite 2] or [Save as Favorite 3], and press the OK button.

The settings of the selected image are saved to [Favorite 1 - 3] and the last displayed image is displayed again.



## Setting the Digital Filter

You can apply a filter effect when taking pictures. The following filters can be selected.

Filter Name	Effect	Parameter
Toy Camera	For taking pictures that look as if taken with a toy camera.	Shading Level: Low/Medium/High
		Blur: Low/Medium/High
		Tone Break: Red/Green/Blue/Yellow
High Contrast	For taking pictures with high contrasts.	Intensity: 1 to 5
Shading	For taking pictures with the background darkened.	Shading Type: 6 types
		Shading Level: -3 to +3
Slim	Changes the horizontal and vertical ratio of images.	-8 to +8
HDR	Creates an image that looks like a high dynamic range image.	Low/Medium/High
Invert Color	Inverts the colors in the image.	OFF/ON
Extract Color	For extracting two specific colors and making the rest of the image black and white.	Extracted Color 1: Red/Magenta/Blue/Cyan/Green/Yellow
		Extractable Range of Color 1: 1 to 5
		Extracted Color 2: OFF/Red/Magenta/Blue/Cyan/Green/Yellow
		Extractable Range of Color 2: 1 to 5
Color	For taking pictures with the selected color filter. Choose from 18 filters (6 colors × 3 tones).	Color: Red/Magenta/Blue/Cyan/Green/Yellow
		Color Density: Light/Medium/Dark
Water Color	For taking a picture that looks as though it was painted.	Intensity: Low/Medium/High
		Saturation: OFF/Low/Medium/High
Posterization	Lessens the tone of the image to create an image that looks as though it was hand-drawn.	Intensity: 1 to 5
Fish-eye	For taking pictures that look as if taken with a fish-eye lens.	Low/Medium/High



- Digital Filter is not available in the following situations.
  - when the capture mode is set to (Night Scene HDR)/ (Quick Macro)/**HDR** (HDR) of **SCN** (Scene) mode
  - when [File Format] is set to [RAW] or [RAW+]
- When Digital Filter is set, the following functions are not available.
  - Continuous Shooting, Interval Shooting or Multi-exposure
  - HDR Capture (The function selected last is used)
- Depending on the filter used, it may take longer to save images.

## 1 Press the **INFO** button in Capture mode.

The control panel appears.

## 2 Use the four-way controller (▲▼◀▶) to select [Digital Filter], and press the **OK** button.

The screen to select a filter appears.

After turning the power on, if you have taken any images before pressing the **OK** button, the last image taken is displayed in the background.

## 3 Use the four-way controller (▲▼◀▶) to select a filter.



## 4 Press the **Av** button.

The parameter setting screen appears.

- 5** Use the four-way controller (▲▼) to select a parameter, and the four-way controller (◀▶) to adjust the parameter's value.



- 6** Press the OK button.

The camera returns to the control panel.



- You can also change the settings from the [📷 Rec. Mode 1] menu (p.65).
- Select [Not use any filters] in Step 3 to finish shooting with digital filter.
- After shooting, you can also apply digital filter effects to JPEG/RAW images in Playback mode. (p.174)

## Saving Frequently Used Functions to the Quick Dial

You can save frequently used functions to the quick dial to easily load and use the desired settings when taking pictures.

Save up to four settings to each of the following functions.

- Smart Effect (p.140)
- Digital Filter (p.135)
- Custom Image (p.131)
- Aspect Ratio (p.121)



You can save only one of the above functions. You cannot assign multiple functions at the same time.

- 1** Select **[Quick Dial]** in the **[Rec. Mode 3]** menu, and press the four-way controller (▶).

The screen for setting the quick dial function appears.

- 2** Use the four-way controller (◀▶) to select the function to save.

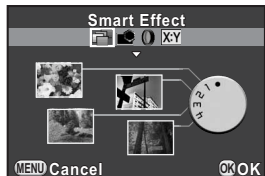

- 3** Use the four-way controller (▲▼) to select the position 1-4 of the quick dial to which to save the function.
- 4** Use the four-way controller (◀▶) to select the setting.

To make detailed settings for Smart Effect, press the **Av** button.

---

**5 Repeat Steps 3 and 4.**

Save the settings for the other positions in the same way.

---

**6 Press the OK button.**

The setting assigned to each position is saved.

---

**7 Press the MENU button.**

The screen that was displayed before selecting the menu appears again.

---

**Loading Settings for Taking Pictures**

You can take pictures with the settings saved in the quick dial, and while using the quick dial, these settings have priority over the settings such as ones made through the menus.

---

**1 In Capture mode, turn the quick dial to select the position 1 to 4.**

The saved setting is loaded, and the camera is ready to take a picture.

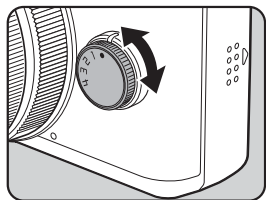

---

**2 Take the picture.**

---

**3 After taking pictures, return the quick dial to the position 0.**

The camera returns to the original setting.



You cannot use the menus to change the settings when taking pictures with the quick dial. To change the settings of the quick dial, save other settings again.

## Setting the Smart Effect

You can set and capture images with a variety of effects. Select from the following types of effects.

- Brilliant Color
- Uicolor Bold
- Vintage Color
- Cross Processing
- Warm Fade
- Tone Expansion
- Bold Monochrome
- Water Color
- Vibrant Color Enhance
- USER 1 to 3 (p.142)

**1** Select [Smart Effect] in Step 2 on p.138.

**2** Use the four-way controller (▲▼) to select the position 1-4 of the quick dial to which to save the setting.

**3** Press the  Av button.

The screen for making detailed Smart Effect settings appears.

**4** Use the four-way controller (▲▼◀▶) to choose an effect.

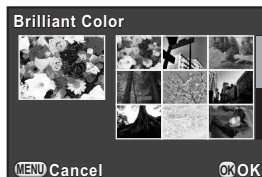

**5** Press the OK button.

The camera returns to the screen for setting the quick dial function.

**6** Repeat Steps 2 to 5.

**7** Press the OK button.

The settings are saved.

## 8 Press the MENU button.

The screen that was displayed before selecting the menu appears again.

### Shooting with Smart Effect

#### 1 Turn the quick dial to select the position 1 to 4.

The Smart Effect settings are loaded, and the camera is ready to take a picture.

#### 2 Press the four-way controller (▼) to change the settings.

The parameter setting screen appears.

#### 3 Use the four-way controller (◀▶) to change the parameters.



The following parameters can be changed depending on the selected effect.

Effect	Parameter
Brilliant Color/Cross Processing// Warm Fade/Tone Expansion/Bold Monochrome/Water Color//Vibrant Color Enhance	Intensity: 2 levels
Unicolor Bold	Extracted Color: Red/Magenta/Blue/ Cyan/Green/Yellow
Vintage Color	Type: 3 types

#### 4 Press the OK button.

The camera is ready to take a picture.

## Saving the Camera Settings

You can save the current camera settings and retrieve them later on by the quick dial operation.

- 1 **Set necessary settings.**
- 2 **Select from USER 1 to 3 in Step 4 on p.140.**



- 3 **Press the button.**  
The save confirmation screen appears.
- 4 **Use the four-way controller (▲▼) to select [Save Settings], and press the OK button.**

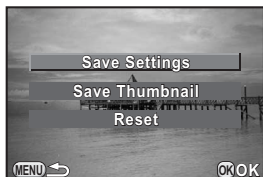

- 5 **Use the four-way controller (▲▼) to select [Save], and press the OK button.**

The settings are saved, and the screen that was displayed in Step 2 appears again.

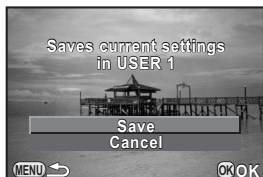



## Saving a Thumbnail Image to the USER Mode

If you take an image that you like, you can save the image along with the settings used in that image to make it even easier to take pictures.

- 1** Select from **USER 1** to **3** for which settings were saved on the screen in **Step 2** on p.142.

- 2** Press the **⊙/🗑** button.

The save confirmation screen appears.

- 3** Use the four-way controller (**▲▼**) to select **[Save Thumbnail]**, and press the **OK** button.

The image selection screen appears.

- 4** Turn the e-dial to choose an image.

You can select from any of the captured images.

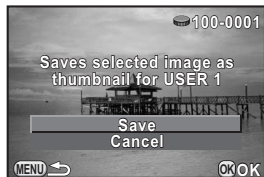



- 5** Use the four-way controller (**▲▼**) to select **[Save]**, and press the **OK** button.

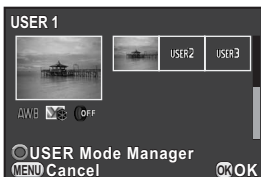







The image is saved and displayed in an image list.



# Setting the Green Button and E-dial Functions

## Setting the Green Button Operation

You can assign one of the following functions to the / button and access the function by simply pressing the button when shooting.

Green Button	Resets the values being adjusted. (default setting)
Preview	While the  /  button is pressed, you can check the depth of field by stopping down the aperture to the set value. (p.94)
One Push File Format	Temporarily changes the file format. Simultaneously saves an image in both JPEG and RAW formats, regardless of the [File Format] setting. You can set whether to apply the setting to only one image or not, and select the file format when the  /  button is pressed. (p.145)
AE Lock	The exposure setting is locked when the  /  button is pressed. (p.82)
Enable AF	Autofocus is performed only when the  /  button is pressed and not when the shutter release button is pressed halfway. (p.90)

- 1 Select [Green Button] in the [Rec. Mode 3] menu, and press the four-way controller (▶).**

The [Green Button] screen appears.

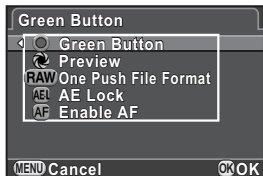

- 2 Press the four-way controller (▶), use the four-way controller (▲▼) to select a function, and press the OK button.**









- 3 Press the MENU button twice.**

The screen that was displayed before selecting the menu appears again.



## Setting the One Push File Format





When [One Push File Format] is assigned to the / button, specify the function settings.

- 1 Select [One Push File Format] in Step 2 on p.144.
- 2 Use the four-way controller ( ) to select [Cancel after 1 shot], and use the four-way controller ( ) to select  or .

<input checked="" type="checkbox"/>	The recording format returns to the original file format after a picture is taken. (default setting)
<input type="checkbox"/>	The setting is canceled when any of the following operations are performed. <ul style="list-style-type: none"> <li>- the / button is pressed again</li> <li>- the  button, <b>MENU</b> button or power switch is pressed</li> <li>- the mode dial is turned</li> </ul>

- 3 Use the four-way controller ( ) to choose a file format.

The left side is the [File Format] (p.121) setting and the right side is the file format when the / button is pressed.

- 4 Press the four-way controller () , use the four-way controller ( ) to select a file format that is used when the / button is pressed, and press the OK button.

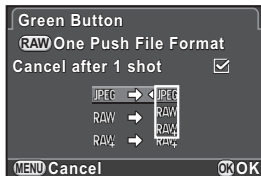

- 5 Press the MENU button twice.

The screen that was displayed before selecting the menu appears again.

## Setting the E-dial Operation in P Mode

Set the value to be changed with the e-dial when the capture mode is set to **P** (Program) mode.

- 1 Select [Green Button] in Step 2 on p.144.
- 2 Use the four-way controller (▲▼) to select [E-dial in Program], and press the four-way controller (▶).
- 3 Use the four-way controller (▲▼) to select the value to be changed with the e-dial, and press the OK button.

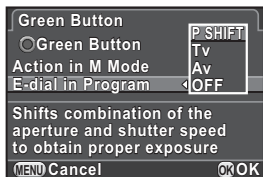

P SHIFT	Automatically adjusts the shutter speed and aperture value to obtain a proper exposure (Program shift). (default setting)
Tv	Sets the shutter speed.
Av	Sets the aperture value.
OFF	Disables the e-dial operation when turned in <b>P</b> mode.



- 4 Press the **MENU** button twice.







The screen that was displayed before selecting the menu appears again.





If the button is pressed after turning the e-dial in **P** mode, the settings return to normal **P** mode.

## Setting the Green Button Operation in M Mode

You can set the function of the / button when the capture mode is set to **M** (Manual) mode.

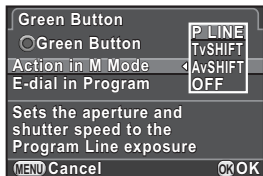
- 1 Select [Green Button] in Step 2 on p.144.
- 2 Use the four-way controller ( ) to select [Action in M Mode], and press the four-way controller () .
- 3 Use the four-way controller ( ) to select a function to assign to the / button, and press the OK button.



P LINE	Adjusts the aperture value and shutter speed to obtain a proper exposure according to the Program Line. (default setting)
Tv SHIFT	Adjusts the shutter speed while the aperture value remains fixed to obtain a proper exposure.
Av SHIFT	Adjusts the aperture value while the shutter speed remains fixed to obtain a proper exposure.
OFF	Disables the  /  button operation when pressed in <b>M</b> mode.

- 4 Press the MENU button twice.

The screen that was displayed before selecting the menu appears again.

You can set the lens functions. Depending on the type of the lens attached, available functions differ.

## Setting the ND Filter

Sets whether to use the ND filter built-in to the lens.

### 1 Press the INFO button in Capture mode.

The control panel appears.

### 2 Use the four-way controller (▲▼◀▶) to select [ND Filter], and press the OK button.

The [ND Filter] screen appears.

### 3 Use the four-way controller (◀▶) to select [Off] or [On], and press the OK button.

The camera returns to the control panel.



- You can also change the setting from the [📷 Rec. Mode 1] menu (p.65).
- This function is fixed to [Off] when an ND filter is not built in to the lens.

## Correcting Lens Distortion

Reduces lens distortions occurring due to lens properties.

**1** Select [Distortion Correction] in the [CAMERA] menu, and press the four-way controller (▶).

**2** Use the four-way controller (▲▼) to select [On] or [Off], and press the OK button.

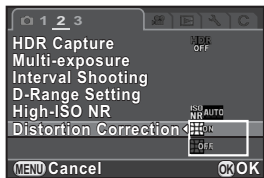

**3** Press the MENU button.

The screen that was displayed before selecting the menu appears again.



The effects of the Distortion Correction function may be barely noticeable in some cases depending on the shooting conditions and other factors.

**Memo**



# 6 Playback Functions

---

This chapter describes how to use the various playback functions.

<b>Playback Functions Operation .....</b>	<b>152</b>
<b>Setting the Playback Display Method .....</b>	<b>154</b>
<b>Enlarging Images .....</b>	<b>155</b>
<b>Displaying Multiple Images .....</b>	<b>156</b>
<b>Playing Back Images Continuously .....</b>	<b>162</b>
<b>Displaying Rotated Images .....</b>	<b>164</b>
<b>Deleting Multiple Images .....</b>	<b>165</b>
<b>Connecting the Camera to an AV Device .....</b>	<b>168</b>

Make settings related to playing back images in the playback mode palette or [▶ Playback] menu.



For details on how to use the menus, refer to "Using the Menus" (p.32).



## Playback Mode Palette Items

Press the four-way controller (▼) in Playback mode to display the playback mode palette.

You can display the playback mode palette even when a movie is paused.



Item	Function	Page
Image Rotation *1	Displays the rotated image.	p.164
Digital Filter *1	Changes the color tone of images, adds softening and slimming effects, or adjusts the brightness.	p.174
Red-eye Edit *1 *2	Corrects images of a subject captured with red eyes.	p.179
Resize *1 *2	Changes the number of recorded pixels or size of the image, and saves the image as a new file.	p.172
Cropping *1	Crops out only the desired area of the picture and saves it as a new image.	p.173
Index *1	Joins a number of images together and creates a new image with them.	p.160
Protect	Protects images from being accidentally erased.	p.199
Slideshow	Plays back the images one after another.	p.163
Save Cross Processing	Saves the settings for an image captured in Cross Processing mode in Custom Image to Favorite.	p.134
RAW Development *1	Converts RAW images to JPEG format.	p.180

Item	Function	Page
 Movie Editing *3	Divides a movie and extracts segments from it.	p.117
 Image Comparison *1	Displays two images side-by-side.	p.159
 DPOF *1 *2	Sets the DPOF settings.	p.201

\*1 This cannot be performed when a movie is displayed.

\*2 This cannot be performed when a RAW image is displayed.

\*3 This can be performed only when a movie is displayed.

## Playback Menu Items

You can perform the following settings in the [ Playback] menu.

Press the **MENU** button in Playback mode to display the [ Playback 1] menu.

Menu	Item	Function	Page
 1	Slideshow	Plays back the images one after another. You can set how images will be displayed in the slideshow.	p.162
	Quick Zoom	Sets the initial magnification when enlarging images.	p.154
	Bright/Dark Area	Sets whether or not to display the Bright/Dark Area warning during playback.	
	Delete All Images	You can delete all saved images at once.	p.167

# Setting the Playback Display Method

You can set the initial magnification when enlarging images, and whether to display the Bright/Dark Area warning in Playback mode.

**1** Select [Quick Zoom] in the [ Playback 1] menu, and press the four-way controller (▶).

**2** Use the four-way controller (▲▼) to select the magnification, and press the OK button.

Select from [Off] (default setting), [x2], [x4], [x8] or [x16].



**3** Use the four-way controller (▲▼) to select [Bright/Dark Area], and use the four-way controller (◀▶) to select  or .

When set to , bright portions blink red and dark portions blink yellow.

**4** Press the MENU button.

The screen that was displayed before selecting the menu appears again.



The Bright/Dark Area warning is not displayed in RGB histogram display and Detailed information display.

Images can be enlarged up to 16 times in Playback mode.

**1** Use the four-way controller (◀▶) to select an image in Playback mode.

**2** Turn the e-dial to the right (toward 🔍).

The image enlarges at each click (1 to 16 times).



### Available operations

E-dial to the right (🔍)	Enlarges the image (up to 16 times).
E-dial to the left (🔍)	Reduces the image (up to 1 times).
Four-way controller (▲▼◀▶)	Moves the area to enlarge.
<b>OK</b> button	Returns a position of the enlarged display area to the center (when the enlarged display area has been moved to the side).
<b>INFO</b> button	Switches information display On/Off.



- You can enlarge the image by following the same procedure during Instant Review (p.55). (**INFO** button is not available.)
- The default setting for the first click (minimum magnification) is 1 times. You can change this in [Quick Zoom] of the [▶ Playback 1] menu. (p.154)
- The initial full display of vertical images is displayed with a magnification of 0.675 times that of horizontal images, therefore, magnification at the first click starts at 1.0 times.

## Multi-image Display Screen

You can display 4, 9, 20, 42 or 90 thumbnail images on the monitor at the same time. The default setting is nine image-display.

### 1 Turn the e-dial to the left (toward ) in Playback mode.

The multi-image display screen appears.

Up to nine thumbnail images will be displayed at once (default setting).

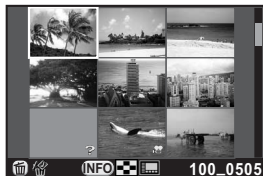



#### Available operations

Four-way controller (▲▼◀▶) Moves the selection frame.

**INFO** button Displays the [Multi-Img Display Setting] screen.





(Display Type cannot be selected when developing multiple RAW images (p.182).)

 /  button Selects and deletes multiple images. (p.165)

### 2 Press the OK button.

A full screen display of the selected image appears.



Icons such as  and  are not displayed with thumbnail images for 90-image display.

## Displaying Images by Folder

Images will be grouped and displayed by folder in which they are saved.

- 1 In the multi-image display screen, turn the e-dial to the left (toward ) again.**

The folder display screen appears.

The number of images saved in the selected folder appears at the top right of the screen.



### Available operations

Four-way controller (▲▼◀▶) Moves the selection frame.

⊙/🗑 button Deletes the selected folder. (p.166)

- 2 Press the OK button.**

The multi-image display screen for the selected folder appears.

## Displaying Images by Shooting Date (Calendar Display)

Images will be grouped and displayed by the shooting date.

### 1 In the multi-image display screen, press the INFO button.

The [Multi-Img Display Setting] screen appears.

### 2 Press the INFO button again.

The calendar display screen appears.  
Only the dates when pictures were taken are displayed.



#### Available operations

Four-way controller (▲▼)	Selects a shooting date.
Four-way controller (◀▶)	Selects an image taken on the selected shooting date.
E-dial to the right (Q)	Displays the selected image at full screen. Turn to the left (☒) to return to the calendar display.
INFO button	The camera returns to the multi-image display screen.
⊙/🗑 button	Deletes selected images.

### 3 Press the OK button.

A full screen display of the selected image appears.



## Comparing Images

You can display two images side-by-side.

### 1 Press the four-way controller (▼) in Playback mode.

The playback mode palette appears.



### 2 Use the four-way controller (▲▼◀▶) to select (Image Comparison), and press the OK button.

The last image displayed will be displayed twice side-by-side.

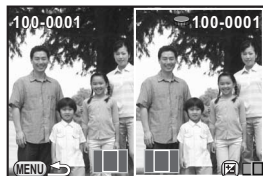
### 3 Select two images you want to compare using the e-dial, and compare them at left and right.



#### Available operations

 Av button	Moves the selection frame (right image, both images, and left image).
E-dial	Displays the previous or next image (when the selection frame is placed on the left or right image). Enlarges or reduces both images simultaneously at the same magnification from 1 to 16 times (when the selection frames are placed on both images).
Four-way controller (▲▼◀▶)	Moves the enlarged area.
OK button	Returns a displayed area of the enlarged area to the center (while moving the enlarged area).
 /  button	Deletes the selected image (when the selection frame is placed on the left or right image).
INFO button	Switches information display On/Off.

### 4 Press the MENU button.

The camera returns to the normal Playback mode.

## Joining Multiple Images (Index)

Join a number of images together and display them as an index print. You can also save the displayed index print as a new image. You can have the camera select the images to include or you can select the images to include in the index print, and the images will be randomly arranged or displayed by file number depending on the layout selected.







### 1 Press the four-way controller (▼) in Playback mode.

The playback mode palette appears.

### 2 Use the four-way controller (▲▼◀▶) to select (Index), and press the OK button.

The Index setting screen appears.

### 3 Press the four-way controller (▶), use the four-way controller (▲▼) to select a layout, and press the OK button.

You can select  (Thumbnail),  (Square),  (Random1),  (Random2),  (Random3) or  (Bubble).

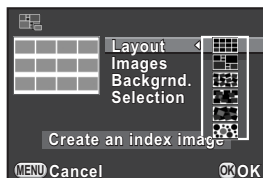

Images are displayed according to the file number (from the smallest number) for , and are displayed in random order for other layouts.

### 4 Use the four-way controller (▲▼) to select [Images], and press the four-way controller (▶).

### 5 Use the four-way controller (▲▼) to select the number of images, and press the OK button.

You can select 12, 24 or 36 images.

When the number of saved images is smaller than the number selected, empty spaces will appear when [Layout] is set to  and some images may be duplicated for other layouts.



**6** Use the four-way controller (▲▼) to select [Backgrnd.], and press the four-way controller (▶).

**7** Use the four-way controller (▲▼) to select the background color, and press the OK button.

You can select a white or black background.

**8** Use the four-way controller (▲▼) to select [Selection], and press the four-way controller (▶).



**9** Use the four-way controller (▲▼) to select a type of image selection, and press the OK button.

 All images	Picks images automatically from all of the images saved.
 Manual	Individually select images you want to include in the index. Continue by selecting [Select image(s)] and select the individual images.
 Folder name	Picks images automatically from the folder selected. Continue by selecting [Select a folder] and select the folder.

**10** Use the four-way controller (▲▼) to select [Create an index image], and press the OK button.

The index image is created and a confirmation screen appears.

**11** Use the four-way controller (▲▼) to select [Save] or [Reshuffle], and press the OK button.

Save	The index image is saved as a  and  file.
Reshuffle	Reselects the images to be included in the index and displays a new index image. However, if  (Thumbnail) is selected for [Layout], this item is not displayed.

After the index image is saved, the camera returns to Playback mode and the index image is displayed.



Processing may take a while when creating an index image.

You can play back all images saved on your SD Memory Card successively in the slideshow.

## Setting the Slideshow Display

Sets how images will be displayed during Slideshow.

- 1** Select [Slideshow] in the [▶ Playback 1] menu, and press the four-way controller (▶).

The Slideshow setting screen appears.

- 2** Use the four-way controller (▲▼) to select an item you want to change.

The following items can be changed.

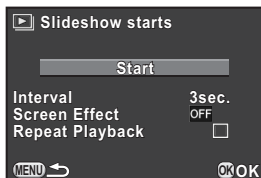

Item	Description	Setting
Interval	Select an image display interval.	3sec. (default setting)/ 5sec./10sec./30sec.
Screen Effect	Select a transition effect when the next image is displayed.	Off (default setting)/Fade/ Wipe/Shrink
Repeat Playback	Set whether to start the slideshow again from the beginning after the last image is displayed.	<input type="checkbox"/> (default setting)/ <input checked="" type="checkbox"/>

- 3** Press the four-way controller (▶), use the four-way controller (▲▼) to change the setting, and press the OK button.

## Starting the Slideshow

- 1** Select [Start] in Step 2 on p.162, and press the **OK** button. Or, select  (Slideshow) in the playback mode palette, and press the **OK** button.

The start screen is displayed and the slideshow begins.



### Available operations

---

**OK** button                      Pauses/resumes playback.

---

Four-way controller (◀) Shows the previous image.

---

Four-way controller (▶) Shows the next image.

---

Four-way controller (▼) Stops playback.

---

- 2** Stop the slideshow.

Slideshow ends when one of the following operations is performed during playback or pause.

- the four-way controller (▼) is pressed \*1
- the  button is pressed \*1
- the **MENU** button is pressed \*1
- the shutter release button is pressed \*2
- the mode dial is turned \*2

\*1 After slideshow ends, the camera switches to normal Playback mode.

\*2 After slideshow ends, the camera switches to Capture mode.



For movies, only the first frame is displayed and then the next image is displayed after the set interval has elapsed. To play a movie during a slideshow, press the **OK** button while the first frame is displayed. After the playback of the movie is finished, the slideshow will resume.

# Displaying Rotated Images

You can change the rotation information of an image and save it. Images with changed image rotation information are displayed at the changed orientation during playback.



- You cannot change the rotation information of the following images.
  - Protected images
  - Images without a rotation information tag
- Movie files cannot be rotated.

## 1 Select the image you want to rotate in Playback mode, and press the four-way controller (▼).

The playback mode palette appears.

## 2 Use the four-way controller (▲▼◀▶) to select (Image Rotation), and press the OK button.

The selected image is rotated in 90° increments and the four thumbnail images are displayed.

## 3 Use the four-way controller (▲▼◀▶) to select the desired rotation direction, and press the OK button.

The image rotation information is saved.

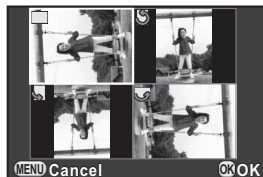

You can delete multiple images at once. Be aware that deleted images cannot be restored.

Protecting Images from Deletion (Protect) (p.199)

## Deleting Selected Images

You can delete multiple images in the multi-image display at once.



- Protected images cannot be selected.
- You can select up to 100 images at a time.

### 1 Turn the e-dial to the left (toward ) in Playback mode.

The multi-image display screen appears.

### 2 Press the button.

The screen to select images to delete is displayed.

The screen temporarily changes to 42-image display when [Multi-Image Display Setting] (p.156) is set to 90-image display.

### 3 Select the images to delete.



#### Available operations

Four-way controller Moves the selection frame.

(▲▼◀▶)

**OK** button Confirms/cancels the deletion of a selected image.

E-dial Displays a full screen display of the selected image.  
(Use the four-way controller (◀▶) to display the previous or next image.)

**4 Press the  button.**

The delete confirmation screen appears.

**5 Use the four-way controller ( ) to select [Select & Delete], and press the OK button.**





The selected images are deleted.

## Deleting a Folder



You can delete a selected folder and all the images in it.

**1 Turn the e-dial two clicks to the left (toward ) in Playback mode.**



The folder display screen appears.

**2 Use the four-way controller (   ) to select a folder to delete, and press the  button.**

The folder delete confirmation screen appears.

**3 Use the four-way controller ( ) to select [Delete], and press the OK button.**

The selected folder and all images in it are deleted.

The confirmation screen appears when there are protected images. Use the four-way controller ( ) to select [Delete All] or [Leave All] and press the **OK** button.

When [Delete All] is selected, protected images are also deleted.



## Deleting All Images

You can delete all saved images at once.

- 1** Select **[Delete All Images]** in the **[▶ Playback 1]** menu, and press the four-way controller (**▶**).

The confirmation screen for deleting all images is displayed.

- 2** Use the four-way controller (**▲ ▼**) to select **[Delete All Images]**, and press the **OK** button.

All images are deleted.

The confirmation screen appears when there are protected images. Use the four-way controller (**▲ ▼**) to select **[Delete All]** or **[Leave All]** and press the **OK** button.

When **[Delete All]** is selected, protected images are also deleted.

# Connecting the Camera to an AV Device

You can connect the camera to a TV or other device with a video input terminal or HDMI input terminal and play back images.



- For an AV device with multiple video input terminals, check the operating manual of the AV device, and select a suitable video input terminal for connecting the camera.
- You cannot output composite and HDMI video signals at the same time.
- While the camera is connected to an AV device, nothing is displayed on the camera monitor. Also, you cannot adjust the volume on the camera. Adjust the volume on the AV device.
- If you intend to use the camera continuously for a long period, use of the AC adapter kit K-AC115 (optional) is recommended. (p.40)

## Connecting the Camera to a Video Input Terminal or HDMI Input Terminal

Provide a cable according to the terminal of the device to which you connect.

Terminal of AV Device	Cable Used
Video terminal	AV cable I-AVC7 (optional)
HDMI terminal	HDMI cable with an HDMI terminal (Type D) (sold separately)

**1 Turn the AV device and camera off.**

**2 Open the terminal cover of the camera, and connect the cable to the PC/AV terminal or HDMI terminal.**

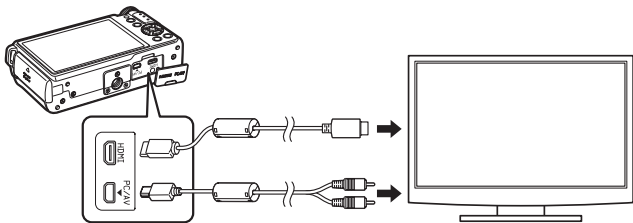

---

**3** Connect the other end of the cable to the video input terminal on the AV device.

---

**4** Turn the AV device and camera on.

The camera turns on in video mode or HDMI mode, and the camera information is displayed on the screen of the connected AV device.



When using the video output, images/movies are output at normal resolution regardless of the resolution supported by the AV device. To output HD video, use the HDMI output or transfer to and play back on a computer.

## Setting the Video/HDMI Output Format

Set the video/HDMI output format according to the connected terminal. Normally, the default output format setting does not have to be changed. However, if it fails to play back images/movies properly, change the setting.



To change the setting, remove the cable first before proceeding.

## Selecting the Video Output Format

When the hometown is set at the time of initial setting (p.48), the video output format is set in accordance with that region. Depending on the country or region, images/movies may fail to be played back with the set video output format. If this happens, change the setting.

---

**1** Select [Video Out] in the [ Set-up 2] menu, and press the four-way controller (▶).

---

**2** Use the four-way controller (▲▼) to select [NTSC] or [PAL], and press the OK button.

---

**3** Press the MENU button.

The screen that was displayed before selecting the menu appears again.



The video output format differs depending on the region. When you set [Setting the Time] in the World Time setting (p.187) to (Destination), the video output setting changes to the video output format for that city. Refer to "List of World Time Cities" (p.189) for cities that can be selected as a hometown or destination.

## Selecting the HDMI Output Format

By default, the maximum resolution is automatically selected to suit the AV device and camera. However, if it fails to play back images/movies properly, change the setting.

- 1** Select [HDMI Out] in the [ Set-up 2] menu, and press the four-way controller ().
- 2** Use the four-way controller ( ) to select the HDMI output format, and press the OK button.

Auto	The maximum resolution corresponding to the AV device and camera is automatically selected. (default setting)
1080i	1920×1080i
720p	1280×720p
480p 576p	720×480p (when [Video Out] is set to [NTSC]) 720×576p (when [Video Out] is set to [PAL])

- 3** Press the MENU button.

The screen that was displayed before selecting the menu appears again.



When the HDMI output format is set to [1080i] or [720p], the display of the AV device may display some items with different designs from those of camera on the screen.

# 7 Editing Images

---

This chapter describes how to edit the captured images.

<b>Changing the Image Size .....</b>	<b>172</b>
<b>Processing Images .....</b>	<b>174</b>
<b>Developing RAW Images .....</b>	<b>180</b>

## Changing the Number of Recorded Pixels (Resize)

Changes the number of recorded pixels, and saves the image as a new file.



- Only JPEG images captured with this camera can be resized.
- Images already resized to **0.2M** or **0.3M** with this camera cannot be resized.

### 1 Select an image to resize in Playback mode, and press the four-way controller (▼).

The playback mode palette appears.

### 2 Use the four-way controller (▲▼◀▶) to select (Resize), and press the OK button.

The screen to select the recorded pixels appears.

### 3 Use the four-way controller (◀▶) to select the number of recorded pixels, and press the OK button.

You can select one of the image sizes starting from one size smaller than that of the original image. The selectable sizes vary according to the original image size and aspect ratio.



### 4 Use the four-way controller (▲▼) to select [Save as], and press the OK button.

The resized image is saved as a new image.

## Cropping Out Part of the Image (Cropping)

Crops out only the desired area of the selected image and saves it as a new image. The aspect ratio can also be changed.



- Only JPEG images captured with this camera can be cropped.
- Images already resized to 0.2M or 0.3M with this camera cannot be cropped.

### 1 Select an image to crop in Playback mode, and press the four-way controller (▼).

The playback mode palette appears.



### 2 Use the four-way controller (▲▼◀▶) to select (Cropping), and press the OK button.

The cropping frame to specify the size and position of the area to crop appears on the screen.

### 3 Specify the size and position of the area to crop by using cropping frame.



#### Available operations

E-dial	Changes the size of the cropping frame.
Four-way controller (▲▼◀▶)	Moves the cropping frame.
 Av button	Changes the aspect ratio.
 /  button	Rotates the cropping frame (only when the cropping frame can be rotated).

### 4 Press the OK button.

The save confirmation screen appears.

### 5 Use the four-way controller (▲▼) to select [Save as], and press the OK button.

The cropped image is saved as a new image.

## Processing Images with Digital Filters

You can edit captured images using digital filters. The following filters are available.

Filter Name	Effect	Parameter
Monochrome	Creates a monochrome image such as a black-and-white photo.	Filter Effect: OFF/Red/Green/Blue/Infrared Filter
		Toning (B-A): 7 levels
Toy Camera	Creates an image that looks as though it was shot with a toy camera.	Shading Level: Low/Medium/High
		Blur: Low/Medium/High
		Tone Break: Red/Green/Blue/Yellow
High Contrast	Enhances the contrast in the image.	Intensity: 1 to 5
Shading	Creates an image with darkened edges.	Shading Type: 6 types
		Shading Level: -3 to +3
Slim	Changes the horizontal and vertical ratio of images.	-8 to +8
HDR	Creates an image that looks like a high dynamic range image.	Low/Medium/High
Invert Color	Inverts image colors.	OFF/ON
Extract Color	Extracts two specific colors and makes the rest of the image black and white.	Extracted Color 1: Red/Magenta/Blue/Cyan/Green/Yellow
		Extractable Range of Color 1: 1 to 5
		Extracted Color 2: OFF/Red/Magenta/Blue/Cyan/Green/Yellow
		Extractable Range of Color 2: 1 to 5
Color	Adds a color filter to the image. Select from 18 filters (6 colors x 3 tones).	Color: Red/Magenta/Blue/Cyan/Green/Yellow
		Color Density: Light/Medium/Dark
Water Color	Creates an image that looks as though it was painted.	Intensity: Low/Medium/High
		Saturation: OFF/Low/Medium/High



Filter Name	Effect	Parameter
Posterization	Lessens the tone of the image to create an image that looks as though it was hand-drawn.	Intensity: 1 to 5
Fish-eye	Creates an image that looks as though it was shot with a fish-eye lens.	Low/Medium/High
Retro	Creates an image with the look of an old photo.	Toning (B-A): 7 levels Frame Composite: None/Thin/ Medium/Thick
Soft	Creates an image with a soft focus throughout the image.	Soft Focus: Low/Medium/High Shadow Blur: OFF/ON
Sketch Filter	Creates an image that looks as though it was drawn with a pencil.	Contrast: Low/Medium/High Scratch Effect: OFF/ON
Miniature	Blurs part of the image to create a simulated miniature scene.	In-Focus Plane: -3 to +3 In-Focus Width: Narrow/Middle/Wide In-Focus Plane Angle: Side/Vertical/ Positive Slope/Negative Slope Blur: Low/Medium/High
Frame Composite	Adds a decorative frame to images.	Frame Type: 1/2/3 Frame Width: Thin/Medium/Thick
Starburst	Creates an image with a special sparkling look by adding extra glitter to the highlights of night scenes or lights reflected on water.	Shape: Cross/Star/Snow Crystal/ Heart/Musical Note Effect Density: Small/Medium/Large Size: Small/Medium/Large Angle: 0°/30°/45°/60°
Base Parameter Adj	Adjusts the parameters to create the desired image.	Brightness: -8 to +8 Saturation: -3 to +3 Hue: -3 to +3 Contrast: -3 to +3 Sharpness: -3 to +3



Only JPEG and RAW images captured with this camera can be edited using the Digital Filter.

- 1 **Select an image for applying the digital filter in Playback mode, and press the four-way controller (▼).**

The playback mode palette appears.

- 2 **Use the four-way controller (▲▼◀▶) to select 0 (Digital Filter), and press the OK button.**

The screen to select a filter appears.

- 3 **Use the four-way controller (▲▼◀▶) to select a filter.**

After selecting a filter, you can check the effect on the screen.

You can select a different image by turning the e-dial.

Proceed to Step 7 if you do not need to change the parameters.



- 4 **Press the  Av button.**

The screen to adjust the parameter appears.

- 5 **Use the four-way controller (▲▼) to select a parameter, and use the four-way controller (◀▶) to adjust the value.**



Color Filter



Slim Filter

- 6 **Press the OK button.**

The save confirmation screen appears.

## 7 Use the four-way controller (▲▼) to select [Use filters in combination] or [Save as], and press the OK button.

Select [Use filters in combination] when you want to apply additional filters to the same image. The screen that was displayed in Step 3 appears again.

If [Save as] was selected, the filter-processed image is saved as a new image.

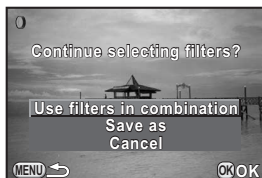

Up to 20 filters, including a digital filter used during shooting (p.135), can be combined to the same image.

## Recreating Filter Effects

Retrieves the setting of an image with filter effects and apply the same filter effects to other images.

### 1 Select a filter-processed image in Playback mode.

### 2 Select 0 (Digital Filter) in the playback mode palette, and press the OK button.

### 3 Use the four-way controller (▲▼) to select [Recreating filter effects], and press the OK button.

The filter effects used for the selected image appear.



### 4 To check the parameter details, press the INFO button.

You can check the filter parameters.

Press the **MENU** button to return to the previous screen.



## 5 Press the OK button.

The image selection screen appears.

## 6 Use the e-dial to select an image for applying the same filter effects, and press the OK button.

You can only select an image that has not been processed with a filter.

The save confirmation screen appears.



## 7 Use the four-way controller (▲▼) to select [Save as], and press the OK button.

The filter-processed image is saved as a new image.

### Searching for the Original Image

Searches for and displays the original image prior to digital filter application.

## 1 Select [Searching for the original image] in Step 3 on p.177, and press the OK button.

The original image prior to digital filter application is retrieved.



If the original image is no longer stored on the SD Memory Card, the message [Original image, prior to digital filter application, is not found] appears.

## Editing Out the Unwanted Red-eye Effect

You can correct images where the flash has caused the subject to appear with red eyes.



- Only JPEG images captured with this camera can be used for the Red-eye Edit function.
- The Red-eye Edit function does not work on images where red eyes cannot be detected on the camera. An error message appears in Step 3.

---

**1** Select an image to edit in Playback mode, and press the four-way controller (▼).

The playback mode palette appears.

---

**2** Use the four-way controller (▲▼◀▶) to select  (Red-eye Edit), and press the OK button.

The save confirmation screen appears.

---

**3** Use the four-way controller (▲▼) to select [Save as], and press the OK button.

The edited image is saved as a new image.

You can convert captured RAW images into JPEG images, and save them as a new file.



Only RAW images captured with this camera can be edited. RAW images and JPEG images captured with other cameras cannot be edited on this camera.

## Developing One RAW Image

- 1 Select a RAW image in Playback mode, and press the four-way controller (▼).**

The playback mode palette appears.

- 2 Use the four-way controller (▲▼◀▶) to select RAW (RAW Development), and press the OK button.**

The screen to select a development method is displayed.

- 3 Use the four-way controller (▲▼) to select [Developing a Single Image], and press the OK button.**

The parameters recorded in the image file appear.

Proceed to Step 7 if you do not need to change the parameters.



- 4 Use the four-way controller (▲▼) to choose a parameter you want to change.**

You can select a different image by turning the e-dial.



The following parameters can be changed.

Parameter	Value	Page
Aspect Ratio	16:9 / 3:2 / 4:3 / 1:1	p.121
Recorded Pixels	JPEG recorded pixels corresponding to the aspect ratio	p.122
Quality Level	★★★★ / ★★★ / ★★ / ★	p.123
Color Space	sRGB/AdobeRGB	p.123
Custom Image	Bright/Natural/Portrait/Landscape/Vibrant/Radiant/Muted/Bleach Bypass/Reversal Film/Monochrome/Cross Processing	p.131
White Balance	AWB /  /  /  /  /  /  /  /  /  /	p.124
Sensitivity	-2.0 to +2.0	—
High-ISO NR	Auto/Low/High	p.85
Shadow Correction	Auto/On/Off	p.129
Distortion Correction	On/Off	p.149

## 5 Use the four-way controller (◀▶) to change the value.

Press the four-way controller (▶) to display the setting screen for White Balance and Custom Image.

## 6 Press the OK button.

The save confirmation screen appears.

## 7 Use the four-way controller (▲▼) to select [Save as], and press the OK button.

The RAW image is developed and saved as a new image.

## 8 Use the four-way controller (▲▼) to select [Continue] or [Exit], and press the OK button.

Select [Continue] to edit other images. The screen for selecting the parameter in Step 5 appears again.

## Developing Multiple RAW Images

You can develop multiple RAW images with the same settings.

- 1 Select [Developing Multiple Images] in Step 3 on p.180, and press the OK button.**

The multi-image display screen appears.

Refer to p.156 for details on operations in the multi-image display screen.

- 2 Use the four-way controller (▲▼◀▶) to select the RAW images to be developed, and press the OK button.**

- 3 Press the  Av button.**

The development confirmation screen appears.

- 4 Use the four-way controller (▲▼) to select [Develop images as shot] or [Develop images with modified settings], and press the OK button.**

To change parameters, select [Develop images with modified settings].



- 5 Use the four-way controller (▲▼◀▶) to set [JPEG Recorded Pixels] and [JPEG Quality].**

When [Develop images with modified settings] is selected in Step 4, refer to p.181 to change other parameters.



- 6 Press the OK button.**

The save confirmation screen appears.

- 7 Use the four-way controller (▲▼) to select [Save as], and press the OK button.**

The selected RAW images are developed and saved as new images.



# 8 Changing Additional Settings

---

This chapter describes how to change additional settings.

<b>How to Operate the Set-up Menu .....</b>	<b>184</b>
<b>Camera Settings.....</b>	<b>186</b>
<b>File Management Settings.....</b>	<b>198</b>



Perform general settings related to the camera in the [  Set-up] menu.





For details on how to use the menus, refer to "Using the Menus" (p.32).

## Set-up Menu Items

Perform the following settings in the [  Set-up 1-3] menus.

Press the **MENU** button in Capture/Playback mode and use the four-way controller (   ) or e-dial to display the [  Set-up 1-3] menus.

Menu	Item	Function	Page
 1	Language/言語	Changes the language in which menus and messages appear.	p.190
	Date Adjustment	Sets the date format and time.	p.187
	World Time	Sets the display of the local date and time of the specified city so they can be displayed on the monitor in addition to the present location.	p.187
	Sound Effects	Switches the operation sound on/off and changes its volume.	p.186
	Guide Display	Sets the length of time that the guides are displayed on the monitor when the Capture mode is changed.	p.191
	LCD Display Settings	Adjusts the brightness and the color of the monitor.	p.193
	Flicker Reduction	Cuts down on screen flicker by setting the power frequency to that used in your region.	p.29
 2	Video Out	Sets the output format when connecting to an AV device with a video input terminal.	p.169
	HDMI Out	Sets the HDMI output format when connecting to an AV device with an HDMI terminal.	p.170
	USB Connection	Sets the USB connection mode when connecting to a computer.	p.205
	Folder Name	Sets the naming system for folders to store images.	p.200

Menu	Item	Function	Page
2	Create New Folder	Creates a new folder on the SD Memory Card.	p.201
	Power Saving	You can save battery power by setting the display to dim automatically when no operation is performed for 10 seconds.	p.190
	Auto Power Off	Sets the time until the camera turns off automatically.	p.190
3	Reset	Resets all settings.	p.196
	Pixel Mapping	Maps out and corrects any defective pixels in the CMOS sensor.	p.194
	Dust Removal	Cleans the CMOS sensor by shaking it.	p.227
	Format	Formats an SD Memory Card.	p.198
	Firmware Version Info	Displays the camera's firmware version.	p.197

● [2] Set-up 1] menu

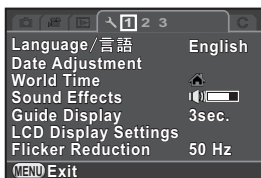

● [2] Set-up 2] menu

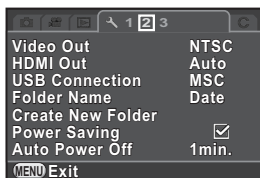

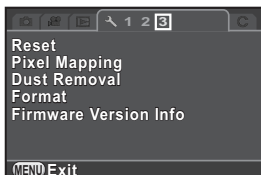

● [3] Set-up 3] menu





## Setting the Sound Effects, Date and Time, and Display Language

### Setting the Sound Effects

You can turn the camera operation sound on or off, or change its volume. The sound for the following items can be set.





- In-focus
- AE-L (AE Lock operation sound)
- Self-timer
- Remote Control
- One Push File Format (operation sound when [One Push File Format] is assigned to the / button)
- Shutter Sound

**1** Select **[Sound Effects]** in the [ **Set-up 1**] menu, and press the four-way controller ().

The [Sound Effects 1] screen appears.

**2** Press the four-way controller () , and use the four-way controller ( ) to adjust the volume.

Select from six levels. When set to 0, you can turn all the sound effects off.

**3** Use the four-way controller ( ) to select an item, and use the four-way controller ( ) to select  or .

Turn the e-dial to display the [Sound Effects 2] screen.

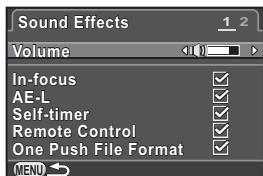

**4** Press the **MENU** button twice.

The screen that was displayed before selecting the menu appears again.

## Changing the Date and Time Display

You can change the initial date and time settings, and their display formats.

Set in [Date Adjustment] (p.184) of the [↖ Set-up 1] menu.

☞ Setting the Date and Time (p.50)

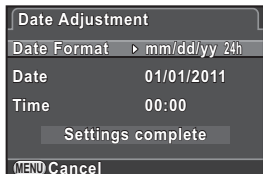

## Setting the World Time

The date and time set in “Initial Settings” (p.48) serve as the date and time of your present location.

Setting the destination in [World Time] enables you to display the local date and time on the monitor when traveling overseas.

**1** Select [World Time] in the [↖ Set-up 1] menu, and press the four-way controller (▶).

The [World Time] screen appears.

**2** Use the four-way controller (◀▶) to select ↗ (Destination) or ↖ (Hometown) for [Setting the Time].

This setting is reflected in the date and time that appear in the guide display and control panel.

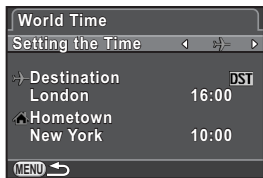

**3** Press the four-way controller (▼) to move the frame to ↗ (Destination), and press the four-way controller (▶).

The [↗ Destination] screen appears.

#### 4 Use the four-way controller (◀▶) to select a destination city.

Turn the e-dial to change the region. The location, time difference and current time of the selected city appear.

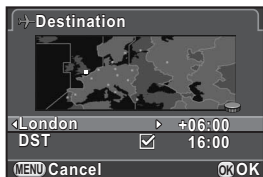

#### 5 Press the four-way controller (▼) to select [DST], and use the four-way controller (◀▶) to select or .

Select  if the destination city uses daylight saving time (DST).

#### 6 Press the OK button.

The destination setting is saved and the camera returns to the [World Time] screen.

#### 7 Press the MENU button twice.

The screen that was displayed before selecting the menu appears again.



- Refer to “List of World Time Cities” (p.189) for cities that can be selected as a destination.
- Select (Hometown) in Step 3 to change the city and DST setting.
- appears in the control panel and guide display (p.69) if [Setting the Time] is set to (Destination). Also, the video output setting (p.169) changes to the video output format for that city.

## ● List of World Time Cities

Region	City	Video Output Format	Region	City	Video Output Format
North America	Honolulu	NTSC	Africa/ West Asia	Istanbul	PAL
	Anchorage	NTSC		Cairo	PAL
	Vancouver	NTSC		Jerusalem	PAL
	San Francisco	NTSC		Nairobi	PAL
	Los Angeles	NTSC		Jeddah	PAL
	Calgary	NTSC		Tehran	PAL
	Denver	NTSC		Dubai	PAL
	Chicago	NTSC		Karachi	PAL
	Miami	NTSC		Kabul	PAL
	Toronto	NTSC		Male	PAL
	New York	NTSC		Delhi	PAL
	Halifax	NTSC		Colombo	PAL
Central and South America	Mexico City	NTSC	Kathmandu	PAL	
	Lima	NTSC	Dacca	PAL	
	Santiago	NTSC	East Asia	Yangon	NTSC
	Caracas	NTSC		Bangkok	PAL
	Buenos Aires	PAL		Kuala Lumpur	PAL
	Sao Paulo	PAL		Vientiane	PAL
Rio de Janeiro	NTSC	Singapore		PAL	
Europe	Lisbon	PAL		Phnom Penh	PAL
	Madrid	PAL		Ho chi Minh	PAL
	London	PAL		Jakarta	PAL
	Paris	PAL		Hong Kong	PAL
	Amsterdam	PAL		Beijing	PAL
	Milan	PAL	Shanghai	PAL	
	Rome	PAL	Manila	NTSC	
	Copenhagen	PAL	Taipei	NTSC	
	Berlin	PAL	Seoul	NTSC	
	Prague	PAL	Tokyo	NTSC	
	Stockholm	PAL	Guam	NTSC	
	Budapest	PAL	Oceania	Perth	PAL
	Warsaw	PAL		Adelaide	PAL
	Athens	PAL		Sydney	PAL
	Helsinki	PAL		Noumea	PAL
	Moscow	PAL		Wellington	PAL
Africa/ West Asia	Dakar	PAL		Auckland	PAL
	Algiers	PAL	Pago Pago	NTSC	
	Johannesburg	PAL			

## Setting the Display Language

You can change the language in which the menus, error messages, etc. are displayed.

The camera supports the following languages: English, French, German, Spanish, Portuguese, Italian, Dutch, Danish, Swedish, Finnish, Polish, Czech, Hungarian, Turkish, Greek, Russian, Korean, Traditional Chinese, Simplified Chinese and Japanese.

Set in [Language/言語] (p.184) of the [  Set-up 1] menu.

 Setting the Display Language (p.48)



## Setting the Monitor and the Menu Display

### Minimizing Battery Consumption

You can set the monitor to dim and the camera to turn off automatically if unused for a certain length of time.

Set in [Power Saving] and [Auto Power Off] (p.185) of the [  Set-up 2] menu.

Power Saving	The monitor brightness goes dim if the camera is unused for 10 seconds. The default setting is <input checked="" type="checkbox"/> (On). Press any button to return it to the normal brightness.
Auto Power Off	The power turns off automatically. Select from [1min.] (default setting), [3min.], [5min.], or [Off]. To turn it back on, press the power switch.



- The Power Saving function does not work while recording a movie.
- The Auto Power Off function does not work in the following situations.
  - when a slideshow is played back
  - when the camera is connected to a computer with an USB cable







## Setting the Capture Mode Display Method

Sets the monitor display method in Capture mode.

- 1 Select [LCD View Options] in the [📷 Rec. Mode 3] menu, and press the four-way controller (▶).

The [LCD View Options] screen appears.

- 2 Press the four-way controller (▶), use the four-way controller (▲▼) to select a grid display type, and press the OK button.

Select from  (default setting),  (4x4 Grid),  (Golden Section) or  (Scale).

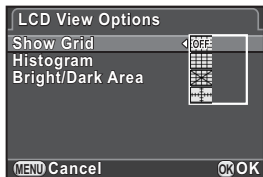

- 3 Use the four-way controller (▲▼) to select [Histogram] or [Bright/Dark Area], and use the four-way controller (◀▶) to select  or .

Histogram	Shows the brightness distribution of an image. (p.26)
Bright/Dark Area	Bright (overexposed) portions blink red and dark (underexposed) portions blink yellow. (p.28)

- 4 Press the MENU button twice.

The screen that was displayed before selecting the menu appears again.

## Setting the Guide Display Time

Set the length of time that the guides (p.69) are displayed on the monitor when the Capture mode is changed.

Select from [3 sec.] (default setting), [10 sec.], [30 sec.] and [Off].

Set in [Guide Display] (p.184) of the [🔧 Set-up 1] menu.

## Setting the Initial Menu Tab Displayed

Set the initial menu tab displayed on the monitor when the **MENU** button is pressed.

- 1 Select **[12. Save Menu Location]** in the **[C Custom Setting 2]** menu, and press the four-way controller (▶).

The [12. Save Menu Location] screen appears.

- 2 Use the four-way controller (▲▼) to select **[Reset Menu Location]** or **[Save Menu Location]**, and press the **OK** button.

1	Reset Menu Location	The [📷 Rec. Mode 1] menu ([🎬 Movie 1] menu in 🎬 mode, and [▶ Playback 1] menu in Playback mode) is always displayed first. (default setting)
2	Save Menu Location	The menu tab last selected is displayed first.

- 3 Press the **MENU** button.

The screen that was displayed before selecting the menu appears again.

## Setting the Display for Instant Review

You can set the Instant Review (p.55) display settings.

- 1 Select **[Instant Review]** in the **[📷 Rec. Mode 3]** menu, and press the four-way controller (▶).

The [Instant Review] screen appears.

- 2 Press the four-way controller (▶), use the four-way controller (▲▼) to select a display time, and press the **OK** button

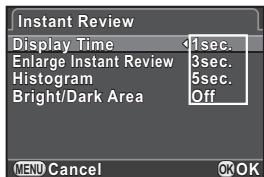

- 3** Use the four-way controller (▲▼) to select [Enlarge Instant Review], [Histogram] or [Bright/Dark Area], and use the four-way controller (◀▶) to select  or .

Enlarge Instant Review	You can enlarge the image with the e-dial. (p.155)
Histogram	Shows the brightness distribution of an image. (p.26)
Bright/Dark Area	Bright (overexposed) portions blink red and dark (underexposed) portions blink yellow. (p.28)

- 4** Press the **MENU** button twice.

The screen that was displayed before selecting the menu appears again.

## Adjusting the Brightness and the Color of the Monitor

Adjusts the brightness and the color of the monitor.

- 1** Select [LCD Display Settings] in the [↖ Set-up 1] menu, and press the four-way controller (▶).

The [LCD Display Settings] screen appears.

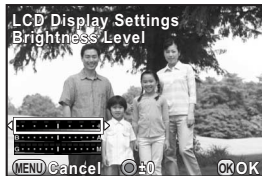

- 2** Use the four-way controller (▲▼) to select [Brightness Level] or [Color Adjustment].



Brightness Level	Changes the brightness of the monitor (-3 to +3).
Adjust: Blue-Amber	Adjusts the tone of the colors between blue (B7) and amber (A7).
Adjust: Green-Magenta	Adjusts the tone of the colors between green (G7) and magenta (M7).

---

### 3 Use the four-way controller (◀▶) to adjust the value.

Press the  button to reset the adjustment value. (Available only when [Green Button] is assigned to the  button in [Green Button] of the [Rec. Mode 3] menu (p.144).).

---

### 4 Press the OK button.

### 5 Press the MENU button.

The screen that was displayed before selecting the menu appears again.

---

## Correcting Defective Pixels in the CMOS Sensor (Pixel Mapping)

Pixel Mapping is a function for mapping out and correcting defective pixels in the CMOS sensor.

---

### 1 Select [Pixel Mapping] in the [Set-up 3] menu, and press the four-way controller (▶).

The [Pixel Mapping] screen appears.

---

### 2 Use the four-way controller (▲▼) to select [Pixel Mapping], and press the OK button.

Defective pixels are mapped and corrected, and the screen that was displayed before selecting the menu appears again.



When the battery level is low, [Not enough battery power remaining to activate Pixel Mapping] is displayed on the monitor. Use the AC adapter kit K-AC115 (optional) or install a fully charged battery.

## Selecting Settings to Save in the Camera (Memory)

You can select which function settings to save when the camera is turned off. The following function settings can be saved.

Function	Default Setting
Flash Mode	<input checked="" type="checkbox"/>
Drive Mode	<input checked="" type="checkbox"/>
White Balance	<input checked="" type="checkbox"/>
Custom Image	<input checked="" type="checkbox"/>
Sensitivity	<input checked="" type="checkbox"/>
EV Compensation	<input checked="" type="checkbox"/>

Function	Default Setting
Flash Exposure Comp.	<input checked="" type="checkbox"/>
Focus Position	<input type="checkbox"/>
Digital Filter	<input type="checkbox"/>
HDR Capture	<input type="checkbox"/>
Playback Info Display	<input checked="" type="checkbox"/>
File No.	<input checked="" type="checkbox"/>

- 1 Select **[Memory]** in the **[Rec. Mode 3]** menu, and press the four-way controller (▶).

The [Memory 1] screen appears.

- 2 Use the four-way controller (▲▼) to select an item, and use the four-way controller (◀▶) to select  or .

Turn the e-dial to display the [Memory 2] screen.

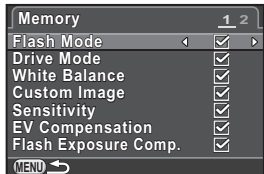

<input checked="" type="checkbox"/>	Settings are saved even when the camera is turned off.
<input type="checkbox"/>	Settings are cleared and returned to their default values when the camera is turned off.

- 3 Press the **MENU** button twice.

The screen that was displayed before selecting the menu appears again.



- Set [File No.] to  (On) to continue the sequential numbering for the file name even if a new folder is created. Refer to “Selecting the File Number Setting” (p.200) for details.
- When [Reset] (p.196) of the [Set-up 3] menu is performed, all Memory settings return to the default values.

## Resetting the Menus

### Resetting the Rec. Mode/Movie/Playback/Set-up Menus

Settings of the direct keys and for the items of the [📷 Rec. Mode] menu, [🎞️ Movie] menu, [▶ Playback] menu, [⚙️ Set-up] menu, and playback mode palette can be reset to default values.

- 1 Select [Reset] in the [⚙️ Set-up 3] menu, and press the four-way controller (▶).**

The [Reset] screen appears.

- 2 Use the four-way controller (▲▼) to select [Reset], and press the OK button.**

The settings are reset, and the screen that was displayed before selecting the menu appears again.



The following settings are not reset.

- Language/言語
- Date Adjustment
- The city and DST settings for World Time
- Flicker Reduction
- Video Out
- [C Custom Setting] menu

### Resetting the Custom Setting Menu

Settings for the items of the [C Custom Setting] menu can be reset to default values.

- 1 Select [Reset Custom Functions] in the [C Custom Setting 2] menu, and press the four-way controller (▶).**

The [Reset Custom Functions] screen appears.

- 2 Use the four-way controller (▲▼) to select [Reset], and press the OK button.**

The settings are reset, and the screen that was displayed before selecting the menu appears again.

## Checking the Camera Version Information

You can check the version information for software (firmware) in the camera. If an update file for the firmware is released, you can update the camera to the latest firmware version.



Refer to the PENTAX website for more information and procedural details regarding updates.

### 1 Select [Firmware Version Info] in the [ Set-up 3] menu, and press the four-way controller (▶).

The firmware versions for the camera and lens are displayed on the [Firmware Version Info] screen.

If an update file is saved on your SD Memory Card, you can run the update at a later time.



### 2 Press the MENU button twice.

The screen that was displayed before selecting the menu appears again.



- You cannot return a camera to its previous firmware version after updating it.
- Before running the update, be sure to save the data on your SD Memory Card to a computer or other location.
- When the battery level is low, [Not enough battery power remaining to update the firmware] is displayed on the monitor. Use the AC adapter kit K-AC115 (optional) or install a fully charged battery.

## Formatting an SD Memory Card

Use this camera to format (initialize) an SD Memory Card that is unused or has been used on other devices.

Formatting deletes all the data saved on the SD Memory Card.



- Do not remove the SD Memory Card while formatting. The card may be damaged and become unusable.
- Formatting deletes all data, either protected or unprotected. Be aware.

### 1 Select [Format] in the [↖ Set-up 3] menu, and press the four-way controller (▶).

The [Format] screen appears.

### 2 Use the four-way controller (▲▼) to select [Format], and press the OK button.

Formatting starts.

When formatting is completed, the screen that was displayed before selecting the menu appears again.

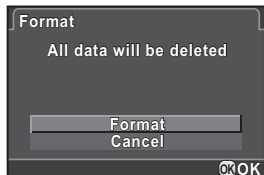

When an SD Memory Card is formatted, the volume label assigned to the card is "PENTAX Q". When this camera is connected to a computer, the SD Memory Card is recognized as a removable disk with the name "PENTAX Q".



## Protecting Images from Deletion (Protect)

You can protect images from being accidentally deleted.



Even protected images are deleted if the inserted SD Memory Card is formatted.

### 1 Press the four-way controller (▼) in Playback mode.

The playback mode palette appears.

### 2 Use the four-way controller (▲▼◀▶) to select (Protect), and press the OK button.

The screen to select how to change the settings is displayed.

### 3 Use the four-way controller (▲▼) to select [Single Image] or [All Images], and press the OK button.

If you selected [All Images], proceed to Step 5.

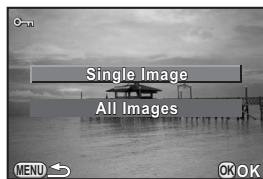

### 4 Use the e-dial to select an image to protect.

### 5 Use the four-way controller (▲▼) to select [Protect], and press the OK button.

Select [Unprotect] to cancel the protection of the image.

The image is protected and the  icon appears at the top right of the screen.

Repeat Steps 4 and 5 to protect other images.



### 6 Press the MENU button.

The camera returns to Playback mode.

## Changing the Naming System for Folders

You can select a naming system for folders to store images.

Date	The two digits of the month and day on which the picture was taken are assigned as the folder name in the form of [xxx_MMDD]. [xxx] is a sequential number from 100 to 999. [MMDD] (month and day) appears according to the display format set in [Date Adjustment] (p.50). (default setting) Example) 101_0125: Folder for images taken on January 25th
PENTX	The folder name is assigned in the form of [xxxPENTX]. Example) 101PENTX

Set in [Folder Name] (p.184) of the [ Set-up 2] menu.



When the number of storable images exceeds 500, captured images are divided into folders of 500 images each. However, in Exposure Bracketing shooting, images will be stored in the same folder until shooting is completed, even if the number of images exceeds 500.

## Selecting the File Number Setting

You can select a method for assigning the file number of an image when saved to a new folder. Set in [File No.] in [Memory] (p.195) of the [ Rec. Mode 3] menu.

<input checked="" type="checkbox"/>	The file number of the last image saved to the previous folder is saved and subsequent images are assigned sequential file numbers even if a new folder is created.
<input type="checkbox"/>	The file number of the first image saved to a folder returns to 0001 each time a new folder is created for saving images.

## Creating New Folders

You can create a new folder on an SD Memory Card. A folder is created with the number following the number of the folder currently being used.

- 1** Select **[Create New Folder]** in the **[ Set-up 2]** menu, and press the four-way controller (**▶**).

The **[Create New Folder]** screen appears.

- 2** Use the four-way controller (**▲ ▼**) to select **[Create folder]**, and press the **OK** button.

A folder with a new number is created when the next image/movie file is saved.

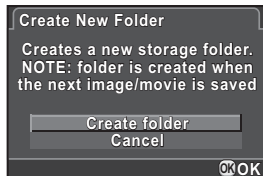

Only one folder can be created using this operation. Multiple empty folders cannot be created consecutively.

## Setting the DPOF Settings

By adding DPOF (Digital Print Order Format) settings to stored images on the SD Memory Card, you can specify the number of copies and whether to imprint the date on the images in advance and order conventional photograph prints by taking this SD Memory Card to a store for printing.



- DPOF settings cannot be applied to RAW images and movies.
- You can make DPOF settings for up to 999 images.

- 1** Press the four-way controller (**▼**) in **Playback mode**.

The playback mode palette appears.

- 2** Use the four-way controller (**▲ ▼ ◀ ▶**) to select ** (DPOF)**, and press the **OK** button.

The screen to select how to change the settings is displayed.

### 3 Use the four-way controller (▲▼) to select [Single Image] or [All Images], and press the OK button.

If you selected [All Images], proceed to Step 5.

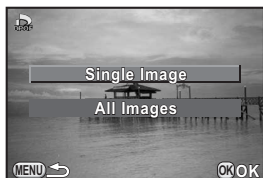

### 4 Use the e-dial to select an image to set DPOF settings.

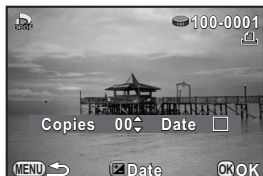

### 5 Use the four-way controller (▲▼) to select the number of copies.

You can set up to 99 copies.

 appears at the top right of the screen for images with DPOF settings. To cancel the DPOF settings, set the number of copies to [00].

### 6 Press the Av button to select or for printing the date.

<input checked="" type="checkbox"/>	The date will be printed.
<input type="checkbox"/>	The date will not be printed.

Repeat Steps 4 to 6 to make DPOF settings for other images (up to 999).

### 7 Press the OK button.

The DPOF settings for the selected image is saved and the camera returns to Playback mode.



- Depending on the printer or printing equipment at the photo processing lab, the date may not be printed on the pictures even if the date for DPOF setting is set to .
- The number of copies specified in the All Images setting applies to all the images, and that specified in the Single Image setting is canceled. Before printing, check that the specified number is correct.

# 9 Connecting to a Computer

---

This chapter explains how to connect the camera to a computer, install the supplied CD-ROM, etc.

<b>Manipulating Captured Images on a Computer</b>	<b>204</b>
<b>Saving Images on a Computer</b>	<b>205</b>
<b>Using the Provided Software</b>	<b>207</b>

# Manipulating Captured Images on a Computer

The captured still pictures and movies can be transferred to a computer by connecting the camera using a USB cable, and RAW images can be developed using the provided software “SILKYPIX Developer Studio”. We recommend the following system requirements to connect the camera to a computer or to use the software.

## ● Windows

OS	Windows XP (SP3 or later, 32-bit Home/Pro), Windows Vista (32-bit, 64-bit), Windows 7 (32-bit, 64-bit) <ul style="list-style-type: none"> <li>• Installation requires administrator rights</li> <li>• Can be run as a 32-bit application on any 64-bit Edition of Windows</li> </ul>
CPU	Intel Pentium-compatible processor (Pentium 4, Athlon XP or higher recommended) <ul style="list-style-type: none"> <li>• Supports multi-core processors (Intel Core i5, i7; Core 2 Quad, Duo; AMD Phenom II X4, X6; Athlon II X2, X4; and other)</li> </ul>
RAM	1 GB minimum (2 GB or more recommended)
HDD	For installing and starting up the program: 100 MB minimum of free space For saving image files: Approx. 10 MB/file
Monitor	1024×768 dots, 24-bit full color or higher
Other	Input devices such as a keyboard and mouse

## ● Macintosh

OS	Mac OS X 10.4, 10.5, or 10.6
CPU	Intel processor-compatible, Power PC
RAM	1 GB minimum (2 GB or more recommended)
HDD	For installing and starting up the program: 100 MB minimum of free space For saving image files: Approx. 10 MB/file
Monitor	1024×768 dots, 24-bit full color or higher
Other	Input devices such as a keyboard and mouse



QuickTime is required to play back movies transferred to a computer. You can download it from the following site:  
<http://www.apple.com/quicktime/download/>

## Setting the USB Connection Mode

Set the USB connection mode when connecting the camera to a computer.

- 1** Select **[USB Connection]** in the **[↖ Set-up 2]** menu, and press the four-way controller (**▶**).
- 2** Use the four-way controller (**▲ ▼**) to select **[MSC]** or **[PTP]**, and press the **OK** button.

MSC	Mass Storage Class (default setting) A general-purpose driver program that handles devices connected to the computer via USB as a memory device.
PTP	Picture Transfer Protocol A protocol that allows transfer of digital images and control of digital cameras via USB.

Unless otherwise specified, select **[MSC]**.

- 3** Press the **MENU** button.

The screen that was displayed before selecting the menu appears again.

## Connecting the Camera and a Computer

Connect the camera to a computer using the provided USB cable I-USB7.

- 1 Turn the computer on.**
- 2 Turn off the camera, and use the USB cable to connect the PC/AV terminal of the camera and the computer.**

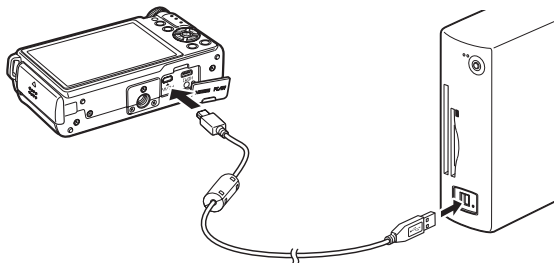

- 3 Turn the camera on.**

The camera is recognized as a removable disk or an SD Memory Card with a volume label "PENTAX Q".

If the "PENTAX Q" dialog appears when the camera is turned on, select [Open folder to view files using Windows Explorer] and click the OK button.

- 4 Save the captured images to the computer.**

Copy the image file(s) or folder(s) to the hard disk of the computer.

- 5 Disconnect the camera from the computer.**



“SILKYPIX Developer Studio 3.0 for PENTAX” is included on the CD-ROM (S-SW115). With the SILKYPIX Developer Studio, you can develop RAW files, adjust the color of the images and other settings, and save the new images as a JPEG or TIFF file.

## Installing the Software

You can install the software from the provided CD-ROM. When multiple accounts have been setup on a computer, log on with an account that has administrative rights before installing the software.

### 1 Turn the computer on.

Make sure no other software is running.

### 2 Place the CD-ROM (S-SW115) into the CD/DVD drive on the computer.

The [PENTAX Software Installer] screen appears.

#### If the [PENTAX Software Installer] screen does not appear

- **For Windows**

- 1 Click [My Computer] from the Start menu.
- 2 Double-click the [CD/DVD drive (S-SW115)] icon.
- 3 Double-click the [Setup.exe] icon.

- **For Macintosh**

- 1 Double-click the CD/DVD (S-SW115) icon on the desktop.
- 2 Double-click the [PENTAX Installer] icon.

### 3 Click [SILKYPIX Developer Studio 3.0 for PENTAX].

For Macintosh, follow the instructions on the screen to perform subsequent steps.



### 4 Select the desired language in the [Choose Setup Language] screen, and click [OK].

### 5 When the [InstallShield Wizard] screen appears in the selected language, click [Next].

Follow the instructions on the screen to perform subsequent steps.

## Screen of the SILKYPIX Developer Studio

When SILKYPIX Developer Studio 3.0 for PENTAX is launched, the screen on the right appears.



Refer to Help for details on using the software program.

## Regarding Product Registration

To better serve you, please take a moment to register your software.

Click [Product Registration] on the screen in Step 3 on p.208.



A world map for Internet Product Registration is displayed. If a computer is connected to the Internet, click the displayed country or region and then follow the instructions to register your software.

Note that you can only register online if your country or area is shown.

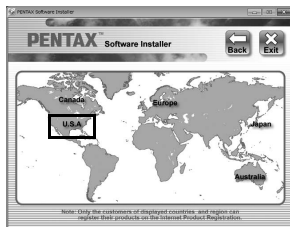

**Memo**

# 10 Using the Flash

---

This chapter provides details on the built-in flash and describes how to take pictures with an external flash.

<b>Using the Built-in Flash .....</b>	<b>212</b>
<b>Using an External Flash (Optional) .....</b>	<b>215</b>

## Flash Characteristics in Each Exposure Mode



### Using the Flash in Tv Mode

- When taking a moving subject, you can use the flash to change the blur effect.
- The aperture value automatically changes according to the ambient brightness.

### Using the Flash in Av Mode

- You can set the desired aperture value to take a flash photograph when you want to change the depth of field or shoot a subject farther away.
- The shutter speed automatically changes with the ambient brightness.

## Using the Slow-speed Sync

You can use Slow-speed Sync in  (Night Scene Portrait) or **SCN** (Scene) mode or **Tv** (Shutter Priority) mode when shooting portraits with the sunset in the background. Both the portrait and the background are captured beautifully.  and  can be used in **P** (Program) or **Av** (Aperture Priority) mode.



- Slow-speed Sync slows down the shutter speed. Use the Shake Reduction function or turn off the Shake Reduction function and use a tripod to avoid camera shake. The picture will also blur if the subject moves.
- Slow-speed Sync can also be performed with an external flash.

## Using the Trailing Curtain Sync

Trailing Curtain Sync discharges the flash immediately before the shutter closes. When shooting moving objects with a slow shutter speed, Trailing Curtain Sync and Slow-speed Sync produce different effects depending on when the flash is discharged.

For example, when shooting a moving car with Trailing Curtain Sync, trailing light is captured while the shutter is open and the flash captures the car immediately before the shutter is closed. Therefore, the picture will include a sharp, well-lit car with trailing light behind it.

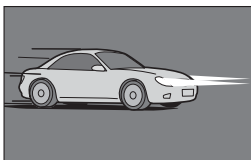

Slow-speed Sync  
(Leading Curtain Sync)

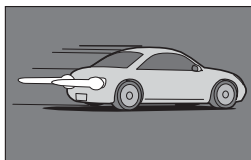

Trailing Curtain Sync



Trailing Curtain Sync slows down the shutter speed. Use the Shake Reduction function, or turn off the Shake Reduction function and use a tripod to avoid camera shake.

## Distance and Aperture when Using the Built-in Flash

Relationships among the guide number, aperture and distance must be considered when shooting with the flash to obtain a correct exposure. Calculate and adjust the shooting conditions if the flash output is not sufficient.

Sensitivity	Built-in Flash Guide Number	Sensitivity	Built-in Flash Guide Number
ISO 125	Approx. 5.6	ISO 1600	Approx. 20
ISO 200	Approx. 7	ISO 3200	Approx. 28
ISO 400	Approx. 10	ISO 6400	Approx. 40
ISO 800	Approx. 14		

## Calculating Shooting Distance from Aperture Value

The following equation calculates the effective distance of the flash for aperture values.

Maximum flash distance  $L1 = \text{Guide number} \div \text{Aperture value}$

Minimum flash distance  $L2 = \text{Maximum flash distance} \div 6 *$

\* The value 6 used in the formula above is a fixed value which applies only when using the built-in flash alone.

Example)

When the sensitivity is ISO 200 and the aperture value is F2.0

$L1 = 7 \div 2.0 = \text{approx. } 3.5 \text{ (m)}$

$L2 = 3.5 \div 6 = \text{approx. } 0.6 \text{ (m)}$

Therefore, the flash can be used in a range of about 0.6 m to 3.5 m. However, the built-in flash in this camera cannot be used when the distance is 0.7 m or less. When the flash is used at closer than 0.7 m, it causes vignetting in the picture corners, light is distributed unevenly and a picture may be overexposed.

## Calculating Aperture Value from Shooting Distance

The following equation calculates the aperture value for shooting distances.

Aperture value  $F = \text{Guide number} \div \text{Shooting distance}$

Example)

When the sensitivity is ISO 200 and the shooting distance is 3 m, the aperture value is:

$F = 7 \div 3 = \text{approx. } 2.3$

If the resulting number (2.3, in the above example) is not available as a lens aperture, a smaller number that is closest (2.0, in the above example) is generally used.

## Lens Compatibility with the Built-in Flash

Depending on the lens used with this camera, even if a lens without a hood is attached, the use of the built-in flash may not be available or may be limited due to vignetting.

### Unavailable due to vignetting

Lens Name
03 FISH-EYE



Using an optional external flash AF540FGZ, AF360FGZ, AF200FG or AF160FC enables a variety of flash modes, such as P-TTL auto flash mode, depending on the external flash being used. See the chart below for details.

✓ : Available    × : Not available

Camera Function	Flash		
	Built-in Flash	AF540FGZ AF360FGZ	AF200FG AF160FC
Red-eye reduction flash	✓	✓	✓
Auto flash discharge	✓	✓	✓
Automatically switching to the flash sync speed	✓	✓	✓
Aperture value is automatically set in <b>P</b> mode and <b>Tv</b> mode.	✓	✓	✓
P-TTL auto flash	✓	✓	✓
Slow-speed Sync	✓	✓	✓
Flash exposure compensation	✓	✓	✓
Auto zoom flash head	×	✓	×
AF assist light of external flash	×	×	×
Trailing Curtain Sync*1	✓	✓	×
Contrast-control-sync flash mode	×	×	×
Slave flash	×	×	×
Wireless flash	×	×	×

\*1 1/2000 sec. or slower for a 01 STANDARD PRIME/02 STANDARD ZOOM lens (1/250 sec. or slower for external flash units), 1/13 sec. or slower for a 03 FISH-EYE/04 TOY WIDE/05 TOY TELEPHOTO lens



- The built-in flash will not discharge if the camera is connected to an external flash.
- Flashes with reversed polarity (the center contact on the hot shoe is minus) cannot be used due to the risk of damaging the camera and flash.



- When an external flash is attached directly to the hot shoe of the camera, the camera's center of gravity is greatly shifted, making it difficult to take pictures. When using an external flash, it is recommended to use an extension cord to separate the camera and flash. (p.217)
- To use an AF160FC flash with the camera, a commercially available step-up ring or similar accessory is needed.

## Using P-TTL Mode

You can use the P-TTL auto flash with the AF540FGZ, AF360FGZ, AF200FG or AF160FC flash unit.

- 1 Remove the cover of the hot shoe, and attach the external flash.**
- 2 Turn on the camera and the external flash.**
- 3 Set the external flash mode to [P-TTL].**
- 4 Confirm that the external flash is fully charged, and then take a picture.**



- The maximum sync speed available with an external flash is 1/250 sec.
- P-TTL auto flash is only available with an AF540FGZ, AF360FGZ, AF200FG or AF160FC flash unit.
- For details such as operation method and effective distance, please refer to the external flash manual.
- The flash does not discharge if the subject is bright enough when the flash mode is set to  $\text{⚡}^A$  or  $\text{⚡}^A$ . Therefore, it may not be suitable for daylight-sync shooting.
- Never pop up the built-in flash manually when any external flash unit is attached to the camera. The built-in flash will hit the external flash.

### Red-eye Reduction

As with the built-in flash, the red-eye reduction function is available with an external flash. The red-eye reduction function works by discharging the flash twice even when only an external flash is used. However, this function may not be available on some flashes or may have restrictions for usage conditions. Refer to the chart on p.215.

## Connecting an External Flash with an Extension Cord

Attach the Hot Shoe Adapter F<sub>G</sub> (optional) to the camera hot shoe and an Off-Camera Shoe Adapter F (optional) to the bottom of the external flash, and connect these with the Extension Cord F5P (optional) as shown in the illustration below. The Off-Camera Shoe Adapter F can be mounted to your tripod using the tripod screw.

The built-in flash will not discharge if the camera is connected to an external flash.

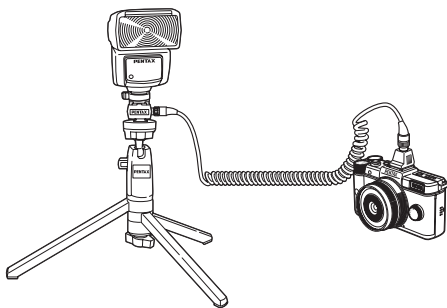

- Do not combine with accessories that have a different number of contacts, such as a Hot Shoe Grip, as a malfunction may occur.
- Combining with flashes from other manufacturers may cause equipment breakdown.

**Memo**

# 11 Appendix

---

<b>Default Settings .....</b>	<b>220</b>
<b>Functions Available with Various Lens Combinations .....</b>	<b>226</b>
<b>Cleaning the CMOS Sensor .....</b>	<b>227</b>
<b>Optional Accessories .....</b>	<b>228</b>
<b>Error Messages .....</b>	<b>232</b>
<b>Troubleshooting .....</b>	<b>234</b>
<b>Main Specifications .....</b>	<b>237</b>
<b>Index .....</b>	<b>243</b>
<b>WARRANTY POLICY .....</b>	<b>249</b>

# Default Settings

The table below shows the factory default settings.

The functions set in Memory (p.195) are saved even when the camera is turned off.

## Reset Setting

Yes: The setting returns to the default setting with the reset function (p.196).

No: The setting is saved even after reset.



## Direct Keys

Item	Default Setting	Reset Setting	Page
Sensitivity	AUTO (ISO 125 - 3200)	Yes	p.75
White Balance	<b>AWB</b> (Auto)	Yes	p.124
Flash Mode	Depends on Capture mode	Yes	p.57
Drive Mode	<input type="checkbox"/> (Single Frame Shooting)	Yes	p.80 p.98 p.100 p.102

## Quick Dial

Position	Default Setting	Reset Setting	Page
1	Smart Effect [Brilliant Color]	Yes	p.138
2	Smart Effect [Unicolor Bold]		
3	Smart Effect [Vintage Color]		
4	Smart Effect [Cross Processing]		

## [📷 Rec. Mode] Menu

Item		Default Setting	Reset Setting	Page
Custom Image		Bright	Yes	p.131
Digital Filter		Not use any filters	Yes	p.135
Image Capture Settings	File Format	JPEG	Yes	p.121
	Aspect Ratio	4:3	Yes	p.121
	JPEG Recorded Pixels	12M (4000×3000)	Yes	p.122
	JPEG Quality	★★★ (Best)	Yes	p.123
	Color Space	sRGB	Yes	p.123
Focus Settings	Focus Method	<b>AF</b>	Yes	p.86
	Autofocus Method	 (AF Select (25 Points))	Yes	p.87
	MF Assist	Off	Yes	p.93
AE Metering		 (Multi-segment)	Yes	p.84
ND Filter		Off	Yes	p.148
HDR Capture		Off	Yes	p.130
Multi-exposure	Number of Shots	2 times	Yes	p.107
	Auto EV Adjustment	<input type="checkbox"/> (Off)	Yes	
Interval Shooting	Interval	1 sec.	Yes	p.104
	Number of Shots	2 images	Yes	
	Start Interval	Now	Yes	
	Start Time	12:00 AM/00:00	Yes	
D-Range Setting	Highlight Correction	Auto	Yes	p.128
	Shadow Correction	Auto	Yes	p.129
High-ISO NR		Auto	Yes	p.85
Distortion Correction		On	Yes	p.149
Quick Dial		Smart Effect	Yes	p.138

Item		Default Setting	Reset Setting	Page	
Green Button	Green Button	Green Button	Yes	p.144	
	One Push File Format	Cancel after 1 shot	<input checked="" type="checkbox"/> (On)		Yes
		JPEG/RAW/RAW+ File Format	All RAW+		Yes
	Action in M Mode	P LINE	Yes		p.147
	E-dial in Program	P SHIFT	Yes	p.146	
LCD View Options	Show Grid	(Off)	Yes	p.191	
	Histogram	<input type="checkbox"/> (Off)	Yes		
	Bright/Dark Area	<input type="checkbox"/> (Off)	Yes		
Instant Review	Display Time	1 sec.	Yes	p.192	
	Enlarge Instant Review	<input type="checkbox"/> (Off)	Yes		
	Histogram	<input type="checkbox"/> (Off)	Yes		
	Bright/Dark Area	<input type="checkbox"/> (Off)	Yes		
Memory	Focus Position, Digital Filter, HDR Capture	<input type="checkbox"/> (Off)	Yes	p.195	
	Other than the above functions	<input checked="" type="checkbox"/> (On)	Yes		
Shake Reduction		(On)	Yes	p.96	

## [ Movie] Menu

Item		Default Setting	Reset Setting	Page
Recorded Pixels		(1920×1080, )	Yes	p.109
Sound		(On)	Yes	
Exposure Setting		Auto	Yes	
Movie SR		(On)	Yes	
Interval Movie	Interval	1 sec.	Yes	p.113
	Recording Time	5 sec.	Yes	
	Start Interval	Now	Yes	
	Start Time	12:00 AM / 00:00	Yes	





## Playback Mode Palette

Item	Default Setting	Reset Setting	Page
Image Rotation	—	—	p.164
Digital Filter	Monochrome	Yes	p.174
Red-eye Edit	—	—	p.179
Resize	Maximum size according to the setting	—	p.172
Cropping	Maximum size according to the setting	—	p.173
Index	—	—	p.160
Protect	—	No	p.199
Slideshow	—	Yes	p.163
Save Cross Processing	—	Yes	p.134
RAW Development	Recorded Pixels: <span style="border: 1px solid black; padding: 0 2px;">12M</span> Quality Level: ★★★	Yes	p.180
Movie Editing	—	—	p.117
Image Comparison	—	—	p.159
DPOF	—	No	p.201

## [▶ Playback] Menu

Item	Default Setting	Reset Setting	Page
Slideshow	Interval	3 sec.	p.162
	Screen Effect	Off	
	Repeat Playback	<input type="checkbox"/> (Off)	
Quick Zoom	Off	Yes	p.154
Bright/Dark Area	<input type="checkbox"/> (Off)	Yes	
Delete All Images	—	—	p.167

[  Set-up ] Menu

Item		Default Setting	Reset Setting	Page
Language/ 言語		According to default setting	No	p.190
Date Adjustment		According to default setting	No	p.187
World Time	World Time setting	 (Hometown)	Yes	p.187
	Hometown (City)	According to default setting	No	
	Hometown (DST)	According to default setting	No	
	Destination (City)	Same as Hometown	No	
	Destination (DST)	Same as Hometown	No	
Sound Effects	Volume	3	Yes	p.186
	Setting	All <input checked="" type="checkbox"/> (On)		
Guide Display		3 sec.	Yes	p.191
LCD Display Settings		±0	Yes	p.193
Flicker Reduction		50 Hz	No	p.29
Video Out		According to default setting	No	p.169
HDMI Out		Auto	Yes	p.170
USB Connection		MSC	Yes	p.205
Folder Name		Date	Yes	p.200
Create New Folder		—	—	p.201
Power Saving		<input checked="" type="checkbox"/> (On)	Yes	p.190
Auto Power Off		1 min.	Yes	p.190
Reset		—	—	p.196
Pixel Mapping		—	—	p.194
Dust Removal	Dust Removal	—	—	p.227
	Start-up Action/ Shut-down Action	<input type="checkbox"/> (Off)	Yes	
Format		—	—	p.198
Firmware Version Info		—	—	p.197

**[C Custom Setting] Menu**

Item	Default Setting	Reset Setting	Page
1. AE-L with AF Locked	On	Yes	p.83
2. Link AE to AF Point	Off	Yes	p.84
3. Auto Bracketing Order	0 – +	Yes	p.80
4. Shake Reduction Options	Mode1	Yes	p.97
5. WB When Using Flash	Auto White Balance	Yes	p.125
6. AWB in Tungsten Light	Subtle Correction	Yes	—
7. AF Release Options	Focus-priority	Yes	p.88
8. AF Assist Light	On	Yes	p.87
9. AF with Remote Control	Off	Yes	p.101
10. Flash When Retracted	Discharge Flash	Yes	p.60
11. Release While Charging	Off	Yes	p.60
12. Save Menu Location	Reset Menu Location	Yes	p.192
13. Electronic Shutter	Disable	Yes	p.226
Reset Custom Functions	—	—	p.196

# Functions Available with Various Lens Combinations

✓: Available #: Restricted ×: Not available

Function \ Lens	01 STANDARD PRIME 02 STANDARD ZOOM	04 TOY WIDE 05 TOY TELEPHOTO	03 FISH-EYE
Autofocus	✓	×	×
Manual focus	✓	✓	✓
Quick-Shift focus	✓	×	×
Autofocus Method	✓	×	×
Aperture control	✓	×	×
ND filter on the lens	✓	×	×
Shutter on the lens	✓	×	×
Electronic shutter	✓ <sup>*1</sup>	✓	✓
Multi-segment metering	✓	✓	× (Center-weighted metering)
<b>AUTO/SCN/BC</b> mode	✓	# <sup>*2</sup>	# <sup>*2</sup>
<b>P/Tv</b> mode	✓	# <sup>*2</sup>	# <sup>*2</sup>
<b>Av</b> mode	✓	# <sup>*2</sup>	# <sup>*2</sup>
<b>M</b> mode	✓	# <sup>*2</sup> <sup>*3</sup>	# <sup>*2</sup> <sup>*3</sup>
 mode	✓	# <sup>*2</sup>	# <sup>*2</sup>
P-TTL Auto Flash	✓ <sup>*4</sup>	✓ <sup>*5</sup>	# <sup>*5</sup> <sup>*6</sup>

\*1 Set [13. Electronic Shutter] to [Enable] in the [C Custom Setting 2] menu. You can take pictures at higher speeds with the electronic shutter than with the lens shutter.

Ex.) With a 01 STANDARD PRIME lens

Pictures taken at 1/2000 sec. or slower with the lens shutter and 1/2000 sec. to 1/8000 sec. with the electronic shutter.

\*2 Aperture value fixed.

\*3 **Bulb** mode not available in **M** mode. Allows the use of a slow shutter speed of up to 2 sec.

\*4 Built-in flash: 1/2000 sec., external flash: 1/250 sec.

\*5 Flash sync speed is approx. 1/13 sec.

\*6 Light may be unevenly distributed.

If the CMOS sensor becomes dirty or dusty, shadows may appear in the image in certain situations such as when shooting against a white background. This indicates that the CMOS sensor must be cleaned.

## Removing Dust by Shaking the CMOS Sensor (Dust Removal)

Shaking the CMOS sensor removes dust that has collected.

- 1** Select **[Dust Removal]** in the **[ Set-up 3]** menu, and press the four-way controller (**▶**).

The **[Dust Removal]** screen appears.

- 2** Press the **OK** button.

The Dust Removal function is activated by shaking the CMOS sensor.

To activate the Dust Removal function every time the camera is turned on and off, set **[Start-up Action]** and **[Shut-down Action]** to .

When Dust Removal is completed, the camera returns to the **[ Set-up 3]** menu.

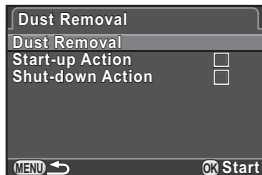

Use a brush-less blower to remove dirt and dust from the CMOS sensor. Using a blower with a brush may scratch the CMOS sensor. Do not wipe the CMOS sensor with a cloth.

# Optional Accessories

A number of dedicated accessories are available for this camera. Contact a PENTAX Service Center for details regarding accessories. Products marked with an asterisk (\*) are the same as those supplied with the camera.

## Power Supply Accessories

### Battery Charger kit K-BC68P (\*)

(Kit includes Battery Charger D-BC68P and AC plug cord.)

### Rechargeable Lithium-ion Battery D-LI68 (\*)

### AC Adapter kit K-AC115

(Kit includes AC Adapter D-AC115, DC Coupler D-DC115 and AC plug cord.)

Lets you power your camera from an AC outlet.



The AC adapter and battery charger are both only sold as a kit.

## Viewfinder

### External optical viewfinder O-VF1

An optical viewfinder that is attached to the hot shoe on the camera.

Includes a dedicated frame for a 01 STANDARD PRIME lens, field of view is approx. 90%. (Comes with a corrective frame for close-up shots)



## Flash Accessories

### Auto Flash AF540FGZ

### Auto Flash AF360FGZ

The AF540FGZ and AF360FGZ are P-TTL auto flash units with a maximum guide number of 54 and 36 (ISO 100/m), respectively.



AF540FGZ



AF360FGZ

### Auto Flash AF200FG

The AF200FG is a P-TTL auto flash unit with a maximum guide number of 20 (ISO 100/m).



AF200FG

### Auto Macro Flash AF160FC

The AF160FC is a flash system especially designed for macro photography to take close, shadowless pictures of small objects. It is compatible with existing TTL auto flash functions and it can be used with a wide range of PENTAX cameras by using provided adapter rings.



AF160FC

**Hot Shoe Adapter F<sub>G</sub>****Extension Cord F5P**Hot Shoe Adapter F<sub>G</sub>**Off-camera Shoe Adapter F**

Use the adapters and cords to use the external flash away from the camera.



Off-camera Shoe Adapter F

**Off-Camera Shoe Clip CL-10**

This large clip is used for setting the AF540FGZ or AF360FGZ on a desk or table.



Off-Camera Shoe Clip CL-10

**Remote Control**

Used in Remote Control shooting.

Operating range of the remote control:

From the front of the camera: Approx. 4 m

From the back of the camera: Approx. 5 cm

**Remote Control F****Remote Control Waterproof O-RC1**



---

**Camera Case and Strap**

**Camera Case O-CC115**

**Camera Strap O-ST115 (\*)**

---

**Others**

**Hot Shoe Cover Fk (\*)**

**USB Cable I-USB7 (\*)**

**AV Cable I-AVC7**

































Error Messages	Description
Memory card full	The SD Memory Card is full and no more images can be saved. Insert a new SD Memory Card or delete unwanted images. (p.43, p.165) You may be able to save more images if you change the image capture settings. (p.120)
No more image/movie can be saved	The SD Memory Card has 65,535 image/movie files saved on it and no more files can be saved. Insert a new SD Memory Card or delete unwanted files. (p.43, p.165)
No image	There are no images that can be played back on the SD Memory Card.
This image cannot be displayed	You are trying to play back an image in a format not supported by this camera. You may be able to play it back on another brand of camera or a computer.
No card in the camera	There is no SD Memory Card inserted in the camera. (p.43)
Memory card error	The SD Memory Card has a problem, and image capture and playback are impossible. It may be viewable on a computer but not with this camera.
Card is not formatted	The SD Memory Card you have inserted is unformatted or has been formatted on another device and is not compatible with this camera. Use the card after formatting it with this camera. (p.198)
Card is locked	The write-protect switch on an SD Memory Card you have inserted is locked. Unlock the SD Memory Card.
This image cannot be enlarged	You are trying to enlarge an image that cannot be enlarged.
This image is protected	You are trying to delete an image that is protected. Remove protection from the image. (p.199)
Not enough battery power remaining to activate Pixel Mapping	Appears during Pixel Mapping if the battery level is insufficient. Install a fully charged battery, or use the AC adaptor kit K-AC115 (optional). (p.40)

Error Messages	Description
Not enough battery power remaining to update the firmware	Appears when trying to update the firmware if the battery level is insufficient. Install a fully charged battery, or use the AC adaptor kit K-AC115 (optional). (p.40)
Unable to update firmware. There is a problem with the firmware update file	Unable to update the firmware. The update file is damaged. Try downloading the update file again. (p.197)
Image folder cannot be created	The maximum folder number (999) and file number (9999) are being used, and no more images can be saved. Insert a new SD Memory Card or format the card. (p.198)
Unable to store image	The image could not be saved because of an SD Memory Card error.
Settings not stored	The DPOF settings could not be saved because SD Memory Card is full. Delete unwanted images and perform DPOF setting again. (p.165)
The operation could not be completed correctly	The camera was unable to measure the manual white balance (p.125) or use HDR Capture (p.130). Try the operation again.
No more images can be selected	You cannot select 100 or more images at a time for Index (p.160) and Select & Delete (p.165).
No image can be processed	There are no images that can be processed using Digital Filter (p.174) or RAW Development (p.180) function.
This image cannot be processed	Appears when you try to perform Resize (p.172), Cropping (p.173), Digital Filter (p.174), Red-eye Edit (p.179) or RAW Development (p.180) for images captured with other cameras, or when you try to perform Resize or Cropping for minimum file size images.
The camera failed to create an image	The creation of an index print image failed. (p.160)
This function is not available in the current mode	You are trying to set a function that is not available when the capture mode is set to <b>AUTO</b> (Auto Picture), <b>SCN</b> (Scene) or  (Movie) mode.
The camera will turn off to prevent damage from overheating	The camera will turn off because its internal temperature gets too hot. Leave the camera turned off until it has had time to cool down before turning on the camera again.

In rare cases, the camera may not operate correctly due to static electricity. This can be remedied by taking the battery out and putting it back in again. After these procedures are done, if the camera operates correctly, it does not require any repairs.

We recommend checking the following items before contacting a service center.

Problem	Cause	Remedy
The camera does not turn on	Battery is not installed	Check if battery is installed. If not, install a fully charged battery.
	Battery is not installed properly	Check the orientation of battery. (p.38)
	The battery power is low	Install a fully charged battery, or use the AC adaptor kit K-AC115 (optional). (p.40)
The shutter cannot be released	The built-in flash is charging	Wait until charging is finished.
	There is no available space on the SD Memory Card	Insert an SD Memory Card with available space or delete unwanted images. (p.43, p.165)
	Recording	Wait until recording is finished.
Autofocus does not work	The subject is difficult to focus on	Autofocus cannot work well for subjects that have low contrast (the sky, white walls, etc.), dark colors, intricate designs, rapidly-moving objects or scenery shot through a window or a net-like pattern. Lock focus on another object located at the same distance as your subject, then aim at the target and press the shutter release button fully. Alternatively, use manual focus. (p.92)
	The subject is not in the focusing area	Position the subject in the focus frame on the monitor. If the subject is outside the focusing area, aim the camera at the subject and lock the focus, then compose a picture and press the shutter release button fully. (p.91)

Problem	Cause	Remedy
Autofocus does not work	The subject is too close	Move away from the subject and take a picture.
	The focus method is set to <b>MF</b>	Set [Focus Method] to <b>AF</b> . (p.86)
The focus cannot be locked	[Autofocus Method] is set to [Face Detection] or [Tracking]	Autofocus is not locked (focus lock) when [Autofocus Method] is set to [Face Detection] or [Tracking]. The camera will continue focusing on the subject while the shutter release button is pressed halfway. If there is a subject that you want to focus on, set [Autofocus Method] to [AF Select (25 Points)], [Select], or [Spot], and use the focus lock. (p.91)
	The capture mode is set to  ,  ,  ,  , or  of <b>SCN</b> mode.	Set the capture mode to any mode other than  (Moving Object),  (Night Snap),  (Pet),  (Kids) or  (Stage Lighting) of <b>SCN</b> (Scene) mode. (p.72)
The AE Lock function does not operate	The shutter speed is set to <b>Bulb</b>	Set the shutter speed to any mode other than <b>Bulb</b> . (p.78)
The built-in flash does not discharge	When the flash mode is set to  or  , the flash will not discharge if the subject is bright	Set the flash mode to  (Flash On) or  (Flash On+Red-eye Reduction). (p.57)
	The capture mode is set to  ,  ,  ,  ,  ,  ,  ,  , or  of <b>SCN</b> mode	Set <b>SCN</b> (Scene) mode to any mode other than  (Sunset),  (Blue Sky),  (Night Scene),  (Night Scene HDR),  (HDR),  (Backlight Silhouette),  (Candlelight),  (Stage Lighting) or  (Museum). (p.72)
The USB connection with a computer does not work properly	The USB connection mode is set to [PTP]	Set [USB Connection] in the [  Set-up 2] menu to [MSC]. (p.205)

Problem	Cause	Remedy
Shake Reduction does not work	The Shake Reduction function is off	Set [Shake Reduction] to on. (p.96)
	Shutter speed is too low for the Shake Reduction function to be effective when panning or shooting night scenes, etc.	Set [Shake Reduction] to off and use a tripod.
	The subject is too close	Move away from the subject, or turn off the Shake Reduction function and use a tripod.
The shooting settings cannot be changed	The quick dial is set to the position 1 to 4	When you use the quick dial to take pictures, priority is given to the settings saved in the quick dial. (p.139)

## Model Description

Type	Lens-interchangeable SL digital-still camera
Lens Mount	PENTAX bayonet Q-mount
Compatible Lens	Q-mount lenses

## Image Capture Unit

Image Sensor	Type: CMOS sensor with a primary color filter, Size: 1/2.3-inch
Effective Pixels	Approx. 12.4 megapixels
Total Pixels	Approx. 12.75 megapixels
Dust Removal	Image sensor cleaning using ultrasonic vibrations "DR II"
Sensitivity (Standard Output)	AUTO: ISO 125 to ISO 6400 (1/3 EV step) *Bulb: up to ISO 1600
Image Stabilizer	Sensor shift Shake Reduction

## File Formats

File Format	RAW (DNG), JPEG (Exif 2.3), DCF2.0 compliant																																											
Recorded Pixels	JPEG: <table border="0"> <tr> <td>16:9</td> <td>9M</td> <td>(4000×2248)</td> <td>6M</td> <td>(3456×1944)</td> </tr> <tr> <td></td> <td>4M</td> <td>(2688×1512)</td> <td>2M</td> <td>(1920×1080)</td> </tr> <tr> <td>3:2</td> <td>10M</td> <td>(4000×2664)</td> <td>8M</td> <td>(3456×2304)</td> </tr> <tr> <td></td> <td>5M</td> <td>(2688×1792)</td> <td>2M</td> <td>(1920×1280)</td> </tr> <tr> <td>4:3</td> <td>12M</td> <td>(4000×3000)</td> <td>9M</td> <td>(3456×2592)</td> </tr> <tr> <td></td> <td>5M</td> <td>(2688×2016)</td> <td>3M</td> <td>(1920×1440)</td> </tr> <tr> <td>1:1</td> <td>9M</td> <td>(2992×2992)</td> <td>6M</td> <td>(2592×2592)</td> </tr> <tr> <td></td> <td>4M</td> <td>(2016×2016)</td> <td>2M</td> <td>(1440×1440)</td> </tr> </table> RAW: <table border="0"> <tr> <td>4:3</td> <td>12M</td> <td>(4000×3000)</td> </tr> </table>	16:9	9M	(4000×2248)	6M	(3456×1944)		4M	(2688×1512)	2M	(1920×1080)	3:2	10M	(4000×2664)	8M	(3456×2304)		5M	(2688×1792)	2M	(1920×1280)	4:3	12M	(4000×3000)	9M	(3456×2592)		5M	(2688×2016)	3M	(1920×1440)	1:1	9M	(2992×2992)	6M	(2592×2592)		4M	(2016×2016)	2M	(1440×1440)	4:3	12M	(4000×3000)
16:9	9M	(4000×2248)	6M	(3456×1944)																																								
	4M	(2688×1512)	2M	(1920×1080)																																								
3:2	10M	(4000×2664)	8M	(3456×2304)																																								
	5M	(2688×1792)	2M	(1920×1280)																																								
4:3	12M	(4000×3000)	9M	(3456×2592)																																								
	5M	(2688×2016)	3M	(1920×1440)																																								
1:1	9M	(2992×2992)	6M	(2592×2592)																																								
	4M	(2016×2016)	2M	(1440×1440)																																								
4:3	12M	(4000×3000)																																										
Quality Level	RAW: DNG (12 bit) JPEG: ★★★ (Best), ★★ (Better), ★ (Good) RAW and JPEG simultaneously recordable																																											
Color Space	sRGB, AdobeRGB																																											
Storage Medium	SD, SDHC, and SDXC Memory Cards																																											
Storage Folder	Date (100_1018, 100_1019...)/ PENTX (100PENTX, 101PENTX...)																																											

**LCD Monitor**

Type	TFT color LCD monitor, wide angle viewing
Size	3.0 inches
Dots	Approx. 460,000 dots
Adjustment	Brightness and colors adjustable
Display	Field of View: approx. 100%, Grid display (4 × 4 Grid, Golden Section, Scale display), Bright/dark area warning, Histogram

**White Balance**

Auto	TTL by CMOS image sensor
Preset	Daylight, Shade, Cloudy, Fluorescent Light ( <b>D</b> : Daylight Color, <b>N</b> : Daylight White, <b>W</b> : Cool White, <b>L</b> : Warm White), Tungsten, Flash, <b>CTE</b> , Manual
Manual	Configuration on monitor
Fine Adjustment	Adjustable ±7 steps on A-B axis and G-M axis

**Focusing Mechanism**

Type	Contrast detection AF
Brightness Range	EV 1 to 18 (ISO125)
Focus Method	AF/MF switching
Autofocus Method	Face Detection, Tracking, AF Select (25 Points), Select, Spot
AF Assist Light	Dedicated LED AF assist light
MF Assist	Off/×2/×4

**Metering**

Type	TTL image sensor metering, multi-segment metering, center-weighted metering, and spot metering
Metering Range	EV 1.3 to 17 (ISO 125, F1.9 lens), +2 EV with Electronic Shutter enabled, +2 EV using the ND filter
Exposure Modes	Auto Picture modes: Standard, Portrait, Landscape, Macro, Night Scene Portrait, Night Scene, Blue Sky, Forest Scene modes: Portrait, Landscape, Macro, Moving Object, Night Scene Portrait, Sunset, Blue Sky, Night Scene, Night Scene HDR*, Night Snap, Food, Quick Macro*, Pet, Kids, Forest, Surf & Snow, HDR*, Backlight Silhouette, Candlelight, Stage Lighting, Museum Program, Shutter Priority, Aperture Priority, Manual, Bulb, Blur Control* *JPEG only
EV Compensation	±3 EV (1/3 EV step)
AE Lock	Can be assigned to the  button from the menu. Continuous as long as the shutter release button is pressed halfway.



Shutter	Lens shutter: 1/2000 - 30 seconds (1/3 EV step, 1/8000 - 30 seconds when Electronic Shutter is enabled), Bulb *When using a lens that has no lens shutter; shooting at 1/8000 - 2 seconds with the electronic shutter is available, Bulb shooting is not available.
Aperture	From wide open to F8 *Not available when using a lens that has no lens shutter.
ND Filter	Off/On *Not available when using a lens that has no lens shutter.

### Drive Modes

Mode Selection	Single frame, Continuous (Hi, Lo), Self-timer (12s, 2s), Remote Control (0 sec., 3 sec., continuous), Auto Bracketing (3 frames, remote control)
Continuous Shooting	Approx. 5 fps, JPEG ( $\frac{1}{12m}$ /★★★/Continuous Hi): up to 5 frames Approx. 1.5 fps, JPEG ( $\frac{1}{12m}$ /★★★/Continuous Lo): up to 100 frames

### Built-in Flash

Type	Built-in retractable P-TTL flash, Guide number: approx. 7 (ISO200/m), approx. 5.6 (ISO125/m) Angle of view coverage: equivalent to 28 mm in 35 mm format
Flash Modes	P-TTL, Red-eye Reduction, Slow-speed Sync, Trailing Curtain Sync
Sync Speed	Lens shutter: 1/2000 seconds, Electronic shutter: 1/13 seconds, Used with external flash unit: 1/250 seconds
Flash Exposure Compensation	-2.0 to +1.0 EV

### Capture Functions

Custom Image	Bright, Natural, Portrait, Landscape, Vibrant, Radiant, Muted, Bleach Bypass, Reversal Film, Monochrome, Cross Processing
Noise Reduction	High-ISO NR
Dynamic Range Setting	Highlight Correction, Shadow Correction
Lens Correction	Distortion Correction
Digital Filter	Toy Camera, High Contrast, Shading, Slim, HDR, Invert Color, Extract Color, Color, Water Color, Posterization, Fish-eye
HDR Capture	Auto, HDR 1, HDR 2
Multi-exposure	Number of shots: 2-9, Exposure adjusted automatically.
Interval Shooting	Shooting interval: 1 sec. to 24 hr., Start Interval setting: immediately, from the set time, Number of shots: up to 999 images

Smart Effect	Brilliant Color, Unicolor Bold, Vintage Color, Cross Processing, Warm Fade, Tone Expansion, Bold Monochrome, Water Color, Vibrant Color Enhance, USER 1-3
--------------	---

### Movie

File Format	MPEG-4 AVC/H.264
Recorded Pixels	<b>FullHD</b> (1920×1080, <b>16:9</b> , 30 fps), <b>HD</b> (1280×720, <b>16:9</b> , 30 fps), <b>VGA</b> (640×480, <b>4:3</b> , 30 fps)
Quality Level	★★★ (Best), ★★ (Better), ★ (Good)
Sound	Built-in monaural microphone
Recording Time	Up to 25 minutes; automatically stops recording if the internal temperature of the camera becomes high.
Custom Image	Bright, Natural, Portrait, Landscape, Vibrant, Radiant, Muted, Bleach Bypass, Reversal Film, Monochrome, Cross Processing
Digital Filter	Toy Camera, High Contrast, Shading, Slim, HDR, Invert Color, Extract Color, Color, Water Color, Posterization, Fish-eye
Interval Movie	Recording interval: 1 sec., 5 sec., 10 sec., 30 sec., 1 min., 5 min., 10 min., 30 min., 1 hr., Recording time: 5 sec. to 99 hr., Start Interval setting: immediately, from the set time

### Playback Functions

Playback View	Single frame, image comparison, multi-image display (4, 9, 20, 42, 90 segmentation), display magnification (up to 16×, scrolling and quick magnification available), rotating, histogram (Y histogram, RGB histogram), bright/dark area warning, detailed information display, folder display, calendar display, slideshow
Delete	Delete single image, delete all images, select & delete, delete folder, delete instant review image
Digital Filter	Monochrome, Toy Camera, High Contrast, Shading, Slim, HDR, Invert Color, Extract Color, Color, Water Color, Posterization, Fish-eye, Retro, Soft, Sketch Filter, Miniature, Frame Composite, Starburst, Base Parameter Adjustment
RAW Development	File Format (JPEG), Aspect Ratio, Color Space, Custom Image, White Balance, Sensitivity, High-ISO NR, Shadow Correction, Distortion Correction
Edit	Resize, Cropping (aspect ratio adjustment available), Index, Movie Editing (divide or delete selected frames), Capturing a JPEG still picture from a movie, Red-eye Edit, Save the RAW file data in the buffer memory

## Customization

Custom Functions	13 items
Mode Memory	12 items
Button/Dial Customization	Ⓞ/🗑 button: Green Button, Preview, One Push File Format, AE Lock, Enable AF Quick Dial: Smart Effect, Custom Image, Digital Filter, Aspect Ratio
World Time	World Time settings for 75 cities (28 time zones)
Language	English, French, German, Spanish, Portuguese, Italian, Dutch, Danish, Swedish, Finnish, Polish, Czech, Hungarian, Turkish, Greek, Russian, Korean, Traditional Chinese, Simplified Chinese, and Japanese

## Power Supply

Battery Type	Rechargeable Lithium-ion Battery D-LI68
AC Adapter	AC Adapter Kit K-AC115 (optional)
Battery Life	Number of recordable images (with 50% flash usage): approx. 230 images, (without flash usage): approx. 250 images Playback time: approx. 160 minutes * Using a new lithium-ion battery under the temperature at 23 °C, Tested in compliance with CIPA standard. Actual results may vary depending on the shooting conditions/circumstances.

## Interfaces

Connection Port	USB 2.0 (high-speed compatible)/AV output terminal, HDMI output terminal (Type D)
USB Connection	MSC/PTP
Video Output Format	NTSC/PAL

## Dimensions and Weight

Dimensions	Approx. 98.0 mm (W) × 57.5 mm (H) × 31.0 mm (D) (excluding the operation parts and protrusion)
Weight	Approx. 200 g (loaded and ready with the dedicated battery and SD Memory Card), Approx. 180 g (body only)

## Accessories

Package Contents	USB Cable I-USB7, Strap O-ST115, Rechargeable Lithium-ion Battery D-LI68, Battery Charger D-BC68P, Software (CD-ROM) S-SW115 <Mounted on the camera> Hot shoe cover F <sub>K</sub> , Body mount cover
Software	SILKYPIX Developer Studio 3.0 for PENTAX

## Approximate Image Storage Capacity

(When using a 2 GB SD Memory Card)

Aspect Ratio	Recorded Pixels	JPEG Quality			RAW
		★★★	★★	★	
16:9	9M (4000×2248)	561	1067	1797	90
	6M (3456×1944)	845	1607	2708	—
	4M (2688×1512)	1263	2402	4046	—
	2M (1920×1080)	2115	4020	6772	—
3:2	10M (4000×2664)	503	957	1613	88
	8M (3456×2304)	629	1196	2015	—
	5M (2688×1792)	998	1897	3196	—
	2M (1920×1280)	2115	4020	6772	—
4:3	12M (4000×3000)	418	796	1341	85
	9M (3456×2592)	561	1067	1797	—
	5M (2688×2016)	998	1897	3196	—
	3M (1920×1440)	1510	2871	4837	—
1:1	9M (2992×2992)	561	1067	1797	90
	6M (2592×2592)	845	1607	2708	—
	4M (2016×2016)	1263	2402	4046	—
	2M (1440×1440)	2115	4020	6772	—

\* The maximum number of recordable images is 65,535 images, regardless of the amount of available space on the SD Memory Card.

\* The number of storable images may vary depending on the subject, shooting conditions, shooting mode and SD Memory Card, etc.

## Symbols

[ Rec. Mode] menu	.... 65, 221
[ Movie] menu	.... 67, 109, 222
[ Playback] menu	.... 153, 223
[ Set-up] menu	..... 184, 224
[ <b>C</b> Custom Setting] menu	..... 68, 225
(Playback) button	..... 19, 21, 61
(Green/Delete) button	..... 19, 21, 62, 144
<b>Av</b> (EV Compensation) button	..... 19, 21, 79
<b>AUTO</b> Auto Picture	..... 54, 70
Standard	..... 70
Portrait	..... 70, 71
Landscape	..... 70, 71
Macro	..... 70, 71
Night Scene Portrait	... 70, 71
Sunset	..... 70, 71
Blue Sky	..... 70, 71
Forest	..... 70, 71
Moving Object	..... 71
Night Scene	..... 71
Night Scene HDR	..... 71
Night Snap	..... 71
Food	..... 71
Quick Macro	..... 71
Pet	..... 71
Kids	..... 71
Surf & Snow	..... 72
<b>HDR</b> HDR	..... 72
Backlight Silhouette	..... 72
Candlelight	..... 72
Stage Lighting	..... 72
Museum	..... 72
Movie	..... 111

## A

AC adapter	.....40
Accessories	.....228
Action in M Mode	.....147
Adding the date (DPOF)	.....202
AdobeRGB	.....123
AE Lock	.....82
AE Metering	.....84
AF area	.....89
AF Assist Light	.....17, 87
<b>AF</b> (Autofocus)	.....86
AF frame	.....55
AF Select (25 Points)	.....87
Aperture Priority mode <b>Av</b>	.....76
Aspect Ratio	.109, 120, 121, 173
Auto Bracketing	.....80
Auto Flash	.....57
Auto Picture mode <b>AUTO</b>	.....54, 70
Auto Power Off	.....190
<b>AWB</b> (White Balance)	.....124
Autofocus <b>AF</b>	.....86
Autofocus Method	.....87
<b>Av</b> (Aperture Priority) mode	...76
AV device	.....168

## B

Backlight Silhouette	.....72
Base Parameter Adj (Digital Filter)	.....175
Battery	.....37
<b>BC</b> (Blur Control) mode	.....73
Beep	.....186
Bleach Bypass (Custom Image)	.....131
Blue Sky	.....70, 71
Blur Control mode <b>BC</b>	.....73

Bold Monochrome (Smart Effect)	140
Bracketing shooting	80
Bright (Custom Image)	131
Bright areas	128
Bright/Dark Area warning	154, 191, 193
Brightness adjustment	128
Brilliant Color (Smart Effect)	140
Built-in flash	57
<b>Bulb</b> (Bulb)	78
Bulb shooting	78

## C

Calendar display	158
Camera shake	96, 110
Candlelight 	72
Capture mode	69
Card access lamp	17
Center-weighted metering	84
Charging the battery	37
City	189
Cleaning the sensor	227
Cloudy (White Balance)	124
Color (Digital Filter)	135, 174
Color Adjustment	193
Color Space	123
Computer	203
Connection cable cover	41
Continuous Autofocus	92
Continuous playback	162
Continuous Shooting	102
Contrast (Custom Image)	132
Control panel	24, 31
Correcting distortion	149
Creating new folders	201
Cropping images	173
Cross Processing (Custom Image)	131

Cross Processing (Smart Effect)	140
<b>CTE</b> (White Balance)	124
Custom Image	131
[C Custom Setting] menu	68, 225

## D

Dark areas	129
Date Adjustment	50
Date change	187
Daylight (White Balance)	124
Default settings	220
Delete	62, 165
Delete all images	167
Delete folder	166
Deleting single image	62
Destination	187
Detailed information display	27
Developing Raw images	180
Digital Filter	135, 174
Direct keys	30, 64, 220
Discharge	57
Display language	190
Distortion Correction	149
DPOF	201
D-Range Setting	129
Drive Mode	64
Dust Removal	227
Dynamic Range	76, 128

## E

E-dial	19, 21
E-dial in Program	146
Effect	140
Electronic Shutter	226
Enable AF	90
Enlarge Instant Review	155, 193
Error messages	232
EV Compensation	79

<b>Av</b> (EV Compensation) button	19, 21, 79
Exposure	75
Exposure Bracketing	80
Exposure mode	76
External flash	215
Extract Color (Digital Filter)	135, 174

## F

Face Detection	87
File Format	121
File No.	200
Filter	135, 174
Firmware	197
Firmware Version Info	197
Fish-eye (Digital Filter)	135, 175
Flash	57, 211
Flash (White Balance)	124
Flash Exposure Compensation	58
Flash Off	57
Flash On	57
Flash pop-up switch	19, 59
Flicker Reduction	29
Fluorescent Light (White Balance)	124
Focus Lock	91
Focus Method	86
Focus Settings	87
Focusing	86
Focusing ring	92
Folder display	157
Folder Name	200
Food	71
Forest	70, 71
Format	198
Four-way controller (   )	19, 21, 30, 64

Frame Composite (Digital Filter)	175
Frame rate	109

## G











(Green/Delete) button	19, 21, 62, 144
Guide Display	69, 191
Guide indicators	29
Guide number	213

## H



HDMI output format	170
HDMI terminal	168
<b>HDR</b>	72
HDR (Digital Filter)	135, 174
HDR Capture	130
High Contrast (Digital Filter)	135, 174
High Dynamic Range	130
High/Low Key Adj (Custom Image)	132
High-ISO NR	85
Highlight Correction	128
Histogram	26, 28, 191, 193
Hometown	187
Hot shoe	17
Hue (Custom Image)	132

## I

Image Capture Settings	120
Image Comparison	159
Image finishing tone	131
Image Rotation	164
Image storage capacity	40, 242
Index	160
<b>INFO</b> button	19, 21, 22, 25
Initial settings	48
Initializing a memory card	198
Installing software	207
Instant Review	55, 192

- Interval Movie ..... 113
- Interval Shooting ..... 104
- Invert Color (Digital Filter) ..... 135, 174
- ISO sensitivity ..... 75
- J**
- JPEG ..... 121
- JPEG Quality ..... 123
- JPEG Recorded Pixels ..... 122
- K**
- Kids  ..... 71
- L**
- Landscape  ..... 70, 71
- Landscape (Custom Image) ..... 131
- Language setting ..... 48, 190
- LCD Display Settings ..... 193
- LCD View Options ..... 191
- Leading Curtain Sync ..... 213
- Lens ..... 45, 226
- Lens information contacts ..... 17
- Lens mount index ..... 45
- Lens unlock button ..... 19, 46
- Locking the exposure ..... 82
- Locking the focus ..... 91
- M**
- M** (Manual) mode ..... 76
- Macintosh ..... 204
- Macro  ..... 70, 71
- Manual focus **MF** ..... 86, 92
- Manual mode **M** ..... 76
- Manual White Balance ..... 125
- Memory ..... 195
- Memory Card ..... 43
- MENU** button ..... 19, 21, 32
- Menu operation ..... 32
- Menu page display ..... 192
- Metering method ..... 84
- MF Assist ..... 93
- MF** (Manual focus) ..... 86, 92
- Microphones ..... 17
- Miniature (Digital Filter) ..... 175
- Mode dial ..... 19, 69
- Monitor ..... 22, 193
- Monochrome (Custom Image) ..... 131
- Monochrome (Digital Filter) ..... 174
- Movie ..... 109
- Movie Editing ..... 117
- [ Movie] menu ..... 67, 109, 222
- Movie SR ..... 110
- Moving Object  ..... 71
- MSC ..... 205
- Multi-exposure ..... 107
- Multi-image display ..... 156
- Multi-segment metering ..... 84
- Museum  ..... 72
- Muted (Custom Image) ..... 131
- N**
- Natural (Custom Image) ..... 131
- ND Filter ..... 148
- Night Scene  ..... 71
- Night Scene HDR  ..... 71
- Night Scene Portrait  ..... 70, 71
- Night Snap  ..... 71
- Noise Reduction ..... 85
- NTSC ..... 169
- O**
- OK** button ..... 19, 21
- One Push File Format ..... 145
- Optional accessories ..... 228
- P**
- P** (Program) mode ..... 76
- PAL ..... 169
- PC/AV terminal ..... 168, 206
- Pet  ..... 71



Pixel Mapping .....	194
Pixels .....	109, 122
Playback .....	61
 (Playback) button .....	19, 21, 61
 [Playback] menu ....	153, 223
Playback mode palette .....	152, 223
Playback time .....	40
Playing back movies .....	115
Portrait  .....	70, 71
Portrait (Custom Image) .....	131
Posterization (Digital Filter) .....	135, 175
Power Saving .....	190
Power supply .....	47
Power switch .....	19, 21, 47
Preview .....	94, 144
Printing .....	201
Product registration .....	209
Program mode <b>P</b> .....	76
Protect .....	199
Provided software .....	207
PTP .....	205
P-TTL (Auto Flash) .....	216

## Q

Quality Level .....	123
Quick dial .....	19, 138
Quick Macro  .....	71
Quick Zoom .....	154





## R

Radiant (Custom Image) .....	131
RAW .....	121
RAW Development .....	180
 [Rec. Mode] menu ....	65, 221
Recorded Pixels .....	109, 122
Red-eye Edit .....	179
Red-eye Reduction .....	57, 216
Release-priority .....	88

Remote Control .....	100
Remote control receiver .....	17
Reset .....	196
Resize .....	172
Retro (Digital Filter) .....	175
Reversal Film (Custom Image) .....	131
Rotation .....	164

## S

Saturation (Custom Image) .....	132
Save Cross Processing .....	134
Save Settings .....	142
Save Thumbnail .....	143
Saving frequently used functions .....	138
Saving RAW image .....	61
<b>SCN</b> (Scene) mode .....	71
SD Memory Card .....	43
Select & Delete .....	165
Select (Autofocus Method) .....	87
Self-timer .....	98
Self-timer lamp .....	17
Sensitivity .....	75
 [Set-up] menu .....	184, 224
Shade (White Balance) .....	124
Shading (Digital Filter) .....	135, 174
Shadow Correction .....	129
Shake Reduction .....	96, 110
Sharpness (Custom Image) .....	132
Shooting information .....	22
Show Grid .....	191
Shutter Priority mode <b>Tv</b> .....	76
Shutter release button .....	19, 21
SILKYPIX Developer Studio .....	207
Sketch Filter (Digital Filter) ...	175
Slideshow .....	162

Slim (Digital Filter) .....	135, 174
Slow-speed Sync .....	57, 212
Smart Effect .....	140
Soft (Digital Filter) .....	175
Software .....	207
Sound .....	186
Sound Effects .....	186
Speaker .....	17
Specifications .....	237
Spot (Autofocus Method) .....	87
Spot metering .....	84
sRGB .....	123
Stage Lighting  .....	72
Standard  .....	70
Standard display .....	22
Starburst (Digital Filter) .....	175
Strap .....	36
Sunset  .....	70, 71
Surf & Snow  .....	72

## T

Tone Expansion (Smart Effect) .....	140
Toning (Custom Image) .....	133
Toy Camera (Digital Filter) .....	135, 174
Tracking .....	87
Trailing Curtain Sync .....	57, 213
Tungsten (White Balance) ...	124
Tv (Shutter Priority) mode .....	76

## U

Unicolor Bold (Smart Effect) .....	140
Updating software .....	197
USB Connection .....	205
USB Connection mode .....	205
USER .....	142

## V

Vibrant (Custom Image) .....	131
Vibrant Color Enhance (Smart Effect) .....	140
Video Output Format .....	169
Video terminal .....	168
Vintage Color (Smart Effect) .....	140

## W

Warm Fade (Smart Effect) .....	140
Water Color (Digital Filter) .....	135, 174
Water Color (Smart Effect) ...	140
White Balance .....	124
Windows .....	204
World Time .....	187
Write-protect .....	5

## Z

Zoom display .....	155
Zoom lens .....	56

All PENTAX cameras purchased through authorized bona fide photographic distribution channels are guaranteed against defects of material or workmanship for a period of twelve months from date of purchase. Service will be rendered, and defective parts will be replaced without cost to you within that period, provided the equipment does not show evidence of impact, sand or liquid damage, mishandling, tampering, battery or chemical corrosion, operation contrary to operating instructions, or modification by an unauthorized repair shop. The manufacturer or its authorized representatives shall not be liable for any repair or alterations except those made with its written consent and shall not be liable for damages from delay or loss of use or from other indirect or consequential damages of any kind, whether caused by defective material or workmanship or otherwise; and it is expressly agreed that the liability of the manufacturer or its representatives under all guarantees or warranties, whether expressed or implied, is strictly limited to the replacement of parts as hereinbefore provided. No refunds will be made on repairs by non-authorized PENTAX service facilities.

## Procedure During 12-month Warranty Period

Any PENTAX which proves defective during the 12-month warranty period should be returned to the dealer from whom you purchased the equipment or to the manufacturer. If there are no representatives of the manufacturer in your country, send the equipment to the manufacturer, with postage prepaid. In this case, it will take a considerable length of time before the equipment can be returned to you owing to the complicated customs procedures required. If the equipment is covered by warranty, repairs will be made and parts replaced free of charge, and the equipment will be returned to you upon completion of servicing. If the equipment is not covered by warranty, regular charges of the manufacturer or of its representatives will apply. Shipping charges are to be borne by the owner. If your PENTAX was purchased outside of the country where you wish to have it serviced during the warranty period, regular handling and servicing fees may be charged by the manufacturer's representatives in that country. Notwithstanding this, your PENTAX returned to the manufacturer will be serviced free of charge according to this procedure and warranty policy. In any case, however, shipping charges and customs clearance fees to be borne by the sender. To prove the date of your purchase when

required, please keep the receipt or bills covering the purchase of your equipment for at least a year. Before sending your equipment for servicing, please make sure that you are sending it to the manufacturer's authorized representatives or their approved repair shops, unless you are sending it directly to the manufacturer. Always obtain a quotation for the service charge, and only after you accept the quoted service charge, instruct the service station to proceed with the servicing.

- **This warranty policy does not affect the customer's statutory rights.**
- **The local warranty policies available from PENTAX distributors in some countries can supersede this warranty policy. Therefore, we recommend that you review the warranty card supplied with your product at the time of purchase, or contact the PENTAX distributor in your country for more information and to receive a copy of the warranty policy.**



The CE Mark is a Directive conformity mark of the European Union.

**For customers in USA****STATEMENT OF FCC COMPLIANCE**

This device complies with Part 15 of the FCC Rules. Operation is subject to the following two conditions: (1) This device may not cause harmful interference, and (2) this device must accept any interference received, including interference that may cause undesired operation.

Changes or modifications not approved by the party responsible for compliance could void the user's authority to operate the equipment.

This equipment has been tested and found to comply with the limits for a Class B digital device, pursuant to part 15 of the FCC Rules.

These limits are designed to provide reasonable protection against harmful interference in a residential installation. This equipment generates, uses and can radiate radio frequency energy and, if not installed and used in accordance with the instructions, may cause harmful interference to radio communications. However, there is no guarantee that interference will not occur in a particular installation.

If this equipment does cause harmful interference to radio or television reception, which can be determined by turning the equipment off and on, the user is encouraged to try to correct the interference by one or more of the following measures:

- Reorient or relocate the receiving antenna.
- Increase the separation between the equipment and receiver.
- Connect the equipment into an outlet on a circuit different from that to which the receiver is connected.

\* Consult the dealer or an experienced radio/TV technician for help.

**For customers in Canada**

This Class B digital apparatus complies with Canadian ICES-003.

**Pour les utilisateurs au Canada**

Cet appareil numérique de la classe B est conforme à la norme NMB-003 du Canada.

**FOR CALIFORNIA, U.S.A. ONLY**

Perchlorate Material-special handling may apply.

The lithium battery used in this camera contains perchlorate material, which may require special handling.

See [www.dtsc.ca.gov/hazardouswaste/perchlorate](http://www.dtsc.ca.gov/hazardouswaste/perchlorate)

**Declaration of Conformity**  
According to 47CFR, Parts 2 and 15 for  
**Class B Personal Computers and Peripherals**

We: PENTAX Imaging Company  
A Division of PENTAX of America, Inc.

Located at: 600 12<sup>th</sup> Street, Suite 300  
Golden, Colorado 80401 U.S.A.  
Phone: 303-799-8000 FAX: 303-790-1131

Declare under sole responsibility that the product identified herein complies with 47CFR Parts 2 and 15 of the FCC rules as a Class B digital device. Each product marketed is identical to the representative unit tested and found to be compliant with the standards. Records maintained continue to reflect the equipment being produced can be expected to be within the variation accepted, due to quantity production and testing on the statistical basis as required by 47CFR §2.909. Operation is subject to the following two conditions: (1) This device may not cause harmful interference, and (2) This device must accept any interference received, including interference that may cause undesired operation. The above named party is responsible for ensuring that the equipment complies with the standards of 47CFR §15.101 to §15.109.

Product Name: PENTAX Digital Still Camera

Model Number: PENTAX Q

Contact person: Customer Service Manager

Date and Place: June, 2011, Colorado

## Information for Users on Collection and Disposal of Old Equipment and Used Batteries



### 1. In the European Union

These symbols on the products, packaging and/or accompanying documents mean that used electrical and electronic equipments and batteries should not be mixed with general household waste.

Used electrical/electronic equipments and batteries must be treated separately and in accordance with legislation that requires proper treatment, recovery and recycling of these products.

Following the implementation by member states, private households within the EU states may return their used electrical/electronic equipments and batteries to designated collection facilities free of charge\*.

In some countries your local retailer may also take back your old product free of charge if you purchase a similar new one.

\*Please contact your local authority for further details.



By disposing of this product correctly you will help ensure that the waste undergoes the necessary treatment, recovery and recycling and thus prevent potential negative effects on the environment and human health which could otherwise arise due to inappropriate waste handling.

### 2. In other countries outside the EU

These symbols are only valid in the European Union. If you wish to discard these items, please contact your local authorities or dealer and ask for the correct method of disposal.



For Switzerland: Used electrical/electronic equipment can be returned free of charge to the dealer, even when you don't purchase a new product. Further collection facilities are listed on the home page of [www.swico.ch](http://www.swico.ch) or [www.sens.ch](http://www.sens.ch).

Note for the battery symbol (bottom two symbol examples):  
This symbol might be used in combination with a designation for the chemical element or compound in use. In this case you have to comply with the requirement set by the Directive for the chemicals involved.

# Memo



# Memo

**HOYA CORPORATION**  
**PENTAX Imaging Systems Division**

2-35-7, Maeno-cho, Itabashi-ku, Tokyo 174-8639, JAPAN  
(<http://www.pentax.jp>)

**PENTAX Europe Imaging Systems S.A.S.** 112 Quai de Bezons, B.P. 204, 95106 Argenteuil Cedex, FRANCE  
**(European Headquarters)** (HQ - <http://www.pentax.eu>)  
(France - <http://www.pentax.fr>)

**PENTAX Imaging Systems GmbH** Julius-Vosseler-Strasse 104, 22527 Hamburg, GERMANY  
(<http://www.pentax.de>)

**PENTAX Imaging Systems Limited** PENTAX House, Heron Drive, Langley, Slough, Berks SL3 8PN, U.K.  
(<http://www.pentax.co.uk>)

**PENTAX Imaging Company**  
**A Division of PENTAX of America, Inc.**

(Headquarters)  
600 12th Street, Suite 300 Golden, Colorado 80401, U.S.A.  
(PENTAX Service Department)  
250 North 54th Street Chandler, Arizona 85226, U.S.A.  
(<http://www.pentaximaging.com>)

**PENTAX Canada Inc.** 1770 Argentia Road Mississauga, Ontario L5N 3S7, CANADA (<http://www.pentax.ca>)

**PENTAX Trading (SHANGHAI) Limited** 23D, Jun Yao International Plaza, 789 Zhaojiabang Road, Xu Hui District, Shanghai, 200032 CHINA  
(<http://www.pentax.com.cn>)

<http://www.pentax.jp/english>

• Specifications and external dimensions are subject to change without notice.