

PENTAX



Digital Camera

Optio WG-2 GPS

Optio WG-2

Operating Manual



To ensure the best performance from your camera, please read the Operating Manual before using the camera.

Thank you for purchasing this PENTAX Digital Camera. Please read this manual before using the camera in order to get the most out of all the features and functions. Keep this manual safe, as it can be a valuable tool in helping you to understand all the camera's capabilities.

This operating manual applies to Optio WG-2 GPS and Optio WG-2. The illustrations used in this manual are those of Optio WG-2 GPS.

Regarding copyrights

Images taken using the PENTAX Digital Camera that are for anything other than personal enjoyment cannot be used without permission according to the rights as specified in the Copyright Act. Please take care, as there are cases where limitations are placed on taking pictures even for personal enjoyment during demonstrations, performances or of items on display. Images taken with the purpose of obtaining copyrights also cannot be used outside the scope of use of the copyright as laid out in the Copyright Act, and care should be taken here also.

Regarding trademarks

- SDXC logo is a trademark of SD-3C, LLC.
- Microsoft and Windows are registered trademarks of Microsoft Corporation in the United States and other countries. Windows Vista is either a registered trademark or trademark of Microsoft Corporation in the United States and/or other countries.
- Macintosh and Mac OS are trademarks of Apple Inc., registered in the U.S. and other countries.
- ArcSoft®, and its logo are either the registered trademark or trademark of ArcSoft Inc. in the United States and/or other countries.
- HDMI, the HDMI logo, and High-Definition Multimedia Interface are trademarks or registered trademarks of HDMI Licensing, LLC in the United States and/or other countries.
- Eye-Fi, the Eye-Fi logo and Eye-Fi *connected* are trademarks of Eye-Fi, Inc.
- This product supports PRINT Image Matching III. PRINT Image Matching enabled digital still cameras, printers and software help photographers to produce images more faithful to their intentions. Some functions are not available on printers that are not PRINT Image Matching III compliant. Copyright 2001 Seiko Epson Corporation. All Rights Reserved. PRINT Image Matching is a trademark of Seiko Epson Corporation. The PRINT Image Matching logo is a trademark of Seiko Epson Corporation.
- This product is licensed under the AVC Patent Portfolio License for the personal use of a consumer or other uses in which it does not receive remuneration to (i) encode video in compliance with the AVC standard ("AVC video") and/or (ii) decode AVC video that was encoded by a consumer engaged in a personal activity and/or was obtained from a video provider licensed to provide AVC video. No license is granted or shall be implied for any other use. Additional information may be obtained from MPEG LA, LLC. See <http://www.mpegla.com>.
- All other brands or product names are trademarks or registered trademarks of their respective companies.
- In this manual, the TM and ® marks are not specified.

Regarding Product Registration

In order to better serve you, we request that you complete the product registration, which can be found on the CD-ROM supplied with the camera or on the PENTAX website. Thank you for your cooperation.
Refer to "Product Registration on the Internet" (p.201) for more information.

To users of this camera

- Do not use or store this device in the vicinity of equipment that generates strong electromagnetic radiation or magnetic fields.
Strong static charges or the magnetic fields produced by equipment such as radio transmitters could interfere with the monitor, damage the stored data, or affect the product's internal circuitry and cause camera misoperation.
- The liquid crystal panel used in the display is manufactured using extremely high precision technology. Although the level of functioning pixels is 99.99% or better, you should be aware that 0.01% or fewer of the pixels may not illuminate or may illuminate when they should not. However, this has no effect on the recorded image.
- A band of light may appear on the display if the camera is aimed at a bright subject. This is known as a smear, but it is not a malfunction.
- There is a possibility that the illustrations and the display screen in this manual are different from the actual product.
- In this manual, SD Memory Cards, SDHC Memory Cards and SDXC Memory Cards are referred to as SD Memory Cards.
- In this manual, the generic term "computer(s)" refers to either a Windows PC or a Macintosh hereafter.
- In this manual, the term "battery(ies)" refers to any type of batteries used for this camera and accessories.

Using Your Camera Safely

We have paid close attention to the safety of this product. When using this product, we request your special attention regarding items marked with the following symbols.



Warning

This symbol indicates that violating this item could cause serious personal injuries.



Caution

This symbol indicates that violating this item could cause minor or medium personal injuries, or loss of property.

About the Camera

Warning

- Do not attempt to take the camera apart or modify the camera. High voltages are present within the camera, and there is a danger of electric shock if the camera is taken apart.
- If the inside of the camera should become exposed as a result of, for example, the camera being dropped, please do not under any circumstances touch such exposed portions, as there is a danger of receiving an electric shock.
- Wrapping the strap of the camera around your neck is also dangerous. Please take care that small children do not hang the strap around their necks.
- If any irregularities occur during use, such as smoke or a strange odor, stop use immediately, remove the battery or the AC adapter, and contact your nearest PENTAX Service Center. Continuing to use the product can cause a fire or electric shock.

Caution

- Do not place your finger on the flash when it is discharging as there is a risk of burns.
- Do not discharge the flash while it is touching your clothing as there is a risk of discoloring.
- Some portions of the camera heat up during use, so please take care, as there is a risk of low temperature burns if such portions are held for long periods of time.
- Should the LCD be damaged, be careful of glass fragments. Also, be careful not to allow the liquid crystal to get on your skin, in your eyes, or in your mouth.
- Depending on your individual factors or physical condition, the use of the camera may cause itching, rashes or blisters. In case of any abnormality, stop using the camera and get medical attention immediately.

About the Battery Charger and the AC Adapter

Warning

- Always use the battery charger and AC adapter exclusively developed for this product, with the specified power and voltage. Using a battery charger or AC adapter not exclusive to this product, or using the exclusive battery charger or AC adapter with an unspecified power or voltage can cause a fire, electric shock, or camera breakdown. The specified voltage is 100-240V AC.
- Do not disassemble or modify the product. This can cause a fire or electric shock.
- If the generation of smoke or strange odor from the product or other abnormality occurs, immediately discontinue its use and consult a PENTAX Service Center. Continuing to use the product can cause a fire or electric shock.
- If water should happen to get inside the product, consult a PENTAX Service Center. Continuing to use the product can cause a fire or electric shock.
- If a thunder storm should occur while using the battery charger or AC adapter, unplug the AC plug cord and discontinue use. Continuing to use the product can cause damage to the equipment, fire, or electric shock.
- Wipe off the plug of the AC plug cord if it becomes covered with dust. Dust on the plug may cause a fire.

Caution

- Do not place heavy objects on the AC plug cord, allow heavy objects to drop onto it or allow the AC plug cord to become damaged due to excessive bending. If the AC plug cord becomes damaged, consult a PENTAX Service Center.
- Do not short or touch the output terminals of the product while it is still plugged in.
- Do not plug in the AC plug cord with wet hands. This can cause an electric shock.
- Do not subject the product to strong impacts or allow it to drop onto a hard surface. This can cause a malfunction.
- Do not use the battery charger to charge a battery other than a rechargeable lithium-ion battery D-LI92. This can cause overheating, explosion, or battery charger failure.
- To reduce the risk of hazards, use only a CSA/UL certified power supply cord set, cord is Type SPT-2 or heavier, minimum NO.18 AWG copper, one end with a molded-on male attachment plug cap (with a specified NEMA configuration), and the other is provided with a molded-on female connector body (with a specified IEC nonindustrial type configuration) or the equivalent.

About the Battery

Warning

- Be sure to store the battery out of the reach of small children. Placing it in their mouths may cause an electric shock.
- If any leakage from the battery should come in contact with your eyes, it may cause a loss of sight. Flush your eyes with clean water and get medical attention immediately. Do not rub them.

Caution

- Only use the specified battery with this camera. Use of other batteries may cause an explosion or fire.
- Do not disassemble the battery. Disassembling the battery may cause an explosion or leakage.
- Remove the battery from the camera immediately if it becomes hot or begins to smoke. Be careful not to burn yourself during removal.
- Keep wires, hairpins, and other metal objects away from the + and - contacts of the battery.
- Do not short the battery or dispose of the battery in fire. This can cause an explosion or fire.
- If any leakage from the battery should come in contact with skin or clothes, it may cause irritation to the skin. Wash the affected areas thoroughly with water.
- Precautions for D-LI92 Battery Usage:
 - BATTERY MAY EXPLODE OR FIRE IF MISTREATED.
 - DO NOT DISASSEMBLE OR DISPOSE OF IN FIRE.
 - DO NOT CHARGE EXCEPT SPECIFIED CHARGING CONDITION.
 - DO NOT HEAT ABOVE 140°F / 60°C, OR SHORT CIRCUIT.
 - DO NOT CRUSH OR MODIFY.

Keep the Camera and Accessories Out of the Reach of Small Children

Warning

- Be sure to keep the camera and its accessories out of the reach of small children.
 1. Injuries may result from the product falling or from unexpected movement.
 2. Suffocation may result from wrapping the strap around the neck.
 3. Small accessories such as battery or an SD Memory Card may be swallowed. Seek medical attention immediately if an accessory is accidentally swallowed.

Care to be Taken During Handling

Before Using Your Camera

- When traveling, take the Worldwide Service Network listing that is included in the package. This will be useful if you experience problems abroad.
- When the camera has not been used for a long time, confirm that it is still working properly, particularly prior to taking important pictures (such as at a wedding or when traveling). Contents of the recording cannot be guaranteed if recording, playback or transferring your data to a computer, etc. is not possible due to a malfunction of your camera or recording media (SD Memory Card), etc.
- The lens on this camera is not interchangeable. The lens is not removable.

About the Battery and Battery Charger

- Storing the battery fully charged may decrease the battery performance. Avoid storing it especially in high temperatures.
If the battery is left inserted and the camera is not used for a long time, the battery will over-discharge and shorten the battery's service life.
- Charging the battery a day before use or on the day of use is recommended.
- The AC plug cord supplied with the camera is for exclusive use with the battery charger D-BC92. Do not use it with any other equipment.

Precautions on Carrying and Using Your Camera

- Hot and humid places should be avoided. Particular care should be taken regarding vehicles, which can become very hot inside.
- Ensure that the camera is not subjected to substantial vibrations, shocks, or pressure as this may cause damage, malfunction, or a loss in waterproof performance. Place the camera on a cushion for protection when the camera is subjected to the vibrations of a motorbike, car, ship, etc. If the camera is subjected to substantial vibrations, shocks, or pressure, take your camera to your nearest PENTAX Service Center and have it checked.
- The temperature range in which the camera can be used is -10°C to 40°C (14°F to 104°F).
- The liquid crystal display will become black at high temperatures but will return to normal at normal temperatures.
- The response speed of the liquid crystal display becomes slow at low temperatures. This is due to the properties of the liquid crystal and is not a malfunction.

- If the camera is subjected to rapid temperature changes, condensation may form on the inside and outside of the camera. Therefore put the camera in a bag or plastic bag and take the camera out when the difference in temperature has subsided.
- Avoid contact with garbage, mud, sand, dust, water, toxic gases, or salts. These could cause the camera to breakdown. Wipe the camera to dry off any rain or water drops.
- Please do not press forcefully on the display. This could cause it to break or malfunction.
- Be careful not to sit down with the camera in your back pocket as this may damage the exterior of the camera or the display.
- When using a tripod with the camera, be careful not to overtighten the screw in the tripod socket on the camera.

Cleaning Your Camera

- Do not clean the product with organic solvents such as thinner, alcohol or benzene.
- Use a lens brush to remove dust accumulated on the lens. Never use a spray blower for cleaning as it may damage the lens.

Storing Your Camera

- Avoid storing the camera where pesticides and chemicals are handled. Remove the camera from its case and store it in a well-ventilated place to prevent the camera from becoming moldy during storage.
- Avoid using or storing the camera where it may be exposed to static electricity or electrical interference.
- Avoid using or storing the camera in direct sunlight or in locations where it may be exposed to rapid changes in temperature or to condensation.

Other Precautions

- Periodic inspections are recommended every one to two years to maintain high performance.
- Please note that deleting data, or formatting the SD Memory Cards or the built-in memory does not completely erase the original data. Deleted files can sometimes be recovered using commercially available software. It is user's responsibility to ensure the privacy of such data.

- The SD Memory Card is equipped with a write-protect switch. Setting the switch to LOCK prevents new data from being recorded on the card, the stored data from being deleted, and the card from being formatted by the camera or a computer.

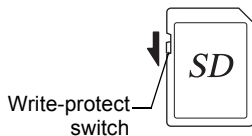

-  appears on the display when the card is write-protected.
- Care should be taken when removing the SD Memory Card immediately after using the camera, as the card may be hot.
 - Keep the battery/card cover closed and do not remove the SD Memory Card or turn the camera off while the data is being played back or saved to the card, or the camera is connected to a computer with the USB cable, as this may cause the data to be lost or the card to be damaged.
 - Do not bend the SD Memory Card or subject it to violent impact. Keep it away from water and store away from high temperature.
 - Do not remove the SD Memory Card during formatting as this may damage the card and render it unusable.
 - The data on the SD Memory Card may be deleted in the following circumstances. We do not accept any liability for data that is deleted.
 - (1) When the SD Memory Card is mishandled by the user.
 - (2) When the SD Memory Card is exposed to static electricity or electrical interference.
 - (3) When the SD Memory Card has not been used for a long time.
 - (4) When the SD Memory Card is ejected or the battery is removed while the data on the card is being recorded or accessed.
 - If it is not used for a long time, the data on the card may become unreadable. Be sure to regularly make a backup of important data on a computer.
 - When using an SD Memory Card with a slow recording speed, recording may stop while you are taking movies even when there is adequate space in the memory, or shooting and playback may take a long time.
 - Be sure to format SD Memory Cards that are unused or have been used on another camera. Refer to "Formatting the Memory" (p.174).

Regarding Waterproof, Dustproof, and Shockproof Design

- This camera is provided with a waterproof/dustproof design complying with JIS waterproof grade 8 and JIS dustproof grade 6 (equivalent to IP68).
- The camera satisfies the PENTAX drop test (1.5 m height onto a 5 cm thick plywood surface) complying with MIL-Standard 810F Method 516.5-Shock testing.
- The camera satisfies the PENTAX test for the waterproof, dustproof, and shockproof performance, but this does not guarantee it will remain free of trouble or damages.
- Waterproof performance is not guaranteed if the camera is exposed to impact such as being dropped or hit.

Precautions Before Using the Camera in the Water

Check the Following Before Going Near the Water

- Make sure that there are no cracks or scratches on the rubber seal of the battery/card and terminal covers.

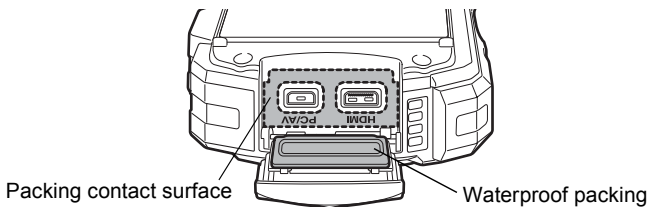
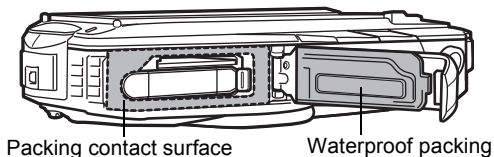

- Make sure there are no foreign objects (dust, sand, hair, lint or liquid) on the rubber seals or the surface they contact before closing the battery/card and terminal covers. Wipe off any foreign objects with a clean lint-free cloth.

- Close the battery/card and terminal covers properly until they click. Otherwise water may get in and damage the camera.

Be Careful Near the Water

- Avoid opening the battery/card and terminal covers when near the waterside or with wet hands. Wait until the camera is completely dry before changing the battery or the SD Memory Card. Avoid changing the battery or card where the camera is likely to get wet or dirty, and make sure that your hands are dry.
- The camera will sink if dropped in water, so be sure to attach the strap and slip the strap over your wrist when using the camera in or near water.
- To enhance the waterproof performance of the camera, the front of the lens is protected by glass. As any dirt or water on the glass will affect the quality of pictures taken, the glass should be kept clean at all times.

Precautions When Using the Camera in the Water

- Do not use the camera deeper than 12 meters underwater. Do not use the camera underwater for more than 120 minutes consecutively.
- Do not open the battery/card and terminal covers underwater.
- Do not use in hot water or in a hot spring.
- Do not apply excessive force to the camera, for example diving into water with it. Doing so may compromise the waterproof performance of the camera or cause the covers to open.
- Leaving the camera on the sand at the beach may cause the camera to exceed its operating temperature or cause the speaker or microphone to become blocked with sand.
- Avoid subjecting the camera to substantial vibrations, shocks, or pressure as this may cause a loss in waterproof performance. If the camera is subjected to substantial vibrations, shocks or pressure, take your camera to your nearest PENTAX Service Center and have it checked.
- Avoid getting sunscreen or sun oil on the camera as it may cause discoloration of the surface. If any oil gets on the camera, wash it off immediately with warm water.
- Sudden and extreme changes in temperature may cause condensation to form in and on the camera. Keep the camera in a bag or case to reduce the difference in temperature.



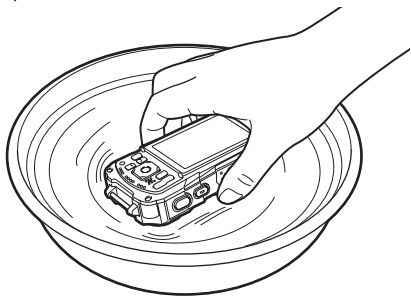

Precautions After Using the Camera in the Water

- Do not open the battery/card cover or terminal cover if the camera is wet. Wipe off any water with a clean lint-free cloth.
- The inside surface of the covers may get wet when they are opened. Wipe off any water that is on the cover.
- Wiping off the camera while there is sand or dust on it may scratch the surface of the camera. Make sure that the battery/card cover and terminal cover are firmly closed before washing the camera in tap water. After washing the camera, dry it with a soft cloth.
- Wipe off any dirt or sand on the waterproof packing or the packing contact surface. The camera's waterproof performance may be compromised by loose packing or cracks or dents in the packing or packing contact surface. If there is any such damage, contact your nearest PENTAX Service Center.
- If the camera is very dirty or after it has been used in the sea, make sure that it is turned off and the battery/card and terminal covers are firmly closed before rinsing it under running tap water or leaving it in a bowl of clean water for a short time (2 or 3 minutes).



- Avoid cleaning with agents such as soapy water, mild detergents, or alcohol as this may compromise the waterproof performance of the camera.
- To maintain the waterproof performance of the camera, you are recommended to change the waterproof packing once a year. Contact your nearest PENTAX Service Center regarding changing the packing. (A charge will be made.)
- The camera's accessories are not waterproof.

Contents

Using Your Camera Safely	1
Care to be Taken During Handling	5
Regarding Waterproof, Dustproof, and Shockproof Design.....	8
Precautions Before Using the Camera in the Water.....	8
Precautions When Using the Camera in the Water.....	9
Precautions After Using the Camera in the Water.....	10
Contents	11
Composition of the Operating Manual.....	17
Camera Features	18
Checking the Contents of the Package	22
Names of Parts.....	23
Names of Operating Parts.....	24
Monitor Indications	25
Getting Started	32
<hr/>	
Attaching the Carabiner Strap	32
Powering the Camera	33
Charging the Battery	33
Installing the Battery.....	34
Using the AC Adapter.....	37
Installing the SD Memory Card	39
Turning the Camera On and Off.....	41
Starting-up in Playback Mode	42
Initial Settings.....	43
Setting the Display Language	43
Setting the Date and Time.....	46
Common Operations	48
<hr/>	
Understanding the Button Functions.....	48
 Mode	48
 Mode	50
Switching Between  Mode and  Mode.....	52
Setting the Camera Functions	53
Operating the Menus.....	53
Menu List.....	55

Taking Still Pictures	60
Taking Pictures	60
Using the Zoom	63
Setting the Shooting Mode	65
Using the Face Detection Function	69
Taking Pictures in Basic Mode (Green Mode)	73
Taking Pictures of Your Pet (Pet Mode)	74
Taking Pictures of Text (Text Mode)	77
Taking Pictures in Digital Microscope Mode	77
Framing Your Pictures (Frame Composite Mode)	78
Taking Pictures at a Set Interval (Interval Shot)	79
Using the Self-timer	81
Taking a Series of Pictures (Continuous Shooting/Burst Shooting)	82
Taking Pictures Using the Remote Control Unit (Optional)	83
Taking Pictures with Automatic Exposure Adjustment (Auto Bracketing)	84
Using the Digital Wide Function (Digital Wide Mode)	85
Taking Panoramic Pictures (Digital Panorama Mode)	87
Setting the Shooting Functions	89
Setting the Rec. Mode Menu	89
Selecting the Flash Mode	90
Selecting the Focus Mode	91
Setting the Image Tone	95
Selecting the Number of Recorded Pixels	96
Selecting the Quality Level of Still Pictures	97
Adjusting the White Balance	98
Setting the AE Metering	99
Setting the Sensitivity	100
Setting AUTO ISO Range	101
Setting the Exposure (EV Compensation)	101
Correcting the Brightness (D-Range Setting)	102
Setting Pixel Track SR	103
Setting Blink Detection	104
Setting the Instant Review	104
Setting the Green Button	105
Setting the Image Sharpness (Sharpness)	108
Setting the Saturation/Tone Adjustment	108
Setting the Image Contrast (Contrast)	109
Setting the Date Imprint Function	109
Setting the IQ Enhancer Processing	110
Setting the Macro Light	110
Taking Pictures Underwater	111
Taking Underwater Pictures (Underwater Mode/Underwater Movie Mode)	111

Recording Movies	113
Recording Movies	113
Selecting the Number of Recorded Pixels and Frame Rate for Movies	115
Setting the Movie SR (Movie Shake Reduction) Function	116
Recording a Movie from Pictures Taken at a Set Interval (Interval Movie)	116
Using the High Speed Movie Function	119
Saving the Settings (Memory)	120
Playing Back and Deleting Images	122
<hr/>	
Playing Back Images	122
Playing Back Still Pictures	122
Playing Back a Movie	123
Multi-Image Display	124
Using the Playback Function	126
Slideshow	129
Rotating the Image	131
Zoom Playback	132
Zoom In on the Subject's Face Automatically (Face Close-up Playback)	133
Deleting Images and Sound Files	135
Deleting a Single Image/Sound File	135
Deleting Selected Images and Sound Files	136
Deleting All Images and Sound Files	137
Protecting Images and Sound Files from Deletion (Protect)	138
Connecting the Camera to AV Equipment	140
Connecting the Camera to a Video Input Terminal	140
Connecting the Camera to an HDMI Terminal	142
Editing and Printing	143
<hr/>	
Editing Images	143
Changing the Image Size (Resize)	143
Cropping Images	144
Processing Images to Make Faces Look Smaller	145
Using the Digital Filters	146
Using the HDR Filter	148
Using the Ink Rubbing Filter	148
Creating a Collage Image	149
Red-eye Compensation	152
Adding a Frame (Frame Composite)	153
Overlaying Your Original Frame on Still Pictures	156
Editing Movies	160
Copying Images and Sound Files	163
Printing Settings	165
Setting the Printing Service (DPOF)	165

Recording Sound (Voice Recording Mode)	168
Setting Voice Recording	168
Recording Sounds	169
Playing Back Sound	170
Adding a Voice Memo to Images	171
Recording a Voice Memo	171
Playing Back a Voice Memo	172

Settings

Camera Settings	173
Setting the Setting Menu	173
Formatting the Memory	174
Changing the Sound Settings	175
Changing the Date and Time	176
Setting the Alarm	178
Setting the World Time	180
Setting the Text Size on the Menu	182
Changing the Display Language	182
Changing the Naming System of the Folder	183
Changing the Naming System of the File	185
Changing the Video Output Format	187
Selecting the HDMI Output Format	188
Setting the Eye-Fi Communication	189
Adjusting the Brightness of the Display	189
Using the Power Saving Function	190
Setting Auto Power Off	190
Setting the Quick Zoom Function	191
Setting the Guide Display	191
Perform Pixel Mapping	192
Changing the Start-up Screen	193
Resetting to Default Settings (Reset)	194
Setting the Startup Shortcut	194
Displaying the Clock Display	195
Light up the LED	196

Setting Up Your Computer	197
Provided Software	197
System Requirements	198
Installing the Software	199
Setting the USB Connection Mode.....	202
Connecting to a Windows PC	204
Connecting the Camera and Your Windows PC	204
Transferring Images	205
Disconnecting the Camera from Your Windows PC.....	207
Starting "MedialImpression 3.5 for PENTAX"	208
Viewing Images	210
Details on How to Use "MedialImpression 3.5 for PENTAX"	211
Connecting to a Macintosh	212
Connecting the Camera and Your Macintosh.....	212
Transferring Images	213
Disconnecting the Camera from Your Macintosh.....	214
Starting "MedialImpression 2.1 for PENTAX"	215
Viewing Images	217
Details on How to Use "MedialImpression 2.1 for PENTAX"	217
Transferring Images Using an Eye-Fi Card	218
 Appendix	 220
<hr/> Functions Available for Each Shooting Mode	220
Messages	223
Troubleshooting	225
Default Settings	227
List of World Time Cities	232
Optional Accessories	233
Main Specifications	234
Warranty Policy	239
Index	244

In this manual, the method for operating the four-way controller is shown in illustrations, such as in the one below.

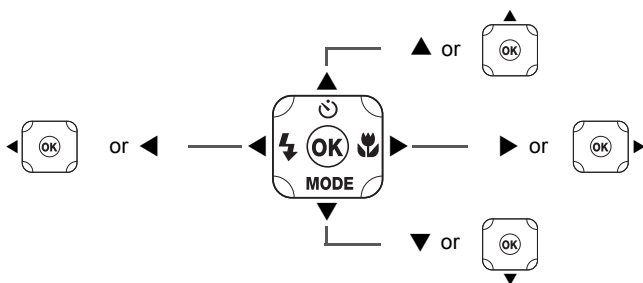

The meanings of the symbols used in this Operating Manual are explained below.

	Indicates the reference page number for an explanation of the related operation.
	Indicates information that is useful to know.
	Indicates precautions to be taken when operating the camera.
Mode	This is the mode for taking still pictures and movies. In this manual, “Still Picture Capture Mode” refers to only the mode for taking still pictures.
Mode	This is the mode for viewing still pictures and playing back movies and sound files.

Composition of the Operating Manual

This Operating Manual contains the following chapters.

1 Getting Started

This chapter explains what you need to do after purchasing the camera before you start taking pictures. Be sure to read it and follow the instructions.

2 Common Operations

This chapter explains common operations such as the functions of the buttons and how to use the menus. For more details, refer to the respective chapters below.

3 Taking Pictures

This chapter explains the various ways of capturing images and how to set the relevant functions.

4 Playing Back and Deleting Images

This chapter explains how to view still pictures and movies on the camera or on a TV and how to delete images, sound files, and movies from the camera.

5 Editing and Printing

This chapter explains the various ways of printing still pictures and how to edit images with the camera.

6 Recording and Playing Back Sound

This chapter explains how to record sound files or add sound (a voice memo) to an image and how to play back sound files.

7 Settings

This chapter explains how to set camera-related functions.

8 Connecting to a Computer

This chapter explains how to connect the camera to a computer, and includes installation instructions and a general overview of the provided software.

9 Appendix

This chapter deals with troubleshooting and lists the optional accessories.

1

2

3

4

5

6

7

8

9

Camera Features

In addition to basic picture-taking, this camera has a variety of shooting modes to suit different situations. This section describes how to make the most of the key features of your camera. For details on how to operate the camera, look at the table of contents or in the index for specific functions.

Suitable for Outdoor Activities

This camera is both waterproof and dustproof and has a tough body. You need not worry about sprays of water while fishing or unexpected rain or dust while trekking.



Functions that expand photo opportunities to the sea, the hills, and the rivers

- Waterproof at a depth of 12 meters (39.4 ft.)
- Take pictures underwater for up to two hours.
- Covers can be locked*1
- Shockproof performance*2
- Water repellent coating on the lens cover glass.

*1 This camera has locks for the battery/card and terminal covers. The battery compartment and the card and terminal compartment are not waterproof or dustproof. Lock the covers properly before approaching anyplace that is wet or dirty.

*2 The camera satisfies the PENTAX drop test (1.5 m height onto a 5 cm thick plywood surface) complying with MIL-Standard 810F Method 516.5-Shock testing.

- Waterproof performance is not guaranteed if the camera is exposed to impact such as being dropped or hit.
- The camera is not guaranteed to be free of trouble or damages under every condition.

- For taking enlarged pictures of very close objects such as the veins of leaves or specimens of tiny insects in Digital Microscope mode (p.77).
- For creating an image like an ink rubbing using the Ink Rubbing Filter (p.148).

Easy-to-Navigate Capture and Playback Functions!

The user-friendly design of the camera enables easy operation with only a few buttons. Simply by choosing the appropriate icon, you can select the shooting mode (p.67) and choose the optimal settings for the situation, or the playback mode (p.128) and enjoy the various playback and editing functions. A guide on the display lets you check the functions available in each mode and how to use them.

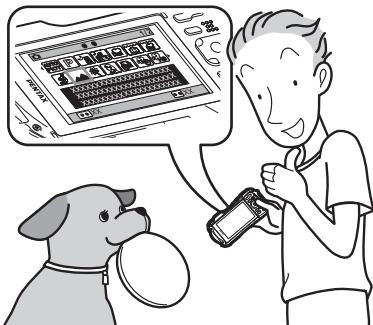

- A shooting mode guide is displayed in the Capture Mode Palette and a playback mode guide in the Playback Mode Palette (p.65, p.126).
- Use Green Mode to take pictures easily using standard settings (p.73).

Perfect for Portrait Shots!

This camera comes with a "Face Detection" function that spots the faces in your shot and automatically adjusts the focus and exposure for the faces. It can detect up to 32 people per shot (*1), so it will help you take perfect group shots too. It automatically releases the shutter when people are smiling, and if anyone blinks, it tells you that. It also tells you where faces are detected on the screen (*2), so you can take the shot again until it is perfect. It also has a feature that lets you enlarge each person's face in sequence during playback so you can quickly check their facial expressions.

*1 Up to 31 face detection frames are displayed on the monitor.

*2 The camera can tell the position of up to 3 detected faces.

- **Face Detection function (p.69).**
- **Close-ups of people's faces for easy checking during playback (p.133).**
- **Self-portrait Assist function tells you the face position on the screen (p.72).**

Advanced Movie Recording Functions!

This camera includes Movie SR to reduce camera shake during movie recording (p.116). It also supports 1920 x 1080 Full HDTV so you can view your recordings as stunning wide-screen movies.

- **Use the camera to shoot fun-filled movies of your children or pets as a visual diary of their development (p.113).**

A Multitude of Functions inside the Camera for Enjoying Images Without a Computer!

This camera has a variety of functions to let you enjoy playing back and editing images without having to connect the camera to your computer and transfer the images first. The camera is all you need to take and edit still pictures and movies (p.143).

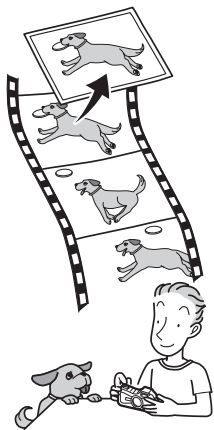

- **Resize (p.143), Cropping (p.144) and Red-eye Compensation (p.152) can be used, while the image is displayed in playback mode.**
- **You can divide a movie in two or select a frame from a movie to save it as a still picture (p.160).**

Checking the Contents of the Package

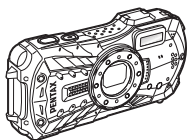

Camera
Optio WG-2 GPS/
Optio WG-2

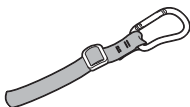

Carabiner strap
O-ST124 (WG-2 GPS) (*)
O-ST125 (WG-2) (*)

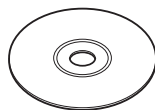

Software (CD-ROM)
S-SW125

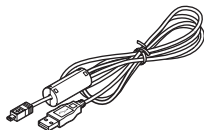

USB cable
I-USB7 (*)



AC plug cord (*)



Rechargeable lithium-ion
battery D-LI92 (*)

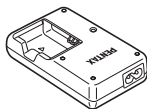

Battery charger
D-BC92 (*)



Macro stand
O-MS1

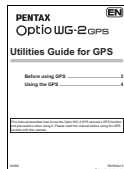

Utilities Guide for GPS
(Optio WG-2 GPS only)

Operating Manual
(this manual)
Quick Guide

Items marked with an asterisk (*) are also available as optional accessories. The battery charger and AC plug cord are only sold as a set (battery charger kit K-BC92).

For other optional accessories, refer to "Optional Accessories" (p.233).

Names of Parts

Front

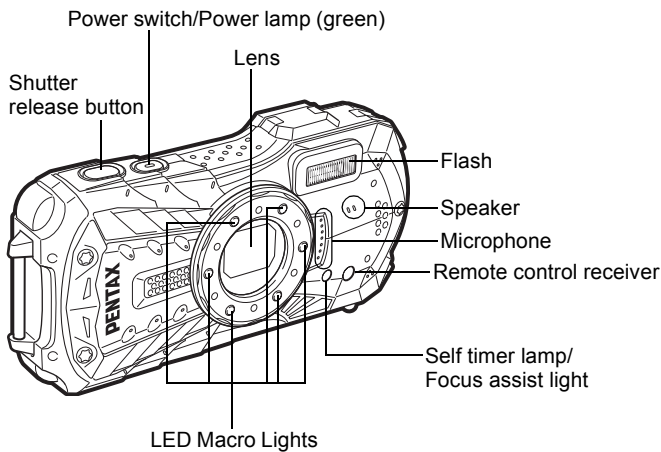

Back

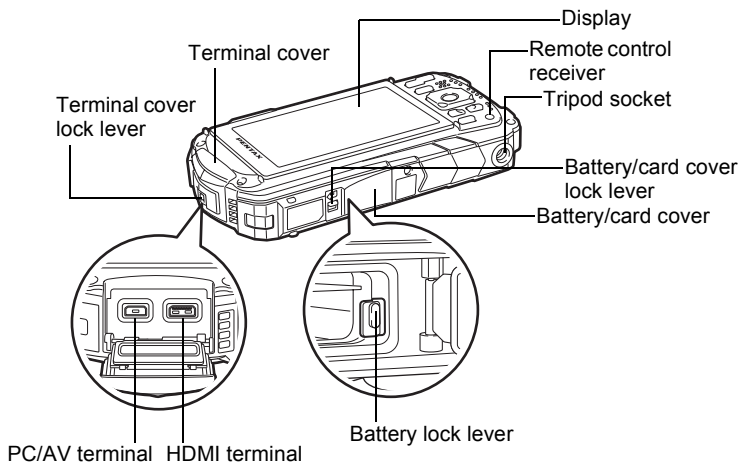

Names of Operating Parts

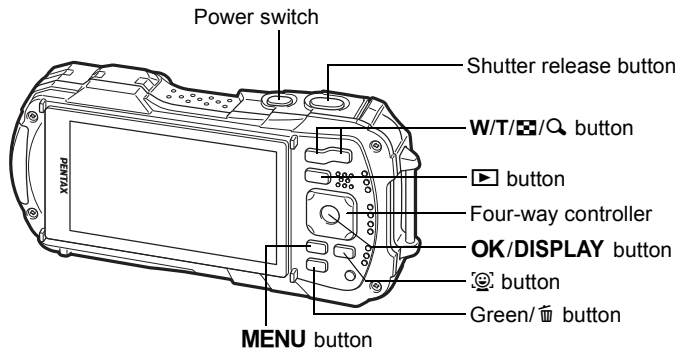

Refer to "Understanding the Button Functions" (p.48 - 51) for an explanation of the function of each button.

Macro stand

Attaching the supplied macro stand (O-MS1) reduces camera shake during shooting in Digital Microscope mode (p.77). Insert two clips above and below the LED Macro Lights part. When attaching and detaching the macro stand, do not hold the clip part.

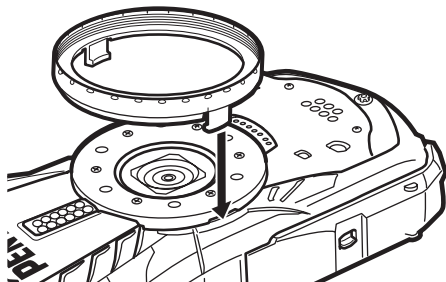

* When using the macro stand, the camera may not be able to focus if the objects have uneven surfaces.

Monitor Indications

Display in Mode

The display changes in the following sequence each time you press the **OK/ DISPLAY** button: “Normal Display”, “Histogram + Info”, “No Info”, “LCD Off”.



- All the camera buttons function as normal even when the LCD is off. Press the shutter release button to take pictures as normal.
- The display cannot be changed in some shooting modes.

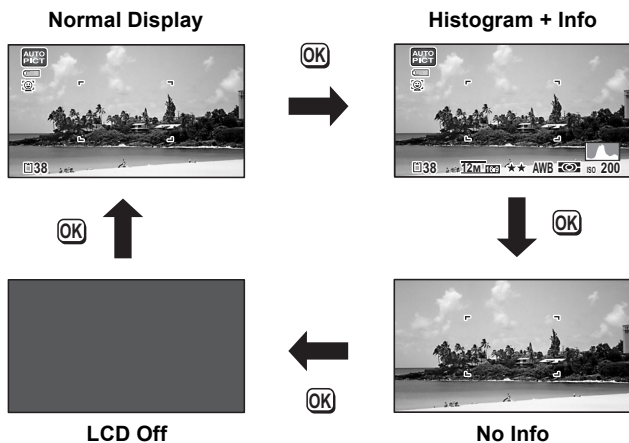



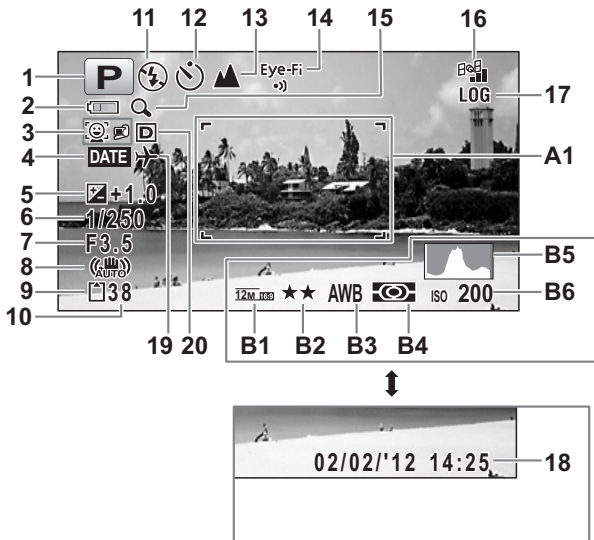

Normal Display in Still Picture Capture Mode

1 to 21 and A1 appear when “Normal Display” is selected. B1 to B6 appear at the position of 18 when “Histogram + Info” is selected. Only A1 appears when “No Info” is selected.



- | | |
|--|--|
| 1 Shooting mode (p.65) | 16 GPS data
(Optio WG-2 GPS only) |
| 2 Battery level indicator (p.36) | 17 GPS log icon
(Optio WG-2 GPS only) |
| 3 Face Detection icon (p.70) | 18 Date and time (p.46) |
| 4 Date Imprint setting (p.109) | 19 World Time setting (p.180) |
| 5 EV Compensation (p.101) | 20 D-Range Setting (p.102) |
| 6 Shutter speed | A1 Focus frame (p.60) |
| 7 Aperture | B1 Recorded pixels (p.96) |
| 8 Pixel Track SR icon (p.103) | B2 Quality Level (p.97) |
| 9 Memory status (p.41) | B3 White Balance (p.98) |
| 10 Remaining image storage capacity | B4 AE Metering (p.99) |
| 11 Flash mode (p.90) | B5 Histogram (p.31) |
| 12 Drive mode (p.81 - p.84) | B6 Sensitivity (p.100) |
| 13 Focus mode (p.91) | |
| 14 Eye-Fi communication status (p.189) | |
| 15 Digital zoom/Intelligent Zoom icon (p.63) | |

- * 6 and 7 are only displayed when the shutter release button is pressed half-way.
- * For 13, when the focus mode is set to **AF** and the Auto Macro function is activated,  appears on the display (p.91).
- * 14 changes depending on [Eye-Fi] setting in [ Setting] menu.
- * 16 changes depending on [GPS] setting in [ Setting] menu.
No icon is displayed on the screen when [GPS On/Off] is set to [Off].
- * 17 appears when recording the GPS log.
- * 18 disappears two seconds after the camera is turned on.
- * 20 changes depending on [D-Range Setting] setting in the [ Rec. Mode] menu.
No icon is displayed on the screen when [Highlight Correction] and [Shadow Correction] are both set to (Off).
- * When the shooting mode is  (Auto Picture) and if you press the shutter release button halfway, the automatically selected shooting mode appears in A1 even when “No Info” is selected.
- * When there is an area on the screen that is overexposed it appears white, the indicated area blinks red as a warning. Similarly, when there is an area that is underexposed it appears black, the indicated area blinks yellow as a warning.
- * Some indications may not appear depending on the shooting mode.

Display in Mode

The display shows the shooting information of the image in playback mode. The display changes in the following sequence each time you press the **OK/ DISPLAY** button:



- The display cannot be changed by pressing the **OK/DISPLAY** button while playing back a voice memo/movie or pausing playback.
- Only the Optio WG-2 GPS can display GPS information. If you are using the Optio WG-2, the display changes to the normal display by pressing the **OK** button at no info display.

Normal Display



Histogram + Info



GPS information display



No Info



Histogram + Info Display in Playback Mode

(All of the display items are displayed here for explanatory purposes.)

The display shows information such as the shooting conditions. A1 to A11 also appear when "Normal Display" is selected. B1 to B8 appear only when "Histogram + Info" is selected.



- | | |
|--|--|
| A1 Face Detection icon (p.69) | A10 Eye-Fi communication status (p.189) |
| A2 Playback mode
▶ : Still Picture (p.122)
▶ : Movie (p.123)
▶ : Sound (p.170) | A11 Volume icon |
| A3 Battery level indicator (p.36) | B1 Shutter speed |
| A4 Protect icon (p.138) | B2 Aperture |
| A5 Voice memo icon (p.172) | B3 Histogram (p.31) |
| A6 Four-way controller guide | B4 Sensitivity (p.100) |
| A7 File number | B5 Recorded pixels (p.96) |
| A8 Folder number (p.183) | B6 Quality Level (p.97) |
| A9 Memory status (p.41) | B7 White Balance (p.98) |
| | B8 AE Metering (p.99) |

- * A1 appears only if the Face Detection function worked when the image was shot.
- * In "Normal Display", A3 disappears if no operation is performed for two seconds.
- * A6 appears even when "No Info" is selected, but disappears if no operation is performed for two seconds. When no operation is performed for two seconds in "Normal Display" or "Histogram + Info", only "Edit" disappears.
- * A11 appears only when the volume is being adjusted during playback of movies, sounds, or voice memos (p.123, p.170, p.172).
- * When "Normal Display" is selected, the current date and time appears for two seconds in the B4 to B8 positions.

- * When there is an area on the screen that is overexposed it appears white, the indicated area blinks red. Similarly, when there is an area that is underexposed it appears black, the indicated area blinks yellow.

GPS Information Display in Playback Mode (displayed only on the Optio WG-2 GPS)

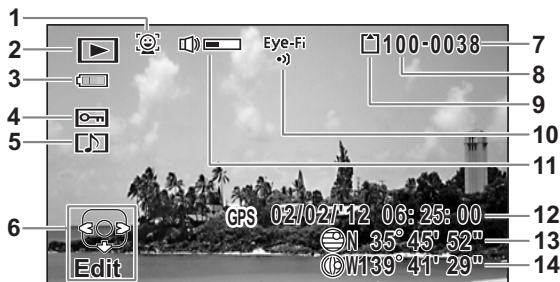

- | | | | |
|---|---------------------------|----|-----------------------------|
| 1 | Face Detection icon | 8 | Folder number |
| 2 | Playback mode | 9 | Memory status |
| 3 | Battery level indicator | 10 | Eye-Fi communication status |
| 4 | Protect icon | 11 | Volume icon |
| 5 | Voice memo icon | 12 | Positioning time |
| 6 | Four-way controller guide | 13 | Positioning latitude |
| 7 | File number | 14 | Positioning longitude |

- * 12 is displayed in GPS time (time data received from GPS satellites). This may be different from the time you have set on the camera.

Guide Display

A guide for each available button operation appears as follows on the display during operation.

▲	Four-way controller (▲)
▼	Four-way controller (▼)
◀	Four-way controller (◀)
▶	Four-way controller (▶)
MENU	MENU button

	Zoom button
OK	OK/DISPLAY button
SHUTTER	Shutter release button
	Green/ button
	button

Histogram

A histogram shows the brightness distribution of an image. The horizontal axis represents brightness (dark at the left and bright at the right) and the vertical axis represents the number of pixels.

The shape of the histogram before and after shooting tells you whether the brightness and contrast are correct or not, and

lets you decide if you need to use EV compensation and take the picture again.

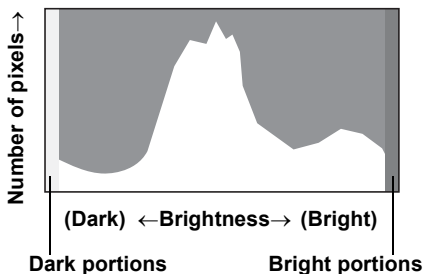

Setting the Exposure (EV Compensation) p.101

Understanding Brightness

If the brightness is correct, the graph peaks in the middle. If the image is underexposed, the peak is on the left side, and if it is overexposed, the peak is on the right side.

Dark image

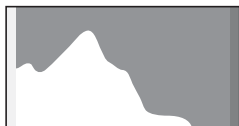

Correct image

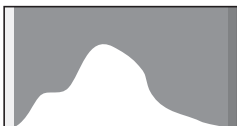

Bright image

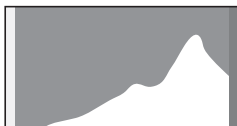

When the image is underexposed, the part to the left is cut off (dark portions) and when the image is overexposed, the part to the right is cut off (bright portions). This camera has a function where overexposed areas are indicated as blinking red and underexposed areas as blinking yellow.

Understanding Contrast

The graph peaks gradually for images in which contrast is balanced. The graph peaks on both sides but sinks in the middle for images with a large difference in contrast and low amounts of mid-level brightness.

Attaching the Carabiner Strap

Attach the carabiner strap supplied with the camera.

1 Getting Started

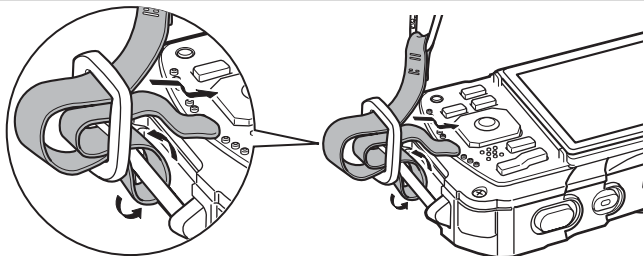

- 1** Pass the end of the strap through the strap lug on the camera.
- 2** Fix the end of the strap to the stopper.

Protective rubber ring

The carabiner has rubber rings to prevent damage to the display. These rubber rings cushion the impact when the carabiner hits the display.

Be sure to adjust the position of the rubber rings as shown in the figure below for the best results before using the carabiner strap.

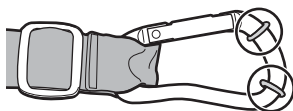

Powering the Camera

Charging the Battery

Use the supplied battery charger (D-BC92) to charge the supplied rechargeable lithium-ion battery (D-LI92) before using it in the camera for the first time or after a long period of non-use, or when the [Battery depleted] message appears.

Note: AC plug cord "Listed, Type SPT-2 or NISPT-2, 18/2 flexible cord, rated 125 V, 7A, minimum 6 ft (1.8 m)"

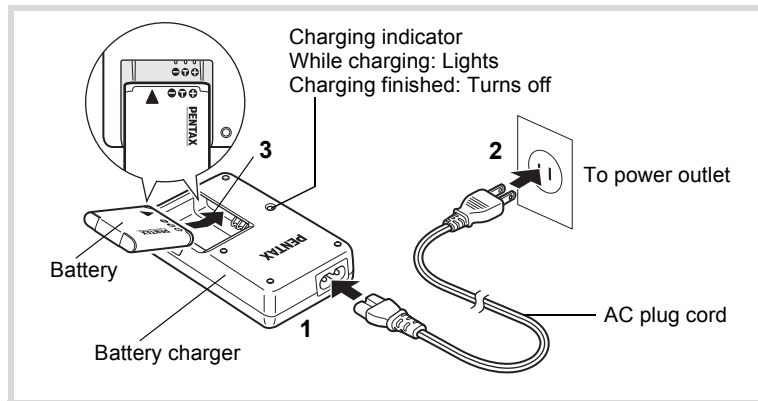

- 1** Connect the AC plug cord to the battery charger.
- 2** Plug the AC plug cord into the power outlet.
- 3** Place the battery in the battery charger so that the **PENTAX** logo is facing up.
The charging indicator turns on while charging.
When charging is finished, the charging indicator turns off.
- 4** Remove the battery from the battery charger when charging is finished.



- Do not charge batteries other than the rechargeable lithium ion D-LI92 battery using the supplied D-BC92 battery charger. Doing otherwise may cause damage or overheating.
- The battery has reached the end of its service life when it starts to run down soon after being charged. Replace it with a new battery.
- If the battery is inserted correctly but the charging indicator fails to light, the battery may be faulty. Replace it with a new battery.



The time required to fully charge the battery is about 120 minutes (max.). (The charging time may vary depending on the ambient temperature and charging conditions.) The appropriate ambient temperature for charging the battery is 0°C to 40°C (32°F to 104°F).

1

Installing the Battery

Use the rechargeable lithium-ion battery D-LI92 that is provided with the camera. Charge the battery before using it in the camera for the first time.

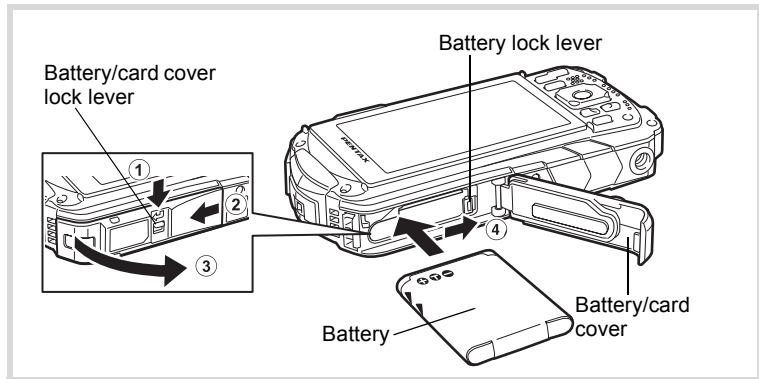

1 Open the battery/card cover.

Press the battery/card cover lock lever in the direction shown ①, slide the cover towards ② and open it towards ③.

2 Using the side of the battery to press the battery lock lever in the direction of ④, insert the battery with the PENTAX logo pointing toward the lens.

Push the battery in until it is locked in place.



If the battery is incorrectly oriented, malfunction may result.

3 Close the battery/card cover.

Push down and slide the battery/card cover with steady but gentle force in the opposite direction indicated by ②.

Removing the Battery

1 Open the battery/card cover.

2 Press the battery lock lever towards ④.

The battery will be ejected. Take care not to drop the battery when removing it.



- Do not use excessive force when sliding the battery/card cover open and closed because the waterproof packing may peel off. If the packing is not in the correct position, the camera will not be waterproof.
- If the battery/card cover is not locked securely when you close it, water, sand, or dirt may get into the camera.
- This camera uses a rechargeable lithium-ion battery D-LI92. Use of any other type of battery may damage the camera and cause malfunction.
- Insert the battery correctly. If the battery is incorrectly oriented, malfunction may result.
- Do not remove the battery while the camera is turned on.
- When storing the battery for more than 6 months, charge the battery for 30 minutes using the battery charger and store the battery separately. Be sure to recharge the battery every 6 to 12 months. Storing the battery below room temperature is ideal. Avoid storing it in high temperatures.
- The date and time may be returned to the default setting if the camera is left without the battery for a long time.
- Be careful as the camera or the battery may become hot when the camera is used continuously for a long period of time.
- Allow the camera to dry completely before changing the battery. Avoid changing the battery where the camera is likely to get wet or dirty, and make sure that your hands are dry.

- **Image Storage Capacity, Movie Recording Time, Sound Recording Time, and Playback Time**
(at 23°C or 73.4°F with the display on and the battery fully charged)

Image Storage Capacity ^{*1} (flash used for 50% of shots)	Movie Recording Time ^{*2}	Sound Recording Time ^{*2}	Playback Time ^{*2}
Approx. 260 pictures	Approx. 70 min.	Approx. 270 min.	Approx. 240 min.

*1 Recording capacity shows approximate number of shots recorded during CIPA-compliant testing (with display on, flash used for 50% of the shots, and 23°C or 73.4°F). Actual performance may vary according to operating conditions.

*2 According to the results of in-house testing.



- Battery performance may deteriorate as temperature decreases. When using the camera in cold regions, we recommend carrying a spare battery in your pocket to keep it warm. Battery performance will return to normal in normal temperatures.
- If [GPS On/Off] on the [GPS] setting is set to [On], the camera performs positioning regularly even if it is turned off, which reduces the battery life.
- Be sure to take a spare battery with you when traveling abroad or to a cold region, or if you intend to take a lot of pictures.

• Battery Level Indicator

You can check the battery level by the indicator on the display.

Screen Display	Battery Status
(green)	Adequate power remains.
(green)	Battery is running low.
(yellow)	Battery is running very low.
(red)	Battery is exhausted.
[Battery depleted]	The camera will turn off after this message appears.

Using the AC Adapter

Use of the optional AC adapter kit (K-AC117) is recommended if you intend to use the camera for a long time or connect it to a computer.

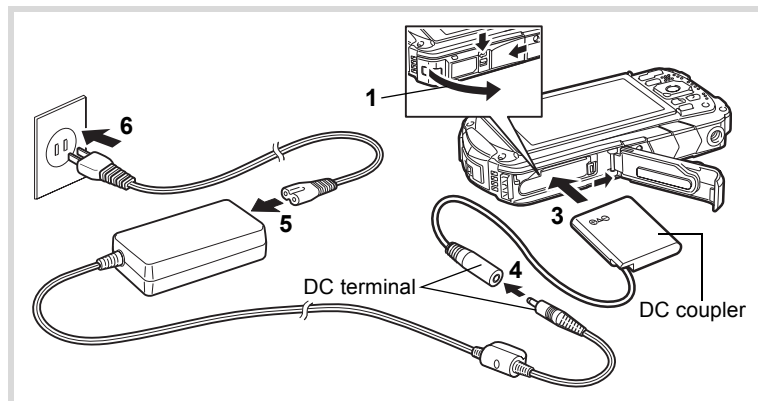

- 1 Make sure that the camera is turned off and open the battery/card cover.**
- 2 Remove the Battery.**
Refer to p.34 - p.35 on how to open the battery/card cover and remove the battery.
- 3 Insert the DC coupler.**
Using the side of the DC coupler to press the battery lock lever, insert the DC coupler. Confirm that the DC coupler is locked in place.
The battery/card cover will not close while the DC coupler is inserted. Leave the cover open when using the AC adapter and do not attempt to close it.
- 4 Connect the DC terminal of the AC adapter to the DC terminal of the DC coupler.**
- 5 Connect the AC plug cord to the AC adapter.**
- 6 Plug the AC plug cord into the power outlet.**

- Make sure that the camera is turned off before connecting or disconnecting the AC adapter.
- Make sure that the AC plug cord and the DC terminal connecting the AC adapter to the camera are inserted securely. Data may be lost if either becomes disconnected while data is being recorded on the SD Memory Card or the built-in memory.
- Use the AC adapter with due care to avoid fire or electric shock. Be sure to read “About the Battery Charger and the AC Adapter” (p.3) before using the AC adapter.
- Be sure to read the operation manual accompanying the AC adapter kit K-AC117 before using the adapter.
- When connecting the AC adapter, you cannot set the camera upright on the table because the cord from the DC coupler comes out of the bottom of the camera.
- Do not use excessive force when sliding the battery/card cover open and closed because the waterproof packing may peel off. If the packing is not in the correct position, the camera will not be waterproof.

Installing the SD Memory Card

This camera uses SD Memory Cards, SDHC Memory Cards or SDXC Memory Cards. (These cards are referred to as SD Memory Cards hereafter.) Captured images and sound files are saved on the SD Memory Card if a card is inserted in the camera. They are saved in the built-in memory if a card is not inserted (p.41).



- **Be sure to use this camera to format (initialize) an SD Memory Card that is unused or has been used on other cameras or digital devices. Refer to “Formatting the Memory” (p.174) for instructions on formatting.**
- Make sure that the camera is turned off before inserting or removing the SD Memory Card.
- Allow the camera to dry completely before changing the SD Memory Card. Avoid changing the card where the camera is likely to get wet or dirty, and make sure that your hands are dry.
- Do not use excessive force when sliding the battery/card cover open and closed because the waterproof packing may peel off. If the packing is not in the correct position, the camera will not be waterproof.



- The number of still pictures that can be stored varies depending on the capacity of the SD Memory Card and the selected number of recorded pixels and quality level (p.235).
- The power lamp blinks while the SD Memory Card is being accessed (data is being recorded or read).

Backing Up Data

The camera may not be able to access data in the built-in memory in the case of a malfunction. Use a computer or other device to back up important data in another location.

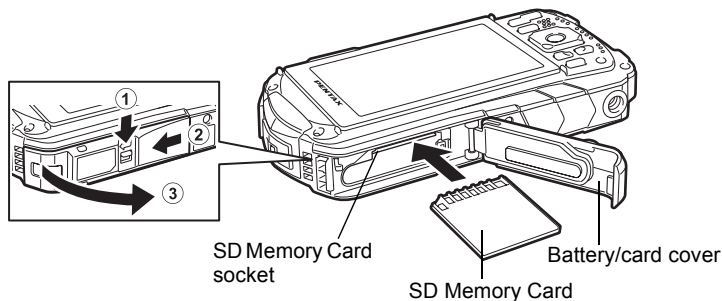

1 Open the battery/card cover.

Press the battery/card cover lock lever in the direction shown ①, slide the cover towards ② and open it towards ③.

2 Insert the SD Memory Card into the SD Memory Card socket so that the label is facing toward the front of the camera (the side with the lens).

Push the card in all the way. Images and sound may not be recorded correctly if the card is not inserted all the way.

To remove the SD Memory Card, push it in once and then pull it out.

3 Close the battery/card cover.

Push down and slide the battery/card cover with steady but gentle force in the opposite direction indicated by ②.



If the battery/card cover is not locked securely when you close it, water, sand, or dirt may get into the camera.



- The file size differs depending on the number of recorded pixels of the images and the number of the recordable images to the SD Memory Card also differs.
- Set the number of recorded pixels for still pictures from [📷 Rec. Mode] menu and for movies from [🎬 Movie] menu.
- For an approximate number of recordable images or time that can be saved on an SD Memory Card, see "Main Specifications" (p.234).

Turning the Camera On and Off

1

Getting Started

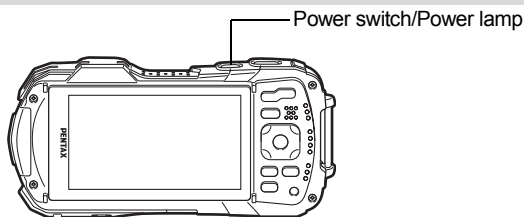

1 Press the power switch.

The camera turns on and both the power lamp and display turn on. If the [Language/言語] screen or [Date Adjustment] screen appears when you turn the camera on, follow the procedure on p.43 to set the display language and/or current date and time.

2 Press the power switch again.

The camera turns off and both the power lamp and display turn off.

Taking Still Pictures p.60

Checking the SD Memory Card

The SD Memory Card is checked when the camera turns on and the memory status is displayed.

	The SD Memory Card is inserted. Images and sound files will be saved on the SD Memory Card.
	The SD Memory Card is not inserted. Images and sound files will be saved in the built-in memory.
	The write-protect switch on the SD Memory Card is in the LOCK position (p.7). Images and sounds cannot be recorded.



Memory status

Starting-up in Playback Mode

Use this function when you want to play back images or sound files straightaway without taking any pictures.

1

Getting Started

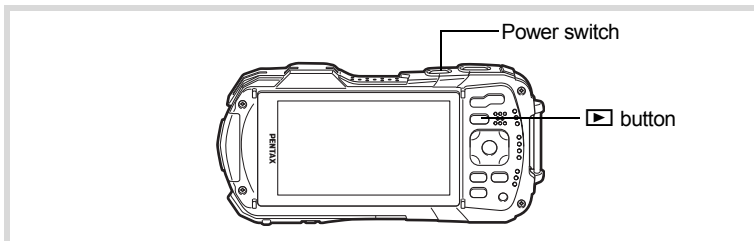



1

Press and hold down the button.

The display turns on and the camera starts up in playback mode.



- To switch from playback mode to  mode, press the  button or press the shutter release button halfway.
- In order to set the start up in playback mode to off, set [Playback Mode] to (Off) from [Startup Shortcut] in the [ Setting] menu. (p.194)

Playing Back Still Pictures  p.122

Initial Settings

The [Language/言語] screen appears when the camera is turned on for the first time. Perform the operations in “Setting the Display Language” below to set the language, and in “Setting the Date and Time” (p.46) to set the current date and time.

The language, date, and time can be changed later. Refer to the pages below for instructions.

- To change the language, follow the steps in “Changing the Display Language” (p.182).
- To change the date and time, follow the steps in “Changing the Date and Time” (p.176).

Setting the Display Language

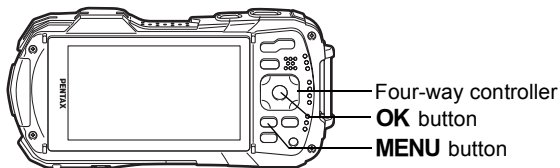

1 Use the four-way controller (▲▼◀▶) to choose the display language.

2 Press the OK button.

The [Initial Setting] screen appears in the selected language. If the desired settings for [Hometown] and [DST] (Daylight Saving Time) appear, proceed to Step 9.

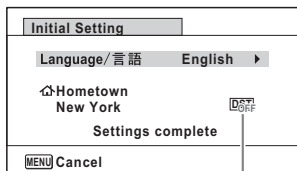

Daylight saving time

3 Press the four-way controller (▼).

The frame moves to [↗ Hometown].

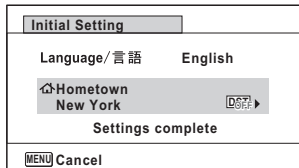
**4 Press the four-way controller (▶).**

The [↗ Hometown] screen appears.

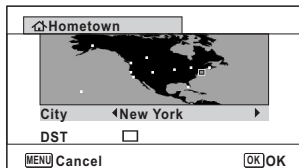
5 Use the four-way controller (◀▶) to choose a city.**6 Press the four-way controller (▼).**

The frame moves to [DST] (Daylight Saving Time).

7 Use the four-way controller (◀▶) to select or .**8 Press the OK button.**

The [Initial Setting] screen reappears.

9 Press the four-way controller (▼) to select [Settings complete].**10 Press the OK button.**

The [Date Adjustment] screen appears. Next, set the date and time.

If you accidentally select the wrong language and go to the next procedure, perform the following operation to set the language back.

● **When the Wrong Language Has Been Inadvertently Selected**

- 1 Press the four-way controller (▶).**
- 2 Use the four-way controller (▲ ▼ ◀ ▶) to select the language and press the OK button.**
The [Initial Setting] screen appears in the selected language.

● **When the Screen After Step 2 Appears in the Wrong Language**

- 1 Press the MENU button.**
This exits the settings screen and returns the camera to capture mode.
- 2 Press the MENU button.**
The [📷 Rec. Mode] menu appears.
- 3 Press the four-way controller (▶) twice.**
- 4 Use the four-way controller (▼ ▲) to select [Language/言語].**
- 5 Press the four-way controller (▶).**
The [Language/言語] screen appears.
- 6 Use the four-way controller (▲ ▼ ◀ ▶) to select the language.**
- 7 Press the OK button.**
The [🔍 Setting] menu appears in the selected language.

The language is now switched to your desired language. To reset [Hometown], [Date] and [Time], refer to the pages below for instructions.

- To change [Hometown], follow the steps in “Setting the World Time” (☞p.180).
- To change the date and time, follow the steps in “Changing the Date and Time” (☞p.176).

The video output format (NTSC/PAL) is set to the format of the city selected in [Hometown] on the [Initial Setting] screen. See the following pages for information on the available video output formats and how to change the initial settings.

- Video output formats available initially: “List of World Time Cities” (☞p.232)
- To change the video output format: “Changing the Video Output Format” (☞p.187).

Setting the Date and Time

Set the current date and time and the display format.

1

Getting Started

1 Press the four-way controller (▶).

The frame moves to [mm/dd/yy].

2 Use the four-way controller (▲▼) to choose the date and time display format.

Choose from [mm/dd/yy], [dd/mm/yy] or [yy/mm/dd].

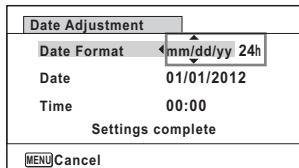

3 Press the four-way controller (▶).

The frame moves to [24h].

4 Use the four-way controller (▲▼) to select [24h] (24-hour display) or [12h] (12-hour display).

5 Press the four-way controller (▶).

The frame returns to [Date Format].

6 Press the four-way controller (▼).

The frame moves to [Date].

7 Press the four-way controller (▶).

The frame moves to the month.

8 Use the four-way controller (▲▼) to change the month.

Change the day and year in the same manner.

Next, change the time.

If you selected [12h] in step 4, the setting switches between am and pm corresponding to the time.

9 Press the four-way controller (▼) to select [Settings complete].

10 Press the OK button.

This confirms the date and time.



If you press the **OK** button in step 10, the camera clock is reset to 00 seconds. To set the exact time, press the **OK** button when the time signal (on the TV, radio, etc.) reaches 00 seconds.



When the [Initial Setting] or [Date Adjustment] screen is displayed, you can cancel the setting operation and switch to the capture mode by pressing the **MENU** button. In this case, the [Initial Setting] screen will appear next time you turn the camera on.





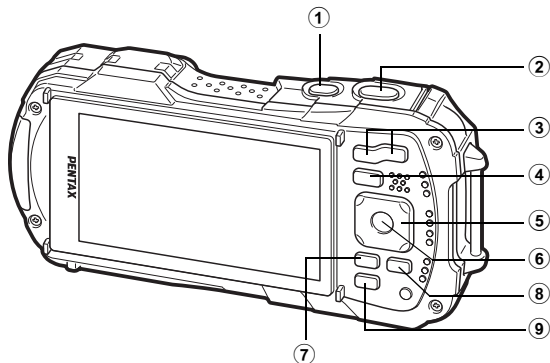

[Language/言語], [Date], [Time], [Hometown] and [DST] can be changed. Refer to the pages below for instructions.

- To change the language, follow the steps in “Changing the Display Language” (☞p.182).
- To change the date and time, follow the steps in “Changing the Date and Time” (☞p.176).
- To change the city or turn DST on and off, follow the steps in “Setting the World Time” (☞p.180).

Understanding the Button Functions

Mode



- ① **Power switch**
Turns the camera on and off (p.41).
- ② **Shutter release button**
Focuses the camera on the subject when pressed halfway in Still Picture Capture Mode (except when the focus mode is set to **PF**, **▲**, and **MF**) (p.61). Takes a still picture when pressed down fully (p.61). Pressing down fully starts and stops movie recording in  (Movie),  (Underwater Movie), and  (High Speed Movie) modes (p.111, p.113). Pressing down fully starts and stops sound file recording in  (Voice Recording) mode (p.169).
- ③ **W/T button**
Changes the captured area (p.63).
- ④ ** button**
Switches to the  mode (p.52).
- ⑤ **Four-way controller**
(**▲**) : Changes the drive mode (p.81 - p.84).
(**▼**) : Displays the Capture Mode Palette (p.67).
(**◀**) : Changes the flash mode (p.90).
(**▶**) : Changes the focus mode (p.91).
(**▲▼**) : Adjusts the focus when the focus mode is set to **MF** (p.92).

⑥ OK/DISPLAY button

Changes the information on the display (p.25).

⑦ MENU button

Displays the [📷 Rec. Mode] menu (p.53).

⑧ 😊 button

Switches the Face Detection function (p.69). The Face Detection function is switched as follows each time the 😊 button is pressed:

Smile Capture → Self-portrait Assist → Self-portrait Assist + Smile Capture → Face Detection Off → Face Detection On

Selects or registers a pet in 🐾 (Pet) mode.

⑨ Green button

Switches to 🟢 (Green) mode (p.73).

Calls up the assigned function (p.105).

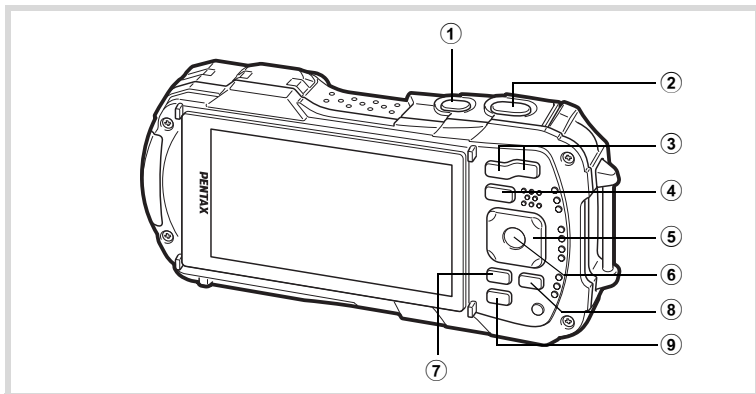

① **Power switch**

Turns the camera on and off (p.41).

② **Shutter release button**

Switches to mode (p.52).

③ **/ button**

In single-image display, pressing switches to 6-image display. Pressing again switches to 12-image display (p.124). Press to return to the previous display.

In single-image display, pressing enlarges the image. Press to return to the previous display (p.132).

In 12-image display press to change to folder or calendar display (p.125).

In folder/calendar display, press to change to 12-image display (p.125).

Adjusts the volume during playback of movies, sound files or voice memo (p.123, p.170, p.172).

④ **button**

Switches to mode (p.52).

- ⑤ **Four-way controller**
- (▲) : Plays back and pauses a movie or sound file (p.123, p.170, p.172).
 - (▼) : Displays the Playback Mode Palette (p.128).
Stops a movie or sound file during playback (p.123, p.170, p.172).
 - (◀▶) : Displays the previous or next image and sound file during single-image display (p.122).
Fast-forwards, fast-reverses, frame forwards, frame reverses, reverses a movie and makes a movie play forwards during playback (p.123).
Fast forwards, reverses, and moves to the next index in sound file playback (p.170).
 - (▲▼◀▶) : Moves the display area during zoom display (p.132).
Selects an image in 6- or 12-image display, a folder in folder display, and a date in calendar display (p.124, p.125).
Moves the image when using the Frame Composite function (p.154).
Adjusts the position of a frame or an image when you are using the Original Frame function (p.158).

⑥ **OK/DISPLAY button**

- Changes the information on the display (p.28).
- Returns zoom, 6- or 12-image display to single-image display (p.125, p.132).
- Changes to 12-image display of the selected folder during folder display (p.125).
- Changes to single-image display of the selected date during calendar display (p.126).

⑦ **MENU button**

- Displays the [ Setting] menu during single-image display (p.53).
- Returns to single-image display during Playback Mode Palette display (p.127).
- Returns zoom, 6- or 12-image display to single-image display.
- Changes to 12-image display of the selected folder during folder display (p.126).
- Changes to 12-image display of the selected date during calendar display (p.126).





⑧ ** button**

- Zooms up on the subjects' faces in the order in which they were recognized during shooting (Face close-up playback) (p.133).



⑨ **Green/ button**

- Switches from single-image display to the Delete screen (p.135).
- Switches from 6- or 12-image display to the Select & Delete screen (p.136).
- Switches from folder display to the calendar display screen (p.125).
- Switches from calendar display to the folder display screen (p.125).



Switching Between Mode and Mode

In this manual, the capture mode, such as for taking still pictures, is referred to as “ mode” (capture mode). Playback mode, such as for displaying captured images on the monitor, is referred to as “ mode” (playback mode). In  mode, you can perform simple editing operations on the images that are played back. Follow the procedure below to switch between  mode and  mode.

To Switch from Mode to Mode

- 1 Press the  button.**
The camera switches to  mode.

To Switch from Mode to Mode

- 1 Press the  button or the shutter release button halfway.**
The camera switches to  mode.

Displaying data stored in the built-in memory

When an SD Memory Card is inserted in the camera, still pictures, movies, and sounds on the SD Memory Card are displayed. If you want to display still pictures, movies, and sounds stored in built-in memory, turn the camera off and remove the SD Memory Card.



Make sure that the camera is turned off before inserting or removing the SD Memory Card.

Setting the Camera Functions

To change the camera settings, press the **MENU** button to display the [📷 Rec. Mode] menu or [⚙️ Setting] menu. Functions for playing back and editing images and sound files are displayed from the Playback Mode Palette.



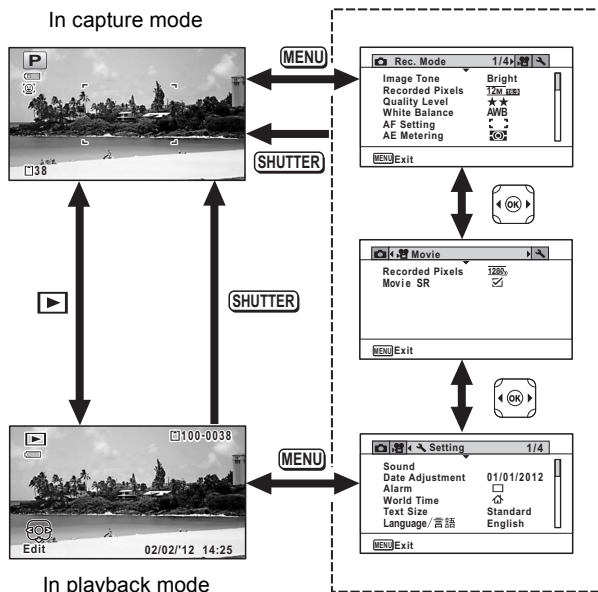

Operating the Menus

There are three types of menu: [📷 Rec. Mode], [🎬 Movie] and [⚙️ Setting]. Press the **MENU** button in 📷 mode to display the [📷 Rec. Mode] menu. Press the **MENU** button in 🎬 mode to display the [⚙️ Setting] menu. Use the four-way controller (◀▶) to move between menus.





- Available button and key operations appear on the display during menu operation.
- The **MENU** button function differs depending on the screen. Refer to the guide indications.



	Exit	Exits the menu and returns to the original screen.
		Returns to the previous screen with the current setting.
	Cancel	Cancels the current selection, exits the menu and returns to the previous screen.

Menu List

This displays the items that can be set with the menus and provides descriptions of each item. See the list of default settings in the Appendix “Default Settings” (p.227) to decide whether you want the settings saved when the camera is turned off and whether you want the settings returned to the defaults when the camera is reset.

Rec. Mode] Menu

This menu shows the functions related to taking still pictures and recording movies.

Item	Description	Page
Image Tone	For setting the tone of images	p.95
Recorded Pixels	For choosing the number of recorded pixels of still pictures	p.96
Quality Level	For setting the quality level of still pictures	p.97
White Balance	For adjusting the color balance according to the lighting conditions	p.98
AF Setting	Focusing Area When AF (Standard),  (Macro), or  (1cm Macro) is selected as the focus mode, you can change the autofocus area (Focusing Area)	p.93
	Auto Macro For choosing whether or not to use the auto macro function	p.94
	Focus Assist For setting whether or not to use the focus assist light	p.94
AE Metering	For choosing the area of the screen that is metered to determine the exposure	p.99
Sensitivity	For setting the sensitivity	p.100
AUTO ISO Range	For setting the adjustment range when sensitivity is set to AUTO	p.101
EV Compensation	For adjusting the overall brightness of the picture	p.101
D-Range Setting	Highlight Correction For setting whether to perform bright portion compensation	p.102
	Shadow Correction For setting whether to perform dark portion compensation	p.102
Pixel Track SR	For choosing whether to compensate for camera shake while taking still pictures	p.103
Blink Detection	For choosing whether to use the Blink Detection function with the Face Detection function	p.104
Digital Zoom	For choosing whether or not to use the digital zoom function	p.65
Instant Review	For choosing whether to display Instant Review	p.104
Memory	For choosing whether to save the set values of the shooting function or return to the defaults when the camera is turned off	p.120

Item	Description	Page
Green Button	For assigning a function to the Green button in  mode	p.105
Sharpness	For choosing sharp or soft outlines	p.108
Saturation (Tone Adjustment)	For setting the color saturation. When [Monochrome] is selected, the item changes to [Tone Adjustment]	p.108
Contrast	For setting the image contrast level	p.109
Date Imprint	For choosing whether to imprint the date and/or time when taking still pictures	p.109
IQ Enhancer*	For setting whether to perform the IQ enhancer.	p.110
Macro Light	For setting whether or not to turn on the LED Macro Lights for macro photography	p.110

*IQ Enhancer = Image Quality Enhancer

● [Rec. Mode] Menu 1

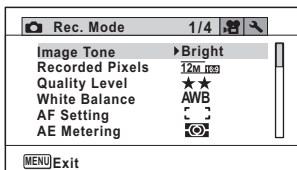

● [Rec. Mode] Menu 2

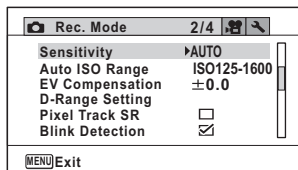

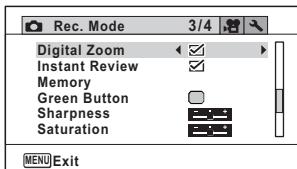

● [Rec. Mode] Menu 3

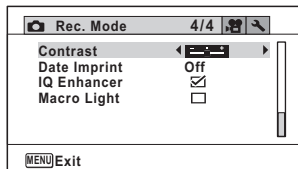

● [Rec. Mode] Menu 4



- Use  (Green) mode to enjoy easy picture-taking using standard settings, regardless of the settings in the [ Rec. Mode] menu (p.73).
- Assigning frequently used functions to the Green button enables you to go straight to the desired function (p.105).

[Movie] Menu

Item	Description	Page
Recorded Pixels	For choosing the number of recorded pixels and the frame rate for movies	p.115
Movie SR	For choosing whether or not to use the Movie Shake Reduction function	p.116

● [Movie] Menu

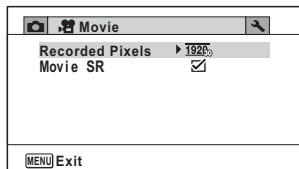

[Setting] Menu

Item	Description	Page
Sound	For adjusting the operation volume and playback volume, and setting the start-up sound, shutter sound, key operation sound, and self-timer sound	p.175
Date Adjustment	For adjusting the date and time	p.176
Alarm	For setting the alarm	p.178
World Time	For setting the hometown and destination	p.180
Text Size	For setting the text size of the menu	p.182
Language/言語	For setting the language in which menus and messages appear	p.182
Folder Name	For choosing how names are assigned to folders for storing images and sound files	p.183
File Name	For choosing how names are assigned to images and sound files	p.185
USB Connection	For setting the method for connecting to a PC (MSC or PTP)	p.202
Video Out	For setting the output format to the AV equipment	p.187
HDMI Out	For setting the HDMI output format when connecting to an AV device with an HDMI terminal	p.188
Eye-Fi	For setting whether or not to use Eye-Fi communication	p.189
Brightness Level	For changing the brightness of the display	p.189

Item		Description	Page
Power Saving		For setting the time until the camera enters power-saving mode	p.190
Auto Power Off		For setting the time until the camera turns off automatically	p.190
Quick Zoom		For choosing whether to use [Quick Zoom] (p.132) when playing back images	p.191
Guide Display		For setting whether to display explanations for selected items in Capture Mode Palette and Playback Mode Palette displays	p.191
Reset		For returning settings other than the date and time, language, world time and video out to their defaults	p.194
Delete All		For deleting all the images and sound files at once	p.137
Pixel Mapping		For correcting for defective pixels on the CCD sensor	p.192
Startup Shortcut	Playback Mode	For choosing whether to start-up the camera in playback mode.	p.194
	LED Lighting	For choosing whether to turn the LED Macro Lights on while the camera is turned off.	p.194
	Clock Display	For choosing whether to display the clock while the camera is turned off.	p.194
Format		For formatting the SD Memory Card/built-in memory	p.174
GPS (*)	GPS On/Off	For setting whether to record the GPS data on captured images	GPS Guide
	GPS Logging	For setting the interval and duration of logs. Saving and deleting of received logs can be selected also.	
	GPS Time Sync	For setting whether to correct the clock in the camera automatically using the received GPS data	

(*) Optio WG-2 GPS only

● [Setting] Menu 1

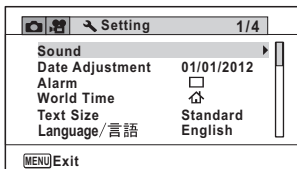

● [Setting] Menu 2

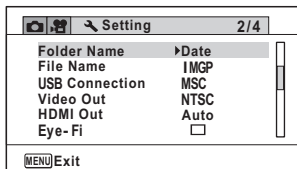

● [Setting] Menu 3

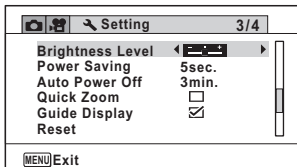

● [Setting] Menu 4

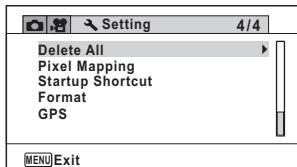

Taking Still Pictures

Taking Pictures

This camera is equipped with functions and shooting modes that support a wide array of scenes and subjects. This section explains shooting using the default settings when shipped.

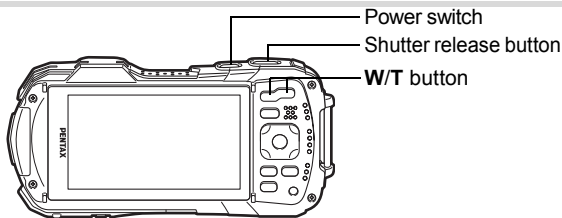

1 Press the power switch.

The camera turns on and is ready to take still pictures. In this manual, this is called Still Picture Capture Mode.

2 Confirm the subject and shooting information on the display.

The focus frame in the middle of the display indicates the zone of automatic focusing.



Focus frame

When the camera detects a person's face, the Face Detection function is activated and the face detection frame appears (p.69).

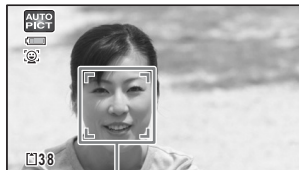

Face detection frame

You can change the captured area by pressing the zoom button (p.63).

Right (T) Enlarges the subject.

Left (W) Widens the area that is captured by the camera.

3

Press the shutter release button halfway.

The camera emits focus assist light in dark shooting situations.

The focus frame (or face detection frame) on the display turns green when the camera focuses on the subject at the correct distance.



4



Press the shutter release button fully.

The picture is taken.

The flash discharges automatically depending on the light conditions.

The image appears on the display temporarily (Instant Review: p.63) and is saved to the SD Memory Card or the built-in memory.



- Press the Green button to switch to  (Green) mode and let the camera set all the shooting functions automatically (p.73).
-  is displayed when the shutter release button is pressed halfway if there is a risk of camera shake.

Using the Shutter Release Button

The shutter release button works in a two-step action as follows.

Press halfway

This refers to pressing the shutter release button gently to the first position. This locks the focus setting and the exposure. The green focus frame lights on the display when the shutter release button is pressed halfway and the subject is in focus. If the subject is out of focus, the frame turns white.

Press fully

This refers to pressing the shutter release button all the way down to the fully depressed position. This takes a picture.

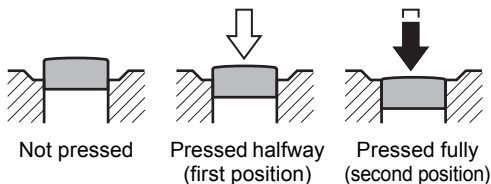

Poor focusing conditions

The camera may not be able to focus under the following conditions. In these cases, lock the focus on an object the same distance away as the subject (by pressing and holding the shutter release button halfway), then aim the camera at your subject and press the shutter release button fully.

- Objects that lack contrast such as a blue sky or white wall
- Dark places or objects, or conditions that prevent light being reflected back
- Intricate patterns
- Fast moving objects
- When there is an object in the foreground and an object in the background in the captured area
- Strongly reflected light or strong backlighting (bright background)

Instant Review and Blink Detection

The image appears on the display temporarily (Instant Review) immediately after it is captured. If the camera detects that the subject's eyes are closed while Face Detection (p.69) is activated, the message [Closed eyes have been detected] appears for 3 seconds (Blink Detection).



- When the Face Detection function does not work, Blink Detection also does not function. Even if the subject's faces are recognized, Blink Detection may not function depending on the condition of the recognized faces.
- You can also disable the Blink Detection function (p.104).

3

Using the Zoom

You can use the zoom to change the captured area.

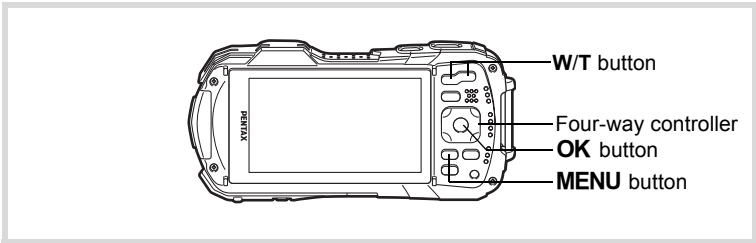

1

Press the W/T button in mode.

W Wide (left)

Widens the area that is captured by the camera.

T Tele (right)

Enlarges the subject.

If you continue to press **T**, the camera automatically switches from optical zoom to Intelligent Zoom and stops at the point where the zoom switches to digital zoom.

Once the button is released and pressed again, the camera switches to digital zoom.

If the digital zoom is set to off on the menu, the optical zoom and the Intelligent Zoom ranges are available for use. The zoom ratio of the Intelligent Zoom changes depending on the number of recorded pixels.

The zoom bar is displayed as follows.

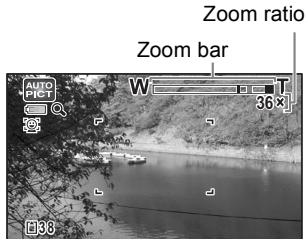

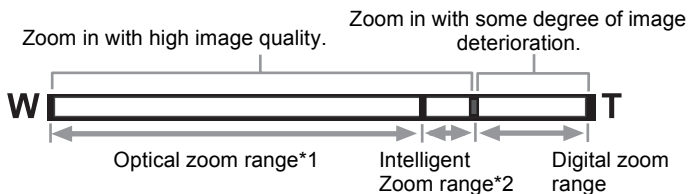

*1 You can zoom in to a maximum of 5× optically.

*2 The Intelligent Zoom range differs depending on the recorded pixels. See the following table.

3 Recorded pixels and the maximum zoom ratio

Recorded Pixels	Intelligent Zoom (The zoom ratio includes the 5× optical zoom.)	Digital zoom
16M / 12M <small>16:9</small> / 12M <small>4:3</small>	Not Available (5× optical zoom only)	Equivalent to approx. 36×
7M / 5M <small>16:9</small>	Approx. 7.5×	
5M / 4M <small>16:9</small>	Approx. 8.9×	
3M	Approx. 11.3×	
2M <small>16:9</small>	Approx. 12×	
1280 (*)	Not Available (5× optical zoom only)	
1024	Approx. 22.5×	Equivalent to approx. 36×
640	Approx. 36× (same as digital zoom)	

(*) 1280 can only be set for recorded pixels when (Report) mode is set.



- We recommend you use a tripod to prevent camera shake when taking pictures at high zoom.
- Pictures taken in the digital zoom range appear grainier than pictures taken in the optical zoom range.
- For details on the available functions, refer to “Functions Available for Each Shooting Mode” (p.220).
- The image enlarged using Intelligent Zoom may appear rough on the display. This does not affect the quality of the recorded image.
- Intelligent Zoom is available regardless of whether digital zoom is turned on or off.

To Set the Digital Zoom

The digital zoom is set to (On) in the default settings. To take pictures using only the optical zoom and Intelligent Zoom, set the digital zoom to (Off).

1 Press the **MENU** button in **📷** mode.

The [📷 Rec. Mode] menu appears.

2 Use the four-way controller (▲▼) to select [Digital Zoom].

3 Use the four-way controller (◀▶) to switch between (On) or (Off).

- (On) Uses digital zoom
- (Off) Uses only optical zoom and Intelligent Zoom

The setting is saved.

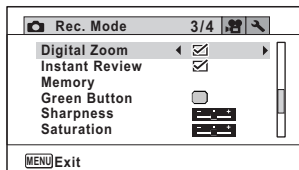

4 Press the **MENU** button.

The camera returns to capture mode.

Saving the Digital Zoom Function setting p. 120

Setting the Shooting Mode

This camera has a variety of shooting modes that let you take pictures or record movies and sound in different situations simply by choosing the right mode for the particular situation from the Capture Mode Palette.

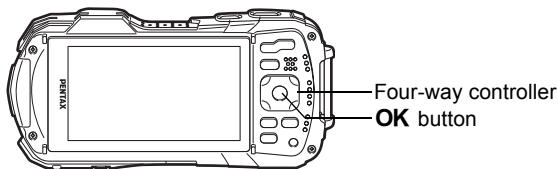

1 Press the four-way controller (▼) in **📷** mode.

The Capture Mode Palette appears.

2 Use the four-way controller (▲▼◀▶) to choose a shooting mode.























































A guide of the selected shooting mode is displayed in the lower part of the display.























3 Press the OK button.

The shooting mode is selected and the camera returns to capture mode.

The following 24 modes can be selected with Capture Mode Palette.

Item	Description	Page															
 Auto Picture	<p>The camera automatically selects the appropriate capture mode from the following fifteen modes</p> <table border="1" data-bbox="358 239 850 676"> <tr> <td data-bbox="358 239 522 337">  Standard </td> <td data-bbox="522 239 685 337">  Night Scene </td> <td data-bbox="685 239 850 337">  Night Scene Portrait </td> </tr> <tr> <td data-bbox="358 337 522 407">  Landscape </td> <td data-bbox="522 337 685 407">  Flower </td> <td data-bbox="685 337 850 407">  Portrait </td> </tr> <tr> <td data-bbox="358 407 522 477">  Sport </td> <td data-bbox="522 407 685 477">  Candlelight </td> <td data-bbox="685 407 850 477">  Blue Sky </td> </tr> <tr> <td data-bbox="358 477 522 575">  Portrait× Blue Sky </td> <td data-bbox="522 477 685 575">  Portrait× Backlight </td> <td data-bbox="685 477 850 575">  Sunset </td> </tr> <tr> <td data-bbox="358 575 522 673">  Portrait× Sunset </td> <td data-bbox="522 575 685 673">  Group Photograph </td> <td data-bbox="685 575 850 673">  Text </td> </tr> </table> <p>* When the camera detects the pet's full face, the shutter is automatically released.</p>	 Standard	 Night Scene	 Night Scene Portrait	 Landscape	 Flower	 Portrait	 Sport	 Candlelight	 Blue Sky	 Portrait× Blue Sky	 Portrait× Backlight	 Sunset	 Portrait× Sunset	 Group Photograph	 Text	—
 Standard	 Night Scene	 Night Scene Portrait															
 Landscape	 Flower	 Portrait															
 Sport	 Candlelight	 Blue Sky															
 Portrait× Blue Sky	 Portrait× Backlight	 Sunset															
 Portrait× Sunset	 Group Photograph	 Text															
 Program	<p>Used for basic shooting. The shutter speed and the aperture are set automatically by the camera during shooting. However, you can select other functions such as the flash mode and recorded pixels</p>	—															
 Night Scene	<p>For night time images. Use of a tripod or other support is suggested</p>	—															
 Handheld Night Snap	<p>Minimizes camera shake for shooting at night or other low light settings</p>	—															
 Movie	<p>For recording movies. Sound is recorded at the same time</p>	p.113															
 Underwater	<p>For capturing images underwater</p>	p.111															
 Underwater Movie	<p>Use this mode for taking underwater movie</p>	p.111															
 Digital Microscope	<p>Capture the bigger images of the closer objects (fixed to $\frac{2M}{1600}$)</p>	p.77															
 Landscape	<p>For capturing landscape views. Focuses the camera on wide range</p>	—															
 Flower	<p>For images of flowers. The outline of the flower is softened</p>	—															

Item		Description	Page
	Portrait	For capturing portraits. Reproduces a healthy and bright skin tone	—
	Interval Shot	Shoots a series of images at a specified interval of time	p.79
	Interval Movie	Shoots a series of images at a specified interval, and saves them as a movie	p.116
	High Speed Movie	Records a high speed movie for slow motion playback	p.119
	Digital SR	Higher sensitivity reduces blur	—
	Surf & Snow	For bright images such as sand or snow. Accurately meters for bright scenes	—
	Kids	For capturing moving kids. Reproduces a healthy and bright skin tone	—
	Pet	For capturing moving pets. Available to detect registered pets	p.74
	Sport	For a fast moving subject. Tracks the subject until the picture is taken	—
	Candlelight	For capturing scenes in candlelight	—
	Fireworks	For capturing fireworks. Use of a tripod or other support is suggested	—
	Night Scene Portrait	For images of people at night. Use of a tripod or other support is advised	—
	Text	Captures text in an easy to read manner. Text contrast can be adjusted	p.77
	Food	For images of food and prepared dishes. Enhances saturation and contrast	—
	Digital Wide	Stitches two pictures together to create a wider image (fixed to [3M])	p.85
	Digital Panorama	Stitches images taken with the camera to create a panoramic photograph	p.87
	Frame Composite	For capturing images with a frame. Recorded pixels is fixed to [3M] or [2M.FPS]	p.78
	Report	For capturing image with fixed 1280×960 pixels for reports	—

*  (Green) (p.73) and  (Voice Recording) (p.168) modes are available in addition to the ones noted above.



- In shooting modes other than (Program), (Night Scene), (Movie), (Digital Microscope), (Handheld Night Snap), (Interval Shot), (Interval Movie), (High Speed Movie), (Digital SR), (Digital Panorama), (Digital Wide), and (Frame Composite), Saturation, Contrast, Sharpness, White Balance, etc. are automatically set to the optimal settings for the selected mode.
- Some functions may not be available or may not function fully depending on the selected shooting mode. For details, refer to “Functions Available for Each Shooting Mode” (p.220).
- You can turn off the shooting mode guide on the Capture Mode Palette (p.191).
- The shutter speed tends to be slower when taking pictures of dark scenes. To prevent camera shake, set the Pixel Track SR to (On) (p.103) or use a tripod and/or remote control (optional), the self-timer function (p.81).

Using the Face Detection Function

When the camera detects a person's face in the image, the Face Detection function displays a yellow face detection frame around the face on the display screen, sets the focus (Face Detection AF) and compensates the exposure (Face Detection AE).

If the subject in the face detection frame moves, the frame also moves and changes size as it tracks the face.

The Face Detection function can recognize up to 32 people's faces. If it recognizes multiple faces, the camera displays a yellow frame over the main face and white frames over the other faces. It can display up to a total of 31 frames, including both the main and white frames.

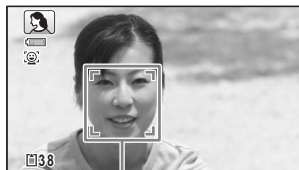

Face detection frame

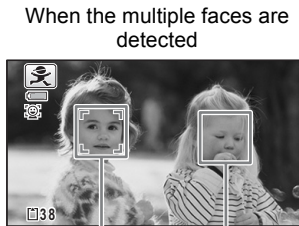

Main frame White frame



- Face Detection AF and AE may not work if the subject is wearing sunglasses, has part of their face covered or is not looking toward the camera.
- If the camera cannot detect the subject's face, the camera focuses using the setting currently selected in [Focusing Area].
- However, the Smile Capture function may not work and an image may not be captured, even when turned on, depending on the condition of the recognized faces, such as the faces are too small. If this happens, press the shutter release button to take a picture.
- In (Pet) mode, the Face Detection mode is switched to Pet Detection (only one pet).
- If you use the Face Detection function when the flash mode is set to (Auto), the flash mode automatically changes to (Flash On + Red-eye).

3

To Switch the Face Detection Function

By default, the Face Detection function is set to Face Detection On. You can switch to the Smile Capture function, which automatically releases the shutter when your subject smiles. The Face Detection function is switched as follows each time the button is pressed:

Smile Capture → Self-portrait Assist → Self-portrait Assist + Smile Capture → Face Detection Off → Face Detection On

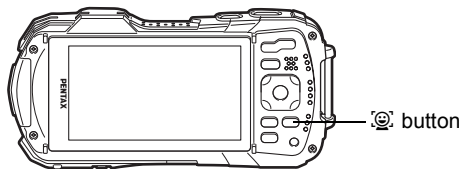

An icon indicating either Face Detection or Smile Capture appears on the display. (The Face Detection Off icon only appears right after the Face Detection function is switched to off.)

Face Detection On



Smile Capture



Self-portrait Assist



Face Detection Off

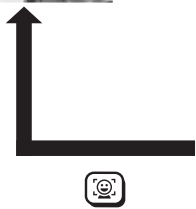

The Face Detection function cannot be selected in some shooting modes. Refer to “Functions Available for Each Shooting Mode” (p.220) for details.

3

To Use the Self-portrait Assist Function

The LED Macro Lights around the lens blink when the camera detects people faces in the Self-portrait Assist or Self-portrait Assist + Smile Capture function. The position of the blinking LED indicates where the detected face is on the screen.

The position (area) of the detected face corresponds to the blinking LED as follows.

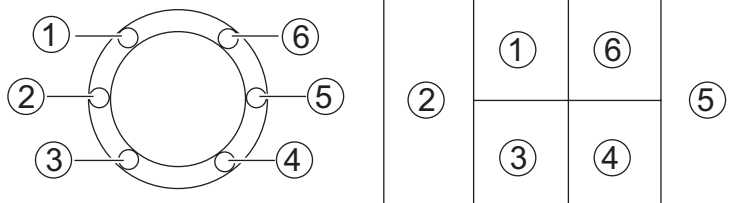

Example 1. When the camera detects a person in area ① on the display.

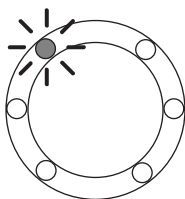

Example 2. When the camera detects two people in areas ② and ⑤ on the display.

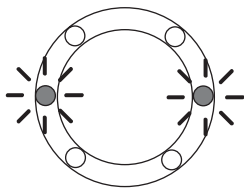



- When the camera detects two faces in the same area, the closest LED to the blinking LED also blinks.
- The camera can tell the position of up to three detected faces by blinking LED.
- When the camera detects three faces in area ②, LED ① to ③ blink.
- When the camera detects three faces in area ⑤, LED ④ to ⑥ blink.
- When the camera detects four or five faces, the LED blink depending on the number of detected faces. When the camera detects six or more faces, all LED (six) blink (the lights do not tell the position of detected faces).
- In (Auto Picture) mode, LED turn off after pressing the shutter release button halfway when the camera is in a mode with no Face Detection function.
- When the Self-portrait Assist function is on, LED do not turn off after the set period of Power Saving.
- LED do not blink when the detected faces are too small.

Taking Pictures in Basic Mode (Green Mode)

In (Green) mode, you can enjoy easy picture-taking using standard settings, regardless of the settings in the [Rec. Mode] menu.

mode settings are as shown below.

Flash Mode	(Auto)	Highlight Correction	<input type="checkbox"/> (Off)
Drive Mode	<input type="checkbox"/> (Standard)	Shadow Correction	<input type="checkbox"/> (Off)
Focus Mode	AF (Standard)	Sensitivity	AUTO (125-1600)
Information Display	Standard	EV Compensation	±0.0
Pixel Track SR	<input type="checkbox"/> (Off)	Blink Detection	<input checked="" type="checkbox"/> (On)
Recorded Pixels	(4608×2592)	Digital Zoom	<input checked="" type="checkbox"/> (On)
White Balance	AWB (Auto)	Instant Review	<input checked="" type="checkbox"/> (On)
Focusing Area	[] (Multiple)	Sharpness	(Normal)
Auto Macro	<input checked="" type="checkbox"/> (On)	Saturation	(Normal)
Focus Assist	<input checked="" type="checkbox"/> (On)	Contrast	(Normal)
AE Metering	(Multi-segment metering)	Date Imprint	Off
Image Tone	Bright	IQ Enhancer	<input checked="" type="checkbox"/> (On)
Quality Level	★★ (Better)	Macro Light	<input type="checkbox"/> (Off)

1 Press the Green button in mode.

The camera switches to  mode.

Press the Green button again to return to the status before  mode was selected.

When the camera detects a person's face, the Face Detection function is activated and the face detection frame appears (p.69).











2 Press the shutter release button halfway.

The focus frame on the display turns green when the camera focuses on the subject at the correct distance.

3 Press the shutter release button fully.

The picture is taken.



- Assign  mode to the [Green Button] on the [ Rec. Mode] menu for using  mode (p.105). (The default setting is  mode).
- Press the **MENU** button in  mode to display the [ Setting] menu. The [ Rec. Mode] menu cannot be displayed.
- When the camera is turned off in  mode, it turns on in  mode next time the power switch is pressed.

Taking Pictures of Your Pet (Pet Mode)

In  (Pet) mode, the camera automatically releases the shutter when the pet is detected. Also the camera can register pets.

1 Use the four-way controller () to select (Pet) from the Capture Mode Palette.

2 Press the OK button.

 (Pet) mode is selected and the camera returns to capture status.

When the camera detects the pet's full face, the shutter is automatically released.

To Register the Pet

- 1 Press the  button on the capture status screen in  (Pet) mode.

The pet selection screen appears.

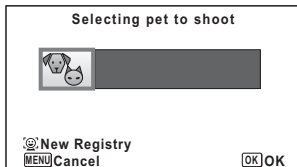

- 2 Press the  button again.

The pet registration screen appears.

Aiming the camera at the pet's full face automatically releases the shutter and the pet registration confirmation dialog appears.



Pet registration screen

When you select [Registry] using four-way controller () and press the **OK** button, the picture of the registered pet is indicated on the upper-left corner of the display and the camera returns to the capture status.



Registry confirmation screen

When the camera detects the pet's full face, the camera automatically releases the shutter.

You can also take a picture by pressing the shutter release button.

When you press the  button twice in the capture status screen, the pet registration screen appears to register another pet. You can register up to three pets.





Capture status screen



- When you press the **MENU** button on the pet registration screen, the registration will be canceled and the camera returns to the Still Picture Capture Mode.
- Only dogs and cats can be registered using the Pet Detection function. Other animals or human faces cannot be registered. You may not be able to register a pet's face if, for example, the pet's face is too small.
- The camera may not detect the registered pet's face, depending on the shooting situation.

To Switch the Pet You Want to Shoot

If you have registered two or three pets, choose the pet you want to detect.

- 1 Press the  button on the capture status screen in  (Pet) mode.

The pet registration screen appears.





- 2 Use the four-way controller (◀▶) to select the pet you want to detect.

- 3 Press the OK button.

The selected pet is switched to the pet you want to detect and the camera returns to capture status.

To Delete the Pet from the Entry

- 1 Press the  button on the capture status screen in  (Pet) mode.

The pet registration screen appears.



- 2 Use the four-way controller (◀▶) to select the pet you want to delete.

- 3 Press the  button.





- 4 Use the four-way controller (▲) to select [Delete].

- 5 Press the OK button.

The selected pet is deleted.

Taking Pictures of Text (Text Mode)

Take crisp and easy-to-read pictures of text. It is useful for taking pictures of and saving important documents, and when the text is too small and difficult to read.





	Color	A picture of the text is taken in its original color.
	Reversed Color	The colors are reversed.
	B&W	A picture of the text is taken in black and white.
	Negative	Black and white are reversed.

1 Use the four-way controller (▲▼◀▶) to select  (Text) from the Capture Mode Palette.

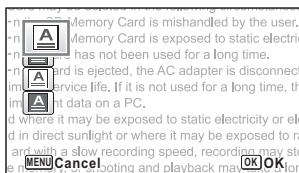
2 Press the OK button.

The text mode selection screen appears.



3 Use the four-way controller (▲▼) to select , , , or .

4 Press the OK button.

The selected icon appears and the camera returns to capture status.

Taking Pictures in Digital Microscope Mode

In  (Digital Microscope) mode, you can take pictures of objects as close as 1 cm, also because the LED Macro Lights around the lens are always lighted, you can take minute pictures of text, the veins of leaves, or specimens of tiny insects etc.



The illumination of the LED Macro Lights may be uneven or insufficient depending on the shooting conditions.

1 Use the four-way controller (▲▼◀▶) to select  (Digital Microscope) from the Capture Mode Palette.

2 Press the OK button.

 mode is selected and the camera returns to capture mode.

3 Press the W/T button.

If you press **T**, the camera enlarges the subject.

You can enlarge the subject up to 6.5 times(*).

(*)Intelligent Zoom is included. Up to 1.8 times for optical zoom.

W Wide (left)

Widens the area that is captured by the camera.

T Tele (right)

Enlarges the subject.



Attaching the supplied macro stand (O-MS1) reduces camera shake during macro photography (p.24).

Framing Your Pictures (Frame Composite Mode)

In (Frame Composite) mode, you can take pictures using the frames stored in the camera.

1 Use the four-way controller (▲▼◀▶) to select (Frame Composite) from the Capture Mode Palette.

2 Press the OK button.

The 12-frame display of the frame selection screen appears.

3 Use the four-way controller (▲▼◀▶) to choose the frame you want to use.



4 Press the Q button.

The selected frame appears in single-image display.

You can choose another frame using either of the following operations.

Four-way controller (◀▶)	Press to choose a different frame.
Zoom button left (⊞)	Press to return to the 12-frame display of the frame selection screen, and then perform step 4 to choose a different frame.

5

Press the OK button.

The frame appears on the display.

When the camera detects a person's face, the Face Detection function is activated and the face detection frame appears (p.69).



At shipment, the camera includes 3 default frames for each aspect ratio (4:3 and 16:9).

Optional Frames

The optional frames are stored in the CD-ROM supplied with the camera. To use these frames, copy them from the CD-ROM (p.155). These optional frames are deleted if the files on the built-in memory are deleted with a computer or if the built-in memory is formatted.

Adding a Frame to a captured image p.153

Taking Pictures at a Set Interval (Interval Shot)

In this mode, a set number of pictures can be taken automatically at a set interval from a set time.

Interval	10 sec. – 99 min.	Set the camera to take pictures at intervals. The intervals can be set in increments of one second from ten seconds to 4 minutes, or in 1 minute increments from 4 to 99 minutes. You cannot set the camera to take interval shots at less than ten seconds.
Number of Shots	2 shots – number of recordable images	You can set this to up to 1000 shots. However, it cannot exceed the number of recordable images.
Start Delay	0 min. – 24 hours	You can set 1 minute increments for the first 59 minutes and 1 hour increments from there. If the start time is set to 0 minutes, the first picture is taken as soon as the shutter release button is pressed.

1

Use the four-way controller (▲▼◀▶) to select (Interval Shot) from the Capture Mode Palette.

2

Press the OK button.

The current interval shot settings appear for approximately 1 minute. To take pictures with the current settings, go to step 10.

3

Press the OK button while the settings are displayed.

The [Interval Shot] setting screen appears. [Interval] is marked with the frame.

4 Set the interval.

- 1 Press the four-way controller (▶).
- 2 Use the four-way controller (▲▼) to set the minutes, then press the four-way controller (▶).
- 3 Use the four-way controller (▲▼) to set the seconds, then press the four-way controller (▶).

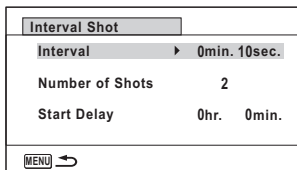

The frame returns to [Interval].

5 Press the four-way controller (▼).

The frame moves to [Number of Shots].

6 Set the number of shots.

- 1 Press the four-way controller (▶).
- 2 Use the four-way controller (▲▼) to set [Number of Shots], then press the four-way controller (▶).

The frame returns to [Number of Shots].

7 Press the four-way controller (▼).

The frame moves to [Start Delay].

8 Set the start delay.

- 1 Press the four-way controller (▶).
- 2 Use the four-way controller (▲▼) to set the hours, then press the four-way controller (▶).
- 3 Use the four-way controller (▲▼) to set the minutes, then press the four-way controller (▶).

The frame returns to [Start Delay].

9 Press the MENU button.

The [Interval Shot] settings are saved and the camera returns to capture mode.

10 Press the shutter release button halfway.

The focus frame on the display turns green if the subject is in focus.

11 Press the shutter release button fully.

Interval shooting starts.

The LCD turns off between shots (during standby). Press the power switch during standby to display the remaining number of shots and interval on the monitor.

The [Stop interval shooting?] message is displayed when the power switch and then the MENU button are pressed during standby. Pressing the OK button cancels interval shooting.



- Even if an alarm is set, the alarm will not ring during interval shooting.
- Interval shot stops if the SD Memory Card is removed or inserted during standby.

Using the Self-timer

In Self-timer mode, the picture is taken ten seconds or two seconds after the shutter release button is pressed.

Stabilize the camera with a tripod or other support when taking a picture with the self-timer.

	Use this mode when you want to be included in a group picture. The picture is taken approximately ten seconds after the shutter release button is pressed.
	Use this mode to avoid camera shake. The picture is taken approximately two seconds after the shutter release button is pressed.

1 Press the four-way controller (▲) in mode.

The [Drive Mode] screen appears.

2 Use the four-way controller (◀▶) to select and press the four-way controller (▼).

3 Use the four-way controller (◀▶) to select or and press the OK button.

The camera is ready to take the picture using the self-timer.

When the camera detects a person's face, the Face Detection function is activated and the face detection frame appears (p.69).



4 Press the shutter release button to take a picture.

Countdown starts and the remaining seconds are displayed on the screen.

If you select

The self timer lamp and all of the LED Macro Lights turn on.

From 5 seconds before shooting, the LED Macro Lights turn off in order from the top right.

From 3 seconds before shooting, the self timer lamp also blinks.

If you select

The self timer lamp and the LED Macro Lights blink.

The picture is taken after a countdown of either ten seconds or two seconds.



Focusing may be compromised if you move the camera while the self-timer lamp is blinking when taking still pictures.



- In (Movie), (Underwater Movie) and (High Speed Movie) modes, recording will start after ten seconds or two seconds.
- Press the shutter release button halfway while the self-timer is engaged to stop the countdown and press fully to restart the countdown.
- cannot be selected while (Green) mode is in default setting. Select in another shooting mode and then switch the shooting mode to .
- The self-timer lamp does not turn on or blink in (Pet) mode.
- In the following situations, the LED Macro Lights remain turned on regardless of the countdown.
 - In (Digital Microscope) mode
 - When [Macro Light] on the [Rec. Mode] menu is set to (On)
- cannot be selected in some shooting modes. Refer to “Functions Available for Each Shooting Mode” (p.220) for details.

3

Taking a Series of Pictures (Continuous Shooting/Burst Shooting)

Pictures are taken continuously as long as the shutter release button is pressed.

	Continuous Shooting	Each time a picture is taken, the image is saved in the memory before the next image is taken. The higher the image quality, the longer the interval between shots.
	Burst Shooting	The number of recorded pixels is fixed at / and the interval between shots is shorter than “Continuous Shooting”.

* The number of images that can be shot continuously and the interval between shots depend on shooting situations.

1

Press the four-way controller (▲) in mode.

The [Drive Mode] screen appears.

2

Use the four-way controller (◀▶) to select or and press the OK button.

The camera is ready for continuous shooting and burst shooting.

3







Press the shutter release button to take a picture.

Pictures are taken continuously as long as you keep the shutter release button pressed.





/ cannot be selected in some shooting modes. Refer to “Functions Available for Each Shooting Mode” (p.220) for details.



- With , you can continue shooting until the memory capacity of the SD Memory Card or built-in memory is full.
- The interval of  varies according to the [Recorded Pixels] and [Quality Level] settings.
- The focus, exposure and white balance are locked with the first shot.
- When the Face Detection function is activated (p.69), it works only when taking the first shot.
- The Blink Detection function works only for the last shot.
- The number of recorded pixels is fixed at  /  in  mode. When the shooting mode is set to  (Report), the number of recorded pixels is set to .

Taking Pictures Using the Remote Control Unit (Optional)

You can use the remote control (optional) to take pictures while you are away from the camera.

	The shutter will be released after about three seconds when the shutter release button on the remote control unit is pressed.
	The shutter will be released immediately when the shutter release button on the remote control unit is pressed.

1 Press the four-way controller (▲) in mode.

The [Drive Mode] screen appears.

2 Use the four-way controller (◀▶) to select and press the four-way controller (▼).

3 Use the four-way controller (◀▶) to select or and press the OK button.

The self-timer lamp begins to blink slowly and the camera is ready to take a picture with the remote control.

When the camera detects a person's face, the Face Detection function is activated and the face detection frame appears (p.69).

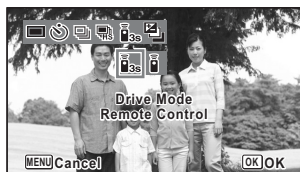

Point the remote control at the remote control receiver and press the shutter release button on the remote control.

The focus frame turns green when the subject is in focus and the camera takes a picture at the following timing.







When  is selected:

The self-timer lamp and the LED Macro Lights blink quickly and the camera takes a picture after about three seconds.

When  is selected:

The camera takes a picture immediately.



- The shooting with remote control is available from the front of the camera and the back of the camera.
- The operating range is approx. 4 m from the front of the camera and 2 m from the back of it.
- In  (Movie),  (Underwater Movie) and  (High Speed Movie) modes, pressing the shutter release button again stops the recording.
- The camera takes a picture even if the focus is not achieved.
- If the shutter release button on the camera is pressed halfway during the countdown, the countdown stops. If the shutter release button on the remote control is pressed again, the camera starts the countdown again.
-  /  cannot be selected in some shooting modes. Refer to “Functions Available for Each Shooting Mode” (p.220) for details.
- The self-timer lamp does not turn on or blink in  (Pet) mode.

Taking Pictures with Automatic Exposure Adjustment (Auto Bracketing)

Press the shutter release button once to automatically adjust the exposure and take three pictures in succession. After taking the pictures, you can select the best one.

The shooting order is best exposure → -1.0 EV → +1.0 EV.

1

Press the four-way controller (▲) in  mode.

The [Drive Mode] screen appears.

2

Use the four-way controller (◀▶) to select  (Auto Bracketing) and press the OK button.

The camera is now ready to take pictures with Auto Bracketing.



- When the Instant Review is set to (On) (p.104), the pictures taken are shown in Instant Review after shooting (p.63).
-  cannot be selected in some shooting modes. Refer to “Functions Available for Each Shooting Mode” (p.220) for details.

Using the Digital Wide Function (Digital Wide Mode)

In **WIDE** (Digital Wide) mode, you can stitch two vertical images captured with this camera into a single frame up to approx. 21 mm coverage (35 mm film equivalent).



1 Use the four-way controller (▲▼◀▶) to select **WIDE** (Digital Wide) from the Capture Mode Palette.

2 Press the OK button.

The camera enters **WIDE** mode.

Turn the camera 90° clockwise and align your first picture.

When the camera detects a person's face, the Face Detection function is activated and the face detection frame appears (p.69).

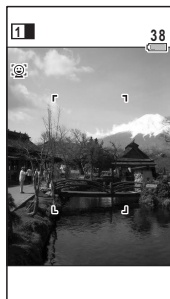

3 Press the shutter release button to take a picture.

The first captured image is temporarily saved, and the shooting screen for the second image is displayed.



4 Take the second image.

Overlap the image on the preview guide on the left of the screen to compose the second image. Repeat steps 4 and 5 to take the second image. This combines first and second images.

The stitched first and second image appears on the display temporarily (Instant Review), and then is saved.



- To minimize distortion when taking the second image, turn the camera so that it pivots around the right edge of the preview guide on the screen.
- Some distortion may result from moving objects, repeating patterns, or if nothing exists when overlapping the first and second image on the preview guide.
- When the Face Detection function is activated (p.69), it works only when taking the first shot.
- The number of recorded pixels for images captured with **WIDE** mode is fixed at **[5M]**.

To Cancel after Taking the First Shot

1 When the shooting screen for the second image is displayed in step 5 on p.86, press the **OK** button or the four-way controller (▼).

A confirmation dialog appears.

- 2** Use the four-way controller (▲▼) to select an option and press the OK button.

Save	Saves the first image and you can retake the first shot. The first image is saved at [3M].
Discard	Discards the first image and you can retake the first shot.
Cancel	Returns to the shooting screen for the second image.

Taking Panoramic Pictures (Digital Panorama Mode)

In ■■■ (Digital Panorama) mode, you can stitch together two or three captured frames to create a panoramic photograph with the camera.

- 1** Use the four-way controller (▲▼◀▶) to select ■■■ (Digital Panorama) from the Capture Mode Palette.

- 2** Press the OK button.

The camera enters ■■■ mode and the message [Set shift direction] is displayed.

- 3** Use the four-way controller (◀▶) to choose the direction in which the images will be joined.

The screen for taking the first frame is displayed.

When the camera detects a person's face, the Face Detection function is activated and the face detection frame appears (p.69).



- 4** Press the shutter release button to take a picture.

The screen for taking the second frame is displayed after you take the first frame.

If you select right (▶) in step 4:

The right edge of the first frame appears in semi-transparent form on the left edge of the display.

If you select left (◀) in step 4:

The left edge of the first frame appears in semi-transparent form on the right edge of the display.

5 Take the second frame.

Move the camera so that the semi-transparent image and the actual view overlap and press the shutter release button.

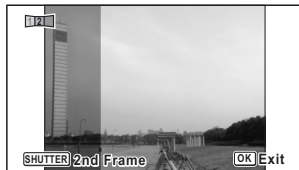
**6 Take the third frame.**

Repeat steps 4 to 5 to take the third frame.

The panorama images are joined and a stitched together image appears.

The stitched together image does not appear when [Instant Review] (p.104) is off.



- Some distortion may result from moving objects, repeating patterns, or if nothing exists when overlapping the first and second frames or the second and third frames on the preview guide.
- When the Face Detection function is activated (p.69), it works only when taking the first shot.

To Cancel after Taking the First or Second Frame**1 After shooting the first frame in step 6 on p.88 or the second frame in step 7, press the OK button or the four-way controller (▼).**

A confirmation dialog appears.

2 Use the four-way controller (▲▼) to select an option and press the OK button.

Save	Saves the captured image(s) and you can retake the first frame. When this option is selected after shooting the second frame, the first and the second frames are stitched together and saved as a panoramic photograph.
Discard	Discards the captured image(s) and you can retake the first frame.
Cancel	Returns to the previous shooting screen.



Unstitched images shot in **■■■** mode are fixed at **2M** (1600×1200).

Setting the Shooting Functions

Setting the Rec. Mode Menu

Settings for shooting are mostly set from the [📷 Rec. Mode] menu. Refer to explanations for each function on how to make these settings.

- 1 Press the MENU button in Still Picture Capture Mode.**

The [📷 Rec. Mode] menu appears.
Pressing the **MENU** button in 📷 (Movie), 📷 (Underwater Movie), 📷 (High Speed Movie) and 📷 (Interval Movie) modes displays the [📷 Movie] menu.
- 2 Use the four-way controller (▲▼◀▶) to select an item and set it up.**

To Finish the Setting

- 3 After setting, press the MENU button.**

The camera returns to capture status.
The setting is saved and the camera returns to the previous screen.

To Save the Setting and Start Taking Pictures

- 3 Press the shutter release button halfway.**

The setting is saved and the camera returns to capture mode.



When the [📷 Setting] menu is displayed from ▶ mode, you can switch to 📷 mode by pressing the ▶ button.

To Save the Setting and Start Playback of Images

- 3 Press the ▶ button.**

When the [📷 Rec.Mode], [📷 Movie] or [📷 Setting] menu is displayed from 📷 mode, the setting is saved and the camera returns to playback mode.

To Cancel the Changes and Continue with Menu Operations

- 3 Press the MENU button.**

The changes are canceled and you can select a menu.



The **MENU** button function differs depending on the screen. Refer to the guide indications.

- Exit Exits the menu and returns to the original screen.
- ↶ Returns to the previous screen with the current setting.
- Cancel Cancels the current selection, exits the menu and returns to the previous screen.

Selecting the Flash Mode

3

	Auto	The flash discharges automatically depending on the light conditions.
	Flash Off	The flash does not discharge, regardless of the brightness. Use this mode to take pictures where flash photography is prohibited.
	Flash On	The flash discharges regardless of the brightness.
	Auto + Red-eye	This mode reduces the phenomenon of red eyes caused by the light from the flash being reflected in the subject's eyes. The flash discharges automatically.
	Flash On + Red-eye	This mode reduces the phenomenon of red eyes caused by the light from the flash being reflected in the subject's eyes. The flash discharges regardless of the light conditions.



- The selectable function differs depending on the shooting mode, focus mode or drive mode you have set. Refer to “Functions Available for Each Shooting Mode” (p.220) for details.
- If you use the Face Detection function when is selected, the mode is automatically set to .
- A pre-flash discharges when using the red-eye reduction function.



Using the flash when capturing images at a close distance may cause irregularities in the image due to the light distribution.

1

Press the four-way controller (◀) in mode.

The [Flash Mode] screen appears.



The flash mode changes each time the button is pressed. You can also change the setting using the four-way controller (▲▼).



Press the OK button.

The setting is saved and the camera returns to capture mode.





About the red-eye phenomenon

Taking pictures using the flash may cause the subject's eyes to appear red in the resulting picture. This phenomenon occurs when the light from the flash is reflected in the subject's eyes. It can be reduced by illuminating the area around the subject or moving closer to the subject and zooming out to a wider angle. Setting the flash mode to  (Auto + Red-eye) or  (Flash On + Red-eye) is also an effective way of reducing red eyes.

If the subject's eyes appear red despite such precautions, they can be corrected by the red-eye compensation function (p.152).

Saving the Flash Mode setting  p.120

Selecting the Focus Mode

AF	Standard	This mode is used when the distance to the subject is from 50 cm to ∞ . The camera is focused on the subject in the autofocus area when the shutter release button is pressed halfway.
	Macro	This mode is used when the distance to the subject is from 10 cm to 60 cm. The camera is focused on the subject in the autofocus area when the shutter release button is pressed halfway.
	1cm Macro	This mode is used when the distance to the subject is from 1 cm to 30 cm. The camera is focused on the subject in the autofocus area when the shutter release button is pressed halfway.
PF	Pan Focus	This mode is used when you ask someone to take pictures for you, or when taking pictures of the scenery through the window of a car or train. The entire picture, from the front to the back, is focused.
	Infinity	This mode is used for taking distant objects. The flash is set to  (Flash Off).
MF	Manual Focus	This mode lets you adjust the focus manually.

1 Press the four-way controller (▶) in mode.

The [Focus Mode] screen appears.

The focus mode changes each time the button is pressed. You can also change the setting using the four-way controller (▲▼).

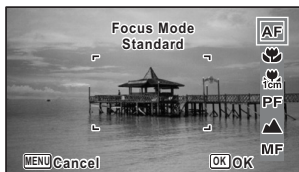





2 Press the OK button.

The setting is saved and the camera returns to capture mode.

3



- The selectable function differs depending on the shooting mode. Refer to “Functions Available for Each Shooting Mode” (p.220) for details.
- The noise from focusing is recorded when a focus mode other than **PF** or **▲** is selected in  (Movie),  (Underwater Movie) and  (High Speed Movie) modes.
- When [Auto Macro] is on and shooting with  selected, if the subject is further than 60 cm away, the camera automatically focuses to ∞ (Infinity).

Saving the Focus Mode setting  p.120

To Set the Manual Focus

The procedure for setting the focus manually (**MF**) is described below.

1 Press the four-way controller (▶) in mode.

The [Focus Mode] screen appears.

2 Use the four-way controller (▶) to select MF.

3 Press the OK button.

The central portion of the image is magnified to full screen on the display.

4 Press the four-way controller (▲▼).

The **MF** indicator appears on the display to indicate the approximate distance to the subject. Use the four-way controller (▲▼) to adjust the focus using the indicator as a guide.

- ▲ for distant focus
- ▼ for closer focus



MF indicator

5 Press the OK button.

The focus is fixed and the camera returns to capture mode.

After the focus is fixed, you can press the four-way controller (▶) again to display the **MF** indicator and readjust the focus.



The shooting mode and drive mode cannot be changed while the **MF** indicator is displayed.



To switch from **MF** to another focus mode, press the four-way controller (▶) while the **MF** indicator is displayed.

Changing the Focusing Area (AF area)

You can change the autofocus area (Focusing Area).

[] Multiple	Normal autofocus area
[] Spot	The autofocus area becomes smaller.
[] Automatic Tracking AF	Keeps moving subjects in focus.

1 Use the four-way controller (▲▼) to select [AF Setting] on the [📷 Rec. Mode] menu.

2 Press the four-way controller (▶).
The [AF Setting] screen appears.

3 Use the four-way controller (▲▼) to select [Focusing Area].

4 Press the four-way controller (▶).
A pull-down menu appears.

5 Use the four-way controller (▲▼) to change the Focusing Area.

6 Press the OK button.
The setting is saved.



The selectable function differs depending on the shooting mode. Refer to "Functions Available for Each Shooting Mode" (p.220) for details.

Setting the Auto Macro

When [Auto Macro] is on, the focus is adjusted to the macro range (distance to the subject is 10 cm to 60 cm) as necessary, even if the focus mode setting is AF (Standard).

When it is off and the focus mode is set to Standard (**AF**), the AF operates only in the standard range, and focusing is not done in the macro range.

When the focus mode is set to Macro or 1cm Macro, the focus is only adjusted in the respective macro range and is not done in the standard range.

- 1** Use the four-way controller (▲▼) to select [AF Setting] on the [📷 Rec. Mode] menu.
- 2** Press the four-way controller (▶).
The [AF Setting] screen appears.
- 3** Use the four-way controller (▲▼) to select [Auto Macro].
- 4** Use the four-way controller (◀▶) to select (On)/ (Off).
The setting is saved.

Setting the AF Assist Light (Focus Assist)

The camera automatically emits the focus assist light in dark shooting situations. You can set the light to on or off.

- 1** Use the four-way controller (▲▼) to select [AF Setting] on the [📷 Rec. Mode] menu.
- 2** Press the four-way controller (▶).
The [AF Setting] screen appears.
- 3** Use the four-way controller (▲▼) to select [Focus Assist].
- 4** Use the four-way controller (◀▶) to select (On)/ (Off).
The setting is saved.



Looking at the light directly will not create a safety hazard. However, do not look into the emitter from a very short distance since you may feel dazzled.



The camera does not emit the focus assist light depending on the shooting mode or focus mode. Refer to "Functions Available for Each Shooting Mode" (p.220) for details.

Setting the Image Tone

For setting the tone of images.

You can select from [Bright], [Natural], or [Monochrome].

The default setting is [Bright].

1 Use the four-way controller (▲▼) to select [Image Tone] on the [📷 Rec. Mode] menu.

2 Press the four-way controller (▶).

A pull-down menu appears.

3 Use the four-way controller (▲▼) to select a finishing tone.

4 Press the OK button.

The setting is saved.



When [Monochrome] is selected, [Tone Adjustment] appears on the [📷 Rec. Mode] menu for setting the tone of monochrome images instead of [Saturation].

Selecting the Number of Recorded Pixels

You can choose the number of recorded pixels settings for still pictures. The larger the number of recorded pixels, the clearer the details will appear when you print your picture. As the quality of the printed picture also depends on the image quality, exposure control, resolution of the printer, and other factors, you do not need to select more than the required number of recorded pixels. [3M] is adequate for making postcard-size prints. The more pixels there are, the larger the picture and the bigger the file size. Refer to the following table for the appropriate settings according to expected usage.

Recorded Pixels	Expected Usage
[16M] 4608×3456	For printing high quality photos or A4-size pictures or larger, or editing images on a computer.
[12M] 3456×3456	
[12M] 4608×2592	
[7M] 3072×2304	
[5M] 3072×1728	
[5M] 2592×1944	For making postcard-size prints.
[4M] 2592×1464	
[3M] 2048×1536	
[2M] 1920×1080	
[1280] 1280×960	For posting on a website or attaching to e-mail.
[1024] 1024×768	
[640] 640×480	

Clearer

- The default setting is [12M].
- [1280] can only be set for recorded pixels when [Report] mode is set. [1280] does not appear in the Recorded Pixels menu.



If you select [16M] / [7M] / [5M] / [3M] / [1024] / [640], the aspect ratio of the screen is 4:3. The monitor display for recording and playback is as shown on the right.



- 1** Use the four-way controller (▲▼) to select [Recorded Pixels] on the [📷 Rec. Mode] menu.
- 2** Press the four-way controller (▶).
A pull-down menu appears.
- 3** Use the four-way controller (▲▼) to change the number of recorded pixels.
- 4** Press the OK button.
The setting is saved.



The selectable number of recorded pixels differs depending on the shooting mode. Refer to “Functions Available for Each Shooting Mode” (p.220) for details.

Selecting the Quality Level of Still Pictures

Select the quality level (data compression ratio) for still images according to how the images will be used.

The more stars (★), the higher the quality of the image, but the file size increases. The selected recorded pixels setting also affects the size of the image file (see p.96).





Quality Level

★★★	Best	Lowest compression ratio. Suitable for photo prints.
★★	Better	Standard compression ratio. Suitable for viewing the image on a computer screen. (default setting)
★	Good	Highest compression ratio. Suitable for attaching to e-mails or creating websites.

- 1** Use the four-way controller (▲▼) to select [Quality Level] on the [📷 Rec. Mode] menu.
- 2** Press the four-way controller (▶).
The pull-down menu appears.
- 3** Use the four-way controller (▲▼) to change the quality level.
The number of recordable still pictures is displayed at the top of the screen when you select a quality level.
- 4** Press the OK button.
The setting is saved.

Adjusting the White Balance

You can take pictures in natural colors by adjusting the white balance according to the light conditions at the time of shooting.

AWB	Auto	The camera adjusts the white balance automatically.
	Daylight	Use this mode when taking pictures outside in sunlight.
	Shade	Use this mode when taking pictures outside in the shade.
	Tungsten Light	Use this mode when taking pictures under electric or other tungsten light.
	Fluores. Light	Use this mode when taking pictures under fluorescent light.
	Manual	Use this mode when adjusting the white balance manually.

3



- Set another white balance if you are not satisfied with the color balance of pictures taken with the white balance set to **AWB**.
- The White balance setting may not be changed depending on the selected shooting mode. Refer to “Functions Available for Each Shooting Mode” (p.220) for details.

1 Use the four-way controller (▲▼) to select [White Balance] on the [Rec. Mode] menu.

2 Press the four-way controller (▶).
The [White Balance] screen appears.

3 Use the four-way controller (▲▼) to change the setting.

You can check the results of available white balance settings on the preview image each time you press the four-way controller.

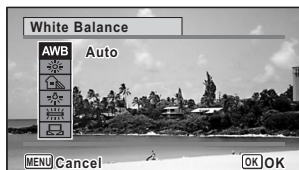

4 Press the OK button.
The setting is saved.





If you change the [White Balance] setting frequently, you can save time by assigning the Fn settings to the Green button (p.105).

Saving the White Balance setting  p.120



Manual Setting

Have a blank sheet of white paper or similar material ready.

- 1** In the [White Balance] screen, use the four-way controller (▲▼) to select  (Manual).
- 2** Point the camera at the blank sheet of paper or other material so that it fills the frame displayed in the center of the screen.
- 3** Press the shutter release button fully.
The white balance is automatically adjusted.
- 4** Press the OK button.
The setting is saved and the screen returns to the [ Rec. Mode] menu.

Setting the AE Metering

You can set the area of the screen where the brightness is metered to determine the exposure.

	Multi-segment metering	The camera divides the image into 256 areas, meters the brightness and determines the exposure.
	Center-weighted metering	The camera takes a reading of the overall brightness of the picture with the center of the image having more influence on the exposure.
	Spot AE metering	The camera determines the exposure by metering the brightness only at the center of the image.

- 1** Use the four-way controller (▲▼) to select [AE Metering] on the [ Rec. Mode] menu.
- 2** Press the four-way controller (▶).
A pull-down menu appears.
- 3** Use the four-way controller (▲▼) to select a metering method.
- 4** Press the OK button.
The setting is saved.



- When the shutter release button is pressed halfway, the brightness is metered and the exposure is determined.
- When the subject is outside the focusing area and you want to use Spot AE metering, aim the camera at the subject and press and hold the shutter release button halfway to lock the exposure, then compose your picture again and press the shutter release button fully.
- The AE Metering setting may not be changed depending on the selected shooting mode. Refer to “Functions Available for Each Shooting Mode” (p.220) for details.

Saving the AE Metering setting p.120

3

Setting the Sensitivity

You can select the sensitivity to suit the brightness of the surroundings.

AUTO	The sensitivity is automatically adjusted by the camera. (Default value: sensitivity 125-1600)
125	 <p>The lower the sensitivity, the less noise that affects the image. The shutter speed will be slower in low light conditions.</p> <p>Higher sensitivity settings use faster shutter speeds in low light conditions to reduce camera shake, but the image may be affected by noise.</p>
200	
400	
800	
1600	
3200	
6400	

1 Use the four-way controller (▲▼) to select [Sensitivity] on the [📷 Rec. Mode] menu.

2 Press the four-way controller (▶).
A pull-down menu appears.

3 Use the four-way controller (▲▼) to change the sensitivity.

4 Press the OK button.
The setting is saved.



- The sensitivity cannot be selected in some shooting modes. Refer to “Functions Available for Each Shooting Mode” (p.220) for details.
- When the shooting mode is set to (Report), the AUTO is fixed at 125-6400. Other sensitivities can also be selected.
- When [Pixel Track SR] is set to (On), 3200/6400 cannot be selected.
- When the sensitivity is set to 125 and Highlight Correction is set to (On), the setting changes to 250 (200 cannot be selected). The setting returns when Highlight Correction is set to (Off).

Saving the Sensitivity setting p.120

Setting AUTO ISO Range

Set the sensitivity range when the sensitivity is set to AUTO.

The sensitivity can be set to 125-200, 125-400, 125-800, 125-1600, 125-3200, 125-6400.

- 1 Use the four-way controller (▲▼) to select [AUTO ISO Range] on the [📷 Rec. Mode] menu.**
- 2 Press the four-way controller (▶).**
A pull-down menu appears.
- 3 Use the four-way controller (▲▼) to select the sensitivity adjustment range.**
- 4 Press the OK button.**
The setting is saved.



- AUTO ISO Range cannot be selected in some shooting modes. Refer to “Functions Available for Each Shooting Mode” (p.220) for details.
- When [Pixel Track SR] is set to (On), 125-3200 and 125-6400 cannot be selected.

Setting the Exposure (EV Compensation)

For adjusting the overall brightness of the picture.

Use this function to take pictures that are intentionally overexposed or underexposed.

- 1 Use the four-way controller (▲▼) to select [EV Compensation] on the [📷 Rec. Mode] menu.**

2 Use the four-way controller (◀▶) to select the EV value.

To brighten, select a positive (+) value. To darken, select a negative (–) value. You can choose the EV setting in the range of –2.0 EV to +2.0 EV in 1/3 EV steps.



- When a histogram is displayed in Still Picture Capture Mode or playback mode, you can check whether the exposure is correct (p.31).
- EV Compensation cannot be used in some shooting modes. Refer to “Functions Available for Each Shooting Mode” (p.220) for details.

Saving the EV Compensation setting see p.120

Correcting the Brightness (D-Range Setting)

Expands the dynamic range and prevents bright and dark areas from occurring. [Highlight Correction] adjusts the bright areas when the image is too bright and [Shadow Correction] adjusts the dark areas when the image is too dark.

1 Use the four-way controller (▲▼) to select [D-Range Setting] on the [Rec. Mode] menu.

2 Press the four-way controller (▶).

The [D-Range Setting] screen appears.

3 Use the four-way controller (▲▼) to select [Highlight Correction] or [Shadow Correction].

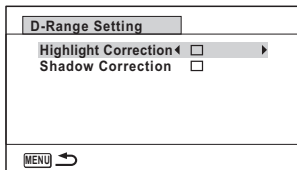

4 Use the four-way controller (◀▶) to select (On) or (Off).

The D-Range Setting icon appears on the display.



	When [Highlight Correction] is set to <input checked="" type="checkbox"/>
	When [Shadow Correction] is set to <input checked="" type="checkbox"/>
	When [Highlight Correction] and [Shadow Correction] are set to <input checked="" type="checkbox"/>



- When the Sensitivity is set to 125 or 200 and Highlight Correction is set to (On), the setting changes to 250. The setting returns when Highlight Correction is set to (Off).
- If you change the [Highlight Correction] or [Shadow Correction] setting frequently, you can save time by assigning it to the Green button (p.105).



D-Range setting cannot be set in some shooting modes. Refer to “Functions Available for Each Shooting Mode” (p.220) for details.

Setting Pixel Track SR

You can set this function to correct for camera shake when taking still shots. If Pixel Track SR is set to (On), the camera automatically corrects for camera shake in the images you shot. The default setting is (Off).



Shake Reduction settings in (Movie) and (Underwater Movie) mode are configured under Movie SR (p.116).

1

Use the four-way controller (▲▼) to select [Pixel Track SR] on the [Rec. Mode] menu.

2

Use the four-way controller (◀▶) to switch between (On) or (Off).

- (On) Automatically corrects for camera shake.
- (Off) No correction for camera shake.

The setting is saved.



- Pixel Track SR cannot be set in some shooting modes. Refer to “Functions Available for Each Shooting Mode” (p.220) for details.
- Pixel Track SR does not function when the flash discharges even if [Pixel Track SR] is set to (On).



Pixel Track SR may not be effective when the shutter speed is slow. We recommend you turn off the [Pixel Track SR] setting (off) and use a tripod for slow shutter speeds.

Setting Blink Detection

This specifies whether Blink Detection works when you use the Face Detection function. The default setting is (On).

1 Use the four-way controller (▲▼) to select [Blink Detection] on the [📷 Rec. Mode] menu.

2 Use the four-way controller (◀▶) to switch between (On) or (Off).

- (On) Blink Detection function works.
- (Off) Blink Detection function does not work.

The setting is saved.

Blink Detection  p.63



If the Blink Detection function detected closed eyes when shooting, [Closed eyes have been detected] is displayed for 3 seconds during Instant Review.

Setting the Instant Review

Use this setting to specify whether or not an Instant Review is displayed immediately after images are shot. The default setting is (On: displays the image).

1 Use the four-way controller (▲▼) to select [Instant Review] on the [📷 Rec. Mode] menu.

2 Use the four-way controller (◀▶) to switch between (On) or (Off).

- (On) Instant Review is displayed.
- (Off) Instant Review is not displayed.



The setting is saved.

Instant Review  p.63



Setting the Green Button

You can assign one of the following functions to the Green button: [Green Mode] (p.73), [Voice Recording] (p.168), [Movie] (p.113) or [Fn Setting] (p.106). You can activate the assigned function by just pressing the Green button.





When the shooting mode is set to  (Green) mode, [Green Button] settings cannot be configured on the [ Rec. Mode] menu. To configure the settings, first switch to a mode other than .

Assigning a Function

1 Use the four-way controller ( ) to select [Green Button] on the [ Rec. Mode] menu.

2 Press the four-way controller ().
A pull-down menu appears.

3 Use the four-way controller ( ) to select a function you want to assign.

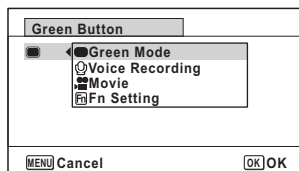



4 Press the OK button.
The setting is saved.



- [Green Mode] is registered as the default setting.
- If you select [Movie] for both [Fn Setting] and capture mode, the Green button does not function because the modes are the same.

Registering Frequently Used Functions (Fn Setting)

You can register frequently used functions on the four-way controller. Using this function, you can directly set the functions by pressing the four-way controller without displaying the menu in capture mode.

In [Fn Setting], Still Picture Capture Mode and  (Movie) mode have different settings. To execute [Fn Setting] in  mode, press the MENU button in  mode in step 1 on page p.105.

3 Use the four-way controller (▲▼) to select [Fn Setting].

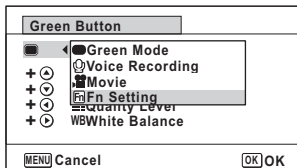

4 Press the OK button.

The [Fn Setting] screen appears.

5 Use the four-way controller (▲▼) to select a key you want to assign a function to.

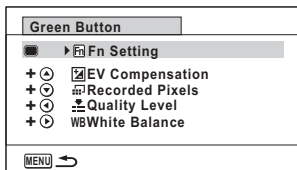

6 Press the four-way controller (▶).

A pull-down menu appears.

7 Use the four-way controller (▲▼) to select the function you want to register.

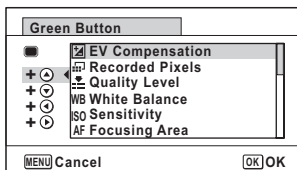

8 Press the OK button.

The setting is saved.



This function is activated only when you assign the [Fn Setting] to the Green button.



You can assign only one function to each key.

The default settings for Fn settings

	Still Picture Capture Mode	Movie mode
Default setting	(▲) EV Compensation	(▲) Movie SR
	(▼) Recorded Pixels	(▼) EV Compensation
	(◀) Quality Level	(◀) Recorded Pixels
	(▶) White Balance	(▶) White Balance

Functions that can be assigned to each key

	Still Picture Capture Mode	Movie mode
Selectable items	EV Compensation	Recorded Pixels
	Recorded Pixels	Movie SR
	Quality Level	White Balance
	White Balance	Focusing Area
	Sensitivity	EV Compensation
	Focusing Area	Sharpness
	Auto Macro	Saturation (Tone Adjustment) *
	AE Metering	Contrast
	Highlight Correction	
	Shadow Correction	
	Sharpness	
	Saturation (Tone Adjustment) *	
	Contrast	

* The items displayed change depending on the [Image Tone] selected on the [📷 Rec. Mode] menu. When you have selected either [Bright] or [Natural], [Saturation] is displayed, and when [Monochrome] is selected, [Tone Adjustment] is displayed.

Changing Assigned Items

Press the Green button in shooting mode to display the Fn Setting screen. Select an item with the four-way controller (▲▼◀▶), and press either the (▲▼) or (◀▶) four-way controller to change the settings.

Setting the Image Sharpness (Sharpness)

You can give the image sharp or soft outlines.

- 1 Use the four-way controller (▲▼) to select [Sharpness] on the [📷 Rec. Mode] menu.
- 2 Use the four-way controller (◀▶) to change the sharpness level.

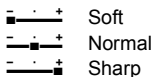

Setting the Saturation/Tone Adjustment

You can set either color brightness (Saturation) or the tone of monochrome images (Tone Adjustment).

The items displayed change depending on the [Image Tone] selected on the [📷 Rec. Mode] menu.

Selected Image Tone	Displayed item
Bright, Natural	Saturation
Monochrome	Tone Adjustment

- 1 Use the four-way controller (▲▼) to select [Saturation (Tone Adjustment)] on the [📷 Rec. Mode] menu.
- 2 Use the four-way controller (◀▶) to select the level of saturation (or Tone Adjustment).

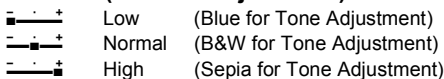

Setting the Image Contrast (Contrast)

For setting the image contrast level.

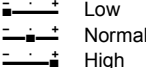
- 1 Use the four-way controller (▲▼) to select [Contrast] on the [📷 Rec. Mode] menu.
- 2 Use the four-way controller (◀▶) to change the contrast level.

 - Low
 - Normal
 - High

Setting the Date Imprint Function

You can choose whether to imprint the date and/or time when taking still pictures.

- 1 Use the four-way controller (▲▼) to select [Date Imprint] on the [📷 Rec. Mode] menu.
- 2 Press the four-way controller (▶).
A pull-down menu appears.
- 3 Use the four-way controller (▲▼) to select the Date Imprint details.
Choose from [Date], [Date & Time], [Time] or [Off].
- 4 Press the **OK** button.
The setting is saved.



- The date and/or time imprinted with the [Date Imprint] function cannot be deleted.
- Note that if the printer or the image editing software is set to print the date and the images to be printed already have the date and/or time imprinted, the imprinted dates and/or times may overlap.



- **DATE** appears on the display in 📷 mode when [Date Imprint] is set to any setting other than [Off].
- The date and/or time are imprinted on the picture with the display format set in the [Date Adjustment] screen (p.46).

Setting the IQ Enhancer Processing

You can take pictures with clearer details by using image processing with IQ enhancer technique.

1 Use the four-way controller (▲▼) to select [IQ Enhancer] on the [📷 Rec. Mode] menu.

2 Use the four-way controller (◀▶) to select (On)/ (Off).

- (On) IQ enhancer function works
 (Off) IQ enhancer function does not work

The setting is saved.



IQ enhancer does not function in the following situation:
When the drive mode is set to (Burst Shooting)

Setting the Macro Light

Set whether or not to turn on the LED Macro Lights around the lens.
The LED Macro Lights turn on when the [Macro Light] is set to (On).
The default setting is (Off).

1 Use the four-way controller (▲▼) to select [Macro Light] on the [📷 Rec. Mode] menu.

2 Use the four-way controller (◀▶) to select (On)/ (Off).

- (On) Turns on the LED Macro Lights
 (Off) Turns off the LED Macro Lights

The setting is saved.



- In (Digital Microscope) mode, the LED Macro Lights turn on regardless of whether the setting is turned on or off.
- If the Power Saving is set to on, the light turns off after the set time.
- The LED Macro Lights turn off during playback and when using the USB connector except when outputting video in mode.
- Self-portrait Assist and Self-portrait Assist + Smile Capture cannot be selected when [Macro Light] is set to (On).







If you take a picture using self-timer (,) or remote control (,) while [Macro Light] is set to (On), the LED Macro Lights remain on regardless of the countdown.

Taking Pictures Underwater



Taking Underwater Pictures (Underwater Mode/ Underwater Movie Mode)

This camera complies with JIS waterproof grade 8 and can be used to take pictures at a depth of 12 m continuously for 2 hours. In addition, this camera complies with JIS dustproof grade 6 (IP68).

	Use the Underwater mode to take underwater still pictures that capture the blueness of the sea.
	Use the Underwater Movie mode to record movies underwater.

1 Use the four-way controller (▲▼◀▶) to select  (Underwater)/  (Underwater Movie) from the Capture Mode Palette.

2 Press the OK button.
The shooting mode is selected and the camera returns to capture mode.

3 Press the shutter release button to take a picture.
If you selected , the picture is taken.
If you selected , recording starts. You can continue recording until the recorded movie time reaches 25 minutes. To stop recording, press the shutter release button fully. Perform the same steps as  (Movie) mode to record movies.

Recording Movies  p.113



- Before taking pictures underwater, make sure that there is no dirt or sand on the waterproof seal of the battery/card and terminal covers and check that the covers are securely locked.
- Before opening the battery/card and terminal covers after using the camera underwater, make sure that there is no water, dirt, or sand on the covers or anywhere else on the camera. Wipe the camera before opening the covers.
- When shooting in  (Underwater Movie) mode, use SD Speed Class 4 or higher cards.

Regarding Waterproof, Dustproof, and Shockproof Design  p.8



- When the Focus Mode is set to **MF**, you can adjust the focus before recording starts and during recording.
- Optical and digital zoom can be used in  mode before recording starts. Digital zoom can also be used during recording.

Although the camera is designed to be waterproof and dustproof, avoid using the camera under the following conditions. It may momentarily be subjected to water pressure beyond that covered in the guarantee and water may enter the interior of the camera.

- Jumping into the water while holding the camera
- Swimming while holding the camera in your hand
- Using the camera in environments where water is applied forcefully, such as strong river currents and waterfalls

Recording Movies

Recording Movies

This mode enables you to record movies. Sound is recorded at the same time.

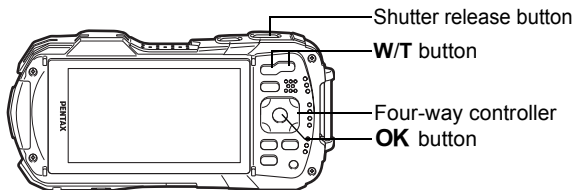

1 Use the four-way controller (▲▼◀▶) to select  (Movie) from the Capture Mode Palette.

2 Press the OK button.  (Movie) mode is selected and the camera returns to capture mode. The following information appears on the display.

- 1 Movie mode icon
- 2 Movie Shake Reduction icon
- 3 Remaining recordable time
- 4 REC indicator (blinks during recording)
- 5 Focus frame (does not appear during recording)

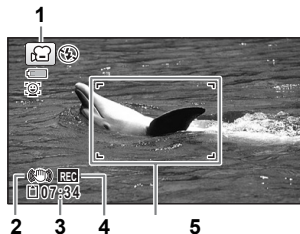

You can change the captured area by pressing the W/T button.

- T Enlarges the subject
- W Widens the area that is captured by the camera

3 Press the shutter release button fully.



Recording starts. You can continue recording until the recorded movie time reaches 25 minutes.

Press the shutter release button fully.

Recording stops.

Playing Back a Movie  p.123



- The focus mode can be changed before recording starts.
- When the focus mode is set to **MF** (Manual Focus), you can adjust the focus before recording starts.
- Optical and digital zoom can be used before recording starts. Digital zoom is available during recording when digital zoom (p.65) is set to  (On).
- When the shooting mode is set to  (Movie), Face Detection is automatically set to on. You can select Smile Capture or Face Detection Off by pressing the  button before starting recording a movie (p.69). When Smile Capture function is activated, movie recording starts automatically when the camera recognizes the subject's smile. However, depending on the condition of the recognized faces, movie recording may not start automatically because the Smile Capture function may not work. If this happens, press the shutter release button to start movie recording.
- You can record a movie using the remote control unit (optional) (p.83).
- When you change the display by pressing the **OK/DISPLAY** button while recording a movie, the histogram is not displayed.
- When you use the SD Memory Card, use SD Speed Class 4 or higher cards.

Keeping the Shutter Release Button Pressed

If you keep the shutter release button pressed for more than one second, recording will continue as long as you keep the button pressed. Shooting stops when you take your finger off the shutter release button.



Selecting the Number of Recorded Pixels and Frame Rate for Movies

You can choose the number of recorded pixels and frame rate settings for movies. The more pixels there are, the clearer the details and the bigger the file size. The more frames per second, the better the quality of the movie, but the file size becomes larger.

Setting	Recorded Pixels	Frame Rate	Use
1920p	1920x1080	30 fps	Records images in full HDTV format (16:9). Movement is recorded smoothly.
1280p	1280x720	60 fps	Records images in HDTV format (16:9). Quick movement is recorded smoothly.
1280p	1280x720	30 fps	Records images in HDTV format (16:9). Movement is recorded smoothly. (default setting)
640p	640x480	30 fps	Suitable for viewing on a TV or computer screen. Movement is recorded smoothly.

* The frame rate (fps) indicates the number of frames per second.

1 Use the four-way controller (▲▼) to select [Recorded Pixels] on the [Movie] menu.

Pressing the **MENU** button in  (Movie) or  (Underwater Movie) modes display the [Movie] menu.

2 Press the four-way controller (▶).

A pull-down menu appears.

3 Use the four-way controller (▲▼) to change the number of recorded pixels and frame rate.

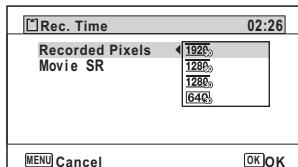

4 Press the OK button.



The setting is saved.





The following restrictions may cause the selected recordable time and the actual recordable time to be different.

- The maximum recordable time of a file is limited to 25 minutes.

Setting the Movie SR (Movie Shake Reduction) Function

In  (Movie)/ (Underwater Movie) modes, you can compensate for camera shake while you are recording a movie with the Movie SR (Movie Shake Reduction) function.

1 Use the four-way controller (▲▼) to select [Movie SR] on the [Movie] menu.

Pressing the **MENU** button in  (Movie) or  (Underwater Movie) modes display the [ Movie] menu.

2 Use the four-way controller (◀▶) to select (On) or (Off).

- (On) Automatically corrects for camera shake.
- (Off) No correction for camera shake.

The setting is saved.

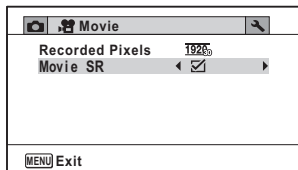

Recording a Movie from Pictures Taken at a Set Interval (Interval Movie)

In this mode, you can record multiple still pictures taken automatically at a set interval from a set time, as a movie file.

Interval	You can set this to 1 minute, 5 minutes, 10 minutes, 30 minutes, or 1 hour.
Total Time	Set the total time, from 10 minutes to 359 hours. The total time and the settable units change depending on the interval set. The Interval can be set in increments of 1 minute, 5 minutes, 10 minutes, 30 minutes, or 1 hour.
Start Delay	Set the start delay, from 0 minutes to 24 hours. You can set 1 minute increments for the first 59 minutes and 1 hour increments from there. If the start time is set to 0 minutes, the first picture is taken as soon as the shutter release button is pressed.

1 Use the four-way controller (▲▼◀▶) to select  (Interval Movie) from the Capture Mode Palette.

2 Press the OK button.

The current Interval Movie setting appears for approximately one minute. To take pictures with the current settings, go to step 10.

3 Press the OK button while the settings are displayed.

The Interval Movie setting screen appears. [Interval] is marked with the frame.

4 Set the interval.

1 Press the four-way controller (▶).

A pull-down menu appears.

2 Use the four-way controller (▲▼) to set the interval, then press the OK button.

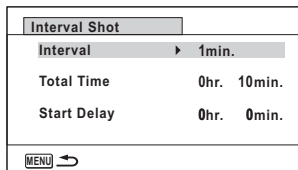

The frame returns to [Interval].

5 Press the four-way controller (▼).

The frame moves to [Total Time].

6 Set the total time.

1 Press the four-way controller (▶).

2 Use the four-way controller (▲▼) to set the hours, then press the four-way controller (▶).

3 Use the four-way controller (▲▼) to set the minutes, then press the four-way controller (▶).

The frame returns to [Total Time].

7 Press the four-way controller (▼).

The frame moves to [Start Delay].

8 Set the start delay.

1 Press the four-way controller (▶).

2 Use the four-way controller (▲▼) to set the hours, then press the four-way controller (▶).

3 Use the four-way controller (▲▼) to set the minutes, then press the four-way controller (▶).

The frame returns to [Start Delay].

9 Press the MENU button.

The Interval movie setting is saved and the camera returns to capture mode.

10 Press the shutter release button to take a picture.

Interval movie recording starts.

The LCD turns off between shots (during standby). Press the power switch during standby to display the remaining time and interval on the monitor.

The [Stop interval shooting?] message is displayed when the power switch and then the **MENU** button are pressed during standby. Pressing the **OK** button cancels interval movie.



- Confirm that the battery is sufficiently charged before starting interval movie recording. If the battery is not sufficiently charged, it may become depleted during interval movie recording and cause recording of the movie to stop.
- When performing interval movie recording, the settings are fixed as follows; Recorded Pixels: 1920, Frame Rate: 30fps, Quality Level: ★★★, Movie SR: (Off), and Flash Mode:
- Interval shot stops if the SD Memory Card is removed or inserted during standby.
- Sound cannot be recorded in mode.
- When you use the SD Memory Card, use SD Speed Class 4 or higher cards.



- If you set a start delay, a start time corresponding to the current time and the start delay you set is displayed in real time.
- The total time you can set differs according to the shooting interval you set, as indicated in the table below.

Interval	Total time that can be set
	30 fps
1 min	10 minutes to 5 hours and 59 minutes (in increments of 1 minute)
5 min	30 minutes to 29 hours and 55 minutes (in increments of 5 minutes)
10 min	1 hour to 59 hours and 50 minutes (in increments of 10 minutes)
30 min	3 hours to 179 hours and 30 minutes (in increments of 30 minutes)
1 hr	6 hours to 359 hours (in increments of 1 hour)

- The Date Imprint function (p.109) can be selected for Interval Movie mode.

Using the High Speed Movie Function

The camera records a high speed movie for slow motion playback.

1 Use the four-way controller (▲▼◀▶) to select  (High Speed Movie) from the Capture Mode Palette.

2 Press the OK button.
The camera returns to capture mode.



3 Press the shutter release button fully.
Recording starts. You can continue recording until the built-in memory or the SD Memory Card is full, or the recorded movie time reaches 15 seconds.

4 Press the shutter release button fully.









- The recorded pixels is fixed to 640 x 480.
- The flash does not discharge in this mode.
- The Face Detection function and the Movie SR are fixed to off.
- When you use the SD Memory Card, use SD Speed Class 4 or higher cards.

Saving the Settings (Memory)

The Memory function is for saving the current camera settings when the camera is turned off.

For some camera settings, the Memory function is always set to (On) (the settings are saved when the camera is turned off), while for others you can choose on or off (to choose whether the settings are saved or not when the camera is turned off). The items which can be set to or (Off) in the Memory function are shown in the table below. (Items not listed here are always saved in the selected settings when the camera is turned off.)

If you select , the settings will be saved in the status they were in immediately before the camera was turned off. If you select , the settings will be reset to the defaults when the camera is turned off. The table below also shows whether the Memory default setting for each item is or .

Item	Description	Default setting	Page
Face Detection	A Face Detection mode set by using the  button.	<input type="checkbox"/>	p.69
Flash Mode	The flash mode set with the four-way controller (◀)	<input checked="" type="checkbox"/>	p.90
Drive Mode	The drive mode set with the four-way controller (▲)	<input type="checkbox"/>	p.81 - p.84
Focus Mode	The focus mode set with the four-way controller (▶)	<input type="checkbox"/>	p.91
Zoom Position	The zoom position set with the W/T button.	<input type="checkbox"/>	p.63
MF Position	The manual focus position set with the four-way controller (▲▼)	<input type="checkbox"/>	p.92
White Balance	The [White Balance] setting on the  [Rec. Mode] menu	<input type="checkbox"/>	p.98
Sensitivity	The [Sensitivity] setting on the  [Rec. Mode] menu	<input type="checkbox"/>	p.100
EV Compensation	The [EV Compensation] setting on the  [Rec. Mode] menu	<input type="checkbox"/>	p.101
AE Metering	The [AE Metering] setting on the  [Rec. Mode] menu	<input type="checkbox"/>	p.99
Digital Zoom	The [Digital Zoom] setting on the  [Rec. Mode] menu	<input checked="" type="checkbox"/>	p.65
DISPLAY	The information display mode set with the OK/DISPLAY button	<input type="checkbox"/>	p.25
File No.	If a new SD Memory Card is inserted when set to <input checked="" type="checkbox"/> (On), file numbers are assigned sequentially.	<input checked="" type="checkbox"/>	—

1 Use the four-way controller (▲▼) to select [Memory] on the [📷 Rec. Mode] menu.

2 Press the four-way controller (▶).

The [Memory] screen appears.

3 Use the four-way controller (▲▼) to choose an item.

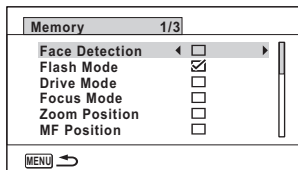

4 Use the four-way controller (◀▶) to select (On) or (Off).

Playing Back Images

Playing Back Still Pictures

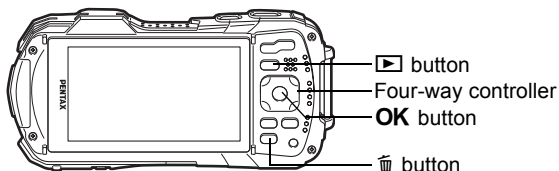

4

Playing Back and Deleting Images

1 Press the ▶ button after taking a picture.

The camera enters ▶ mode and the image appears on the display. Displaying one image in full in ▶ mode (▶ mode default setting) is called single-image display.

File number



To Play Back the Previous or Next Image

2 Press the four-way controller (◀▶).

The previous or next image appears.

To Delete the Displayed Image

Press the 🗑 button while the image is displayed to display the Delete screen. Press the four-way controller (▲) to select [Delete] and press the OK button.

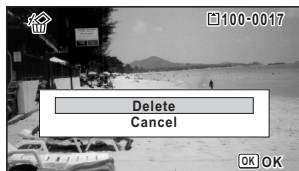

For information on other deletion procedures see p.135

Playing Back a Movie

You can play back the movies you have taken. The sound is played back at the same time.

1 Enter  mode and use the four-way controller (◀▶) to choose the movie you want to play back.

2 Press the four-way controller (▲).

Playback starts.



The following operations can be performed during playback.

Four-way controller (▲)	Pauses playback
Zoom button right (Q)	Increases the volume
Zoom button left (E)	Reduces the volume
Press and hold the four-way controller (▶)	Fast-forwards playback
Press and hold the four-way controller (◀)	Fast-reverses playback

The following operations can be performed while playback is paused.

Four-way controller (◀)	Reverses the frame(*)
Four-way controller (▶)	Forwards the frame
Four-way controller (▲)	Resumes playback

(*)Every 30 frame is the first frame for reversing frame. For example, when you reverse frame at 1 to 31, the frame reverses to the first frame and when you reverse frame at 32 to 61, the frame reverses to the 31st frame.

3 Press the four-way controller (▼).

Playback stops.



Only movies taken with this camera can be played back. Movies taken with other cameras cannot be played back.

Multi-Image Display









6-Image Display/12-Image Display

You can display 6 or 12 thumbnails of captured images at a time.

1 Press the button in mode.

The 6-image display appears showing a page consisting of 6 thumbnail images. Pressing the  button again changes it to a 12-image display.

A page consisting of 6 or 12 thumbnail images appears. The displayed images change 6- or 12-images at a time page by page.

Use the four-way controller () to move the frame. If there are too many images to fit on one page, pressing the four-way controller () while image ① is selected will display the previous page. Similarly, if you choose image ② and press the four-way controller () , the next page appears.

◆ indicates that the previous or next screen is stored in a separate folder.

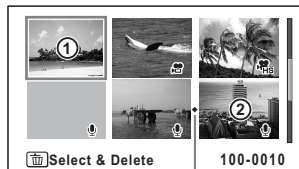

6-Image Display



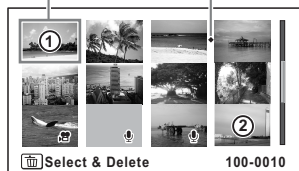

Folder divider icon



Frame



12-Image Display

The icons that appear on the images indicate the following:

(No icon)	Still picture without sound
 (With image)	Still picture with sound
	Movie (the first frame appears)
 (With image)	High Speed Movie (the first frame appears)
 (Without image)	Sound files only

Press the **OK** button to switch to single-image display of the selected image.
Press the  button to switch to  mode.

Folder Display/Calendar Display

Press the  button in 12-image display to switch to folder or calendar display.
Press the Green button to switch between folder display and calendar display.

1 Press the button twice in mode.





The screen changes to 12-image display.

2 Press the button.

The screen changes to folder display or calendar display.

Folder display

The list of folders with recorded images and sound files appears.

Use the four-way controller (   ) to move the frame.

If you select a folder and press the  button or the **OK** button, images in the folder are displayed in 12-image display.

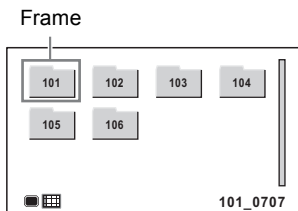

Calendar display

Recorded images and sound files are displayed by date in calendar format. The first image recorded on a date is displayed for that date on the calendar.



📍 appears for dates on which the first recorded file was either sound-only data or a still picture with a voice memo.

Use the four-way controller (▲▼◀▶) to move the frame.

If you select a date and press the 🔍 button, images taken on that date are displayed in 12-image display.

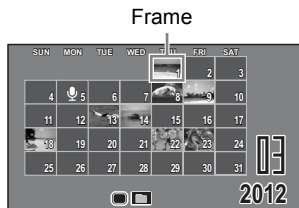
Select a date and press the **OK** button to switch to single-image display of the first image recorded on that date.



- Press the **MENU** button in folder display or calendar display to switch to 12-image display.
- Press the  button or half-press the shutter release button in folder display or calendar display to switch to  mode.

Using the Playback Function

1 In  mode, press the four-way controller (▼).

The Playback Mode Palette appears.

2 Use the four-way controller (▲▼◀▶) to choose an icon.

The guide for the selected function appears below.

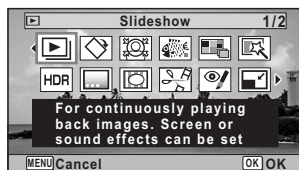

3 Press the **OK** button.

The playback function is recalled.

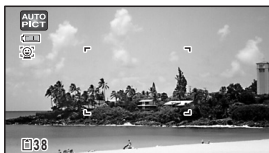
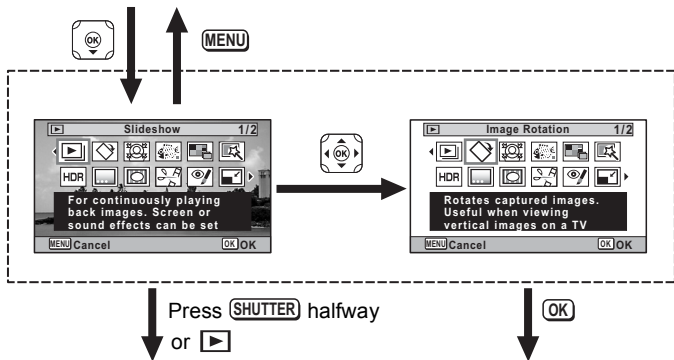

Closes the Playback Mode Palette and goes to mode.

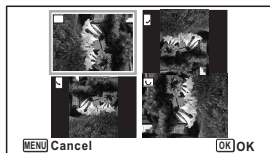



















Goes to the screen for selected playback function.





- When the frame is placed over an icon on the Playback Mode Palette, a guide for that function appears.
- You can turn the guide display off for the function on the Playback Mode Palette (p.191).





Playback Mode Palette

Playback Mode		Description	Page
	Slideshow	For continuously playing back images. Screen or sound effects can be set	p.129
	Image Rotation	Rotates captured images. Useful when viewing vertical images on a TV	p.131
	Small Face Filter	Reduces the size of faces in the image, for well-proportioned portraits	p.145
	Ink Rubbing Filter	Creates an image similar to ink rubbing from original pictures	p.148
	Collage	Creates a collage print page from saved image files	p.149
	Digital Filter	For modifying images with a Color filter or Soft filter	p.146
	HDR Filter	Processes single image to simulate HDR effect	p.148
	Original Frame	Available to make from the kind and color of a frame. Available to enter text	p.156
	Frame Composite	For composing an image with a frame. Select Overwrite or Save as to save	p.153
	Movie Editing	Save as Still image	p.160
		Divide Movies	
		Adding title picture	
	Red-eye Compensation	For compensating red-eye. May not work due to the condition of the image	p.152
	Resize	Changes Recorded Pixels and Quality Level to make the file size smaller	p.143
	Cropping	For cropping images to the size you like. Saved as a new image	p.144
	Image/Sound Copy	For copying images and sounds between the builtin memory and SD memory card	p.163
	Voice Memo	Attaches sound to images. Recording is possible till the memory card is full	p.171
	Protect	Protects images and sounds from accidental deletion. Formatting will delete	p.138
	DPOF	For the print settings. Useful when printing at a printing service	p.165
	Start-up Screen	For setting a captured image as the Start-up Screen	p.193

Slideshow

You can play back recorded still pictures and movies one after another.

1 Enter  mode and use the four-way controller ( ) to choose the image to start the slideshow with.

2 Use the four-way controller (   ) to select  (Slideshow) from the Playback Mode Palette.

3 Press the OK button.
The slideshow setting screen appears.

4 Use the four-way controller ( ) to select [Start].

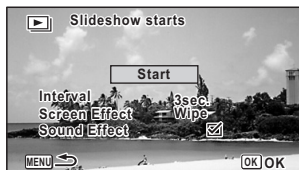



5 Press the OK button.
The slideshow starts.

Pressing the OK button during the slideshow pauses the slideshow. To resume the slideshow, press the OK button again.

6 Press any button other than the OK button.
The slideshow stops.

To Set the Slideshow Conditions

You can set the playback interval and also a screen effect and sound effect for when one image changes to the next.

1 Use the four-way controller ( ) to select [Interval] in step 4 on p.129.

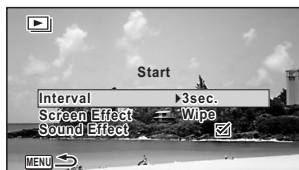

2 Press the four-way controller ().
A pull-down menu appears.

3 Use the four-way controller (▲▼) to change the interval and press the OK button.

Choose from [3sec.], [5sec.], [10sec.], [20sec.] or [30sec.].

4 Use the four-way controller (▲▼) to select [Screen Effect].

After selecting [Screen Effect], press the four-way controller (▶). A pull-down menu appears with the following items. Use the four-way controller (▲▼) to select an item and press the **OK** button.

Wipe	The next image slides over the previous one from left to right
Checker	The next image appears in small square mosaic blocks
Fade	The current image gradually fades out and the next image fades in
Random	Various effects are used randomly
Off	No effect

5 Use the four-way controller (▲▼) to select [Sound Effect].**6 Use the four-way controller (◀▶) to select (On) or (Off).**

Except when the [Screen Effect] is set to [Off], you can choose (On) or (Off) for the sound that is played when one image changes to the next.











7 Use the four-way controller (▲▼) to select [Start].**8 Press the OK button.**

The slideshow starts using the selected interval and effect.





- The slideshow will continue until you press any button other than the **OK** button.
- Movies or pictures with sound will be played through to the end before the next picture is played back, regardless of the interval setting. However, pressing the four-way controller (▶) while playing back a movie or a picture with sound skips to the next image.
- Sound files made in (Voice Recording) are not played back in the slideshow.
- Images taken at (Digital Panorama) are displayed by scrolling from left to right in 4 seconds before the next picture is played back, regardless of the Interval or Screen Effect setting.
- When [Random] is selected for the screen effect, the interval is fixed and the sound effect is set to off. Also the sound of pictures with sound will not be played back.

Rotating the Image

- 1 Press the  button after taking a picture.**
The image appears on the display.
- 2 Use the four-way controller (   ) to select  (Image Rotation) from the Playback Mode Palette.**
- 3 Press the OK button.**
The rotation selection screen (0°, Right 90°, Left 90°, or 180°) appears.
- 4 Use the four-way controller (   ) to choose the rotation direction and press the OK button.**

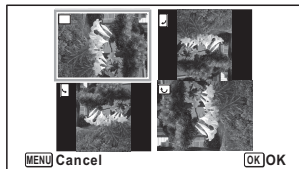

The rotated image is saved.



- Images taken at  (Digital Panorama) and movies cannot be rotated.
- Protected images can be rotated, but they cannot be saved in a rotated state.

Zoom Playback

You can magnify an image up to ten times.

1 Enter  mode and use the four-way controller ( ) to choose the image you want to magnify.

2 Press the  button.

The image is magnified ($\times 1.1$ to $\times 10$). Holding down the  button continuously magnifies the image.







With [Quick Zoom] (p.191) set to (On), pressing  button once magnifies the image to $10\times$.

You can use the + mark of the guide at the bottom left of the screen to check which portion of the image is magnified.



Guide

The following operations can be performed while an image is magnified.

Four-way controller (   )	Moves the position to be magnified
Zoom button right ()	Makes the image bigger (max. of $10\times$)
Zoom button left ()	Makes the image smaller (min. of $1.1\times$)

3 Press the **OK** button.





The image returns to single-image display.



Movies cannot be magnified.

Zoom In on the Subject's Face Automatically (Face Close-up Playback)

You can enjoy playing back images with the subject's faces zoomed up simply by pressing the  button (Face close-up playback) if the Face Detection function activated when the images were taken.

- 1** Enter  mode and use the four-way controller ( ) to choose the image you want to magnify.
- 2** Confirm that the  icon is displayed in the image and press the  button.

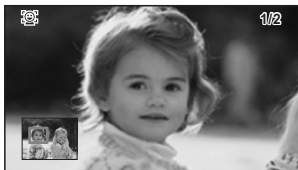

The image is magnified around the face first recognized when the image was taken.



If multiple faces were recognized when the image was taken, the subject's faces are zoomed up on each time the  button is pressed in order of the recognition during shooting.



The following operations can be performed during Face close-up playback mode.

Zoom button right ()	Zooms up on the subject being displayed for Face close-up playback at an equal or slightly larger magnification ratio.
Zoom button left ()	Zooms up on the subject being displayed for Face close-up playback at an equal or slightly smaller magnification ratio.

- 3** Press the OK button.

The image returns to single-image display.



- Face close-up playback is not available for movies or images that are saved as still pictures from the movies.
- The magnification ratio for Face close-up playback may differ depending on the conditions such as the size of the face recognized when shooting.
- Face close-up playback is also available for pet's faces taken at  (Pet) mode.

Deleting Images and Sound Files

Delete images and sound files that you do not want to keep.

Deleting a Single Image/Sound File

You can delete a single image or sound file.

If sound (voice memo) has been recorded with an image (p.171), you can delete the sound without deleting the image.



Protected images and sound files cannot be deleted (p.138).

1 Enter mode and use the four-way controller (◀▶) to choose the image/sound file you want to delete.

appears on the images with sound.

2 Press the button.

A confirmation screen appears.

3 Use the four-way controller (▲) to select [Delete].

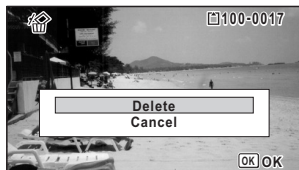

Select [Delete Sound] to delete sound without deleting the image.

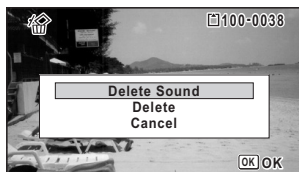

4 Press the OK button.

The image is deleted.



You cannot delete only the sound in a movie.

Deleting Selected Images and Sound Files

You can delete several images/sound files selected from the 6- or 12-image display at once.

Caution

Protected images and sound files cannot be deleted (p.138).

1 Press the button once or twice in mode.

6-image display or 12-image display appears.

2 Press the button.

 appears on the images and sound files.

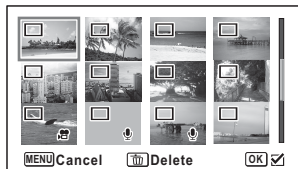

3 Use the four-way controller (, , ,) to choose the images and sound files that you want to delete and press the OK button.

 appears on the selected images and sound files.

Pressing and holding the  button displays the selected image in single-image display and you can check whether to delete the image. Releasing the button returns to 6- or 12-image display. However, protected images cannot be displayed in single-image display.

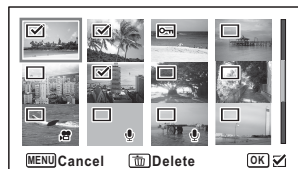

4 Press the button.

A confirmation screen appears.

5 Use the four-way controller () to select [Select & Delete].

6 Press the OK button.

The selected images and sound files are deleted.

Deleting All Images and Sound Files

Deletes all the images and sound files at once.



Protected images and sound files cannot be deleted (p.138).

1 Press the **MENU** button in mode.

The [Setting] menu appears.

When you press the **MENU** button in mode, press the four-way controller () once.

2 Use the four-way controller () to select [Delete All].

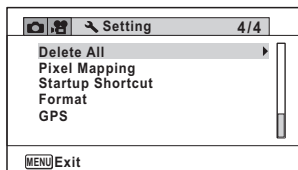

3 Press the four-way controller () to confirm.

A confirmation dialog appears.



4 Use the four-way controller () to select [Delete All].

5 Press the **OK** button.

All the images and sound files are deleted.

Protecting Images and Sound Files from Deletion (Protect)

You can protect stored images and sound files from being accidentally deleted.

- 1** Enter  mode and use the four-way controller (◀▶) to choose the image you want to protect.
- 2** Use the four-way controller (▲▼◀▶) to select  (Protect) from the Playback Mode Palette.
- 3** Press the OK button.
The screen for selecting [Single Image/Sound] or [All Images/Sounds] appears.

4

- 4** Use the four-way controller (▲) to select [Single Image/Sound].



- 5** Press the OK button.
The message [Protects this image/sound] appears.

To protect another image or sound file, use the four-way controller (◀▶) to select another image or sound file.

- 6** Use the four-way controller (▲) to select [Protect].



- 7** Press the OK button.
The selected image or sound file is protected.
To protect other images or sound files, repeat Steps 4 to 7.
Select [Cancel] to exit the Protect settings.



- To cancel the Protect setting, select [Unprotect] in step 6.
-  appears on the protected images and sound files during playback.

To Protect All Images and Sound Files

- 1** Select [All Images/Sounds] in step 4 on p.138.



- 2** Press the OK button.

- 3** Use the four-way controller (▲) to select [Protect].



- 4** Press the OK button.

All the images and sound files are protected and the screen shown in Step 1 reappears.

- 5** Use the four-way controller (▲▼) to select [Cancel] and press the OK button.

The Playback Mode Palette reappears.



Protected images and sound files are deleted when the SD Memory Card or the built-in memory is formatted (p.174).



To cancel the Protect setting on all your images and sound files, select [Unprotect] in step 3.

Connecting the Camera to AV Equipment

You can connect the camera to a TV or other device with a video input terminal or HDMI terminal and playback images.



- The power lamp on the camera lights up during a connection.
- If you intend to use the camera continuously for a long period, use of the AC adapter kit K-AC117 (optional) is recommended. (p.37)
- For AV device with multiple video input terminals, check the operating manual of the AV device, and select the video input terminal to which the camera is connected.
- You cannot output composite and HDMI video at the same time.
- The camera display turns off while the camera is connected to AV equipment.
- You cannot adjust the volume on the camera when connected to an AV device. Adjust the volume on the AV device.
- When the camera is connected to an AV device, you can change the images with the remote control (optional).

4

Playing Back and Deleting Images

Connecting the Camera to a Video Input Terminal

By using the optional AV cable (I-AVC7), you can capture and play back images on device with a video input terminal, such as a TV.

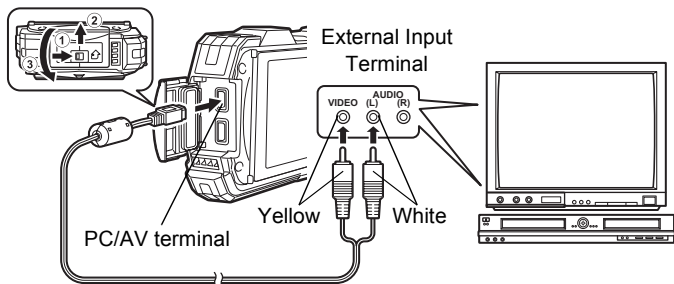

1 Turn the AV device and camera off.

2 Open the terminal cover.

Move the terminal cover lock lever in the direction shown by ①, slide the cover in the direction shown by ② and open the cover in the direction shown by ③.

3 Connect the AV cable to the PC/AV terminal.

4 Connect the other ends of the AV cable (yellow: video, white: audio) to the video input terminal and audio input terminal of the AV device.

When using stereo sound device, insert the sound terminal into the L (white) terminal.

5 Turn the AV device on.

When the device that the camera is connected to and the device that plays back images are different, turn both devices on.

When viewing images on AV device with multiple video input terminals (such as a TV), refer to the operating manual of the device and select the video input terminal to which to connect the camera.

6 Turn the camera on.



- Depending on the country or region, images and sound files may fail to be played back if the video output format is set different from the one in use there. If this happens, change the video output format setting (p.187).
- The camera's AV output is output at normal resolution.
To watch movies shot at 1920i, 1280i, or 1280i at HDTV resolution, output the movies as HDMI or transfer them to a computer (p.142).



Close the terminal cover securely when not using the terminal.

<How to close the terminal cover>

Close the cover in the opposite direction indicated by ③. While lightly pressing on the terminal cover, slide it away from ② until it clicks.

Connecting the Camera to an HDMI Terminal

Use a commercially available HDMI cable to connect the camera to a device with an HDMI terminal.

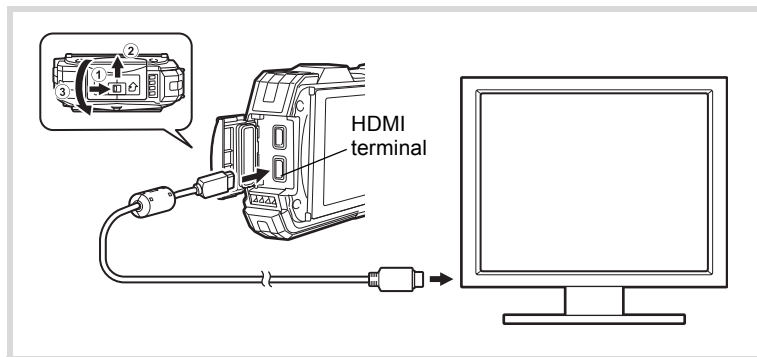

4

Playing Back and Deleting Images

1 Turn the AV device and camera off.

2 Open the terminal cover.

Move the terminal cover lock lever in the direction shown by ①, slide the cover in the direction shown by ② and open the cover in the direction shown by ③.

3 Connect the HDMI cable to the HDMI terminal.

4 Connect the other end of the HDMI cable to the HDMI terminal on the AV device.

5 Turn the AV device and camera on.

The camera information is displayed on the screen of the connected AV device.



- The camera has a Type D (Micro) HDMI terminal. Use a commercially available HDMI cable that matches your AV device.
- If you play back movies by connecting the camera to an AV device with a commercially available HDMI cable, set the output format to "Selecting the HDMI Output Format" (p.188).



Close the terminal cover securely when not using the terminal.

<How to close the terminal cover>

Close the cover in the opposite direction indicated by ③. While lightly pressing on the terminal cover, slide it away from ② until it clicks.

Changing the Image Size (Resize)

By changing the recorded pixels and quality level of a selected image, you can make the file size smaller than the original. You can use this function to continue taking pictures when the SD Memory Card or the built-in memory is full, by making the images smaller and overwriting the original images to make more space available.



- Images taken with the recorded pixels of 12M or taken at (Digital Panorama) and movies cannot be resized.
- You cannot select a larger resolution and higher quality level than that of the original image.

1 Enter mode and use the four-way controller () to choose the image you want to resize.

2 Use the four-way controller () to select (Resize) from the Playback Mode Palette.

3 Press the OK button.

The screen for choosing the recorded pixels appears.

4 Select [Recorded Pixels] and [Quality Level].

Use the four-way controller () to choose the recorded pixels and quality level.

Use the four-way controller () to switch between [Recorded Pixels] and [Quality Level].



5 Press the OK button.

A confirmation dialog for overwriting the image appears.

If the selected image is protected, the processed image is saved as a new image and the following confirmation does not appear.

6 Use the four-way controller () to select [Overwrite] or [Save as].

7 Press the OK button.

The resized image is saved.

Cropping Images

You can delete the unwanted part of a picture and save the cropped image as a separate image.



Images taken with the recorded pixels of 12M [12M] or taken at [DP] (Digital Panorama) and movies cannot be cropped.

- 1** Enter [] mode and use the four-way controller (◀▶) to choose the image you want to crop.
- 2** Use the four-way controller (▲▼◀▶) to select [] (Cropping) from the Playback Mode Palette.
- 3** Press the OK button.

The cropping screen appears.

The largest size of cropped image is shown with a green frame on the screen. The cropped image cannot be larger than this cropping frame size.

- 4** Choose the cropping area.

The following operations move the green frame and set the area for cropping on the screen.

Zoom button ([Z]/[Q])	Changes the size of the cropped frame
Four-way controller (▲▼◀▶)	Moves the cropping frame up, down, left and right
Green Button	Rotates the cropping frame. <ul style="list-style-type: none">• The button is displayed only when the cropping frame can be rotated.

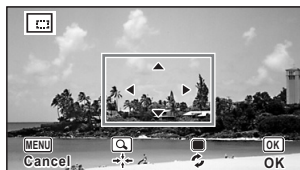















- 5** Press the OK button.



The cropped image is saved with a new file name.



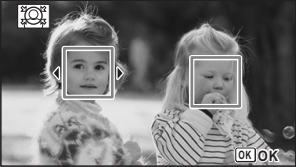

The number of recorded pixels is selected automatically according to the size of the cropped image. The image is saved at the same quality level as the original.

Processing Images to Make Faces Look Smaller

Images are processed to reduce the size of people's faces detected with the Face Detection function (p.69) when taking pictures so that they look smaller.

- 1** Enter  mode and use the four-way controller ( ) to choose the image you want to edit.
- 2** Use the four-way controller (   ) to select  (Small Face Filter) from the Playback Mode Palette.
- 3** Press the OK button.
Face detection frames for faces that can be processed are displayed.
Proceed to Step 6 when there is only one detection frame.
- 4** Use the four-way controller (   ) to select a face to be processed.
A green frame indicates the face that is to be processed.

- 5** Press the OK button.
- 6** Use the four-way controller ( ) to change the reduction ratio.

	Approx. 5%
	Approx. 7%
	Approx. 10%

- 7** Press the OK button.
A confirmation dialog for overwriting the image appears.
If the selected image is protected, the processed image is saved as a new image and the following confirmation dialog does not appear.
- 8** Use the four-way controller ( ) to select [Overwrite] or [Save as].
- 9** Press the OK button.
The camera returns to  mode and the processed image is displayed.



You may not be able to process images in the following situations:

- When the size of face taken in relation to an image is too large or too small
- When faces are located in the edges of an image

In such cases, the face detection frame in Step 3 will not appear.

Using the Digital Filters

This mode lets you change the color tones and perform special processing on a selected image.

B&W/Sepia	Changes color images to black and white or processes using the sepia filter.
Toy Camera	Images seem to have been taken with a toy camera.
Retro	Images have the feel of old photos with a white border. You can choose from three filters: Original image, amber, and blue.
Color	Processes the image using the selected color filter. You can choose from six filters: red, pink, purple, blue, green, and yellow.
Extract Color	Processes the image using the selected color extraction filter. You can choose from three filters: red, green, and blue.
Color Emphasis	There are 4 filters: Sky Blue/Fresh Green/Delicate Pink/Autumn Leaves.
High Contrast	Adjusts the contrast of the captured images.
Starburst	Processes the image with a special sparkling look achieved by adding cross-like effects to a highlighted area, such as town lights at night, light reflected from water, or other light sources. You can choose from three filters: Cross, Heart, and Star.
Soft	Processes the image into a soft image that appears soft overall.
Fish-eye	Applies a fish-eye lens effect to images.
Brightness	Adjusts the brightness of the image.
Miniature	Blurs part of the image to create a fake miniature scene.



Images taken at (Digital Panorama), movies or images taken with another camera cannot be edited using Digital Filter function. An error message appears if you choose this function from the Playback Mode Palette and press the **OK** button.

1 Enter mode and use the four-way controller () to choose the image you want to edit.

2 Use the four-way controller () to select (Digital Filter) from the Playback Mode Palette.

3**Press the OK button.**

The digital filter selection screen appears.

- 1 B&W/Sepia
- 2 Toy Camera
- 3 Retro
- 4 Color
- 5 Extract Color
- 6 Color Emphasis
- 7 High Contrast
- 8 Starburst
- 9 Soft
- 10 Fish-eye
- 11 Brightness
- 12 Miniature

**4****Use the four-way controller (▲▼) to choose the digital filter you want to use.**

The preview image of the results of the filter effect appears.

5**Use the four-way controller (◀▶) to adjust the effect as necessary.**

	Four-way controller (◀)	Default Setting	Four-way controller (▶)
Retro	Blue	Original image	Amber
Toy Camera	Weak	Standard	Strong
High Contrast	Weak	Standard	Strong
Fish-eye	Weak	Standard	Strong
Brightness	Dark	Standard	Bright
Miniature	Upper	Upper and lower	Lower

B&W/Sepia	B&W ↔ Sepia
Color	Red ↔ Pink ↔ Purple ↔ Blue ↔ Green ↔ Yellow
Extract Color	Red ↔ Green ↔ Blue
Color Emphasis	Sky Blue ↔ Fresh Green ↔ Delicate Pink ↔ Autumn Leaves
Starburst	Cross ↔ Heart ↔ Star

6**Press the OK button.**

A confirmation dialog for overwriting the image appears.

If the selected image is protected, the processed image is saved as a new image and the following confirmation does not appear.

5

7 Use the four-way controller (▲▼) to select [Overwrite] or [Save as].

8 Press the OK button.
The images processed with the filter are saved.

Using the HDR Filter

Adjusts parts of the image that are too bright or too dark and processes images to simulate an HDR effect.

1 Enter  mode and use the four-way controller (◀▶) to choose the image you want to edit.

2 Use the four-way controller (▲▼◀▶) to select HDR (HDR Filter) from the Playback Mode Palette.

3 Press the OK button.
The preview image of the results of the filter effect appears.

4 Press the OK button.
A confirmation dialog for overwriting the image appears.
If the selected image is protected, the processed image is saved as a new image and the following confirmation does not appear.

5 Use the four-way controller (▲▼) to select [Overwrite] or [Save as].





6 Press the OK button.
The images processed with the filter are saved.

Using the Ink Rubbing Filter

You can edit the image to look like an ink rubbing.



The Ink Rubbing Filter cannot be used on the following images.

- Movies or images taken at  (Digital Panorama) or  (Report) modes
- Images taken with the recorded pixels of 12M , 3M, 2M , 1024, or 640
- Images taken with other cameras

An error message appears in step 3.

1 Enter  mode and use the four-way controller (▲▼◀▶) to choose the image you want to edit.



2 Use the four-way controller (▲▼◀▶) to select  (Ink Rubbing Filter) from the Playback Mode Palette.

3 Press the OK button.

The preview image of the results of the filter effect appears.

4 Use the four-way controller (◀▶) to choose the effect.

You can adjust the effect in five levels.

- | | |
|---|----------|
|  | Weak |
|  | Standard |
|  | Strong |

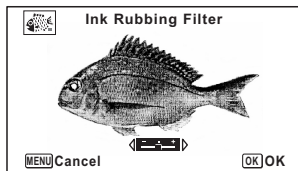

5 Press the OK button.

A confirmation dialog for overwriting the image appears.

If the selected image is protected, the processed image is saved as a new image and the following confirmation does not appear.

6 Use the four-way controller (▲▼) to select [Overwrite] or [Save as].

7 Press the OK button.

The images processed with the filter are saved.





- The processed image is saved with the recorded pixels of 5M / 4M.16:9.
- When there is little contrast between the object and the background, the shape of the object may not be sharp depending on the conditions of the original image.

Creating a Collage Image

Make a collage image by placing captured images on a selected pattern.



The collage function cannot be used on the following images.

- Movies or images taken at  (Digital Panorama) or  (Report) modes
- Images taken with the recorded pixels of 12M 181, 1024, or 640
- Images taken with other cameras

1 Use the four-way controller (▲▼◀▶) to select  (Collage) from the Playback Mode Palette.

2

Press the OK button.

The item selection screen appears.

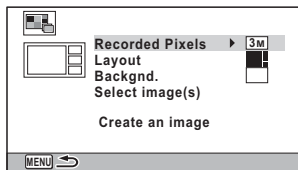

Selecting the Number of Recorded Pixels

3

Use the four-way controller (▲▼) to choose the [Recorded Pixels].

4

Press the four-way controller (▶).

A pull-down menu appears.

5

Use the four-way controller (▲▼) to choose the recorded pixels.

You can choose from 3M or 2M. 1080.

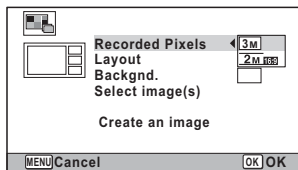

6

Press the OK button.

Returns to the item selection screen.

Selecting the Layout Pattern

7

Use the four-way controller (▲▼) to choose the [Layout].

8

Press the four-way controller (▶).

A pull-down menu appears.

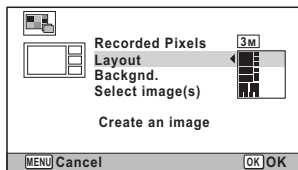

9

Use the four-way controller (▲▼) to choose the pattern of layout.

You can choose from 3 patterns of layout (■/■/■).

10

Press the OK button.

Returns to the item selection screen.

Selecting the Background

11 Use the four-way controller (▲▼) to choose [Backgnd.].

12 Press the four-way controller (▶).

A pull-down menu appears.

13 Use the four-way controller (▲▼) to choose the background.

You can choose the white background or the black background.

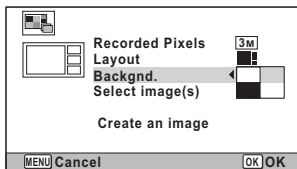

14 Press the OK button.

Returns to the item selection screen.

Laying Out the Image



- The collage function cannot be used on the following images.
 - Movies or images taken at ■■■ (Digital Panorama) or 📄 (Report) modes
 - Images taken with the recorded pixels of 12M 181, 1024, or 640
 - Images taken with other cameras
 These images do not appear as selectable items.
- If you select an image with a 16:9 aspect ratio, the black areas appear above and below the image.

15 Use the four-way controller (▲▼) to choose [Select image(s)].

16 Press the four-way controller (▶).

The images to be selected appear.

17 Use the four-way controller (◀▶) to choose the image to be placed and press the OK button.

The selected image is placed in the highlighted area in the guide. The guide appears on the top left of the monitor.

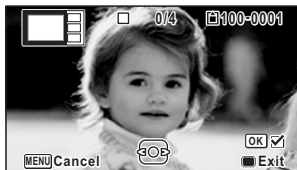

18 Repeat step 17 to lay out the rest images.

- 19** Press the **●** button.
Returns to the item selection screen.

Saving the Edited Image

- 20** Use the four-way controller (**▲▼**) to select **[Create an image]**.

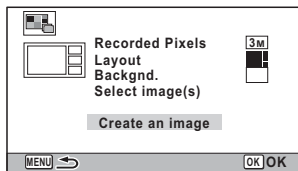

- 21** Press the **OK** button.
A confirmation dialog for saving the image appears.

- 22** Use the four-way controller (**▲**) to select **[Save]**.

- 23** Press the **OK** button.
The edited image is saved.



The quality level of the image is fixed at ★★★ (Best).

Red-eye Compensation

You can correct images where the flash has caused the subject to appear with red eyes.



- The red-eye compensation function cannot be used on images taken at **■■■** (Digital Panorama), movies or on images where red eyes cannot be detected on the camera. An error message appears in step 3.
- The red-eye compensation function can only be used with still pictures taken with this camera.

- 1** Enter **▶** mode and use the four-way controller (**◀▶**) to choose the image you want to edit.

- 2** Use the four-way controller (**▲▼◀▶**) to select **👁** (Red-eye Compensation) from the Playback Mode Palette.

- 3** Press the **OK** button.

A confirmation dialog for overwriting the image appears.
If the selected image is protected, the processed image is saved as a new image and the following confirmation does not appear.

4 Use the four-way controller (▲▼) to select [Overwrite] or [Save as].

5 Press the OK button.
The edited image is saved.

Adding a Frame (Frame Composite)

This function lets you add a decorative frame to still pictures. There are 6 frames already stored in the camera. You can copy the optional frames from the CD-ROM supplied with the camera.



(Frame Composite) cannot be used on the following images.

- Movies or images taken at (Digital Panorama) or (Report) modes
- Images taken with the recorded pixels of 12M , 1024, or 640

An error message appears in step 3.

1 Enter mode and use the four-way controller (◀▶) to choose the image to which you want to add a frame.

2 Use the four-way controller (▲▼◀▶) to select (Frame Composite) from the Playback Mode Palette.

3 Press the OK button.
The 12-frame display of the frame selection screen appears.

4 Use the four-way controller (▲▼◀▶) to choose a frame.



5 Press the Q button.

The selected frame appears in single-image display.

You can choose another frame using either of the following operations.

Four-way controller (◀▶)	Press to choose a different frame.
Zoom button left (⊞)	Press to return to the 12-frame display of the frame selection screen, and then perform step 5 to choose a different frame.

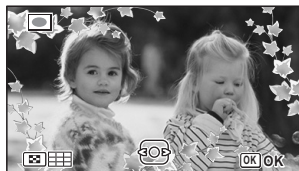
**6 Press the OK button.**

The image position and size adjustment screen appears.

You can adjust the image using either of the following operations.

Four-way controller (▲▼◀▶)	Press to adjust the position of the image
Zoom button (⊞/Q)	Press to make the image larger or smaller.

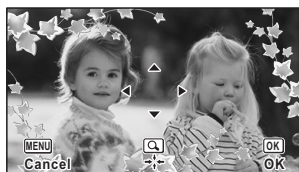
**7 Press the OK button.**

A confirmation dialog for overwriting the image appears.

If the selected image is protected, the processed image is saved as a new image and the following confirmation does not appear.

8 Use the four-way controller (▲▼) to select [Overwrite] or [Save as].**9 Press the OK button.**

The edited image is saved with the recorded pixels of **3M / 2M**.

Optional Frames

The optional frames are stored in the CD-ROM supplied with the camera. To use these frames, copy them from the CD-ROM. These optional frames are deleted if the files on the built-in memory are deleted with a computer or if the built-in memory is formatted.

To Copy Frames

- 1 Remove the SD Memory Card from the camera.**
If you leave the SD Memory Card in the camera, the frames will be copied onto the card, not into the camera's built-in memory.
- 2 Connect the camera to the computer using the provided USB cable.**
Refer to "Connecting to a Computer" (p.197) for instructions on connecting the camera to a computer.
- 3 When the device detection window opens, click [Cancel].**
- 4 Insert the CD-ROM into the CD-ROM/DVD drive.**
- 5 When the installer window opens, click [EXIT].**
- 6 If there is not already a "FRAME" folder in the root directory of the camera (Removable Disk), create the folder.**
- 7 Copy the desired files from the FRAME folder in the root directory of the CD-ROM to the FRAME folder on the camera (Removable Disk).**
For information on working with files on your computer, refer to the instruction manual supplied with the computer.
- 8 Disconnect the USB cable from the computer and camera.**
Refer to "Connecting to a Computer" (p.197) for instructions on disconnecting the camera from a computer.

- Frames can be stored both in the built-in memory and on the SD Memory Cards, but using large numbers of frames may slow down processing times.

To Use a New Frame

The frames downloaded from the PENTAX website or other source can be used for adding a frame to pictures.



- Extract the downloaded frame and copy it to the FRAME folder in the built-in memory or the SD Memory Card.
- The FRAME folder is created when the SD Memory Card is formatted with this camera.
- For more information on downloading, refer to the PENTAX website.

Overlaying Your Original Frame on Still Pictures

You can overlay your original frame (decorative frame) on still pictures. You can select the type and color of an original frame and its position. Text can also be entered.

5

Frame



Type of original frame	Blur/Edge Composite
Frame Type	<input type="checkbox"/> (All sides)/ <input type="checkbox"/> (Upper and lower sides)/ <input type="checkbox"/> (Right and left sides)/ <input type="checkbox"/> (Upper side)/ <input type="checkbox"/> (Lower side)/ <input type="checkbox"/> (Left side)/ <input type="checkbox"/> (Right side)
Color	White/Gray/Black/Pink/Pumpkin/Dark red/Dark green

Text Stamp

Available characters	A – Z, a – z, 0 – 9, Symbols
Display Position	<input type="checkbox"/> (Upper-left)/ <input type="checkbox"/> (Upper-center)/ <input type="checkbox"/> (Upper-right)/ <input type="checkbox"/> (Lower-left)/ <input type="checkbox"/> (Lower-center)/ <input type="checkbox"/> (Lower-right)
Color	White/Gray/Black/Pink/Pumpkin/Dark red/Dark green



The Original Frame function cannot be used on images taken at (Digital Panorama) or (Report) modes, images taken with the recorded pixels of 12M / 3M / 2M / 1024 / 640 or movies. An error message appears in Step 3.

- 1** Enter  mode and use the four-way controller (◀▶) to choose the image to which you want to add a frame.
- 2** Use the four-way controller (▲▼◀▶) to select  (Original Frame) from the Playback Mode Palette.

- 3** Press the OK button.
The original frame type selecting screen appears.

- 4** Use the four-way controller (▲▼) to select an original frame type, and press the OK button.
The frame setting screen appears.

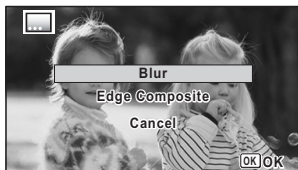

- 5** Use the four-way controller (▲▼) to select [Frame Type], and press the four-way controller (▶).



- 6** Use the four-way controller (▲▼) to select a frame type, and press the four-way controller (◀).

- 7** Set [Color] in the same way as in Steps 5 and 6.

- 8** Adjust the position of the frame and image.
For details, refer to “To Adjust the Position of the Frame and an Image” (p.158).

- 9** Use the four-way controller (▲▼) to select [Text Stamp], and press the four-way controller (▶).
The Text Stamp screen appears.
When you do not want to enter characters, proceed to Step 11.

- 10** Set up the text stamp.
For details, refer to “To Set Up Text Stamp” (p.159).

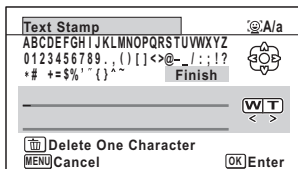

11 Press the OK button.

A confirmation dialog for overwriting the image appears.

If the selected image is protected, the processed image is saved as a new image and the following confirmation dialog does not appear.

12 Use the four-way controller (▲▼) to select [Overwrite] or [Save as].

13 Press the OK button.

The edited image is saved with the recorded pixels of **5M** / **4M** 16:9.

To Adjust the Position of the Frame and an Image

1 Press the Green button.

The frame position adjustment screen appears.

Four-way controller (▲▼◀▶)	Press to adjust the position of the frame
Zoom button right (Q)	Press to make the frame larger
Zoom button left (Q)	Press to make the frame smaller



2 Press the Green button.

The image position adjustment screen appears.

Four-way controller (▲▼◀▶)	Press to adjust the position of the image
Zoom button right (Q)	Press to make the image larger
Zoom button left (Q)	Press to make the image smaller

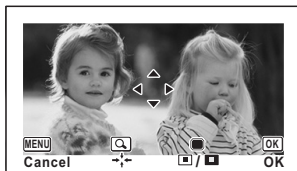

3 Press the OK button.

The screen returns to the original screen.

To Set Up Text Stamp

- 1 Use the four-way controller (▲▼◀▶) to select a character and press the OK button.**

The selected character is input.
Up to 52 characters can be input.

 button	Press to switch between upper and lower case
Zoom button right (Q)	Press to move the cursor to the right
Zoom button left (Z)	Press to move the cursor to the left
Green button	Press to delete the character

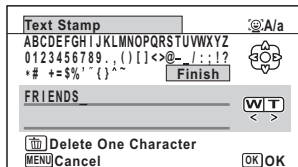

- 2 Use the four-way controller (▲▼◀▶) to select [Finish] and press the OK button.**

- 3 Use the four-way controller (▲▼) to select [Display Position] and press the four-way controller (▶).**



- 4 Use the four-way controller (▲▼) to select the display position and press the four-way controller (◀).**
- 5 Use the four-way controller (▲▼) to select [Color] and press the four-way controller (▶).**
- 6 Use the four-way controller (▲▼) to select the color and press the four-way controller (◀).**

To View the Preview Screen

- 1 Press the Green button.**
The preview screen appears.



- 2 Press the MENU button.**
The screen returns to the original screen.

- 3 Press the OK button.**
Proceed to Step 11 on p.158.

Editing Movies

5

You can extract a frame from the recorded movie to save as a still picture, divide a movie into two, or add a title picture to a movie.

- 1 Enter  mode and use the four-way controller (◀▶) to choose the movie you want to edit.**

- 2 Use the four-way controller (▲▼◀▶) to select  (Movie Editing) from the Playback Mode Palette.**

- 3 Press the OK button.**
The movie editing selection screen appears.



To Save a Frame from a Movie as a Still Picture

- 4 Select [Save as Still Image] on the movie editing selection screen.**

- 5 Press the OK button.**
The screen for selecting a frame to be saved as a still picture appears.

6 Use the four-way controller (▲▼◀▶) to choose the frame you want to save.

- ▲ Plays or pauses the movie
- ▼ Stops the movie and returns to the first frame
- ◀ Reverses the movie frame by frame
- ▶ Advances the movie frame by frame



7 Press the OK button.

The selected frame is saved as a still picture.

To Divide a Movie

4 Select [Divide Movies] on the movie editing selection screen.

5 Press the OK button.

The screen for choosing the dividing position appears.

6 Use the four-way controller (▲▼◀▶) to determine the dividing position.

- ▲ Plays or pauses the movie
- ▼ Stops the movie and returns to the first frame
- ◀ Reverses the movie frame by frame
- ▶ Advances the movie frame by frame



7 Press the OK button.

A confirmation dialog appears.

8 Use the four-way controller (▲) to select [Divide].

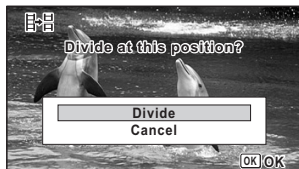

9 Press the OK button.

The movie is divided at the specified position, each segment is saved as a new file, and the original movie is deleted.



The protected movies cannot be divided.



- Only the movie for more than 2 seconds (31 frames) can be divided.
- For dividing, every 30 frames (31st, 61st, 91st.. frames) can be selected.

To Add a Title Picture to a Movie**4 Select [Adding title picture] on the movie editing selection screen.****5 Press the OK button.**

The screen for selecting a title picture appears.



6 Use the four-way controller (◀▶) to choose the desired title picture.

Only images available for use with the title picture are displayed.

7 Press the OK button.

The screen for confirming the position of the title picture appears.

8 Use the four-way controller (▲▼) to select the position.

-  Adds the title picture to the beginning of the movie
-  Adds the title picture to the end of the movie

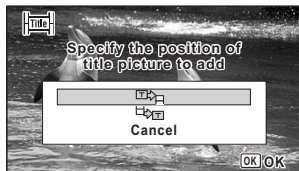
**9 Press the OK button.**

The selected picture is saved as the title picture.



- Protected movies cannot be added a title picture.
- If a movie is more than 26 minutes long after adding title pictures, you cannot add any more title pictures to it.



- When a title picture is added to the beginning of a movie: When the movie is played back, the still picture is played back for three seconds, and then the movie is played back. The still picture registered as title picture is used as the thumbnail of the movie.
- When a title picture is added to the end of a movie: When the movie is played back, the movie is played back, and then the still picture is played back for three seconds. The thumbnail of the movie is not changed by adding a title picture to the end of the movie.
- Only a still picture with the same aspect ratio as the movie can be set as a title picture.

Copying Images and Sound Files

You can copy images and sound files from the built-in memory to the SD Memory Card and vice versa. This function can only be selected when an SD Memory Card has been inserted in the camera.



Make sure that the camera is turned off before inserting or removing the SD Memory Card.

1 Use the four-way controller (▲▼◀▶) to select  (Image/Sound Copy) from the Playback Mode Palette.

2 Press the OK button.

The copying method selection screen appears.

To Copy Files from the Built-in Memory to the SD Memory Card

All the images and sound files in the built-in memory are copied to the SD Memory Card at once. Before copying the images, make sure that there is enough space on the SD Memory Card.

3 Use the four-way controller (▲) to select [ → SD].



4 Press the OK button.

All the images and sound files are copied to the SD Memory Card.

To Copy Files from the SD Memory Card to the Built-in Memory

Selected images and sound files from the SD Memory Card are copied to the built-in memory one by one.

3 Use the four-way controller (▲▼) to select [SD]➡[●].

4 Press the OK button.

5 Use the four-way controller (◀▶) to select the image/sound file you want to copy.

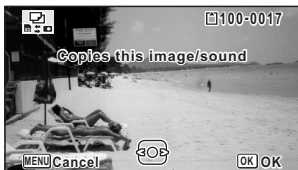

6 Press the OK button.

The selected image/sound file is copied to the built-in memory.

To copy other images or sound files, repeat Steps 3 to 6. Select [Cancel] to exit the copy operation.



- Images with sounds (Voice Memo) are copied with the sound.
- When a file is copied from the SD Memory Card to the built-in memory, it is assigned a new file name.

Printing Settings

You can print pictures taken with the camera in the following ways.

- 1 Go to a photo processing lab.
- 2 Use a printer that has an SD Memory Card slot to print directly from the SD Memory Card.
- 3 Use the software that is available on your computer to print images.

Setting the Printing Service (DPOF)

DPOF (Digital Print Order Format) is the format for storing print order data on still pictures captured with a digital camera. Once the print order data has been stored, the pictures can be printed according to the DPOF settings using a DPOF-compatible printer or at a photo processing lab.

DPOF cannot be set for movies or sound-only files.



If the picture already has the date and/or time imprinted on it (p.109), do not set [Date] to (On) in DPOF setting. If you select , the imprinted date and/or time may overlap.

Printing a Single Image

Set the following items for each image.

Copies	For setting the number of prints. You can print up to 99 copies.
Date	Specify whether you want the date inserted on the print or not.

1 Use the four-way controller (▲▼◀▶) to select  (DPOF) from the Playback Mode Palette.

2 Press the OK button.

The screen for selecting [Single Image] or [All Images] appears.

3 Use the four-way controller (▲▼) to select [Single Image].



4 Press the OK button.

The message [Applies DPOF settings to this image] appears.

To make DPOF settings for another image, use the four-way controller (◀▶) to select another image.

If DPOF settings have already been made for the selected image, the previous number of copies and date setting ((On) or (Off)) will be displayed.

5 Use the four-way controller (▲▼) to choose the number of copies.



6 Use the Green button to choose whether to insert the date or not.

- (On) The date will be imprinted.
- (Off) The date will not be imprinted.

To continue setting DPOF print order data, use the four-way controller (◀▶) to choose another image and repeat steps 5 and 6.

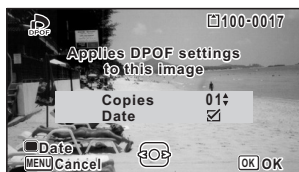

7 Press the OK button.

The setting is saved and the screen shown in Step 3 reappears.



Depending on the printer or printing equipment at the photo processing lab, the date may not be imprinted on the pictures even if (On) is selected in the DPOF settings.



To cancel DPOF settings, set the number of copies to [00] in step 5 and press the **OK** button.

Printing All Images

DPOF settings are applied to all the images stored in the camera.

1 Select [All Images] in step 3 on p.166.

2 Press the OK button.

The message [Applies DPOF settings to all images] appears.

3 Choose the number of copies and whether to insert the date or not.

Refer to steps 5 and 6 in “Printing a Single Image” (p.166) for details of how to make the settings.

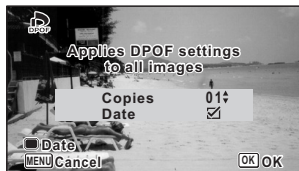

4 Press the OK button.

The settings for all the images are saved and the camera returns to the DPOF setting screen.



- The number of copies specified in the DPOF settings applies to all the images. Before printing, check that the number is correct.
- Settings for single images are canceled when settings are made with [All Images].

Recording Sound (Voice Recording Mode)

You can record sound with the camera. The microphone is located on front of the camera. When recording sound, aim the microphone at the sound source.

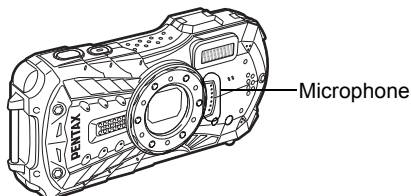

Setting Voice Recording

To use the Voice Recording function, assign it to the Green button first.



When the shooting mode is set to **Green** mode, [Green Button] settings cannot be configured on the [Rec. Mode] menu. To configure the settings, first switch to a mode other than **Green**.

6

1 Use the four-way controller (▲▼) to select [Green Button] on the [Rec. Mode] menu.

2 Press the four-way controller (▶).
A pull-down menu appears.

3 Use the four-way controller (▲▼) to select [Voice Recording] and press the OK button.
The Voice Recording function is assigned to the Green button.

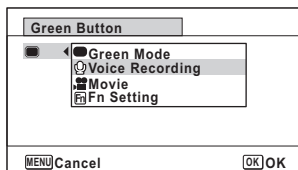

Recording Sounds

1 Press the Green button in mode.

The camera enters  (Voice Recording) mode. The remaining recordable time and the recording time of the current file appear on the display.

- 1 Recording time
- 2 Remaining recordable time

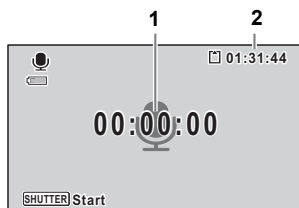

2 Press the shutter release button fully.

Recording starts. The self-timer lamp and REC icon (red) blink during recording. When the Green button is pressed during recording, an index is added to the current sound file.

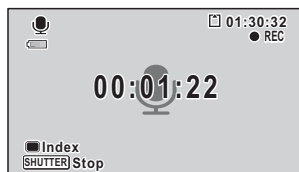

3 Press the shutter release button fully.

Recording stops.





- If you press and hold down the shutter release button for more than one second in step 2, recording continues until you take your finger off the button. This is useful for recording short sounds.
- Sound is saved in WAVE monaural files.

Playing Back Sound

You can play back the sound files you recorded in Voice Recording.

1 Press the  button.

2 Use the four-way controller ( ) to choose a sound file to play back.



3 Press the four-way controller () .

Playback starts.

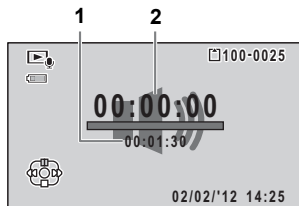

- 1 Total file recording time
- 2 Playback time





The following operations can be performed during playback.

- | | |
|---|----------------------|
| Four-way controller () | Pauses playback |
| Zoom button right () | Increases the volume |
| Zoom button left () | Reduces the volume |



If there are no recorded indexes:

- | | |
|---|------------------------|
| Four-way controller () | Reverses playback |
| Four-way controller () | Fast forwards playback |

If there are recorded indexes:

- | | |
|---|---|
| Four-way controller () | Plays back starting from the previous index |
| Four-way controller () | Plays back starting from the next index |

The following operations can be performed while playback is paused.

- | | |
|---|----------------------------|
| Four-way controller () | Resumes playback |
| Four-way controller () | Rewinds approx. 5 seconds |
| Four-way controller () | Advances approx. 5 seconds |

4 Press the four-way controller () .

Playback stops.

Adding a Voice Memo to Images

You can add a voice memo to your still pictures.

Recording a Voice Memo

1 Enter  mode and use the four-way controller (◀▶) to choose the still picture to which you want to add a voice memo.

2 Use the four-way controller (▲▼◀▶) to select  (Voice Memo) from the Playback Mode Palette.

3 Press the OK button.

Recording starts.





4 Press the OK button.

Recording stops.



- A voice memo cannot be added to the image that already has a voice memo. Delete the old voice memo (p.135) and record a new one.
- A voice memo cannot be added to protected images (p.138).

Playing Back a Voice Memo

- 1** Enter  mode and use the four-way controller ( ) to choose the still picture with the voice memo that you want to play back.

 appears on images with voice memos in single-image display.

- 2** Press the four-way controller () .

Playback starts.



The following operations can be performed during playback.

- | | |
|---|----------------------|
| Zoom button right () | Increases the volume |
| Zoom button left () | Reduces the volume |

- 3** Press the four-way controller () .

Playback stops.

Deleting a Single Image/Sound File  p.135

Camera Settings

Setting the Setting Menu

Settings for the camera are set from the [Setting] menu. Refer to explanations for each function on how to make these settings.

- 1 Press the MENU button in mode.**

The [Setting] menu appears.
When you press the MENU button in mode, press the four-way controller ().
- 2 Use the four-way controller () to select an item and set it up.**
- 3 After finishing the settings, press the MENU button.**

The setting is saved and the camera returns to the previous screen.

To Save the Setting and Start Taking Pictures

- 3 Press the shutter release button halfway.**

The setting is saved and the camera returns to capture mode.



When the [Setting] menu is displayed from mode, you can switch to mode by pressing the button.

To Cancel the Changes and Continue with Menu Operations

- 3 Press the MENU button before you have finished the settings.**

The changes are canceled and you can select a menu.



The MENU button function differs depending on the screen. Refer to the guide indications.

Exit	Exits the menu and returns to the original screen.
	Returns to the previous screen with the current setting.
Cancel	Cancels the current selection, exits the menu and returns to the previous screen.

Formatting the Memory

Formatting deletes all the data on the SD Memory Card or the built-in memory. Be sure to use this camera to format (initialize) an SD Memory Card that is unused or has been used on other cameras or digital devices.

Caution

- Do not remove an SD Memory Card while it is being formatted. This may damage the card and make it unusable.
- Formatting deletes protected images and any data recorded on the card with a computer or any camera.
- SD Memory Cards formatted on a computer or device other than this camera cannot be used. Be sure to format the card with the camera.
- To format the built-in memory, be sure to eject the SD Memory Card beforehand. Otherwise, the SD Memory Card will be formatted.

1 Use the four-way controller (▲▼) to select [Format] on the [↶ Setting] menu.

2 Press the four-way controller (▶).

The [Format] screen appears.

3 Use the four-way controller (▲) to select [Format].

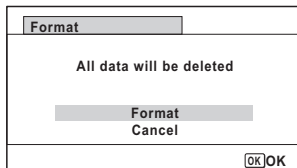

4 Press the OK button.

Formatting starts.

When formatting is completed, the camera returns to mode or mode.

Changing the Sound Settings

You can adjust the volume of operation sounds and change the type of sound.

1 Use the four-way controller (▲▼) to select [Sound] on the [↖ Setting] menu.

2 Press the four-way controller (▶).

The [Sound] screen appears.

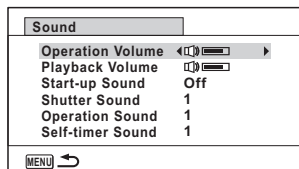

To Change the Operation Volume/Playback Volume

3 Use the four-way controller (▲▼) to select [Operation Volume].

4 Use the four-way controller (◀▶) to adjust the volume.

Set the volume to 0 to mute the start-up sound, shutter sound, operation sound, and self-timer sound.

5 Change [Playback Volume] in the same way as in steps 3 and 4.

To Change the Sound Type

3 Use the four-way controller (▲▼) to select [Start-up Sound].

4 Press the four-way controller (▶).

A pull-down menu appears.

5 Use the four-way controller (▲▼) to select the sound type.

Choose from [1], [2], [3], [4], [Off], or [USER].

6 Press the OK button.

7 Set [Shutter Sound], [Operation Sound] and [Self-timer Sound] in the same way as in steps 3 to 6.

Changing the Sound (Using a Recorded Sound File)

You can use a sound recorded by the camera for sound settings. The first two seconds of the selected sound file will be played as the [USER] sound.

1 Select [USER] in step 5 in “To Change the Sound Type”.

2 Press the OK button.

The playback screen for the recorded sound files appears.

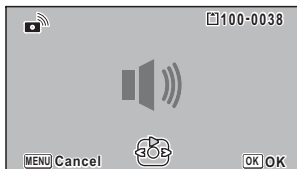

3 Use the four-way controller (◀▶) to select a sound file.

Play back the selected file to confirm.

Four-way controller (▲): Plays back the first two seconds of the sound file.

Four-way controller (▼): Stops playback.

4 Press the OK button.

The selected sound is set as the [USER] sound.

5 Set [Shutter sound], [Operation Sound] and [Self-timer Sound] in the same manner.

7

Settings



The Sound settings are saved when the camera is turned off.

Changing the Date and Time

You can change the initial date and time settings (p.46). You can also set the style in which the date appears on the camera.

1 Use the four-way controller (▲▼) to select [Date Adjustment] on the [↖ Setting] menu.

2 Press the four-way controller (▶).

The [Date Adjustment] screen appears.

Date Adjustment	
Date Format	▶ mm/dd/yy 24h
Date	01/01/2012
Time	00:00
Settings complete	
[MENU] Cancel	

3 Press the four-way controller (▶).

The frame moves to [mm/dd/yy].

Depending on the initial setting or previous setting, [dd/mm/yy] or [yy/mm/dd] may be displayed.

4 Use the four-way controller (▲▼) to choose the date and time display style.

Choose from [mm/dd/yy], [dd/mm/yy] or [yy/mm/dd].

5 Press the four-way controller (▶).

The frame moves to [24h].

6 Use the four-way controller (▲▼) to select [24h] (24-hour display) or [12h] (12-hour display).**7 Press the four-way controller (▶).**

The frame returns to [Date Format].

8 Press the four-way controller (▼).

The frame moves to [Date].

9 Press the four-way controller (▶).

The frame moves to one of the following items depending on the date style set in step 4.

Month for [mm/dd/yy]

Day for [dd/mm/yy]

Year for [yy/mm/dd]

The following operations and screens use [mm/dd/yy] as an example. The operations are the same even if another date style has been selected.

10 Use the four-way controller (▲▼) to change the month.**11 Press the four-way controller (▶).**

The frame moves to the day field. Use the four-way controller (▲▼) to change the day. After changing the day, change the year in the same manner.

- 12** Change the time in the same way as in steps 7 to 11.
If you selected [12h] in step 6, the setting switches between am and pm corresponding to the time.

- 13** Press the four-way controller (▼) to select [Settings complete].

- 14** Press the OK button.

The date and time settings are saved and the screen returns to the [↶ Setting] menu.



When you press the **OK** button in step 14, the camera clock is reset to 00 seconds. To set the exact time, press the **OK** button when the time signal (on the TV, radio, etc.) reaches 00 seconds.

Setting the Alarm

You can set the alarm to ring at a specified time.

You can choose whether the alarm will ring at the same time every day or only once at the set time.

Setting the Alarm

- 1** Use the four-way controller (▲▼) to select [Alarm] on the [↶ Setting] menu.

- 2** Press the four-way controller (▶).

The Alarm screen appears.

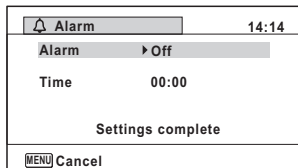

- 3** Press the four-way controller (▶).

A pull-down menu appears.

- 4** Use the four-way controller (▲▼) to select the alarm.

Choose from [Off], [Once], or [Everyday].

- 5** Press the OK button.

- 6** Press the four-way controller (▼).

The frame moves to the [Time] field.

7 Press the four-way controller (▶).

The frame moves to the hour field.

8 Use the four-way controller (▲▼) to change the hour, then press (▶).

The frame moves to the minute field.

Change the minutes in the same manner.

9 Press the OK button.

10 Press the four-way controller (▼).

The frame moves to [Settings complete].

11 Press the OK button.

When the alarm is set to [Off], the settings are saved and the screen returns to the [↖ Setting] menu.

Check that [Alarm] is set to (Off).

When the alarm is set to [Once] or [Everyday], [Alarm is set] is displayed and the power turns off.

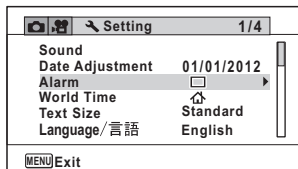

Checking the Alarm

1 Use the four-way controller (▲▼) to select [Alarm] on the [↖ Setting] menu.

Check that [Alarm] is set to (On).

2 Press the four-way controller (▶).

The Alarm screen appears.

Check the alarm frequency and time.

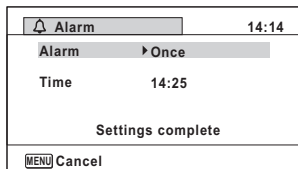

Turning the Alarm Off

The Clock display appears and the alarm rings for one minute when the set time is reached while the camera is turned off.



You can stop the alarm by pressing any button on the camera while the alarm is ringing.





Caution

- The alarm will not ring if the camera is on when the set time is reached.
- Even if an alarm is set, the alarm will not ring while interval shooting is being performed.

Setting the World Time

The date and time selected in “Setting the Date and Time” (p.46) and “Changing the Date and Time” (p.176) serve as the  (Hometown) date and time. By using the world time function, you can display the time in a city other than the Hometown ( Destination). This is useful when taking pictures in a different time zone.



To Set the Destination

1 Use the four-way controller ( ) to select [World Time] on the [ Setting] menu.

2 Press the four-way controller () .

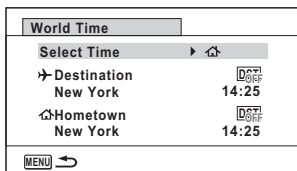
The [World Time] screen appears.



3 Use the four-way controller ( ) to select  (Destination).

4 Press the four-way controller () .

The [Destination] screen appears. The city that is currently selected blinks on the map.

5 Use the four-way controller (◀▶) to change the Destination city.

The current time, location and time difference of the selected city appear.

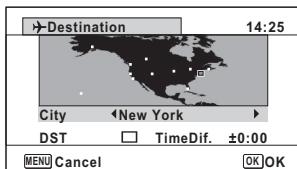

6 Use the four-way controller (▲▼) to select [DST].

7 Use the four-way controller (◀▶) to select (On) or (Off).

Select (On) if the Destination city uses daylight saving time.

8 Press the OK button.

The [World Time] setting is saved.



Select  (Hometown) in step 3 to set the city and DST setting for the Hometown city.

To Display the Time of the Destination (Select Time)

1 Use the four-way controller (▲▼) to select [World Time] on the [Setting] menu.

2 Press the four-way controller (▶).

The [World Time] screen appears.

3 Use the four-way controller (▲▼) to select [Select Time].

4 Press the four-way controller (▶).

A pull-down menu appears.



5 Use the four-way controller (▲▼) to select (Destination) or (Hometown).

 Displays the time of the Destination city

 Displays the time of the Hometown city

6 Press the OK button.

The setting is saved.

When  (Destination) is selected the  icon appears on the display to indicate that the destination date and time are displayed in  mode.



Setting the Text Size on the Menu

You can set the text size of the item selected with the cursor on the menu to [Standard] (normal display) or [Large] (magnified display).

1 Use the four-way controller (▲▼) to select [Text Size] on the [↵ Setting] menu.

2 Press the four-way controller (▶).

A pull-down menu appears.

3 Use the four-way controller (▲▼) to select the text size.

Select from [Standard] or [Large].

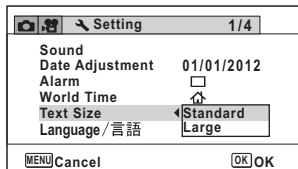

4 Press the OK button.

The setting is saved.

Changing the Display Language

You can change the language in which the menus, error messages, etc. are displayed.

1 Use the four-way controller (▲▼) to select [Language/言語] on the [↵ Setting] menu.

2 Press the four-way controller (▶).

The [Language/言語] screen appears.

3 Use the four-way controller (▲▼◀▶) to select the desired language.

4 Press the OK button.

The menus and messages are displayed in the selected language.

Changing the Naming System of the Folder

You can change the naming system of the folder for storing images. When the naming system is set to the [Date], pictures are saved in separate folders by the date they were taken.

Choice	The name of the folder
Date (Default)	xxx_mmdd (3-digit folder number_month day) * xxx_ddmm (3-digit folder number_day month) when the date format is set to [dd/mm/yy] A folder is made by day, and the images and sound files of the day are saved in the folder.
PENTX	xxxPENTX (xxx is the 3-digit folder number) Up to 9999 images are saved in the same folder.
_USER	xxxxAAAAA (xxx is the automatically given 3-digit folder number, and AAAAA is the 5-digit letters that you entered) Up to 9999 images are saved in the same folder.

Image taken on April 1 with the folder name setting set to [Date] created.

A folder with the name "100_0401" is created.

The images are saved in the "100_0401" folder.

Image taken on April 8 with the folder name setting set to [Date] created.

A folder with the name "101_0408" is created.

The images are saved in the "101_0408" folder.

Image taken on April 10 with the folder name setting set to [PENTX] created.

A folder with the name "102PENTX" is created.

The images are saved in the "102PENTX" folder.

Image taken on April 15 with the folder name setting set to [PENTX] created.

A new folder is not created.

The images are saved in the "102PENTX" folder.

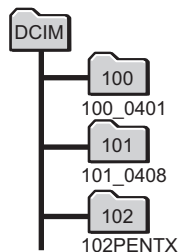
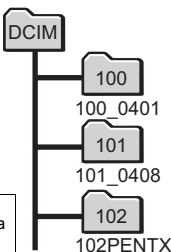
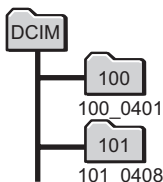
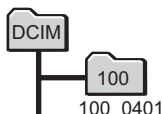

- Up to 900 folders can be created.
- Up to 9999 images or sounds can be saved in a folder.

Selecting a Rule for Naming Folders

- 1 Use the four-way controller (▲▼) to select [Folder Name] on the [↖ Setting] menu.**
- 2 Press the four-way controller (▶).**
A pull-down menu appears.
- 3 Use the four-way controller (▲▼) to select the rule for naming folders.**
- 4 Press the OK button.**
The setting is saved.

Naming the Folder Yourself

You can name the folder in which to save images.
You can enter up to five numbers and letters.
The 5-digit name is displayed after the 3-digit folder number.

- 1 Select [_USER] in step 3 in “Selecting the Rule for Naming Folders”.**
- 2 Press the four-way controller (▶).**
The folder naming screen appears.
“ _USER ” has already been entered.

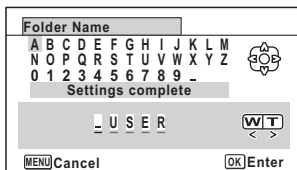

- 3 Use the four-way controller (▲▼◀▶) to select the letter to enter, and press the OK button.**
The first letter is fixed and the cursor moves to the second letter.
- 4 Repeat step 3 and enter the remaining letters.**

- 5** Press the four-way controller (◀) while “A” is selected, or press (▼▶) while “_” is selected.

The frame moves to [Settings complete].

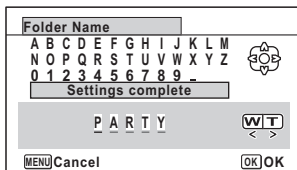

- 6** Press the OK button twice.

The folder name is fixed, and returns to the [⌂ Setting] menu.



- You can move the cursor by pressing the zoom button.
- The folder name you have set is displayed in the [⌂ Setting] menu.

Changing the Naming System of the File

You can change the naming system of the file.

Choice	The name of the file
IMGP (Default)	IMGPxxxx (xxxx is the automatically assigned 4-digit file number) The file number follows the setting character which is specified to the camera.
USER	AAAAxxxx (xxxx is the automatically assigned 4-digit file number) The file number follows the name you have entered.

Selecting a Rule for Naming Files

- 1** Use the four-way controller (▲▼) to select [File Name] on the [⌂ Setting] menu.
- 2** Press the four-way controller (▶).
A pull-down menu appears.
- 3** Use the four-way controller (▲▼) to select the rule for naming files.
- 4** Press the OK button.
The setting is saved.

Naming the File Yourself

You can name the file of images that are captured.
You can enter up to four numbers and letters. The 4-digit name is displayed before the 4-digit file number.

1 Select [USER] in step 3 in “Selecting a Rule for Naming Files”.

2 Press the four-way controller (▶).

The file naming screen appears.
“USER” has already been entered.

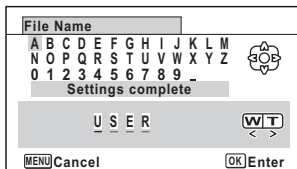

3 Use the four-way controller (▲▼◀▶) to select the letter to enter, and press the OK button.

The first letter is fixed and the cursor moves to the second letter.

4 Repeat step 3 and enter the remaining letters.

5 Press the four-way controller (◀) while “A” is selected, or press (▼▶) while “_” is selected.

The frame moves to [Settings complete].

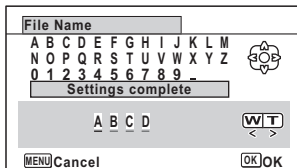

6 Press the OK button twice.

The file name is fixed, and returns to the [↖ Setting] menu.



- You can move the cursor by pressing the zoom button.
- The file name you have set is not changed even if you reset the camera.

Changing the Video Output Format

When you connect the camera to AV equipment, choose the appropriate video output format (NTSC or PAL) for taking and playing back images.

- 1 Use the four-way controller (▲▼) to select [Video Out] on the [↶ Setting] menu.**
- 2 Press the four-way controller (▶).**
A pull-down menu appears.
- 3 Use the four-way controller (▲▼) to select a video output format.**
Choose the video output format to match the output format of the AV equipment.
- 4 Press the OK button.**
The setting is saved.



Depending on the country or region, images and sound files may fail to be played back if the video output format is set differently from the one in use there. If this happens, change the video output format setting.

Connecting the Camera to AV Equipment ☞p.140
Video Output Format by City ☞p.232

Selecting the HDMI Output Format

When you connect the camera to AV equipment with an HDMI cable, set the appropriate video output resolution for playing back images. The default setting is [Auto].

- 1 Use the four-way controller (▲▼) to select [HDMI Out] on the [↶ Setting] menu.**
- 2 Press the four-way controller (▶).**
A pull-down menu appears.
- 3 Use the four-way controller (▲▼) to select an output format.**
Choose the HDMI output format to match the output format of the AV equipment.
- 4 Press the OK button.**
The setting is saved.



The items on the pull-down menu vary depending on the selected Video output format.

To change the display, set the Video output format before setting the HDMI output format.

The table below shows the combinations of the Video output format and HDMI output.

	Video output format	
	NTSC	PAL
Resolution	Auto (The largest size that both the TV and camera support is automatically selected)	
	1080i (1920×1080i)	
	720p (1280×720p)	
	480p (1920×1080i)	576p (720×576p)

Setting the Eye-Fi Communication

You can automatically transfer images or movies to a computer or similar devices via wireless LAN using a commercially available Eye-Fi card. For details on transferring images, refer to "Transferring Images Using an Eye-Fi Card" (p.218). The default setting is (Off).

- 1 Use the four-way controller (▲▼) to select [Eye-Fi] on the [↖ Setting] menu.**
- 2 Use the four-way controller (◀▶) to select (On) or (Off).**
 - (On) Turns on communication using an Eye-Fi card
 - (Off) Turns off communication using an Eye-Fi card
- 3 Press the OK button.**



The setting is saved.



To establish an Eye-Fi communication, you first have to specify a wireless LAN access point and transfer destination on the Eye-Fi card. For details on how to set up the card, refer to the operating manual supplied with the Eye-Fi card.

Adjusting the Brightness of the Display

You can adjust the brightness of the display to 7 levels.

- 1 Use the four-way controller (▲▼) to select [Brightness Level] on the [↖ Setting] menu.**
- 2 Use the four-way controller (◀▶) to adjust the brightness.**
 -  Dark
 -  Normal
 -  Bright

Using the Power Saving Function

You can save battery power by setting the display to dim automatically when no operation is performed for a fixed time. After the power saving function has been activated, the display returns to the ordinary brightness if any button is pressed.

- 1 Use the four-way controller (▲▼) to select [Power Saving] on the [↖ Setting] menu.**
- 2 Press the four-way controller (▶).**
A pull-down menu appears.
- 3 Use the four-way controller (▲▼) to select the time until the camera enters power saving mode.**
Choose from [2min.], [1min.], [30sec.], [15sec.], [5sec.] or [Off].
- 4 Press the OK button.**
The setting is saved.



- Power Saving does not function in the following situations:
 - While taking pictures in (Continuous Shooting) and (Burst Shooting) modes
 - In playback mode
 - During movie recording
 - While the camera is connected to a computer
 - When using the AC adapter
 - While a menu is being displayed
 - In (Digital Microscope) mode
- When no operation is performed after the camera is turned on, Power Saving is activated only after 15 seconds elapse even if [5sec.] is set.

Setting Auto Power Off

You can set the camera to turn off automatically when no operation is performed for a fixed time.

- 1 Use the four-way controller (▲▼) to select [Auto Power Off] on the [↖ Setting] menu.**
- 2 Press the four-way controller (▶).**
A pull-down menu appears.

3 Use the four-way controller (▲▼) to select the time until the camera turns off automatically.

Choose from [5min.], [3min.] or [Off].

4 Press the OK button.

The setting is saved.



Auto Power Off does not function in the following situations:

- While taking pictures in (Continuous Shooting) and (Burst Shooting) modes
- While recording a movie
- During a slideshow or movie/sound playback
- While the camera is connected to a computer
- While recording sound in (Voice Recording) mode
- While images are being transferred in Eye-Fi communication.

Setting the Quick Zoom Function

While playing back images in mode, you can set whether to use [Quick Zoom] to enlarge the playback image up to 10× when pressing the button once.

1 Use the four-way controller (▲▼) to select [Quick Zoom] on the [Setting] menu.

2 Use the four-way controller (◀▶) to switch between (On) or (Off).

- (On) The Quick Zoom is available.
- (Off) The Quick Zoom is not available.

Setting the Guide Display

Set whether to display the guide for the Capture Mode Palette or Playback Mode Palette.

1 Use the four-way controller (▲▼) to select [Guide Display] on the [Setting] menu.

2 Use the four-way controller (◀▶) to switch between (On) or (Off).

- (On) The mode guides are displayed.
- (Off) The mode guides are not displayed.

Perform Pixel Mapping

Pixel Mapping is a function for mapping out and correcting for defective pixels in the CCD sensor. Run the Pixel Mapping function if image dots always seem to be defective in the same place.



- Pixel Mapping is only accessible from mode. Pixel Mapping cannot be selected even if the [Setting] menu is displayed by pressing the **MENU** button in mode.
- When executing Pixel Mapping from mode, press the button once to enter mode. Then press the **MENU** button and the four-way controller () to display the [Setting] menu and select Pixel Mapping.
- Pixel Mapping cannot be selected in (Voice Recording) mode.

1 Use the four-way controller () to select [**Pixel Mapping**] on the [Setting] menu.

2 Press the four-way controller ().
The [Pixel Mapping] screen appears.

3 Use the four-way controller () to select [**Pixel Mapping**].

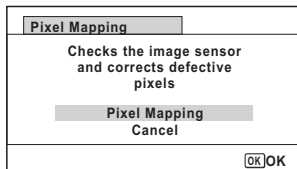

4 Press the **OK** button.
Defective pixels are mapped and corrected.



When the battery level is low, [Not enough battery power remaining to activate Pixel Mapping] is displayed on the monitor. Use the AC adapter kit K-AC117 (optional) or use a battery with ample capacity remaining.

Changing the Start-up Screen

You can choose the start-up screen displayed when the camera is turned on.

You can choose any of the following images as the start-up screen:

- The Guide Display Start-up Screen showing a guide for the shooting modes and buttons
- One of the 3 pre-installed screens
- One of your own images (compatible images only)

1 Use the four-way controller (▲▼◀▶) to select  (Start-up Screen) from the Playback Mode Palette.

2 Press the OK button.

The image selection screen appears.

3 Use the four-way controller (◀▶) to choose the image for the start-up screen.

Only images available for the start-up screen are displayed. You can also choose one of the 3 pre-installed screens or the Guide Display Start-up Screen already stored in the camera.



4 Press the OK button.

The setting is saved.



- Once the start-up screen has been set, it will not be deleted even if the original image is deleted or the SD Memory Card or built-in memory is formatted. However the image is deleted if you change the start-up screen after deleting the recorded image or formatting the memory.
- The start-up screen is not displayed when set to [Off].
- The start-up screen is not displayed when you turn the camera on in playback mode.
- Movies or images taken at  (Digital Panorama) mode cannot be used for the start-up screen.

Resetting to Default Settings (Reset)

You can reset the camera settings to their defaults. Refer to “Default Settings” (p.227) for the reset settings.

1 Use the four-way controller (▲▼) to select [Reset] on the [↶ Setting] menu.

2 Press the four-way controller (▶).

The [Reset] screen appears.

3 Use the four-way controller (▲) to select [Reset].

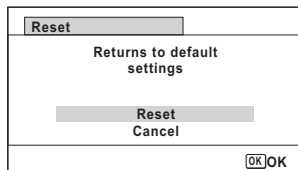

4 Press the OK button.

The settings return to the defaults.

Setting the Startup Shortcut

You can start a function by pressing a button other than power switch when the camera is off.

7

Settings

Playback Mode	When [Playback Mode] is on, you can turn on the camera by pressing and holding down the [▶] button.
LED Lighting	When [LED Lighting] is on, you can turn on the LED Macro Lights by pressing and holding down the Green button.
Clock Display	When [Clock Display] is on, you can display the clock on the display by pressing and holding down the OK button.

1 Use the four-way controller (▲▼) to select [Startup Shortcut] on the [↶ Setting] menu.

2 Press the four-way controller (▶).

The [Startup Shortcut] screen appears.

3 Use the four-way controller (▲▼) to select an item.

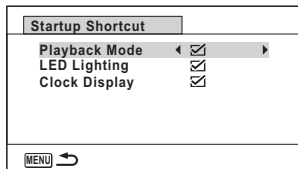

4 Use the four-way controller (◀▶) to switch between (On)/

(Off).

- (On) The startup shortcut is available
- (Off) The startup shortcut is not available



The default settings are all (On).

Displaying the Clock Display

You can use the camera as a clock. With the camera turned off, press and hold down the **OK** button to display the clock on the display.

1 Press and hold down the **OK** button.

The camera turns on and the clock appears on the screen.

The camera turns off automatically after approximately 10 seconds.

Pressing the power switch turns the camera off immediately.



Not to function the clock display by pressing **OK** button, set [Clock Display] to (Off) on [Startup Shortcut] from [Setting] menu. (p.194)

Light up the LED

You can use the camera as a light. Pressing and holding down the Green button lights up the LED Macro Lights when the camera is turned off.

1

Press and hold down the Green button.

The LED light up. The LED turn off automatically after the period you have set on [Auto Power Off].

Pressing the power switch turns the camera off immediately.



- Not to light up the LED by pressing the Green button, set [LED Lighting] to (Off) on [Startup Shortcut] from [Setting] menu (p.194).
- When the [Auto Power Off] is set to [Off], the LED do not turn off automatically.
- Press the power switch to turn off the LED.

Setting Up Your Computer

By installing the software included on the provided CD-ROM on your computer and connecting the camera to your computer with the USB cable, you can transfer images and movies captured with your camera to the computer and then display and manage them. This section explains how to install the provided software and the other necessary preparations for enjoying the captured images and movies on your computer.

Provided Software

The following software is included on the provided CD-ROM.

Windows

- **Image viewing/managing/editing software “MediaImpression 3.5 for PENTAX”**

Macintosh

- **Image viewing/managing/editing software “MediaImpression 2.1 for PENTAX”**

(Applicable languages: English, French, German, Spanish, Portuguese, Italian, Dutch, Swedish, Russian, Chinese [traditional and simplified], Korean, and Japanese)



We recommend using the optional AC adapter kit K-AC117 when the camera is connected to a computer (p.37). If the battery runs out of power while images are being transmitted to a computer, the data may be lost or damaged.

System Requirements

The following system requirements must be met for you to fully enjoy the images and movies captured with the camera on your computer.

* The following lists the minimum system requirements for playing back and editing movies. Operation is not guaranteed on all computers meeting the system requirements.

Windows

OS	Windows XP SP3, Windows Vista or Windows 7 <ul style="list-style-type: none">The OS must be preinstalled and updated to the latest version.
CPU	Pentium 4 1.6 GHz or equivalent AMD Athlon (Intel Core 2 Duo 2.0 GHz or equivalent AMD Athlon X2 processor or above recommended)
Memory	512 MB minimum (1 GB or more recommended)
Hard Disk Space	300 MB minimum
Monitor	1024 × 768 pixels, 16-bit color monitor or higher
Others	CD-ROM/DVD drive USB port as standard equipment



Windows 95, Windows 98, Windows 98SE, Windows Me, Windows NT and Windows 2000 are not supported.

Macintosh

OS	Mac OS X (Ver.10.4, 10.5, 10.6 10.7) <ul style="list-style-type: none">The OS must be preinstalled and updated to the latest version.
CPU	PowerPC G4 800 MHz processor or equivalent (Intel Core Duo processor or above recommended)
Memory	512 MB minimum (1 GB or more recommended)
Hard Disk Space	300 MB minimum
Monitor	1024 × 768 pixels, 16-bit color monitor or higher
Others	CD-ROM/DVD drive USB port as standard equipment

* The movie edited with "MedialImpression 2.1 for PENTAX" cannot be saved as MPEG-4 AVC/H.264 format.

Installing the Software

Windows

Install the image viewing/managing/editing software (MediaImpression 3.5 for PENTAX).



- Make sure your Windows PC meets the system requirements before installing the software.
- When multiple accounts have been set up, log on with an account that has administrative rights before installing the software.

1 Turn your Windows PC on.

2 Insert the CD-ROM into the CD-ROM/DVD drive.

[Auto play] screen appears.

Click [PENTAX Software Installer], and then click [Yes].

If the installer screen does not appear

Display the installer screen following the steps below.

- 1) Double-click [My Computer] on the desktop.
- 2) Double-click the [CD-ROM/DVD drive] icon.

If you are using Windows XP

The “MediaImpression 3.5 for PENTAX” installer screen appears.

3 Click [ArcSoft].

The “Choose Setup Language” screen appears.



4 Choose a language, and click [OK].

The setup screen appears.

Follow the on-screen guidance to install the software.



- 5** Click **[Finish]**.
“Medialmpression 3.5 for PENTAX”
installation is complete.

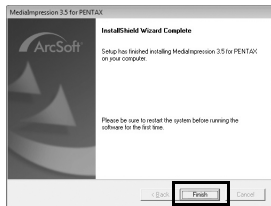

- 6** Click **[Exit]** on the installation screen.
The window closes.

Macintosh

Install the image viewing/managing/editing software (Medialmpression 2.1 for PENTAX).

- 1** Turn your Macintosh on.
- 2** Insert the CD-ROM into the CD-ROM/DVD drive.
- 3** Double-click the CD-ROM icon.
- 4** Double-click the **[Pentax Software Installer]** icon.
The “Medialmpression 2.1 for PENTAX” installer screen appears.
- 5** Click **[ArcSoft]**.

The setup screen appears.
Follow the on-screen guidance to install the software.



6**Click [Close].**

“MediaImpression 2.1 for PENTAX”
installation is complete.

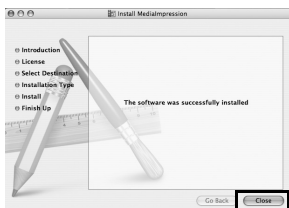
**7****Click [Exit] on the installation screen.**

The window closes.

Product Registration on the Internet

In order to better serve you, we request that you complete the product registration.

If your computer is connected to the Internet, please click [Product Registration] on the setup screen after the language selection screen is displayed.

The world map screen shown on the right for Internet Product Registration is displayed. Click the displayed country or region and then follow the instructions to register your product.

Only customers in countries and regions displayed on the software installation screen can register their products on the Internet Product Registration.

**8**

Setting the USB Connection Mode

Set the device to which the camera is connected with the USB cable.



Make sure to set the USB connection mode before connecting your camera to the computer. You cannot perform the following setting if the camera is already connected to your computer with the USB cable.

- 1 Turn your camera on.**
- 2 Use the four-way controller (▲▼) to select [USB Connection] on the [↖ Setting] menu.**
- 3 Press the four-way controller (▶).**
A pull-down menu appears.
- 4 Use the four-way controller (▲▼) to select [MSC].**

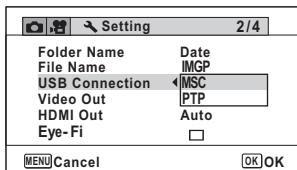

- 5 Press the OK button.**
The setting is saved.

Proceed to the following pages depending on your computer.

Connecting to a Windows PC p.204

Connecting to a Macintosh p.212

MSC (Mass Storage Class)

A general-purpose driver program that handles devices connected to the computer via USB as a memory device. Also indicates a standard for controlling USB devices with this driver.

By simply connecting a device that supports USB Mass Storage Class, you can copy, read, and write files from a computer without installing a dedicated driver.

PTP (Picture Transfer Protocol)

A protocol that allows transfer of digital images and control of digital cameras via USB, standardized as ISO 15740.

You can transfer image data between devices that support PTP without installing a device driver.

Unless otherwise specified, select MSC when connecting the camera to your computer.

Connecting to a Windows PC

Connecting the Camera and Your Windows PC

Connect your camera to the Windows PC using the provided USB cable.

- 1 Turn your Windows PC on.**
- 2 Turn your camera off.**
- 3 Connect your camera to the Windows PC using the USB cable.**

Connect the terminal of the USB cable with arrow mark  facing the front side of the camera.

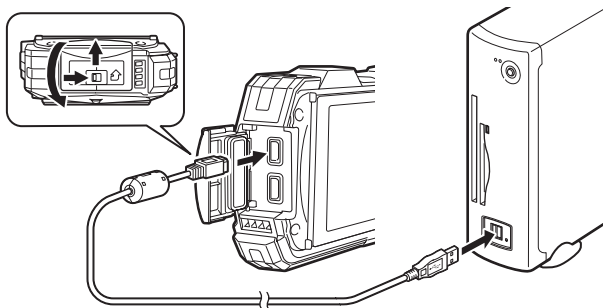

- 4 Turn your camera on.**

The "AutoPlay" screen appears.

If the "AutoPlay" screen does not appear, follow the steps in "When the "AutoPlay" Screen Does Not Appear" (p.206).



We recommend using the optional AC adapter kit K-AC117 when the camera is connected to the computer (p.37). If the battery runs out of power while images are being transmitted to the computer, the image data may be lost or damaged.



The power lamp is lit while the camera is connected to a PC, and it blinks while the card is being accessed.

Transferring Images

Transfer the images captured with the camera to your Windows PC.



If there is no SD Memory Card in the camera, the images stored in the built-in memory will be transferred to your Windows PC.

5 Click [Import media files to local disk].

The “MediaImpression 3.5 for PENTAX” starts.

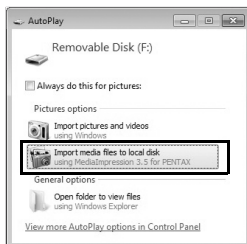

6 Select an image to import.

To select multiple images, choose the images while pressing the Ctrl key. To specify the destination location, click the folder icon at [Destination Folder].

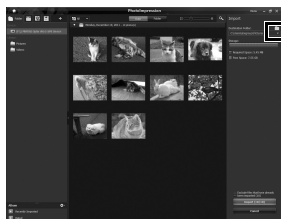

7 Click [Import].

A message appears indicating that import is complete. An arrow mark appears on the imported image.

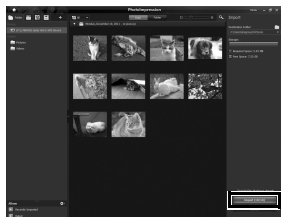

When the “AutoPlay” Screen Does Not Appear

- 5** Double-click the [MediaImpression 3.5 for PENTAX] icon on the desktop.



- 6** Click [PhotoImpression].



- 7** Click the icon of connected camera at the upper left on the screen.

The import screen appears. For the following procedures, proceed to step 6 on p.205.

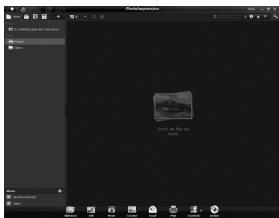

Images are stored in folders named by the shooting date (“XXX_0808” for August 8. “XXX” is a three-digit folder number.).

If [PENTX] is selected for [Folder Name] in the [⌘ Setting] menu, a folder named “XXXPENTX” (XXX is a three-digit folder number) is displayed. If [_USER] is selected for [Folder Name], “xxxAAAAA” (xxx is a three-digit folder number, AAAAA is the 5-digit letters that you entered) is displayed. The images are stored there.

Disconnecting the Camera from Your Windows PC

- 1** Click the  [Safely Remove Hardware] icon in the task bar.



- 2** Click [Eject xxx (name of the camera)].

A message appears indicating that the hardware can be safely removed.



- 3** Disconnect the **USB cable from your Windows PC and the camera.**



- If the camera (removable disk) is being used by an application such as “MediaImpression 3.5 for PENTAX”, the camera cannot be disconnected until the application is closed.
- The camera will automatically switch to the playback mode when the USB cable is disconnected from your Windows PC or the camera.

Starting “MediaImpression 3.5 for PENTAX”

“MediaImpression 3.5 for PENTAX” lets you view, edit, manage, search for, share, and print images.

- 1 Double-click the [MediaImpression 3.5 for PENTAX] icon on the desktop.**

“MediaImpression 3.5 for PENTAX” starts and the main window appears.

Media Window Interface

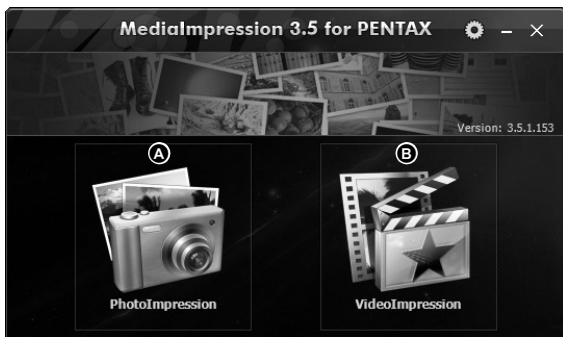

* The screen shown is an example with the default settings.

A PhotoImpression

You can view or manage still pictures. For example, you can import, edit and print still pictures.

B VideoImpression

You can view or manage movies. For example, you can import and edit movies.

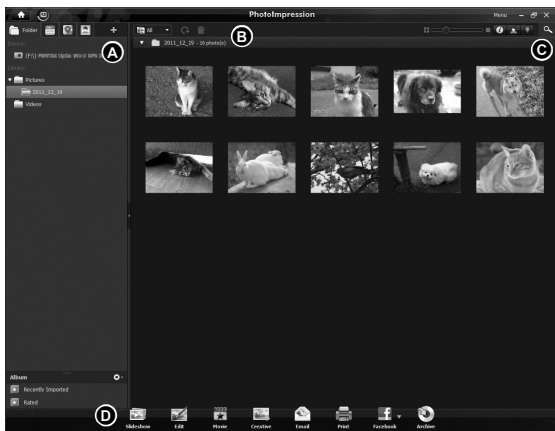

* The screen shown is an example with the default settings.

A Views

Displays the configuration of folders or groups sorted by your favorites, GPS information or a detected person.

B Preview Area

Displays the contents of the selected folder or sorted group.

C Properties

Displays the information of the selected image, detects people or displays the map of the location at which the image was shot (only for images with GPS information).

D Actions

This panel provides editing/managing functions, such as editing, making movies.

Viewing Images

- 1** Click [PhotoImpression] or [VideoImpression] from the main window.



- 2** Select and click the folder or the group containing the image you want to view.

Images are displayed.



- 3** Select and double-click the image you want to view.

The selected image is displayed with the viewer.

With the viewer, you can enlarge/reduce the display size of the image or edit it and so on. You can also play back movies or sound files.

Double-click the image to view it at full screen.



Details on How to Use “MediaImpression 3.5 for PENTAX”

You can find more information on how to use “MediaImpression 3.5 for PENTAX” by using the help pages.

1 Click [Help] from [Menu] on the menu bar.

The help screen appears.

2 Click the desired topic.

An explanation is displayed.

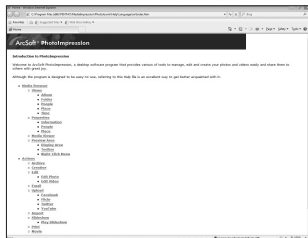

Connecting to a Macintosh

Connecting the Camera and Your Macintosh

Connect your camera to the Macintosh using the provided USB cable.

- 1 Turn your Macintosh on.**
- 2 Turn your camera off.**
- 3 Connect your camera to the Macintosh using the USB cable.**
Connect the terminal of the USB cable with arrow mark  facing the front side of the camera.

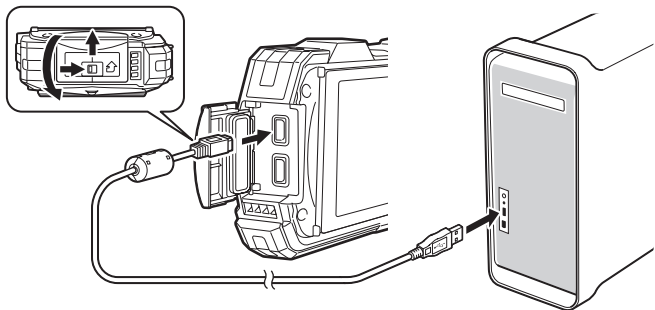

- 4 Turn your camera on.**
The camera is recognized as [NO_NAME] on the desktop.



We recommend using the optional AC adapter kit K-AC117 when the camera is connected to the computer (p.37). If the battery runs out of power while images are being transmitted to the computer, the image data may be lost or damaged.



- If the SD Memory Card has a volume label, the volume label name appears instead of [NO_NAME]. A new unformatted SD Memory Card may show the manufacturer's name or model number.
- The power lamp is lit while the camera is connected to a Macintosh, and it blinks while the card is being accessed.

Transferring Images

Transfer the images captured with the camera to your Macintosh.



If there is no SD Memory Card in the camera, the images stored in the built-in memory will be transferred to your Macintosh.

- 5** Double-click the [Medialmpression] folder inside the [Applications] folder.
- 6** Double-click the [Medialmpression 2.1 for PENTAX] icon. “Medialmpression 2.1 for PENTAX” starts and the main browser window appears.
- 7** Set up [Destination Folder] and select [Subfolder Name].

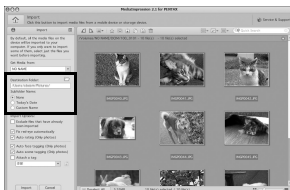

- 8** Select the image/s you want to copy, then click [Import].
The selected image/s is copied to the PC.

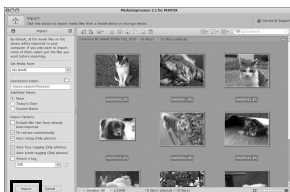

- 9** Click [Done].

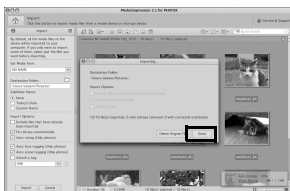

Disconnecting the Camera from Your Macintosh

1 Drag [NO_NAME] on the desktop to the trash.

If the SD Memory Card has a volume label, drag the icon of that name to the trash.

2 Disconnect the USB cable from your Macintosh and the camera.



- If the camera (removable disk) is being used by an application such as "MediaImpression 2.1 for PENTAX", the camera cannot be disconnected until the application is closed.
- The camera will automatically switch to the playback mode when the USB cable is disconnected from your Macintosh or the camera.

Starting “MediaImpression 2.1 for PENTAX”

“MediaImpression 2.1 for PENTAX” lets you view, edit, manage, search for, share, and print images.

- 1 Double-click the [MediaImpression] folder inside the [Applications] folder.**
- 2 Double-click the [MediaImpression 2.1 for PENTAX] icon.**
“MediaImpression 2.1 for PENTAX” starts and the main browser window appears.

Media Window Interface

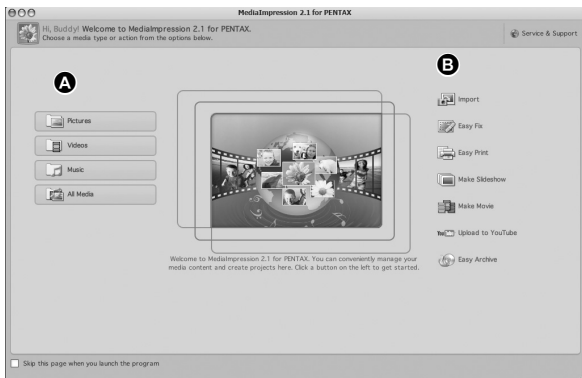

* The screen shown is an example with the default settings.

A Media browser tool

You can view images or play back movies, sound files.

B Edit/Managing tool

You can edit or manage images. For example, you can import, edit or print images.

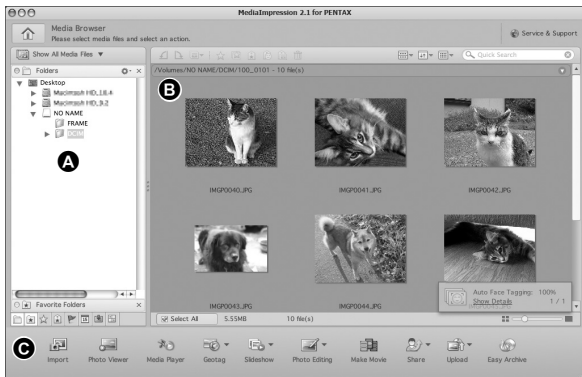

* The screen shown is an example with the default settings.

A Views

Displays the configuration of folders in your computer. When you browse a folder, the contents of the folder appear in the media thumbnail pane.

B Preview Area

Displays the contents of the selected folder or the results of the most recent search (the file/s or folder/s that matches the search item).

C Actions

This panel provides editing/managing functions, such as importing, editing, making movies.

Viewing Images

- 1** Click [Pictures], [Videos], or [All Media] from the main window.
- 2** Select and click the folder containing the image you want to view in the folder pane.
- 3** Select and double-click the image you want to view in the media thumbnail pane.

The selected image is displayed with the viewer.

With the viewer, you can enlarge/reduce the display size of the image or edit it and so on.

You can also play back movies or sound files.



Details on How to Use “Medialmpression 2.1 for PENTAX”

You can find more information on how to use “Medialmpression 2.1 for PENTAX” by using the help pages.

- 1** Select [ArcSoft Medialmpression Help] from [Help] on the menu bar.
The help screen appears.
- 2** Click the desired topic.
An explanation is displayed.

Transferring Images Using an Eye-Fi Card

You can automatically transfer images or movies to a computer or similar devices via wireless LAN using a memory card that is equipped with the wireless LAN (Eye-Fi card) function.

1 Specify the wireless LAN access point and transfer destination on the Eye-Fi card.

For details on how to set up the card, refer to the operating manual supplied with the Eye-Fi card.

2 Turn the camera off.





3 Insert the Eye-Fi card that has been set up.

4 Turn the camera on.

5 Set [Eye-Fi] in the [Setting] menu to (On).

The images are transferred automatically. For details on how to set up the camera, refer to "Setting the Eye-Fi Communication" (p.189).



The following icons appear on the display.

Eye-Fi 	During Eye-Fi communication. The camera is communicating or searching for the access point when [Eye-Fi] is set to <input checked="" type="checkbox"/> (On).
Eye-Fi 	Eye-Fi communication waiting. The camera is not communicating when [Eye-Fi] is set to <input checked="" type="checkbox"/> (On).
Eye-Fi 	Eye-Fi communication prohibited. When [Eye-Fi] is set to <input type="checkbox"/> (Off).
Eye-Fi 	Eye-Fi version error. Version of the Eye-Fi card is out of date or the card is write-protected.



- Not available for Endless Memory mode.
- Run the latest firmware on your Eye-Fi card.



- When you use a new Eye-Fi card, copy the install file of Eye-Fi Manager stored on the card to your computer before you format the card.
- Do not use an Eye-Fi card, or set [Eye-Fi] to (Off) in a location where wireless LAN devices are restricted or prohibited, such as on planes (since images are transferred via wireless LAN).
- If you insert an older version Eye-Fi card in the camera, an error message appears.
- Images are not transferred in the following cases:
 - When available wireless LAN access points are not found.
 - When the battery level is low ( (yellow) or  (red) is indicated).
- Sound files cannot be transferred.
- We recommend that you use an AC adapter (optional) when you transfer a large number of images because this often requires long transferring times.
- While images are being transferred, the Auto Power Off does not function.
- If you transfer large-sized files, such as a movie, the temperature inside the camera increases and the camera may be automatically turned off to protect the circuit.
- To transfer images via wireless LAN, use of an access point, an Internet environment, and configuration are required. For details, refer to the Internet website (<http://www.eye.fi/>).
- For details on how to use an Eye-Fi card, refer to the operating manual supplied with the Eye-Fi card.
- If you have a problem with the Eye-Fi card, contact the manufacturer of the card.
- This camera is equipped with the function that sets Eye-Fi communication to on or off, however, this does not guarantee availability of all the functions on the Eye-Fi card.
- Use of the Eye-Fi card is permitted only in the country where you purchased the card. Follow the laws of that country.

Functions Available for Each Shooting Mode

√: Can be set.

×: Cannot be set.

—: Settings and changes are not applied.

Function		Shooting Mode								
Zoom button	Zoom operation	√*2	√	√	√	√*3	√	√*3	√	
Ⓞ button	Face Detection On	√	√	√	√	√	√	√	√	
	Smile Capture	√	√	√	√	√	√	√	√	
	Self-portrait Assist / Self-portrait Assist + Smile Capture	√*30	√*30	√*30	√*30	×	√*30	×	√*30	
	Face Detection Off	×	√	√	√	√	√	√	√	
Flash Mode	Auto	√	√	×	×	×	√	×	√	
	Flash Off	√	√	√	√	√	√	√	√	
	Flash On	√	√	×	×	×	√	×	√	
	Auto + Red-eye	√	√	×	×	×	√	×	√	
	Flash On + Red-eye	√	√	√	×	×	√	×	√	
Drive Mode	Standard	√	√	√	×	√	√	√	√	
	Self-timer	√	√	√	×	√	√	√	√	
	Continuous Shooting/ Burst Shooting	×	√	×	×	×	√	×	√	
	Remote Control	√	√	√	×	√	√	√	√	
Focus Mode	Auto Bracketing	×	√	√	×	×	√	×	√	
	AF Standard	√	√	√	√	√	√	√	√	
	Macro	√	√	√	√	√	√	√	√	
	1cm Macro	√	√	√	√	√	√	√	√	
	PF Pan Focus	√	√	√	√	√	√	√	√	
	Infinity	√	√	√	√	√	√	√	√	
MF Manual Focus	√	√	√	√	√	√	√	√		
[Rec. Mode] menu	Image Tone	×*8	√	√	√	√	×	×	×	
	Recorded Pixels	√	√	√	√	√*10	√	√*10	√	
	Quality Level	√	√	√	√	×	√	×	√	
	White Balance	×	√	√	√	√	×	×	×	
	AF Setting	Focusing Area	×	√	√	√	√*21	√	√*21	√
		Auto Macro	√	√	√	√	√	√	√	√
		Focus Assist	√	√	√	√	×	√	×	√
	AE Metering	×	√	√	√	×	×	×	×	
	Sensitivity	√	√	√	√	×	√	×	√	
	AUTO ISO Range	√	√	√	√	×	√	×	√	
	EV Compensation	×	√	√	√	√	√	√	√	
	D-Range Setting	×	√	√	√*9	√	√	√	√	
	Pixel Track SR*1	√	√	√	×	√	√	√	√	
	Blink Detection	√	√	√	√	—	√	—	√	
	Sharpness/Saturation (Tone Adjustment)/Contrast	×	√	√	√	√	×	×	×	
Date Imprint	√	√	√	√	—	√	—	√		
IQ Enhancer	√	√	√	×	√	√	√	√		
Macro Light	√	√	√	√	√	√	√	√		

√	√	√ ³	√ ³	√ ⁴	x	√	√	√	√	√	√	√ ⁵	√ ⁶	
√	√	√	√	x	√	√	√	√	√	√	√	√	√	
√	x	x	√	x	√	√	√	x	√	√	√	√	√	
√ ³⁰	√ ³¹	√ ³¹	x	x	x	√ ³⁰	√ ³⁰	x	√ ³⁰	x	√ ³⁰	x	√ ³⁰	
x	√	√	√	x*7	√	√	√	x	√	√	√	√	√	
√	√	x	x	x	√	√	√	√	x	√	√	√	√	
√	√	√	√	√	√	√	√	√	√	√	√	√	√	
√	√	x	x	x	√	√	√	√	x	√	√	√	x	
√	√	x	x	x	√	√	√	√	x	√	√	√	x	
√	√	x	x	x	√	√	√	√	x	√	√	√	x	
√	x	x	√	√	√	√	√	√	√	√	√	√	√	
√	x	x	√	√	√	√	√	√	√	√	√	√	√	
√	x	x	x	x	x	√	√	√	x	x	x	√	x	
√	x	x	x	x	x	√	√	√	x	x	x	√	x	
√	√	√	√	x	√	√	√	√	x	√	√	√	√	
√	√	√	√	x	√	√	√	√	x	√	√	√	√	
√	√	√	√	x	√	√	√	√	x	√	√	√	√	
√	√	x	x	x	√	√	√	√	x	√	√	√	x	
x*8	√	√	√	√	√	√	√	x*8	x*8	x*8	√	√	x*8	
√	√	x	x*32	x*11	x*12	√	√	√	√	√	√ ¹³	x*14	x*15	x*16
√	√	x*17	x*17	√	√	√	√	√	√	√	√	√	√	x*18
x*19	√	√	√	√	√	√	√	x*19	x*19	x*19	√	√	x*19	x*19
√	√	√ ²¹	√ ²¹	√	√	√	√	√	√	x*20	√	√ ²¹	√	x*20
√	√	√	√	x	√	√	√	√	√	x	√	√	√	x*22
√	√	x	x	√	√	√	√	√	√	x	√	√	√	x*22
x*23	√	x*23	x*23	√	√	√	√	x*23	x*23	x*23	√	√	x*23	x*23
√	√	x*24	x*24	√	√	x*24	√	√	√	x*25	√	√	√	x*24
√	√	x*26	x*26	√	√	x*27	√	√	√	-	√	√	x*27	-
√	√	√	√	√	√	√	√	√	√	√	√	√	√	x*28
√	√	√	√	√	√	√	√	√	√	√	√	√	√	x*7
√	x*7	x*7	x*7	√	x*7	x*7	√	√	x*7	x*7	x*7	√	x*7	
√	√	-	-	x*7	√	√	√	√	√	√	√	√	x*22	
x*29	√	√	√	√	√	√	√	x*29	x*29	x*29	√	√	x*29	x*29
√	√	-	-	√	√	√	√	√	√	√	√	√	√	x*7
√	√	√	√	√	x*7	√	√	√	√	√	x*7	√	√	x*22
√	√	√	√	x*22	√	√	√	√	√	√	√	√	√	x*7

- *1 Movie SR is used for movies, while Pixel Track SR is used for still pictures.
- *2 Flowers cannot be detected when using digital zoom or Intelligent Zoom.
- *3 Before shooting only optical zoom and digital zoom are available, during shooting only digital zoom is available.
- *4 Only optical zoom and Intelligent Zoom are available, digital zoom is not available.
- *5 Only optical zoom is available, digital zoom and Intelligent Zoom are not available.
- *6 Only optical zoom and digital zoom are available, Intelligent Zoom is not available.
- *7 Fixed to (Off)
- *8 Fixed at Bright
- *9 Only Shadow Correction is available.
- *10 Set in [Movie] menu
- *11 Fixed to
- *12 Fixed to for individual pictures, and fixed to for composite images.
- *13 Fixed to for individual pictures, and fixed to for composite 3 images.
- *14 Fixed to /
- *15 Fixed to
- *16 Fixed to
- *17 Fixed to (Best) equivalent
- *18 Fixed to (Better)
- *19 Fixed to **AWB**
- *20 Fixed to (Multi)
- *21 (Automatic Tracking AF) is not available
- *22 Fixed to (On)
- *23 Fixed to (Multi-segment metering)
- *24 Fixed to AUTO
- *25 The sensitivity is fixed at its minimum setting
- *26 Fixed at 125-800
- *27 Fixed at 125-6400
- *28 Fixed at ± 0.0
- *29 Fixed as normal
- *30 Not available when the Macro Light is (On)
- *31 Only Self-portrait Assist is available.
- *32 Fixed to

Messages















Messages such as the following may appear on the display during camera operation.

Message	Description
Battery depleted	The battery is exhausted. Charge the battery using the battery charger (p.33).
Memory card full	The SD Memory Card is full and no more images can be saved.
The card memory is not enough to copy images/sounds	Insert a new SD Memory Card or delete unwanted images. (p.39, p.135) Change the recorded pixels or quality level of recorded images and try again (p.143).
Memory card error	Shooting and playback are impossible due to a problem with the SD Memory Card. You may be able to display or copy the images on the card using a computer.
The built-in memory is not formatted	The data within the built-in memory are damaged. Format the built-in memory.
Card is not formatted	The SD Memory Card you have inserted is unformatted or has been formatted on a computer or other device and is not compatible with this camera. Format the SD Memory Card in the camera (p.174).
Card is locked	The SD Memory Card is write-protected (p.7).
Compression error	This message occurs when the camera fails to compress an image. Change the quality level or recorded pixels of the image and try shooting or saving it again.
No image/sound	There are no image or sound files on the SD Memory Card or the built-in memory.
Movie recording stopped	This message appears when the internal temperature of the camera has exceeded normal operating limits while recording a movie.
Deleting	This message appears when deleting an image or sound file.
Camera cannot play this image and sound	You are trying to play back an image or sound in a format not supported by this camera. You may be able to play it back on another brand of camera or on your computer.
Image folder cannot be created	The largest file number (9999) has been assigned to an image in the largest folder number (999) and no more images can be saved. Insert a new SD Memory Card or format the card/built-in memory (p.174).
Protected	The image or sound file you are trying to delete is protected.

Message	Description
Data being recorded	Displayed when you try to switch to  mode while an image is still being recorded, or when the protect setting or DPOF setting is being changed. It disappears after the image is recorded or the setting is changed.
Data being processed	Displayed when the camera takes more than five seconds to display an image due to image processing, or when the SD Memory Card or the built-in memory is being formatted.
Built-in memory full	Displayed if the built-in memory is full when saving a file.
No image to be processed	Displayed when there are no images or sound files.
This image/sound cannot be processed	Displayed for files that cannot be processed.
No card in the camera	Displayed if no SD Memory Card is inserted when "Image/Sound Copy" is selected from the Playback Mode Palette and the OK button is pressed.
The built-in memory is not enough to copy images/sounds	Displayed when there is insufficient built-in memory to perform copying.
Cannot process correctly	Displayed when Red-eye Compensation processing fails.
Not enough battery power remaining to activate Pixel Mapping	Displayed when the battery is too low during Pixel Mapping. Change the battery (p.34) or use the AC adapter kit K-AC117 (optional) (p.37).
No more images can be selected	Displayed when you select more than the maximum number of images.
The camera will turn off to prevent damage from overheating	Appears when the temperature inside the camera exceeds the highest limit.
Not enough battery power remaining to complete the requested operation	Displayed when the battery does not have enough power for positioning, recording, saving, or discarding logs.

Troubleshooting

Problem	Cause	Remedy
The camera will not turn on	The battery is not installed	Check if a battery is installed. If not, install a battery.
	The battery is installed incorrectly	Check orientation of the battery. Reinsert the battery according to the ⊕ ⊖ symbols in the battery compartment (p.34).
	The battery is exhausted	Charge the battery.
No image appears on the display	The camera is connected to a computer	The display is off when the camera is connected to a computer.
	The camera is connected to a TV	The display is off when the camera is connected to a TV.
	The display is set to off.	Press the OK/DISPLAY button to turn the display on.
The display is hard to see	The brightness level of the display is set too dark	Adjust the brightness level in [Brightness Level] in the [Setting] menu. (p.189)
	Power Saving function is on	When the Power Saving function is on, the display automatically darkens after a certain amount of time. Press a button to return to the normal brightness level. Select [Off] in [Power Saving] in the [Setting] menu to turn the Power Saving function off (p.190).
The shutter will not release	The flash is charging	Pictures cannot be taken while the flash is charging. Wait until charging is finished.
	There is no available space on the SD Memory Card or in the built-in memory	Insert an SD Memory Card with available space or delete unwanted images (p.39, 135).
	Recording	Wait until recording is finished.
The picture is dark when using the flash	The subject is too far away in a dark environment, such as a night scene	The picture becomes dark if the subject is too far away. Take pictures within the specified flash range.

Problem	Cause	Remedy
The subject is not in focus	The subject is difficult to focus on with autofocus	Lock the focus on an object the same distance away as the subject (by pressing and holding the shutter release button halfway), then aim the camera at your subject and press the shutter release button fully (p.62). Or set the focus manually (p.92).
	The subject is not in the focusing area	Locate the desired subject in the focus frame (focusing area) in the center of the display. If it is difficult to do so, first lock the focus on the desired subject (focus lock), and then move the camera to recompose.
The flash does not discharge	The flash mode is set to  (Flash Off)	Set to  (Auto) or  (Flash On) (p.90).
	The Drive Mode is set to  ,  , or  ; the Focus Mode is set to  (Infinity); or the Shooting Mode is set to  ,  ,  ,  ,  ,  (Interval Movie) or  (High Speed Movie).	The flash does not discharge in these modes.



Very occasionally, static electricity may cause camera to malfunction. In this case, remove the battery and install it again. If the camera is then working properly, you can continue using the camera.

Default Settings

The table below lists the factory default settings.

The meaning of the indications for menu items with a default setting is explained below.

Last Memory Setting





- Yes : The current setting (last memory) is saved when the camera is turned off.
- No : The setting returns to the default setting when the camera is turned off.
- * : The setting depends on the [Memory] setting (p.120).
- : N/A

Reset Setting

- Yes : The setting returns to the default setting with the Reset function (p.194).
- No : The setting is saved even after reset.
- : N/A

● [📷 Rec. Mode] Menu Items



Item		Default Setting (Shooting mode: P)	Last Memory Setting	Reset Setting	Page
Image Tone		Bright	Yes	Yes	p.95
Recorded Pixels		12M (4608×2592)	Yes	Yes	p.96
Quality Level		★★ (Better)	Yes	Yes	p.97
White Balance		AWB (Auto)	*	Yes	p.98
AF Setting	Focusing Area	[] (Multiple)	Yes	Yes	p.93
	Auto Macro	<input checked="" type="checkbox"/> (On)	Yes	Yes	p.94
	Focus Assist	<input checked="" type="checkbox"/> (On)	Yes	Yes	p.94
AE Metering		☉ (Multi-segment)	*	Yes	p.99
Sensitivity		AUTO (125-1600)	*	Yes	p.100
AUTO ISO Range		125-1600	*	Yes	p.101
EV Compensation		±0.0	*	Yes	p.101
D-Range Setting	Highlight Correction	<input type="checkbox"/> (Off)	Yes	Yes	p.102
	Shadow Correction	<input type="checkbox"/> (Off)	Yes	Yes	p.102
Pixel Track SR		<input type="checkbox"/> (Off)	Yes	Yes	p.103
Blink Detection		<input checked="" type="checkbox"/> (On)	Yes	Yes	p.104
Digital Zoom		<input checked="" type="checkbox"/> (On)	*	Yes	p.65
Instant Review		<input checked="" type="checkbox"/> (On)	Yes	Yes	p.104

Item		Default Setting (Shooting mode: P)	Last Memory Setting	Reset Setting	Page
Memory	Face Detection	<input type="checkbox"/> (Off)	Yes	Yes	p.120
	Flash Mode	<input checked="" type="checkbox"/> (On)	Yes	Yes	
	Drive Mode	<input type="checkbox"/> (Off)	Yes	Yes	
	Focus Mode	<input type="checkbox"/> (Off)	Yes	Yes	
	Zoom Position	<input type="checkbox"/> (Off)	Yes	Yes	
	MF Position	<input type="checkbox"/> (Off)	Yes	Yes	
	White Balance	<input type="checkbox"/> (Off)	Yes	Yes	
	Sensitivity	<input type="checkbox"/> (Off)	Yes	Yes	
	EV Compensation	<input type="checkbox"/> (Off)	Yes	Yes	
	AE Metering	<input type="checkbox"/> (Off)	Yes	Yes	
	Digital Zoom	<input checked="" type="checkbox"/> (On)	Yes	Yes	
	DISPLAY	<input type="checkbox"/> (Off)	Yes	Yes	
File No.	<input checked="" type="checkbox"/> (On)	Yes	Yes		
Green Button	Green Mode	Yes	Yes	p.105	
Sharpness	 (Normal)	Yes	Yes	p.108	
Saturation	 (Normal)	Yes	Yes	p.108	
Tone Adjustment	 (B&W)	Yes	Yes	p.108	
Contrast	 (Normal)	Yes	Yes	p.109	
Date Imprint	Off	Yes	Yes	p.109	
IQ Enhancer	<input checked="" type="checkbox"/> (On)	Yes	Yes	p.110	
Macro Light	<input type="checkbox"/> (Off)	Yes	Yes	p.110	

● [Movie] Menu Items

Item	Default Setting	Last Memory Setting	Reset Setting	Page
Recorded Pixels	 (1920×1080·30fps)	Yes	Yes	p.115
Movie SR	<input checked="" type="checkbox"/> (On)	Yes	Yes	p.116

● [ Setting] Menu Items



Item		Default Setting	Last Memory Setting	Reset Setting	Page
Sound	Operation Volume	3	Yes	Yes	p.175
	Playback Volume	3	Yes	Yes	
	Start-up Sound	Off	Yes	Yes	
	Shutter Sound	1	Yes	Yes	
	Operation Sound	1	Yes	Yes	
	Self-timer Sound	1	Yes	Yes	
Date Adjustment	Date Format (date)	According to initial setting	Yes	No	p.46 p.176
	Date Format (time)	24h	Yes	No	
	Date	1/1/2012	Yes	No	
	Time	According to initial setting	Yes	No	
Alarm	Alarm	Off	Yes	Yes	p.178
	Time	0:00	Yes	Yes	
World Time	Select Time	 Hometown	Yes	Yes	p.180
	Destination (City)	According to initial setting	Yes	No	
	Destination (DST)	<input type="checkbox"/> (Off)	Yes	No	
	Hometown (City)	According to initial setting	Yes	No	
	Hometown (DST)	<input type="checkbox"/> (Off)	Yes	No	
Text Size		Standard	Yes	No	p.182
Language/ 言語		According to initial setting	Yes	No	p.43 p.182
Folder Name		Date	Yes	Yes ^{*1}	p.183
File Name		IMGP	Yes	Yes	p.185
USB Connection		MSC	Yes	Yes	p.202
Video Out		According to initial setting	Yes	No	p.187
HDMI Out		Auto	Yes	Yes	p.188
Eye-Fi		<input type="checkbox"/> (Off)	Yes	Yes	p.189
Brightness Level		 (Normal)	Yes	Yes	p.189
Power Saving		5 sec.	Yes	Yes	p.190
Auto Power Off		3 min.	Yes	Yes	p.190
Quick Zoom		<input type="checkbox"/> (Off)	Yes	Yes	p.191
Guide Display		<input checked="" type="checkbox"/> (On)	Yes	Yes	p.191
Reset		Cancel	—	—	p.194
Delete All		Cancel	—	—	p.137
Pixel Mapping		Cancel	—	—	p.192

Item		Default Setting	Last Memory Setting	Reset Setting	Page	
Startup Shortcut	Playback Mode	<input checked="" type="checkbox"/> (On)	Yes	Yes	p.194	
	LED Lighting	<input checked="" type="checkbox"/> (On)	Yes	Yes	p.194	
	Clock Display	<input checked="" type="checkbox"/> (On)	Yes	Yes	p.194	
Format		Cancel	—	—	p.174	
GPS*2	GPS On/Off		Off	Yes	Yes	GPS Guide
	GPS Logging	Record log	Logging Interval: 15 sec. Logging Duration: 1 hr.	Yes	Yes	
		Save log data	Save	—	—	
		Discard log data	Cancel	—	—	
	GPS Time Sync		Off	Yes	Yes	

*1 Except the folder name that you created











*2 Optio WG-2 GPS only

● Playback Mode Palette Items

Item		Default Setting	Last Memory Setting	Reset Setting	Page
Slideshow	Interval	3 sec.	Yes	Yes	p.129
	Screen Effect	Wipe	Yes	Yes	
	Sound Effect	<input checked="" type="checkbox"/> (On)	Yes	Yes	
Image Rotation		Normal	—	—	p.131
Small Face Filter		Approx. 7%	No	No	p.145
Ink Rubbing Filter		 (Standard)	No	No	p.148
Collage	Recorded Pixels		Yes	Yes	p.149
	Layout		Yes	Yes	
	Background	White	Yes	Yes	
	Select image(s)	—	—	—	
Digital Filter		B&W/Sepia	No	—	p.146
HDR Filter		—	—	—	p.148
Original Frame	Blur	All sides/White	No	—	p.156
	Edge Composite	All sides/White	No	—	
Frame Composite		Default 1	Yes	Yes	p.153
Movie Editing	Save as Still Image	—	—	—	p.160
	Divide Movies	—	—	—	
	Adding title picture	—	—	—	

Item		Default Setting	Last Memory Setting	Reset Setting	Page
Red-eye Compensation		—	—	—	p.152
Resize	Recorded Pixels	Depending on the picture taken	—	—	p.143
	Quality Level	Depending on the picture taken	—	—	p.143
Cropping		Depending on the picture taken	—	—	p.144
Image/Sound Copy		Built-in memory → SD Memory Card	—	—	p.163
Voice Memo		—	—	—	p.171
Protect	Single Image/Sound	Depending on the recorded image/sound	—	—	p.138
	All Images/Sounds	Depending on the recorded image/sound	—	—	
DPOF	Single Image	Copies: 0	—	—	p.165
	All Images	Date: □ (Off)	—	—	
Start-up Screen		Default 1	Yes	Yes	p.193

● Key Operation

Item	Function	Default Setting	Last Memory Setting	Reset Setting	Page
 button	Operation Mode	 Mode	—	—	—
W/T button	Zoom Position	Full wide-angle	*	No	p.63
Four-way controller	 Drive Mode	<input type="checkbox"/> (Standard)	*	Yes	p.81 - p.84
	 Shooting Mode	 (Auto Picture)	Yes	Yes	p.65
	 Flash Mode	 (Auto)	*	Yes	p.90
	 Focus Mode	AF (Standard)	*	Yes	p.91
MENU button	Menu Display	Shooting mode:  [Rec. Mode] menu Playback mode:  [Setting] menu	—	—	p.53
OK/DISPLAY button	Information Display	Standard	*	Yes	p.25
 button	Operation Mode	Face Detection On	*	Yes	p.69
Green Button	Function Recall	Green Mode	Yes	Yes	p.73

List of World Time Cities

City: indicates cities that can be set as either the Initial Setting (p.43) or the World Time (p.180).

Video Output Format: indicates the video output format of the city set as the Initial Setting.

Region	City name	Video output format	Region	City name	Video output format	
North America	Honolulu	NTSC	Africa/West Asia	Istanbul	PAL	
	Anchorage	NTSC		Cairo	PAL	
	Vancouver	NTSC		Jerusalem	PAL	
	San Francisco	NTSC		Nairobi	PAL	
	Los Angeles	NTSC		Jeddah	PAL	
	Calgary	NTSC		Tehran	PAL	
	Denver	NTSC		Dubai	PAL	
	Chicago	NTSC		Karachi	PAL	
	Miami	NTSC		Kabul	PAL	
	Toronto	NTSC		Male	PAL	
	New York	NTSC		Delhi	PAL	
Halifax	NTSC	Colombo		PAL		
Central and South America	Mexico City	NTSC		Kathmandu	PAL	
	Lima	NTSC		Dacca	PAL	
	Santiago	NTSC		East Asia	Yangon	NTSC
	Caracas	NTSC			Bangkok	PAL
	Buenos Aires	PAL			Kuala Lumpur	PAL
	Sao Paulo	PAL			Vientiane	PAL
Rio de Janeiro	NTSC	Singapore	PAL			
Europe	Lisbon	PAL	Phnom Penh		PAL	
	Madrid	PAL	Ho Chi Minh		PAL	
	London	PAL	Jakarta		PAL	
	Paris	PAL	Hong Kong		PAL	
	Amsterdam	PAL	Beijing		PAL	
	Milan	PAL	Shanghai		PAL	
	Rome	PAL	Manila		NTSC	
	Copenhagen	PAL	Taipei		NTSC	
	Berlin	PAL	Seoul		NTSC	
	Prague	PAL	Tokyo		NTSC	
	Stockholm	PAL	Guam	NTSC		
	Budapest	PAL	Oceania	Perth	PAL	
	Warsaw	PAL		Adelaide	PAL	
	Athens	PAL		Sydney	PAL	
	Helsinki	PAL		Noumea	PAL	
	Moscow	PAL		Wellington	PAL	
	Africa/West Asia	Dakar		PAL	Auckland	PAL
Algiers		PAL		Pago Pago	NTSC	
Johannesburg		PAL				

Optional Accessories

A number of dedicated accessories are available for this camera. Products marked with an asterisk (*) are the same as those supplied with the camera.

- **Power supply**

- Rechargeable lithium-ion battery D-LI92 (*)**

- Battery charger kit K-BC92 (*)**

- (Battery charger D-BC92, AC plug cord)

- AC adapter kit K-AC117**

- (AC adapter D-AC115, DC coupler D-DC92, AC plug cord)

- The battery charger and AC adapter are only sold as a set.

- **Cable**

- USB cable I-USB7 (*)**

- AV cable I-AVC7**

- **Strap**

- O-ST124 (*)**

- O-ST125 (*)**

- O-ST24** Genuine leather strap.

- O-ST8** Silver chain strap.

- O-ST81** Waterproof strap.

- **Camera case**

- O-CC118**

- **Remote Control**

- REMOTE CONTROL WATERPROOF O-RC1**

- REMOTE CONTROL E**

- REMOTE CONTROL F**

Main Specifications

Type	Digital compact camera
Number of Effective Pixels	Approx. 16 megapixels
Image Sensor	1/2.3 inch CMOS
Number of Recorded Pixels	Still 16M (4608×3456), 12M 16M (3456×3456), 12M 1639 (4608×2592), 7M (3072×2304), 5M 1639 (3072×1728), 5M (2592×1944), 4M 1639 (2592×1464), 3M (2048×1536), 2M 1639 (1920×1080), 1024 (1024×768), 640 (640×480) * Fixed at 3M / 2M 1639 in Frame Composite mode. * Fixed at 5M in Digital Wide mode, however, the first frame uses 3M . * Fixed at 2M for one frame in Digital Panorama mode. * Fixed at 2M 1639 in Digital Microscope mode. * Fixed at 5M / 4M 1639 in Burst Shooting mode. * Fixed at 1280 (1280×960) in Report mode.
	Movie 1920 (1920×1080/30fps), 1280 (1280×720/60fps) 1280 (1280×720/30 fps), 640 (640×480/30 fps)
Sensitivity	AUTO, Manual (ISO 125, 200, 400, 800, 1600, 3200, 6400) * The sensitivity is fixed at AUTO (125-6400) in Digital SR mode.
File Format	Still JPEG (Exif 2.3), DCF 2.0, DPOF, PRINT Image Matching III Movie MPEG-4 AVC/H.264, approx. 60 fps/30 fps, PCM system, monaural sound, Movie SR (Movie Shake Reduction) Sound Voice memo, Voice recording: WAVE (PCM) system, monaural
Quality Level	Still ★★★ "Best", ★★ "Better", ★ "Good" Movie Fixed at ★★★ (Best) *Unchangeable
Storage Media	Built-in memory (approx. 88.2 MB), SD Memory Card, SDHC Memory Card, SDXC Memory Card

Approximate Image Storage Capacity and Recording Time
Still

	Built-in Memory			2 GB SD Memory Card		
	★★★	★★	★	★★★	★★	★
16M (4608×3456)	17 pictures	30 pictures	49 pictures	370 pictures	653 pictures	1078 pictures
12M 12M (3456×3456)	20 pictures	39 pictures	60 pictures	435 pictures	853 pictures	1307 pictures
12M 12M (4608×2592)	20 pictures	39 pictures	60 pictures	435 pictures	853 pictures	1307 pictures
7M (3072×2304)	30 pictures	55 pictures	89 pictures	653 pictures	1205 pictures	1921 pictures
5M 5M (3072×1728)	35 pictures	68 pictures	99 pictures	778 pictures	1499 pictures	2119 pictures
5M (2592×1944)	35 pictures	68 pictures	99 pictures	778 pictures	1499 pictures	2119 pictures
4M 4M (2592×1464)	47 pictures	89 pictures	128 pictures	1024 pictures	1921 pictures	2794 pictures
3M (2048×1536)	55 pictures	110 pictures	161 pictures	1205 pictures	2364 pictures	3415 pictures
2M 2M (1920×1080)	81 pictures	148 pictures	217 pictures	1756 pictures	3235 pictures	4728 pictures
1280 (1280×960)	128 pictures	235 pictures	332 pictures	2794 pictures	5122 pictures	6830 pictures
1024 (1024×768)	194 pictures	332 pictures	434 pictures	4098 pictures	6830 pictures	8782 pictures
640 (640×480)	403 pictures	627 pictures	706 pictures	8782 pictures	12294 pictures	15368 pictures

- The image storage capacity is for reference only. The actual image storage capacity may vary depending on the SD Memory Card and the subject.
- **1280** (1280×960) can only be set for recorded pixels when  (Report) mode is set.

Movie/Sound

	Built-in Memory	2 GB SD Memory Card
1920 (1920×1080/30 fps)	44 sec.	16 min. 59 sec.
1280 (1280×720/60 fps)	44 sec.	16 min. 42 sec.
1280 (1280×720/30 fps)	1 min. 12 sec.	27 min. 24 sec.
640 (640×480/30 fps)	3 min. 7 sec.	1 hr. 10 min. 58 sec.
Sound	24 min. 5 sec.	8 hr. 44 min. 34 sec.

- The above figures are based on our standard shooting conditions and may vary depending on the subject, shooting conditions and type of the SD Memory Card used.
- The maximum length of continuous recording time for a movie is 25 minutes.

White Balance	Auto, Daylight, Shade, Tungsten Light, Fluores. Light, Manual	
Lens	Focal Length	5.0 - 25.0 mm (approx. 28 mm - 140 mm in 35 mm equivalent focal length)
	Aperture	F3.5 (W) - F5.5 (T)
	Lens Composition	11 elements in 9 groups (5 aspherical elements)
	Zoom Type	Electrically driven
Optical Zoom	5×	
Intelligent Zoom	$\frac{7M}{5M}$: approx. 7.5×, $\frac{5M}{4M}$: approx. 8.9×, $\frac{3M}{1024}$: approx. 11.3×, $\frac{2M}{160}$: approx. 12×, $\frac{1024}{640}$: approx. 22.5×, $\frac{640}{160}$: approx. 36× (when combined with optical zoom)	
Digital Zoom	Max. approx. 7.2× (combines with 5× optical zoom to give zoom magnification equivalent to 36×)	
Motion Blur Reduction	Still	Electronic Shake Reduction (Pixel Track SR), Hi-sensitivity Shake Reduction (Digital SR)
	Movie	Electronic Movie Shake Reduction (Movie SR)
Display	3.0 inch wide-LCD, Wide viewing angle, approx. 460,000 dots (AR coating (cover only))	
Playback Modes	Single-frame, 6-frame, 12-frame, Enlargement (max. 10×, scrollable), Face close-up playback, Pet close-up playback, Folder Display, Calendar Display, Sound Playback, Histogram Display, Bright and Dark Area Compensation, Select & Delete, Slideshow, Resize, Cropping, Image/Sound Copy, Image Rotation, Digital Filter, HDR Filter, Original Frame, Ink Rubbing Filter, Collage, Small Face Filter, Movie Playback/Edit (Save as Still image, Divide, Adding title picture), Frame Composite, Red-eye Compensation, Voice Memo, Protect, DPOF, Start-up Screen	
Focus Mode	Autofocus, Macro, 1cm Macro, Pan Focus, Infinity, Manual Focus	
Focus	Type	TTL contrast detection system by sensor Multiple (9-point autofocus)/spot/automatic tracking AF changeable
	Focus range (From lens face)	Standard : 0.5 m - ∞ (Full zoom range)
		Macro : 0.1 m - 0.6 m (Full zoom range)
		1cm Macro : 0.01 m - 0.3 m (At the intermediate position of the zoom range)
* It is possible to switch to Infinity, Pan Focus and Manual Focus.		
* Face Detection AF is available only when the camera recognizes the subject's face.		
Focus Lock	By half-pressing the shutter release button	

Exposure Control	AE Metering	Multi-segment metering, Center-weighted metering, Spot metering
	EV Compensation ± 2 EV (can be set in 1/3 EV steps)	
Face Detection	Detection of up to 32 people's faces (up to 31 face detection frames on the display), Smile Capture, Blink Detection, Self-portrait Assist, Self-portrait Assist + Smile Capture * Face Detection AE is available only when the camera detects the subject's face.	
Pet Detection	Registering: 3, Detecting: 1	
Shooting Mode	Auto Picture, Program, Night Scene, Movie, Underwater Movie, High Speed Movie, Interval Movie, Digital Microscope, Landscape, Flower, Portrait, Underwater, Interval Shot, Handheld Night Snap, Digital SR, Surf & Snow, Kids, Pet, Sport, Candlelight, Fireworks, Night Scene Portrait, Text, Food, Digital Wide, Digital Panorama, Frame Composite, Report, Green Mode, Voice Recording (can be used when Fn Setting assigned)	
Digital Filter	B&W/Sepia, Toy Camera, Retro, Color (red, pink, purple, blue, green, yellow), Extract Color (red, green, blue), Color Emphasis (Sky Blue, Fresh Green, Delicate Pink, Autumn Leaves), High Contrast, Starburst (Cross, Heart, Star), Soft, Fish-eye, Brightness, Miniature	
Movie	Continuous Recording Time	Approx. 1 second - 25 minutes (however, only until the built-in memory or SD Memory Card is full)
Shutter Speed	1/4000 sec. - 1/4 sec. (mechanical and electronic shutter), max. 4 sec. (Night Scene mode)	
Built-in Flash	Modes	Auto, Flash Off, Flash On, Auto + Red-eye, Flash On + Red-eye
	Flash Range	Wide-angle: approx. 0.2 m - 5.5 m (approx. 0.66 ft - 18 ft) (Sensitivity: in Auto condition) Telephoto: approx. 0.2 m - 3.5 m (approx. 0.66 ft - 11 ft) (Sensitivity: in Auto condition)
Drive Mode	Single-frame, Self-timer, Continuous Shooting, Burst Shooting, Remote Control, Auto Bracketing	
Self-timer	Electronic control type, control time: Approx. 10 sec., 2 sec.	
Time Function	World Time	75 cities (28 time zones)
	Clock Display	Clock display by holding down OK/DISPLAY button while camera is turned off (approx. 10 sec.)
	Alarm	Alarm with simultaneous display of the Clock display at specified time
Power Source	Rechargeable lithium-ion battery D-LI92, AC adapter kit (optional)	

Battery Life	Image Storage Capacity Approx. 260 pictures	* Recording capacity shows approximate number of shots recorded during CIPA-compliant testing (with display on, flash used for 50% of the shots, and 23°C or 73.4°F). Actual performance may vary according to operating conditions.
	Playback Time Approx. 240 min.	* According to the results of in-house testing.
	Movie Recording Time Approx. 70 min.	* According to the results of in-house testing.
	Sound Recording Time Approx. 270 min.	* According to the results of in-house testing.
Interfaces	USB 2.0 (high-speed compatible) /PC/AV terminal / HDMI terminal (Type D (Micro))	
Video Output Format	NTSC/PAL (monaural)	
Waterproof and Dustproof Rating	JIS waterproof grade 8 and JIS dustproof grade 6 (IP68) Continuous underwater picture-taking possible for 2 hours at depth of 12 m.	
Impact Resistance Rating	PENTAX drop test (1.5 m height onto a 5 cm thick plywood surface) complying with MIL-Standard 810F Method 516.5-Shock testing. * Waterproof performance is not guaranteed if the camera is exposed to impact such as being dropped or hit. * The camera is not guaranteed to be free of trouble or damages under every condition.	
Dimensions	Approx. 122.5 (W) × 61.5 (H) × 29.5 (D) mm (excluding operating or protruding parts)	
Weight	Optio WG-2 GPS: Approx. 177g (excluding battery and SD Memory Card) Approx. 198g (including battery and SD Memory Card) Optio WG-2: Approx. 173g (excluding battery and SD Memory Card) Approx. 194g (including battery and SD Memory Card)	
Accessories	Rechargeable lithium-ion battery, Battery charger, AC plug cord, USB cable, Software (CD-ROM), Carabiner strap, Macro stand, Operating Manual, Quick Guide, Utilities Guide for GPS (Optio WG-2 GPS only)	

Warranty Policy

All PENTAX cameras purchased through authorized bona fide photographic distribution channels are guaranteed against defects of material or workmanship for a period of twelve months from date of purchase. Service will be rendered, and defective parts will be replaced without cost to you within that period, provided the equipment does not show evidence of impact, sand or liquid damage, mishandling, tampering, battery or chemical corrosion, operation contrary to operating instructions, or modification by an unauthorized repair shop. The manufacturer or its authorized representatives shall not be liable for any repair or alterations except those made with its written consent and shall not be liable for damages from delay or loss of use or from other indirect or consequential damages of any kind, whether caused by defective material or workmanship or otherwise; and it is expressly agreed that the liability of the manufacturer or its representatives under all guarantees or warranties, whether expressed or implied, is strictly limited to the replacement of parts as hereinbefore provided. No refunds will be made on repairs by non-authorized PENTAX service facilities.

Procedure During 12-month Warranty Period

Any PENTAX which proves defective during the 12-month warranty period should be returned to the dealer from whom you purchased the equipment or to the manufacturer. If there is no representative of the manufacturer in your country, send the equipment to the manufacturer, with postage prepaid. In this case, it will take a considerable length of time before the equipment can be returned to you owing to the complicated customs procedures required. If the equipment is covered by warranty, repairs will be made and parts replaced free of charge, and the equipment will be returned to you upon completion of servicing. If the equipment is not covered by warranty, regular charges of the manufacturer or of its representatives will apply. Shipping charges are to be borne by the owner. If your PENTAX was purchased outside of the country where you wish to have it serviced during the warranty period, regular handling and servicing fees may be charged by the manufacturer's representatives in that country. Notwithstanding this, your PENTAX returned to the manufacturer will be serviced free of charge according to this procedure and warranty policy. In any case, however, shipping charges and customs clearance fees to be borne by the sender. To prove the date of your purchase when required, please keep the receipt or bills covering the purchase of your equipment for at least a year. Before sending your equipment for servicing, please make sure that you are sending it to the manufacturer's authorized representatives or their approved repair shops, unless you are sending it directly to the manufacturer. Always obtain a quotation for the service charge, and only after you accept the quoted service charge, instruct the service station to proceed with the servicing.

- This warranty policy does not affect the customer's statutory rights.
- The local warranty policies available from PENTAX distributors in some countries can supersede this warranty policy. Therefore, we recommend that you review the warranty card supplied with your product at the time of purchase, or contact the PENTAX distributor in your country for more information and to receive a copy of the warranty policy.



The CE Mark is a Directive conformity mark of the European Union.

For customers in USA

STATEMENT OF FCC COMPLIANCE

This device complies with Part 15 of the FCC Rules. Operation is subject to the following two conditions: (1) This device may not cause harmful interference, and (2) this device must accept any interference received, including interference that may cause undesired operation.

Changes or modifications not approved by the party responsible for compliance could void the user's authority to operate the equipment.

This equipment has been tested and found to comply with the limits for a Class B digital device, pursuant to part 15 of the FCC Rules.

These limits are designed to provide reasonable protection against harmful interference in a residential installation. This equipment generates, uses and can radiate radio frequency energy and, if not installed and used in accordance with the instructions, may cause harmful interference to radio communications.

However, there is no guarantee that interference will not occur in a particular installation.

If this equipment does cause harmful interference to radio or television reception, which can be determined by turning the equipment off and on, the user is encouraged to try to correct the interference by one or more of the following measures:

- Reorient or relocate the receiving antenna.
- Increase the separation between the equipment and receiver.
- Connect the equipment into an outlet on a circuit different from that to which the receiver is connected.

*Consult the dealer or an experienced radio/TV technician for help.

For customers in Canada

This Class B digital apparatus complies with Canadian ICES-003.

Pour les utilisateurs au Canada

Cet appareil numérique de la classe B est conforme à la norme NMB-003 du Canada.

FOR CALIFORNIA, U.S.A. ONLY

Perchlorate Material-special handling may apply. The lithium battery used in this camera contains perchlorate material, which may require special handling. See www.dtsc.ca.gov/hazardouswaste/perchlorate

Declaration of Conformity
According to 47CFR, Parts 2 and 15 for
Class B Personal Computers and Peripherals

We: PENTAX RICOH IMAGING AMERICAS CORPORATION

Located at: 633 17th Street, Suite 2600,
Denver, Colorado 80202, U.S.A.
Phone: 800-877-0155 Fax: 303-790-1131

Declare under sole responsibility that the product identified herein complies with 47CFR Parts 2 and 15 of the FCC rules as a Class B digital device. Each product marketed is identical to the representative unit tested and found to be compliant with the standards. Records maintained continue to reflect the equipment being produced can be expected to be within the variation accepted, due to quantity production and testing on the statistical basis as required by 47CFR §2.909. Operation is subject to the following two conditions: (1) This device may not cause harmful interference, and (2) This device must accept any interference received, including interference that may cause undesired operation. The above named party is responsible for ensuring that the equipment complies with the standards of 47CFR §15.101 to §15.109.

Product Name: Digital Camera

Model Number: Optio WG-2 GPS / Optio WG-2

Contact person: Customer Service Manager

Date and Place: February, 2012, Colorado

Information for Users on Collection and Disposal of Old Equipment and Used Batteries



1. In the European Union

These symbols on the products, packaging and/or accompanying documents mean that used electrical and electronic equipments and batteries should not be mixed with general household waste.

Used electrical/electronic equipments and batteries must be treated separately and in accordance with legislation that requires proper treatment, recovery and recycling of these products.



By disposing of these products correctly you will help ensure that the waste undergoes the necessary treatment, recovery and recycling and thus prevent potential negative effects on the environment and human health which could otherwise arise due to inappropriate waste handling.

If a chemical symbol is added beneath the symbol shown above, in accordance with the Battery Directive, this indicates that a heavy metal (Hg = Mercury, Cd = Cadmium, Pb = Lead) is present in the battery at a concentration above an applicable threshold specified in the Battery Directive.

For more information about collection and recycling of used products, please contact your local authorities, your waste disposal service or the point of sale where you purchased the products.

2. In other countries outside the EU

These symbols are only valid in the European Union. If you wish to discard used products, please contact your local authorities or dealer and ask for the correct method of disposal.

For Switzerland: Used electrical/electronic equipment can be returned free of charge to the dealer, even when you don't purchase a new product. Further collection facilities are listed on the home page of www.swico.ch or www.sens.ch.

Symbols

Mode	16, 52
button	49, 51
Mode	16, 52
button	48, 50
[Rec. Mode] Menu	55, 227
[Movie] Menu	57, 228
[Setting] Menu	57, 229
Green Mode	73
Delete	122, 135
button	50
Magnify	132
T Tele	63
W Wide	63
W/T button	48
Movie	113
Pet	74
Text	77
Digital Wide	85
Digital Panorama	87
Landscape	67
Flower	67
Underwater	111
Underwater Movie	111
Food	68
Report	68
Digital Microscope	77
Frame Composite	78
Handheld Night Snap	67
Interval Shot	79
Interval Movie	116
High Speed Movie	119

Numerics

1cm Macro	91
6-Image Display/	
12-Image Display	124

A

AC adapter	37
Adding sound (Voice Memo)	171
AE Metering	99
Alarm	178
Auto + Red-eye (Flash)	90
Auto Bracketing	84
AUTO ISO Range	101
Auto Macro	94

Auto Power Off	190
Auto AWB (White Balance)	98
Auto (Flash)	90
Automatic Tracking AF	93
AV cable	141

B

B&W/Sepia filter	146
Basic Mode	73
Battery Level Indicator	36
Blink Detection	63, 104
Brightness filter	146
Brightness Level	189
Built-in Memory	163
Burst Shooting	82

C

Calendar display	126
Camera shake	64
Capture Mode Palette	67
Changing volume	175
Charging a battery	33
Checking the Memory Card	41
Clock Display	195
Collage	149
Color emphasis filter	146
Color filter	146
Connecting the Camera to	
AV Equipment	140
Connecting to a TV	140
Continuous Shooting	82
Contrast	109
Copy	163
Cropping	144

D



Date Adjustment	46, 176
Date Imprint	109
Default Settings	227
Delete all	137
Delete	122, 135
Digital Filter	146
Digital Microscope Mode	77
Digital Wide Mode	85
Digital zoom	65
Display brightness	189
Display Language	182

Dividing movies	161
DPOF settings	165
D-Range Setting	102
Drive Mode	79, 81, 82, 84

E

EV Compensation	101
Extract color filter	146
Eye-Fi	189, 218

F

Face Close-up Playback	133
Face Detection	69
File Name	185
Filters	146
Fish-eye filter	146
Flash Mode	90
Flash Off  (Flash)	90
Flash On  (Flash)	90
Flash On + Red-eye  (Flash)	90
Flower	67
Focus Assist	94
Focus Mode	91
Focusing	91
Focusing Area	93
Folder display	125
Folder Name	183
Food	68
Format	174
Four-way controller	48, 51
Frame Composite	78, 153
Frame Rate	115

G

Green button	105
Green button 	49, 51
Green Mode	73
Guide Display	30

H

HDMI	188
HDR Filter	148
High contrast filter	146
Highlight Correction	102
Histogram	31
Hometown	180

I





Image Rotation	131
Image Storage Capacity	235
Image Tone	95

Image/Sound Copy	163
Infinity 	91
Initial Setting	43
Ink Rubbing Filter	148
Installing a battery	34
Installing the software	199
Instant Review	63, 104
Interval Movie Mode	116
Interval Shot	79
IQ Enhancer	110

L

Landscape	67
Language setting	43, 182
LED lighting	194

M

Macintosh	198
Macro 	91
Macro Light	110
Magnify 	132
Manual Focus MF	91
Manual  (White Balance)	99
Mass Storage Class	203
MediaImpression	197
Memory	120
MENU button	49, 51
Miniature filter	146
Movie Editing	160
Movie SR (Movie Shake Reduction) Function	116
MSC	203
Multi-segment metering 	99

N

Number of pixels	96
------------------------	----

O



OK/DISPLAY button	49, 51
Operating the Menus	53
Optional accessory	233
Original Frame	156

P

Pan Focus PF	91
Panoramic Pictures	87
Pet Mode	74
Photo processing lab	165
Picture Transfer Protocol	203
Pixel Mapping	192
Pixel Track SR	103

Playback	122, 123
Playback (sound)	170
Playback (Voice Memo)	172
Playback Mode Palette	128, 230
Playing back movies	123
Power Saving	190
Power switch	41, 48, 50
Press fully (shutter release button)	62
Press halfway (shutter release button)	62
Product registration	201
Protect 	138
Provided software	197
PTP	203

R

Rec. Mode Menu	55, 227
Recorded Pixels	96, 115
Recording movies	113
Red-eye Compensation	152
Red-eye reduction   (Flash)	90
Regarding Waterproof, Dustproof, and Shockproof Design	8
Remote Control Unit	83
Report	68
Reset	194
Resetting settings	194
Resize	143
Retro filter	146
Rotating	131

S

Saturation	108
Saving as still picture (movie)	160
Saving pictures by date	183
Saving settings	120
SD Memory Card	39
Select Time	181
Self-portrait Assist	72
Self-timer 	81
Sensitivity	100
Setting Menu	57, 229
Shadow Correction	102
Sharpness	108
Shooting information	25
Shooting Mode	65
Shutter release button	48, 50, 62
Slideshow	129
Small Face Filter	145
Smile Capture	70
Soft filter	146

Sound settings	175
Sound types	175
Specifications	234
Standard AF	91
Starburst filter	146
Starting-up in Playback Mode	42
Start-up screen	193
Startup Shortcut	194
System requirements	198

T

Taking pictures underwater	111
Text Mode	77
Text Size	182
Title picture of movie	162
Tone Adjustment	108
Toy camera filter	146

U

Underwater Mode	111
Underwater Movie Mode	111
USB Connection	202

V

Video output format	187, 232
Voice Memo	171
Voice Recording	168

W

Waterproof and Dustproof	111
White Balance	98
Windows	198
World Time	180

Z

Zoom W T	63
-----------------------	----

Memo

Memo

Memo

PENTAX RICOH IMAGING CO., LTD.

2-35-7, Maeno-cho, Itabashi-ku, Tokyo 174-8639, JAPAN
(<http://www.pentax.jp>)

PENTAX RICOH IMAGING FRANCE S.A.S. 112 Quai de Bezons, B.P. 204, 95106 Argenteuil Cedex, FRANCE
(European Headquarters) (HQ - <http://www.pentax.eu>)
(France - <http://www.pentax.fr>)

PENTAX RICOH IMAGING DEUTSCHLAND GmbH Julius-Vosseler-Strasse 104, 22527 Hamburg, GERMANY
(<http://www.pentax.de>)

PENTAX RICOH IMAGING UK LTD. PENTAX House, Heron Drive, Langley, Slough, Berks SL3 8PN, U.K.
(<http://www.pentax.co.uk>)

PENTAX RICOH IMAGING AMERICAS CORPORATION 633 17th Street, Suite 2600, Denver, Colorado 80202, U.S.A.
(<http://www.pentaximaging.com>)

PENTAX RICOH IMAGING CANADA INC. 1770 Argentia Road Mississauga, Ontario L5N 3S7, CANADA
(<http://www.pentax.ca>)

<http://www.pentax.jp/english>

- Specifications and external dimensions are subject to change without notice.