

Panasonic®

Basic Owner's Manual Digital Camera

Model No. **DMC-ZS40**

LUMIX



Please read these instructions carefully before using this product, and save this manual for future use.

More detailed instructions on the operation of this camera are contained in "Owner's Manual for advanced features (PDF format)" in the supplied CD-ROM. Install it on your PC to read it.



Register online at www.panasonic.com/register (U.S. customers only)

If you have any questions, visit:
USA and Puerto Rico: www.panasonic.com/support

P



VQT5E54
M1213KZ0

**Dear Customer,
Thank you for choosing Panasonic!**

You have purchased one of the most sophisticated and reliable products on the market today. Used properly, we're sure it will bring you and your family years of enjoyment. Please take time to fill in the information below. The serial number is on the tag located on the underside of your camera. Be sure to **retain this manual** as your convenient camera information source.

Date of Purchase	Dealer Phone No.
Dealer Purchased From	Model No.
Dealer Address	Serial No.

Please note that the actual controls and components, menu items, etc. of your Digital Camera may look somewhat different from those shown in the illustrations in this Owner's Manual.

Carefully observe copyright laws.

- Recording of pre-recorded tapes or discs or other published or broadcast material for purposes other than your own private use may infringe copyright laws. Even for the purpose of private use, recording of certain material may be restricted.



A lithium ion battery that is recyclable powers the product you have purchased. Please call 1-800-8-BATTERY for information on how to recycle this battery.

Information for Your Safety

The socket outlet shall be installed near the equipment and shall be easily accessible.

■ Product identification marking

Product	Location
Digital camera	Bottom

WARNING:

To reduce the risk of fire, electric shock or product damage,

- Do not expose this unit to rain, moisture, dripping or splashing.
- Use only the recommended accessories.
- Do not remove covers.
- Do not repair this unit by yourself. Refer servicing to qualified service personnel.

■ About the AC adaptor (supplied)

CAUTION!

To reduce the risk of fire, electric shock or product damage,

- Do not install or place this unit in a bookcase, built-in cabinet or in another confined space. Ensure this unit is well ventilated.

AC adaptor

This AC adaptor operates on AC between 110V and 240V.

But

- In the U.S.A. and Canada, the AC adaptor must be connected to a 120V AC power supply only.
- When connecting to an AC supply outside of the U.S.A. or Canada, use a plug adaptor to suit the AC outlet configuration.

■ About the battery pack

CAUTION

Battery pack (Lithium ion battery pack)

- Use the specified unit to recharge the battery pack.
- Do not use the battery pack with equipment other than the specified unit.
- Do not get dirt, sand, liquids, or other foreign matter on the terminals.
- Do not touch the plug terminals (+ and -) with metal objects.
- Do not disassemble, remodel, heat or throw into fire.

If any electrolyte should come into contact with your hands or clothes, wash it off thoroughly with water.

If any electrolyte should come into contact with your eyes, never rub the eyes. Rinse eyes thoroughly with water, and then consult a doctor.

CAUTION

- Danger of explosion if battery is incorrectly replaced. Replace only with the type recommended by the manufacturer.
- When disposing of the batteries, please contact your local authorities or dealer and ask for the correct method of disposal.

- Do not heat or expose to flame.
- Do not leave the battery(ies) in a car exposed to direct sunlight for a long period of time with doors and windows closed.

Warning

Risk of fire, explosion and burns. Do not disassemble, heat above 60 °C (140 °F) or incinerate.



FCC Note:

This equipment has been tested and found to comply with the limits for a Class B digital device, pursuant to Part 15 of the FCC Rules. These limits are designed to provide reasonable protection against harmful interference in a residential installation. This equipment generates, uses, and can radiate radio frequency energy and, if not installed and used in accordance with the instructions, may cause harmful interference to radio communications. However, there is no guarantee that interference will not occur in a particular installation. If this equipment does cause harmful interference to radio or television reception, which can be determined by turning the equipment off and on, the user is encouraged to try to correct the interference by one or more of the following measures:

- Reorient or relocate the receiving antenna.
- Increase the separation between the equipment and receiver.
- Connect the equipment into an outlet on a circuit different from that to which the receiver is connected.
- Consult the dealer or an experienced radio/TV technician for help.

FCC Caution: To assure continued compliance, follow the attached installation instructions and use only shielded interface cables with ferrite core when connecting to computer or peripheral devices.

Any changes or modifications not expressly approved by the party responsible for compliance could void the user's authority to operate this equipment.

Declaration of Conformity

Trade Name: Panasonic

Model No.: DMC-ZS40

Responsible Party: Panasonic Corporation of North America
Two Riverfront Plaza, Newark, NJ 07102-5490

Support Contact: <http://www.panasonic.com/contactinfo>

This device complies with Part 15 of the FCC Rules. Operation is subject to the following two conditions: (1) This device may not cause harmful interference, and (2) this device must accept any interference received, including interference that may cause undesired operation.

■ Cautions for Use

- Do not use any other USB connection cables except the supplied one or a genuine Panasonic USB connection cable (DMW-USBC1: optional).
- Always use a genuine Panasonic AV cable (DMW-AVC1: optional).
- Use a “High Speed HDMI micro cable” with the HDMI logo. Cables that do not comply with the HDMI standards will not work.
“High Speed HDMI micro cable” (Type D-Type A plug, up to 2 m (6.6 feet) long)

Keep this unit as far away as possible from electromagnetic equipment (such as microwave ovens, TVs, video games etc.).

- If you use this unit on top of or near a TV, the pictures and/or sound on this unit may be disrupted by electromagnetic wave radiation.
- Do not use this unit near cell phones because doing so may result in noise adversely affecting the pictures and/or sound.
- Recorded data may be damaged, or pictures may be distorted, by strong magnetic fields created by speakers or large motors.
- Electromagnetic wave radiation may adversely affect this unit, disturbing the pictures and/or sound.
- If this unit is adversely affected by electromagnetic equipment and stops functioning properly, turn this unit off and remove the battery or disconnect AC adaptor (supplied). Then reinsert the battery or reconnect AC adaptor and turn this unit on.

Do not use this unit near radio transmitters or high-voltage lines.

- If you record near radio transmitters or high-voltage lines, the recorded pictures and/or sound may be adversely affected.

Certification and Compliance

See Camera for the certification and compliance mark specific to that device.

- 1 Select [Wi-Fi Setup] in the [Wi-Fi] menu**
- 2 Press ▲ ▼ to select [Approved Regulations], and press [MENU/SET]**

Contains FCC ID : VPYLBXN604

This transmitter must not be co-located or operated in conjunction with any other antenna or transmitter.

This equipment complies with FCC radiation exposure limits set forth for an uncontrolled environment and meets the FCC radio frequency (RF) Exposure Guidelines in Supplement C to OET65. This equipment has very low levels of RF energy that are deemed to comply without testing of specific absorption ratio (SAR).

Contents

Information for Your Safety	3	Viewing your pictures	28
Before use	9	Deleting pictures	28
Standard accessories	10	What you can do with the	
Names and Functions of		Wi-Fi® function.....	29
Main Parts	11	GPS functions.....	31
Inserting and removing the		Reading the Owner's Manual	
battery or SD memory card		(PDF format).....	32
(optional)	14	Supplied software.....	33
Charging the battery	15	Copying still pictures and	
Setting the clock.....	17	motion pictures.....	34
Setting the menu	19	Troubleshooting	35
Taking pictures with		Specifications	37
automatic settings		Digital Camera Accessory	
[Intelligent Auto] Mode.....	20	System.....	40
Recording motion pictures...	23	Digital Camera Accessory	
Using the control ring/ control dial	25	Order Form.....	41
Registering preferred		Limited Warranty	
functions to the		(ONLY FOR U.S.A. AND	
[Fn] button.....	27	PUERTO RICO)	42
Taking pictures with the			
composition determined			
[Composition Guide].....	27		

Before use

■ Camera handling

- Keep the camera away from excessive vibration, force, or pressure.
- The camera is not dust resistant, splash resistant, or waterproof. Avoid using the camera in places with excessive dust or sand, or where water can come into contact with the camera.
- Do not allow camera to come into contact with pesticides or volatile substances (can cause surface damage or coating to peel).

■ Condensation (When the lens, the LCD monitor or the viewfinder is fogged up)





- Condensation may occur when the camera is exposed to sudden changes of temperature or humidity. Avoid these conditions, which may make the lens, the LCD monitor or the viewfinder dirty, cause mold, or damage the camera.
- If condensation does occur, turn off the camera and wait about two hours before using it. Once the camera adjusts to the surrounding temperature, the fogging will clear naturally.

■ Caring for your camera

- Before cleaning the camera, remove the battery or disconnect the power plug from the outlet.
- Do not press the LCD monitor with excessive force.
- Do not press the lens with excessive force.
- Do not keep rubber or plastic products in contact with the camera for a long period of time.
- Do not use solvents such as benzene, thinner, alcohol, kitchen detergents, etc., to clean the camera, since it may deteriorate the external case or the coating may peel off.
- Do not leave the camera with the lens facing the sun, as rays of light from the sun may cause it to malfunction.
- Do not extend the supplied cord or cable.
- While the camera is accessing the card or built-in memory (for an operation such as picture writing, reading, deleting, or formatting), do not turn off the camera or remove the battery, card, AC adaptor (supplied).
- The data on the built-in memory or the card may be damaged or lost due to electromagnetic waves, static electricity or breakdown of the camera or the card. We recommend storing important data on a PC etc.
- Do not format the card on your PC or other equipment. Format it on the camera only to ensure proper operation.

Standard accessories

Check that all the accessories are supplied before using the camera. Part numbers are as of January 2014. These may be subject to change.

<input type="checkbox"/> Battery pack DMW-BCM13PP • Charge the battery before use. Battery pack is indicated as battery pack or battery in the text. 	<input type="checkbox"/> USB connection cable K1HY08YY0031 
<input type="checkbox"/> AC adaptor VSK0768 	<input type="checkbox"/> CD-ROM VFF1254 • Software: Use it to install the software on your PC. • Owner's Manual for advanced features 
<input type="checkbox"/> Hand strap VFC4297 	

- SD Memory Card, SDHC Memory Card and SDXC Memory Card are indicated as card in the text.
- **Cards are optional.** You can record or play back pictures on the built-in memory when you are not using a card.
- **Compatible memory cards (optional)**
The following SD standard-based cards (Panasonic brand recommended) can be used.
SD Memory Card (8 MB to 2 GB) / SDHC Memory Card (4 GB to 32 GB) / SDXC Memory Card (48 GB, 64 GB)
- For information about optional accessories, refer to the “Digital Camera Accessory System”.
- If accessories are lost, customers can visit us at www.panasonic.com/support for further information about obtaining replacement parts.
- Please dispose of all packaging appropriately.
- Keep small parts in a safe place out of the reach of children.
- The illustrations and screens in this manual may differ from the actual product.
- SILKYPIX Developer Studio SE is not provided on the supplied CD-ROM. Download this software from the website and install it on your computer to use. (→34)

Names and Functions of Main Parts

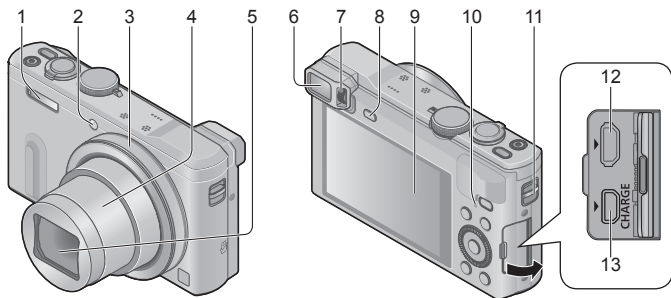

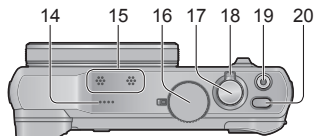

(Top)

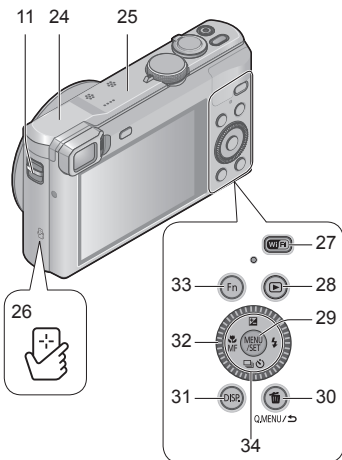
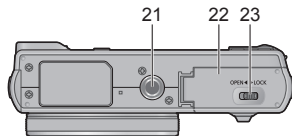

(Bottom)



Names and Functions of Main Parts

- 1 Flash
- 2 Self-timer indicator/
AF Assist Lamp
- 3 Control ring
- 4 Lens barrel
- 5 Lens
 - Do not touch the lens barrier.
- 6 Viewfinder (LVF)
- 7 Diopter adjustment dial
 - Adjusts the focus in the viewfinder.
- 8 [LVF] button
 - Use this to switch display between viewfinder and LCD monitor.
- 9 LCD Monitor
- 10 Charging lamp (Red)/
Wi-Fi® connection lamp (Blue)/
GPS status indicator (Green)
 - The color of the lamp differs depending on the function.
- 11 Strap eyelet
 - We recommend using the supplied hand strap to avoid dropping the camera.
- 12 [HDMI] socket
 - Do not connect any other cables except the HDMI micro cable. Doing so may cause malfunction.
- 13 [AV OUT/DIGITAL] socket
 - This socket is also used when charging the battery.
- 14 Speaker
- 15 Microphones
- 16 Mode dial
 - Use this to select the recording mode.
- 17 Shutter button
- 18 Zoom lever
- 19 Motion picture button
- 20 Camera [ON/OFF] button
- 21 Tripod mount
 - Do not attach to a tripod with a 5.5 mm (0.22 inch) or longer screw. Doing so may damage this unit.
 - If you are not holding the camera, for example when using self-timer recording or remote recording, the camera could tilt when the lens barrel extends during zooming, so make sure to secure the camera in place with a tripod or by other means.
 - It may not be possible to attach certain types of tripods properly.
- 22 Card/Battery door
- 23 Release lever
- 24 [Wi-Fi] antenna
- 25 GPS antenna
- 26 NFC antenna
- 27 [Wi-Fi] button
- 28 Playback button
 - Use this to select the recording mode or playback mode.
- 29 [MENU/SET] button
- 30 [Q.MENU/ ] /  button
 - You can display the Quick Menu and erase pictures.
- 31 [DISP.] button
 - Use this to change display.
- 32 Control dial
 - Turn the dial to select setting items and change setting values.
- 33 [Fn] button
- 34 Cursor button

[MENU/SET] button / Cursor button

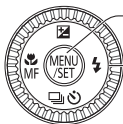

[MENU/SET] button

- Use this button to display the menus, enter the settings, etc.

Cursor button

- This button is used to move the cursor on the menu screens and for other functions.
- In this manual, the button that is to be used is indicated by ▲▼◀▶.

You can perform the following operations while recording.



[] button (▲)

- Exposure Compensation
 - Corrects the exposure when there is a backlight or when the subject is too dark or too bright.

[] button (▶)

- Flash

[] button (▼)

- Burst*
 - A burst of still pictures can be recorded while the shutter button is pressed fully.
 - Auto Bracket*
 - Records 3 pictures in continuous succession while exposure is changed automatically. After exposure adjustment, the adjustment value is set as the standard.
 - Self-timer*
 - This is effective for preventing jitter when pressing the shutter button, by setting the self-timer to 2 seconds.
- *To cancel the setting, select [] or [].

[] button (◀)

- Macro recording
 - When you want to enlarge the subject, setting to [AF Macro] ([]) enables you to take pictures at an even closer distance than the normal focus range (up to 3 cm (0.098 feet) for max. Wide).
- Manual Focus
 - Manual Focus is convenient when you want to lock the focus to take pictures or when it is difficult to adjust focus using Auto Focus.

Inserting and removing the battery or SD memory card (optional)

Make sure that the camera is turned off.

- 1 Slide the release lever (A) to the [OPEN] position and open the card/battery door**



- 2 Insert the battery and card, making sure that their orientation is correct**

- Battery: Insert the battery all the way firmly and check that it is locked by lever (B).
- Card: Insert the card all the way firmly until it clicks. Do not touch the terminals on the back of the card.

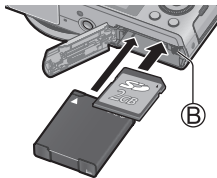

- 3 Close the door**

Slide the release lever to the [LOCK] position.

■ To remove

• To remove battery:

Move lever in direction of arrow.

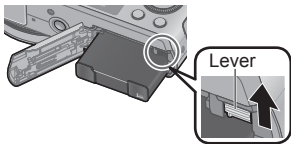

• To remove card:

Push the card until it clicks, then pull the card out.

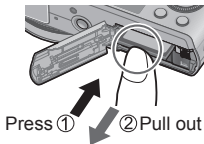

- Always use genuine Panasonic batteries (DMW-BCM13PP).
- If you use other batteries, we cannot guarantee the quality of this product.
- Keep the Memory Card out of reach of children to prevent swallowing.
- We recommend using a Panasonic card.

Charging the battery

- The battery that can be used with this unit is DMW-BCM13PP.
- The battery is not charged when the camera is shipped. Charge the battery before use.

Make sure that the camera is turned off.

1 Insert the battery to this unit, and then connect this unit to the AC adaptor (supplied) (A) or a PC (B)

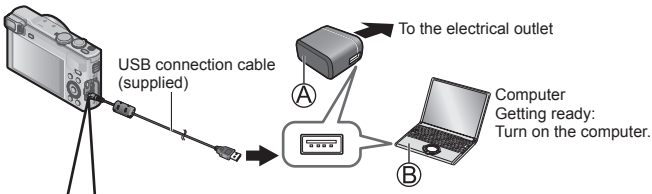

When charging the camera, connect the USB connection cable (supplied) to the [AV OUT/DIGITAL] socket (gold terminal). Connecting the cable to a wrong terminal may cause malfunction.

[AV OUT/DIGITAL] socket

- Place the camera in an upright position, and find the gold terminal at the bottom.

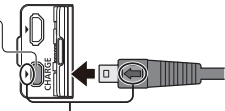

- Insert the USB connection cable so that its [←] mark will face the [▶] mark side of the camera.
- Always check the direction of the pins and hold the plug straight to insert or remove it. (If the cable is inserted in the wrong direction, the pins could become deformed and cause faulty operation.) Also, do not insert into the wrong socket. Doing so may cause damage to this unit.

Charging the battery



■ Charging lamp (Red)

On: Charging in progress

Off: Charging stops

(After charging stops, disconnect the camera from the electrical outlet or your computer.)

Flashing: Charging error

(For instructions on correcting the problem, refer to “Troubleshooting” (→35).)

■ Notes on charging time

When using the AC adaptor (supplied)

Charging time
Approx. 170 min

- The battery is a rechargeable lithium ion battery. If the temperature is too high or too low, the operating time of the battery will become shorter.
- The battery becomes warm after using and during and after charging. The camera also becomes warm during use. This is not a malfunction.
- Do not peel off or scratch the covering on the battery.
- **Do not leave any metal items (such as clips) near the contact areas of the power plug or near the batteries.**
- Store the battery in a cool and dry place with a relatively stable temperature: (Recommended temperature: 15 °C to 25 °C (59 °F to 77 °F), Recommended humidity: 40%RH to 60%RH)
- **Do not store the battery for a long time while fully charged.** When storing the battery for a long period of time, we recommend charging it once a year. Remove the battery from the camera and store it again after it has completely discharged.
- If you try to recharge the battery when it is already fully charged, the charging lamp will light for approximately 15 seconds.

When using the AC adaptor (supplied), observe the following points as improper connections may cause malfunctions.

- Do not use any other USB connection cables except the supplied one or a genuine Panasonic USB connection cable (DMW-USBC1: optional).
- Do not use any other AC adaptors except the supplied one.
- Do not use the AC adaptor (supplied) or the USB connection cable (supplied) with other devices.

Setting the clock

The clock is not set when the camera is shipped.
Disconnect the unit from the AC adaptor (supplied).

- 1 Press the Camera [ON/OFF] button (A)**
- 2 Press [MENU/SET] (B)**
- 3 Press ◀▶ to select the items (year, month, day, hour, minute, display order or time display format), and press ▲▼ to set**
 - To cancel → Press [Q.MENU/↵] button.
- 4 Press [MENU/SET] to set**
- 5 Confirm the setting and press [MENU/SET]**
 - To return to the previous screen, press [Q.MENU/↵] button.
- 6 Press ◀ to select [Yes] and press [MENU/SET] if automatically correcting time of day using the GPS function**
 - [GPS Setting] is set to [ON]
 - To manually set date and time → select [No], and press [MENU/SET].
- 7 When [Please set the home area] is displayed, press [MENU/SET]**

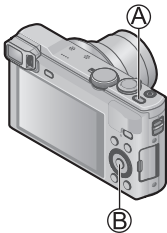

(Continued on the next page)

8 Press ◀▶ to set your home area and press [MENU/SET]



- If the time zone of your current location is different from that of [Home], [World Time] is set to [Destination]. ([✈️]) will be displayed next to the time and date on the screen)

■ Changing time settings

Select [Clock Set] from [Setup] menu, perform 3 and 4.
Please see the next page on how to set the menu.

Setting the menu

Refer to the following procedures to operate the menus.

Example: Setting [AF Mode] from [□] to [👤] in the [Program AE] Mode

1 Press [MENU/SET] to display the menu

2 Press ▲▼◀▶ or turn the control dial to select the [Rec] menu, and press [MENU/SET]



3 Press ▲▼ or turn the control dial to select [AF Mode], and press [MENU/SET]

- Depending on the item, its setting may not appear or it may be displayed in a different way.



4 Press ▲▼ or turn the control dial to select [👤], and press [MENU/SET]

5 Press [Q.MENU/↶] button several times to close the menu

- In recording mode, the menu screen can also be exited by pressing the shutter button halfway.

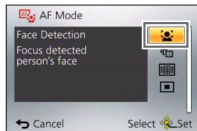

■ Menu types

- [Rec]
- [Motion Picture]
- [GPS]
- [Setup]
- [Wi-Fi]
- [Playback Mode]
- [Play Mode]

Taking pictures with automatic settings

[Intelligent Auto] Mode

This mode is recommended for those who want to point and shoot or beginners as the camera optimizes settings to match the subject and recording environment.

1 Set mode dial to [iA] ([Intelligent Auto] Mode)

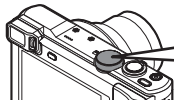

Align the mode dial correctly to the mode that you want to use.

2 Take a picture

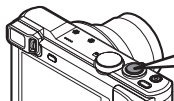











Press halfway
(press lightly to focus)





Press fully
(press the button all the way to record)

■ Automatic Scene Detection

Camera reads scene when pointed at subject, and makes optimum settings automatically.

 [i-Portrait]	 [i-Night Portrait] (Only when [i&A] is selected)
 [i-Baby]	 [i-Night Scenery]
 [i-Scenery]	 [i-Handheld Night Shot]
 [i-Sunset]	 [i-Food]
 [i-Macro]	 When scene does not correspond to any of the above

■ Recording modes

IA	[Intelligent Auto] Mode Take pictures with automatic settings. IA+ You can switch to the [Intelligent Auto Plus] Mode on the menu to adjust the brightness and color settings to your liking.
P	[Program AE] Mode Take pictures with automatic shutter speed and aperture value settings.
A	[Aperture-Priority] Mode Determine aperture, then record pictures.
S	[Shutter-Priority] Mode Determine shutter speed, then record pictures.
M	[Manual Exposure] Mode Determine aperture and shutter speed, then record pictures.
C1 C2	[Custom] Mode Record pictures using pre-registered settings.
	[Panorama Shot] Mode Record panorama pictures.
SCN	[Scene Mode] This allows you to take pictures that match the scene being recorded.
	[Creative Control] Mode Take pictures by selecting your preferred picture effect.

■ Holding the camera

Do not block the flash or the lamp.
Do not look at it from close range.

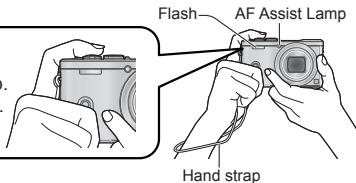

- To avoid camera shake, hold it with both hands keeping your arms close to your body while standing with your feet slightly apart.
- Do not touch the lens.

■ Zoom types

You can adjust the area of a picture to be taken using zoom.

Capture a wider area  Enlarge the subject
(wide-angle) (telephoto)

• Optical Zoom

Zooming in up to 30x is possible if pictures without [EZ] have been selected by [Picture Size] on the [Rec] menu.

• Extended optical zoom

Zooming in up to 71.7x is possible when pictures with [EZ] have been selected by [Picture Size] on the [Rec] menu.

• [i.Zoom]

Increase the zoom ratio up to 2x higher than the original zoom ratio with limited deterioration of picture quality. Set the [i.Zoom] in the [Rec] menu to [ON].

• [Digital Zoom]

Zoom 4x further than Optical/Extended optical zoom. Note that, with Digital Zoom, enlarging will decrease picture quality. Set the [Digital Zoom] in the [Rec] menu to [ON].

• [Step Zoom]

Each time the control ring/control dial is operated, the zoom stops at the position for one of the preset focal lengths.

■ Menu convenient for taking pictures

• [Picture Size]

Recording capacity guidelines (still pictures)

Save location	18M	5M	0.3M
Built-in Memory	1	3	69
Card (2 GB)	270	650	10050

(When [Aspect Ratio] is set to [4:3] and [Quality] is set to [📶])

Recording motion pictures

You can record motion pictures with audio (stereo).

- You can record motion pictures fitting each Recording Mode.
- Motion pictures cannot be recorded in the built-in memory.

1 Press the motion picture button (A) to start recording

- Do not block the microphones (B) when recording motion pictures.
- You can also use zoom while recording motion pictures.
 - The zoom speed will be slower than normal.
 - The operating sounds of the zoom lever or control ring/control dial may be recorded in some cases.
- Still pictures can be taken during motion picture recording.

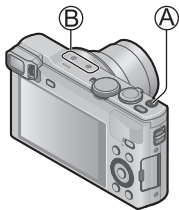

2 Press the motion picture button (A) again to end recording

- About recording time
 - You can continuously record a motion picture in [MP4] for up to 29 minutes 59 seconds or approx. 4 GB. (Since recording in [MP4] with [FHD/30p] creates larger files, the recording time for such motion pictures will be shorter than 29 minutes 59 seconds.)
 - If [Rec Quality] of [AVCHD] motion pictures is set to [FHD], you can continuously record a motion picture for up to 29 minutes 59 seconds.
- Motion pictures cannot be recorded in the following cases.
 - [Panorama Shot] Mode
 - [3D Photo Mode] ([Scene Mode])
 - [Soft Focus]/[Star Filter] ([Creative Control] Mode)

Recording motion pictures

■ About the recording format for recording motion pictures

This unit can record motion pictures in either AVCHD or MP4 formats.

The recording format for motion pictures can be changed in [Rec Format] of the [Motion Picture] menu.

■ About the recording quality setting

The recording quality for motion pictures can be changed in [Rec Quality] of the [Motion Picture] menu.

[AVCHD] in [Rec Format]

* AVCHD Progressive

Item	Picture size	fps	Bit rate
[FHD/60p]/ G *	1920×1080	60p	Approx. 28 Mbps
[FHD/60p]*			
[FHD/60i]/ G	1920×1080	60i	Approx. 17 Mbps
[FHD/60i]			
[HD/60p]/ G	1280×720	60p	Approx. 17 Mbps
[HD/60p]			

- Select picture quality settings with the [**G**] to record location information and place name information.

[MP4] in [Rec Format]

Item	Picture size	fps	Bit rate
[FHD/30p]	1920×1080	30p	Approx. 20 Mbps
[HD/30p]	1280×720	30p	Approx. 10 Mbps
[VGA/30p]	640×480	30p	Approx. 4 Mbps

■ About motion picture icon

[Rec Format] ——— **AVCHD G** ——— Location information/Place name log
Picture size ——— **FHD 60i** ——— fps



- If the surrounding temperature is high, or a motion picture is recorded continuously, [**△**] is displayed and recording may be stopped halfway through to protect the camera.
- If Extended optical zoom is used before pressing the motion picture button, these settings will be cleared, and the recordable area will be changed significantly.

Using the control ring/control dial

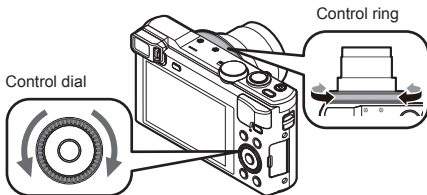
You can use the control ring/control dial to perform frequently used operations and settings directly.



Items that can be set by the control ring/control dial vary depending on recording modes. Following are the pre-assigned settings.

Recording mode	Setting	
	Control ring*1	Control dial
iA	Step Zoom (→22)	
P	Program Shift	
A	Aperture adjustment	
S	Shutter speed adjustment	
M	Aperture adjustment	Shutter speed adjustment*2
	Picture effects change	
SCN	Scene change	
	Picture effects change	

*1 When Manual Focus is set, the control ring is assigned to focus adjustment.

*2 Press **▲** to switch between aperture adjustment and shutter speed adjustment.

■ To change the settings assigned to the control ring/control dial

Changes the settings assigned to the control ring/control dial.

- ① Press [MENU/SET]
- ② Press ▲▼◀▶ to select [Setup] menu and press [MENU/SET]
- ③ Press ▲▼ to select [Ring/Dial Set] and press [MENU/SET]
- ④ Press ▲▼ to select [(0)] (control ring) or [(⦿)] (control dial), and then press [MENU/SET]
- ⑤ Press ▲▼ to select the setting and press [MENU/SET]

The following settings can be assigned

- [Default Control]
- [Zoom]
- [Step Zoom]
- [Exposure Comp.]
- [Aspect Ratio]
- [Sensitivity]
- [White Balance]
- [Not Set] (control ring only)

- ⑥ Press [Q.MENU/↵] button several times

- The assigned function setting applies to all the Recording Modes. However, the assigned function may not operate when combined with certain Recording Mode.

■ Using Quick menu

During recording, you can easily call some of the menu items and set them.

- ① Press [Q.MENU/↵] button
- ② Press ◀▶ to select menu items
 - The menu items and setting items that are displayed differ depending on the recording mode.
- ③ Turn the control ring or control dial to change the setting
- ④ Press [MENU/SET]

Registering preferred functions to the [Fn] button

It is set to [Composition Guide] at the time of purchase.

- 1 Press [MENU/SET]
- 2 Press ▲ ▼ ◀ ▶ to select [Setup] menu and press [MENU/SET]
- 3 Press ▲ ▼ to select [Fn Button Set] and press [MENU/SET]
- 4 Press ▲ ▼ to select the function to register and press [MENU/SET]

Taking pictures with the composition determined [Composition Guide]

- 1 Press [Fn] button
 - If the setting of the [Fn] button has been changed, select [Composition Guide] in the [Setup] menu and press [MENU/SET].
- 2 Press ▲ ▼ to select the guideline to display and press [MENU/SET]
 - Explanations and examples of the composition will be displayed in turn when you press the [DISP.] button.

■ Guidelines (Examples)

[Rule of Thirds Offset]

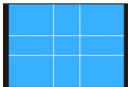

[Diagonal lines]



[Radiation]



Viewing your pictures

1 Press the Playback button (A)

- By holding down the Playback button while the camera is off, you can turn the camera on in Playback Mode.

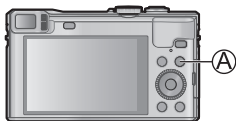

2 Press ◀▶ or turn the control dial to select the picture to be displayed

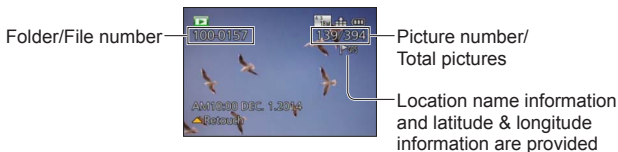

- To play back a motion picture, select a picture with the motion picture icon, and press ▲.

Deleting pictures

Deleted pictures cannot be recovered.

1 Press [] button (A) to delete the displayed picture

2 Press ◀ to select [Yes] and then press [MENU/SET] (B)

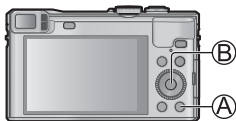

What you can do with the Wi-Fi® function

■ Using a smartphone/tablet as a camera remote control

By installing the “Panasonic Image App” on your smartphone/tablet, you can operate the camera remotely and use the smartphone/tablet to record and play back. In addition, you can copy pictures in the camera to the smartphone/tablet.

- For information on installing “Panasonic Image App” and basic operations on the smartphone/tablet, refer to “Wi-Fi® Quick Guide”.



■ Sending pictures to Wi-Fi compatible equipment

You can select pictures on your camera and transfer them to a TV, printer, AV equipment, PC, etc.



■ Transferring pictures automatically [Smart Transfer]

During battery charging, recorded pictures are transferred automatically to PC, AV equipment and cloud folders.



What you can do with the Wi-Fi® function

■ Using WEB services

Through LUMIX CLUB, you can send still pictures and motion pictures to social networking services, etc. To upload recorded pictures to a social networking service right away, we recommend that you first send the pictures to your smartphone/tablet and then upload them from your smartphone/tablet.

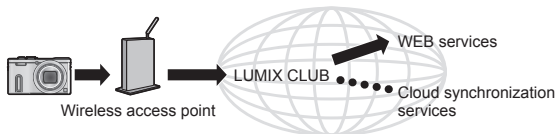

■ LUMIX CLUB

If you register this unit to the “LUMIX CLUB”, you can synchronize images between the devices you are using, or transfer these images to WEB services.

For details, refer to the “LUMIX CLUB” site.

<http://lumixclub.panasonic.net/eng/c/>

Please refer to “Owner’s Manual for advanced features (PDF format)” for details.

- When sending images on a mobile network, high packet communication fees may be incurred depending on the details of your contract.
- The camera uses WPA and WPA2 security.
- Hereafter, this manual uses the term “smartphone” for both smartphones and tablets unless it is particularly distinguishing between them.

GPS functions

Before using the camera, be sure to read "User License Agreement for Location Name Data" (Owner's Manual for advanced features).

This camera can record the location information of a place where a picture was taken on the pictures. The camera can also automatically adjust the time.

Using the GPS function to execute positioning

- 1 Press [MENU/SET]**
- 2 Press ▲ ▼ ◀ ▶ to select [GPS] menu and press [MENU/SET]**
- 3 Press ▲ ▼ to select [GPS Setting] and press [MENU/SET]**
- 4 Press ▲ ▼ to select [ON] and press [MENU/SET]**
 - A message appears on the screen. After confirming the message, press [MENU/SET].

■ About the GPS function

- Information measured with this unit is simply a rough estimate. Please do not use for professional applications.
- Positioning can be executed faster using GPS assist data.

■ When [GPS Setting] is [ON], the GPS function works even if the camera is turned off.

- Electromagnetic waves from the camera can affect instruments and meters. During takeoff and landing of airplanes or in other restricted areas, set [Airplane Mode] to [ON] and turn off the camera.
- When [GPS Setting] is [ON] and [Airplane Mode] is [OFF], power will drain from the battery even if the camera is turned OFF.

■ When using in another country

- The GPS function may not work in China or in the border regions of countries neighboring China. (Current as of January 2014)
- Some countries or regions may regulate the use of GPS or related technology.

Reading the Owner's Manual (PDF format)

More detailed instructions on the operation of this camera are contained in "Owner's Manual for advanced features (PDF format)" in the supplied CD-ROM. Install it on your PC to read it.

■ For Windows

- 1 Turn the PC on and insert the CD-ROM containing the Owner's Manual (supplied)
- 2 Click the [Owner's Manual]
- 3 Select the desired language and then click [Owner's Manual] to install
Ⓐ To return to the install menu.
- 4 Double-click the "Owner's Manual" shortcut icon on the desktop

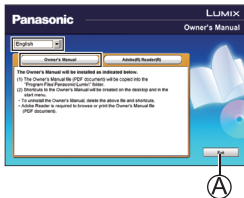

■ When the Owner's Manual (PDF format) will not open

You will need Adobe Acrobat Reader 5.0 or later, or Adobe Reader 7.0 or later to browse or print the Owner's Manual (PDF format).

- You can download and install a version of Adobe Reader that you can use with your OS from the following website.
<http://get.adobe.com/reader/otherversions/>

■ For Mac

- ① Turn the PC on and insert the CD-ROM containing the Owner's Manual (supplied)
- ② Open the "Manual" folder in the CD-ROM and then copy the PDF file with the desired language inside the folder
- ③ Double click the PDF file to open it

Supplied software

The supplied CD-ROM contains the following software.

Install the software on your computer to use.

For details about operating environment and usage, please read “Owner’s Manual for advanced features” (PDF format) or the manuals for each software.

- PHOTOfunSTUDIO / LoiLoScope are not compatible with Mac.

PHOTOfunSTUDIO 9.3 PE	Pictures can be captured to a PC, and can be viewed, organized, printed, etc. Also, still pictures can be corrected and motion pictures can be edited. <ul style="list-style-type: none">• Compatible OS: Windows 8.1 / 8 / 7 / Vista / XP
LoiLoScope (30-day full-trial version)	You can edit motion pictures easily. This will only install a shortcut to the trial version download site. For details about using LoiLoScope, please download and see the manual from the following site. http://loilo.tv/product/20/ <ul style="list-style-type: none">• Compatible OS: Windows 8.1 / 8 / 7 / Vista / XP

Installing supplied software

Preparations:

- Check your PC’s specifications and operating environment for each software.
- Before inserting the CD-ROM (supplied), close all running applications.

■ For Windows

1 Insert the supplied CD-ROM with the supplied software

2 When the install menu appears, click [Applications]

3 Click [Recommended Installation]

- Continue the installation procedure following the instructions displayed on the screen.
- The software compatible with your PC will be installed.

Downloading SILKYPIX Developer Studio SE

This software develops and edits RAW file pictures. Edited pictures can be saved in a file format such as JPEG or TIFF that can be displayed on a PC, etc. Download SILKYPIX Developer Studio SE from the following site and install it on your computer to use. (This software is not provided on the supplied CD-ROM.)
<http://www.isl.co.jp/SILKYPIX/english/p/>

- Compatible OS: Windows 8.1 / 8 / 7 / Vista / XP
Mac OS X (10.5 - 10.9)
- For details on how to use the SILKYPIX Developer Studio SE, refer to the “Help” or the Ichikawa Soft Laboratory’s support website.
- To download the software, the PC must be connected to the Internet.
- It may take time to download the software in some communication environments.

Copying still pictures and motion pictures

- 1 Turn on the camera and the PC, and connect them using the USB connection cable (supplied)**
 - Do not use any other USB connection cables except the supplied one or a genuine Panasonic USB connection cable (DMW-USBC1: optional). Using cables other than the above may cause a malfunction.
- 2 Press ▲ ▼ on the camera to select [PC], and press [MENU/SET]**
- 3 Copy pictures to your computer**
 - For Windows
Use “PHOTOfunSTUDIO”.
 - For Mac
Copy the picture files contained in the “DCIM” folder (except for AVCHD motion pictures).
- 4 Cancel the connection and disconnect the USB connection cable**

Troubleshooting

First, try out the following procedures.

If the problem persists, performing [Reset] in the [Setup] menu may resolve the issue.

The charging lamp blinks.

- Charging is being performed in a place with extremely high or low temperature.
→ **Reconnect the USB connection cable (supplied) and retry charging in a place where ambient temperature is 10 °C to 30 °C (50 °F to 86 °F) (temperature conditions also apply to the battery itself).**
- Charging is not possible if the power supply capacity of the computer is low.

The lower right portion of recorded pictures appears dark or the color is unnatural.

- Your finger is blocking the flash.
→ Make sure you are holding the camera correctly (→21).

Striping or flicker may appear under lighting such as fluorescent lighting and LED lighting fixture.

- This is characteristic of MOS sensors which serve as the camera's pickup sensors. This is not a malfunction.

I would like to upload recorded pictures to a social networking service right after taking them. How can I do that?

- We recommend sending the pictures to your smartphone and uploading them from the smartphone.

I am having a problem connecting to my Windows 8 PC. The user name and password are not recognized.

- Depending on the OS version, on Windows 8, for example, there are two types of user account (local account/Microsoft account). Be sure to use the user name and password for the local account. Since a Local account is not required by Windows 8, you may need to create one.

Troubleshooting

The Wi-Fi connection is not recognizing my PC.

- By default, the Wi-Fi connection uses the default workgroup name of "WORKGROUP". If the name of the workgroup has been changed, it will not be recognized. Select [PC Connection] then [Change Workgroup Name] in the [Wi-Fi Setup] menu to change the workgroup name to match that of your PC.



The GPS status indicator lights up while the camera is turned off.

- [GPS Setting] is [ON].
- Electromagnetic waves from the camera can affect instruments and meters. In airplane cabins (during takeoff and landing) or in other restricted areas, set [Airplane Mode] to [ON], and then turn off the camera.

Positioning takes time.

- When using the camera for the first time or after not using it for a while, positioning may take several minutes.
 - Positioning usually takes less than two minutes, but because the positions of the GPS satellites change, it may take longer depending on the recording location and environment.
- Positioning can be executed faster when you download GPS assist data to the camera using the "GPS Assist Tool".
- Positioning will take time in environments where it is difficult to receive the signals from the GPS satellites.

The location name information is different from the recording location.

- Immediately after the camera is turned on or when the GPS icon is something other than , the location name information that is recorded in the camera may vary significantly from the current position.
- When  is displayed for the location name information, the information can be changed to a different candidate before starting to record. You can edit a place name or landmark name recorded in a picture.

Please refer to "Owner's Manual for advanced features (PDF format)" for details.

Specifications

Digital Camera: Information for your safety

Power Source	DC 5 V
Power Consumption	1.7 W (When recording with LCD Monitor) 1.1 W (When playing back with LCD Monitor)
Camera effective pixels	18,100,000 pixels
Image sensor	1/2.3" MOS sensor, total pixel number 18,900,000 pixels Primary color filter
Lens	Optical 30x zoom f=4.3 mm to 129.0 mm (35 mm film camera equivalent: 24 mm to 720 mm) / Max. Wide: F3.3 to F8.0 Max. Tele: F6.4 to F8.0
Image Stabilizer	Optical method
Focus range	
AF	50 cm (1.6 feet) (Max. Wide) / 200 cm (6.6 feet) (Max. Tele) to ∞
AF Macro / Intelligent Auto / Motion picture / MF	3 cm (0.098 feet) (Max. Wide) / 200 cm (6.6 feet) (Max. Tele) to ∞
Scene Mode	The focus ranges listed above may vary depending on the selected Scene Mode.
Shutter system	Electronic shutter + Mechanical shutter
Shutter speed	4 seconds to 1/2000th of a second [Starry Sky] Mode: 15 seconds, 30 seconds
Minimum Illumination	Approx. 10 lx (when i-Low light is used, the shutter speed is 1/30th of a second)

Specifications

Exposure (AE)	Program AE (P) / Aperture-priority AE (A) / Shutter-priority AE (S) / Manual exposure (M)
Metering Mode	[Multi Metering] / [Center Weighted] / [Spot]
LCD monitor	3.0" TFT LCD (3:2) (Approx. 921,600 dots)
Viewfinder	Color LCD Viewfinder (Approx. 200,000 dots) (with diopter adjustment -4 to +4 diopter)
Microphones	Stereo
Speaker	Monaural
Recording media	Built-in Memory (Approx. 12 MB) SD Memory Card / SDHC Memory Card / SDXC Memory Card
Recording file format	
Still picture	RAW / JPEG (based on Design rule for Camera File system, based on Exif 2.3 standard / DPOF corresponding) / MPO
Motion pictures	AVCHD / MP4
Audio compression format	AVCHD: Dolby® Digital (2 ch) MP4: AAC (2 ch)
Interface	
Digital	USB 2.0 (High Speed)
Analog video	NTSC Composite
Audio	Audio line output (Monaural)
Terminal	HDMI: MicroHDMI Type D AV OUT/DIGITAL: Dedicated jack (8 pin)
Dimensions	Approx. 110.6 mm (W) x 64.3 mm (H) x 34.4 mm (D) [4.35" (W) x 2.53" (H) x 1.35" (D)] (excluding the projection part)

Mass (Weight)	With card and battery: Approx. 240 g (0.529 lb) Excluding card and battery: Approx. 214 g (0.472 lb)
Operating temperature	0 °C to 40 °C (32 °F to 104 °F)
Operating humidity	10%RH to 80%RH
Language select	[ENGLISH] / [ESPAÑOL]

Wi-Fi

Compliance standard	IEEE 802.11b/g/n (standard wireless LAN protocol)
Frequency range used (central frequency)	2412 MHz to 2462 MHz (1ch to 11ch)
Encryption method	Wi-Fi compliant WPA™ / WPA2™
Access method	Infrastructure mode

NFC

Compliance standard	ISO / IEC 18092 NFC-F (Passive Mode)
----------------------------	--------------------------------------

AC adaptor

(Panasonic VSK0768): Information for your safety

Input	~ 110 V to 240 V, 50/60 Hz, 0.2 A
Output	=== 5 V, 800 mA

Battery pack (lithium-ion)

(Panasonic DMW-BCM13PP): Information for your safety

Voltage / capacity	3.6 V / 1250 mAh
---------------------------	------------------

Specifications are subject to change without notice.

Digital Camera Accessory System

Description	Accessory#
Battery pack	DMW-BCM13
USB connection cable	DMW-USBC1
AV cable	DMW-AVC1

- Product numbers are correct as of January 2014. These may be subject to change.
- Accessories and/or model numbers may vary between countries. Consult your local dealer.

Digital Camera Accessory Order Form

Please photocopy this form when placing an order.

1. Digital Camera Model # _____

2. Items Ordered

Accessory #	Description	Price Each	Quantity	Total Price
Shipping & Handling				\$6.95
Subtotal				
Your State & Local Sales Tax				
Total				

3. Method of payment (check one)

- American Express
 VISA
 MasterCard
 Discover

Credit Card # _____

Expiration Date _____

Customer Signature _____

(Please do not send cash)

4. Shipping information (UPS delivery requires complete street address)

Ship To:

Mr.

Mrs.

Ms.

First _____ Last _____

Street Address _____

City _____ State _____ Zip _____

Phone#: _____
Day () _____

Night () _____

TO OBTAIN ANY OF OUR DIGITAL CAMERA ACCESSORIES YOU CAN DO ANY OF THE FOLLOWING:

VISIT YOUR LOCAL PANASONIC DEALER

OR

YOU MAY CONTACT US DIRECTLY AT:

1-800-237-9080 (FAX ONLY)

OR

MAIL THIS ORDER TO: PANASONIC NATIONAL PARTS CENTER

20421 84th Avenue South, Kent, WA 98032

Limited Warranty (ONLY FOR U.S.A. AND PUERTO RICO)

Panasonic Products Limited Warranty

Limited Warranty Coverage (For USA and Puerto Rico Only)

If your product does not work properly because of a defect in materials or workmanship, Panasonic Corporation of North America (referred to as “the warrantor”) will, for the length of the period indicated on the chart below, which starts with the date of original purchase (“warranty period”), at its option either (a) repair your product with new or refurbished parts, (b) replace it with a new or a refurbished equivalent value product, or (c) refund your purchase price. The decision to repair, replace or refund will be made by the warrantor.

Product or Part Name	Parts	Labor
Digital Camera	1 Year	1 Year
All included Accessories (Except Non-Rechargeable Batteries)	90 Days	Not Applicable
Only Non-Rechargeable Batteries	10 Days	Not Applicable

During the “Labor” warranty period there will be no charge for labor. During the “Parts” warranty period, there will be no charge for parts. This Limited Warranty excludes both parts and labor for non-rechargeable batteries, antennas, and cosmetic parts (cabinet). This warranty only applies to products purchased and serviced in the United States or Puerto Rico. This warranty is extended only to the original purchaser of a new product which was not sold “as is”.

Mail-In Service--Online Repair Request

Online Repair Request

To submit a new repair request and for quick repair status visit our Web Site at www.panasonic.com/repair.

When shipping the unit, carefully pack, include all supplied accessories listed in the Owner's Manual, and send it prepaid, adequately insured and packed well in a carton box. When shipping Lithium Ion batteries please visit our Web Site at www.panasonic.com/BatteryHandling as Panasonic is committed to providing the most up to date information. Include a letter detailing the complaint, a return address and provide a daytime phone number where you can be reached. A valid registered receipt is required under the Limited Warranty.

IF REPAIR IS NEEDED DURING THE WARRANTY PERIOD, THE PURCHASER WILL BE REQUIRED TO FURNISH A SALES RECEIPT/PROOF OF PURCHASE INDICATING DATE OF PURCHASE, AMOUNT PAID AND PLACE OF PURCHASE. CUSTOMER WILL BE CHARGED FOR THE REPAIR OF ANY UNIT RECEIVED WITHOUT SUCH PROOF OF PURCHASE.

Limited Warranty Limits And Exclusions

This warranty ONLY COVERS failures due to defects in materials or workmanship, and DOES NOT COVER normal wear and tear or cosmetic damage. The warranty ALSO DOES NOT COVER damages which occurred in shipment, or failures which are caused by products not supplied by the warrantor, or failures which result from accidents, misuse, abuse, neglect, mishandling, misapplication, alteration, faulty installation, set-up adjustments, misadjustment of consumer controls, improper maintenance, power line surge, lightning damage, modification, introduction of sand, humidity or liquids, commercial use such as hotel, office, restaurant, or other business or rental use of the product, or service by anyone other than a Factory Service Center or other Authorized Servicer, or damage that is attributable to acts of God.

THERE ARE NO EXPRESS WARRANTIES EXCEPT AS LISTED UNDER “LIMITED WARRANTY COVERAGE”.

THE WARRANTOR IS NOT LIABLE FOR INCIDENTAL OR CONSEQUENTIAL DAMAGES RESULTING FROM THE USE OF THIS PRODUCT, OR ARISING OUT OF ANY BREACH OF THIS WARRANTY.

(As examples, this excludes damages for lost time, travel to and from the servicer, loss of or damage to media or images, data or other memory or recorded content. The items listed are not exclusive, but for illustration only.)

ALL EXPRESS AND IMPLIED WARRANTIES, INCLUDING THE WARRANTY OF MERCHANTABILITY, ARE LIMITED TO THE PERIOD OF THE LIMITED WARRANTY.

Some states do not allow the exclusion or limitation of incidental or consequential damages, or limitations on how long an implied warranty lasts, so the exclusions may not apply to you.

This warranty gives you specific legal rights and you may also have other rights which vary from state to state. If a problem with this product develops during or after the warranty period, you may contact your dealer or Service Center. If the problem is not handled to your satisfaction, then write to the warrantor's Consumer Affairs Department at the addresses listed for the warrantor.

PARTS AND SERVICE, WHICH ARE NOT COVERED BY THIS LIMITED WARRANTY, ARE YOUR RESPONSIBILITY.

Customer Services Directory (United States and Puerto Rico)

Obtain Product Information and Operating Assistance; locate your nearest Dealer or Service Center; purchase Parts and Accessories; or make Customer Service and Literature requests by visiting our Web Site at:

<http://www.panasonic.com/support>

or, contact us via the web at:

<http://www.panasonic.com/contactinfo>

For hearing or speech impaired TTY users, TTY: 1-877-833-8855

Accessory Purchases (United States and Puerto Rico)

Purchase Parts, Accessories and Owner's Manual online for all Panasonic Products by visiting our Web Site at:

<http://www.pstc.panasonic.com>

Or, send your request by E-mail to:

npcparts@us.panasonic.com

You may also contact us directly at:

1-800-237-9080 (Fax Only)

(Monday-Friday 9am-9pm EST)

Panasonic National Parts Center

20421 84th Avenue South, Kent, WA 98032

(We accept Visa, MasterCard, Discover Card, American Express)

For hearing or speech impaired TTY users, TTY: 1-866-605-1277

As of November 2013

- SDXC Logo is a trademark of SD-3C, LLC.
- HDMI, the HDMI Logo, and High-Definition Multimedia Interface are trademarks or registered trademarks of HDMI Licensing LLC in the United States and other countries.
- HDAVI Control™ is a trademark of Panasonic Corporation.
- “AVCHD”, “AVCHD Progressive” and the “AVCHD Progressive” logo are trademarks of Panasonic Corporation and Sony Corporation.
- Manufactured under license from Dolby Laboratories. Dolby and the double-D symbol are trademarks of Dolby Laboratories.
- Windows and Windows Vista are either registered trademarks or trademarks of Microsoft Corporation in the United States and/or other countries.
- Mac and Mac OS are trademarks of Apple Inc., registered in the U.S. and other countries.
- QuickTime and the QuickTime logo are trademarks or registered trademarks of Apple Inc., used under license therefrom.
- The Wi-Fi CERTIFIED Logo is a certification mark of the Wi-Fi Alliance.
- The Wi-Fi Protected Setup Mark is a mark of the Wi-Fi Alliance.
- “Wi-Fi”, “Wi-Fi Protected Setup”, “Wi-Fi Direct”, “WPA” and “WPA2” are marks or registered marks of the Wi-Fi Alliance.
- DLNA, the DLNA Logo and DLNA CERTIFIED are trademarks, service marks, or certification marks of the Digital Living Network Alliance.
- This product uses “DynaFont” from DynaComware Corporation. DynaFont is a registered trademark of DynaComware Taiwan Inc.
- Other names, company names, and product names mentioned in these instructions are trademarks or registered trademarks of the companies concerned.



-If you see this symbol-



Information on Disposal in other Countries outside the European Union

This symbol is only valid in the European Union. If you wish to discard this product, please contact your local authorities or dealer and ask for the correct method of disposal.

Panasonic Corporation of North America

Two Riverfront Plaza, Newark, NJ 07102-5490

© Panasonic Corporation 2014

Printed in China