

Panasonic[®]

Owner's Manual for advanced features Digital Camera

Model No. **DMC-FZ200**
DMC-FZ60

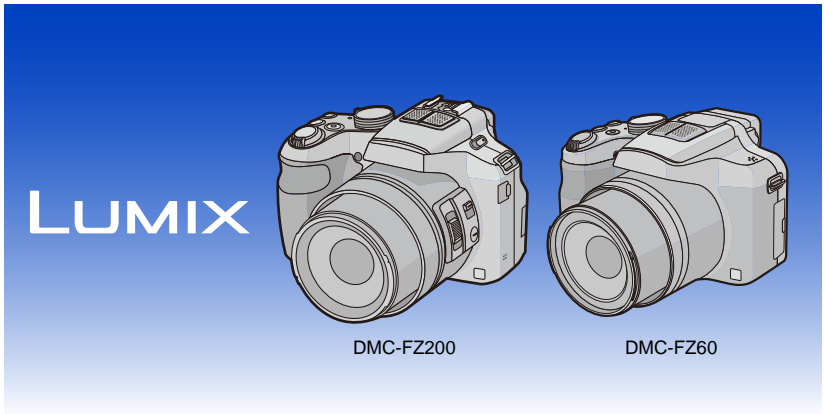

Before connecting, operating or adjusting this product,
please read the instructions completely.



(DMC-FZ200)



(DMC-FZ60)



Register online at
www.panasonic.com/register
(U.S. customers only)

VQT4H64
F0712WT0

Contents

Before Use

Care of the camera	7
Standard Accessories	8
Names and Functions of Main Parts	9

Preparation

Attaching the Lens Cap/Shoulder Strap	16
Attaching the Lens Hood (DMC-FZ200)	17
Charging the Battery	18
• Charging	18
• Approximate operating time and number of recordable pictures	20
Inserting and Removing the Card (optional)/the Battery	22
About the Built-in Memory/the Card	23
• Approximate number of recordable pictures and available recording time	25
Setting Date/Time (Clock Set)	27
• Changing the clock setting	28
Tips for taking good pictures	29
• Preventing jitter (camera shake)	29

Basic

Selecting the Recording Mode	30
Taking Pictures with Your Favorite Settings (Program AE Mode)	31
• Program Shift	32
Focusing	33
Taking Pictures Using the Automatic Function (Intelligent Auto Mode)	35
• Taking Pictures with Defocus Control Function	37
• Changing the settings	38
• Recording using Intelligent Auto Plus Mode	39
Recording Motion Pictures	41
• Recording still pictures while recording motion pictures	44
Playing Back Pictures ([Normal Play])	45
• Selecting a picture	45
• Displaying Multiple Screens (Multi Playback)	46
• Using the Playback Zoom	46
Playing Back Motion Pictures	47
• Creating Still Pictures from a Motion Picture	48
Deleting Pictures	49
• To delete a single picture	49
• To delete multiple pictures or all the pictures	50
Setting the Menu	51
• Setting menu items	52
• Using the Quick Menu	54
About the Setup Menu	55

Recording

About the LCD Monitor/Viewfinder	69
Taking Pictures with the Zoom	71
• Using the Optical Zoom/Using the Extended Optical Zoom (EZ)/Using the Intelligent Zoom/Using the Digital Zoom.....	71
Taking Pictures using the Flash	75
• Switching to the appropriate flash setting	76
Compensating the Exposure.....	79
Taking Pictures Using Burst Mode	80
Taking Pictures with the Self-Timer	84
Setting the Light Sensitivity	86
Adjusting the White Balance.....	88
Taking Pictures with Auto Focus	92
Taking Close-up Pictures	97
Taking Pictures with Manual Focus.....	99
Fixing the Focus and the Exposure (AF/AE Lock)	102
Using the function button.....	104
Taking Pictures by Specifying the Aperture/ Shutter Speed	105
• Aperture-Priority AE Mode.....	105
• Shutter-Priority AE Mode	105
• Manual Exposure Mode.....	106
Taking Pictures that Match the Scene Being Recorded (Scene Mode)	107
• [Portrait]	107
• [Soft Skin]	108
• [Scenery].....	108
• [Panorama Shot].....	109
• [Sports].....	111
• [Panning].....	111
• [Night Portrait].....	112
• [Night Scenery]	112
• [Handheld Night Shot].....	113
• [HDR]	113
• [Food].....	113
• [Baby1]/[Baby2]	114
• [Pet]	115
• [Sunset].....	115
• [High Sens.]	115
• [Glass Through]	115
• [3D Photo Mode].....	116
Taking Pictures with different image effects (Creative Control Mode).....	117
• [Expressive]	118
• [Retro]	118
• [High Key]	118
• [Low Key].....	118
• [Sepia].....	119

• [Dynamic Monochrome].....	119
• [Impressive Art].....	119
• [High Dynamic].....	119
• [Cross Process].....	120
• [Toy Effect].....	120
• [Miniature Effect].....	120
• [Soft Focus].....	122
• [Star Filter].....	122
• [One Point Color].....	122
Recording Motion Picture with Manual Settings	
(Creative Video Mode).....	123
• Recording the High Speed Motion Picture (DMC-FZ200).....	125
Taking Pictures in Custom Mode.....	126
• Registering Personal Menu Settings (Registering custom settings).....	127
• Recording using registered custom set.....	127
Taking a Picture with Face Recognition Function.....	128
• Face Settings.....	129
Entering Text.....	132
Using the [Rec] menu.....	133
• [Photo Style].....	133
• [Aspect Ratio].....	134
• [Picture Size].....	135
• [Quality].....	137
• [ISO Limit Set].....	138
• [ISO Increments].....	138
• [Extended ISO] (DMC-FZ200).....	138
• [Face Recog.].....	138
• [AF Mode].....	138
• [AF Style].....	139
• [Quick AF].....	140
• [AF/AE Lock].....	140
• [Metering Mode].....	140
• [i.Dynamic] (Intelligent dynamic range control).....	141
• [Min. Shtr Speed].....	141
• [i.Resolution].....	142
• [Digital Zoom].....	142
• [Stabilizer].....	143
• [AF Assist Lamp].....	144
• [Flash].....	144
• [Flash Synchro].....	144
• [Flash Adjust.].....	145
• [Red-Eye Removal].....	145
• [Conversion].....	145
• [Auto Bracket].....	146
• [Date Stamp].....	147
• [Clock Set].....	147

Using the [Motion Picture] menu	148
• [Rec Mode]	148
• [Rec Quality]	149
• [High Speed Video] (DMC-FZ200)	150
• [Continuous AF]	150
• [Wind Cut]	151
• [Zoom Mic]	151

Playback/Editing

Having Fun with Recorded Pictures	152
• [Auto Retouch]	152
• [Creative Retouch]	153
Playing Back Burst Pictures (DMC-FZ200)	154
Editing Burst Pictures (DMC-FZ200)	155
Various methods of playback	156
• [Slide Show]	156
• [Filtering Play]	159
• [Calendar]	160
Using the [Playback] menu	161
• [Upload Set]	161
• [Title Edit]	163
• [Text Stamp]	164
• [Video Divide]	166
• [Resize]	167
• [Cropping]	168
• [Leveling]	169
• [Favorite]	170
• [Print Set]	171
• [Protect]	173
• [Face Rec Edit]	174
• [Copy]	175

Connecting to other equipment

Playing Back Pictures on a TV Screen	176
• Using VIERA Link (HDMI).....	178
Playing back 3D pictures	180
Saving still pictures and motion pictures on your PC	182
• Uploading the images to sharing sites.....	185
Saving still pictures and motion pictures on a Recorder	186
Printing the Pictures	188
• Selecting a single picture and printing it.....	190
• Selecting multiple pictures and printing them.....	190
• Print Settings	191

Others

Optional accessories	194
Screen Display	200
Cautions for Use	203
Message Display	207
Troubleshooting	210

Care of the camera

Do not subject to strong vibration, shock, or pressure.

- The lens, LCD monitor, or external case may be damaged if used in following conditions.

It may also malfunction or image may not be recorded.

– Drop or hit the camera.

– Press hard on the lens or the LCD monitor.

- **When camera is not in use or when using the playback feature, ensure that the lens is in the stored position, with lens cap on.**

- **There are times when rattling sounds or vibrations will come from the camera, but these are due to the motion of the aperture, the zoom and the motor and do not indicate a defect.**

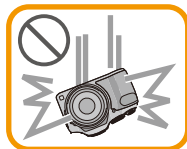

This camera is not dust/splash/water proof.

Avoid using the camera at location with a lot of dust, water, sand, etc.

- Liquid, sand and other foreign material may get into the space around the lens, buttons, etc. Be particularly careful since it may not just cause malfunctions, but it may become unrepairable.

– Places with a lot of sand or dust.

– Places where water can come into contact with this unit such as when using it on a rainy day or on the beach.



■ About Condensation (When the lens or viewfinder is fogged up)

- Condensation occurs when the ambient temperature or humidity changes. Be careful of condensation since it causes lens stains, fungus and camera malfunction.

- If condensation occurs, turn the camera off and leave it for about 2 hours. The fog will disappear naturally when the temperature of the camera becomes close to the ambient temperature.



Standard Accessories

Check that all the accessories are supplied before using the camera.

- The accessories and their shape will differ depending on the country or area where the camera was purchased.
For details on the accessories, refer to “Basic Owner’s Manual”.
- Battery Pack is indicated as **battery pack** or **battery** in the text.
- Battery Charger is indicated as **battery charger** or **charger** in the text.
- SD Memory Card, SDHC Memory Card and SDXC Memory Card are indicated as **card** in the text.
- **The card is optional.**
You can record or play back pictures on the built-in memory when you are not using a card.
- If any accessories are lost, customers in the USA and Puerto Rico should contact Panasonic’s parts department at 1-800-833-9626 and customers in Canada should contact 1-800-99-LUMIX (1-800-995-8649) for further information about obtaining replacement parts.

Names and Functions of Main Parts

DMC-FZ200

- 1 Lens (P7, 204)
- 2 Zoom lever (P71)
- 3 Shutter button (P31, 35)
- 4 Self-timer indicator (P84)/
AF Assist Lamp (P144)
- 5 Mode dial (P30)
- 6 Flash (P75)
- 7 Flash open lever (P75)
- 8 Shoulder strap eyelet (P16)
- 9 Focus selector switch (P97, 99)
- 10 Side lever (P72, 100)
- 11 [FOCUS] button (P35, 96, 101)
- 12 Lens barrel

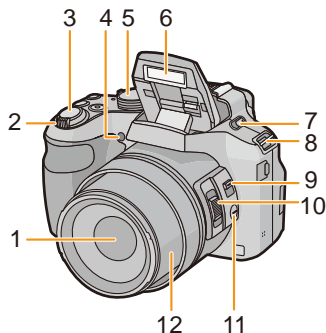

- 13 LCD monitor (P69, 200)
- 14 Viewfinder (P14, 200)
- 15 [EVF/LCD] button (P14)
- 16 Hot shoe (P196, 198)
- 17 Stereo microphone
- 18 [▶] (Playback) button (P45)
- 19 [AF/AE LOCK] button (P102)/[Fn2] button (P104)
- 20 Camera ON/OFF switch (P27)
- 21 Motion picture button (P41)
- 22 [⏏] (Burst Mode) button (P80)
- 23 [Fn1] button (P104)
- 24 Power lamp (P27)
- 25 Rear dial (P15)
- 26 [DISP.] button (P69)
- 27 [MENU/SET] button (P15, 52)
- 28 [Q.MENU] button (P54)/[⏏/↵] (Delete/Cancel) button (P49)
- 29 Cursor buttons (P15)

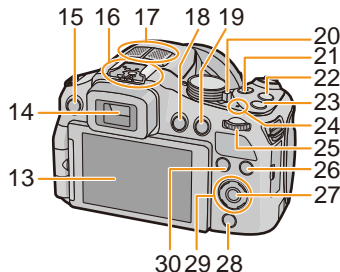

- ① ▲/ ISO (P86)
 - ② ▼/ Self-timer (P84)
 - ③ ◀/ AF MODE (P92)
 - ④ ▶/ (WB) White Balance (P88)
- 30 [Fn3] button (P104)

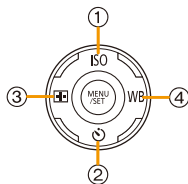

-
- 31 Diopter adjustment dial (P14)
32 [MIC/REMOTE] socket (P198)
33 Speaker (P57)
- Be careful not to cover the speaker with your finger. Doing so may make sound difficult to hear.

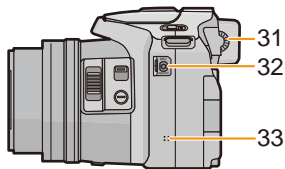

-
- 34 [HDMI] socket (P176)
35 [AV OUT/DIGITAL] socket (P176, 183, 186, 188)

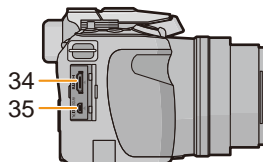

-
- 36 Tripod mount (P206)
- A tripod with a screw length of 5.5 mm (0.22 inch) or more may damage this unit if attached.
- 37 Release lever (P22)
38 Card/Battery door (P22)
39 DC coupler cover (P199)
- When using an AC adaptor, ensure that the Panasonic DC coupler (optional) and AC adaptor (optional) are used.

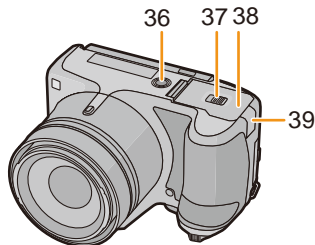

DMC-FZ60

- 1 Lens (P7, 204)
- 2 Zoom lever (P71)
- 3 Shutter button (P31, 35)
- 4 Self-timer indicator (P84)/
AF Assist Lamp (P144)
- 5 Mode dial (P30)
- 6 Flash (P75)
- 7 Speaker (P57)
- Be careful not to cover the speaker with your finger.
Doing so may make sound difficult to hear.
- 8 Shoulder strap eyelet (P16)
- 9 Lens barrel

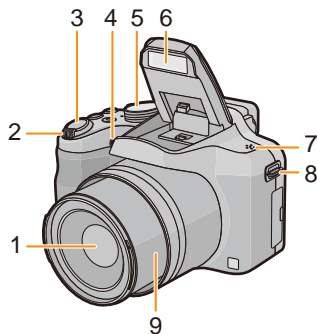

- 10 LCD monitor (P69, 200)
- 11 Viewfinder (P14, 200)
- 12 Flash open button (P75)
- 13 Stereo microphone
- 14 [EVF/LCD] button (P14)
- 15 [AF/AE LOCK]/[Fn1] button (P104)
- 16 Camera ON/OFF switch (P27)
- 17 Motion picture button (P41)
- 18 [] (Burst Mode) button (P80)
- 19 [FOCUS] button (P35, 96, 101)
- 20 Power lamp (P27)
- 21 Rear dial (P15)
- 22 [DISP.] button (P69)
- 23 [MENU/SET] button (P15, 52)
- 24 [Q.MENU] button (P54)/[] (Delete/Cancel) button (P49)
- 25 Cursor buttons (P15)

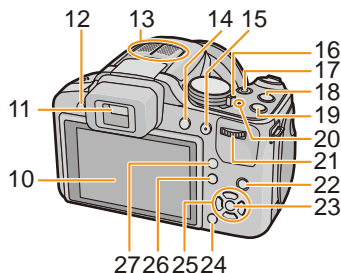

- ① ▲/ ISO (P86)
 - ② ▼/ Self-timer (P84)
 - ③ ◀/ Fn2 (P104)
 - ④ ▶/ (WB) White Balance (P88)
- 26 [] (Playback) button (P45)
 - 27 [AF/AF-LOCK/MF] button (P97, 99)

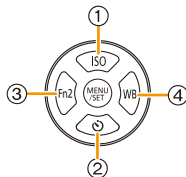

-
- 28 Diopter adjustment dial (P14)
 - 29 [HDMI] socket (P176)
 - 30 [AV OUT/DIGITAL] socket (P176, 183, 186, 188)

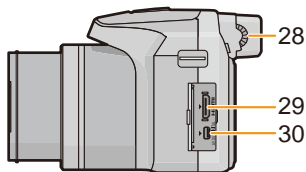

-
- 31 Tripod mount (P206)
 - A tripod with a screw length of 5.5 mm (0.22 inch) or more may damage this unit if attached.
 - 32 Release lever (P22)
 - 33 Card/Battery door (P22)
 - 34 DC coupler cover (P199)
 - When using an AC adaptor, ensure that the Panasonic DC coupler (optional) and AC adaptor (optional) are used.

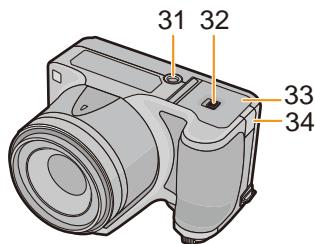

LCD Monitor (DMC-FZ200)

At the time when this camera is purchased, the LCD monitor is stowed in the camera body. Bring out the LCD monitor as shown below.

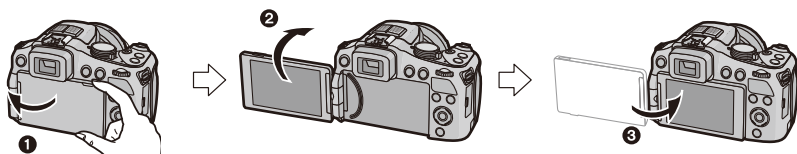

❶ Open the LCD monitor. (Maximum 180°)

❷ It can be rotated 180° forwards.

❸ Return the monitor to its original position.

• **Only rotate the LCD monitor after opening it wide enough, and be careful not to use excessive force as it may be damaged.**

The LCD monitor can be rotated to suit your needs. This is convenient as it allows you to take pictures from various angles by adjusting the LCD monitor.

• Do not cover the AF Assist Lamp with your fingers or other objects.

■ Taking pictures at a high angle

• This is convenient when there is someone in front of you and you cannot get close to the subject.



• It can only be rotated 90° towards you.

■ Taking pictures at a low angle

• This is convenient when taking pictures of flowers etc. that are in a low position.



• It can be rotated 180° forward.

Note

- Be careful as this unit may get scratched if you rotate the LCD monitor without opening the LCD monitor fully.
- When not using the LCD monitor it is recommended that you close it with the screen facing inwards to prevent dirt and scratches.
- Note that operating noise may be recorded when recording a motion picture with the LCD monitor rotated.

Viewfinder

Switching the LCD monitor/Viewfinder

Press [EVF/LCD].

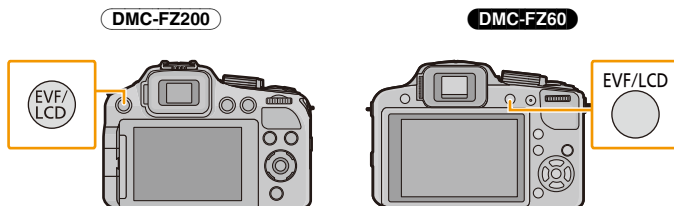

- You can switch between LCD monitor display and Viewfinder display.
- Switching via the [EVF/LCD] button will be maintained even when this unit is turned off.

Diopter adjustment

Adjust the diopter to suit your vision so that you can see the Viewfinder clearly.

Look at the display on the Viewfinder and rotate the diopter adjustment dial to where the screen is in focus.

- (A) Diopter adjustment dial

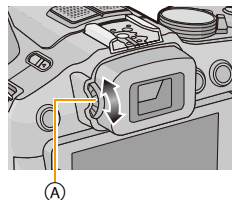

Cursor buttons/[MENU/SET] button

Cursor button:

Selection of items or setting of values etc., is performed.

[MENU/SET] button:

Confirmation of setting contents, etc., is performed.

- This document expresses the up, down, left, and right of the cursor button as follows, or as ▲/▼/◀/▶.

e.g.: When you press the ▼ (down) button

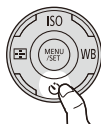

or **Press ▼**

Rear Dial

There are 2 ways to operate the rear dial, rotating left or right, and deciding by pressing.

Rotating:

Selection of items or setting of values is performed during the various settings.

Pressing:

Operations that are the same as [MENU/SET] button, such as determine settings, etc., are performed during the various settings.

- Rear dial is described as follows in this Owner's Manual.

e.g.: Rotating left or right



e.g.: Pressing the rear dial



Attaching the Lens Cap/Shoulder Strap

■ Attaching the Lens Cap

- When you turn the camera off or carry the camera, attach the lens cap to protect the surface of the lens.

1 Pass the string through the hole on the camera.

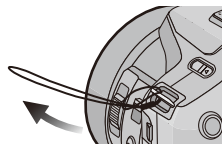

2 Pass the same string through the hole on the lens cap.

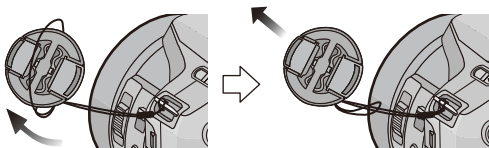

3 Attach the lens cap.

- Do not hang or swing around this unit.
- Make sure to detach the lens cap when turning this unit on.
- Be careful not to lose the lens cap.
- Be careful that the lens cap string does not become entangled with the shoulder strap.

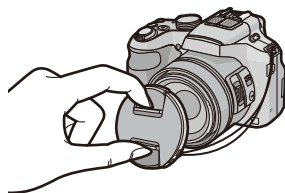

■ Attaching the Shoulder Strap

- We recommend attaching the shoulder strap when using the camera to prevent it from dropping.

1 Pass the shoulder strap through the hole at the shoulder strap eyelet.

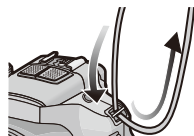

2 Pass the shoulder strap through the stopper and fasten the shoulder strap.

- (A) Pull the shoulder strap 2 cm (0.066 feet) or more.

- Attach the shoulder strap to the other side of the camera being careful not to twist it.

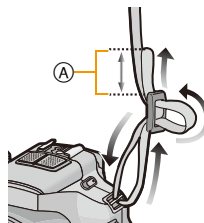

Attaching the Lens Hood DMC-FZ200

In bright sunlight or backlight, the lens hood will minimize lens flare and ghosting. The lens hood cuts off excess lighting and improves the picture quality.

- Check that the camera is turned off.
- Close the flash.

1 Attach the lens hood into the lens with the short side aligned with the bottom of the main unit.

- Do not hold the lens hood in a way that twists or bends it.



2 Rotate the lens hood in the direction of the arrow.



3 You will feel some stiffness just before the mark, but continue to rotate the lens hood to (A) where the marks align.

(The lens hood will stop with a “click”.)

- Check that the lens hood is firmly attached and that it does not appear in the picture.

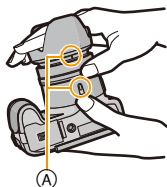

Note

- When taking pictures with flash with the lens hood attached, the lower portion of the photo may turn dark (vignetting effect) and the control of the flash may be disabled because the photo flash may be obscured by the lens hood. We recommend detaching the lens hood.
- When temporarily detaching and carrying the lens hood, attach the lens hood to the lens in the reverse direction. Return it to the normal direction when taking pictures.

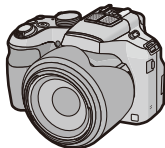

Charging the Battery

About batteries that you can use with this unit

It has been found that counterfeit battery packs which look very similar to the genuine product are made available for purchase in some markets. Some of these battery packs are not adequately protected with internal protection to meet the requirements of appropriate safety standards. There is a possibility that these battery packs may lead to fire or explosion. Please be advised that we are not liable for any accident or failure occurring as a result of use of a counterfeit battery pack. To ensure that safe products are used, we recommend that a genuine Panasonic battery pack is used.

- Use the dedicated charger and battery.

Charging

- The battery is not charged when the camera is shipped. Charge the battery before use.
- Charge the battery with the charger indoors.
- Charge the battery in areas with an ambient temperature between 10 °C and 30 °C (50 °F and 86 °F) (same as the battery temperature) is recommended.

- 1 Attach the battery paying attention to the direction of the battery.

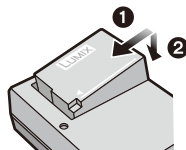

- 2 Connect the charger to the electrical outlet.

- The [CHARGE] indicator (A) lights up and charging begins.

plug-in type

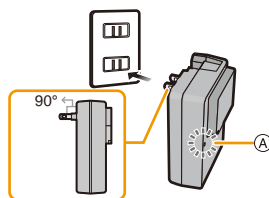

inlet type

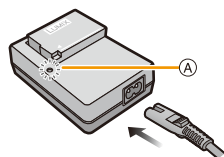

■ About the [CHARGE] indicator

The [CHARGE] indicator turns on:

The [CHARGE] indicator is turned on during charging.

The [CHARGE] indicator turns off:

The [CHARGE] indicator will turn off once the charging has completed without any problem. (Disconnect the charger from the electrical socket and detach the battery after charging is completed.)

• When the [CHARGE] indicator flashes

- The battery temperature is too high or too low. It is recommended to charge the battery again in an ambient temperature of between 10 °C and 30 °C (50 °F and 86 °F).
- The terminals of the charger or the battery are dirty. In this case, wipe them with a dry cloth.

■ Charging time

	DMC-FZ200	DMC-FZ60
Charging time	Approx. 140 min	Approx. 155 min

- The indicated charging time is for when the battery has been discharged completely. The charging time may vary depending on how the battery has been used. The charging time for the battery in hot/cold environments or a battery that has not been used for long time may be longer than normal.

■ Battery indication

The battery indication is displayed on the screen.



- The indication turns red and blinks if the remaining battery power is exhausted. (The power lamp also blinks) Recharge the battery or replace it with a fully charged battery.

● Note

- **Do not leave any metal items (such as clips) near the contact areas of the power plug. Otherwise, a fire and/or electric shocks may be caused by short-circuiting or the resulting heat generated.**
- The battery becomes warm after using it and during and after charging. The camera also becomes warm during use. This is not a malfunction.
- The battery can be recharged even when it still has some charge left, but it is not recommended that the battery charge be frequently topped up while the battery is fully charged. (Since characteristic swelling may occur.)

Approximate operating time and number of recordable pictures

■ Recording still pictures (When using the LCD monitor)

	DMC-FZ200	DMC-FZ60	
Number of recordable pictures	Approx. 540 pictures	Approx. 450 pictures	(By CIPA standard in Program AE Mode)
Recording time	Approx. 270 min	Approx. 225 min	

Recording conditions by CIPA standard

- CIPA is an abbreviation of [Camera & Imaging Products Association].
- Temperature: 23 °C (73.4 °F)/Humidity: 50%RH when LCD monitor is on.
- Using a Panasonic SD Memory Card (32 MB).
- Using the supplied battery.
- Starting recording 30 seconds after the camera is turned on. (When the Optical Image Stabilizer function is set to [ON].)
- **Recording once every 30 seconds** with full flash every second recording.
- Rotating the zoom lever from Tele to Wide or vice versa in every recording.
- Turning the camera off every 10 recordings and leaving it until the temperature of the battery decreases.

The number of recordable pictures varies depending on the recording interval time. If the recording interval time becomes longer, the number of recordable pictures decreases. [For example, if you were to take one picture every two minutes, then the number of pictures would be reduced to approximately one-quarter of the number of pictures given above (based upon one picture taken every 30 seconds).]

■ Recording motion pictures (When using the LCD monitor)

DMC-FZ200

	[AVCHD] (Recording with picture quality set to [PSH])	[MP4] (Recording with picture quality set to [FHD])
Recordable time	Approx. 160 min	Approx. 200 min
Actual recordable time	Approx. 80 min	Approx. 100 min

DMC-FZ60

	[AVCHD] (Recording with picture quality set to [FSH])	[MP4] (Recording with picture quality set to [FHD])
Recordable time	Approx. 160 min	Approx. 160 min
Actual recordable time	Approx. 90 min	Approx. 90 min

- These times are for an ambient temperature of 23 °C (73.4 °F) and a humidity of 50%RH. Please be aware that these times are approximate.
- Actual recordable time is the time available for recording when repeating actions such as turning this unit on and off, starting/stopping recording, zoom operation etc.
- Maximum time to record motion pictures continuously with [MP4] is 29 minutes 59 seconds or up to 4 GB. You can check the recordable time on the screen. (For [FHD] in [MP4] format, the file size is large and so the recordable time will drop below 29 minutes 59 seconds.)

■ Playback (When using the LCD monitor)

	DMC-FZ200	DMC-FZ60
Playback time	Approx. 440 min	Approx. 330 min

Note

- **The operating times and number of recordable pictures will differ according to the environment and the operating conditions.**

For example, in the following cases, the operating times shorten and the number of recordable pictures is reduced.

- In low-temperature environments, such as on ski slopes.
- When using [LCD Mode].
- When [Live View Mode] is set to [NORMAL].
- When operations such as flash and zoom are used repeatedly.
- When the operating time of the camera becomes extremely short even after properly charging the battery, the life of the battery may have expired. Buy a new battery.

Inserting and Removing the Card (optional)/the Battery

- Turn this unit off and confirm that the lens barrel is retracted.
- We recommend using a Panasonic card.

1 Slide the release lever in the direction of the arrow and open the card/battery door.

- Always use genuine Panasonic batteries.
- If you use other batteries, we cannot guarantee the quality of this product.

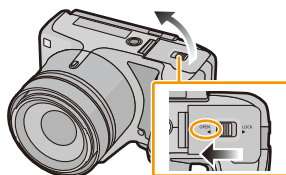

2 Battery: Being careful about the battery orientation, insert all the way until you hear a locking sound and then check that it is locked by lever (A).

Pull the lever (A) in the direction of the arrow to remove the battery.

Card: Push it securely all the way until you hear a “click” while being careful about the direction in which you insert it.

To remove the card, push the card until it clicks, then pull the card out upright.

(B): Do not touch the connection terminals of the card.

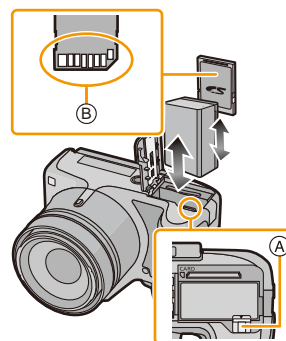

3 1: Close the card/battery door.

2: Slide the release lever in the direction of the arrow.

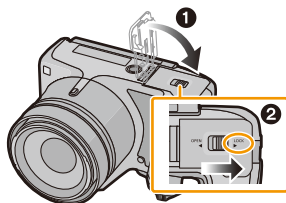

Note

- Remove the battery after use. (The battery will be exhausted if left for a long period of time after being charged.)
- Remove the card or battery after turning this unit off, with the power lamp completely turned off and the lens barrel retracted completely. (The camera may not function properly, or the card or recorded contents may be damaged.)
- When using an AC adaptor (optional) instead of the battery, refer to P199.

About the Built-in Memory/the Card

The following operations can be performed using this unit:

When a card has not been inserted	Pictures can be recorded on the built-in memory and played back.
When a card has been inserted	Pictures can be recorded on the card and played back.

• When using the built-in memory

 (access indication^{*})

• When using the card

 (access indication^{*})

- * The access indication is displayed in red when pictures are being recorded on the built-in memory (or the card).



Built-in Memory

- You can copy the recorded pictures to a card. (P175)
- The access time for the built-in memory may be longer than the access time for a card.

	DMC-FZ200	DMC-FZ60
Memory size	Approx. 70 MB	Approx. 70 MB

Card

The following cards which conform to the SD video standard can be used with this unit.
(These cards are indicated as **card** in the text.)

	Remarks
SD Memory Card (8 MB to 2 GB)	<ul style="list-style-type: none"> • Use a card with SD Speed Class* with “Class 4” or higher when recording motion pictures.
SDHC Memory Card (4 GB to 32 GB)	<ul style="list-style-type: none"> • SDHC Memory Card can be used with SDHC Memory Card or SDXC Memory Card compatible equipment. • SDXC Memory Card can only be used with SDXC Memory Card compatible equipment.
SDXC Memory Card (48 GB, 64 GB)	<ul style="list-style-type: none"> • Check that the PC and other equipment are compatible when using the SDXC Memory Cards. http://panasonic.net/avc/sdcard/information/SDXC.html <hr/> <p>DMC-FZ200</p> <ul style="list-style-type: none"> • This unit is compatible with UHS-I standard SDHC/SDXC memory cards. <hr/> <ul style="list-style-type: none"> • Only the cards with capacity listed left can be used.

* SD Speed Class is the speed standard regarding continuous writing. Check via the label on the card, etc.

e.g.:

CLASS **4** **4**

• Please confirm the latest information on the following website.

<http://panasonic.ip/support/global/cs/dsc/>

(This Site is English only.)

Note

• Do not turn this unit off, remove its battery or card, or disconnect the AC adaptor (optional) when the access indication is lit (when pictures are being written, read or deleted, or the built-in memory or the card is being formatted). Furthermore, do not subject the camera to vibration, impact or static electricity.

The card or the data on the card may be damaged, and this unit may no longer operate normally.

If operation fails due to vibration, impact or static electricity, perform the operation again.

- Write-Protect switch (A) provided (When this switch is set to the [LOCK] position, no further data writing, deletion or formatting is possible. The ability to write, delete and format data is restored when the switch is returned to its original position.)
- The data on the built-in memory or the card may be damaged or lost due to electromagnetic waves, static electricity or breakdown of the camera or the card. We recommend storing important data on a PC etc.
- Do not format the card on your PC or other equipment. Format it on the camera only to ensure proper operation. (P68)
- Keep the Memory Card out of reach of children to prevent swallowing.



Approximate number of recordable pictures and available recording time

About the display of the number of recordable pictures and available recording time

- Switching between the display of number of recordable pictures and available recording time can be performed in the [Remaining Disp.] (P61) in the [Setup] menu.

(A) Number of recordable pictures

(B) Available recording time

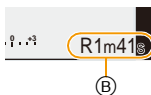
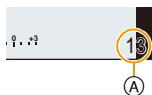

- The number of recordable pictures and the available recording time are an approximation. (These vary depending on the recording conditions and the type of card.)
- The number of recordable pictures and the available recording time varies depending on the subjects.

Number of recordable pictures

- [+99999] is displayed if there are more than 100,000 pictures remaining.

• Aspect ratio [4:3], Quality [S:M]

DMC-FZ200

[Picture Size]	Built-in Memory (Approx. 70 MB)	2 GB	32 GB	64 GB
12M	13	380	6260	12670
5M (EZ)	24	650	10620	21490
0.3M (EZ)	380	10050	162960	247150

DMC-FZ60

[Picture Size]	Built-in Memory (Approx. 70 MB)	2 GB	32 GB	64 GB
16M	11	300	4910	9880
5M (EZ)	24	650	10620	21490
0.3M (EZ)	380	10050	162960	247150

■ Available recording time (when recording motion pictures)

• “h” is an abbreviation for hour, “m” for minute and “s” for second.

• [AVCHD]

DMC-FZ600

[Rec Quality]	Built-in Memory (Approx. 70 MB)	2 GB	32 GB	64 GB
PSH	–	8m00s	2h31m00s	5h07m00s
FSH	–	14m00s	4h10m00s	8h26m00s
SH	–	14m00s	4h10m00s	8h26m00s

DMC-FZ60

[Rec Quality]	Built-in Memory (Approx. 70 MB)	2 GB	32 GB	64 GB
FSH	–	15m00s	4h10m00s	8h27m00s
SH	–	15m00s	4h10m00s	8h27m00s

• [MP4]

DMC-FZ600

[Rec Quality]	Built-in Memory (Approx. 70 MB)	2 GB	32 GB	64 GB
FHD	–	12m02s	3h22m58s	6h50m54s
HD	–	22m59s	6h27m29s	13h04m28s
VGA	1m42s	50m36s	14h12m48s	28h46m30s

DMC-FZ60

[Rec Quality]	Built-in Memory (Approx. 70 MB)	2 GB	32 GB	64 GB
FHD	–	12m23s	3h23m18s	6h51m18s
HD	–	23m39s	6h28m09s	13h05m14s
VGA	1m44s	52m04s	14h14m15s	28h48m10s

Note

- The recordable time is the total time of all the motion pictures which have been recorded.
- Number of recordable pictures/available recording time for the card may decrease when [Upload Set] is performed.
- Maximum time to record motion pictures continuously with [MP4] is 29 minutes 59 seconds or up to 4 GB. You can check the recordable time on the screen. (For [FHD] in [MP4] format, the file size is large and so the recordable time will drop below 29 minutes 59 seconds.)
- The maximum available continuous recording time is displayed on the screen.

Setting Date/Time (Clock Set)

• The clock is not set when the camera is shipped.

1 Turn the camera on.

- The power lamp **1** lights when you turn this unit on.
- If the language select screen is not displayed, proceed to step 4.

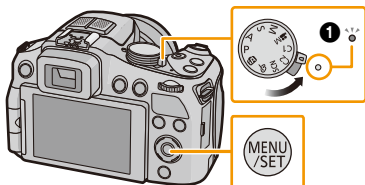

2 Press [MENU/SET].

3 Press ▲/▼ to select the language, and press [MENU/SET].

4 Press [MENU/SET].

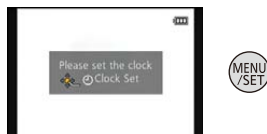

5 Press ◀/▶ to select the items (year, month, day, hour, minute, display sequence or time display format), and press ▲/▼ to set.

- (A): Time at the home area
- (B): Time at the travel destination

- You can cancel without setting the clock by pressing [🗑️/↩️].

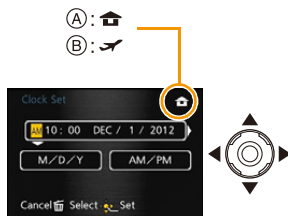

6 Press [MENU/SET] to set.

7 Press [MENU/SET].

Changing the clock setting

Select **[Clock Set]** in the **[Rec]** or **[Setup]** menu, and press **▶**. (P52)

- The clock can be reset as shown in steps **5** and **6**.
- **The clock setting is maintained for 3 months using the built-in clock battery even without the battery. (Leave the charged battery in the unit for 24 hours to charge the built-in battery.)**



Note

- If the clock is not set, the correct date cannot be printed when you order a photo studio to print the picture, or when you stamp the date on the pictures with **[Date Stamp]** (P147) or **[Text Stamp]** (P164).
- If the clock is set, the correct date can be printed even if the date is not displayed on the screen of the camera.

Tips for taking good pictures

Hold the camera gently with both hands, keep your arms still at your side and stand with your feet slightly apart.

- Be careful not to put your fingers on the flash, AF Assist Lamp (A), microphone (B), speaker or lens etc.
- Be careful not to cover the speaker with your finger. Doing so may make sound difficult to hear. (P10, 11)
- Be careful not to move the camera when you press the shutter button.
- When taking pictures, make sure your footing is stable and there is no danger of colliding with another person, an object etc.
- Do not hold the lens barrel as you take pictures. There is a risk that your finger will be trapped as the lens retracts.

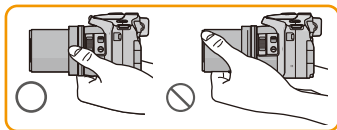

■ Direction Detection Function ([Rotate Disp.])

Pictures recorded with the camera held vertically are played back vertically (rotated). (Only when [Rotate Disp.] (P67) is set)

- When the camera is held vertically and tilted up and down to record pictures, the Direction Detection function may not work correctly.
- Motion pictures taken with the camera held vertically are not displayed vertically.
- You cannot record 3D pictures in vertical orientation.

Preventing jitter (camera shake)

When the Jitter alert [⊞] appears, use [Stabilizer] (P143), a tripod or the Self-timer (P84).

- Shutter speed will be slower particularly in the following cases. Keep the camera still from the moment the shutter button is pressed until the picture appears on the screen. We recommend using a tripod.
 - Slow sync./Red-Eye Reduction
 - [Night Portrait]/[Night Scenery] (Scene Mode)
 - When the shutter speed is slowed in [Min. Shtr Speed]

Selecting the Recording Mode

Switching the mode by rotating the mode dial.

Align a desired mode with part ①.

- Rotate the mode dial slowly to select the desired mode.

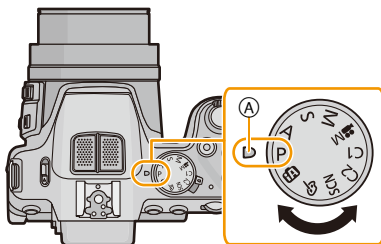

■ Basic

P	Program AE Mode (P31)
The subjects are recorded using your own settings.	
IA	Intelligent Auto Mode (P35)
The subjects are recorded using settings automatically selected by the camera.	

■ Advanced

A	Aperture-Priority AE Mode (P105)
The shutter speed is automatically determined by the aperture value you set.	
S	Shutter-Priority AE Mode (P105)
The aperture value is automatically determined by the shutter speed you set.	
M	Manual Exposure Mode (P106)
The exposure is adjusted by the aperture value and the shutter speed which are manually adjusted.	
CM	Creative Video Mode (P123)
Record motion picture with manual settings.	
C1 C2	Custom Mode (P126)
Use this mode to take pictures with previously registered settings.	
SCN	Scene Mode (P107)
This allows you to take pictures that match the scene being recorded.	
CC	Creative Control Mode (P117)
Record while checking the image effect.	

Taking Pictures with Your Favorite Settings

(Program AE Mode)

Recording mode:          

The camera automatically sets the shutter speed and the aperture value according to the brightness of the subject.

You can take pictures with greater freedom by changing various settings in [Rec] menu.

1 Set the mode dial to [P].

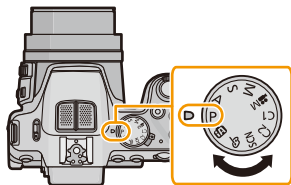

2 Aim the AF area at the point you want to focus on.

3 Press the shutter button halfway to focus.

- (A) Aperture value
- (B) Shutter speed
- (C) ISO sensitivity

- The focus indication (D) (green) lights when the subject is focused.
- The maximum close-up distance (the shortest distance at which the subject can be taken) differs depending on the zoom magnification. Please check with the focus range display on the screen. (P34)
- Aperture value and shutter speed are displayed in red when correct exposure is not achieved. (Except when using a flash)

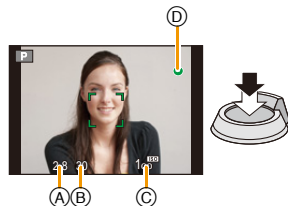

4 Press the shutter button fully (push it in further), and take the picture.



Program Shift

In Program AE Mode, you can change the preset aperture value and shutter speed without changing the exposure. This is called Program Shift.

You can make the background more blurred by decreasing the aperture value or record a moving subject more dynamically by slowing the shutter speed when taking a picture in Program AE Mode.

1 Press the shutter button halfway and display the aperture value and shutter speed value on the screen.

2 While the values are displayed (about 10 seconds), perform the Program Shift by rotating the rear dial.

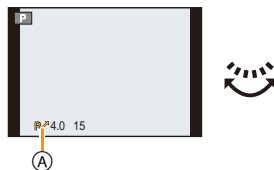

- It will switch between Program Shift operation and Exposure Compensation operation (P79) every time the rear dial is pressed while the values are displayed.
- The Program Shift indication (A) appears on the screen when Program Shift is activated.
- Program Shift is canceled if the camera is turned off or the rear dial is rotated until the Program Shift indication disappears.

Example of Program Shift

(A): Aperture value

(B): Shutter speed

- Program Shift amount
- Program Shift line chart
- Program Shift limit

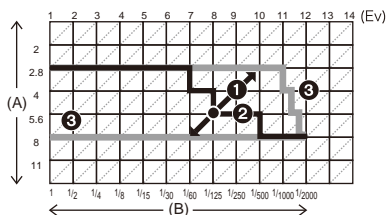

Note

- EV is an abbreviation of [Exposure Value], a unit indicating the amount of exposure. The EV changes with the aperture value or the shutter speed.
- Program Shift is canceled and the camera returns to normal Program AE Mode if more than 10 seconds pass after Program Shift is activated. However, the Program Shift setting is memorized.
- Depending on the brightness of the subject, Program Shift may not be activated.
- Program Shift is available in all ISO sensitivity settings except [ISO].

Focusing

Aim the AF area at the subject, and then press the shutter button halfway.

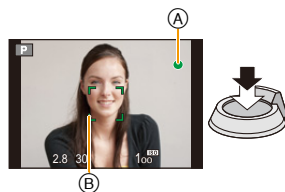

Focus	When the subject is focused	When the subject is not focused
Focus indication (A)	On	Blinks
AF area (B)	White→Green	White→Red
Sound	Beeps 2 times	Beeps 4 times

- The AF area may be displayed larger for certain zoom magnifications and in dark places.

About focus range

The focus range is displayed when operating the zoom.

- The focus range is displayed in red when it is not focused after pressing the shutter button halfway.

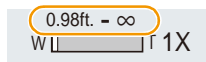

The focus range may change gradually depending on the zoom position.

e.g.: Range of focus during the Program AE Mode

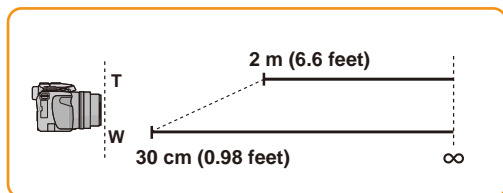

When the subject is not in focus (such as when it is not in the center of the composition of the picture you want to take)

- 1 Aim the AF area at the subject, and then press the shutter button halfway to fix the focus and exposure.
- 2 Press and hold the shutter button halfway while moving the camera as you compose the picture.



- You can repeatedly retry the actions in step 1 before pressing the shutter button fully.

Subjects and recording conditions which are difficult to focus

- Fast-moving subjects, extremely bright subjects or subjects without contrast
- When recording subjects through windows or near shiny objects
- When it is dark or when jitter occurs
- When the camera is too close to the subject or when taking a picture of both distant and near subjects

Taking Pictures Using the Automatic Function

(Intelligent Auto Mode)

Recording mode:  P A S M       

The camera will set the most appropriate settings to match the subject and the recording conditions so we recommend this mode for beginners or those who want to leave the settings to the camera and take pictures easily.

- The following functions are activated automatically.
 - Scene Detection/Backlight Compensation/Intelligent ISO sensitivity control/Auto White Balance/Face Detection/[AFS]/[Quick AF]/[i.Dynamic]/[i.Resolution]/[i.ZOOM]/[Stabilizer]/[AF Assist Lamp]/[Red-Eye Removal]/[Continuous AF]/[Zoom Mic]
- Image quality is fixed to .

1 Set the mode dial to [iA].

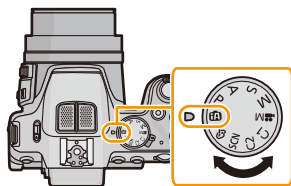

2 Press the shutter button halfway to focus and then press it fully to take the picture.

(A) Focus indication

- The AF area (B) is displayed around the subject's face by the Face Detection function. In other cases, it is displayed at the point on the subject which is in focus.
- You can set the AF tracking* by pressing [FOCUS]. For details, refer to P95. (AF tracking is canceled by pressing [FOCUS] again.)



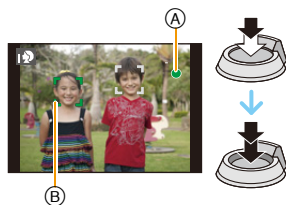





*You cannot use AF Tracking Function when [Color Mode] is set to [B&W] or [SEPIA].



Scene Detection

When the camera identifies the optimum scene, the icon of the scene concerned is displayed in blue for 2 seconds, after which its color changes to the usual red.

When taking pictures





 →	 [i-Portrait]	 [i-Scenery]
	 [i-Macro]	 [i-Night Portrait]* ¹
	 [i-Night Scenery]	 [iHandheld Nite Shot]* ²
	 [i-Sunset]	 [i-Baby]* ³





*1 Only when [] is selected.

*2 Only displayed when [iHandheld Nite Shot] is set to [ON].

*3 When [Face Recog.] is set to [ON], [] will be displayed for birthdays of registered faces already set only when the face of a person 3 years old or younger is detected.

When recording motion pictures





 →	 [i-Portrait]	 [i-Scenery]
	 [i-Low Light]	 [i-Macro]

- [] is set if none of the scenes are applicable, and the standard settings are set.
- When [, , or ] is selected, the camera automatically detects a person's face, and it will adjust the focus and exposure. **(Face Detection)**

DMC-FZ200

- If a tripod is used, for instance, and the camera has judged that camera shake is minimal when the Scene Mode has been identified as [], the shutter speed will be set to a maximum of 8 seconds. Take care not to move the camera while taking pictures.

DMC-FZ60

- If a tripod is used, for instance, and the camera has judged that camera shake is minimal when the Scene Mode has been identified as [], the shutter speed will be set to a maximum of 4 seconds. Take care not to move the camera while taking pictures.
- When [Face Recog.] is set to [ON], and the face similar to the registered face is detected, [R] is displayed in the top right of [, , and ].
- Due to conditions such as the ones below, a different scene may be identified for the same subject.
 - Subject conditions: When the face is bright or dark, the size of the subject, the color of the subject, the distance to the subject, the contrast of the subject, when the subject is moving
 - Recording conditions: Sunset, Sunrise, Under low brightness conditions, When the camera is shaken, When zoom is used
- To take pictures in an intended scene, it is recommended that you take pictures in the appropriate Recording Mode.

The Backlight Compensation

When there is a backlight, the subject appears darker and the camera will automatically attempt to correct it by increasing the brightness of the picture.

In Intelligent Auto Mode, backlight compensation works automatically. The [] is displayed on the screen when backlighting is detected. (Depending on the backlighting conditions, backlighting may not be detected correctly.)

Taking Pictures with Defocus Control Function

You can easily set the blurriness of the background while checking the screen.

1 Press the rear dial to display [].

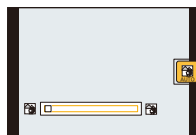

2 Press ◀▶ or rotate the rear dial to adjust.

- Press [] to reset the setting to the default state (AUTO).
- To adjust automatically, reset the setting to the default state (AUTO).



3 Press [MENU/SET] or the rear dial to set.



Changing the settings

Following menus can be set.

Menu	Item
[Rec]	[Picture Size]*/[Color Mode]/[Motion Deblur]/[iHandheld Nite Shot]/[iHDR]/[Face Recog.]
[Motion Picture]	[Rec Mode]/[Rec Quality]
[Setup]	[Clock Set]/[World Time]/[Beep]*/[Language]/[Stabilizer Demo.] <ul style="list-style-type: none"> • Menu items other than those listed above are not displayed, but you can set them in other Recording Modes.

• For the setting method of the menu, refer to [P52](#).

* Available settings may be different from other Recording Modes.

Menus specific to Intelligent Auto Mode

■ [Color Mode]

[Color Mode] can set the color effects of [STANDARD], [Happy], [B&W] or [SEPIA]. When [Happy] is selected, it is possible to automatically take a picture with a higher level of brilliance for the color brightness and vividness.

■ [Motion Deblur]

When [Motion Deblur] is set to [ON], [

■ [iHandheld Nite Shot]

When [iHandheld Nite Shot] is set to [ON] and [

■ [iHDR]

When [iHDR] is set to [ON] and there is, for example, strong contrast between the background and the subject, multiple still pictures are recorded with differing exposures and combined to create a single still picture rich in gradation.

- When [- In the case that a single picture is going to be composed from a burst, a message indicating that multiple pictures are to be recorded appears on the screen and burst recording is carried out. Note that burst recording will not take place if the camera determines that it can compensate for the difference in contrast without composing the picture from a burst.
- In the case of composition from a burst, ghost images may appear if the subject was moving.
- In the following cases, a compensated picture is not created.
 - When the zoom factor exceeds 24×
 - When recording in [Burst].

About the flash

- **Open the flash when the flash is to be used. (P75)**
- When [iA] is selected, [iA], [iA], [iA] or [iS] is set depending on the type of subject and brightness.
- When [iA], [iA] is set, Red-Eye Removal is enabled.
- Shutter speed will be slower during [iA] or [iS].

Recording using Intelligent Auto Plus Mode

You can adjust the brightness and the color balance in addition to the Intelligent Auto Mode function.

- 1 Press [MENU/SET] when in Intelligent Auto Mode.

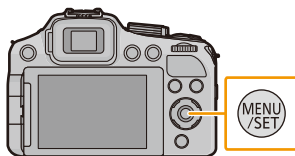

- 2 Press \blacktriangleright to select [iA] and then press [MENU/SET].



Adjusting the brightness, color balance, and background blur

1 Press the rear dial to display the options.

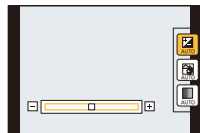

2 Press ▲/▼ to select the item

[]: Adjust the brightness.

[]: Adjust the background blur.

[]: Adjust the color balance.

3 Press ◀/▶ or rotate the rear dial to adjust.

- Press [/↶] to reset the setting to the default state (AUTO).

4 Press [MENU/SET] or the rear dial to set.

Note

- If you turn this unit off or switch another recording mode, the adjusted slider position returns to the default state (AUTO).

Recording Motion Pictures

Applicable modes:         

This can record full high definition motion pictures compatible with the AVCHD format or motion pictures recorded in MP4.

Audio will be recorded in stereo.

1 Start recording by pressing the motion picture button.

- (A) Available recording time
- (B) Elapsed recording time

- It is recommended that you close the flash when recording motion pictures.
- You can record motion pictures fitting each Recording Mode.
- Release the motion picture button right after you press it.
- The recording state indicator (red) (C) will flash while recording motion pictures.
- Focus can be achieved during recording by pressing [FOCUS].
- For the setting of the [Rec Mode] and [Rec Quality], refer to [P148,149](#).

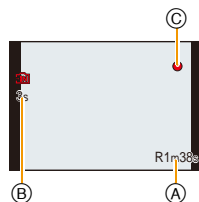
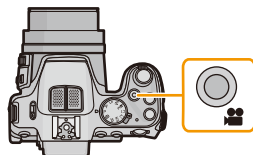

2 Stop the recording by pressing the motion picture button again.

■ About the recording format for recording motion pictures

This unit can record motion pictures in either AVCHD or MP4 formats.

AVCHD:

You can record high definition quality images with this format. It is suitable for viewing on a large format TV or for saving to disc.

DMC-FZ200**AVCHD Progressive:**

The [PSH] in [AVCHD] is a mode that allows motion pictures to be recorded at 1920×1080/60p, the highest quality* that complies with the AVCHD standard.

Recorded motion pictures can be saved and played back using this unit or "PHOTOfunSTUDIO".

* This means the highest quality for this unit.

MP4:

This is a simpler video format best used when extensive editing is needed, or when uploading videos to the Internet.

■ About the compatibility of the recorded motion pictures

Motion pictures recorded in [AVCHD] or [MP4] may be played back with poor picture or sound quality or playback may not be possible even when played back with equipment compatible with these formats. Also, the recording information may not be displayed properly. In this case, use this unit.

• For details on AVCHD Progressive and MP4 compatible devices, refer to the support sites below.

<http://panasonic.jp/support/global/cs/dsc/>

(This Site is English only.)

 **Note**

- Built-in memory can only store data as the [VGA] of [MP4].
- The available recording time displayed on the screen may not decrease regularly.
- Depending on the type of the card, the card access indication may appear for a while after recording motion pictures. This is not a malfunction.
- ISO sensitivity will operate as [AUTO] in Motion Picture Recording other than Creative Video. Also, [ISO Limit Set] will not function.
- There is a risk that the sound of zoom and button operations and the rubbing of the lens cap string will be recorded, and so care is necessary.
- The screen may be blacked out momentarily, or the unit may record noise due to static electricity or electromagnetic waves etc. depending on the environment of the motion picture recording.
- **About zooming while recording motion pictures**
 - Operating the zoom while recording motion pictures can take time for the image to come into focus.
 - If the Extended Optical Zoom are used before pressing the motion picture button, those settings will be cleared, so the shooting range will change dramatically.
- Even if the aspect ratio setting is the same in still and motion pictures, the angle of view may change at the start of the motion picture recording.
When [Video Rec Area] (P60) is set to [ON], angle of view during motion picture recording is displayed.
- If you end motion picture recording after a short time when using [Miniature Effect] of the Creative Control Mode, the camera may go on recording for a certain period. Please continue to hold the camera until the recording finishes.
- It is recommended to use a fully charged battery or AC adaptor (optional) when recording motion pictures.
- If while recording motion pictures using the AC adaptor and the power supply is cut off due to a power outage or if the AC adaptor is disconnected etc., the motion picture being recorded will not be recorded.
- Motion pictures cannot be recorded in the following cases.
 - [Panorama Shot]/[3D Photo Mode] (Scene Mode)
 - [Soft Focus]/[Star Filter] (Creative Control Mode)
- It will be recorded in the following categories for certain Recording Modes. A motion picture recording matching each Recording Mode will be performed for the ones not listed below.

Selected Recording Mode	Recording Mode while recording motion picture
<ul style="list-style-type: none"> • Program AE Mode • Aperture-Priority AE Mode • Shutter-Priority AE Mode • Manual Exposure Mode • [Sports]/[HDR]/[Pet] (Scene Mode) 	Normal motion picture
<ul style="list-style-type: none"> • [Baby1]/[Baby2] (Scene Mode) 	Portrait Mode
<ul style="list-style-type: none"> • [Night Portrait]/[Night Scenery]/[Handheld Night Shot] (Scene Mode) 	Low Light Mode

Recording still pictures while recording motion pictures

Still pictures can be recorded even while recording a motion picture. (simultaneous recording)

During motion picture recording, press the shutter button fully to record a still picture.

Note

- During motion picture recording, if you press the shutter button halfway, the camera will refocus and the refocus movement will be recorded to the motion picture being recorded. To prioritize the motion picture image, recording still pictures by fully pressing the shutter button, or creating still pictures after motion picture recording is recommended. (P48)
- Picture size and number of recordable pictures are displayed by pressing the shutter button halfway.
- Recording of motion picture will continue after taking the still picture.
- Recording is performed by the electronic shutter, so the recorded picture may appear warped.
- Pictures will be recorded with a picture size of [3.5M] (16:9). The picture quality may be different to [3.5M] (16:9) of standard pictures.
- **The flash setting is fixed to [☺].**
- Zooming will stop when a picture is recorded while zooming.
- Only one picture is recorded when Auto Bracket or White Balance Bracket is set.
- Simultaneous recording is not possible in the following cases:
 - When [Rec Mode] is set to [VGA] in [MP4]
 - Creative Video Mode
- In [Miniature Effect] of Creative Control Mode, there may be a slight delay between fully pressing the shutter button and recording.

DMC-FZ200

- You can record up to 20 pictures per motion picture recording.
- The burst speed while recording motion pictures is limited to the following. (P80)
 - [AF] and [AF]/[AF] cannot be set. Setting these will automatically switch to [AF] and [AF].
 - [AF], [AF], [AF] or [AF] cannot be set. Setting these will automatically switch to [AF].
- Only JPEG images are recorded when [Quality] is set to [RAW], [RAW] or [RAW]. (When set to [RAW] or [RAW], still pictures will be recorded in [Quality] of [RAW].)

DMC-FZ60

- You can record up to 1 picture per motion picture recording.

Playing Back Pictures ([Normal Play])

Press [▶].

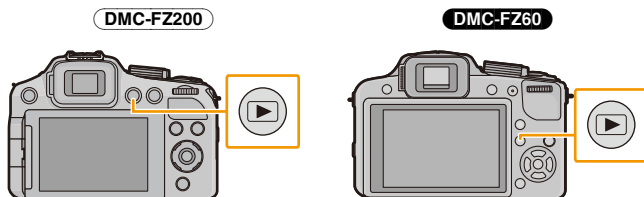

■ To finish playback

Press [▶] again, press the motion picture button or press the shutter button halfway.

📌 Note

- This camera complies with the DCF standard “Design rule for Camera File system” established by JEITA “Japan Electronics and Information Technology Industries Association” and with Exif “Exchangeable Image File Format”. Files which do not comply with the DCF standard cannot be played back.
- The lens barrel retracts about 15 seconds after switching from Recording Mode to Playback Mode.
- Pictures recorded with another camera may not be able to play back on this unit.

Selecting a picture

Press ◀ or ▶.

◀: Play back the previous picture

▶: Play back the next picture

Ⓐ File number

Ⓑ Picture number

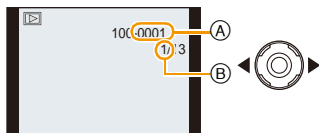

• If you press and hold ◀/▶, you can play back the pictures in succession.

• Speed of picture forwarding/rewinding changes depending on the playback status.

Displaying Multiple Screens (Multi Playback)

Rotate the zoom lever towards [W] (W).

1 screen → 12 screens → 30 screens → Calendar screen display

- Ⓐ Number of the selected picture and the total number of recorded pictures

- Rotate the zoom lever towards [Q] (T) to return to the previous screen.
- Pictures displayed using [!] cannot be played back.

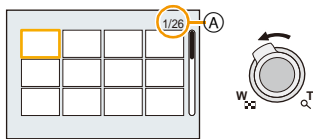

To return to normal playback

Press ▲/▼/◀/▶ to select a picture and then press [MENU/SET].

Using the Playback Zoom

Rotate the zoom lever towards [Q] (T).

1× → 2× → 4× → 8× → 16×

- When you rotate the zoom lever towards [W] (W) after enlarging the picture, the magnification becomes lower.
- When you change the magnification, the zoom position indication Ⓐ appears for about 1 second, and the position of the enlarged section can be moved by pressing ▲/▼/◀/▶.
- The more a picture is enlarged, the more its quality deteriorates.

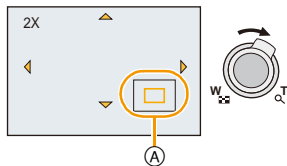

Switching the displayed image while maintaining the Playback Zoom

You can switch the displayed image while maintaining the same zoom magnification and zoom position for the Playback Zoom.

Rotating the rear dial to select the picture during Playback Zoom.

- The zoom position returns to the center in the following images.
 - Images with different aspect ratios
 - Images with different numbers of recorded pixels
 - Images with a different rotation direction (when [Rotate Disp.] is set to [ON])

Enlarge the focus point (display focus point)

This unit will remember the focus point during the recording, and it can be enlarged with that point as a center.

Press [FOCUS] during image playback.

- Focus point may not be the center of enlargement when it is at the edge of the image.
- It will return to the original enlargement if [FOCUS] is pressed again.
- Following pictures cannot be enlarged because there is no focus point:
 - Picture that was taken without focusing
 - Picture that was taken with Manual Focus
 - Picture that was taken with a different camera

Playing Back Motion Pictures

This unit was designed to play motion pictures using the AVCHD, MP4 and QuickTime Motion JPEG formats.

Press **◀/▶** to select a picture with a motion picture icon (such as [MP4/VGA]/[AVCHD/FSH]), and then press **▲** to play back.

(A) Motion picture icon

(B) The motion picture recording time

- After playback starts, the elapsed playback time is displayed on the screen. For example, 8 minutes and 30 seconds is displayed as [8m30s].
- Some information (recording information, etc.) is not displayed for motion pictures recorded in [AVCHD].

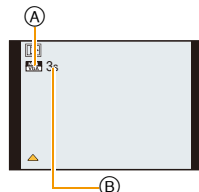

DMC-FZ200

- When playing back high speed motion pictures, select pictures with the high speed motion picture icon [HS].

Operations performed during Motion Picture Playback

The cursor displayed during playback is the same as ▲/▼/◀/▶.

▲	Play/Pause	
▼	Stop	
◀	Fast rewind* Frame-by-frame rewind (while pausing)	
▶	Fast forward* Frame-by-frame forward (while pausing)	
[W]	Reduce volume level	
[T]	Increase volume level	

* The fast forward/rewind speed increases if you press ▶/◀ again.

Note

- When using a high capacity card, it is possible that fast rewinding may be slower than usual.
- To play back the motion pictures recorded by this unit on a PC, use the "PHOTOfunSTUDIO" software on the CD-ROM (supplied).
- Motion pictures recorded with other camera may not be able to play back on this unit.
- Motion pictures recorded with [Miniature Effect] in Creative Control Mode play back at approximately 10 times speed.

DMC-FZ200

- When playing back high speed motion pictures, the motion picture recording time differs to the actual playback time.

Creating Still Pictures from a Motion Picture

You can create a single still picture from a recorded motion picture.

1 Press ▲ to pause motion picture playback.

2 Press [MENU/SET].

- Confirmation screen is displayed. It is executed when [Yes] is selected.
Exit the menu after it is executed.

 **Note**

- The picture is saved with the following recording sizes.

Recording format		Picture size
[AVCHD]		2 M (16:9)
[MP4]	([FHD]/[HD])	2 M (16:9)
	([VGA])	0.3 M (4:3)

- You may not be able to save still pictures from a motion picture taken on other equipment.
- Still pictures created from a motion picture may be coarser than with normal picture quality.

Deleting Pictures

Once deleted, pictures cannot be recovered.

- Pictures on the built-in memory or the card, which are being played back will be deleted.
- Pictures that are not in the DCF standard or those that are protected cannot be deleted.

Press [▶].

To delete a single picture

Select the picture to be deleted, and then press [🗑️/↩️].

- Confirmation screen is displayed.
Picture is deleted by selecting [Yes].

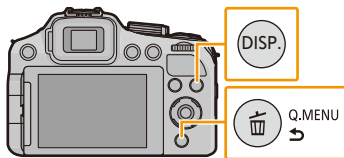

To delete multiple pictures or all the pictures

By using [Delete Multi], you can delete up to the following number of pictures.

DMC-FZ200 : 100 pictures

DMC-FZ60 : 50 pictures

1 Press [🗑️/↩️].

2 Press ▲/▼ to select [Delete Multi] or [Delete All] and then press [MENU/SET].

- [Delete All] → Confirmation screen is displayed. Pictures are deleted by selecting [Yes].
- It is possible to delete all pictures except the ones set as favorite when [All Delete Except Favorite] is selected with the [Delete All] set.



3 (When [Delete Multi] is selected) Press ▲/▼ / ◀/▶ to select the picture, and then press [DISP.] to set. (Repeat this step.)

- [🗑️] appears on the selected pictures. If [DISP.] is pressed again, the setting is canceled.

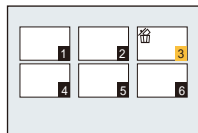

4 (When [Delete Multi] is selected) Press [MENU/SET].

- Confirmation screen is displayed. Pictures are deleted by selecting [Yes].

Note

DMC-FZ200





- Burst picture group (pictures with the burst icon [📀]) will be treated as a single picture. Deleting the burst picture group will delete all pictures in the group. (P154)
- Do not turn the camera off while deleting. Use a battery with sufficient battery power or the AC adaptor (optional).
- Depending on the number of pictures to be deleted, it may take some time to delete them.

Setting the Menu

The camera comes with menus that allow you to choose the settings for taking pictures and playing them back as you like. There are also menus that enable you to have more fun with the camera and use it more easily.

In particular, the [Setup] menu contains some important settings relating to the camera's clock and power. Check the settings of this menu before proceeding to use the camera.

■ Types of menus

Menu	Description of settings
 [Rec] (P133 to 147)	This menu lets you set the Coloring, Sensitivity, Aspect Ratio, Number of pixels and other aspects of the pictures you are recording.
 [Motion Picture] (P148 to 151)	This menu lets you set the [Rec Mode], [Rec Quality], and other aspects for motion picture recording.
 [Playback Mode] (P156 to 160)	This menu lets you select the setting of the playback methods such as playback or slide show of only the pictures set as [Favorite].
 [Playback] (P161 to 175)	This menu lets you set the Protection, Cropping or Print Settings, etc. of recorded pictures.
 [Setup] (P55 to 68)	This menu lets you perform the clock settings, select the operating beep tone settings and set other settings which make it easier for you to operate the camera.

Setting menu items

- If you set [Menu Resume] (P67) in the [Setup] menu to [ON], the screen shows the last selected menu item when the camera was turned off.

Example: In the [Rec] menu, change [AF Mode] from [■] (1-area-focusing) to [👤] (Face Detection)

1 Press [MENU/SET].

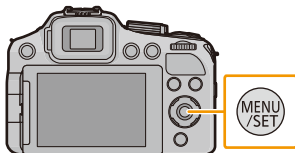

2 Press ▲/▼ or rotate the rear dial to select the menu item.

- It will switch to the next page when you reach the bottom. (It will also switch by rotating the zoom lever.)

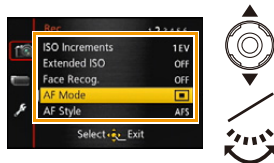

3 Press ► or the rear dial.

- Depending on the menu item, its setting may not appear or it may be displayed in a different way.

4 Press ▲/▼ or rotate the rear dial to select the settings.

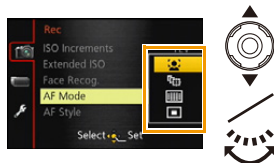

5 Press [MENU/SET] or the rear dial to set.

■ Close the menu

Press [MENU/SET] or press the shutter button halfway.

Switching to other menus

e.g.: Switching to the [Setup] menu from [Rec] menu

1 Press ◀.



2 Press ▼ or rotate the rear dial to select the [Setup] menu icon [🔧].

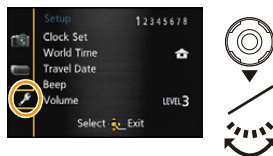

3 Press ▶ or the rear dial.

- Select a menu item next and set it.



Note

- There are functions that cannot be set or used depending on the modes or menu settings being used on the camera due to the specifications.

Using the Quick Menu

By using the Quick Menu, some of the menu settings can be easily found.

- The features that can be adjusted using Quick Menu are determined by the mode or a display style the camera is in.

1 Press [Q.MENU] when recording.

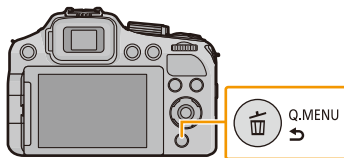

2 Press ◀/▶ to select the item and then press [MENU/SET].

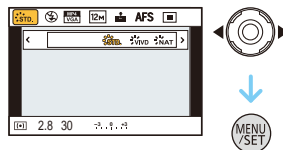

3 Press ◀/▶ to select the setting and then press [MENU/SET] to set.

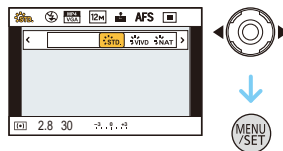

4 Press [Q.MENU] or press the shutter button halfway to close the menu.

■ Using the Quick Menu with the Rear Dial

You can also set the Quick Menu with the rear dial, without changing your position or the camera angle when using the viewfinder.

1 Press [Q.MENU] in the Recording Mode.

2 Rotate the rear dial to select the item, and press the rear dial.



3 Rotate the rear dial to select the setting, and press the rear dial to set.

- Exit the menu after it is set.









About the Setup Menu

[Clock Set], [Economy] and [Auto Review] are important items. Check their settings before using them.

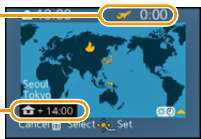
[Clock Set]	—
-------------	---

- Refer to [P27](#) for details.

[World Time]	<p>Set the time in your home area and travel destination. You can display the local times at the travel destinations and record them on the pictures you take.</p> <p>After selecting [Destination] or [Home], press ◀/▶ to select an area, and press [MENU/SET] to set.</p> <ul style="list-style-type: none"> • Set [Home] first thing after purchasing. [Destination] can be set after setting up [Home].
	<p> [Destination]: Travel destination area</p> <p>(A) Current time of the destination area (B) Time difference from home area</p> <p> [Home]: Your home area</p> <p>(C) Current time (D) Time difference from GMT (Greenwich Mean Time)</p> <div style="display: flex; justify-content: space-around; align-items: flex-start;"> <div style="text-align: center;"> <p>(A)</p>  </div> <div style="text-align: center;"> <p>(B)</p>  </div> <div style="text-align: center;"> <p>(C)</p>  </div> <div style="text-align: center;"> <p>(D)</p>  </div> </div>

- Press ▲ if you are using Summer Time []. (The time will move forward by 1 hour.) Press ▲ once more to return to the normal time.
- If you cannot find the travel destination in the areas displayed on the screen, set by the time difference from the home area.

[Travel Date]	Departure date and return date of the trip as well as the name of the travel destination can be set. You can display the number of days that have passed when playing back the pictures and stamp it on the recorded pictures with [Text Stamp] (P164).
	[Travel Setup]: [SET]: Departure date and return date are set. Elapsed days (how many days after) of the trip are recorded. [OFF] <ul style="list-style-type: none"> • The travel date is automatically canceled if the current date is after the return date. If the [Travel Setup] is set to [OFF], [Location] will be also set to [OFF].
	[Location]: [SET]: Travel destination is recorded at the time of recording. [OFF] <ul style="list-style-type: none"> • For details on how to enter characters, refer to “Entering Text” on P132.

- The number of days that have passed since the departure date can be printed out using the “PHOTOfunSTUDIO” bundled software on the CD-ROM (supplied).
- The travel date is calculated using the date in the clock setting and the departure date you set. If you set [World Time] to the travel destination, the travel date is calculated using the date in the clock setting and the travel destination setting.
- The travel date setting is memorized even if the camera is turned off.
- The number of days that have passed since the departure date is not recorded before the departure date.
- [Travel Date] cannot be set for motion pictures recorded with [AVCHD].
- [Location] cannot be recorded when taking motion pictures.
- [Travel Date] cannot be set in the Intelligent Auto Mode. Setting of other Recording Mode will be reflected.

[Beep]	This allows you to set the beep and shutter sound.	
	[Beep Level]: [α] [α]) ([High]) [α] [α] ([Low]) [α] [α] ([OFF])	[Shutter Vol.]: [α] [α]) ([High]) [α] [α] ([Low]) [α] [α] ([OFF])
	[Beep Tone]: [α] [α] / [α] [α] / [α] [α]	[Shutter Tone]: [α] [α] / [α] [α] / [α] [α]

[Volume]	Adjust the volume of the speaker to any of 7 levels.
-----------------	--

- When you connect the camera to a TV, the volume of the TV speakers does not change. Also, when connected, no sound is output from the camera speakers.

[Cust.Set Mem.]	Up to 4 current camera settings can be registered as custom settings.
	[C1]/[C2-1]/[C2-2]/[C2-3]

- Refer to [P127](#) for details.

DMC-FZ200 [AF/AE LOCK /Fn2] DMC-FZ60 [AF/AE LOCK /Fn1]	The function of the [AF/AE LOCK] button can be switched between AF/AE Lock and Fn(function).
	DMC-FZ200 [AF/AE LOCK]/[Fn2] DMC-FZ60 [AF/AE LOCK]/[Fn1]

- At the time of purchase, AF/AE Lock is selected.

[Fn Button Set]	Certain of the menus can be assigned to the function button. You may find it convenient to register a menu that you often use.
	DMC-FZ200 [Fn1 Button Set]/[Fn2 Button Set]/[Fn3 Button Set] DMC-FZ60 [Fn1 Button Set]/[Fn2 Button Set]

- Refer to [P104](#) for details.

DMC-FZ200 [Side Lever]	Switches the function of the side lever to zoom or to adjust focus when the unit is set to Manual Focus.
	[ZOOM]: Control the zoom by sliding the side lever. (P72) [FOCUS]: Adjusts the focus when the unit is set to Manual Focus. (P99) Sliding the side lever when AF is locked (when the shutter button is pressed halfway, or AF is locked with [AF/AE Lock]) will slightly adjust the focus when the unit is set to Auto Focus.



- The focus cannot be slightly adjusted with AF locked when recording motion pictures in Intelligent Auto Mode.

[LCD Display]/ [Viewfinder]	Brightness, color, or red or blue tint of the LCD monitor/viewfinder is adjusted.
	<p>[Brightness]: Adjust the brightness.</p> <p>[Contrast - Saturation]: Adjust the contrast or clarity of colors.</p> <p>[Red Tint]: Adjust the red tint.</p> <p>[Blue Tint]: Adjust the blue tint.</p> <p>1 Select the settings by pressing ▲/▼, and adjust with ◀/▶.</p> <p>2 Press [MENU/SET] to set.</p>



- It will adjust the LCD monitor when the LCD monitor is in use, and the viewfinder when the viewfinder is in use.
- Some subjects may appear differently from actuality on the LCD monitor/viewfinder. However, this does not affect the recorded pictures.

[LCD Mode]	These menu settings make it easier to see the LCD monitor when you are in bright places.
	<p>[A* [Auto Power LCD]*]: The brightness is adjusted automatically depending on how bright it is around the camera.</p> <p>[☐* [Power LCD]: The LCD monitor becomes brighter and easier to see even when taking pictures outdoors.</p> <p>[OFF]</p> <p>* Can be set only when Recording Mode is set.</p>



- The brightness of the pictures displayed on the LCD monitor is increased so some subjects may appear differently from actuality on the LCD monitor. However, this does not affect the recorded pictures.
- The LCD monitor automatically returns to normal brightness after 30 seconds when recording in Power LCD Mode. Press any button to make the LCD monitor bright again.
- When [LCD Mode] is set, the usage time is reduced.

[EVF Disp.Style]	This will set the display style of the Viewfinder.
	<p>[]: Viewfinder style</p> <p>[]: LCD monitor style</p>

- Refer to [P69](#) for details.

[LCD Disp.Style]	This will set the display style of the LCD monitor.
	[]: Viewfinder style []: LCD monitor style

- Refer to [P69](#) for details.

[Guide Line]	This will set the pattern of guide lines displayed when taking a picture.
	[ [ []: Press ▲/▼/◀/▶ to determine the position, then press the [MENU/SET] to set. Press [DISP.] to return to the default position. [OFF]

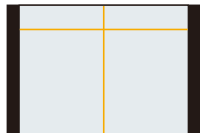

- When you align the subject on the horizontal and vertical guidelines or the cross point of these lines, you can take pictures with well-designed composition by viewing the size, the slope and the balance of the subject.
- In **[Panorama Shot]** in Scene Mode, the guideline is not displayed.

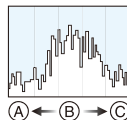

[Histogram]	This allows you to set either to display or not display the histogram.
	[ON]/[OFF]
	<p>A histogram is a graph that displays brightness along the horizontal axis (black to white) and the number of pixels at each brightness level on the vertical axis. It allows you to easily check a picture's exposure.</p> <p>(A) dark (B) optimal (C) bright</p>



- **When the recorded picture and the histogram do not match each other under the following conditions, the histogram is displayed in orange.**
 - When the Manual Exposure Assistance is other than [0] during exposure compensation or in the Manual Exposure Mode
 - When the flash is activated
 - When the flash is closed
 - When the brightness of the screen is not correctly displayed in dark places
 - When the exposure is not adequately adjusted
- The histogram is an approximation in Recording Mode.
- The histogram of a picture may not match in Recording Mode and Playback Mode.
- The histogram displayed in this camera does not match histograms displayed by picture editing software used in PCs etc.
- Histograms are not displayed in the following cases.
 - Intelligent Auto Mode
 - Multi Playback
 - When recording motion pictures
 - Playback Zoom
 - When HDMI mini cable is connected
 - Calendar Search

[Video Rec Area]	Angle of view for Motion Picture Recording can be checked.
	[ON]/[OFF]

- Motion picture recording area display is only an approximation.
- Recording area display may disappear when zooming to Tele depending on the picture size setting.
- It will be fixed to [OFF] during the Intelligent Auto Mode.

[Remaining Disp.]	This will switch display between the number of recordable pictures and available recording time.
	<p> ([Remaining Shots]): This will display the number of recordable pictures for still pictures.</p> <p> ([Remaining Time]): This will display the available recording time for motion pictures.</p>

[Highlight]	When the Auto Review function is activated or when playing back, white saturated areas appear blinking in black and white. This does not affect the recorded image.
	[ON]/[OFF]

- If there are any white saturated areas, we recommend compensating the exposure towards negative (P79) referring to the histogram and then taking the picture again. It may result in a better quality picture.
- There may be white saturated areas if the distance between the camera and the subject is too close when taking pictures with the flash.
- Highlighting does not work during Multi Playback, Calendar Search, Playback Zoom, or Motion Picture Playback.

[ON]**[OFF]**

[Expo.Meter]	Set whether or not to display the exposure meter.
	[ON]/[OFF]

- Set to [ON] to display the [Expo.Meter] when correcting exposure, performing Program Shift, setting aperture, and setting shutter speed.
- Unsuitable areas of the range are displayed in red.
- When [Expo.Meter] is not displayed, switch the display information for screen by pressing [DISP.]. (P69)
- The [Expo.Meter] disappears after approximately 4 seconds if no operation is performed.

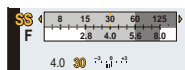

[Lens Resume]	This unit memorizes a zoom position and an MF (Manual Focus) position when it is turned off.
	[Zoom Resume]: When you turn this unit on, the zoom positions when you last turned this unit off are automatically restored. [ON]/[OFF]
	[MF Resume]: It will memorize the MF position set with the Manual Focus. It will resume the memorized Manual Focus position when you return to Manual Focus Recording. [ON]/[OFF]

- MF position will be memorized in the following cases:
 - Turning the camera off
 - When switching to a type of focus other than Manual Focus
 - When switched to Playback Mode
- Zoom position will be set all the way to wide when the [Zoom Resume] is set to [OFF].
- When [MF Resume] is set to [OFF], MF position will be the distance focused at the time of recording in Manual Focus.
- Depending on the recording conditions, the memorized MF positions and resumed MF positions might be different.

[MF Assist]	In Manual Focus, the screen to facilitate focusing on the subject is displayed.
	[ON]: The center of the screen is enlarged over the whole screen. [OFF]

- Refer to [P100](#) for details.

[Economy]	You can conserve the battery life by setting these menus. Also, it will turn off the LCD monitor automatically when not in use to prevent discharge of the battery.
	[Sleep Mode]: The camera is automatically turned off if the camera has not been used for the time selected on the setting. [10MIN.]/[5MIN.]/[2MIN.]/[1MIN.]/[OFF]
	[Auto LCD Off]: The LCD monitor is automatically turned off if the camera has not been used for the time selected on the setting. [30SEC.]/[15SEC.]/[OFF]
	[Live View Mode]: Sets the LCD monitor to display in such a way that power consumption is reduced. [NORMAL]/[ECO]

- Press the shutter button halfway or turn the camera off and on to cancel [Sleep Mode].
- [Sleep Mode] is set to [5MIN.] in the Intelligent Auto Mode.
- Press any button to turn on the LCD monitor again.
- [Sleep Mode] does not work in the following cases.
 - When using the AC adaptor
 - When connecting to a PC or a printer
 - When recording or playing back motion pictures
 - During a slide show
 - [Auto Demo]
- [Auto LCD Off] does not work in the following cases.
 - When using the AC adaptor
 - When connecting to a PC or a printer
 - Intelligent Auto Mode
 - While the Self-timer is set
 - When recording or playing back motion pictures
 - During a slide show
 - While the menu screen is displayed
 - [Auto Demo]
- [Sleep Mode] is fixed to [2MIN.] when [Auto LCD Off] is set to [15SEC.] or [30SEC.].
- When [Live View Mode] is set to [ECO] the image quality on the recording screen may be worse than when it is set to [NORMAL], but this does not affect the recorded image.
- When [Live View Mode] is set to [NORMAL], the usage time is reduced.

[Play on LCD]	If you selected the Viewfinder in a Recording Mode, the display will automatically switch to the LCD monitor when playing back the pictures.
	[ON] [OFF]

[Auto Review]	Set the length of time that the picture is displayed after taking the still picture.
	[HOLD]: The pictures are displayed until one of the buttons is pressed. [2 SEC.] [1 SEC.] [OFF]



- [Auto Review] is activated regardless of its setting in the following cases.
 - When using Auto Bracket
 - During the Burst Mode
- The Auto Review function is fixed to [2 SEC.] in the following cases.
 - Intelligent Auto Mode
- [Auto Review] does not work when recording motion pictures.

[No.Reset]	Reset the file number of the next recording to 0001.
-------------------	--

- The folder number is updated and the file number starts from 0001.
- A folder number between 100 and 999 can be assigned.
When the folder number reaches 999, the number cannot be reset. We recommend formatting the card (P68) after saving the data on a PC or elsewhere.
- To reset the folder number to 100, format the built-in memory or the card first and then use this function to reset the file number.
A reset screen for the folder number will then appear. Select [Yes] to reset the folder number.

[Reset]	The [Rec] or [Setup] menu settings are reset to the initial settings.
----------------	---

- When the [Reset] setting is selected during recording, the operation that resets the lens is also performed at the same time. You will hear the sound of the lens operating but this is normal and not indicative of malfunctioning.
- When the Recording Mode settings are reset, data registered with [Face Recog.] will be also reset, too.
- The folder number and the clock setting are not changed.
- When [Setup] menu settings are reset, the following settings are also reset.
 - The birthday and name settings for [Baby1]/[Baby2] and [Pet] in Scene Mode.
 - The [Travel Date] setting. (Departure date, return date, destination)
 - The [World Time] setting.
 - The [Cust.Set Mem.] setting.
 - Position memorized in [Lens Resume]/[Menu Resume].

[USB Mode]	Select the USB communication system after or before connecting the camera to your PC or your printer with the USB connection cable (supplied).
	<p> [Select on connection]: Select either [PC] or [PictBridge(PTP)] if you connected the camera to a PC or a printer supporting PictBridge.</p> <p> [PictBridge(PTP)]: Set after or before connecting to a printer supporting PictBridge.</p> <p> [PC]: Set after or before connecting to a PC.</p>



[Output]	This sets how the unit connects to a television etc.
	<p>[TV Aspect]: Set to match the type of TV.</p> <p>16:9 [16:9]: When connecting to a 16:9 screen TV.</p> <p>4:3 [4:3]: When connecting to a 4:3 screen TV.</p> <ul style="list-style-type: none"> • This will work when the AV cable (optional) is connected.

[VIERA Link]	Set so this unit can be controlled by the remote control of the VIERA by automatically coupling this unit with the VIERA Link compatible equipment using HDMI mini cable (optional).
	<p>[ON]: Remote control operation of the VIERA Link compatible equipment is enabled. (Not all operations are possible) Button operation of the main unit will be limited.</p> <p>[OFF]: Operation is performed with the buttons on this unit.</p>

- This will work when the HDMI mini cable (optional) is connected.
- Refer to [P178](#) for details.

[3D Playback]	Set the output method for 3D pictures.
	<p>[3D]: Set when connecting to a 3D compatible television.</p> <p>[2D]: Set when connecting to a television not compatible with 3D. Set this when you would like to view pictures in 2D (conventional image) on a 3D compatible television.</p>

- This will work when the HDMI mini cable (optional) is connected.
- Refer to [P180](#) for the method to playback 3D pictures in 3D.

[Rotate Disp.]	This mode allows you to display pictures vertically if they were recorded holding the camera vertically.
	<p> ([On]): Rotate pictures on a TV and the LCD display so that they are displayed vertically.</p> <p> ([External Only]): Pictures are displayed vertically by rotating when played back on TV.</p> <p>[OFF]</p>

- Refer to [P45](#) for information about how to play back pictures.
- When you play back pictures on a PC, they cannot be displayed in the rotated direction unless the OS or software is compatible with Exif. Exif is a file format for still pictures which allows recording information, etc. to be added. It was established by "JEITA (Japan Electronics and Information Technology Industries Association)".
- It may not be possible to rotate pictures that have been recorded with other equipment.
- The display is not rotated during Multi Playback.

[Scene Menu]	Set the screen that appears as you switch the mode dial to [SCN].
	<p>[AUTO]: Display the Scene Mode menu.</p> <p>[OFF]: Display the recording screen of the currently selected Scene Mode.</p>

[Menu Resume]	The last operated menu position is saved even if the camera is turned off.
	[ON]/[OFF]

[Version Disp.]	—
------------------------	---

- It is possible to check which version of firmware is on the camera.
- Press [MENU/SET] on the version display screen to display information about the software on the unit.

[Format]	The built-in memory or card is formatted. Formatting irretrievably deletes all the data so check the data carefully before formatting.
-----------------	--

- Use a battery with sufficient battery power or the AC adaptor (optional) when formatting. Do not turn the camera off during formatting.
- If a card has been inserted, only the card is formatted. To format the built-in memory, remove the card.
- If the card has been formatted on a PC or other equipment, format it on the camera again.
- It may take longer to format the built-in memory than the card.
- If you cannot format, contact the dealer or Panasonic.

For USA and Puerto Rico assistance, please call:
1-800-211-PANA(7262) or, contact us via the web at:
<http://www.panasonic.com/contactinfo>

For Canadian assistance, please call:
1-800-99-LUMIX (1-800-995-8649) or
send e-mail to: lumixconclerge@ca.panasonic.com

[Language]	Set the language displayed on the screen.
-------------------	---

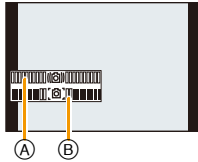

- If you set a different language by mistake, select **[Q]** from the menu icons to set the desired language.

[Demo Mode]	<p>Displays the amount of jitter the camera has detected. ([Stabilizer Demo.] The camera's features are displayed as slide shows. ([Auto Demo])</p>
	<p>[Stabilizer Demo.] (A) Amount of jitter (B) Amount of jitter after correction</p>  <p>[Auto Demo]: [ON]/[OFF]</p>

- The Stabilizer function is switched between ON and OFF every time [MENU/SET] is pressed during the [Stabilizer Demo].
- [Stabilizer Demo.] is an approximation.
- [Auto Demo] is not output to the television.
- Press [MENU/SET] to close [Auto Demo].

About the LCD Monitor/Viewfinder

Press [DISP.] to change.

- When the menu screen appears, the [DISP.] button is not activated. During Playback Zoom, while playing back Motion Pictures and during a Slide Show, you can only select **(E)** or **(G)**.
- You can select between **[**] (LCD monitor style) and **[**] (viewfinder style) for each of the LCD monitor and the Viewfinder display screen using [LCD Disp.Style] and [EVF Disp.Style] in the [Setup] menu.

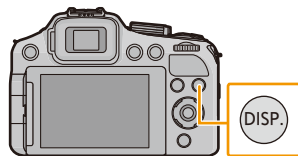

In Recording Mode

[] (LCD monitor style)

(A) Normal display

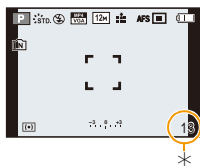

(B) No display

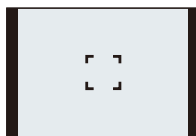

[] (viewfinder style)

(C) Normal display

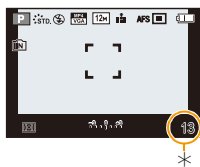

(D) Normal display



- * You can switch between available recording time and number of recordable pictures by setting [Remaining Disp.] in [Setup] menu.

In Playback Mode

Ⓔ Normal display



Ⓕ Display with recording information*1



Ⓖ No display*2

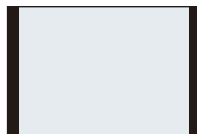

*1 If the [Histogram] in [Setup] menu is set to [ON], Histogram will be displayed.

*2 Name of the registered person in [Face Recog.] is displayed when [DISP.] is pressed.

Taking Pictures with the Zoom

Applicable modes:        

Using the Optical Zoom/Using the Extended Optical Zoom (EZ)/Using the Intelligent Zoom/Using the Digital Zoom

You can zoom in to make people and objects appear closer or zoom out to record landscapes in wide angle.

Extended Optical Zoom works except when the maximum recordable pixels are set. This function allows you to take a picture with additional enlargement without deteriorating the image quality.

To make subjects appear further away use (Wide)

Rotate the zoom lever towards **Wide**.



To make subjects appear closer use (Tele)

Rotate the zoom lever towards **Tele**.



■ Changing the zoom speed

The zoom speed becomes slower when the rotation angle is small and the zoom speed becomes faster when the rotation angle is large.

- (A) Fast
- (B) Slow

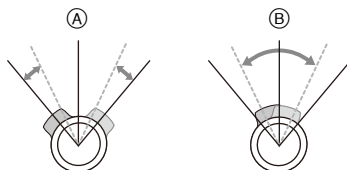

■ Storing the zoom position (Zoom resume)

- Refer to [P62](#) for details.

DMC-FZ200

Control the zoom with the side lever

Using the side lever to control the zoom when taking pictures with the Viewfinder is useful for reducing shaking as the camera can be kept stable.

Using the side lever can also increase techniques used for taking pictures.

- When controlling the zoom with the side lever, set [Side Lever] in the [Setup] menu to [ZOOM]. (P57)
- You can operate the zoom at 2 speeds. The zoom speed becomes slower when the sliding distance is small and the zoom speed becomes faster when the sliding distance is large.
- You cannot use the zoom lever and the side lever simultaneously.

To make subjects appear closer use (Tele)

Slide the side lever towards Tele.

To make subjects appear further away use (Wide)

Slide the side lever towards Wide.



■ Types of zooms

Feature	Optical Zoom	Extended Optical Zoom (EZ)
Maximum magnification	24×	DMC-FZ200 46.9× ^{*1} DMC-FZ60 54× ^{*1}
Picture quality	No deterioration	No deterioration
Conditions	None	[Picture Size] with EZ (P135) is selected.

*1 This includes the optical zoom magnification. The magnification level differs depending on [Picture Size] setting.

The zoom functions below can also be used to further increase the zoom magnification.

Feature	Intelligent Zoom	Digital Zoom
Maximum magnification	2×	4× ^{*2}
Picture quality	Zoom in while limiting deterioration	The higher the magnification level, the greater the deterioration.
Conditions	[i.Resolution] (P142) on the [Rec] menu is set to [i.ZOOM].	[Digital Zoom] (P142) on the [Rec] menu is set to [ON].

*2 2× when [i.Resolution] in the [Rec] menu is set to [i.ZOOM].

■ Screen display

- (A) Extended Optical Zoom indication
- (B) Optical Zoom range
- (C) Intelligent Zoom range
- (D) Digital Zoom range
- (E) Zoom magnification



• When using the zoom function, an estimate of the focus range will appear in conjunction with the zoom display bar. [Example: 0.3 m (0.98 ft.) –∞]

Note

- The indicated zoom magnification is an approximation.
- “EZ” is an abbreviation of “Extended Optical Zoom”. It is possible to take more magnified pictures with the optical zoom.
- The lens barrel extends or retracts according to the zoom position. Take care not to interrupt the motion of the lens barrel while the zoom lever is rotated.
- When you rotate the zoom lever, you may hear some sound from the camera or the camera may shake. This is not a malfunction.
- When using the Digital Zoom, we recommend using a tripod and the Self-timer (P84) for taking pictures.
- The Extended Optical Zoom cannot be used in the following cases.
 - [Motion Deblur] (Intelligent Auto Mode)
 - When the Burst Mode is set to [📷].
 - [Toy Effect] (Creative Control Mode)
 - [Panorama Shot]/[HDR]/[High Sens.]/[3D Photo Mode] (Scene Mode)
 - When recording motion pictures

DMC-FZ200

- When the Burst Mode is set to [📷] or [📷].
- When [Quality] is set to [RAW📷], [RAW📷] or [RAW]

DMC-FZ60

- Macro Zoom Mode

- The Intelligent Zoom cannot be used in the following cases.
 - [Motion Deblur] (Intelligent Auto Mode)
 - When the Burst Mode is set to [📷].
 - [Toy Effect] (Creative Control Mode)
 - [Panorama Shot]/[Handheld Night Shot]/[HDR]/[High Sens.]/[3D Photo Mode] (Scene Mode)

DMC-FZ200

- When the Burst Mode is set to [📷] or [📷].

DMC-FZ60

- Macro Zoom Mode

- [Digital Zoom] cannot be used in the following cases.
 - Intelligent Auto Mode
 - When the Burst Mode is set to [📷].
 - [Toy Effect]/[Miniature Effect] (Creative Control Mode)
 - [Panorama Shot]/[Handheld Night Shot]/[HDR]/[High Sens.]/[3D Photo Mode] (Scene Mode)

DMC-FZ200

- When the Burst Mode is set to [📷] or [📷].
- [High Speed Video] (Creative Video Mode)
- When [Quality] is set to [RAW📷], [RAW📷] or [RAW]

Taking Pictures using the Flash

Applicable modes: **[A]** **[P]** **[A]** **[S]** **[M]** **[C1]** **[C2]** **[SCN]**

■ To open/close the flash

DMC-FZ200

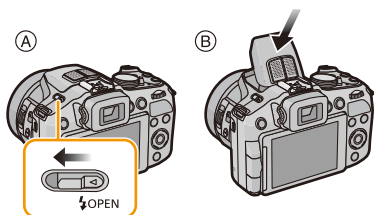

DMC-FZ60

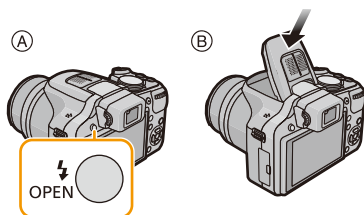

DMC-FZ200

(A) To open the flash

Slide the flash open lever.

(B) To close the flash

Push the top of the flash cover until it clicks.

DMC-FZ60

(A) To open the flash

Press the flash open button.

(B) To close the flash

Press the flash until it clicks.

Note

- Be sure to close the flash when not in use.
- The flash setting is fixed to **[☺]** while the flash is closed.
- **Be careful not to catch a finger when closing a flash bulb.**
- Be sure to keep the flash clean, clear of dust and avoid exposure to anything sticky. This may cause the flash to stick and not open.
- You cannot close the flash by pushing the microphone or its periphery. Forcibly closing the flash can damage the camera.

Switching to the appropriate flash setting









Set the flash to match the recording.

- Open the flash.

1 Select [Flash] in the [Rec] menu. (P52)

2 Press ▲/▼ to select a mode and then press [MENU/SET].

- Exit the menu after it is set.

Settings	Description of settings
 A (([Auto])  A (([iAuto])*1	The flash is automatically activated when the recording conditions make it necessary.
 A  (([Auto/Red-Eye])*2	The flash is automatically activated when the recording conditions make it necessary. It is activated once before the actual recording to reduce the red-eye phenomenon (eyes of the subject appearing red in the picture) and then activated again for the actual recording. • Use this when you take pictures of people in low lighting conditions.
 (([Forced Flash On])	The flash is activated every time regardless of the recording conditions. • Use this when your subject is back-lit or under fluorescent light.
 S  (([Slow Sync./Red-Eye])*2	When taking pictures against a dark background landscape, this feature will slow the shutter speed when the flash is activated. Dark background landscape will appear brighter. Simultaneously it reduces the red-eye phenomenon. • Use this when you take pictures of people in front of a dark background.
 (([Forced Flash Off])	The flash is not activated in any recording conditions. • This item is not displayed on the menu. To set the camera to [🚫], close the flash. • Use this when you take pictures in places where the use of the flash is not permitted.

*1 This can be set only when Intelligent Auto Mode is set. The icon changes depending on the type of subject and brightness. (P39)

*2 The flash is activated twice. The subject should not move until the second flash is activated.











Flash interval depends on the brightness of the subject.

[Red-Eye Removal] (P145) on the [Rec] menu is set to [ON], [🚫] appears on the flash icon.

■ Available flash settings in Recording Mode

The available flash settings depend on the Recording Mode.

(○: Available, —: Not available, ●: Scene Mode initial setting)

					
 *	○*	—	—	—	○
P / A	○	○	○	○	○
S / M	○	○	○	—	○
	○	●	○	—	○
	—	—	—	—	●
	●	—	○	—	○
	—	—	—	●	○

* [] is displayed.

- The flash setting may change if the Recording Mode is changed. Set the flash setting again if necessary.
- The flash setting is memorized even if the camera is turned off. However, the Scene Mode flash setting is reset to the initial setting when the Scene Mode is changed.
- Flash will not be activated when recording motion picture.





■ The available flash range

- The available flash range is an approximation.

	Wide	Tele
[AUTO] in [Sensitivity]	30 cm (0.98 feet) to 13.5 m (44 feet)*1	DMC-FZ200 1.0 m (3.3 feet) to 13.5 m (44 feet)*1 DMC-FZ60 1.0 m (3.3 feet) to 7.3 m (24 feet)*1

*1 When the [ISO Limit Set] (P138) is set to [AUTO].



■ Shutter speed for each flash setting

Flash setting	Shutter speed (Sec.)	Flash setting	Shutter speed (Sec.)
	DMC-FZ200		DMC-FZ200
	1/60*2 to 1/4000		1*2 to 1/4000
	DMC-FZ60		DMC-FZ60
	1/60*2 to 1/2000		1*2 to 1/2000

*2 When [Sensitivity] is set to [AUTO]. The shutter speed may vary depending on the [ISO Limit Set] setting.

- In Intelligent Auto Mode, shutter speed changes depending on the identified scene.
- In Scene Mode, the shutter speeds will differ from those described above.

Note

- When recording with the flash, white saturation can occur if the subject is too close. If [Highlight] of the [Setup] menu is set to [ON], regions of white saturation will blink black and white when you play back or use Auto Review. In this case, we recommend that you adjust [Flash Adjust.] (P145) in the minus direction and record the pictures again.
- Do not bring the flash too close to objects or close the flash while it is activated. The objects may be discolored by its heat or lighting.
- Do not close the flash soon after the flash is activated prior to taking pictures due to AUTO/Red-Eye Reduction etc. It causes a malfunction.
- Recording a subject from too close, or without sufficient flash will not provide the appropriate level of exposure, and may result in a picture that is too white or dark.
- When the flash is being charged, the flash icon blinks red, and you cannot take a picture even when you press the shutter button fully.
- If recording a subject without sufficient flash, the White Balance may not be properly adjusted.
- The flash effect may not be sufficient when shutter speed is fast.
- It may take time to charge the flash if you repeat taking a picture. Take a picture after the access indication disappears.
- The Red-Eye Reduction effect differs between people. Also, if the subject was far away from the camera or was not looking at the first flash, the effect may not be evident.
- Flash is fixed to  when the [Conversion] (P145) is set to  or .

Compensating the Exposure

Applicable modes:        

Use this function when you cannot achieve appropriate exposure due to the difference in brightness between the subject and the background.

1 Press the rear dial to set Exposure Compensation to a selected state.

(A) Exposure Compensation value



2 Rotate the rear dial to compensate the exposure.

(B) Exposure meter

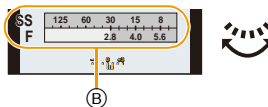

Underexposed



Properly exposed



Overexposed



Compensate the exposure towards positive.

Compensate the exposure towards negative.

Note

- Set the value to [0] when you do not compensate the exposure.
- The set exposure value is memorized even if the camera is turned off.
- The compensation range of the exposure will be limited depending on the brightness of the subject.

Taking Pictures Using Burst Mode

Applicable modes: **[A]** **P** **A** **S** **M** **[C1]** **[C2]** **[SCN]** **[B]**

Pictures are taken continuously while the shutter button is pressed.

Burst speed can be selected to match the recording conditions or subjects.

1 Press **[]**.

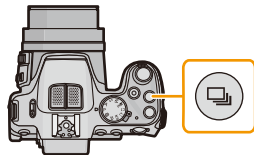





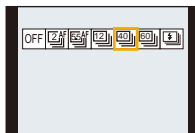







2 Press **◀/▶** to select the burst speed and then press **[MENU/SET]**.

- Description of recording conditions suitable for each burst speed is displayed by pressing **[DISP.]**.



DMC-FZ200

Burst speed (pictures/second)		Features	Maximum recordable pictures (pictures)
 / 	2	<ul style="list-style-type: none"> When [] or [] is set, the focus is fixed to the first picture. 	100*1
 / 	5.5	<ul style="list-style-type: none"> When [] or [] is set, the focus is adjusted for each picture. The exposure and White Balance are adjusted for each picture. 	
	12	<ul style="list-style-type: none"> The focus, exposure and White Balance are fixed to the first picture. 	12*2
 *3	40	<ul style="list-style-type: none"> The focus, exposure and White Balance are fixed to the first picture. Pictures taken in the Burst Mode will be recorded as a single burst picture group. 	40
 *3	60	<ul style="list-style-type: none"> The range that can be recorded will become smaller when it is set to []. 	60
 *4	—	<ul style="list-style-type: none"> Still pictures are taken continuously with flash. Settings for focus, exposure, shutter speed, ISO sensitivity, flash output are fixed to the first picture. 	5











*1 The number of Burst recording pictures are limited by the picture-taking conditions and the type and/or status of the card used.

*2 If [Quality] is set to [RAW $\frac{1}{1}$], [RAW $\frac{1}{2}$] or [RAW], the maximum recordable pictures is 11.

*3 This item cannot be set in the Intelligent Auto Mode.

*4 This option is available only in Program AE Mode, Aperture-Priority AE Mode or Shutter Priority AE mode.

DMC-FZ60

Burst speed (pictures/second)		Features	Maximum recordable pictures (pictures)
 / 	2	<ul style="list-style-type: none"> When [] or [] is set, the focus is fixed to the first picture. 	100*1
 / 	5	<ul style="list-style-type: none"> When [] or [] is set, the focus is adjusted for each picture. The exposure and White Balance are adjusted for each picture. 	
	10	<ul style="list-style-type: none"> The focus, exposure and White Balance are fixed to the first picture. 	3
 *2	—	<ul style="list-style-type: none"> Still pictures are taken continuously with flash. Settings for focus, exposure, shutter speed, ISO sensitivity, flash output are fixed to the first picture. 	5

*1 The number of Burst recording pictures are limited by the picture-taking conditions and the type and/or status of the card used.

*2 This option is available only in Program AE Mode, Aperture-Priority AE Mode or Shutter Priority AE mode.

 **Note**

- When [M], [L] or [H] is selected, the picture size setting will become as shown below.

Aspect ratio	DMC-FZ200 [M]	DMC-FZ200 [L]	[H]
[4:3]	[5M], [3M], [2M], [0.3M]	[2.5M], [0.3M]	[3M]
[3:2]	[4.5M], [2.5M], [0.3M]	[3M], [0.3M]	[2.5M]
[16:9]	[3.5M], [2M], [0.2M]	[3.5M], [0.2M]	[2M]
[1:1]	[3.5M], [2.5M], [0.2M]	[2M], [0.2M]	[2.5M]

- When the Self-Timer is used, the number of recordable pictures in Burst Mode is fixed to 3. (5 pictures in [H])
- The burst speed (pictures/second) may become slower depending on the recording environment such as in dark places, if the ISO sensitivity is high etc.
- Burst Mode is not canceled when the camera is switched off.
- The flash setting is fixed to [☺] (except for [H]).**
- The Burst Mode cannot be used in the following cases.
 - When the Self-timer is set to [10s / 3pictures]
 - [Toy Effect]/[Miniature Effect]/[Soft Focus]/[Star Filter] (Creative Control Mode)
 - [Panorama Shot]/[Handheld Night Shot]/[HDR]/[3D Photo Mode] (Scene Mode)
- The zoom cannot be used when recording burst pictures.
- Depending on the operating conditions, it may take time to take the next picture if you repeat taking a picture.
- It may take time to save pictures taken in Burst Mode on the card. If you take pictures continuously while saving, the maximum number of recordable pictures decreases. For continuous shooting, use of a high speed memory card is recommended.**

DMC-FZ200

- When [M], [L] or [H] is selected, [Quality] can only be set to [■] or [■].
- Recording is performed by the electronic shutter when [M] or [L] is selected, so the recorded picture may appear warped.
- When using AF Lock, the camera does not adjust the focus of each picture even if you use the setting [AF] or [AF].
- When [AF] or [AF] is set, focus prediction will be performed in a possible range to prioritize the burst speed. Therefore, if you try to take a picture of a subject that is moving fast, it may have trouble with focusing or it may take time to focus.
- When [M], [L] or [H] is set, the recording may be brighter or darker from the second picture depending on changes in the brightness of the subject.

DMC-FZ60

- When using AF Lock, the camera does not adjust the focus of each picture even if you use the setting [AF] or [AF].
- When [AF] or [AF] is set, focus prediction will be performed in a possible range to prioritize the burst speed. Therefore, if you try to take a picture of a subject that is moving fast, it may have trouble with focusing or it may take time to focus.
- When [M] is set, the recording may be brighter or darker from the second picture depending on changes in the brightness of the subject.

Taking Pictures with the Self-Timer

Applicable modes: **A** **P** **A** **S** **M** **C1** **C2** **SCN** 

1 Press **▼** [].

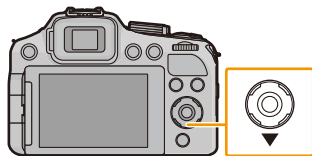

2 Press **▲/▼** to select the item and then press [**MENU/SET**].

Item	Description of settings
[10sec.]	Picture is taken 10 seconds after shutter is pressed.
[10s / 3pictures]	After 10 seconds the camera takes 3 pictures at about 2 seconds intervals after shutter is pressed.
[2sec.]	Picture is taken 2 seconds after shutter is pressed. • When using a tripod etc., this setting is a convenient way to avoid the jitter caused by pressing the shutter button.
[Off]	—

3 Press the shutter button halfway to focus and then press it fully to take the picture.

- The Self-timer indicator **A** blinks and the shutter is activated after 10 seconds (or 2 seconds).
- When [10s / 3pictures] is selected, the Self-timer indicator blinks again after the first and the second pictures are taken and the shutter is activated 2 seconds after it blinks.

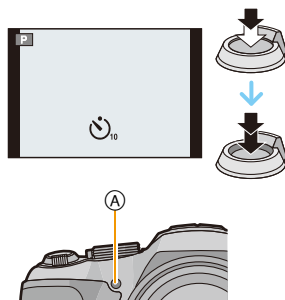

 **Note**

- When you press the shutter button once fully, the subject is automatically focused just before recording. In dark places, the Self-timer indicator will blink and then may turn on brightly operating as an AF Assist Lamp to allow the camera to focus on the subject.
- We recommend using a tripod when recording with the Self-timer.
- Depending on the recording conditions, the recording interval may become more than 2 seconds when [10s / 3pictures] is selected.
- It is not possible to set [10s / 3pictures] in the following cases.
 - Intelligent Auto Mode
 - When using Auto Bracket
 - When using White Balance Bracket
 - During the Burst Mode
 - [Panorama Shot] (Scene Mode)
- Setting of the self-timer cannot be performed in following conditions.
 - [3D Photo Mode] (Scene Mode)
 - When recording motion pictures

Setting the Light Sensitivity

Applicable modes: 

This allows the sensitivity to light (ISO sensitivity) to be set. Setting to a higher figure enables pictures to be taken even in dark places without the resulting pictures coming out dark.

1 Press **▲** [ISO].

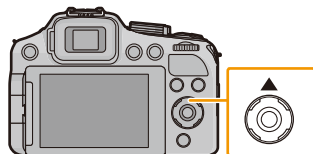

2 Press **▲/▼** to select the ISO sensitivity and then press [MENU/SET] to set.

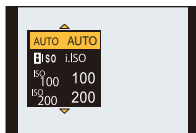

Settings	Description of settings
AUTO	The ISO sensitivity is automatically adjusted according to the brightness. • Maximum [1600] ^{*1}
 ISO	The ISO sensitivity is adjusted according to the movement of the subject and the brightness. • Maximum [1600] ^{*1}
DMC-FZ200 100/200/400/800/1600/3200/ H6400 ^{*2} DMC-FZ60 100/200/400/800/1600/3200	The ISO sensitivity is fixed to various settings. • When the [ISO Increments] in [Rec] menu (P138) is set to [1/3 EV], items of ISO sensitivity that can be set will increase.

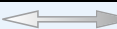
	[100]  [3200]/[6400] ^{*2}	
Recording location (recommended)	When it is light (outdoors)	When it is dark
Shutter speed	Slow	Fast
Noise	Less	Increased
Jitter of the subject	Increased	Less

*1 When the [ISO Limit Set] of [Rec] menu (P138) is set to anything except [AUTO], it is set automatically within the value set in [ISO Limit Set].

DMC-FZ200

*2 Only available when [Extended ISO] (P138) is set.

■ About [ISO] (Intelligent ISO sensitivity control)

The camera detects movement of the subject and then automatically sets the optimum ISO sensitivity and shutter speed to suit the movement of the subject and brightness of the scene to minimize the jitter of the subject.

- The shutter speed is not fixed when the shutter button is pressed halfway. It is continuously changing to match the movement of the subject until the shutter button is pressed fully.

Note

- For the focus range of flash when [AUTO] is set, refer to P78.
- The setting is fixed to [AUTO] in the following cases.
 - Creative Control Mode
- The setting is fixed to [ISO] in the following cases.
 - [Sports]/[Baby1]/[Baby2]/[Pet] (Scene Mode)
- You cannot select [ISO] in Shutter-Priority AE Mode.
- You cannot select [AUTO] or [ISO] in Manual Exposure Mode.
- Setting items below will be selectable in Creative Video Mode.
[AUTO]/[100]/[200]/[400]/[800]/[1600]/[3200]/[6400]
- The shutter speed is determined by the [Sensitivity] setting as shown in the table below.

DMC-FZ200

[Sensitivity] (When the [ISO Increments] (P138) is set to [1/3 EV])	Shutter speed (Sec.)
AUTO/[ISO]	The shutter speed changes automatically according to ISO sensitivity setting.
100/125/160/200/250/320/400/500/640/800/ 1000/1250/1600	60 to 1/4000
2000/2500/3200	15 to 1/4000
H4000*/H5000*/H6400*	8 to 1/4000

* Only available when [Extended ISO] is set.

DMC-FZ60

[Sensitivity] (When the [ISO Increments] (P138) is set to [1/3 EV])	Shutter speed (Sec.)
AUTO/[ISO]	The shutter speed changes automatically according to ISO sensitivity setting.
100/125/160/200/250/320/400	4 to 1/2000
500/640/800/1000/1250/1600	1 to 1/2000
2000/2500/3200	1/4 to 1/2000

Adjusting the White Balance

Applicable modes:

In sunlight, under incandescent lights or in other such conditions where the color of white takes on a reddish or bluish tinge, this item adjusts to the color of white which is closest to what is seen by the eye in accordance with the light source.

1 Press (WB).

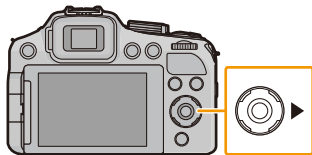

2 Press / to select the White Balance and then press [MENU/SET].

Settings	Description of settings
[AWB]	Automatic adjustment
	When taking pictures outdoors under a clear sky
	When taking pictures outdoors under a cloudy sky
	When taking pictures outdoors in the shade
	When taking pictures with the flash only
	When taking pictures under incandescent lights
	When using the preset White Balance
	When using the preset color temperature setting

Note

- Under fluorescent lighting, LED lighting fixture etc., the appropriate White Balance will vary depending on the lighting type, so use [AWB] or /.
- The White Balance might not be adjusted for the subject where the flash does not reach when the flash is used.
- The White Balance setting is memorized even if the camera is turned off. (However, the White Balance setting for a Scene Mode returns to [AWB] when the Scene Mode is changed.)
- White Balance is fixed to [AWB] in following conditions.
 - [Scenery]/[Panning]/[Night Portrait]/[Night Scenery]/[Handheld Night Shot]/[Food]/[Sunset] (Scene Mode)

■ Auto White Balance

Depending on the conditions prevailing when pictures are taken, the pictures may take on a reddish or bluish tinge. Furthermore, when a multiple number of light sources are being used or there is nothing with a color close to white, Auto White Balance may not function properly. In a case like this, set the White Balance to a mode other than [AWB].

- 1 Auto White Balance will work within this range.
 - 2 Blue sky
 - 3 Cloudy sky (Rain)
 - 4 Shade
 - 5 Sunlight
 - 6 White fluorescent light
 - 7 Incandescent light bulb
 - 8 Sunrise and sunset
 - 9 Candlelight
- K=Kelvin color Temperature

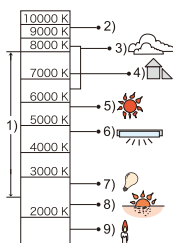

Setting the White Balance manually

Set the White Balance value. Use to match the condition when taking photographs.

- 1 Select [] or [] and then press ►.
- 2 Aim the camera at a sheet of white paper etc. so that the frame in the center is filled by the white object only and then press [MENU/SET].

- White Balance may not be set when the subject is too bright or too dark. Set the White Balance again after adjusting to appropriate brightness.

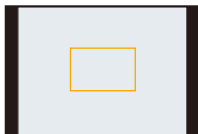

Setting the color temperature

You can set the color temperature manually for taking natural pictures in different lighting conditions. The color of light is measured as a number in degrees Kelvin. As the color temperature increases, the picture becomes more bluish. As the color temperature decreases, the picture becomes more reddish.

- 1 Select [] and then press ►.
- 2 Press ▲/▼ to select the color temperature and then press [MENU/SET].

- You can set a color temperature from [2500K] to [10000K].

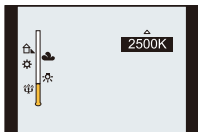

Finely adjusting the White Balance

You can finely adjust the White Balance when you cannot acquire the desired hue by setting the White Balance.

1 Select White Balance and then press ►.

- Press ► again if [1], [2] or [K] is selected.

2 Press ▲/▼/◀/▶ to adjust the White Balance and then press [MENU/SET].

- ◀ : A (AMBER: ORANGE)
- ▶ : B (BLUE: BLUISH)
- ▲ : G+ (GREEN: GREENISH)
- ▼ : M- (MAGENTA: REDDISH)

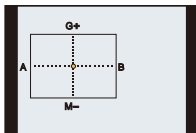

Note

- If you finely adjust the White Balance to A (amber), the White Balance icon on the screen will change to orange. If you finely adjust the White Balance to B (blue), the White Balance icon on the screen will change to blue.
- If you finely adjust the White Balance to G+ (green) or M- (magenta), [+] (green) or [-] (magenta) appears beside the White Balance icon on the screen.
- Select the center point if you are not finely adjusting the White Balance.
- The white balance fine adjustment setting is reflected in the picture when using the flash.
- You can finely adjust the White Balance independently for each White Balance item.
- The white balance fine adjustment setting is memorized even if the camera is turned off.
- The white balance fine adjustment level returns to the standard setting (center point) in the following cases.
 - When you reset the White Balance in [1] or [2]
 - When you reset the color temperature manually in [K]

White Balance Bracket

Bracket setting is performed based on the adjustment values for the white balance fine adjustment, and 3 pictures with different colors are automatically recorded when the shutter button is pressed once.

- 1 Press [DISP.] in step 2 of the “Finely adjusting the White Balance” procedure, and press ▲/▼/◀/▶ to set the bracket.

◀/▶: Horizontal (A to B)

▲/▼: Vertical (G+ to M-)

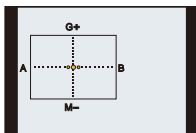

- 2 Press [MENU/SET].

Note

- [BKT] is displayed on the screen when it is set.
- The White Balance Bracket setting is released when this unit is turned off (including Sleep Mode).
- You will only hear the shutter sound once.
- White Balance Bracket does not work when recording motion pictures.

DMC-FZ200

- White Balance Bracket cannot be set when the [Quality] is set to [RAW⁺], [RAW₁], or [RAW].

Taking Pictures with Auto Focus

Applicable modes:         

This allows the focusing method that suits the positions and number of the subjects to be selected.

1 Set the camera to Auto Focus.

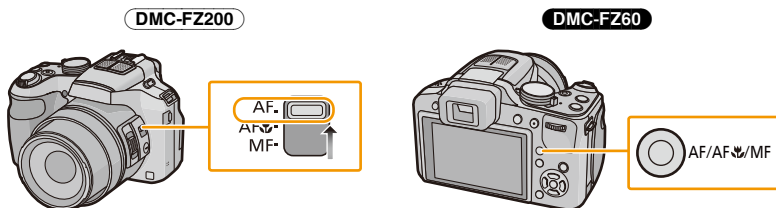

DMC-FZ200

Set the focus selector switch to [AF].

DMC-FZ60

- 1 Press [AF/AF-LOCK/MF] to display the focus setting screen.
- 2 Press ▲/▼ to select [AF] and then press [MENU/SET].





2 Select [AF Mode] on the [Rec] menu and then press ►.

DMC-FZ200

- Auto Focus Mode setting screen can also be displayed by pressing ◀[RECALL].









3 Press ▲/▼ to select the Auto Focus Mode and then press [MENU/SET].

Settings	Description of settings
 ([Face Detection])	The camera automatically detects the person's face. The focus and exposure can then be adjusted to fit that face no matter what portion of the picture it is in. (max. 15 areas)
 ([AF Tracking])*	Focus and exposure can be adjusted to a specified subject. Focus will keep on following the subject even if it moves. (Dynamic tracking)
 ([23-Area])*	Up to 23 points for each AF area can be focused. This is effective when the subject is not in the center of the screen. (AF area frame will be same as image aspect ratio setting.)
 ([1-Area])	The camera focuses on the subject in the AF area on the center of the screen.

*  will be used during motion picture recording.

Note

- It will be fixed to  when the [Face Recog.] is set to [ON].
- It is not possible to set  in the following cases.
 - [Panorama Shot]/[Panning]/[Night Scenery]/[Handheld Night Shot]/[Food] (Scene Mode)
 - [Soft Focus] (Creative Control Mode)
- It is not possible to set  in the following cases.
 - [Panorama Shot] (Scene Mode)
 - [Sepia]/[Dynamic Monochrome]/[High Dynamic]/[Toy Effect]/[Soft Focus] (Creative Control Mode)
 - When [Photo Style] is set to [Monochrome]
- Only  or  can be set during Creative Video Mode.
- [AF Mode] is fixed to  in the following cases.
 - [Miniature Effect] (Creative Control Mode)

DMC-FZ200

- [High Speed Video] (Creative Video Mode)

■ About [👤] ([Face Detection])

The following AF area frames are displayed when the camera detects the faces.

Yellow:

When the shutter button is pressed halfway, the frame turns green when the camera is focused.

White:

Displayed when more than one face is detected. Other faces that are the same distance away as faces within the yellow AF areas are also focused.



Note

- When [Metering Mode] is set to multiple [☐], the camera will adjust the exposure to suit the person's face.
- Under certain picture-taking conditions including the following cases, the face detection function may fail to work, making it impossible to detect faces. [AF Mode] is switched to [☐] ([☐] while motion pictures are taken).
 - When the face is not facing the camera
 - When the face is at an angle
 - When the face is extremely bright or dark
 - When there is little contrast on the faces
 - When the facial features are hidden behind sunglasses, etc.
 - When the face appears small on the screen
 - When there is rapid movement
 - When the subject is other than a human being
 - When the camera is shaking
 - When Digital Zoom is used
- If the camera is registering something other than someone's face, change the settings to something other than [👤].

■ Setting up [AF-ON] ([AF Tracking])

Bring the subject to the AF tracking frame, and press [AF/AE LOCK] to lock the subject.

Ⓐ AF tracking frame

- AF area will be displayed in yellow when a subject is recognized, and exposure and focus will automatically adjust continuously following the subject's movement (Dynamic tracking).
- AF tracking is canceled when [AF/AE LOCK] is pressed again.

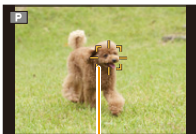

📘 Note

- When the AF lock fails, the Tracking AF frame will turn red and then disappear. Redo the AF lock.
- In the following cases, [AF-ON] operates as [AF-ON]:
 - When the subject is not specified
 - When the subject is lost
 - When the AF tracking fails
- Dynamic tracking function may not work in the following cases:
 - When the subject is too small
 - When the recording location is too dark or bright
 - When the subject is moving too fast
 - When the background has the same or similar color to the subject
 - When jitter is occurring
 - When using the zoom

■ Changing position and size of the AF area (Only when [] is selected)

If you performing any of the following operations, the screen will switch to the settings menu.

- When [] is selected, press [FOCUS].
- From the menu screen, select [], and press ►.

1 Press ▲/▼/◀/▶ to move the AF area.

- You can set to arbitrary position of the screen. (It cannot be set to edge of the screen)
- After moving the AF area, press [DISP.] to return it to the center.

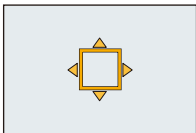

2 Rotate the rear dial to change the size of AF area.

Rear dial right: Enlarge

Rear dial left: Shrink

- It can be changed to 4 different sizes.

3 Press [MENU/SET] to set.

Note

- AF area cannot be moved during motion picture recording.
- The spot metering target can also be moved to match the AF area when using [].
- Position of the AF area will return to initial state when the camera is set to Intelligent Auto Mode, when the Sleep Mode is activated, or when this unit is turned off.
- The AF area may not be displayed as intended at certain zoom magnifications or under low light.

Taking Close-up Pictures

Applicable modes:

This mode allows you to take close-up pictures of a subject, e.g. when taking pictures of flowers. You can take pictures of a subject as close as 1 cm (0.033 feet) from the lens by rotating the zoom lever upmost to Wide (1×).

DMC-FZ200

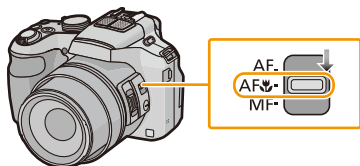

DMC-FZ60

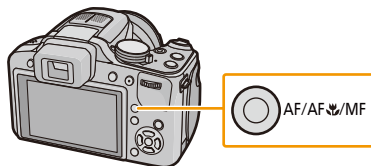

DMC-FZ200

Set the focus selector switch to [AF with a flower icon].

- In AF Macro Mode, [AF with a flower icon] is displayed.

DMC-FZ60

- 1 Press [AF/AF with a flower icon/MF] to display the focus setting screen.
- 2 Press ▲/▼ to select [AF Macro] and then press [MENU/SET].
 - In AF Macro Mode, [AF with a flower icon] is displayed.
 - Select [AF] to cancel.

Macro Zoom Mode DMC-FZ60

Use this setting to get close to the subject and then further enlarge when taking the picture. You can take a picture with the Digital Zoom up to 3× while maintaining the distance to the subject for the extreme Wide position [1 cm (0.033 feet)].

- 1 Press [AF/AF with a flower icon/MF] to display the focus setting screen.
- 2 Press ▲/▼ to select [Macro Zoom] and then press [MENU/SET].
 - The image quality is poorer than during normal recording.
 - Zoom range will be displayed in blue. (Digital zoom range)
 - [AF with a flower icon] is displayed when using Macro Zoom.

Note

- We recommend using a tripod and the Self-timer.
- We recommend setting the flash to [⊕] (close the flash) when you take pictures at close range.
- If the distance between the camera and the subject is beyond the focus range of the camera, the picture may not be properly focused even if the focus indication lights.
- When a subject is close to the camera, the effective focus range is significantly narrowed. Therefore, if the distance between the camera and the subject is changed after focusing on the subject, it may become difficult to focus on it again.
- Macro Mode gives priority to a subject close to the camera. Therefore, if the distance between the camera and the subject is far, it takes longer to focus on it.
- When you take pictures at close range, the resolution of the periphery of the picture may decrease slightly. This is not a malfunction.
- If the lens becomes dirty with fingerprints or dust, the lens may not be able to focus on the subject correctly.
- It is not possible to set AF Macro Mode in the following cases.
 - In all Scene Modes except [3D Photo Mode]

DMC-FZ60

- It is not possible to set [Macro Zoom] in the following cases.
 - Scene Mode
 - [Miniature Effect] (Creative Control Mode)
 - When [F₁₃] in [AF Mode] is set
 - When [Conversion] is set

Taking Pictures with Manual Focus

Applicable modes:

Use this function when you want to fix the focus or when the distance between the lens and the subject is determined and you do not want to activate Auto Focus.

1 Set the Manual Focus.

- When shooting in Manual Focus, [MF] is displayed on the screen.

DMC-FZ200

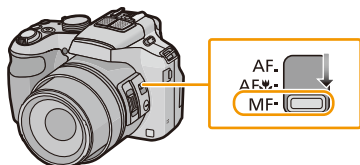

DMC-FZ60

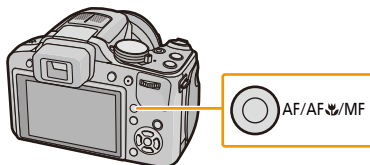

DMC-FZ200

Set the focus selector switch to [MF].

DMC-FZ60

- Press [AF/AF-LOCK/MF] to display the focus setting screen.
- Press / to select [MF] and then press [MENU/SET].
 - Select [AF] to cancel.

2 Press the rear dial to set [MF] to a selected state.

- Enabled operation will switch every time the rear dial is pressed.

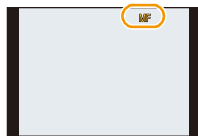

3 Rotate the rear dial to display focus range on the screen.

4 Press / or rotate the rear dial to focus on the subject.

- Using the cursor button is recommended when making slight adjustments.
- When you stop operating the focus adjustment, the focus range will disappear after a few seconds.

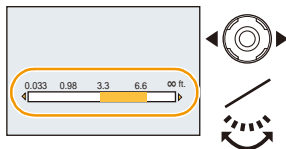

DMC-FZ200**■ Focus setting with the side lever**

- Set the focus selector switch to [MF].

- 1 Set the [Side Lever] on the [Setup] menu to [FOCUS].**
(P57)
- 2 Slide the side lever to display focus range on the screen.**
- 3 Slide the side lever to focus on the subject.**

Side lever (T): Distant

Side lever (W): Near

- Using the cursor button is recommended when making slight adjustments.

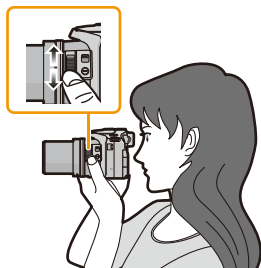
**■ MF Assist**

If [MF Assist] (P62) in the [Setup] menu is set to [ON], when focus is achieved, the MF area (locations that are in focus) is enlarged.

- If you press [MENU/SET] while MF Assist is displayed, the MF area can be moved using ▲/▼/◀/▶. Pressing [MENU/SET] again returns the camera to MF Assist.
- Performing the following operation returns the MF area to the center.
 - Changing the picture size or aspect.
 - Turning the camera off (including Sleep Mode).

DMC-FZ200

- The magnification of the enlarged area can be changed by pressing the rear dial when MF Assist is activated or the MF area is moving.

Technique for Manual Focus

- ❶ Focus by rotating the rear dial.
- ❷ Press the cursor button a few times furthermore in the same direction.
- ❸ Finely focus on the subject by pressing the cursor button in reverse.



■ Prefocus

This is a technique for focusing in advance on the point the pictures will be taken when it is difficult to focus on the subject with Auto Focus due to its quick motion. (e.g. [Panning] in Scene Mode)

This function is suitable when the distance between the camera and the subject is certain.

■ One shot AF

You can focus on the subject with Auto Focus by pressing [FOCUS] button during Manual Focus. This is convenient for prefocus.

📌 Note

- If you use the zoom function after focusing on the subject, focus on the subject again.
- The MF Assist is disabled in the Digital Zoom range or when recording motion pictures.
- The distance to the subject displayed on the screen in Manual Focus is an approximation of the focus position. Use the MF Assist screen for a final check of the focus.
- After canceling Sleep Mode, focus on the subject again.
- Using MF Assist in combination with AE Lock makes it easy to check the focus.

Fixing the Focus and the Exposure (AF/AE Lock)

Applicable modes:         

This is useful when you want to take a picture of a subject outside the AF area or the contrast is too strong and you cannot achieve appropriate exposure.

DMC-FZ200

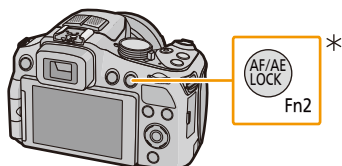

DMC-FZ60

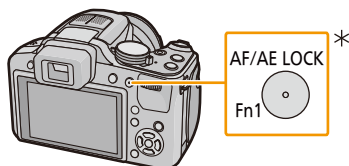

DMC-FZ200

- * To use as the [AF/AE LOCK] button, set [AF/AE LOCK /Fn2] in the [Setup] menu to [AF/AE LOCK]. (P57)

DMC-FZ60

- * To use as the [AF/AE LOCK] button, set [AF/AE LOCK /Fn1] in the [Setup] menu to [AF/AE LOCK]. (P57)

- 1 Aim the AF area at the subject.**
- 2 Press [AF/AE LOCK] to fix the focus and exposure.**
 - This does not work when AF tracking is active.
 - The setting is canceled by pressing the [AF/AE LOCK] again.
- 3 Move the camera to compose the picture and then press the shutter button fully.**
 - When [AE] is set, after pressing the shutter button halfway to focus, press the shutter button fully.

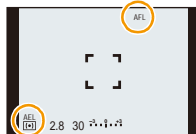

■ AF/AE Lock

Locking of the focus and exposure can be set in [AF/AE Lock] in the [Rec] menu.

Item	Description of settings
[AF]	Only the focus is locked. • [AFL] and focus indication are displayed when the subject comes into focus.
[AE]	Only the exposure is locked. • [AEL], aperture value, and shutter speed are displayed when the exposure is adjusted.
[AF/AE]	Both focus and exposure are locked. • [AFL], [AEL], the focus indication, aperture value and shutter speed are displayed when the focus and the exposure are optimized.

Note

- When AE lock is performed, the brightness of the recording screen that appears on the LCD monitor/Viewfinder is fixed.
- AF Lock only is effective when taking pictures in Manual Exposure Mode or Scene Mode.
- AE Lock only is effective when taking pictures with Manual Focus.
- AE Lock and AF Lock must be activated before motion picture recording begins.
- When recording motion pictures after locking, you can continue to record in a locked state in Creative Video Mode. Lock will be canceled in other modes than Creative Video Mode.
- Lock is canceled when zooming is performed after locking. Perform the locking again.
- The exposure is set, even if the brightness of the subject changes.
- The subject can be focused again by pressing the shutter button halfway even when AE is locked.
- Program Shift can be set even when AE is locked.

Using the function button

You can assign the recording function, etc. to the function buttons. Press the buttons to instantly access assigned functions.

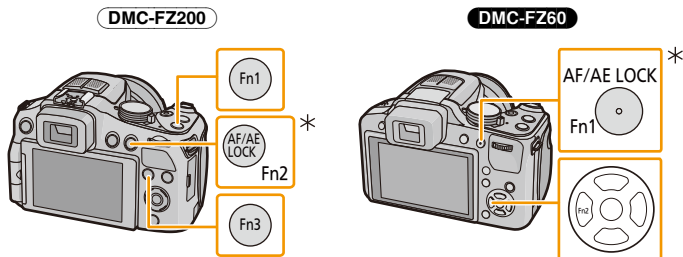

DMC-FZ200

* To use as the function button, set [AF/AE LOCK /Fn2] in the [Setup] menu to [Fn2]. (P57)

DMC-FZ60

* To use as the function button, set [AF/AE LOCK /Fn1] in the [Setup] menu to [Fn1]. (P57)

- 1 Select [Fn Button Set] on the [Setup] menu. (P52)
- 2 Press ▲/▼ to select the button to assign and then press [MENU/SET].
- 3 Press ▲/▼ to select the function to assign and then press [MENU/SET].

Assignable functions			
	[Photo Style] (P133)		[Guide Line] (P59)
	[Aspect Ratio] (P134)		[Video Rec Area] (P60)
	[Quality] (P137)		[Remaining Disp.] (P61)
	[Metering Mode] (P140)		[Flash] (P75)
DMC-FZ60			[Flash Adjust.] (P145)
	[AF Mode] (P92)		[Auto Bracket] (P146)
Focus	[AF Style] (P139)	DMC-FZ200	
	[i.Dynamic] (P141)		[Side Lever] (P57)

- Exit the menu after it is set.

Taking Pictures by Specifying the Aperture/ Shutter Speed

Aperture-Priority AE Mode

Set the aperture value to a higher number when you want a sharp focus background. Set the aperture value to a lower number when you want a soft focus background.

1 Set the mode dial to [A].

2 Rotate the rear dial to set the aperture value.

- (A) Aperture Value
- (B) Exposure meter

- It will switch between aperture setting operation and Exposure Compensation operation every time the rear dial is pressed.

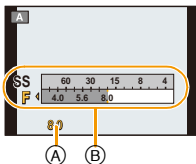

Available Aperture Value* ^{1,2} (Per 1/3 EV)	Shutter Speed* ² (Sec)
F2.8 to F8.0	DMC-FZ200 8 to 1/4000 DMC-FZ60 4* ³ to 1/2000

*1 Some aperture values are not selectable when using conversion lens.

*2 Depending on the zoom position, some of the values cannot be selected.

*3 The shutter speed varies depending on the [Sensitivity] setting. (P87)

Shutter-Priority AE Mode

Set with a faster shutter speed when you want to take a sharp picture of a fast moving subject. Set to a slower shutter speed when you want to create a trail effect.

1 Set the mode dial to [S].

2 Rotate the rear dial to set the shutter speed.

- (C) Shutter Speed
- (D) Exposure meter

- It will switch between shutter speed setting operation and Exposure Compensation operation every time the rear dial is pressed.

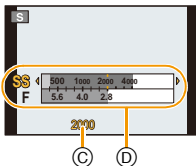

Available Shutter Speed (Sec) (Per 1/3 EV)	Aperture Value* ¹
DMC-FZ200 8 to 1/4000 DMC-FZ60 4* ² to 1/2000	F2.8 to F8.0

*1 Depending on the zoom position, some of the values cannot be selected.

*2 The shutter speed varies depending on the [Sensitivity] setting. (P87)

Manual Exposure Mode

Determine the exposure by manually setting the aperture value and the shutter speed.

- 1 Set the mode dial to [M].
- 2 Rotate the rear dial to set the aperture and shutter speed.

(E) Manual Exposure Assistance

(F) Exposure meter

- It will switch between aperture setting operation and shutter speed setting operation every time the rear dial is pressed.

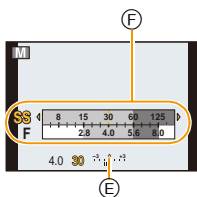

Available Aperture Value ^{*1,2} (Per 1/3 EV)	Available Shutter Speed ^{*2} (Sec) (Per 1/3 EV)
F2.8 to F8.0	DMC-FZ200 60 ^{*3} to 1/4000 DMC-FZ60 4 ^{*3} to 1/2000

*1 Some aperture values are not selectable when using conversion lens.

*2 Depending on the zoom position, some of the values cannot be selected.

*3 The shutter speed varies depending on the [Sensitivity] setting. (P87)

Manual Exposure Assistance

	The exposure is adequate.
	Set to faster shutter speed or larger aperture value.
	Set to slower shutter speed or smaller aperture value.

• The Manual Exposure Assistance is an approximation. We recommend checking the pictures on the playback screen.

Note

• The brightness of the LCD monitor/Viewfinder and the recorded pictures may differ. Check the pictures on the playback screen.

• Set the aperture value to a higher number when the subject is too bright. Set the aperture value to a lower number when the subject is too dim.

• The aperture value and the shutter speed displayed on the screen turn red when the exposure is not adequate.

• Display of the shutter speed will count down when the shutter speed is set to slow and the shutter button is pressed all the way.

• We recommend using a tripod when the shutter speed is slow.

• The [Sensitivity] is automatically set to [AUTO] when you switch the Recording Mode to Shutter-Priority AE Mode while the [Sensitivity] is set to [ISO].

• The [Sensitivity] is automatically set to [100] when you switch the Recording Mode to Manual Exposure Mode while the [Sensitivity] is set to [AUTO] or [ISO].

Taking Pictures that Match the Scene Being Recorded (Scene Mode)

Recording modes:  **SCN**

When you select a Scene Mode to match the subject and recording situation, the camera sets the optimal exposure and hue to obtain the desired picture.

- 1 Set the mode dial to [SCN].
- 2 Press **▲/▼/◀/▶** to select the Scene Mode and then press [MENU/SET].

- If you press [DISP.] when selecting a Scene Mode, explanations about each Scene Mode are displayed.



Note

- To change the Scene Mode, press [MENU/SET] and then press **▶**, and return to step 2 above.

[Portrait]

When taking pictures of people outdoors during the day, this mode allows you to improve the appearance of the persons concerned and make their skin tones look healthier.

■ Technique for Portrait Mode

To make this mode more effective:

- 1 Rotate the zoom lever as far as possible to Tele.
- 2 Move close to the subject to make this mode more effective.

[Soft Skin]

When taking pictures of people outdoors during the daytime, this mode enables the texture of their skin to appear even softer than with [Portrait]. (It is effective when taking pictures of people from the chest up.)

■ Technique for Soft Skin Mode

To make this mode more effective:

- ① Rotate the zoom lever as far as possible to Tele.
- ② Move close to the subject to make this mode more effective.



Note

- If a part of the background etc. is a color close to skin color, this part is also smoothed.
- This mode may not be effective when there is insufficient brightness.

[Scenery]

This allows you to take pictures of a wide landscape.

[Panorama Shot]

Pictures are recorded continuously while moving the camera horizontally or vertically, and are combined to make a single panorama picture.

- 1 Press **▲/▼** to select the recording direction and then press **[MENU/SET]**.
- 2 After confirming the recording direction, press **[MENU/SET]**.
 - The horizontal/vertical guideline will be displayed.
- 3 Press the shutter button halfway to focus.
- 4 Press the shutter button fully and record a picture while moving the camera in a small circle in the direction selected in Step 1.

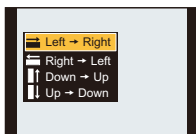

Recording from left to right

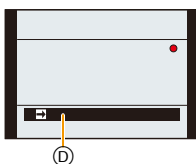
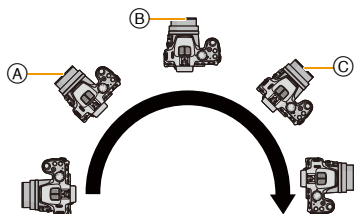

Move the camera in a single panning motion for about 8 seconds.

- Move the camera at a constant speed.

Pictures may not be able to be recorded properly if the camera is moved too fast or too slow.

- (A) 1 second
- (B) 2 seconds
- (C) 3 seconds
- (D) Recording direction and panning (Guide)

■ Technique for Panorama Shot Mode

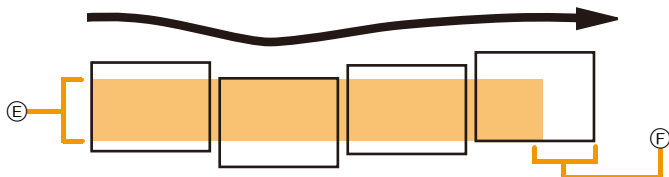

- (E) Move the camera in the recording direction without shaking it. If the camera shakes too much, pictures may not be able to be recorded, or the recorded panorama picture may become narrower (smaller)
- (F) Move the camera towards the edge of the range you wish to record. (The edge of the range will not be recorded in the last frame)

- 5 Press the shutter button once again to end the still picture recording.
 - Recording can also be canceled by keeping the camera still while recording.

Note

- The zoom position is fixed to Wide.
- The focus, white balance, and exposure are fixed at the optimum values for the first picture. As a result, if the focus or brightness changes substantially during recording, the entire panorama picture may not be recorded at the suitable focus or brightness.
- When multiple pictures are combined to create a single panorama picture, the subject may appear distorted or the connection points may be noticeable in some cases.
- The number of recording pixels in the horizontal and vertical directions of the panorama picture varies depending on the recording direction and the number of combined pictures. The maximum number of pixels is shown below.

Recording direction	Horizontal Resolution	Vertical Resolution
Horizontal	8000 pixels	1080 pixels
Vertical	1440 pixels	8000 pixels

- A panorama picture may not be able to be created, or the pictures may not be combined properly when recording the following subjects or under the recording conditions below.
 - Subjects with a single, uniform color or repetitive pattern (such as the sky or a beach)
 - Moving subjects (person, pet, car, waves, flowers blowing in the breeze, etc.)
 - Subjects where the color or patterns change in a short time (such as an image appearing on a display)
 - Dark places
 - Locations with flickering light sources such as fluorescent lights or candles

About playback

Playback zoom can be performed even for pictures that were recorded using [Panorama Shot]. Also, if ▲ is pressed during playback, the screen will automatically scroll in the same direction during recording.

▲	Start/Pause*	
▼	Stop	

* You can perform frame-by-frame forward/rewind by pressing ►/◀ during a pause.

[Sports]

Setting for when you want to take pictures of sports scenes or other fast-moving events.

Note

- Shutter speed may slow down for up to 1 second.
- This mode is suitable for taking pictures of subjects at distances of 5 m (16 feet) or more.

[Panning]

When you move the camera to follow a subject moving in one direction such as a runner or car, the background becomes a blur and the subject stays focused. This effect is called “panning”. This mode allows you to obtain this effect easier.

■ Setting the shutter speed

Select from [Auto] or [Shutter-Priority].

- If you select [Auto], it will not be possible to select the shutter speed.
- If you select [Shutter-Priority], it will switch between shutter speed setting operation and Exposure Compensation operation every time the rear dial is pressed.

■ Technique for Panning Mode

To obtain good pictures in Panning Mode, move the camera in a horizontal plane as you take the pictures.

- We recommend that you do not follow the subject with the camera alone, but stand facing the subject with shoulders squared, and follow it using your entire body, while twisting at the waist.
 - Once the subject is in front of you, press the shutter button. Do not stop moving the camera even after you press the shutter button.
- 1 Move the camera smoothly while following the subject in the viewfinder.
 - 2 Press the shutter button while you are moving the camera.
 - 3 Move the camera continuously.
- We recommend the following:
 - Using the Viewfinder.
 - Selecting a subject with quick motion.
 - Using prefocus.
 - Use this mode with Burst Mode.
(You can then select the best pictures from all the pictures taken.)

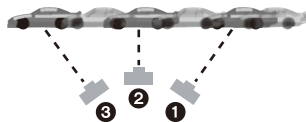

Note

- The shutter speed in Panning Mode becomes slower to achieve the panning effect. As a result, jitter can easily occur.

[Night Portrait]

This allows you to take pictures of a person and the background with near real-life brightness.

■ Technique for Night Portrait Mode

- Use the flash. (You can set to [].)
- Ask the subject not to move while taking a picture.

Note

- We recommend using a tripod and the Self-timer for taking pictures.

DMC-FZ200

- Shutter speed may slow down for up to 8 seconds.
- The shutter may remain closed (max. about 8 sec.) after taking the picture because of signal processing. This is not a malfunction.

DMC-FZ60

- Shutter speed may slow down for up to 4 seconds.
- The shutter may remain closed (max. about 4 sec.) after taking the picture because of signal processing. This is not a malfunction.

- Noise may become visible when you take pictures in dark places.

[Night Scenery]

This allows you to take vivid pictures of the nightscape.

Note

- We recommend using a tripod and the Self-timer for taking pictures.

DMC-FZ200

- Shutter speed may slow down for up to 8 seconds.
- The shutter may remain closed (max. about 8 sec.) after taking the picture because of signal processing. This is not a malfunction.

DMC-FZ60

- Shutter speed may slow down for up to 4 seconds.
- The shutter may remain closed (max. about 4 sec.) after taking the picture because of signal processing. This is not a malfunction.

- Noise may become visible when you take pictures in dark places.

[Handheld Night Shot]

This mode allows you to record multiple pictures of night scenes at high speed, which are all combined to make a single picture. It will reduce the jitter and noise from the picture even when recording with the camera in your hand.

Note

- Do not move the camera while recording pictures continuously.
- Noise may become visible when you take pictures in dark places or take pictures of moving subjects.

[HDR]

You can combine several pictures with different levels of exposure into a single picture with rich gradation. You can minimize the loss of gradations in bright areas and dark areas when, for example, the contrast between the background and the subject is large.

■ What Is HDR?

HDR stands for High Dynamic Range and refers to a technique for expressing a wide contrast range.

Note

- Do not move the camera during the continuous shooting after pressing the shutter button.
- You cannot take the next picture until the combination of pictures is complete.
- A moving subject may be recorded with unnatural blurs.
- The continuous shooting may not work under certain recording conditions. In that case, a single picture is recorded.

[Food]

This mode allows you to take pictures of food with a natural hue without being affected by the ambient light in restaurants etc.

[Baby1]/[Baby2]

This takes pictures of a baby with a healthy complexion. When you use the flash, the light from it is weaker than usual.

It is possible to set different birthdays and names for [Baby1] and [Baby2]. You can select to have these appear at the time of playback, or have them stamped on the recorded image using [Text Stamp] (P164).

■ Birthday/Name setting

- 1 Press ▲/▼ to select [Age] or [Name] and then press ►.
- 2 Press ▲/▼ to select [SET] and then press [MENU/SET].
- 3 Enter the birthday or name.

Birthday: ◀/▶: Select the items (year/month/day)

▲/▼: Setting

[MENU/SET]: Set

Name: For details on how to enter characters, refer to “Entering Text” on P132.

- When the birthday or name is set, [Age] or [Name] is automatically set to [ON].
- If [ON] is selected when the birthday or name has not been registered, the setting screen appears automatically.

- 4 Press [MENU/SET] to finish.

■ Canceling [Age] and [Name]

Select the [OFF] setting in step 2.

● Note

• Still pictures recorded during motion picture recording will not record age or name.

- The age and name can be printed out using the “PHOTOfunSTUDIO” bundled software on the CD-ROM (supplied).
- If [Age] or [Name] is set to [OFF] even when the birthday or name has been set, the age or name will not be displayed.
- Shutter speed may slow down up to 1 second.

[Pet]

Select this mode when you want to take pictures of a pet such as a dog or a cat. You can set your pet's birthday and name.

For information about [Age] or [Name], refer to [Baby1]/[Baby2] on [P114](#).

[Sunset]

Select this when you want to take pictures of sunset view. This allows you to take vivid pictures of the red color of the sun.

[High Sens.]

This mode minimizes the jitter of the subjects, and enables you to take pictures of these subjects in dimly lit rooms.

■ Picture size and aspect ratio

Select the picture size of 3M (4:3), 2.5M (3:2), 2M (16:9) or 2.5M (1:1).

[Glass Through]

This mode is ideal for taking pictures of scenery and other landscapes through clear glass, such as in vehicles or buildings.



Note

- The camera may focus on the glass if it is dirty or has dust on it.
- The pictures taken may not look natural if the glass is colored. When this happens, change the white balance settings. ([P88](#))

[3D Photo Mode]

Pictures are recorded continuously while moving the camera horizontally, and two pictures selected automatically are combined to make a single 3D picture.

To view 3D pictures, a television that supports 3D is required. (This unit will play back in 2D) Refer to [P180](#) for details about the playback method.

■ Technique for 3D Photo Mode

Start the recording and then slide the camera horizontally straight from left to right.

- A guide is displayed while recording.
- Move the camera approximately 10 cm (0.33 feet) within approximately 4 seconds using the guide.

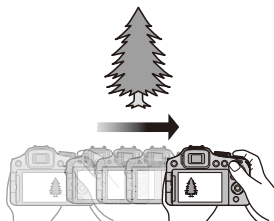

■ To avoid mistakes in 3D recording

- Take a picture of a subject that is not moving.
- Take a picture in a well-lit place, such as outdoors, etc.
- Fix the focus and exposure by pressing the shutter button halfway, then press the shutter button fully and move the camera.
- When you start recording with the subject slightly to the right of the center, the subject will be close to the center in the final picture.

● Note

- **You cannot record 3D pictures in vertical orientation.**
- The 3D pictures are saved in MPO format (3D).
- Zoom position is fixed to Wide.
- The picture size is fixed to 2M (16:9).
- The ISO sensitivity is automatically adjusted. However, the ISO sensitivity is increased to make the shutter speed become high-speed.
- Motion pictures cannot be recorded during 3D Photo Mode.
- Recording may not be possible depending on the recording conditions for the following cases. You may not get a 3D effect or the picture may be warped even if it was possible to record.
 - When the subject is too dark/bright
 - When the brightness of the subject changes
 - When the subject is moving
 - Not enough contrast

Taking Pictures with different image effects

(Creative Control Mode)

Recording modes:  P A S M        

This mode records with additional image effects. You can set the effects to add by selecting example images and checking them on the screen.

1 Set the mode dial to [C].

2 Press ▲/▼ to select image effects (filters) and then press [MENU/SET].

- The image effect of the selected example image will be applied in a preview display (A).
- A brief description of selected image effect appears when you press [DISP].

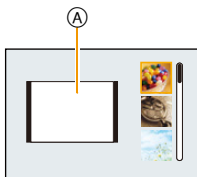

■ Adjust the effect to fit your preferences.

The strength and colors of the effects can be easily adjusted to fit your preferences.

1 Press the rear dial to display the options.

2 Press ▲/▼ to select the item

- You can adjust the image effect.
The items that can be set differ depending on which Creative Control Mode is currently set.
For information on each image effect, refer to “Items that can be set”.

: Adjust the brightness.

: Adjust the background blur.

: Adjust the image effect.



3 Press ◀/▶ or rotate the rear dial to adjust.

- Press [⏪/⏩] to reset the setting to the default state (AUTO).
- To adjust automatically, reset the setting to the default state (AUTO).

4 Press [MENU/SET] or the rear dial to set.

Note

- The displayed image on the recording screen and the preview of the selected image effect may differ from the actual recorded image.
- Creative Control settings are memorized even if the camera is turned off.
- White Balance will be fixed to [AWB], and [Sensitivity] will be fixed to [AUTO].
- In [Miniature Effect] of Creative Control Mode, Defocus Control cannot be used.

* These pictures are examples to show the effect.

[Expressive]

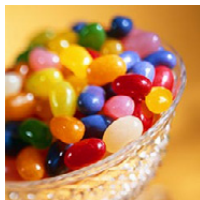

This effect emphasizes the color to make a pop art picture.

Items that can be set

Freshness	Understated colors	↔	Pop colors
-----------	--------------------	---	------------

[Retro]



This effect gives a faded image.

Items that can be set

Color	Yellow emphasized	↔	Red emphasized
-------	-------------------	---	----------------

[High Key]



This effect adds a bright, airy and soft feel to the overall image.

Items that can be set

Color	Pink emphasized	↔	Aquamarine emphasized
-------	-----------------	---	-----------------------

[Low Key]

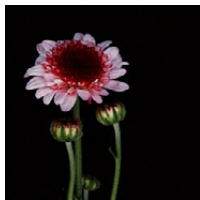

This effect adds a dark and relaxing feel to the overall image and enhances bright parts.

Items that can be set

Color	Red emphasized	↔	Blue emphasized
-------	----------------	---	-----------------

[Sepia]

This effect creates a sepia image.

Items that can be set

Contrast	Low contrast	↔	High contrast
----------	--------------	---	---------------

[Dynamic Monochrome]

This effect gives a higher contrast to create an impressive black and white picture.

Items that can be set

Contrast	Low contrast	↔	High contrast
----------	--------------	---	---------------

[Impressive Art]

This effect gives your photo a dramatic contrast look.

Items that can be set

Freshness	Black and white	↔	Pop colors
-----------	-----------------	---	------------

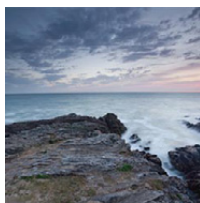
[High Dynamic]

This effect produces the optimum brightness for both dark and bright areas of the image.

Items that can be set

Freshness	Black and white	↔	Pop colors
-----------	-----------------	---	------------

[Cross Process]

This effect gives your photo a dramatic color look.

Items that can be set

Color	Green tone/Blue tone/Yellow tone/ Red tone
-------	---

- Select the color to enhance, and press [MENU/SET].

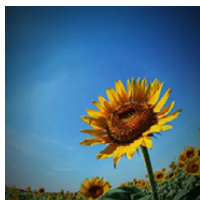
**[Toy Effect]**

This effect reduces peripheral brightness to give the impression of a toy camera.

Items that can be set

Color	Orange emphasized ↔ Blue emphasized
-------	-------------------------------------

[Miniature Effect]

This effect blurs peripheral areas to give the impression of a diorama.

Items that can be set

Freshness	Understated colors ↔ Pop colors
-----------	---------------------------------

■ Setting the type of defocus

With [Miniature Effect] you can make the subject stand out by intentionally creating defocused and in-focus portions. You can set the recording orientation (defocus orientation) and the position and size of the in-focus portion.

1 Press function button to display the setting screen.

DMC-FZ200 : [Fn3]

DMC-FZ60 : [Fn2]

- A frame around the area not to be blurred will display.

2 Adjust the position and size of the frame and then press [MENU/SET] to set.

	(A) When the frame is horizontal	(B) When the frame is vertical
▲/▼	Move (up and down)	Switch to (A)
◀/▶	Switch to (B)	Move (left and right)
	Enlarge and shrink • You can switch between three levels.	
• If you press [DISP.], the adjusted frame will return to the original values.		

(C) Non-blurrable range

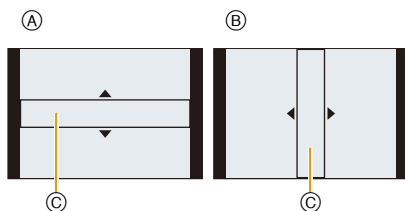

Note

- Display of the recording screen will be delayed more than usual and the screen will look as if frames are being dropped.
- No sound is recorded in motion pictures.
- Approximately 1/10 of the time period is recorded. (If you record for 10 minutes, the resulting motion picture recording will be approximately 1 minute long.)
The displayed available recording time is approximately 10 times. When switching to Recording Mode, please check the available recording time.
- When taking pictures of a large size, the screen may turn black after taking the picture because of signal processing. This is not a malfunction.

[Soft Focus]

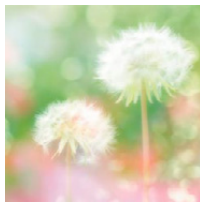

This effect blurs the overall image to produce a soft feel.

Items that can be set

Extent of defocus	Weak defocus	↔	Strong defocus
-------------------	--------------	---	----------------

 **Note**

- Display of the recording screen will be delayed more than usual and the screen will look as if frames are dropping.

[Star Filter]



This effect transforms pin-points of light into a star effect.

Items that can be set

Length of shine	Short	↔	Long
-----------------	-------	---	------

 **Note**

- Display of the recording screen will be delayed more than usual and the screen will look as if frames are dropping.

[One Point Color]

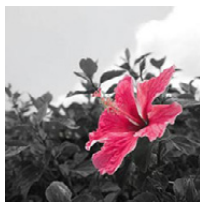

This effect leaves one selected color to emphasize impressiveness.

Items that can be set

Amount of color left	Small amount of color	↔	Large amount of color
----------------------	-----------------------	---	-----------------------

 **Set the color to leave in**

Set the color to leave in by selecting a location on the screen.

1 Press function button to display the setting screen.

DMC-FZ200 : [Fn3]

DMC-FZ60 : [Fn2]

2 Put the center frame onto the color you want to leave, and press [MENU/SET].
 **Note**

- Depending on the subject, the set color may not be left in.



Recording Motion Picture with Manual Settings

(Creative Video Mode)

Recording modes: 

It is possible to manually change the aperture and shutter speed and record motion pictures. Switching the [Creative Video] setting allows you to use settings such as those when mode dial is switched to [P], [A], [S] and [M].

- 1** Set the mode dial to [M].
- 2** Press ▲/▼ to select the item and then press [MENU/SET].

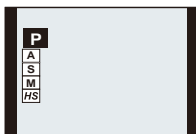

3 Rotate the rear dial to change the settings.

Item	Items that can be set will switch every time the rear dial is pressed	
P	—	Exposure Compensation
A	DMC-FZ200 Aperture (F2.8 to F11) DMC-FZ60 Aperture (F2.8 to F11) (Wide)/ (F5.2 to F11) (Tele)	Exposure Compensation
S	Shutter speed (Sec.) (1/30 to 1/20000th)*1	Exposure Compensation
M	Shutter speed (Sec.) (1/30 to 1/20000th)*1 (When using Manual Focus, the shutter speed can be set from 1/8 to 1/20000th.*2)	DMC-FZ200 Aperture (F2.8 to F11) DMC-FZ60 Aperture (F2.8 to F11) (Wide)/ (F5.2 to F11) (Tele)
DMC-FZ200 HS [High Speed Video] (P125)	—	Exposure Compensation

DMC-FZ200

- *1 If you record with the shutter speed set to slower than 1/60th of a second and [Rec Mode] set to [AVCHD], the exposure time per frame will increase. Depending on the movement of the subject, this may result in blurring in the frames.

DMC-FZ60

- *1 If you record with the shutter speed set to slower than 1/30th of a second and [Rec Mode] set to [AVCHD], the exposure time per frame will increase. Depending on the movement of the subject, this may result in blurring in the frames.

- *2 During recording, if you set a type of focus to other than Manual Focus with the shutter speed set to slower than 1/30th of a second, the shutter speed will automatically be set to 1/30th of a second.





 **Note**

- The settings of the aperture value, shutter speed and exposure compensation can be changed during motion picture recording. In this case, care must be taken because the sounds of such operations may be recorded.
- Manually setting a higher shutter speed may increase the noise on-screen due to the higher sensitivity.
- When recording under lighting such as fluorescent lighting, LED lighting, mercury lighting and sodium lighting, the coloring and brightness of the screen may change.
- Refer to “Recording Motion Pictures” on P41 for other settings and operations for recording motion pictures.

Recording the High Speed Motion Picture DMC-FZ200

Using the [**HS**](High Speed Video) mode, you can record very fast motions that cannot be tracked by the naked eye at the rate of up to 240 frames/second.

- Motion pictures are recorded in [MP4].

- 1 Set the mode dial to [M].**
- 2 Press / to select [**HS**] and then press [MENU/SET].**
- 3 Press / to select the picture quality and then press [MENU/SET].**
 - You can also select the recording quality from [High Speed Video] (P150) in the [Motion Picture] menu.

 **Note**

- **It cannot be recorded into the built-in memory.**
- Audio is not recorded.
- Motion picture can be recorded continuously for up to 4 GB.
- The camera can record motion pictures for up to 29 minutes 59 seconds in playback time equivalent.
- The focus, zoom, exposure and White Balance is fixed to the value at the beginning of the recording motion picture.
- Under fluorescent lighting, flicker or horizontal bars may be seen.

Taking Pictures in Custom Mode

Recording modes:

You can register the current camera settings as custom settings. If you then record in Custom Mode, you can use the registered settings.

- Initial setting of the Program AE Mode is registered as the custom settings initially.

■ Example of registering the settings of the Recording Mode [P] and menus etc. to [C1]:



① Make settings

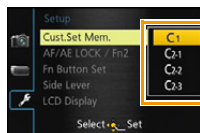

② Register

Even if you change the settings.

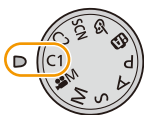

③ Set to Custom Mode

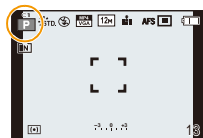

④ Settings registered in Step ② are called up

Registering Personal Menu Settings (Registering custom settings)

If you want to take pictures that have the same settings, you can register up to four items of the current camera settings to [Cust.Set Mem.].

Preparations: Set in advance the Recording Mode you wish to save and select the desired menu settings on the camera.

- 1 Set the mode dial to select the mode you wish to save, and then set the menu on the camera.
- 2 Select [Cust.Set Mem.] on the [Setup] menu. (P52)
- 3 Press ▲/▼ to select the custom set to register and then press [MENU/SET].

- Confirmation screen is displayed. It is executed when [Yes] is selected.
Exit the menu after it is executed.

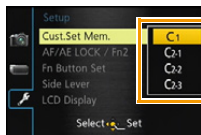

Recording using registered custom set

You can easily call up the settings you have registered using [Cust.Set Mem.].

Set the mode dial to [C1] or [C2].

Ⓐ Display custom settings

- When the mode dial is set to [C2], press ▲/▼ to select the custom set and then press [MENU/SET].

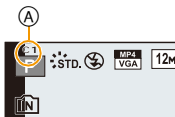

■ To change the menu settings

When the Recording Mode is set to [C1] or [C2], registered settings do not change even if you change the menu settings temporarily.

You can change the registered settings from [Cust.Set Mem.] in the [Setup] menu.

Note

- Since certain menu items would be reflected in other recording modes, they are not saved.

Taking a Picture with Face Recognition Function

Applicable modes:         

Face Recognition is a function which finds a face resembling a registered face and prioritizes focus and exposure automatically. Even if the person is located towards the back or on the end of a line in a group photo, the camera can still take a clear picture.

[Face Recog.] is initially set to [OFF] on the camera.

[Face Recog.] will turn [ON] automatically when the face image is registered.

- The following functions will also work with the Face Recognition function.

In Recording Mode

- Display of corresponding name when camera detects a registered face*
(if name has been set for the registered face)



In Playback Mode

- Display of name and age (if information has been registered)
- Selective playback of pictures chosen from pictures registered with Face Recognition ([Category Selection] in [Filtering Play]).

- * Names of up to 3 people are displayed. Precedence for the names displayed when taking pictures is determined according to the order of registration.

Note

- During the Burst Mode, [Face Recog.] picture information can be attached to only the first picture.
- [Face Recog.] does not guarantee secure recognition of a person.
- Face Recognition may take more time to select and recognize distinctive facial features than regular face detection.
- Even when Face Recognition information has been registered, pictures taken with [Name] set to [OFF] will not be categorized by Face Recognition in [Category Selection] ([Filtering Play]).
- **Even when Face Recognition information is changed (P131), Face Recognition information for the pictures already taken will not be changed.**
For instance, if the name is changed, pictures recorded before the change will not be categorized by Face Recognition in [Category Selection] ([Filtering Play]).
- To change the name information of the pictures taken, perform the [REPLACE] in [Face Rec Edit] (P174).
- [Face Recog.] cannot be used in the following cases.
 - Recording Modes which do not allow setting to  of [AF Mode]
 - [3D Photo Mode] (Scene Mode)
 - When using Manual Focus
 - When recording motion pictures

Face Settings

You can register information such as names and birthdays for face images of up to 6 people. Registration can be facilitated by taking multiple face images of each person. (up to 3 pictures/registration)

■ Point of recording when registering the face images

- Face front with eyes open and mouth closed, making sure the outline of the face, the eyes, or the eyebrows are not covered with the hair when registering.
- Make sure there is no extreme shading on the face when registering. (Flash will not flash during registration.)

(Good example for registering)

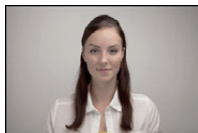

■ When it is not recognizing during recording

- Register the face of same person indoors and outdoors, or with different expressions or angles. (P131)
- Additionally register at the location of recording.
- When a person who is registered is not recognized, correct by re-registering.
- Face Recognition may not be possible or may not recognize faces correctly even for registered faces, depending on the facial expression and environment.

1 Select [Face Recog.] on the [Rec] menu and then press ►. (P52)

2 Press ▲/▼ to select [MEMORY] and then press [MENU/SET].

3 Press ▲/▼/◀/▶ to select the Face Recognition frame that is not registered, and then press [MENU/SET].

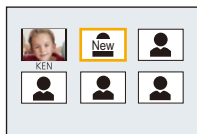

4 Take the picture adjusting the face with the guide.

- Confirmation screen is displayed. It is executed when [Yes] is selected.
- The faces of subjects other than people (pets, etc.) cannot be registered.
- When [DISP.] is pressed, an explanation appears for taking face images.

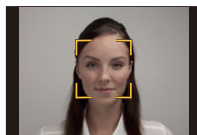

5 Select item to edit with ▲/▼, and then press ►.

- You can register up to 3 face images.

Item	Description of settings
[Name]	<p>It is possible to register names.</p> <ol style="list-style-type: none"> Press ▼ to select [SET] and then press [MENU/SET]. Enter the name. <ul style="list-style-type: none"> For details on how to enter characters, refer to “Entering Text” section on P132.
[Age]	<p>It is possible to register the birthday.</p> <ol style="list-style-type: none"> Press ▼ to select [SET] and then press [MENU/SET]. Press ◀/▶ to select the items (Year/Month/Day), and then press ▲/▼ to set and then press [MENU/SET].
[Focus Icon]	<p>Change the displayed focus icon when the subject is focused.</p> <p>Press ▲/▼ to select the focus icon, and then press [MENU/SET].</p>
[Add Images]	<p>To add additional face images.</p> <p>(Add Images)</p> <ol style="list-style-type: none"> Select the unregistered face recognition frame, and then press [MENU/SET]. Perform steps 4 in “Face Settings”.
	<p>To delete one of the face images.</p> <p>(Delete)</p> <p>Press ◀/▶ to select the face image to delete, and then press [MENU/SET].</p> <ul style="list-style-type: none"> If there is only one image registered, it cannot be deleted.

- Exit the menu after it is set.

Change or delete the information for a registered person

You can modify the pictures or information of an already registered person. You can also delete the information of the registered person.

- 1 Select [Face Recog.] from the [Rec] menu, and then press ►. (P52)
- 2 Press ▼ to select [MEMORY] and press [MENU/SET].
- 3 Press ▲/▼/◀/▶ to select the face image to edit or delete and then press [MENU/SET].
- 4 Press ▲/▼ to select the item and then press [MENU/SET].

Item	Description of settings
[Info Edit]	Changing the information of an already registered person. Perform step 5 in “Face Settings”.
[Priority]	The focus and exposure are preferentially adjusted for higher-priority faces. Press ▲/▼/◀/▶ to select the priority and then press [MENU/SET].
[Delete]	Deleting information of a registered person.

- Exit the menu after it is set.

Entering Text

It is possible to enter babies' and pets' names and the names of travel destinations when recording. (Only alphabetical characters and symbols can be entered.)

1 Display the entry screen.

- You can display the entry screen via the following operations.
 - [Name] of [Baby1]/[Baby2] or [Pet] in Scene Mode
 - [Name] in [Face Recog.]
 - [Location] in [Travel Date]
 - [Title Edit]

2 Press ▲/▼/◀/▶ to select text and then press [MENU/SET] to register.

- Move the cursor to [Aⁿ_a] and then press [MENU/SET] to switch text between [A] (capitals), [a] (lower case), [1] (numbers) and [&] (special characters).
- To enter the same character in a row, move the cursor by sliding the zoom lever to the [Q] (T) side or rotating the rear dial to the right.
- The following operations can be performed by moving the cursor to the item and pressing [MENU/SET]:
 - []: Enter a blank
 - [Delete]: Delete a character
 - [◀]: Move the entry position cursor to the left
 - [▶]: Move the entry position cursor to the right
- A maximum of 30 characters can be entered. (Maximum of 9 characters when setting names in [Face Recog.]
- * A maximum of 15 characters can be entered for [\], [[], []], [•] and [—] (Maximum of 6 characters when setting names in [Face Recog.]).



3 Press ▲/▼/◀/▶ to move the cursor to [Set] and then press [MENU/SET] to end text input.

Note

- Text can be scrolled if all of the entered text does not fit on the screen.
- It is displayed in order of title, location, [Name] ([Baby1]/[Baby2], [Pet]), [Name] ([Face Recog.]).







Using the [Rec] menu

For details on [Rec] menu settings, refer to [P52](#).

[Photo Style]

Applicable modes:  **P** **A** **S** **M**  **C1** **C2**  

6 effects can be selected to match the image you wish to record. It is possible to adjust the items such as color or picture quality of the effect to your desire.

Settings	Description of settings
 STD. [Standard]	This is the standard setting.
 VIVID [Vivid]	Brilliant effect with high saturation and contrast.
 NAT [Natural]	Soft effect with low contrast.
 MONO [Monochrome]	Monochrome effect with no color shades.
 SCNY [Scenery]	An effect appropriate for scenes with vivid blue skies and greens.
 PORT [Portrait]	An effect appropriate for portrait picture with a healthy and beautiful skin tone.
 CUST [Custom]	Use the setting registered in advance.

■ Adjusting the picture quality

- 1 Press ◀/▶ to select the type of Photo Style.
- 2 Press ▲/▼ to select the items, and then press ◀/▶ to adjust.

Item		Effect
☉ [Contrast]	[+]	Increases the difference between the brightness and the darkness in the picture.
	[-]	Decreases the difference between the brightness and the darkness in the picture.
Ⓢ [Sharpness]	[+]	The picture is sharply defined.
	[-]	The picture is softly focused.
⊕ [Saturation]	[+]	The colors in the picture become vivid.
	[-]	The colors in the picture become natural.
NR [Noise Reduction]	[+]	The noise reduction effect is enhanced. Picture resolution may deteriorate slightly.
	[-]	The noise reduction effect is reduced. You can obtain pictures with higher resolution.

- Registered settings are memorized even if the camera is turned off.
- If you adjust the picture quality, [+] is displayed beside the Photo Style icon on the screen.
- Color can be changed by [Saturation] when [Monochrome] is selected.

3 Press ▼ to select [Custom setting] and then press [MENU/SET].

- Confirmation screen is displayed. It is executed when [Yes] is selected.
- Setting can be registered in [Custom].

[Aspect Ratio]

Applicable modes:

This allows you to select the aspect ratio of the pictures to suit printing or the playback method.

Settings	Description of settings
[4:3]	[Aspect Ratio] of a 4:3 TV
[3:2]	[Aspect Ratio] of a 35 mm film camera
[16:9]	[Aspect Ratio] of a high-definition TV, etc.
[1:1]	Square aspect ratio

Note





- The ends of the recorded pictures may be cut at printing so check before printing. (P217)





[Picture Size]





Applicable modes: **FA P A S M**    





Set the number of pixels. The higher the numbers of pixels, the finer the detail of the pictures will appear even when they are printed onto large sheets.

DMC-FZ200

[Aspect Ratio]: [4:3]	
[12M]	4000×3000
[8M ]*	3264×2448
[5M ]	2560×1920
[3M ]*	2048×1536
[2M ]*	1600×1200
[0.3M ]	640×480

[Aspect Ratio]: [3:2]	
[10.5M]	4000×2672
[7M ]*	3264×2176
[4.5M ]*	2560×1712
[2.5M ]*	2048×1360
[0.3M ]*	640×424

[Aspect Ratio]: [16:9]	
[9M]	4000×2248
[6M ]*	3264×1840
[3.5M ]*	2560×1440
[2M ]*	1920×1080
[0.2M ]*	640×360

[Aspect Ratio]: [1:1]	
[9M]	2992×2992
[6M ]*	2448×2448
[3.5M ]*	1920×1920
[2.5M ]*	1536×1536
[0.2M ]*	480×480

* This item cannot be set in the Intelligent Auto Mode.

DMC-FZ60

[Aspect Ratio]: [4:3]	
[16M]	4608×3456
[10M [Z]]*	3648×2736
[7M [Z]]*	3072×2304
[5M [Z]]	2560×1920
[3M [Z]]*	2048×1536
[0.3M [Z]]	640×480

[Aspect Ratio]: [3:2]	
[14M]	4608×3072
[9M [Z]]*	3648×2432
[6M [Z]]*	3072×2048
[4.5M [Z]]*	2560×1712
[2.5M [Z]]*	2048×1360
[0.3M [Z]]*	640×424

[Aspect Ratio]: [16:9]	
[12M]	4608×2592
[7.5M [Z]]*	3648×2056
[5.5M [Z]]*	3072×1728
[3.5M [Z]]*	2560×1440
[2M [Z]]*	1920×1080
[0.2M [Z]]*	640×360

[Aspect Ratio]: [1:1]	
[12M]	3456×3456
[7.5M [Z]]*	2736×2736
[5.5M [Z]]*	2304×2304
[3.5M [Z]]*	1920×1920
[2.5M [Z]]*	1536×1536
[0.2M [Z]]*	480×480

* This item cannot be set in the Intelligent Auto Mode.

 **Note**

- If you change the aspect ratio, set the picture size again.
- In specific modes, Extended Optical Zoom cannot be used, and the picture size for [**[Z]**] is not displayed. For details regarding modes in which Extended Optical Zoom cannot be used, refer to P74.
- Pictures may appear in mosaic depending on the subject and the recording conditions.

DMC-FZ200

- You cannot set [Picture Size] when [Quality] is set to [RAW].

[Quality]

Applicable modes:

Set the compression rate at which the pictures are to be stored.

Settings		Description of settings
	JPEG	A JPEG image in which image quality was given priority.
		A standard image quality JPEG image. This is useful for increasing the number of shots without changing the number of pixels.
DMC-FZ200 [RAW] [RAW]	RAW+JPEG	You can record a RAW image and a JPEG image (or) simultaneously.*1
DMC-FZ200 [RAW]	RAW	You can only record RAW images.*2

*1 If you delete a RAW file from the camera, the corresponding JPEG image will also be deleted.

*2 It is fixed to maximum recordable pixels for each image aspect ratio.

Note

- [Quality] is fixed to in the following case.
 - [High Sens.] (Scene Mode)
- The following icons are displayed during the 3D recording.

([3D+Fine]): Both MPO images and fine JPEG images are recorded simultaneously.

([3D+Standard]): Both MPO images and standard JPEG images are recorded simultaneously.

DMC-FZ200

- You can enjoy more advanced picture editing if you use RAW files. You can save RAW files in a file format (JPEG, TIFF etc.) that can be displayed on your PC etc., develop them and edit them using the software "SILKYPIX Developer Studio" by Ichikawa Soft Laboratory on the CD-ROM (supplied).
- [RAW] images are recorded with a smaller data volume than [RAW] or [RAW].

[ISO Limit Set]

Applicable modes:        

It will select optimal ISO sensitivity with set value as limit depending on the brightness of the subject.

Settings: [AUTO]/[200]/[400]/[800]/[1600]/[3200]

Note

- It is possible to set when the [Sensitivity] is set to [AUTO] or [ISO].
- Setting items below will be selectable in Creative Video Mode.
Settings: [AUTO]/[200]/[400]/[800]/[1600]/[3200]/[6400]

[ISO Increments]

Applicable modes:        

You can adjust the ISO sensitivity settings for every 1/3 EV.

Settings	Description of settings
[1/3 EV]	[100]/[125]/[160]/[200]/[250]/[320]/[400]/[500]/[640]/[800]/[1000]/[1250]/[1600]/[2000]/[2500]/[3200]/[H4000]*/[H5000]*/[H6400]*
[1 EV]	[100]/[200]/[400]/[800]/[1600]/[3200]/[H6400]*

DMC-FZ200

* Only available when [Extended ISO] is set.

Note

- When the setting is changed from [1/3 EV] to [1 EV], ISO sensitivity will be set to value closest to the value set during the [1/3 EV]. (Set value will not restore when the setting is changed back to [1/3 EV]. It will stay as the setting selected for [1 EV].)

[Extended ISO] DMC-FZ200

Applicable modes:        

It will be possible to set ISO sensitivity up to [6400].

Settings: [ON]/[OFF]

[Face Recog.]

- Refer to [P128](#) for details.

[AF Mode]

- Refer to [P92](#) for details.

[AF Style]

Applicable modes: 

Select how the focus is adjusted when taking a still picture.

Settings	The movement of the subject and the scene (recommended)	Description of settings
AFS	Subject is still (Scenery, anniversary photograph, etc.)	“AFS” is an abbreviation of “Auto Focus Single”. Focus is set automatically when the shutter button is pressed halfway. Focus will be fixed while it is pressed halfway.
AFF	Movement cannot be predicted (Children, pets, etc.)	“AFF” is an abbreviation of “Auto Focus Flexible”. In this mode, focusing is performed automatically when the shutter button is pressed halfway. If the subject moves while the shutter button is pressed halfway, the focus is corrected to match the movement automatically.
AFC	Subject is moving (Sport, trains, etc.)	“AFC” is an abbreviation of “Auto Focus Continuous”. In this mode, while the shutter button is pressed halfway, focusing is constantly performed to match the movement of the subject. When the subject is moving, the focusing is performed by predicting the subject position at the time of recording.

• When recording using [AFF], [AFC]

- Press the shutter button halfway again when it is difficult to focus on the subject.
- While the shutter button pressed halfway, shake may be seen on the screen.
- The battery will be consumed faster than usual.

[Quick AF]

Applicable modes:  

As long as the camera is held steady, the camera will automatically adjust the focus and focus adjustment will then be quicker when the shutter is pressed. This is useful when you do not want to miss a picture-taking opportunity.

Settings: [ON]/[OFF]

Note

- The battery will be consumed faster than usual.
- Press the shutter button halfway again when it is difficult to focus on the subject.
- It does not operate during AF tracking.
- You cannot set [Quick AF] in the following cases.
 - [Panning]/[Night Portrait]/[Night Scenery]/[Handheld Night Shot] (Scene Mode)
 - [Soft Focus] (Creative Control Mode)
 - When using Manual Focus





[AF/AE Lock]

- Refer to [P102](#) for details.

[Metering Mode]

Applicable modes:  

Type of optical measurement to measure brightness can be changed.

Settings	Description of settings
 : Multiple	This is the method in which the camera measures the most suitable exposure by judging the allocation of brightness on the whole screen automatically. Usually, we recommend using this method.
 : Center weighted	This is the method used to focus on the subject on the center of the screen and measure the whole screen evenly.
 : Spot	This is the method to measure the subject in the spot metering target  .

[i.Dynamic] (Intelligent dynamic range control)

Applicable modes:  **P** **A** **S** **M**  **C1** **C2**  

Contrast and exposure will be adjusted automatically when there is a big difference in brightness between the background and subject, to bring the image close to how you see.

Settings: [HIGH]/[STANDARD]/[LOW]/[OFF]

Note

- Even when the [Sensitivity] is set to [100], [Sensitivity] may be set higher than [100] if the picture is taken with [i.Dynamic] set to valid.
- Compensation effect may not be achieved depending on the conditions.
- [LOW], [STANDARD], or [HIGH] represents the maximum range of effect.

[Min. Shtr Speed]

Applicable modes:  **P** **A** **S** **M**  **C1** **C2**  

You can take a picture brightly in dark places by setting [Min. Shtr Speed] slower. Also, you can set it faster to reduce the blur of the subject.

Settings: [AUTO], [1/250], [1/125], [1/60], [1/30], [1/15], [1/8], [1/4], [1/2]*, [1]*

DMC-FZ60

* When [Sensitivity] is set to [2000], [2500], or [3200], the camera sets the shutter speed at [1/4].

Minimum shutter speed setting	1/250 ← → 1	
Brightness	Darker	Brighter
Jitter	Less	More

Note

- This should usually be set to [AUTO] to take pictures. (When you select a minimum shutter speed other than [AUTO], [MIN] appears on the screen.)
- When [AUTO] is selected, shutter speed may be set up to 1 second when there is not much jitter to adjust with the [Stabilizer], or when [Stabilizer] is set to [OFF].
- Setting [Min. Shtr Speed] to slower speed might increase the chance of jitter, so we recommend using a tripod and the Self-timer for taking pictures.
- Setting [Min. Shtr Speed] to faster speed might make the picture darker, so we recommend recording the picture in well-lit area. If correct exposure cannot be achieved, [MIN] will flash in red when the shutter button is pressed halfway.

[i.Resolution]

Applicable modes:  **P** **A** **S** **M**  **C1** **C2**  

Pictures with sharp profile and resolution can be taken by utilizing the Intelligent Resolution Technology.

Settings	Description of settings
[i.ZOOM]	[i.Resolution] is activated, and zoom magnification increased to 2 times while limiting deterioration of the picture.
[ON]	[i.Resolution] is activated.
[OFF]	—

Note

- Refer to [P71](#) for information about the Intelligent Zoom.

[Digital Zoom]

Applicable modes:  **P** **A** **S** **M**  **C1** **C2**  

This can enlarge subjects even more than the Optical Zoom, the Extended Optical Zoom or the Intelligent Zoom.

Settings: [ON]/[OFF]

Note

- Refer to [P71](#) for details.

DMC-FZ60

- The setting is fixed to [ON] in the following case.
 - Macro Zoom Mode

[Stabilizer]

Applicable modes:  **P** **A** **S** **M**  **C1** **C2** **SCN** 

Using this mode, jitter during picture taking is detected, and the camera automatically compensates for the jitter, enabling jitter-free images to be taken.

When recording motion pictures, “Active Mode” (stabilizer for motion pictures) will automatically function. This decreases the jitter of the image when recording motion pictures while walking, etc.

Settings: [ON]/[OFF]

Note

- In “Active Mode”, stronger effect of the correction can be achieved at the wide end.
- In the following case, “Active Mode” will not function even when recording motion pictures.
 - When [Rec Mode] is set to [VGA] in [MP4]
 - When [Conversion] is set
- The stabilizer function may not be effective in the following cases. Be careful of camera jitter when you press the shutter button.
 - When there is a lot of jitter.
 - When the zoom magnification is high.
 - In digital zoom range.
 - When taking pictures while following a moving subject.
 - When the shutter speed becomes slower to take pictures indoors or in dark places.
- When [ON] in the Scene Mode [Panning] is selected, the Optical Image Stabilizer is only available when using in the vertical orientation.
- The setting is fixed to [ON] in the following case.
 - [Handheld Night Shot] (Scene Mode)
- The setting is fixed to [OFF] in the following cases.
 - [Panorama Shot]/[3D Photo Mode] (Scene Mode)

DMC-FZ200

- [High Speed Video] (Creative Video Mode)

[AF Assist Lamp]

Applicable modes:  **P A S M**  **C1 C2 SCN** 

AF assist lamp will illuminate the subject when the shutter button is pressed halfway, making it easier for the camera to focus when recording in low light conditions. (Larger AF area is displayed depending on the recording conditions.)

Settings: [ON]/[OFF]

- The effective range of the AF Assist Lamp is 1.5 m (4.9 feet).
- When you do not want to use the AF Assist Lamp  (e.g. when taking pictures of animals in dark places), set the [AF Assist Lamp] to [OFF]. In this case, it will become more difficult to focus on the subject.
- A vignetting effect may appear on the circumference of the AF Assist Lamp because the AF Assist Lamp may be obscured by the lens, however, this does not cause a problem with the performance of the camera.
- [AF Assist Lamp] is fixed to [OFF] in the following cases.
 - [Scenery]/[Panning]/[Night Scenery]/[Handheld Night Shot]/[Sunset]/[Glass Through] (Scene Mode)

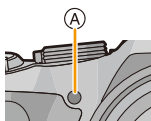



[Flash]

- Refer to [P75](#) for details.

[Flash Synchro]

Applicable modes:  **P A S M**  **C1 C2 SCN** 

2nd curtain synchro activates the flash just before the shutter closes when taking pictures of moving objects such as cars using a slow shutter speed.

Settings	Description of settings
[1ST]	1st curtain synchro The normal method when taking pictures with the flash. 
[2ND]	2nd curtain synchro The light source appears behind the subject and picture becomes dynamic. 

Note

- Set it to [1ST] for normal use.
- [2nd] is displayed in the flash icon on the screen if you set [Flash Synchro] to [2ND].
- When a fast shutter speed is set, the effect of [Flash Synchro] may deteriorate.

[Flash Adjust.]

Applicable modes: **P A S M** **C1 C2 SCN**

Adjust the flash output if the recorded pictures are too bright or too dark.

Note

- You can adjust from [-2 EV] to [+2 EV] in steps of [1/3 EV].
- Select [0 EV] to return to the original flash output.
- [+] or [-] is displayed on the flash icon in the screen when the flash level is adjusted.

[Red-Eye Removal]

Applicable modes: **P A S M** **C1 C2 SCN**

When Red-Eye Reduction ([], []) is selected, Red-Eye Removal is performed whenever the flash is used. The camera automatically detects red-eye and corrects the picture.

Settings: [ON]/[OFF]

Note

- Only available when [AF Mode] is set to [] and Face Detection is active.
- Under certain circumstances, red-eye cannot be corrected.
- It will be fixed to [ON] during the Intelligent Auto Mode.
- [Red-Eye Removal] cannot be used in the following cases.
 - [3D Photo Mode] (Scene Mode)

[Conversion]

Applicable modes: **P A S M** **C1 C2 SCN**

With the optional conversion lenses, you can record even more faraway pictures and take close-up pictures of smaller subjects.

Settings	Description of settings
[]	When you attach the tele conversion lens.
[]	When you attach the close-up lens.
[OFF]	—

Note

- Refer to **P194** for details about attaching the lens.
- Ensure that [Conversion] is set to [OFF] when not using a conversion lens.
- [Conversion] cannot be used in the following cases.
 - [Panorama Shot]/[3D Photo Mode] (Scene Mode)
- Read the operating instructions of the conversion lens for details.

[Auto Bracket]

Applicable modes:        

In this mode, 3 pictures are automatically recorded in the selected exposure compensation range each time the shutter button is pressed.

With Auto Bracket ± 1 EV

1st picture



± 0 EV

2nd picture





-1 EV

3rd picture



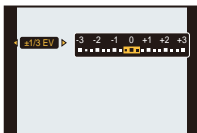

$+1$ EV

Press   to set the compensation range of the exposure and then press [MENU/SET].



- When you do not use Auto Bracket, select [OFF] (0).

Note

- When Auto Bracket is set,  is displayed on the screen.
- When taking pictures using Auto Bracket after setting the exposure compensation range, the pictures taken are based on the selected exposure compensation range.
- The exposure may not be compensated with Auto Bracket depending on the brightness of the subject.
- In Shutter-Priority AE and Manual Exposure, if the shutter speed is set to more than 1 second, Auto Bracket is canceled.
-  is set for the flash when Auto Bracket is set.
- You cannot use the Auto Bracket in following conditions.
 - [Miniature Effect]/[Soft Focus]/[Star Filter] (Creative Control Mode)
 - [Panorama Shot]/[Handheld Night Shot]/[HDR]/[3D Photo Mode] (Scene Mode)
 - When recording motion pictures

[Date Stamp]

Applicable modes:  **P** **A** **S** **M**  **C1** **C2** **SCN** 

You can take a picture with date and time of recording.

Settings	Description of settings
[W/O TIME]	Stamp the year, month, and day.
[WITH TIME]	Stamp the year, month, day, hour, and minutes.
[OFF]	—

Note

- Date information for pictures recorded with the [Date Stamp] set cannot be deleted.
- When printing pictures with [Date Stamp] at a shop or with a printer, the date will be printed on top of the other if you choose to print with the date.
- If the time has not been set, you cannot stamp with the date information.
- The camera cannot stamp the date in the following cases.
 - The clock is not set

DMC-FZ200

- The [Quality] option is set to [RAW]

- The setting is fixed to [OFF] in the following cases.
 - When recording motion pictures
 - When using Auto Bracket
 - [Panorama Shot]/[3D Photo Mode] (Scene Mode)
 - When using [Burst].
- [Text Stamp], [Resize], [Cropping] and [Leveling] cannot be set for pictures recorded with [Date Stamp] set.
- Even if you take a picture with [Date Stamp] set to [OFF], it is possible to stamp dates onto the recorded pictures using [Text Stamp] (P164) or setup the Date print (P172, 191).

[Clock Set]

- Refer to P27 for details.

Using the [Motion Picture] menu

For details on [Motion Picture] menu settings, refer to [P52](#).

In Creative Video Mode, the settable [Rec] menu will be displayed in the [Motion Picture] menu.

- The [Motion Picture] menu is not displayed in the following cases.
 - [Panorama Shot]/[3D Photo Mode] (Scene Mode)
 - [Soft Focus]/[Star Filter] (Creative Control Mode)

[Rec Mode]

Applicable modes:          

This sets up the data format of motion pictures.

Settings	Description of settings
[AVCHD]	Select this format to record HD (high definition) motion pictures for playback on your HDTV using an HDMI connection.
[MP4]	Select this format to record standard definition motion pictures for playback on your PC.

[Rec Quality]

Applicable modes:          

This sets up the picture quality of motion pictures.

When [AVCHD] is selected

Settings	Picture size/Bit rate	fps*	Aspect ratio
DMC-FZ200 [PSH]	1920×1080 pixels/Approx. 28 Mbps	60p	16:9
[FSH]	1920×1080 pixels/Approx. 17 Mbps	60i	
[SH]	1280×720 pixels/Approx. 17 Mbps	60p	

DMC-FZ200

* Sensor output is 60 fps

DMC-FZ60

* Sensor output is 30 fps

When [MP4] is selected

Settings	Picture size/Bit rate	fps	Aspect ratio
[FHD]	1920×1080 pixels/Approx. 20 Mbps	30	16:9
[HD]	1280×720 pixels/Approx. 10 Mbps		4:3
[VGA]	640×480 pixels/Approx. 4 Mbps		

 **Note**

• What is bit rate

This is the volume of data for a definite period of time, and the quality becomes higher when the number gets bigger. This unit is using the “VBR” recording method. “VBR” is an abbreviation of “Variable Bit Rate”, and the bit rate (volume of data for definite period of time) is changed automatically depending on the subject to record. Therefore, the recording time is shortened when a subject with fast movement is recorded.

[High Speed Video] **DMC-FZ200****Applicable modes:** 

Set the picture quality for the [High Speed Video] recording in the Creative Video Mode.

- This menu is displayed only when [High Speed Video] is set.

Settings	Description of settings
[240fps VGA]	Recording 240 frames/second in [VGA] of [MP4]
[120fps HD]	Recording 120 frames/second in [HD] of [MP4]

[Continuous AF]**Applicable modes:** 

It will continually keep on focusing to the subject that the focus was once set.

Settings: [ON]/[OFF] **Note**

- Set this function to [OFF] if you wish to fix the focus on the position where you started the motion picture recording.

[Wind Cut]

Applicable modes:         

This prevents the recording of wind-noise automatically.

Settings: [AUTO]/[OFF]

Note

- Sound quality may be different than usual when [Wind Cut] is set.
- It is fixed to [OFF] in the following cases.
 - [Miniature Effect] (Creative Control Mode)
 - When the [Zoom Mic] is set to [ON]

DMC-FZ200

- [High Speed Video] (Creative Video Mode)

[Zoom Mic]

Applicable modes:         

Coupled to the zoom operation, it will clearly record far sounds with tele, and surrounding sounds with wide.

Settings: [ON]/[OFF]

Note

- When set to [ON] and performing zoom, the operation sound may be recorded enhanced in accordance with the surrounding sounds. Also, audio recording level will be lower compared to when [OFF].
- The stereo effect of the audio is reduced when the picture is enlarged.
- It is fixed to [OFF] in the following cases.
 - [Miniature Effect] (Creative Control Mode)

DMC-FZ200

- [High Speed Video] (Creative Video Mode)

Having Fun with Recorded Pictures

[Auto Retouch]

The brightness and color of the pictures taken can be balanced.

- With [Auto Retouch], a new edited picture is created. Check that there is free space on the built-in memory or the card.

[Auto Retouch] cannot be used if the card's Write-Protect switch is set to [LOCK].



- * These pictures are examples to show the effect.

1 Press **◀/▶** to select a picture, and then press **▲**.

2 Press **▲/▼** to select [Auto Retouch], and then press [MENU/SET].

3 Press **▲/▼** to select [ON], and then press [MENU/SET].

- Confirmation screen is displayed. It is executed when [Yes] is selected.

Note

- Depending on the picture, noise may be emphasized by [Auto Retouch].
- Effects may be difficult to see depending on the picture.
- It may not be possible to perform [Auto Retouch] on pictures which have already been retouched.
- [Auto Retouch] may not be performed on pictures recorded with other equipment.
- [Auto Retouch] is not possible in the following cases:
 - Motion pictures
 - 3D pictures
 - Pictures taken in [Panorama Shot] in Scene Mode

[Creative Retouch]

You can add your desired effects to the pictures that you have taken.

- With [Creative Retouch], a new edited picture is created. Check that there is free space on the built-in memory or the card.

[Creative Retouch] cannot be used if the card's Write-Protect switch is set to [LOCK].

1 Press ◀/▶ to select a picture, and then press ▲.

2 Press ▲/▼ to select [Creative Retouch], and then press [MENU/SET].

3 Press ▲/▼ to select an item, and then press [MENU/SET].

- You can select the item from the following options that are also available in the Creative Control mode. Read P117 for details on the respective effects.
[Expressive]/[Retro]/[High Key]/[Low Key]/[Sepia]/[Dynamic Monochrome]/[Impressive Art]/[High Dynamic]/[Cross Process]/[Toy Effect]/[Miniature Effect]/[Soft Focus]/[Star Filter]/[One Point Color]
- Confirmation screen is displayed. It is executed when [Yes] is selected.
- If you press [MENU/SET] while the following items are selected, you can add the image effect that matches your preference.
 - [Cross Process]: You can select the image effect from Greenish, Bluish, Yellowish or Reddish.
 - [Toy Effect]: You can select the image effect from Orange emphasized, Standard, Blue emphasized.
 - [One Point Color]: Set the color you want to leave.

Note

- Effects may be difficult to see depending on the picture.
- The image effect may appear weak compared to the effect given by the Creative Control Mode.
- [Creative Retouch] may not be performed on pictures recorded with other equipment.
- [Creative Retouch] is not possible in the following cases:
 - Motion pictures
 - 3D pictures
 - Pictures taken in [Panorama Shot] in Scene Mode

Playing Back Burst Pictures DMC-FZ200

■ About the burst picture group

Pictures taken with burst speed set to [] or [] are recorded as a single burst picture group.

The burst icon [] will be displayed for the burst picture group.

- Deleting and editing in a group unit is possible. (For example, if you delete a burst picture group with [], all the pictures in that group are deleted.)



Note

- Burst pictures recorded after the number of burst pictures has exceeded 50000 will not be grouped.
- Burst pictures recorded on other cameras may not be recognized as a burst picture group.
- Burst pictures will not be grouped if recorded without setting the clock.
- If you delete all pictures except one, that picture will be saved as a single picture instead of as a burst picture group.

Continuously playing back burst pictures

Press ◀/▶ to select a picture with a burst icon [], and then press ▲.

■ Operations when continuously playing back the burst picture group

The cursor displayed during playback is the same as ▲/▼/◀/▶.

▲	Play/Pause	
▼	Stop	
◀	Fast rewind, Previous picture*	
▶	Fast forward, Next picture*	

* These operations can be performed only in the Pause Mode.

Playing back each burst picture

1 Select a picture with a burst icon [], and then press ▼.

2 Press ◀/▶ to select the picture.

- Press ▼ again to return to the normal playback screen.
- The same playback controls used for normal pictures can be used for pictures within the burst picture group. (Such as Multi Playback, Playback Zoom and deleting images)

Editing Burst Pictures DMC-FZ200

• The following editing menu can be used.

– [Upload Set]/[Title Edit]/[Text Stamp]/[Resize]/[Cropping]*/[Leveling]*/[Favorite]/[Print Set]/[Protect]/[Copy]

* Cannot be used for the entire burst picture group.

Editing in burst picture group units (All pictures in the burst picture group)

- 1 Press [MENU/SET] during playback to display the [Playback] menu. (P52)
- 2 Press ▲/▼ to select item, and press ►.
- 3 Select [Single] or [Multi] and then press [MENU/SET].
- 4 Select an image with burst icon [📁], and perform editing.

Editing single pictures within a burst picture group

- 1 Select a picture with a burst icon [📁], and then press ▼.
- 2 Press [MENU/SET] to display the [Playback] menu.
- 3 Press ▲/▼ to select item, and press ►.
- 4 Select [Single] or [Multi] and then press [MENU/SET].
- 5 Select the picture, and perform editing.

■ About display of [Favorite], [Print Set] and [Protect] icons during playback of burst picture groups

By setting [Favorite] (P170), [Print Set] (P171), or [Protect] (P173) setting to a picture in the Burst Picture Group, number of settings (number of settings and total number when [Print Set] is set) is displayed on the icon for the first picture of each group.

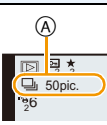
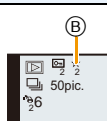
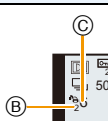
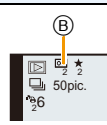
Initial screen for burst picture group (first burst picture)	[Favorite]	[Print Set]	[Protect]
			
<p>(A) Total number of all pictures stored within the burst picture group.</p> <p>(B) Number of pictures in given burst picture group subject to a setting.</p> <p>(C) Total number of prints set over all burst picture groups.</p> <ul style="list-style-type: none"> • For example, if 3 pictures are to be printed from each of 2 burst pictures within the group, a "6" will appear here. 			

Note

- For details on the various ways of editing, refer to "Using the [Playback] menu". (P161)
- Pictures for which you have performed [Text Stamp], [Resize], [Cropping] or [Leveling] will be saved separately from burst pictures.

Various methods of playback

You can play back the recorded pictures in various methods.

- 1 Press **[MENU/SET]** during playback.
- 2 Press **▶**.
- 3 Press **▲/▼** to select the item and then press **[MENU/SET]**.

- Following items can be selected.

[Normal Play] (P45)
[2D/3D Settings]*
[Slide Show] (P156)

[Filtering Play] (P159)
[Calendar] (P160)

- * The playback method for the 3D pictures can be switched. This item is only displayed during HDMI output. Refer to P180 for details about the playback method.

[Slide Show]

You can play back the pictures you have taken in synchronization with music, and you can do this in sequence while leaving a fixed interval between each of the pictures.

You can also put together a slide show composed of only still pictures, only motion pictures, only 3D pictures etc.

We recommend this feature when you view your pictures by connecting the camera to a TV.

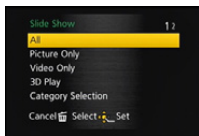

- 1 Select the group to play back by pressing **▲/▼**, and then press **[MENU/SET]**.
- 2 Press **▲/▼** to select the item and then press **[MENU/SET]**.
 - Refer to P180 for the method to play back [3D Play] pictures in 3D.
 - During [Category Selection], press **▲/▼/◀/▶** to select a category, and then press **[MENU/SET]**. Refer to P159 for category details.
- 3 Press **▲** to select **[Start]** and then press **[MENU/SET]**.
- 4 Press **▼** to finish the slide show.

- Normal playback resumes after the slide show finishes.



■ Operations performed during slide show

The cursor displayed during playback is the same as ▲/▼/◀/▶.

▲	Play/Pause	
▼	Stop	
◀	Back to previous picture*	
▶	Ahead to next picture*	
[W]	Reduce volume level	
[T]	Increase volume level	

* Operable only in the following cases.

- in the Pause Mode
- during motion picture playback
- during panorama picture playback

DMC-FZ200

- during Burst Picture Group playback

■ Changing the slide show settings

You can change the settings for slide show playback by selecting [Effect] or [Setup] on the slide show menu screen.

[Effect]

This allows you to select the screen effects when switching from one picture to the next.

[NATURAL], [SLOW], [SWING], [URBAN], [OFF], [AUTO]

- When [URBAN] has been selected, the picture may appear in black and white as a screen effect.
- [AUTO] can be used only when [Category Selection] has been selected. The pictures are played back with the recommended effects in each category.

DMC-FZ200

- [Effect] is fixed to [OFF] during the [Video Only] slide show, or during a slide show of [] in [Category Selection].
- Even if [Effect] is set, it does not work during a slide show of burst picture group.

DMC-FZ60

- During the [Video Only] slide show, [Effect] is fixed to [OFF].
- Some [Effect] will not operate when playing back pictures displayed vertically.
- Screen effects do not operate during a [3D Play] slide show.

[Setup]

[Duration] or [Repeat] can be set.

Settings	Description of settings
[Duration]	[1 SEC.]/[2 SEC.]/[3 SEC.]/[5 SEC.]
[Repeat]	[ON]/[OFF]
[Sound]	<p>[AUTO]: Music is played when the still pictures are played back, and audio is played when the motion pictures are played back.</p> <p>[Music]: Music is played back.</p> <p>[Audio]: Audio (only for motion pictures) is played back.</p> <p>[OFF]: There will be no sound.</p>

- [Duration] can be set only when [OFF] has been selected as the [Effect] setting.
- The [Duration] setting is not applicable to the following images during a slide show.
 - Motion pictures
 - Panorama pictures

DMC-FZ200

- Burst Picture Group





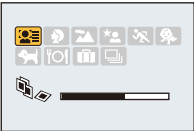





[Filtering Play]

Pictures are classified into only still pictures, only motion pictures, or only 3D pictures etc., and played back.

Settings	Description of settings
[Picture Only]	Only still pictures are played back.
[Video Only]	Only motion pictures are played back.
[3D Play]	Only 3D pictures are played back. • Refer to P180 for the method to play back [3D Play] pictures in 3D.
[Category Selection]	<p>This mode allows you to search images by Scene Mode or other categories (such as [Portrait], [Scenery] or [Night Scenery]) and sort the pictures into each of the categories. You can then play back the pictures in each category.</p> <p>Press ▲/▼/◀/▶ to select the category and then press [MENU/SET] to set.</p> <p>• Only the category for which pictures have been found can be selected.</p> 
[Favorite]	You can play back the pictures you have set as [Favorite] (P170).

■ About the categories to be sorted

It will be sorted as following when [Category Selection] is set.

	Recording information e.g. Scene Modes
	[Face Recog.]*1
	[Portrait], [i-Portrait], [Soft Skin], [Night Portrait], [i-Night Portrait], [Baby1]/[Baby2], [i-Baby]
	[Scenery], [i-Scenery], [Panorama Shot], [Sunset], [i-Sunset], [Glass Through]
	[Night Portrait], [i-Night Portrait], [Night Scenery], [i-Night Scenery], [Handheld Night Shot], [iHandheld Nite Shot]
	[Sports], [Panning]
	[Baby1]/[Baby2], [i-Baby]
	[Pet]
	[Food]
	[Travel Date]
  *2	Pictures taken with burst speed set to [] or []

*1 Press ▲/▼/◀/▶ to select the person to play back and then press [MENU/SET].

*2 The whole group with pictures taken with burst settings [] and [] will be treated as face recognition pictures.

[Calendar]

You can display pictures by recording date.

1 Press ▲/▼/◀/▶ to select the date to be played back.

- If there were no pictures recorded during a month, that month is not displayed.



2 Press [MENU/SET] to display the pictures that were recorded on the selected date.

- Press [🗑️/➡️] to return to the calendar screen.

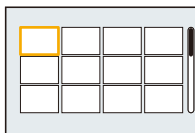

Note

- The recording date of the picture selected in the playback screen becomes the date selected when the calendar screen is first displayed.
- If there are multiple pictures with the same recording date, the first picture recorded on that day is displayed.
- You can display the calendar between January 2000 and December 2099.
- If the date is not set in the camera, the recording date is set as January 1st, 2012.
- If you take pictures after setting the travel destination in [World Time], the pictures are displayed by the dates at the travel destination in Calendar Playback.

Using the [Playback] menu

You can setup pictures to be uploaded to image sharing sites and perform editing like cropping recorded pictures, as well as set up the protection of recorded images, etc.

- With [Text Stamp], [Resize], [Cropping] or [Leveling], a new edited picture is created. A new picture cannot be created if there is no free space on the built-in memory or the card so we recommend checking that there is free space and then editing the picture.

[Upload Set]

It is possible to setup the images to be uploaded to the image sharing sites (Facebook/YouTube) on this unit.

- You can only upload motion pictures to YouTube, while you may upload both motion pictures and still pictures to Facebook.
- **This cannot be done to the images in the built-in memory. Copy the images to a card (P175), and then perform the [Upload Set].**

1 Select [Upload Set] on the [Playback] menu. (P52)

2 Press ▲/▼ to select [Single] or [Multi] and then press [MENU/SET].

3 Select the picture, and then press [MENU/SET] to set.

- The setting is canceled when [MENU/SET] is pressed again.
- Exit the menu after it is set.

[Multi] setting

Press [DISP.] to set (repeat), and then press [MENU/SET] to set.

- The setting is canceled when [DISP.] is pressed again.
 - Confirmation screen is displayed. It is executed when [Yes] is selected.
- Exit the menu after it is executed.

[Single]

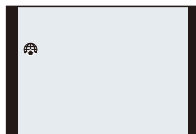

Press ◀/▶ to select the picture.

[Multi]

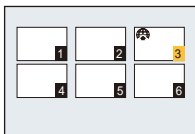

Press ▲/▼/◀/▶ to select the pictures.

■ Upload to the image sharing sites

An upload tool built-in to the camera “LUMIX Image Uploader” is automatically copied to the card when you setup [Upload Set].

Perform the upload operation after connecting the camera to a PC (P182). For details, refer to P185.

■ Canceling all the [Upload Set] settings

1 Select [Upload Set] on the [Playback] menu.

2 Press ▲/▼ to select [Cancel] and then press [MENU/SET].

- Confirmation screen is displayed. It is executed when [Yes] is selected.
Exit the menu after it is executed.

Note

- Setting may not be possible for pictures recorded with other cameras.
- It cannot be set with a card with less than 512 MB of memory.

DMC-FZ200

- The pictures that were taken with the [Quality] set to [RAW] cannot be set to [Upload Set].

[Title Edit]

You can add text (comments) to pictures. After text has been registered, it can be stamped in prints using [Text Stamp] (P164).

- 1 Select [Title Edit] on the [Playback] menu. (P52)
- 2 Press ▲/▼ to select [Single] or [Multi] and then press [MENU/SET].
- 3 Select the picture, and then press [MENU/SET] to set.

- [☑] is displayed for pictures with titles already registered.

[Multi] setting

Press [DISP.] to set (repeat), and then press [MENU/SET] to set.

- The setting is canceled when [DISP.] is pressed again.

4 Enter the text. (P132)

- Exit the menu after it is set.

Note

- To delete the title, erase all the text in the text input screen.
- You can print out texts (comments) using the "PHOTOfunSTUDIO" bundled software on the CD-ROM (supplied).

DMC-FZ200

- You can set up to 100 pictures at one time with [Multi].

DMC-FZ60

- You can set up to 50 pictures at one time with [Multi].

- You cannot use [Title Edit] for the following pictures.

- Motion pictures
- 3D pictures
- Pictures recorded with other equipment

DMC-FZ200

- Pictures taken with [RAW_{Hi}], [RAW_{Lo}] or [RAW]

[Single]



Press ◀/▶ to select the picture.

[Multi]

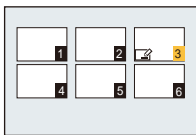

Press ▲/▼/◀/▶ to select the pictures.

[Text Stamp]

You can stamp the recording date/time, name, location, Travel Date or title onto the recorded pictures.

- 1 Select [Text Stamp] on the [Playback] menu. (P52)
- 2 Press ▲/▼ to select [Single] or [Multi] and then press [MENU/SET].
- 3 Select the picture, and then press [MENU/SET] to set.

- [☑] is displayed on pictures already with date or text stamped.

[Multi] setting

Press [DISP.] to set (repeat), and then press [MENU/SET] to set.

- The setting is canceled when [DISP.] is pressed again.

[Single]



Press ◀/▶ to select the picture.

[Multi]

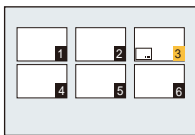

Press ▲/▼/◀/▶ to select the pictures.

- 4 Press ▲/▼ to select text stamp items, and then press ▶.
- 5 Press ▲/▼ to select the settings, and then press [MENU/SET].

Settings	Description of settings
[Shooting Date]	<p>[W/O TIME]: Stamp the year, month and day.</p> <p>[WITH TIME]: Stamp the year, month, day, hour and minutes.</p> <p>[OFF]</p>
[Name]	<p>[👤]: Stamps names registered in name settings for [Face Recog.].</p> <p>[👶/🐾]: Stamps names registered in name settings for [Baby1]/[Baby2] or [Pet] in Scene Mode.</p> <p>[OFF]</p>
[Location]	<p>[ON]: Stamps the travel destination name set under [Location].</p> <p>[OFF]</p>
[Travel Date]	<p>[ON]: Stamps the Travel Date set under [Travel Date].</p> <p>[OFF]</p>
[Title]	<p>[ON]: Stamps the title input in the [Title Edit].</p> <p>[OFF]</p>

6 Press [MENU/SET].

- Confirmation screen is displayed. It is executed when [Yes] is selected.
Exit the menu after it is executed.

Note

- When you print pictures stamped with text, the date will be printed over the stamped text if you specify printing of the date at the photo shop or on the printer.

DMC-FZ200

- You can set up to 100 pictures at one time in [Multi].

DMC-FZ60

- You can set up to 50 pictures at one time in [Multi].

- The picture quality may deteriorate when text stamping is carried out.
- Depending on the printer being used, some characters may be cut at printing. Check before printing.
- When text is stamped onto the images smaller than 0.3 M, it is difficult to read it.
- Text and dates cannot be stamped on the pictures in the following cases.
 - Motion pictures
 - Pictures taken in [Panorama Shot] in Scene Mode
 - 3D pictures
 - Pictures recorded without setting the clock and title
 - Pictures with date or text stamped
 - Pictures recorded with other equipment

DMC-FZ200

- Pictures taken with [RAW₁], [RAW₂] or [RAW]

[Video Divide]

Recorded motion picture can be divided in two. It is recommended for when you want to divide a part you need with a part you do not need.

It cannot be restored once divided.

1 Select [Video Divide] on the [Playback] menu. (P52)

2 Press ◀/▶ to select the motion picture to divide, and then press [MENU/SET].

3 Press ▲ at the location to divide.

- Motion picture is played back from the same location when ▲ is pressed again.
- You can finely adjust the location for division by pressing ◀/▶ while the motion picture is paused.



4 Press ▼.

- Confirmation screen is displayed. It is executed when [Yes] is selected. Exit the menu after it is executed.
- Motion picture may be lost if the card or battery is removed while processing the dividing.

 **Note**

- [Video Divide] may not be performed on motion pictures recorded with other equipment.
- Motion pictures cannot be divided at a location close to the start or end of the motion picture.
- With [MP4] motion pictures, the order of pictures will change if divided. It is recommended to search these motion pictures by using [Calendar] or [Video Only] in the [Filtering Play].
- Motion pictures with a short recording time cannot be divided.

[Resize]

To allow easy posting to web pages, attachment to e-mail etc., picture size (number of pixels) is reduced.

- 1** Select **[Resize]** on the **[Playback]** menu. (P52)
- 2** Press **▲/▼** to select **[Single]** or **[Multi]** and then press **[MENU/SET]**.
- 3** Select the picture and size.

[Single] setting

- 1** Press **◀/▶** to select the picture, and then press **[MENU/SET]**.
- 2** Press **◀/▶** to select the size, and then press **[MENU/SET]**.
 - Confirmation screen is displayed. It is executed when **[Yes]** is selected.
 - Exit the menu after it is executed.

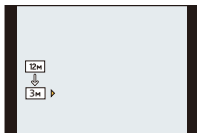
**[Multi] setting**

- 1** Press **▲/▼** to select the size, and then press **[MENU/SET]**.
- 2** Press **▲/▼/◀/▶** to select the picture, and then press **[DISP.]**.
 - Repeat this step for each picture, and press **[MENU/SET]** to set.
 - Confirmation screen is displayed. It is executed when **[Yes]** is selected.
 - Exit the menu after it is executed.

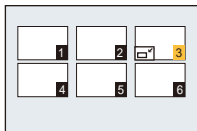
**Note****DMC-FZ200**

- You can set up to 100 pictures at one time in **[Multi]**.

DMC-FZ60

- You can set up to 50 pictures at one time in **[Multi]**.

- The picture quality of the resized picture will deteriorate.
- It may not be possible to resize pictures recorded with other equipment.
- The **[Resize]** feature is disabled during the following conditions:
 - Motion pictures
 - Pictures taken in **[Panorama Shot]** in **Scene Mode**
 - 3D pictures
 - Pictures with date or text stamped

DMC-FZ200

- Pictures taken with **[RAW₁]**, **[RAW₂]** or **[RAW]**

[Cropping]

You can enlarge and then crop the important part of the recorded picture.

- 1** Select **[Cropping]** on the **[Playback]** menu. (P52)
- 2** Press **◀/▶** to select the picture, and then press **[MENU/SET]**.
- 3** Use the zoom lever and press **▲/▼/◀/▶** to select the parts to be cropped.



Zoom lever (T): Enlargement

Zoom lever (W): Reduction

▲/▼/◀/▶: Move

- 4** Press **[MENU/SET]**.

- Confirmation screen is displayed. It is executed when **[Yes]** is selected.
Exit the menu after it is executed.

 **Note**

- The picture quality of the cropped picture will deteriorate.
- It may not be possible to crop pictures recorded with other equipment.
- Information regarding the Face Recognition in the original picture will not be copied to images having undergone **[Cropping]**.
- The **[Cropping]** feature is disabled during the following conditions:
 - Motion pictures
 - Pictures taken in **[Panorama Shot]** in Scene Mode
 - 3D pictures
 - Pictures with date or text stamped

DMC-FZ200

- Pictures taken with **[RAW₁]**, **[RAW₂]** or **[RAW]**

[Leveling]

Minute tilting of the image can be adjusted.

- 1** Select **[Leveling]** on the **[Playback]** menu. (P52)
- 2** Press **◀/▶** to select the picture, and then press **[MENU/SET]**.
- 3** Press **◀/▶** to adjust the tilting, and press **[MENU/SET]**.

▶: clockwise

◀: counter-clockwise

- Up to 2° can be adjusted.
- Confirmation screen is displayed. It is executed when **[Yes]** is selected.
Exit the menu after it is executed.

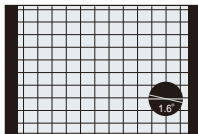

 **Note**

- Quality of image may become coarse when leveling is performed.
- Leveling may not be performed on images recorded with other equipment.
- Information regarding the Face Recognition in the original picture will not be copied to images having undergone **[Leveling]**.
- The **[Leveling]** feature is disabled during the following conditions:
 - Motion pictures
 - Pictures taken in **[Panorama Shot]** in Scene Mode
 - 3D pictures
 - Pictures with date or text stamped

DMC-FZ200

- Pictures taken with **[RAW₁]**, **[RAW₂]** or **[RAW]**

[Favorite]

You can do the following if a mark has been added to pictures and they have been set as favorites.

- Play back only the pictures set as favorites. ([Favorite] in [Filtering Play])
- Play back the pictures set as favorites only as a slide show.
- Delete all the pictures not set as favorites. ([All Delete Except Favorite])

1 Select [Favorite] on the [Playback] menu. (P52)**2 Press ▲/▼ to select [Single] or [Multi] and then press [MENU/SET].****3 Select the picture, and then press [MENU/SET].**

- The settings are canceled when [MENU/SET] is pressed again.
- Exit the menu after it is set.

[Single]

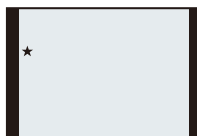

Press ◀/▶ to select the picture.

[Multi]

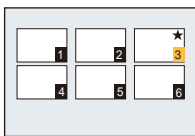

Press ▲/▼/◀/▶ to select the pictures.

■ Canceling all the [Favorite] settings**1 Select [Favorite] on the [Playback] menu.****2 Press ▲/▼ to select [Cancel] and then press [MENU/SET].**

- Confirmation screen is displayed. It is executed when [Yes] is selected.
- Exit the menu after it is executed.

Note

- You can set up to 999 pictures as favorites.
- You may not be able to set pictures taken with other equipment as favorites.

DMC-FZ200

- The [Favorite] feature is disabled during the following conditions:
 - Pictures taken with [RAW]

[Print Set]

DPOF "Digital Print Order Format" is a system that allows the user to select which pictures to print, how many copies of each picture to print and whether or not to print the recording date on the pictures when using a DPOF compatible photo printer or photo printing store. For details, ask at your photo printing store.

When you want to use a photo printing store to print pictures recorded on the built-in memory, copy them to a card (P175) and then set the print setting.

For more information visit:

http://panasonic.jp/dc/dpof_110/white_e.htm

DMC-FZ200

- When you set [Print Set] for a burst picture group, the print setting for the number of prints will be applied to every picture in the group.

- 1 Select [Print Set] on the [Playback] menu. (P52)
- 2 Press ▲/▼ to select [Single] or [Multi] and then press [MENU/SET].
- 3 Select the picture, and then press [MENU/SET].

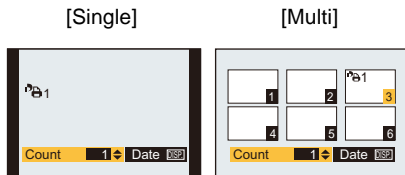

Press ◀/▶ to select the picture.

Press ▲/▼/◀/▶ to select the pictures.

- 4 Press ▲/▼ to set the number of prints, and then press [MENU/SET] to set.

- When [Multi] has been selected, repeat steps 3 and 4 for each picture.

DMC-FZ200

- [+999] is displayed on the screen, if the total number of prints you set for a burst picture group is more than 1000 pictures.
- Exit the menu after it is set.

■ Canceling all the [Print Set] settings

- 1 Select [Print Set] on the [Playback] menu.
- 2 Press ▲/▼ to select [Cancel] and then press [MENU/SET].
 - Confirmation screen is displayed. It is executed when [Yes] is selected.
 - Exit the menu after it is executed.

■ To print the date

After setting the number of prints, set/cancel printing with the recording date by pressing [DISP.].

- Depending on the photo printing store or the printer, the date may not be printed even if you set to print the date. For further information, ask at your photo printing store or refer to the operating instructions for the printer.
- The date cannot be printed on pictures with date or text stamped.

Note

- The number of prints can be set from 0 to 999.
- Depending on the printer, the date print settings of the printer may take precedence so check if this is the case.
- If the file is not based on the DCF standard, the DPOF print setting cannot be set.
- It may not be possible to use the print settings with other equipment. In this case, cancel all the settings, and reset the settings.
- The [Print Set] feature is disabled during the following conditions:
 - Motion pictures

DMC-FZ200

- Pictures taken with [RAW]

[Protect]

You can set protection for pictures you do not want to be deleted by mistake.

- 1** Select **[Protect]** on the **[Playback]** menu. (P52)
- 2** Press **▲/▼** to select **[Single]** or **[Multi]** and then press **[MENU/SET]**.
- 3** Select the picture, and then press **[MENU/SET]** to set.

- The settings are canceled when **[MENU/SET]** is pressed again.
- Exit the menu after it is set.

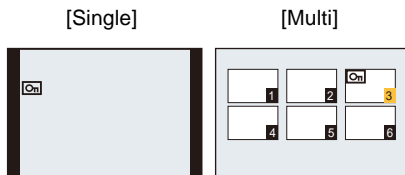

Press **◀/▶** to select the picture.

Press **▲/▼/◀/▶** to select the pictures.

■ Canceling all the **[Protect]** settings

- 1** Select **[Protect]** on the **[Playback]** menu.
- 2** Press **▲/▼** to select **[Cancel]** and then press **[MENU/SET]**.
 - Confirmation screen is displayed. It is executed when **[Yes]** is selected.
 - Exit the menu after it is executed.

Note

- The protect setting may not be effective on other equipment.
- Even if you protect pictures in the built-in memory or a card, they will be deleted if the built-in memory or the card is formatted.
- Even if you do not protect pictures on a card, they cannot be deleted when the card's Write-Protect switch is set to **[LOCK]**.

[Face Rec Edit]

You can delete or change the information relating to Face Recognition for the selected picture.

- 1** Select **[Face Rec Edit]** on the **[Playback]** menu. (P52)
- 2** Press **▲/▼** to select **[REPLACE]** or **[DELETE]** and then press **[MENU/SET]**.
- 3** Press **◀/▶** to select the picture and then press **[MENU/SET]**.
- 4** Press **◀/▶** to select the person and then press **[MENU/SET]**.
- 5** (When **[REPLACE]** is selected) Press **▲/▼/◀/▶** to select the person to replace and then press **[MENU/SET]**.

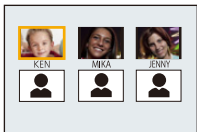



- Confirmation screen is displayed. It is executed when **[Yes]** is selected.
Exit the menu after it is executed.

 **Note**

- Deleted information regarding the **[Face Recog.]** cannot be restored.
- When all Face Recognition information in a picture has been canceled, the picture will not be categorized using Face Recognition in **[Category Selection]** in **[Filtering Play]**.
- You cannot edit the Face Recognition information of protected pictures.



[Copy]

You can copy the data of the pictures you have taken from the built-in memory to a card or from a card to the built-in memory.

- 1 Select [Copy] on the [Playback] menu. (P52)**
- 2 Press ▲/▼ to select the copy destination and then press [MENU/SET].**
 - : All the picture data in the built-in memory are copied onto the card at one time.
 - : One picture at a time is copied from the card to the built-in memory.
- 3 (When [] is selected) Press ◀/▶ to select the picture and then press [MENU/SET].**

- Confirmation screen is displayed. It is executed when [Yes] is selected.
Exit the menu after it is executed.
- Do not turn the camera off at any point during the copying process.

Note

- If a picture exists with the same name (folder number/file number) as the picture to be copied in the copy destination when [] is selected, a new folder is created and the picture is copied. If a picture exists with the same name (folder number/file number) as the picture to be copied in the copy destination when [] is selected, that picture is not copied.
- It may take time to copy the picture data.
- [Print Set], [Protect] or [Favorite] settings will not be copied. Perform the settings again after copying is finished.
- Motion picture recorded in [AVCHD] cannot be copied.

Playing Back Pictures on a TV Screen

Pictures recorded with this unit can be played back on a TV screen.

Preparations: Turn this unit and the TV off.

- **Confirm the terminals on your TV and use a cable compatible with the terminals. Image quality may vary with the connected terminals.**

- 1 High quality
- 2 HDMI socket
- 3 Video socket



1 Connect the camera and a TV.

- Check the direction of the terminals and plug in/out straight holding onto the plug. (It may result in malfunction by the deforming of the terminal if it is plugged in obliquely or in wrong direction.)

To connect with an HDMI mini cable (optional)

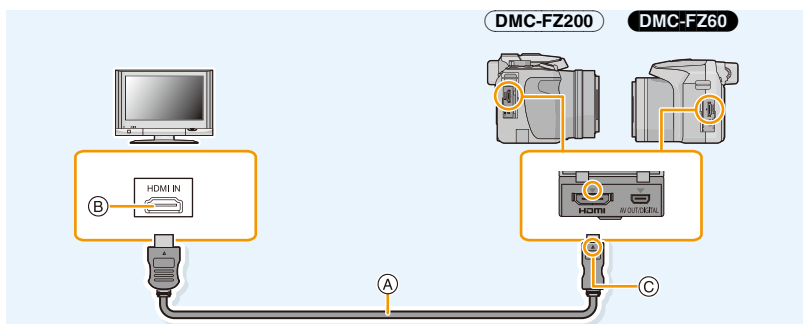

- Always use a genuine Panasonic HDMI mini cable (RP-CDHM15, RP-CDHM30: optional). Part numbers: RP-CDHM15 (1.5 m) (5 feet), RP-CDHM30 (3.0 m) (10 feet)
- Audio will be played back as stereo (2ch).
- No picture is displayed on the screen.
- For more details about VIERA Link (HDMI) playback, refer to [P178](#).

- (A) HDMI mini cable (optional)
- (B) HDMI socket
- (C) Align the marks, and insert.

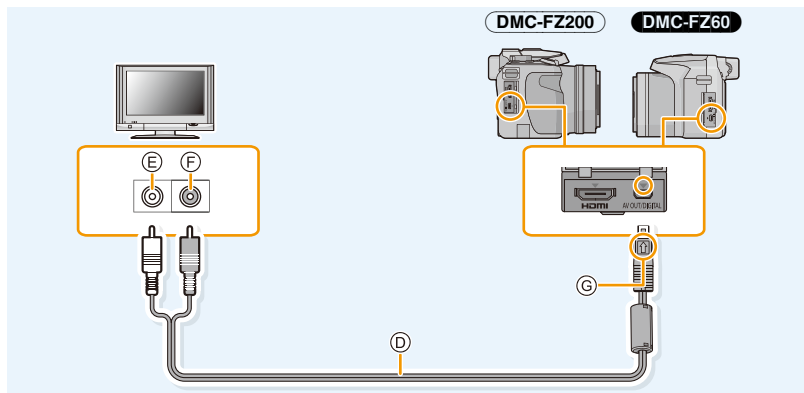
To connect with an AV cable (optional)

- Always use a genuine Panasonic AV cable (DMW-AVC1: optional).
- Check the [TV Aspect]. (P66)
- Audio will be played back in monaural.

Ⓓ AV cable (optional)

Ⓕ Yellow: to the video input socket

Ⓔ White: to the audio input socket

Ⓖ Align the marks, and insert.

2 Turn on the TV and select the input to match the terminal in use.

3 Turn the camera on and then press [▶].

- Input of the TV will switch automatically and playback screen is displayed when connected to a VIERA Link compatible TV using an HDMI mini cable with the [VIERA Link] (P66) set to [ON]. (P178)

Note

- Depending on the [Aspect Ratio], black bands may be displayed on the top and bottom or the left and right of the pictures.
- Change the screen mode on your TV if the picture is displayed with the top or bottom cut off.
- Output from the HDMI mini cable has priority when both AV cable and HDMI mini cable are connected.
- The connection with the USB connection cable will take priority when you connect the USB connection cable simultaneously with the HDMI mini cable.
- When you play back a picture vertically, it may be blurry.
- When pictures are displayed, they may not be displayed properly depending on the type of TV.
- No sound is output from the camera speakers.
- Read the operating instructions for the TV.

The recorded pictures can be played back on a TV with an SD Memory Card slot.

- Proper playback (aspect ratio) will be dependent on the TV used for viewing.
- The file format of the motion pictures that can be played back differs depending on the TV model.
- In some cases, panorama pictures cannot be played back. Also, auto-scroll playback of panorama pictures may not work.
- For cards compatible with playback, refer to the operating instructions of the TV.

Using VIERA Link (HDMI)

What is the VIERA Link (HDMI) (HDAVI Control™)?

- VIERA Link™ is a new name for EZ Sync™.
- This function allows you to use your remote control for the Panasonic TV for easy operations when this unit has been connected to a VIERA Link compatible device using a HDMI mini cable (optional) for automatic linked operations. (Not all operations are possible.)
- VIERA Link is a unique Panasonic function built on a HDMI control function using the standard HDMI CEC (Consumer Electronics Control) specification. Linked operations with HDMI CEC compatible devices made by other companies are not guaranteed. When using devices made by other companies that are compatible with VIERA Link, refer to the operating instructions for the respective devices.
- This unit is compatible with VIERA Link Ver.5. VIERA Link Ver.5 is the newest Panasonic version and is also compatible with existing Panasonic VIERA Link devices. (As of November 2011)

Preparations: Set the [VIERA Link] to [ON]. (P66)

1 Connect this unit to a Panasonic TV compatible with VIERA Link with a HDMI mini cable (optional) (P176).

2 Turn the camera on and then press [▶].

3 Operate with the remote control for the TV.

- Operate with reference to the operation icons displayed on the screen.

Note

- To play back the audio of the motion pictures, set the [Sound] in the Slide Show setting screen to [AUTO] or [Audio].
- It is recommended to connect this unit to an HDMI terminal other than the HDMI1 if there are 2 or more HDMI input terminals on the TV.
- Operation using the button on this unit will be limited.

■ Other linked operations

Turning this unit off:

If you use the remote control for the TV to turn the TV off, this unit is also turned off.

Automatic input switching:

- If you connect with an HDMI mini cable and then turn this unit on, and then press **[▶]**, the input channel on the TV automatically switches to this unit's screen. If the TV's power is in standby status, it will turn on automatically (if [Set] has been selected for the TV's [Power on link] setting).
- Depending on the HDMI terminal on the TV, the input channel may not switch automatically. In this case, use the remote control for the TV to switch the input channel. (For details on how to switch input, please read the operating instructions for the TV.)
- If VIERA Link does not work properly, refer to page 216.

Note

- If you are unsure whether or not the TV you are using are compatible with VIERA Link, read the operating instructions for the TV.
- Available linked operations between this unit and a Panasonic TV is different depending on the types of Panasonic TVs even if they are compatible with VIERA Link. Refer to the operating instructions of the TV for the operations that support on the TV.
- Operation is not possible with a cable that is not based on the HDMI standard.
- Always use a genuine Panasonic HDMI mini cable (RP-CDHM15, RP-CDHM30: optional).
Part numbers: RP-CDHM15 (1.5 m) (5 feet), RP-CDHM30 (3.0 m) (10 feet)

Playing back 3D pictures

Connecting the camera to a 3D compatible television and playing back pictures taken in 3D allows you to enjoy 3D pictures for extra impact.

It is also possible to play back the recorded 3D pictures by inserting an SD card into the 3D compatible television with an SD card slot.

For current information regarding devices that can play back 3D pictures recorded with this unit, please refer to the below support site.

<http://panasonic.jp/support/global/cs/dsc/> (This Site is English only.)

Preparations: Set the [3D Playback] to [**3D**]. (P66)

Connect the unit to a 3D compatible television using the HDMI mini cable and display the playback screen. (P176)

- When [VIERA Link] (P66) is set to [ON] and the camera is connected to a TV supporting VIERA Link, input of the TV will be switched automatically and playback screen will be displayed. Refer to P178 for details.
- For the pictures recorded in 3D, [3D] will appear on the thumbnail display at playback.

■ Play back as a 3D slide show by selecting only the still pictures recorded in 3D

Select [3D Play] in [Slide Show] in the Playback Mode. (P156)

■ Play back in 3D by selecting only the still pictures recorded in 3D

Select [3D Play] in [Filtering Play] in the Playback Mode. (P159)

■ Switch the playback method for the still pictures recorded in 3D

1 Select the picture recorded in 3D.

2 Select [2D/3D Settings] on the [Playback] menu and then press [MENU/SET]. (P52)

- Playback method will switch to 3D if it is playing back in 2D (conventional image).
- If you feel tired, uncomfortable or otherwise strange when playing back pictures recorded in 3D, set to 2D.

 **Note**

- When the picture is not appropriate to view in 3D (disparity is too large, etc.)
 - [Slide Show]:
The picture will be played back in 2D.
 - [Filtering Play]:
Confirmation screen is displayed. Select whether or not to play back the picture in 3D.
- 2 pictures may be displayed side by side when a 3D picture is played back on a TV that is not 3D compatible.
- When a picture recorded in 3D is displayed on the screen of this unit, it is played back in 2D (conventional image).
- A black screen is displayed for a few seconds when switching back and forth playback of 3D pictures and 2D pictures.
- When you select a 3D picture thumbnail, it may take a few seconds for playback to start. After playback, the thumbnail display may take a few seconds to reappear.
- When viewing 3D pictures, your eyes may become tired if you are too close to the television screen.
- If your television does not switch to a 3D picture, make the necessary settings on the TV. (For details, refer to the operating instructions of the TV.)
- The following functions cannot be used during the 3D playback.
 - [Setup] menu
 - [Playback] menu
 - Playback Zoom
 - Deleting pictures
- 3D pictures can be saved to your computer or Panasonic devices. (P182, 186)

Saving still pictures and motion pictures on your PC

You can acquire recorded pictures to a PC by connecting the camera and the PC.

- Some PCs can read directly from the card removed from the camera. For details, refer to the operating instructions of your PC.
- **If the computer being used does not support SDXC Memory Cards, a message prompting you to format may appear. (Doing so will cause recorded images to be erased so do not choose to format.)**

If the card is not recognized, please refer to the below support site.

<http://panasonic.net/avc/sdcard/information/SDXC.html>

■ PC that can be used

The unit can be connected to any PC capable of recognizing a mass storage device.

- Windows support: Windows 7/Windows Vista/Windows XP
- Mac support: OS X v10.1 ~ v10.7

AVCHD motion pictures may not be imported correctly when copied as files or folder.

- With Windows, always import AVCHD motion pictures using "PHOTOfunSTUDIO", one of the programs on the CD-ROM (supplied).

(Read the "Basic Owner's Manual" for more information about the "PHOTOfunSTUDIO")

- With a Mac, AVCHD motion pictures can be imported using "iMovie'11".

Note that motion pictures (AVCHD Progressive) recorded in [PSH] cannot be imported.

(For details about iMovie'11, please contact Apple Inc.)

Preparations: Install "PHOTOfunSTUDIO" to the PC.

- Read the "Basic Owner's Manual" for more information about install.

The software "PHOTOfunSTUDIO" on the CD-ROM (supplied) can be used to save all the still pictures and motion pictures recorded by the camera in their various formats to your computer.



1 Connect the camera to a PC via the USB connection cable (A) (supplied).

- Please turn this unit on and your PC before connecting.
- Do not use any other USB connection cables except the supplied one or a genuine Panasonic USB connection cable (DMW-USBC1: optional).
- Check the directions of the connectors, and plug them straight in or unplug them straight out. (Otherwise the connectors may be bent out of shape which may cause malfunction.)

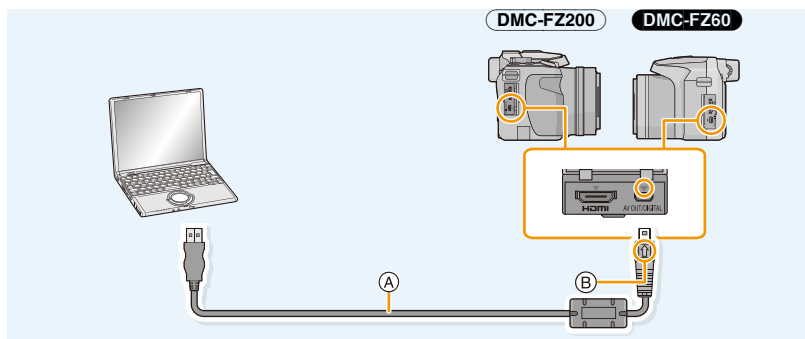

(A) USB connection cable (supplied)

(B) Align the marks, and insert.

2 Press ▲/▼ to select [PC], and then press [MENU/SET].

- If [USB Mode] (P65) is set to [PC] in the [Setup] menu in advance, the camera will be automatically connected to the PC without displaying the [USB Mode] selection screen.
- When the camera has been connected to the PC with [USB Mode] set to [PictBridge(PTP)], a message may appear on the PC's screen. Close the screen by selecting [Cancel], safely remove the USB connection cable (P185), and set the [USB Mode] to [PC].

3 Copy the images to a PC using "PHOTOfunSTUDIO".

- Do not delete or move copied files or folders in Windows Explorer. When viewing in "PHOTOfunSTUDIO", you will not be able to play back or edit.

Note

- “PHOTOfunSTUDIO” is not compatible with Mac.
- Use a battery with sufficient battery power or the AC adaptor (optional). If the remaining battery power becomes low while the camera and the PC are communicating, the status indicator blinks and the alarm beeps.

Refer to “Disconnecting the USB connection cable safely” (P185) before disconnecting the USB connection cable. Otherwise, data may be destroyed.

- Before connecting or disconnecting the AC adaptor (optional), turn the camera off.
- Before inserting or removing a card, turn the camera off and disconnect the USB connection cable. Otherwise, data may be destroyed.

■ Copying to a PC without using “PHOTOfunSTUDIO”

If you are not able to install “PHOTOfunSTUDIO”, you can copy files and folders to your PC by dragging and dropping files from this unit.

Directory structure of built-in memory/card of this unit

For Windows: A drive ([Removable Disk]) is displayed in [Computer]

For Mac: A drive ([LUMIX], [NO_NAME] or [Untitled]) is displayed on the desktop

- Built-in Memory
- Card

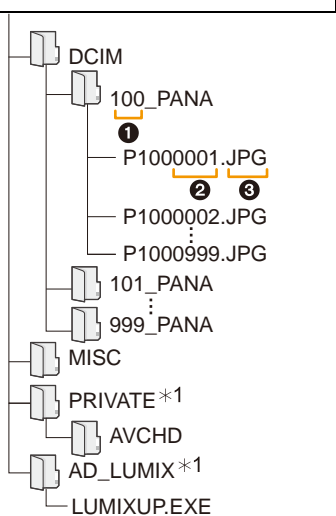

DCIM: Images

❶ Folder number

❷ File number

❸ JPG: Still pictures

MP4: [MP4] Motion pictures

RW2*2: Pictures in RAW files

MPO: 3D pictures

MISC: DPOF print

Favorite

AVCHD: [AVCHD] Motion pictures

AD_LUMIX: For Upload set

LUMIXUP.EXE: Upload tool

“LUMIX Image Uploader”

*1 Cannot be created in the built-in memory.

*2 **DMC-FZ200**

- AVCHD motion pictures may not be imported correctly when copied as files or folder. We recommend using “PHOTOfunSTUDIO” on the CD-ROM (supplied) for importing files. Refer to P182 for details.

- A new folder is created when pictures are taken in the following situations.

- After [No.Reset] (P64) in the [Setup] menu has been executed
- When a card containing a folder with the same folder number has been inserted (such as when pictures were taken using another maker of camera)
- When there is a picture with file number 999 inside the folder

■ Disconnecting the USB connection cable safely

Select the  icon in task tray displayed on the PC, and then click [Eject DMC-XXX] (XXX varies by model).

- Depending on your PC's settings, this icon may not be displayed.
- If the icon is not displayed, check that [Access] is not displayed on the LCD monitor of the digital camera before removing the hardware.

■ Connection in the PTP Mode

Set [USB Mode] to [PictBridge(PTP)].

- Data can now be read only from this unit into the PC.
- When there are 1000 or more pictures on a card, the pictures may not be imported in the PTP Mode.
- Motion picture cannot be played back in PTP Mode.

Uploading the images to sharing sites

Still pictures and motion pictures can be uploaded to image sharing sites (Facebook/YouTube) using the upload tool "LUMIX Image Uploader".

You do not need to transfer the images to the PC or install dedicated software onto the PC, so you can easily upload the images even away from your home or work if there is a PC that is connected to the network.

- It is only compatible with a PC with Windows XP/Windows Vista/Windows 7.
- For details, refer to the operating instructions of "LUMIX Image Uploader" (PDF).

Preparations:

Set up the images to upload with [Upload Set] (P161).

Connect the PC to the Internet.

Create an account at the image sharing site to be used, and prepare the login information.

1 Startup the "LUMIXUP.EXE" by double-clicking it. (P184)

- An upload tool "LUMIX Image Uploader" may startup automatically if the "PHOTOfunSTUDIO" software on the CD-ROM (supplied) is installed.

2 Select the destination to upload.

- Operate following the instructions displayed on the PC screen.

Note

- Operation cannot be guaranteed for future specification changes of the YouTube and Facebook services. Service contents or screen may be modified without notice.
(This service is as of June 1st, 2012)
- Do not upload any images protected by copyright, unless you own the copyright yourself, or have permission from the relevant copyright holder.
- **Images may contain personal information that can be used to identify the user, such as a title, the time and date when the images were taken, and the location where the image was taken if the camera includes a GPS function. Check this information before uploading images to image sharing sites.**

Saving still pictures and motion pictures on a Recorder

If you insert a card holding content recorded with this unit into a Panasonic recorder, you can dub the content to a Blu-ray Disc or DVD etc.

For details on Panasonic devices compatible with the respective file format (such as a Blu-ray Disc recorder), refer to the support sites below.

For details on compatible devices, refer to the support sites below.

<http://panasonic.jp/support/global/cs/dsc/>

(This Site is English only.)

* Some compatible devices may not be sold in certain countries and regions.

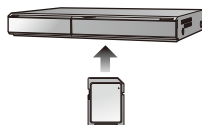

- See the operating instruction for the recorder about the details of copying and playing back.
- **Note that the equipment described may not be available in certain countries and regions.**

■ Dubbing with non-compatible equipment

You can dub the content played back using this unit to non-compatible equipment such as recorders and video players by connecting this unit to the non-compatible equipment using an AV cable (optional). Non-compatible equipment will be able to play back the content. This is convenient if you wish to pass around dubbed content. In this case, the content will be played back in standard rather than high-definition picture quality.

1 Connect this unit with the recording equipment with an AV cable (optional).

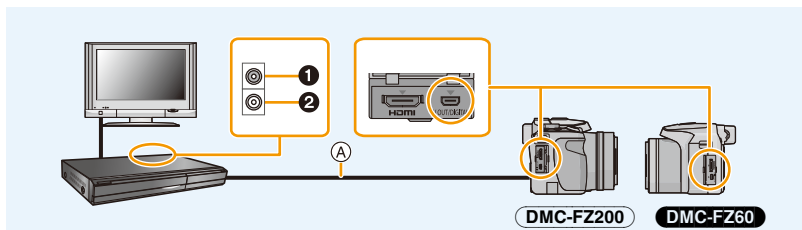

- ① Yellow: to the video input socket
- ② White: to the audio input socket
- Ⓐ AV cable (optional)

2 Start the playback of this unit.

3 Start the recording on the recording equipment.

- When ending the recording (copying), stop the playback on this unit after stopping the recording in recording equipment.

Note

- When you play back motion pictures on 4:3 aspect ratio TV, you must set [TV Aspect] (P66) on this unit to [4:3] before starting a copy. The image will be vertically long if you play back motion pictures copied with [16:9] setting on a [4:3] aspect TV.
- See the operating instructions for the recording equipment about the details of copying and playing back.

Printing the Pictures

If you connect the camera to a printer supporting PictBridge, you can select the pictures to be printed out and instruct that printing be started on the camera's LCD monitor.

DMC-FZ200

- Burst pictures will be displayed as a list, and not as a group.

- Some printers can print directly from the card removed from the camera. For details, refer to the operating instructions of your printer.

Preparations:

Turn on the camera and the printer.

Remove the card before printing the pictures in the built-in memory.

Perform the print quality and other settings at the printer before printing the pictures.

1 Connect the printer and camera with the USB connection cable (supplied).

- Check the directions of the connectors, and plug them straight in or unplug them straight out. (Otherwise the connectors may be bent out of shape which may cause malfunction.)
- Do not use any other USB connection cables except the supplied one or a genuine Panasonic USB connection cable (DMW-USBC1: optional).

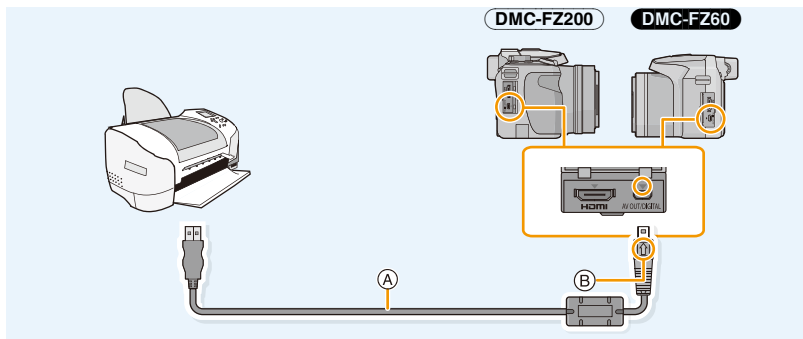

- (A) USB connection cable (supplied)
- (B) Align the marks, and insert.

2 Press ▲/▼ to select [PictBridge(PTP)], and then press [MENU/SET].

 **Note**

- Use a battery with sufficient battery power or the AC adaptor (optional). If the remaining battery power becomes low while the camera and the printer are connected, the status indicator blinks and the alarm beeps. If this happens during printing, stop printing at once. If not printing, disconnect the USB connection cable.
- Do not disconnect the USB connection cable while  (Cable disconnect prohibit icon) is displayed. (may not be displayed depending on the type of printer used)
- Before connecting or disconnecting the AC adaptor (optional), turn the camera off.
- Before inserting or removing a card, turn the camera off, and disconnect the USB connection cable.
- Motion pictures recorded cannot be printed out.

Selecting a single picture and printing it

- 1 Press **◀/▶** to select the picture and then press **[MENU/SET]**.



- 2 Press **▲** to select **[Print start]** and then press **[MENU/SET]**.

- Refer to **P191** for the items which can be set before starting to print the pictures.
- Disconnect the USB connection cable after printing.

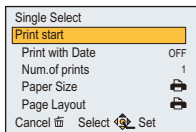

Selecting multiple pictures and printing them

- 1 Press **▲**.

- 2 Press **▲/▼** to select an item and then press **[MENU/SET]**.

Item	Description of settings
[Multi Select]	Multiple pictures are printed at one time. <ul style="list-style-type: none"> • Press ▲/▼/◀/▶ to select the pictures, and then press [DISP.]. (When [DISP.] is pressed again, the setting is canceled.) • After the pictures have been selected, press [MENU/SET].
[Select All]	Prints all the stored pictures.
[Print Set (DPOF)]	Prints the pictures set in [Print Set] only. (P171)
[Favorite]	Prints the pictures set as favorites only. (P170)

- 3 Press **▲** to select **[Print start]** and then press **[MENU/SET]**.

- If the print check screen has appeared, select **[Yes]**, and print the pictures.
- Refer to **P191** for the items which can be set before starting to print the pictures.
- Disconnect the USB connection cable after printing.

Print Settings

Select and set the items both on the screen in step 2 of the “Selecting a single picture and printing it” and in step 3 of the “Selecting multiple pictures and printing them” procedures.

- When you want to print pictures in a paper size or a layout which is not supported by the camera, set [Paper Size] or [Page Layout] to  and then set the paper size or the layout on the printer. (For details, refer to the operating instructions of the printer.)
- When [Print Set (DPOF)] has been selected, the [Print with Date] and [Num.of prints] items are not displayed.

[Print with Date]

Item	Description of settings
[ON]	Date is printed.
[OFF]	Date is not printed.

- If the printer does not support date printing, the date cannot be printed on the picture.
- Depending on the printer, the date print settings of the printer may take precedence so check if this is the case.
- When printing images with [Date Stamp] or [Text Stamp], please remember to set [Print with Date] to [OFF] or the date will print on top.

Note

When asking the photo shop to print the pictures

- By stamping the date using [Date Stamp] (P147) or [Text Stamp] (P164) or setting date printing at the time of the [Print Set] (P171) setting before going to a photo shop, the dates can be printed at the photo shop.

[Num.of prints]





You can set the number of prints up to 999.

[Paper Size]

Item	Description of settings
	Settings on the printer are prioritized.
[L/3.5"×5"]	89 mm×127 mm
[2L/5"×7"]	127 mm×178 mm
[POSTCARD]	100 mm×148 mm
[16:9]	101.6 mm×180.6 mm
[A4]	210 mm×297 mm
[A3]	297 mm×420 mm
[10×15cm]	100 mm×150 mm
[4"×6"]	101.6 mm×152.4 mm
[8"×10"]	203.2 mm×254 mm
[LETTER]	216 mm×279.4 mm
[CARD SIZE]	54 mm×85.6 mm

- Paper sizes not supported by the printer will not be displayed.

[Page Layout] (Layouts for printing that can be set with this unit)

Item	Description of settings
	Settings on the printer are prioritized.
	1 picture with no frame on 1 page
	1 picture with a frame on 1 page
	2 pictures on 1 page
	4 pictures on 1 page

- An item cannot be selected if the printer does not support the page layout.

■ Layout printing**When printing a picture several times on 1 sheet of paper**

For example, if you want to print the same picture 4 times on 1 sheet of paper, set [Page Layout] to  and then set [Num.of prints] to 4 for the picture that you want to print.

When printing different pictures on 1 sheet of paper

For example, if you want to print 4 different pictures on 1 sheet of paper, set [Page Layout] to  and then set [Num.of prints] to 1 for each of the 4 pictures.

Note

- The camera is receiving an error message from the printer when the  indication lights orange during printing. After finishing printing, make sure there are no problems with the printer.
- If the number of prints is high, the pictures may be printed several times. In this case, the remaining number of prints indicated may differ from the number set.

DMC-FZ200

- When the pictures in RAW files are to be printed, the JPEG pictures recorded simultaneously by the camera will be printed. If JPEG pictures do not exit, RAW file pictures cannot be printed.

Optional accessories

Conversion Lens (optional)

With the optional conversion lenses, you can record even more faraway pictures and take close-up pictures of smaller subjects.

Preparations: Remove the lens cap and lens hood.

1 Attach the lens adaptor.

- Rotate the lens adaptor slowly and carefully.

2 Attach the tele conversion lens.

(A) Lens adaptor (optional)

DMC-FZ200 : DMW-LA7

DMC-FZ60 : DMW-LA5

(B) Tele conversion lens (DMW-LT55: optional)

- Close-up lens (DMW-LC55: optional) can be attached in a similar manner.

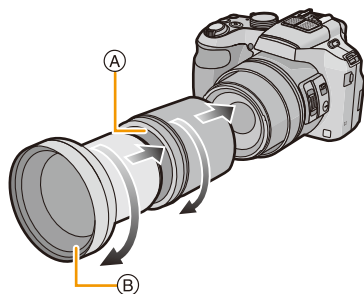

		Tele conversion lens	Close-up lens
Zoom magnification (Max. number of pixels)		DMC-FZ200 14× to 24×* DMC-FZ60 12× to 24×*	4× to 24×
Recordable range	Wide	5.5 m (18 feet) to ∞	DMC-FZ200 27 cm (0.89 feet) to 50 cm (1.6 feet) DMC-FZ60 18 cm (0.59 feet) to 50 cm (1.6 feet)
	Tele	5.5 m (18 feet) to ∞	33 cm (1.08 feet) to 50 cm (1.6 feet)
Maximum aperture	Wide	F4.0	DMC-FZ200 F4.0 DMC-FZ60 F3.6
	Tele		DMC-FZ200 F4.0 DMC-FZ60 F5.2

* The actual magnification when the zoom is used will be 1.7 times the display.

3 Select [Conversion] on the [Rec] menu. (P52)

- Refer to P145 for [Conversion].

4 Press ▲/▼ to select [0], and then press [MENU/SET] to set.

- Set in same way to select [0] too.
- Always set to [OFF] when the conversion lens is taken off.

 **Note**

- **Lens adaptor (optional) is needed to use the conversion lens.**

DMC-FZ200 : DMW-LA7

DMC-FZ60 : DMW-LA5

- MC protector (DMW-LMC52: optional) or ND filters (DMW-LND52: optional) cannot be used together with the conversion lens. Remove them before attaching the conversion lens.
- **Do not use with anything other than DMW-LC55 or DMW-LT55.**
- When there is dirt (water, oil, and fingerprints, etc.) on the surface of the lens, the image may be affected. Lightly wipe the surface of the lens with a soft, dry cloth before and after taking pictures.
- When using the tele conversion lens:
 - We recommend using a tripod.
 - The Stabilizer function may not work sufficiently.
 - The focus indication may light due to the jitter even if the subject is not focused.
 - The time required for focusing may become longer than usual.

Protector/Filter (optional)

The MC protector (DMW-LMC52: optional) is a transparent filter which affects neither the colors nor the amount of light, so it can always be used to protect the camera's lens.

The ND filter (DMW-LND52: optional) reduces the amount of light to approximately 1/8th (equal to adjusting the aperture value 3 increments) without affecting the color balance.

PL filter (DMW-LPL52: optional) will suppress the reflected light from a metal or non spherical surfaces (flat non-metallic surfaces, water vapour or invisible particles in the air), making it possible to take a picture with enhanced contrast.

 **Note**

- Do not attach multiple filters at the same time.
- If the filter is tightened too much, you may not be able to remove it. Do not tighten it too much.
- If the filter is dropped, it may be destroyed. Be careful not to drop it when attaching it to the camera.
- Be careful not to get a fingerprint, dirt, etc., on the filter when it is attached, otherwise the focus may be adjusted to the lens, resulting in the subject being out of focus.
- Refer to the operating instructions for each filter for details.

External Flash (optional) (DMC-FZ200)

After attaching the external flash (DMW-FL220, DMW-FL360, DMW-FL500: optional), the effective range will be increased when compared to the camera's built-in flash.

Preparations:

Turn off the camera and close the built-in flash.

■ Using the dedicated flash (DMW-FL220: optional)

- 1 Attach the dedicated flash to the hot shoe and then turn on the camera and the dedicated flash.**
 - Be sure to firmly secure to the dedicated flash with the lock ring.
- 2 Select [Flash] on the [Rec] menu. (P52)**
- 3 Press ▲/▼ to select the mode and then press [MENU/SET].**
 - While the external flash is connected, [⊙] is displayed on the screen.
- 4 Press [MENU/SET] to close the menu.**

■ When using other commercially available external flashes without communication functions with the camera

- It is necessary to set the exposure on the external flash. If you want to use the external flash in Auto Mode, use an external flash that allows you to set the aperture value and the ISO sensitivity to match the settings on the camera.
- Set to Aperture-Priority AE Mode or Manual Exposure Mode on the camera and then set the same aperture value and ISO sensitivity on the external flash. (The exposure cannot be compensated adequately due to the change on the aperture value in Shutter-Priority AE Mode and the external flash cannot control the light adequately in Program AE Mode because the aperture value cannot be fixed.)

 **Note**

- You can set the aperture value, the shutter speed and the ISO sensitivity on the camera even when attaching the external flash.
- Some commercial external flashes have synchro terminals with high-voltage or reversed polarity. Using such extra flashes may cause a malfunction or the camera may not operate normally.
- If you use commercially available external flashes with communication functions other than the dedicated one, they may not operate normally or they may be damaged. Do not use them.
- Even if the external flash is turned off, the camera may enter the External Flash Mode when the external flash is attached. When you are not using the external flash, detach it.
- When attaching the external flash, the built-in flash cannot be activated.
- Do not open the built-in flash when an external flash is attached.
- The camera will become unstable when attaching the external flash, it is recommended to use a tripod when taking picture.
- Turn off the camera when removing the external flash.
- Detach the external flash when carrying the camera.
- When attaching the external flash, do not hold only the external flash because it may detach from the camera.
- If you use the external flash when the White Balance is set to [] finely adjust the White Balance depending on the picture quality. (P90)
- If you take pictures close to the subject in Wide, the vignetting effect may appear on the bottom of the recorded picture.
- The external flash cannot be used while the stereo microphone (DMW-MS1: optional) is in use.
- Read the operating instructions of the external flash for details.

Remote Shutter (optional) (DMC-FZ200)

If you use the remote shutter (DMW-RSL1: optional), you can avoid jitter (camera shake) when using a tripod and you can keep the shutter pressed fully when taking pictures with Burst Mode. The remote shutter works similar to the shutter button on the camera.

Note

- Always use a genuine Panasonic remote shutter (DMW-RSL1: optional).
- You cannot operate the camera with the remote shutter in the following cases.
 - When the Sleep Mode is canceled
 - When starting/ending the recording of motion pictures
- Record with Creative Video Mode when using for motion picture recording.
- The remote shutter cannot be used while the stereo microphone (DMW-MS1: optional) is in use.
- Read the operating instructions of the remote shutter for details.

External Microphone (optional) (DMC-FZ200)

If you use the stereo microphone (DMW-MS1: optional), you can switch to either stereo or monaural sound recording.

It is also possible to reduce the wind noise efficiently by switching the [WIND CUT OFF/ON] switch to [ON].

Battery Check Lamp [BATTERY]

- When the Off/On Mode Selector Switch is changed from [OFF] to [MONO] or [STEREO], the Battery Check Lamp [BATTERY] will light temporarily if there is still plenty of power in the battery. If the Battery Check Lamp [BATTERY] does not light temporarily, replace the battery with a new one.

Note

- While the external microphone is connected, [🔊] is displayed on the screen.
- When attaching the stereo microphone, do not hold only the stereo microphone because it may detach from the camera.
- Set the wind noise reduction only on the stereo microphone side. You cannot use [Wind Cut] in this unit.
- Do not open the built-in flash when the stereo microphone is attached.
- The stereo microphone cannot be used while the external flash (optional) is in use.
- The stereo microphone cannot be used while the remote shutter (DMW-RSL1: optional) is in use.
- When a stereo microphone other than the dedicated stereo microphone is used, it will not only malfunction, but may also cause damage, so do not use it.
- Read the operating instructions of the stereo microphone for details.

AC adaptor (optional)/DC coupler (optional)

The AC adaptor (optional) can only be used with the designated Panasonic DC coupler (optional). The AC adaptor (optional) cannot be used by itself.

Preparations:

Turn this unit off and confirm that the lens barrel is retracted.

- (A) Card/battery door
- (B) DC coupler
- (C) DC coupler cover
- (D) AC adaptor
- (E) AC cable

- 1 Pull open the card/battery door and the DC coupler cover.**
- 2 Insert the DC coupler into this unit.**
 - Insert by pushing the center of the DC coupler.
 - Press on the DC coupler until it is locked by lever ①.
- 3 Pull out the cable through the opening as shown in the illustration and then close the card/battery door.**
 - Be careful not to catch the cable when closing the card/battery door.
- 4 Plug the AC adaptor into an electrical outlet.**
- 5 Connect the AC adaptor to the [DC IN] socket of the DC coupler.**

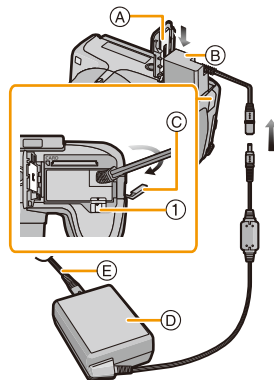

Note

- Always use a genuine Panasonic AC adaptor (optional).
- When using an AC adaptor, use the AC cable supplied with the AC adaptor.
- If the AC adaptor and DC coupler are not necessary, then remove them from the digital camera. Also, please keep the DC coupler cover closed.
- Also read the operating instructions for the AC adaptor and DC coupler.

Screen Display

In recording

- 1 Custom Settings (P127)
- 2 Photo Style (P133)
Color Mode (P38)
☞ : Creative control adjustment display (P117)
- 3 Zoom Microphone (P151)
- 4 Flash Mode (P75)
Flash output adjustment (P145)
- 5 Recording Mode (for recording motion pictures)
(P148)
Recording quality (P149)
- 6 Picture Size (P135)
- 7 Stabilizer Off (P143)
Ⓜ : Jitter Alert (P29)
- 8 Quality (P137)
- 9 AF Macro Mode (P97)

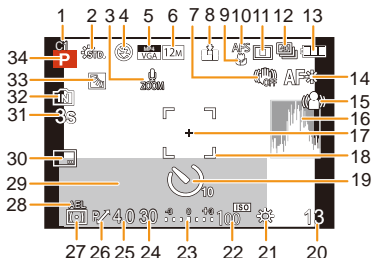

DMC-FZ60

☞ : Macro Zoom Mode (P97)

- 10 AF Style (P139)
MF : MF (P99)
AFL : AF lock (P102)
- 11 AF Mode (P92)
- 12 Burst (P80)
☞ : Auto Bracket (P146)
- 13 Battery Indication (P19)
- 14 AF Assist Lamp (P144)
Focus (P33)
- 15 Motion Deblur (P38)
- 16 Histogram (P60)
- 17 Spot Metering Target (P140)
- 18 AF area (P33)
- 19 Self-timer Mode (P84)
- 20 Number of Recordable Pictures (P25)
Available recording time (P26): R8m30s*
- 21 White Balance (P88)
White Balance Fine Adjustment (P90)
BKT : White Balance Bracket (P91)
- 22 ISO Sensitivity (P86)
ISO Limit Set (P138)
- 23 Exposure compensation value (P79)/Manual Exposure Assistance (P106)
Zoom (P71): EZ i.ZOOM W [] T 1X
- 24 Shutter speed (P31)
☞ : Minimum Shutter Speed (P141)

- 25 Aperture value (P31)
- 26 Program Shift (P32)
- 27 Metering Mode (P140)
- 28 AE lock (P102)
- 29 Current date and time/✈: World Time (P55)
 - Number of days that have passed since the departure date (P56)
 - Location (P56)
 - Name (P114)
 - Age (P114)
 - Exposure meter (P61)
- 30 Date Stamp (P147)
- 31 Elapsed Recording Time (P41): 8m30s*
- 32 Built-in Memory (P23)
 -  Card (P23) (displayed only during recording)
- 33 Backlight Compensation (P37)
- 34 Recording Mode (P30)

* "h" is an abbreviation for hour, "m" for minute and "s" for second.

■ In playback

- 1 Playback Mode (P156)
- 2 Protected Picture (P173)
- 3 Favorites (P170)
- 4 Date/Text stamped display (P147, 164)
- 5 Photo Style (P133)
Color Mode (P38)
- 6 After Auto Retouch (P152)
After Creative Retouch (P153)
- 7 Picture Size (P135)
- 8 Quality (P137)
- 9 Battery Indication (P19)
- 10 Built-in Memory (P23)
Elapsed playback time (P47): 8m30s*
- 11 Picture Number/Total Pictures
- 12 Folder/File Number (P184)
- 13 Histogram (P60)

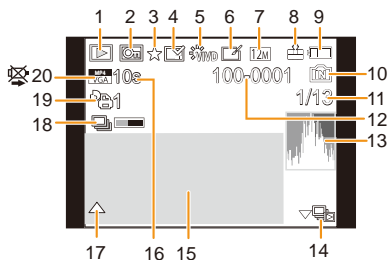

DMC-FZ200

- 14 Burst Picture Group Display (P154)

- 15 Location (P56)

Recording information (P70)

Name (P114)

Age (P114)

Title (P163)

Number of days that have passed since the departure date (P56)

Recorded date and time

✈: World Time (P55)

- 16 Motion picture recording time (P47): 8m30s*

DMC-FZ200

Number of pictures in burst (P154)

- 17 Auto Retouch (P152)

Creative Retouch (P153)

Motion picture playback (P47)

Play panorama (P110)

DMC-FZ200

Continuously Burst Picture Group Playback (P154)

- 18 DMC-FZ200

Currently retrieving information icon (P209)

- 19 Number of Prints (P171)

- 20 Recording Quality (P149)

DMC-FZ200

⚡: High Speed Motion Picture Playback (P125)

📁: Burst Picture Group icon (P154)

Cable disconnection warning icon (P189)

* "h" is an abbreviation for hour, "m" for minute and "s" for second.

Cautions for Use

Optimal use of the camera

Keep this unit as far away as possible from electromagnetic equipment (such as microwave ovens, TVs, video games etc.).

- If you use this unit on top of or near a TV, the pictures and/or sound on this unit may be disrupted by electromagnetic wave radiation.
- Do not use this unit near cell phones because doing so may result in noise adversely affecting the pictures and/or sound.
- Recorded data may be damaged, or pictures may be distorted, by strong magnetic fields created by speakers or large motors.
- Electromagnetic wave radiation generated by microprocessors may adversely affect this unit, disturbing the pictures and/or sound.
- If this unit is adversely affected by electromagnetic equipment and stops functioning properly, turn this unit off and remove the battery or disconnect AC adaptor (optional). Then reinsert the battery or reconnect AC adaptor and turn this unit on.

Do not use this unit near radio transmitters or high-voltage lines.

- If you record near radio transmitters or high-voltage lines, the recorded pictures and/or sound may be adversely affected.

Always use the supplied cords and cables. If you use optional accessories, use the cords and the cables supplied with them.

Do not extend the cords or the cables.

Do not spray the camera with insecticides or volatile chemicals.

- If the camera is sprayed with such chemicals, the body of the camera may be damaged and the surface finish may peel off.
- Do not keep rubber or plastic products in contact with the camera for a long period of time.

Cleaning

Before cleaning the camera, remove the battery or the DC coupler (optional), or disconnect the power plug from the outlet. Then wipe the camera with a dry, soft cloth.

- When the camera is soiled badly, it can be cleaned by wiping the dirt off with a wrung wet cloth, and then with a dry cloth.
- Do not use solvents such as benzine, thinner, alcohol, kitchen detergents, etc., to clean the camera, since it may deteriorate the external case or the coating may peel off.
- When using a chemical cloth, be sure to follow the accompanying instructions.

About the LCD monitor/Viewfinder

- Do not press the LCD monitor with excessive force. Uneven colors may appear on the LCD monitor and it may malfunction.
- If the camera is cold when you turn it on, the picture on the LCD monitor/Viewfinder will be slightly darker than usual at first. However, the picture will return to normal brightness when the internal temperature of the camera increases.

Extremely high precision technology is employed to produce the LCD monitor/Viewfinder screen. However there may be some dark or bright spots (red, blue or green) on the screen. This is not a malfunction. The LCD monitor/Viewfinder screen has more than 99.99% effective pixels with a mere 0.01% of the pixels inactive or always lit. The spots will not be recorded on pictures on the built-in memory or a card.

About the Lens

- Do not press the lens with excessive force.
- Do not leave the camera with the lens facing the sun as rays of light from the sun may cause it to malfunction. Also, be careful when placing the camera outside or near a window.
- When there is dirt (water, oil, and fingerprints, etc.) on the surface of the lens, the picture may be affected. Lightly wipe the surface of the lens with a soft, dry cloth before and after taking pictures.
- Retract the lens when carrying the camera.

Battery

The battery is a rechargeable lithium ion battery. Its ability to generate power comes from the chemical reaction that takes place inside it. This reaction is susceptible to the surrounding temperature and humidity. If the temperature is too high or too low, the operating time of the battery will become shorter.

Always remove the battery after use.

- Place the removed battery in a plastic bag, and store or carry away from metallic objects (clips, etc.).

If you drop the battery accidentally, check to see if the body of the battery and the terminals are damaged.

- Inserting a damaged battery in the camera will damage the camera.

Bring charged spare batteries when going out.

- Be aware that the operating time of the battery becomes shorter in low temperature conditions such as at a ski resort.
- When you travel, do not forget to bring the battery charger (supplied) so that you can charge the battery in the country that you are traveling in.

Dispose of unusable battery.

- The battery has a limited life.
- Do not throw the battery into fire because it may cause an explosion.
- The unusable battery should be discarded in accordance with battery recycling laws. Call the RBRC hotline at 1-800-822-8837 for information.

Do not allow battery terminals to come into contact with metal objects (such as necklaces, hairpins etc.).

- This can cause short circuiting or heat generation and you may be badly burned if you touch a battery.

Charger

- The [CHARGE] indicator may blink under the influence of static electricity or electromagnetic wave. This phenomenon have no effects on charging.
- If you use the battery charger near a radio, the radio reception may be disturbed.
- Keep the charger 1 m (3.3 feet) or more away from radios.
- The charger may generate whirring sounds when it is being used. This is not a malfunction.
- After use, be sure to disconnect the power supply device from the electrical outlet. (A very small amount of current is consumed if it is left connected.)
- Keep the terminals of the charger and battery clean.

About 3D

■ About 3D viewing

Anyone who is hyper sensitive to light, suffers from heart disease or is otherwise unwell should avoid viewing 3D contents.

- Viewing 3D contents may have an adverse effect to the individual.

If you feel tired, uncomfortable or otherwise strange when viewing 3D contents, stop viewing at once.

- Continuing to view may cause illness.
- After stopping viewing, please rest appropriately.

When viewing 3D contents, we recommend taking a break every 30 to 60 minutes.

- Viewing for extended periods may cause eye-fatigue.

Short-sighted or long-sighted persons, those with differences in the sight of their right and left eyes, and those with astigmatism are advised to correct their vision by wearing glasses etc.

Stop viewing if you can clearly see a double image while viewing 3D contents.

- There are differences in the way that different people experience 3D contents. Please correct your sight appropriately before viewing 3D contents.
- You can change the 3D setting of your television or 3D output setting of the unit to 2D.

Card

Do not leave the card where the temperature is high, where electromagnetic waves or static electricity are easily generated or exposed to direct sunlight.

Do not bend or drop the card.

- The card may be damaged or the recorded content may be damaged or deleted.
- Put the card in the card case or the storage bag after use and when storing or carrying the card.
- Do not allow dirt, dust or water to get into the terminals on the back of the card and do not touch the terminals with your fingers.

Notice for when transferring to another party, or disposing of the memory card

- “Format” or “delete” using the camera or a PC will only modify the file management information, and it will not erase the data in the memory card completely.

It is recommended to physically destroy the memory card or use the commercially available computer data deletion software to completely erase the data in the memory card before transferring to another party or disposing.

Management of data in the memory card is the responsibility of the user.

About the personal information

If a name or birthday is set for [Baby1]/[Baby2]/Face Recognition function, this personal information is kept in the camera and recorded in the image.

Disclaimer

- Information including personal information may be altered or vanish due to erroneous operation, effect of static electricity, accident, malfunction, repair, or other handlings.
- Please note in advance that Panasonic is not liable in any way for any direct or indirect damage from the alteration or vanishing of information or personal information.

When requesting a repair, transferring to another party or disposing

- Reset the settings to protect the personal information. (P65)
- If there are pictures stored in the built-in memory, copy them into the memory card (P175) before formatting the built-in memory (P68) as needed.
- Remove the memory card from the camera when requesting a repair.
- Built-in memory and settings may return to factory default when camera is repaired.
- Please contact the dealer where you purchased the camera or Panasonic if above operations are not possible due to malfunction.

When transferring to another party, or disposing of the memory card, please refer to “Notice for when transferring to another party, or disposing of the memory card” on P205.

When not using the camera for a long period of time

- Store the battery in a cool and dry place with a relatively stable temperature: [Recommended temperature: 15 °C to 25 °C (59 °F to 77 °F), Recommended humidity: 40%RH to 60%RH]
- Always remove the battery and the card from the camera.
- If the battery is left inserted in the camera, it will discharge even if the camera is turned off. If the battery continues to be left in the camera, it will discharge excessively and may become unusable even if charged.
- When storing the battery for a long period of time, we recommend charging it once a year. Remove the battery from the camera and store it again after it has completely discharged.
- We recommend storing the camera with a desiccant (silica gel) when you keep it in a closet or a cabinet.

About the picture data

- Recorded data may be damaged or lost if the camera breaks down due to inappropriate handling. Panasonic will not be liable for any damage suffered due to loss of recorded data.

About tripods or unipods

- When you use a tripod, make sure the tripod is stable when this unit is attached to it.
- You may not be able to remove the card or the battery when using a tripod or unipod.
- Make sure that the screw on the tripod or unipod is not at an angle when attaching or detaching the camera. You may damage the screw on the camera if you use excessive force when turning it. Also, the camera body and the rating label may be damaged or scratched if the camera is attached too tightly to the tripod or unipod.
- Read the operating instructions for the tripod or unipod carefully.

Message Display

Confirmation messages or error messages will be displayed on the screen in some cases. The major messages are described below as examples.

[This picture is protected]

→ Delete the picture after canceling the protect setting. (P173)

[This picture cannot be deleted]/[Some pictures cannot be deleted]

- Pictures not based on the DCF standard cannot be deleted.
 - If you want to delete some pictures, format the card after saving necessary data on a PC etc. (P68)

[Cannot be set on this picture]

- [Title Edit], [Text Stamp] or [Print Set] cannot be set for pictures not based on the DCF standard.

[Built-in memory full]/[Memory card full]/[Not enough space on built-in memory]/[Not enough memory on the card]

- There is no space left on the built-in memory or the card.
- When you copy pictures from the built-in memory to the card (batch copy), the pictures are copied until the capacity of the card becomes full.

[Some pictures cannot be copied]/[Copy could not be completed]

- The following pictures cannot be copied.
 - When a picture with the same name as the picture to be copied exists in the copy destination. (Only when copying from a card to the built-in memory.)
 - Files not based on the DCF standard.
- Moreover, pictures recorded or edited by other equipment may not be copied.

[Built-In Memory Error Format built-in memory?]

- This message will be displayed when you formatted the built-in memory on a PC.
 - Format the built-in memory on the camera again. (P68) The data on the built-in memory will be deleted.

[Memory card error.**This card cannot be used in this camera.****Format this card?]**

- It is a format that cannot be used with this unit.
 - Insert a different card.
 - Format the card again with the camera after saving necessary data on a PC etc. (P68) The data on the card will be deleted.

[Please turn camera off and then on again]/[System Error]

- This is displayed when the lens has stopped operating normally due to being pressed on by a hand etc.
 - Turn the camera off and on. If the message persists, contact the dealer or Panasonic.

[Memory Card Error]/[Memory card parameter error]/[This memory card cannot be used]

- Use a card compatible with this unit. (P24)
- SD Memory Card (8 MB to 2 GB)
- SDHC Memory Card (4 GB to 32 GB)
- SDXC Memory Card (48 GB, 64 GB)

[Insert SD card again]/[Try another card]

- An error has occurred accessing the card.
 - Insert the card again.
 - Insert a different card.

**[Read Error/Write Error
Please check the card]**

- It has failed to read or write data.
 - Remove the card after turning this unit off. Insert the card again, turn this unit on, and try to read or write the data again.
- The card may be broken.
 - Insert a different card.

[Motion recording was cancelled due to the limitation of the writing speed of the card]

- Use a card with SD Speed Class with "Class 4" or higher when recording motion pictures.
- In the event that it stops even after using a "Class 4" card or higher, the data writing speed has deteriorated so it is recommended to make a backup and then format (P68).
- Depending on the type of the card, motion picture recording may stop in the middle.

[Cannot record due to incompatible format(NTSC/PAL) data on this card.]

- If you want to delete some pictures, format the card after saving necessary data on a PC etc. (P68)
- Insert a different card.

[A folder cannot be created]

- A folder cannot be created because there are no remaining folder numbers that can be used.
→ Format the card after saving necessary data on a PC etc. (P68) If you execute [No.Reset] in the [Setup] menu after formatting, the folder number is reset to 100. (P64)

[Picture is displayed for 16:9 TV]/[Picture is displayed for 4:3 TV]

- Select [TV Aspect] in the [Setup] menu if you want to change the TV aspect. (P66)
- This message also appears when the USB connection cable is connected to the camera only. In this case, connect the other end of the USB connection cable to a PC or a printer. (P183, 188)

DMC-FZ200**[Editing operation cannot proceed as information processing is ongoing.]**

When a card with pictures deleted or file names changed using a PC or other device is inserted into this unit, it will automatically retrieve new information and reconstruct the burst groups. The currently retrieving information icon [] may be displayed in the playback screen for long period of time when there are many image files, and deletion or [Playback] menu cannot be used during this time.

- If you turn this unit off while information is being retrieved, the pictures for which information was retrieved up to that point will be saved as a burst group. When you switch on again, the information retrieval will restart from the same point.

[Recording failed.]

- You may not record when the recording location is too dark/too bright, or if the subject does not have enough contrast when recording in 3D.

[This battery cannot be used]

- Use a genuine Panasonic battery. If this message is displayed even when a genuine Panasonic battery is used, contact the dealer or Panasonic.
- If the battery terminal is dirty, clean it and remove any objects.

DMC-FZ200**[Please make sure to turn on the power of external microphone.]**

- When attaching the stereo microphone (DMW-MS1: optional), check the battery status and make sure the power is on before use. (P198)

Troubleshooting

First, try out the following procedures (P210 to 219).

If the problem is not resolved, it may be improved by selecting [Reset] (P65) on the [Setup] menu.

Battery and power source

**The camera cannot be operated even when it is turned on.
The camera turns off immediately after it is turned on.**

- The battery is exhausted. Charge the battery.
- If you leave the camera on, the battery will be exhausted.
 - Turn the camera off frequently by using the [Economy] etc. (P63)

This unit is turned off automatically.

- If you connect to a TV compatible with VIERA Link with a HDMI mini cable (optional) and turn the TV off with the remote control for the TV, this unit is also turned off.
 - If you are not using VIERA Link, set [VIERA Link] to [OFF]. (P66)

Card/battery door does not close.

- Insert the battery securely all the way in.

Recording

The picture cannot be recorded.

- Is the mode dial correctly set?
- Is there any memory remaining on the built-in memory or the card?
 - Delete unnecessary pictures to increase the available memory. (P49)
- You may not be able to record for a short while after turning this unit on when using a large capacity card.

The recorded picture is whitish.

- The picture can become whitish if there is dirt e.g. fingerprints on the lens.
 - If the lens is dirty, turn the camera off, retract the lens barrel and gently wipe the lens surface with a soft dry cloth.

The recorded picture is too bright or dark.

- Check that the exposure is correctly compensated. (P79)
- Setting the [Min. Shtr Speed] to faster speed might make the picture darker.
 - Set the [Min. Shtr Speed] (P141) to slower speed.

Multiple pictures are taken at one time.

- Cancel the settings of White Balance Bracket (P91).
- Set Auto Bracket (P146) or the Burst Mode (P80) to [OFF].
- Is the Self-Timer (P84) set to [10s / 3pictures]?

The subject is not focused properly.

- The focus range varies depending on the Recording Mode.
 - Set to the proper mode for the distance to the subject.
- The subject is beyond the focus range of the camera. (P34)
- There is camera shake (jitter) or the subject is moving slightly. (P29)

The recorded picture is blurred.**The Optical Image Stabilizer is not effective.**

- The shutter speed becomes slower when pictures are taken in dark places so hold the camera firmly with both hands to take the pictures. (P29)
- When taking pictures at a slow shutter speed, use the Self-timer. (P84)

Taking pictures using Auto Bracket is not possible.

- Is there any memory remaining on the built-in memory or the card?

The recorded picture looks rough.**Noise appears on the picture.**

- Is the ISO sensitivity high or the shutter speed slow? (ISO sensitivity is set to [AUTO] when the camera is shipped. Therefore, when taking pictures indoors etc. noise will appear.)
 - Decrease the ISO sensitivity. (P86)
 - Increase the setting for [Noise Reduction] in [Photo Style] or lower the setting for each of the items other than [Noise Reduction]. (P134)
 - Take pictures in bright places.
- Has [High Sens.] in the Scene Mode been set? If so, the resolution of the recorded picture decreases slightly because of high sensitivity processing, but this is not a malfunction.

Striping or flicker may appear under lighting such as fluorescent lighting and LED lighting fixture.

- This is characteristic of MOS sensors which serve as the camera's pickup sensors.
This is not a malfunction.



The brightness or the hue of the recorded picture is different from the actual scene.

- When recording under fluorescent or LED lighting fixture etc., increasing the shutter speed may introduce slight changes to brightness and color. These are a result of the characteristics of the light source and do not indicate a malfunction.
- When recording subjects in extremely bright locations or recording under fluorescent lighting, LED lighting fixture, mercury lamp, sodium lighting etc., the colors and screen brightness may change or horizontal striping may appear on the screen.

Reddish horizontal streaks appear on the LCD monitor during recording.

- This is characteristic of MOS sensors which serve as the camera's pickup sensors. It appears when the subject has a bright part. Some unevenness may occur in the surrounding areas, but this is not a malfunction. It is recorded in pictures or motion pictures.
- It is recommended that you take pictures while taking care not to expose the screen to sunlight or any other source of strong light.



Motion picture recording stops in the middle.

- Use a card with SD Speed Class with "Class 4" or higher when recording motion pictures.
- Depending on the type of the card, recording may stop in the middle.
 - If motion picture recording stops during use of a card of at least "Class 4" or if you use a card that has been formatted on a PC or other equipment, the data-writing speed is lower. In such cases, we recommend that you make a backup of the data and then format (P68) the card in this unit.

Object seems to be warped.

- Object seems to be warped slightly when the object moves across the image very fast, but this is because the unit is using MOS for the image sensor. This is not a malfunction.

Zoom does not operate properly.

- Is the [Conversion] (P145) set to [] or []?

DMC-FZ200

The zoom cannot be controlled with the side lever.

- Has [Side Lever] (P57) been set to [FOCUS]?
 - Set [Side Lever] to [ZOOM].

Subject cannot be locked. (AF tracking not possible)

- Set the AF area to the distinctive color of the subject if there is a part that is different from the surrounding color. (P95)

Recording by [Panorama Shot] is ended before finishing.

- If the camera is moved too slowly, the camera has assumed that camera motion was stopped and will end the still picture recording.
- If there is a great deal of shaking towards the recording direction while moving the camera, recording will end.
 - When recording with [Panorama Shot], move the camera by trying to trace a small circle parallel to the recording direction at a speed of about 8 seconds per revolution (estimated).

Lens**Recorded image may be warped, or nonexistent color is surrounding the subject.**

- It is possible that the subject may be warped slightly, or the borders get colored, depending on the zoom magnification, due to the characteristics of the lens. Also, the peripherals of the image might look warped because the perspective is enhanced when the wide angle is used. This is not a malfunction.

LCD monitor/Viewfinder**The LCD monitor/Viewfinder becomes darker or brighter for a moment.**

- This phenomenon appears when you press the shutter button halfway to set the aperture value and does not affect the recorded pictures.
- This phenomenon also appears when the brightness changes when the camera is zoomed or when the camera is moved. This is because of operation of the automatic aperture of the camera, and it is not a malfunction.

The LCD monitor flickers indoors.

- The LCD monitor may flicker for a few seconds after this unit is turned on. This is an operation to correct flicker caused by lighting such as fluorescent lights, LED lights etc. and is not a malfunction.

The LCD monitor/Viewfinder is too bright or dark.

- Check [LCD Mode] setting. (P58)
- Perform [LCD Display]/[Viewfinder]. (P58)

The picture is not displayed on the LCD monitor.

- Does the picture appear on the Viewfinder?
 - Press [EVF/LCD] button to switch to LCD monitor display.

Black, red, blue and green dots appear on the LCD monitor.

- This is not a malfunction.
These pixels do not affect the recorded pictures.

Noise appears on the LCD monitor.

- In dark places, noise may appear to maintain the brightness of the LCD monitor. This does not affect the pictures you are recording.

Flash**The flash is not activated.**

- Is the flash closed?
 - Open the flash. (P75)
- The flash cannot be used in the following cases:
 - When using Auto Bracket (P146)
 - When recording in [Burst] (except for []) (P80)
 - [Scenery]/[Panorama Shot]/[Night Scenery]/[Handheld Night Shot]/[HDR]/[Sunset]/[Glass Through]/[3D Photo Mode] (Scene Mode) (P107)

The flash is activated multiple times.

- The flash is activated twice when Red-Eye Reduction (P76) has been set.
- Is Burst Mode set to []?

Playback**The picture being played back is rotated and displayed in an unexpected direction.**

- [Rotate Disp.] (P67) is set to [] or [].

**The picture is not played back.
There are no recorded pictures.**

- Is there a picture on the built-in memory or the card?
 - The pictures on the built-in memory appear when a card is not inserted. The picture data on the card appears when a card is inserted.
- Is this a folder or picture which was processed in the PC? If it is, it cannot be played back by this unit.
 - It is recommended to use the "PHOTOfunSTUDIO" software in the CD-ROM (supplied) to write pictures from PC to card.
- Has [Filtering Play] been set for playback?
 - Change to [Normal Play]. (P156)

The folder number and the file number are displayed as [—] and the screen turns black.

- Is this a non-standard picture, a picture which has been edited using a PC or a picture which was taken by another make of digital camera?
- Did you remove the battery immediately after picture-taking or did you take the picture using a battery with a low remaining charge?
→ Format the data to delete the pictures mentioned above. (P68)
(Other pictures will be deleted as well and it will not be possible to restore them. Therefore, check well before formatting.)

With a Calendar Search, pictures are displayed on dates differing from the actual dates on which the pictures were taken.

- Is the clock in the camera set properly? (P27)
- When pictures edited using a PC or pictures taken by other equipment are searched, they may be displayed on dates differing from the actual dates on which the pictures were taken.

White round spots like soap bubbles appear on the recorded picture.

- If you take a picture with the flash in a dark place or indoors, white round spots may appear on the picture caused by the flash reflecting of particles of dust in the air. This is not a malfunction.
A characteristic of this is that the number of round spots and their position differ in every picture.



Red part of the recorded image has changed color to black.

- When Red-Eye Removal ([~~A~~], [~~S~~]) is in operation, if you take a picture of subject with red color surrounded by a skin tone color, that red part may be corrected to black by the Red-Eye Removal function.
→ It is recommend to take picture with Flash Mode set to [~~A~~], [~~S~~] or [~~S~~], or [Red-Eye Removal] on the [Rec] menu set to [OFF]. (P145)

[Thumbnail is displayed] appears on the screen.

- Is it a picture that has been recorded with other equipment? In such cases, these pictures may be displayed with a deteriorated picture quality.

A clicking sound is recorded in the motion pictures.

- This unit automatically adjusts the aperture during motion picture recording. At such times, a clicking sound is heard, and this sound may be recorded on the motion pictures. This is not a malfunction.
- The operational sound of the zoom or button operation may be recorded when it is operated during the recording of a motion picture.

Motion pictures recorded with this unit cannot be played back on other equipment.

- Motion pictures recorded in [AVCHD] or [MP4] may be played back with poor picture or sound quality or playback may not be possible even when played back with equipment compatible with these formats. Also, the recording information may not be displayed properly.

TV, PC and printer

The picture does not appear on the television.

- Is the camera connected to the TV correctly?
→ Set the TV input to external input mode.

The display areas on the TV screen and the camera's LCD monitor are different.

- Depending on the TV model, the pictures may be extended horizontally or vertically or they may be displayed with their edges cut off.

The motion pictures cannot be played back on a TV.

- Are you trying to play back the motion pictures by directly inserting the card in the card slot of the TV?
→ Connect the camera to the TV with the AV cable (optional), or with the HDMI mini cable (optional), and then play back the motion pictures on the camera. (P176)

The picture is not displayed fully on the TV.

- Check [TV Aspect] setting. (P66)

VIERA Link does not work.

- Is it connected properly with the HDMI mini cable (optional)? (P176)
→ Confirm that the HDMI mini cable (optional) is firmly fitted.
→ Press [▶] on this unit.
- Is the [VIERA Link] on this unit set to [ON]? (P66)
→ Depending on HDMI terminal of the TV, the input channel may not switch automatically. In this case, use the remote control for the TV to switch input. (For details on how to switch input, please read the operating instructions for the TV.)
→ Check the VIERA Link setting on the connected device.
→ Turn this unit off and on.
→ Set [HDAVI Control] to [Off] on the TV and then turn it back to [On]. (Refer to the operating instructions of the TV for details.)

Cannot communicate with the PC.

- Is the camera connected to the PC correctly?
- Is the camera recognized by the PC correctly?
 - Set to [PC] in [USB Mode]. (P65, 183)
 - Turn this unit off and on.

The card is not recognized by the PC. (The built-in memory is recognized.)

- Disconnect the USB connection cable. Connect it again while the card is inserted in the camera.
- If there are two or more USB terminal on a single PC, try connecting the USB connection cable to another USB terminal.

The card is not recognized by the PC. (SDXC memory card is used)

- Check if your PC is compatible with SDXC memory cards.
<http://panasonic.net/avc/sdcard/information/SDXC.html>
- A message prompting to format the card may be displayed when connecting, but do not format.
- If the [Access] displayed on the LCD monitor does not disappear, disconnect the USB connection cable after turning this unit off.

There is a problem trying to upload to YouTube or Facebook.

- Confirm that the login information (login ID/user name/mail address/password) is correct.
- Confirm that the PC is connected to the Internet.
- Confirm that resident software such as virus protection software or firewall is not blocking access to YouTube or Facebook.
- Confirm with YouTube or Facebook as well.

The picture cannot be printed when the camera is connected to a printer.

- Pictures cannot be printed using a printer which does not support PictBridge.
 - Set to [PictBridge(PTP)] in [USB Mode]. (P65, 188)

The ends of the pictures are cut at printing.

- When using a printer with a cropping or borderless printing function, cancel this function before printing. (For details, refer to the operating instructions for the printer.)
- When you order photo studios to print pictures, ask the photo studio if the pictures can be printed with both ends.

The panorama picture is not printing correctly.

- Since aspect ratio of a panorama picture differs from normal pictures, it may not always be possible to print it correctly.
 - Please use a printer that supports panorama pictures. (For details, please see the operating instructions of your printer)
 - We recommend using the "PHOTOfunSTUDIO" software on the CD-ROM (supplied) to adjust the size of the still picture to the print paper size.

Others

When shaking the camera, there is a rattling sound.

In the following cases, there is no problem with the camera, so do not worry.

- There is a rattling sound when the camera is shaken while this unit is turned off or during Playback Mode. (Sound of lens moving)
- This unit makes a rattling sound etc., when this unit is turned on or off, or when switching from Recording Mode to Playback Mode. (Sound of the aperture)
- Vibration is felt when zooming. (Movement of the lens barrel motor)
- When you hear a clicking or snapping sound from the lens while taking pictures. (The sound of the aperture adjusting to changes in light levels)

When this occurs, the image on the LCD monitor may appear to change dramatically. However, the picture is not affected.

An unreadable language was selected by mistake.

→ Press [MENU/SET], select the [Setup] menu icon [] and then select the [Q] icon to set the desired language. (P68)

A red lamp sometimes turns on when the shutter button is pressed halfway.

- In dark places, the AF Assist Lamp lights red to make it easier to focus on a subject.

Part of the picture is flashing in black and white.

- This is a highlight function showing the white saturated area. (P61)
- Is the [Highlight] set to [ON]?

The AF Assist Lamp does not turn on.

- Is [AF Assist Lamp] on the [Rec] menu set to [ON]? (P144)
- The AF Assist Lamp does not turn on in bright places.

The camera becomes warm.

- The surface of the camera may become warm during use. This does not affect the performance or quality of the camera.

The lens clicks.

- When the brightness changes due to zoom or camera movement etc., the lens may click and the picture on the screen may drastically change. However, the picture is not affected. The sound is caused by the automatic adjustment of the aperture. This is not a malfunction.

The clock is reset.

- If you do not use the camera for a long time, the clock may be reset.
→ [Please set the clock] message will be displayed; please re-set the clock. (P27)

Zooming stops instantaneously.

- When using the Extended Optical Zoom, the zooming action will stop temporarily. This is not a malfunction.

DMC-FZ60**Zoom does not go up to maximum magnification.**

- Is the camera set to Macro Zoom Mode? (P97)
Maximum zoom during Macro Zoom Mode is 3× Digital Zoom.

The file numbers are not recorded consecutively.

- When you perform an operation after taking a certain action, the pictures may be recorded in folders with different numbers from the ones used prior to the operation.

The file numbers are recorded with previously used numbers.

- If you insert or remove the battery before turning off this unit, the folder and file numbers for the pictures taken will not be stored in the memory. When this unit is turned on again and pictures are taken, they may be stored under file numbers which should have been assigned to previous pictures.

When the camera is left alone, the slide show is suddenly displayed.

- This is the [Auto Demo] to introduce the features of the camera. Press a button to return the camera to the original screen.

- SDXC Logo is a trademark of SD-3C, LLC.
- “AVCHD”, “AVCHD Progressive”, the “AVCHD” logo and the “AVCHD Progressive” logo are trademarks of Panasonic Corporation and Sony Corporation.
- Manufactured under license from Dolby Laboratories. Dolby and the double-D symbol are trademarks of Dolby Laboratories.
- HDMI, the HDMI Logo, and High-Definition Multimedia Interface are trademarks or registered trademarks of HDMI Licensing LLC in the United States and other countries.
- HDAVI Control™ is a trademark of Panasonic Corporation.
- QuickTime and the QuickTime logo are trademarks or registered trademarks of Apple Inc., used under license therefrom.
- iMovie, Mac and Mac OS are trademarks of Apple Inc., registered in the U.S. and other countries.
- Windows and Windows Vista are either registered trademarks or trademarks of Microsoft Corporation in the United States and/or other countries.
- YouTube is a trademark of Google Inc.
- Facebook® is a trademark of Facebook, Inc.
- This product uses “DynaFont” from DynaComware Corporation. DynaFont is a registered trademark of DynaComware Taiwan Inc.
- Other names of systems and products mentioned in these instructions are usually the registered trademarks or trademarks of the manufacturers who developed the system or product concerned.

AVCHD™
Progressive
(DMC-FZ200)

AVCHD™
(DMC-FZ60)

DOLBY
DIGITAL

HDMI



This product is licensed under the AVC patent portfolio license for the personal and non-commercial use of a consumer to (i) encode video in compliance with the AVC Standard (“AVC Video”) and/or (ii) decode AVC Video that was encoded by a consumer engaged in a personal and non-commercial activity and/or was obtained from a video provider licensed to provide AVC Video. No license is granted or shall be implied for any other use. Additional information may be obtained from MPEG LA, LLC. See <http://www.mpegla.com> .