

OLYMPUS®

DIGITAL CAMERA

E-PM1

Instruction Manual

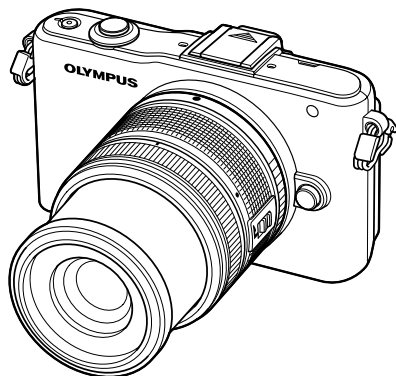

Basic guide

Quick task index

Table of Contents

- 1. Basic photography/frequently-used options**
- 2. Other shooting options**
- 3. Flash shooting**
- 4. Shooting and viewing movies**
- 5. Playback options**
- 6. Sending and receiving images**
- 7. Using OLYMPUS Viewer 2/[ib]**
- 8. Printing pictures**
- 9. Camera setup**
- 10. Customizing camera settings**
- 11. Information**
- 12. SAFETY PRECAUTIONS**

System chart

Index

- Thank you for purchasing an Olympus digital camera. Before you start to use your new camera, please read these instructions carefully to enjoy optimum performance and a longer service life. Keep this manual in a safe place for future reference.
- We recommend that you take test shots to get accustomed to your camera before taking important photographs.
- The screen and camera illustrations shown in this manual were produced during the development stages and may differ from the actual product.
- The contents in this manual are based on firmware version 1.0 for this camera. If there are additions and/or modifications of functions due to firmware update for the camera, the contents will differ. For the latest information, please visit the Olympus website.

■ This notice concerns the supplied flash unit and is chiefly directed to users in North America.

Information for Your Safety

IMPORTANT SAFETY INSTRUCTIONS





When using your photographic equipment, basic safety precautions should always be followed, including the following:

- Read and understand all instructions before using.
- Close supervision is necessary when any flash is used by or near children. Do not leave flash unattended while in use.
- Care must be taken as burns can occur from touching hot parts.
- Do not operate if the flash has been dropped or damaged - until it has been examined by qualified service personnel.
- Let flash cool completely before putting away.
- To reduce the risk of electric shock, do not immerse this flash in water or other liquids.
- To reduce the risk of electric shock, do not disassemble this flash, but take it to qualified service personnel when service or repair work is required. Incorrect reassembly can cause electric shock when the flash is used subsequently.
- The use of an accessory attachment not recommended by the manufacturer may cause a risk of fire, electric shock, or injury to persons.

SAVE THESE INSTRUCTIONS

Indications used in this manual

The following symbols are used throughout this manual.

 Cautions	Important information on factors which may lead to a malfunction or operational problems. Also warns of operations that should be absolutely avoided.
 Notes	Points to note when using the camera.
 Tips	Useful information and hints that will help you get the most out of your camera.
	Reference pages describing details or related information.

Unpack the box contents

The following items are included with the camera.
If anything is missing or damaged, contact the dealer from whom you purchased the camera.



Camera



Body cap



Strap

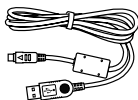

USB cable
CB-USB6



AV cable
(Monaural)
CB-AVC3

- Flash case
- Computer software CD-ROM
- Instruction manual
- Warranty card



Flash
FL-LM1



Lithium ion
battery
PS-BLS1 (BLS-1)
or BLS-5

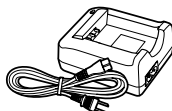

Lithium ion
charger
PS-BCS1 (BCS-1)
or BCS-5

Attaching the strap

- 1** Thread the strap in the direction of the arrows.

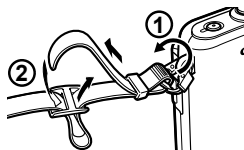

- 2** Lastly, pull the strap tight making sure that it is fastened securely.

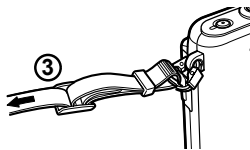

- Attach the other end of the strap to the other eyelet in the same way.

Charging and inserting the battery

1 Charging the battery.

Charging indicator

	BCS-1	BCS-5
Charging in progress	Lights orange	
Charging complete	Lights blue	Off
Charging error	Blinks orange	

(Charging time: Up to approximately 3 hours 30 minutes)

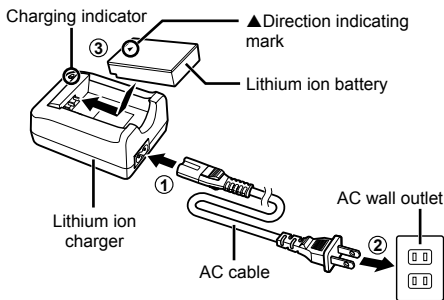

⚠ Cautions

- Unplug the charger when charging is complete.
- Use only compatible battery chargers to charge rechargeable batteries. BLS-1 batteries must be charged using the BCS-1, BLS-5 batteries using the BCS-5.

2 Loading the battery.

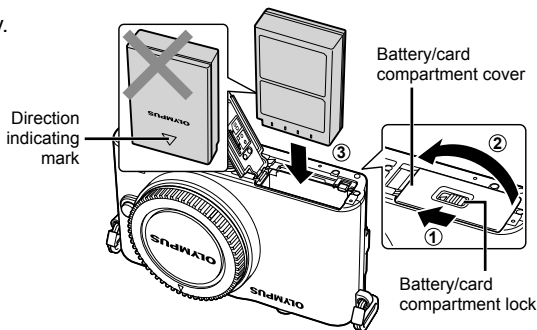

Removing the battery

Turn off the camera before opening or closing the battery/card compartment cover.

To remove the battery, first push the battery lock knob in the direction of the arrow and then remove.

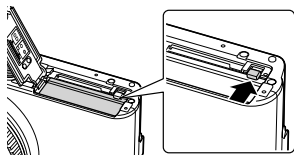

⚠ Cautions

- Contact an authorized distributor or service center if you are unable to remove the battery. Do not use force.

📌 Notes

- It is recommended to set aside a backup battery for prolonged shooting in case the battery in use drains.

Inserting and removing cards

1 Loading the card.

- Insert the SD/SDHC/SDXC/Eye-Fi card (referred to as “card” in these instructions) until it locks in place.

👉 “Card basics” (P. 99)

! Cautions

- Turn off the camera before loading or removing the card.

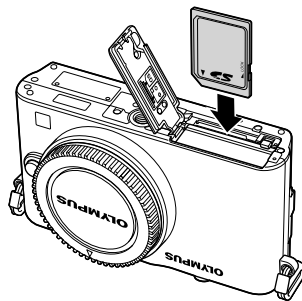

Removing the card

Press the inserted card lightly and it will be ejected. Pull out the card.

! Cautions

- Do not remove the battery or card while the card write indicator (P. 24) is displayed.

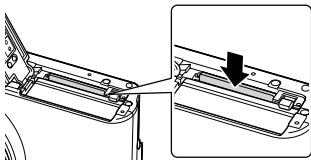

2 Closing the battery/card compartment cover.

- Close the cover and slide the battery/card compartment lock in the direction shown by the arrow.

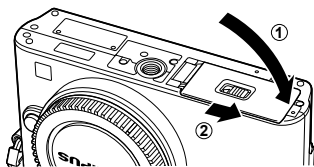

! Cautions

- Close the battery/card compartment cover when using the camera.

Attaching a lens to the camera

- 1** Remove the body cap from the camera and the rear cap from the lens.

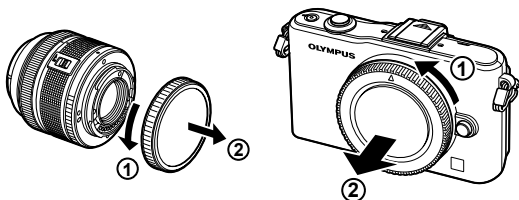

- 2** Attach a lens to the camera.

! Cautions

- Make sure the camera is turned off.
 - Do not press the lens release button.
 - Do not touch internal portions of the camera.
- Align the lens attachment mark (red) on the camera with the alignment mark (red) on the lens, then insert the lens into the camera's body.
- Rotate the lens in the direction indicated by the arrow until you hear it click.

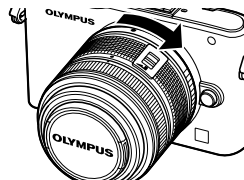
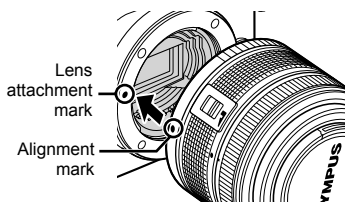

- 3** Remove the lens cap.

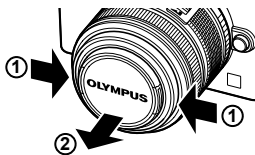

Removing the lens from the camera

While pressing the lens release button, rotate the lens in the direction of the arrow.

 "Interchangeable lenses" (P. 100)

Lens release button



Attaching the flash unit

1 Remove the terminal cover from the flash unit and attach the flash to the camera.

- Slide the flash unit all the way in, stopping when it contacts the back of the shoe and is securely in place.

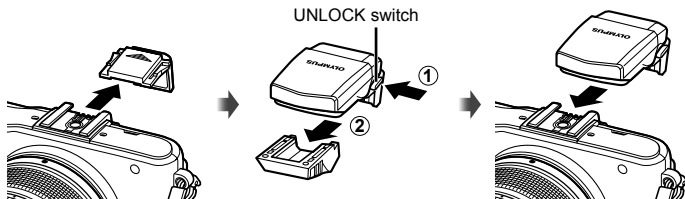

2 To use the flash, raise the flash head.

- Lower the flash head when the flash is not in use.

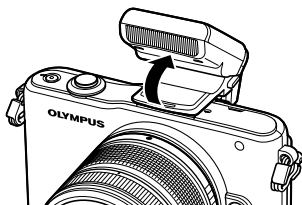

Removing the Flash Unit

Press the UNLOCK switch while removing the flash unit.

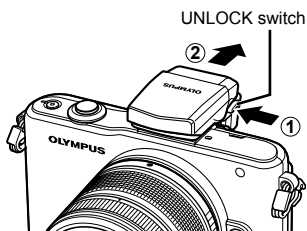

Power on

Press the **ON/OFF** button to turn on the camera.

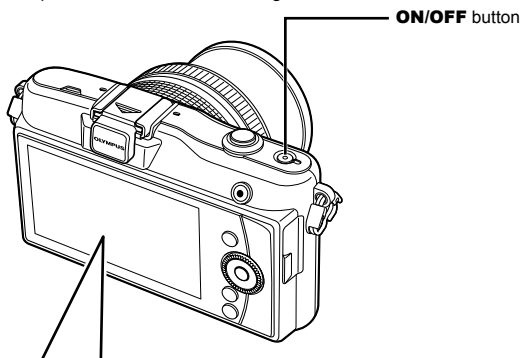

- When the camera is turned on, the (blue) power lamp will light and the monitor will turn on.
- When the camera is turned on, dust reduction will be performed to remove dust from the surface of the image sensor filter.
- To turn off the power, press the **ON/OFF** button again.



■ Monitor



Battery level

-  (green): Camera ready to shoot. Displayed for about 10 seconds after the camera is turned on.
-  (green): Low battery
-  (blinks red): Charge the battery

Available recording time

Number of storable still pictures

Setting the date/time

Date and time information is recorded on the card together with the images. The file name is also included with the date and time information. Be sure to set the correct date and time before using the camera.

1 Display the menus.

- Press the **MENU** button to display the top menu.

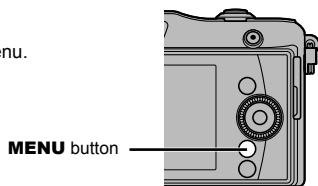

2 Use \triangleleft \triangleright to select [SETUP] and press \odot .

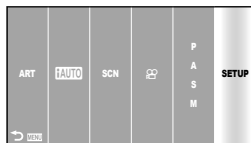

3 Select \odot in the [f] (setup) tab.

- Use \triangle ∇ to select [f] and press \triangleright .
- Select \odot and press \triangleright .

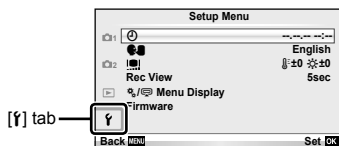

4 Set the date and time.

- Use \triangleleft \triangleright to select items.
- Use \triangle ∇ to change the selected item.
- Use \triangle ∇ to select the date format.

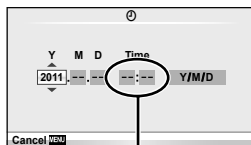

The time is displayed using a 24-hour clock.

5 Save settings and exit.

- Press \odot to set the camera clock and exit to the main menu.
- Press the **MENU** button to exit the menus.

Names of parts

Camera

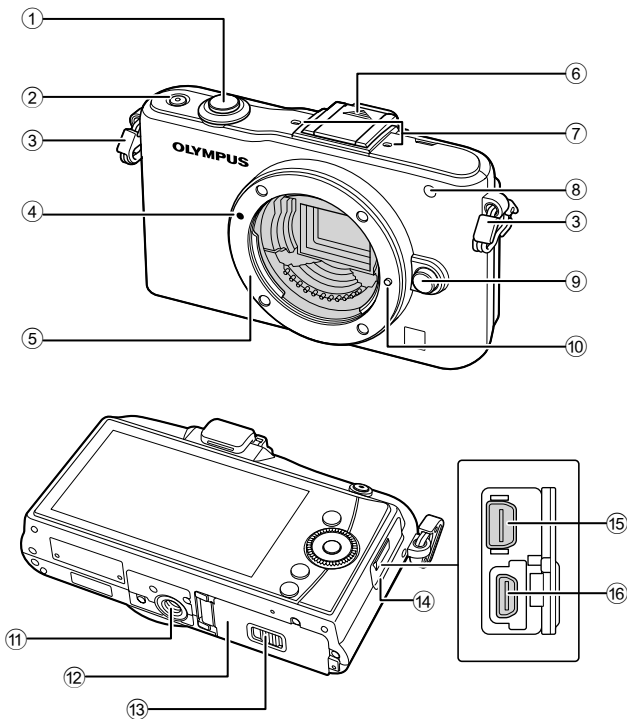

- | | |
|--|--|
| ① Shutter buttonP. 13, 14, 36, 92 | ⑨ Lens release buttonP. 6 |
| ② ON/OFF buttonP. 8 | ⑩ Lens lock pin |
| ③ Strap eyelet.....P. 3 | ⑪ Tripod socket |
| ④ Lens attachment markP. 6 | ⑫ Battery/card compartment cover.....P. 4 |
| ⑤ Mount (Remove the body cap before attaching the lens.) | ⑬ Battery/card compartment lock.....P. 4 |
| ⑥ Hot shoe cover | ⑭ Connector cover |
| ⑦ Stereo microphoneP. 62, 68 | ⑮ Multi-connectorP. 69, 73, 77 |
| ⑧ Self-timer lamp/AF illuminator
.....P. 49/P. 82 | ⑯ HDMI micro connector (type D)P. 69 |

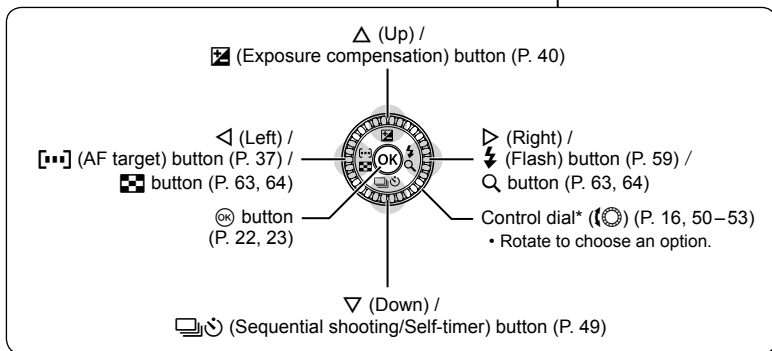
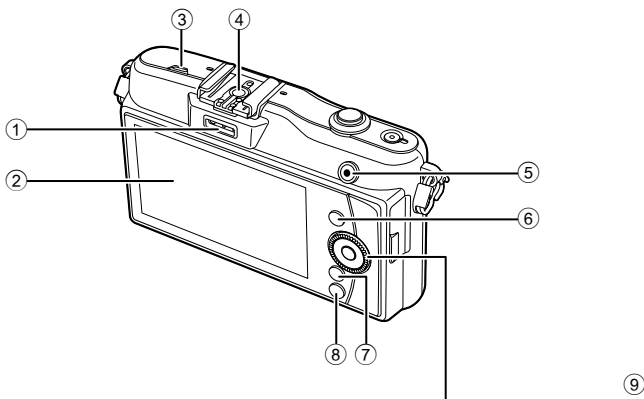

- ① Accessory portP. 71, 81, 90
- ② MonitorP. 24
- ③ Speaker
- ④ Hot shoeP. 60
- ⑤ (Movie) button....P. 13, 15, 61, 65, 89
- ⑥ **INFO** (Information display) button
.....P. 24, 25, 32–34, 38
- ⑦ **MENU** button.....P. 23
- ⑧ [Play] (Playback) button.....P. 16, 63
- ⑨ Arrow pad
Control dial* (⦿).....P. 16, 50–53

* In this manual, the ⦿ icon represent operations performed using the control dial.

Choosing a Shooting Mode

Choose from a variety of shooting modes. After choosing the shooting mode, use the shutter button to take photographs and the **OK** button to shoot movies.

- 1 Press the **MENU** button to display the top menu.
- 2 Use **◀▶** to select a shooting mode.
 - In the **P/A/S/M** column, use **△▽** to highlight **P**, **A**, **S**, or **M**.

MENU button

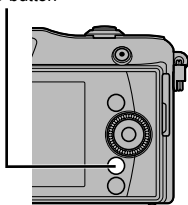

■ Movie mode

 Movie (P. 61)

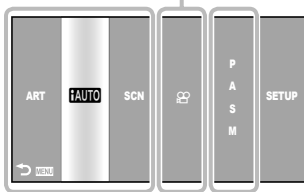

■ Easy shooting modes

iAUTO	iAUTO (P. 20)
ART	Art filter (P. 18)
SCN	Scene (P. 19)

- If **iAUTO** is selected, the camera automatically optimizes settings to suit the subject.
- Select **ART** or **SCN** options according to your subject or creative intent. The camera optimizes settings automatically.
- In these modes, default settings are restored if another shooting mode is selected or the camera is turned off.

■ Advanced shooting modes

P	Program shooting (P. 50)
A	Aperture priority shooting (P. 51)
S	Shutter priority shooting (P. 52)
M	Manual shooting (P. 53)

- For more advanced shooting and greater creative control, you can set the aperture value and shutter speed.
- The settings made in the advanced shooting modes are retained even if the camera is turned off.

- 3 Press **OK**.
 - In **SCN** and **ART** modes, a menu will be displayed. Use **△▽** to highlight options and press **OK** to select.

Tips

- Resetting camera settings:  "Restoring default or custom settings" (P. 35)

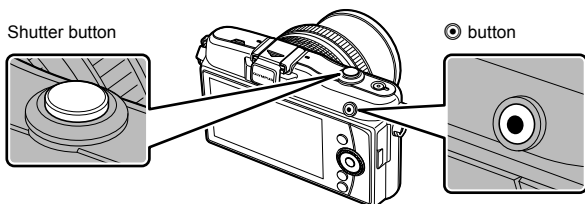

Mode	Photos: shutter button	Movies: button with a circle icon
P	Aperture and shutter speed are automatically adjusted for optimal results.	The camera automatically adjusts settings and records a movie.
A	You control aperture.	
S	You control shutter speed.	
M	You control aperture and shutter speed.	
HAUTO	A full auto mode in which the camera automatically optimizes settings for the current scene.	
ART	Select an art filter.	
SCN	Select a scene.	Adjust shutter speed or aperture for different effects while shooting movies.
	Photographs are recorded at the settings selected in [Mode].	

■ Taking photographs during movie recording

- To take a photograph during movie recording, press the shutter button. Press the button with a circle icon to end recording. Three files will be recorded to the memory card: the movie footage preceding the photograph, the photograph itself, and the movie footage following the photograph.
- Only one photograph can be taken at a time during movie recording; the self-timer and flash can not be used.

! Cautions

- Image size and quality for photographs are independent of movie frame size.
- The autofocus and metering used in movie mode may differ from that used to take photographs.
- The button with a circle icon can not be used to record movies in the following instances: shutter button pressed halfway/BULB/Sequential shooting/PANORAMA/3D/multiple exposure, etc. (still photography also ends)

Taking photographs/shooting movies

1 Frame the shot.

- Be sure your fingers, the strap, or other objects do not obstruct the lens.

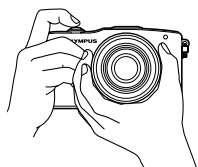

Horizontal grip

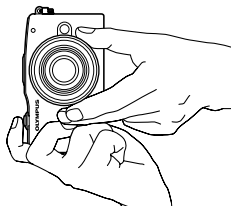

Vertical grip

Using lenses with an UNLOCK switch

Retractable lenses with an UNLOCK switch can not be used while retracted.

Turn the zoom ring in the direction of arrow (1) to extend the lens (2).

To store, turn the zoom ring in the direction of arrow (4) while sliding the UNLOCK switch (3).

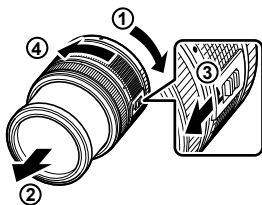

2 Adjust the focus.

- Lightly press the shutter button down to the first position (press the shutter button halfway).

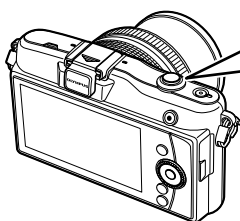

Press the shutter button halfway.

AF target AF confirmation mark



Shutter speed Aperture value

- The AF confirmation mark (● or ○) will be displayed and focus will lock.

●	Lenses that supports Hi-Speed Imager AF*
○	Lenses with other Four Thirds mounts

* Visit our website for more information.

- The shutter speed and aperture value that have been set automatically by the camera are displayed.

Pressing the shutter button halfway and all the way down

The shutter button has two positions. The act of lightly pressing the shutter button to the first position and holding it there is called “pressing the shutter button halfway,” that of pressing it all the way down to the second position “pressing the shutter button all (or the rest of) the way down.”



3 Release the shutter.

Taking photographs

Press the shutter button all the way (fully).

- The shutter sounds and the picture is taken.

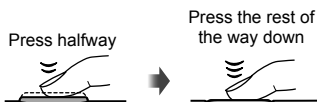



Recording movies

Release the shutter button and press the  button to begin recording.

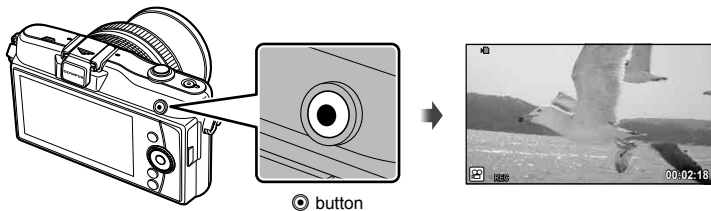
Press the  button again to end recording.



Tips

- If no operations are performed for a minute, the camera enters “sleep” (stand-by) mode to turn off the monitor and to cancel all actions. The camera activates again when you touch any button (the shutter button,  button, etc.). [Sleep]:  “Customizing camera settings” (P. 81)

Cautions

- If the camera is used for extended periods, the temperature of the image pickup device will rise and noise and colored fog may appear in images recorded at high ISO sensitivities. Choose a lower ISO sensitivity or turn the camera off for a short period.

Viewing Images

■ Single-frame playback

- Press the  button to display your most recent photograph or movie.

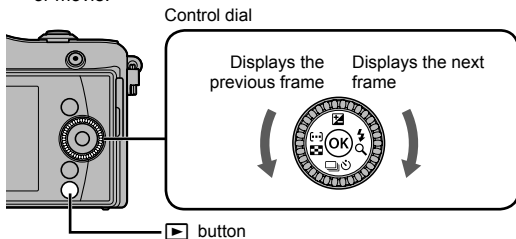





Still image









Movie



■ Close-up playback

- In single-frame playback, press  () to zoom in up to 14x. Press  () to return to single-frame playback.

■ Index display/Calendar display

- To view multiple frames, press  () during single-frame playback. To start calendar playback, press  () repeatedly.
- Press  () to view the currently selected picture full frame.





Index display



Calendar display

■ Movie playback

Select a movie and press  to display the playback menu. Select [Movie Play] and press  to begin playback.

- To interrupt movie playback, press **MENU**.

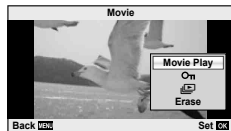

Volume

Volume can be adjusted by pressing Δ or ∇ during single-frame and movie playback.



Erasing images

Display an image you want to delete and press OK to display the playback menu. Use Δ ∇ to highlight [Erase] and press OK , then highlight [Yes] and press OK to delete the picture.

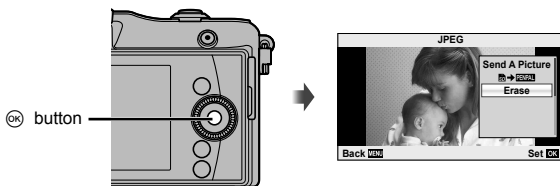

Protecting images

Protect images from accidental deletion. Display an image you wish to protect and press OK to display the playback menu. Select Protect and press OK , and then press Δ to protect the image. Protected images are shown by a Protect (protect) icon. Press ∇ to remove protection.

Protect (protect) icon



Tips

- Protecting or deleting multiple images:  "Selecting images" (P. 65)

Cautions

- Formatting the card erases all images even if they have been protected.

Using art filters

1 Select **ART** as the shooting mode.

-  "Choosing a Shooting Mode" (P. 12)



- Press **OK** or press the shutter button halfway to display the view through the lens in the monitor. Press **OK** to return to the art filter menu.

■ Types of art filters

 Pop Art

 Soft Focus

 Grainy Film

 Pin Hole

 Diorama

 Dramatic Tone

2 Shoot.

! Cautions

- If [RAW] is currently selected for image quality, image quality will automatically be set to [L1N+RAW]. The art filter will be applied to the JPEG copy only.
- Depending on the subject, tone transitions may be ragged, the effect may be less noticeable, or the image may become more "grainy."
- Playback varies with movie quality and filter settings.

Shooting in scene mode

1 Select **SCN** as the shooting mode.

- "Choosing a Shooting Mode" (P. 12)

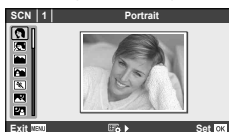

- Press **OK** or press the shutter button halfway to display the view through the lens in the monitor. Press **OK** to return to the scene menu.

■ Types of scene modes

- | | |
|--------------------|------------------|
| Portrait | Nature Macro |
| e-Portrait | Candle |
| Landscape | Sunset |
| Landscape+Portrait | Documents |
| Sport | Panorama (P. 54) |
| Night Scene | Fireworks |
| Night+Portrait | Beach & Snow |
| Children | Fisheye Effect |
| High Key | Wide-angle |
| Low Key | Macro |
| DIS Mode | 3D Photo |
| Macro | |

2 Shoot.

! Cautions

- In [e-Portrait] mode, two images are recorded: an unmodified image and a second image to which [e-Portrait] effects have been applied. The unmodified image is recorded using the option currently selected for image quality, the modified copy at an image quality of JPEG (M-quality (2560 × 1920)).
- [Fisheye Effect], [Wide-angle], and [Macro] are for use with optional converter lenses.
- Movies can not be recorded in [e-Portrait], [Panorama], or [3D Photo] mode.

Using live guides

Live guides are available in iAUTO (iAUTO) mode. While iAUTO is a full auto mode, live guides make it easy to access a variety of advanced photographic techniques.

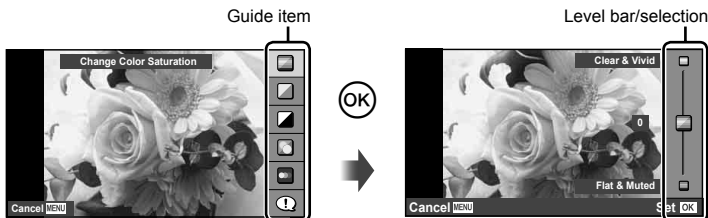

Guide item	Level bar/selection	Affects
Change Color Saturation	Clear & Vivid ↔ Flat & Muted	Saturation, contrast, gradation, etc.
Change Color Image	Warm ↔ Cool	Color temperature, gradation, etc.
Change Brightness	Bright ↔ Dark	Exposure compensation, gradation, etc.
Blur Background	Blur ↔ Sharp	Aperture, live preview, etc.
Express Motions	Blurred Motion* ↔ Stop Motion	Shutter speed (1/2 s – fastest speed), frame rate, etc.
Shooting Tips	<ul style="list-style-type: none"> • Tips For Child Photo • Tips For Pet Photo • Tips For Flower Photo • Tips For Cuisine Photo • Tips For Framing • Tips With Accessory 	—

* Monitor frame rate slows.

- 1 Select **FAUTO** as the shooting mode.
 - "Choosing a Shooting Mode" (P. 12)
- 2 After pressing **OK** to display the live guide, use the **Δ** **▽** buttons on the arrow pad to highlight an item and press **OK** to select.



- 3 Use **Δ** **▽** on the arrow pad to choose the level.
 - If [Shooting Tips] is selected, highlight an item and press **OK** to view a description.
 - Press the shutter button halfway to select.
 - The effect of the selected level is visible in the display. If [Blur Background] or [Express Motions] is selected, the display will return to normal, but the selected effect will be visible in the final photograph.

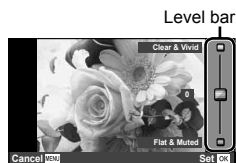

- 4 Shoot.
 - Press the shutter button to shoot.
 - To clear the live guide from the display, press the **MENU** button.

Cautions

- If [RAW] is currently selected for image quality, image quality will automatically be set to [L+N+RAW].
- Live guide settings are not applied to the RAW copy.
- Pictures may appear grainy at some live guide setting levels.
- Changes to live guide setting levels may not be visible in the monitor.
- The flash can not be used with the live guide.
- Changes to live guide options cancel previous changes.
- Choosing live guide settings that exceed the limits of the camera exposure meters may result in pictures that are over- or under-exposed.
- In **P**, **A**, **S**, and **M** modes, live guides can be displayed by pressing the **OK** button. Pictures will be taken using live guide settings. [Button Function]: "Customizing camera settings" (P. 81)

Using live control

The live control can be used to adjust settings in **P**, **A**, **S**, **M**, and **☞** modes. Using live control allows you to preview the effects of different settings in the monitor. A custom setting is available that allows the live control to be used in other modes (P. 81).

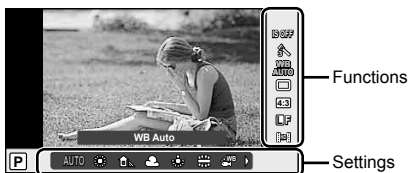

Available settings

Image stabilizer	P. 42	Record mode	P. 47
Picture mode ¹	P. 45	Flash mode ^{1,2}	P. 59
Scene mode ²	P. 19	Flash intensity control ^{1,2}	P. 60
Art filter mode ²	P. 18	Metering mode ^{1,2}	P. 41
☞ mode ³	P. 61	AF mode	P. 36
White balance	P. 43	ISO sensitivity	P. 48
Sequential shooting/self-timer	P. 49	Face priority ^{1,2}	P. 39
Aspect ratio ^{1,2}	P. 48	Movie sound record	P. 62

*1 **P**, **A**, **S** and **M** modes only.

*2 **ART** and **SCN** only.

*3 **☞** mode only.

1 Press **OK** to display the live control.

- To hide the live control, press **OK** again.

2 Use the **Δ**/**∇** buttons on the arrow pad to select settings, use **◀**/**▶** to change the selected setting, and press **OK**.

- The selected settings take effect automatically if no operations are performed for about 8 seconds.

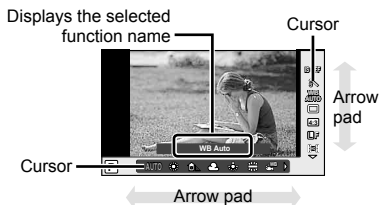

! Cautions

- Some items are not available in some shooting modes.

💡 Tips

- For information on displaying or hiding the live control.
[📷 Control Settings]: **☞** "Customizing camera settings" (P. 81)

Using the menus

- 1 After pressing the **MENU** button to display the top menu, select [SETUP] and press **OK**.

Menus

- 📷 Preliminary and basic shooting options
- 📷 2 Advanced shooting options
- ▶ Playback and retouch options
- ⚙️ Custom menu*
- 🗨️ Accessory port menu*
- ⚙️ Camera setup (e.g., date and language)

* Not displayed at default settings.

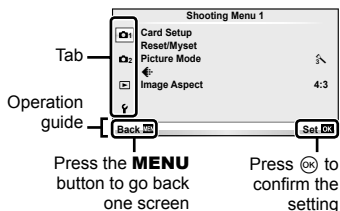

- 2 Use Δ ∇ to select a tab and press **OK**.
- 3 Select an item using Δ ∇ and press **OK** to display options for the selected item.

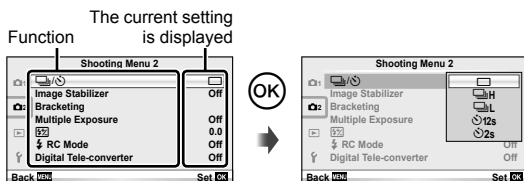

- 4 Use Δ ∇ to highlight an option and press **OK** to select.
 - Press the **MENU** button repeatedly to exit the menu.

Notes

- For details on the functions that can be set with the menu, refer to "Menu directory" (P. 107).
- A guide is displayed for about 2 seconds after you select an option. Press the **INFO** button to view or hide guides.

Tips

- Camera settings can be customized to your shooting style: Use the custom menus to customize camera settings to your own goals or taste. Custom menus are not displayed by default, and you will need to display the menus before proceeding. 🗨️ "Customizing camera settings" (P. 81)
- Using accessory port devices: Settings for the EVF and OLYMPUS PENPAL accessories are accessed from the accessory port menu. This menu is not displayed by default, and you will need to display it before proceeding. 🗨️ "Customizing camera settings" (P. 81)

Information displayed in the monitor

Shooting

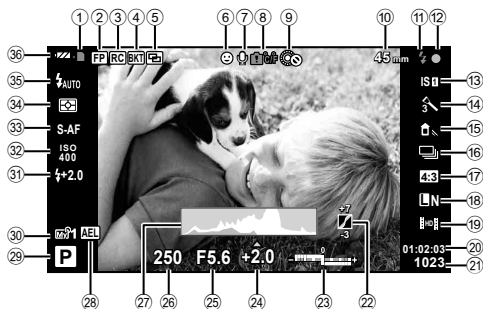

- | | |
|---|---|
| ① Card write indicator.....P. 10 | ②② Tone controlP. 34 |
| ② Super FP flash FPP. 105 | ②③ Top: Flash intensity controlP. 60 |
| ③ RC mode.....P. 93 | Bottom: Exposure compensation indicator.....P. 40 |
| ④ Auto bracket BKTP. 57 | ②④ Exposure compensation value.....P. 40 |
| ⑤ Multiple exposure MEP. 56 | ②⑤ Aperture valueP. 50–53 |
| ⑥ Face priority FPP. 39, 82 | ②⑥ Shutter speedP. 50–53 |
| ⑦ Movie soundP. 62 | ②⑦ HistogramP. 32, 33 |
| ⑧ Internal temperature warning | ②⑧ AE Lock AELP. 41 |
| °C/FP. 97 | ②⑨ Shooting mode.....P. 12, 50–55 |
| ⑨ LockP. 82 | ②⑩ MysetP. 35 |
| ⑩ Focal lengthP. 100 | ③① Flash intensity control.....P. 60 |
| ⑪ FlashP. 59 | (blinks: charging in progress, lights up: charging completed) |
| ⑫ AF confirmation mark.....P. 14 | ③② ISO sensitivity.....P. 48 |
| ⑬ Image stabilizer.....P. 42 | ③③ AF modeP. 36 |
| ⑭ Art filterP. 18 | ③④ Metering mode.....P. 41 |
| Scene mode.....P. 19 | ③⑤ Flash modeP. 59 |
| Picture mode.....P. 45 | ③⑥ Battery check |
| ⑮ White balanceP. 43 | Lit up (green) : Ready for use (displayed for about ten seconds after the camera is turned on) |
| ⑯ Sequential shooting/self-timerP. 49 | Lit up (green) : Battery is running low |
| ⑰ Aspect ratio.....P. 48 | Blinks (red) : Charging required |
| ⑰ Record mode (still images).....P. 47 | |
| ⑰ Record mode (movies)P. 48 | |
| ⑳ Available recording time | |
| ㉑ Number of storable still pictures ...P. 106 | |

You can switch the monitor display using the **INFO** button.

INFO “Switching the information display” (P. 32)

Playback

Simplified display

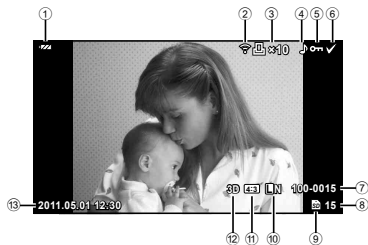

Overall display

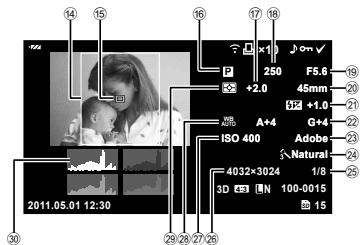

- | | |
|------------------------------------|--|
| ① Battery check.....P. 8 | ⑩ Shooting mode.....P. 12, 50–53 |
| ② Eye-Fi upload complete.....P. 88 | ⑪ Exposure compensation.....P. 40 |
| ③ Print reservation | ⑫ Shutter speed.....P. 50–53 |
| Number of prints.....P. 76 | ⑬ Aperture value.....P. 50–53 |
| ④ Sound record.....P. 68 | ⑭ Focal length.....P. 100 |
| ⑤ Protect.....P. 17 | ⑮ Flash intensity control.....P. 60 |
| ⑥ Image selected.....P. 65 | ⑯ White balance compensation.....P. 44 |
| ⑦ File number.....P. 76, 86 | ⑰ Color space.....P. 85 |
| ⑧ Frame number.....P. 76 | ⑱ Picture mode.....P. 45 |
| ⑨ Storage device.....P. 99 | ⑲ Compression rate.....P. 47 |
| ⑩ Record mode.....P. 47 | ⑳ Pixel count.....P. 47 |
| ⑪ Aspect ratio.....P. 48, 67 | ㉑ ISO sensitivity.....P. 48 |
| ⑫ 3D image.....P. 55 | ㉒ White balance.....P. 43 |
| ⑬ Date and time.....P. 9 | ㉓ Metering mode.....P. 41 |
| ⑭ Aspect border.....P. 48 | ㉔ Histogram.....P. 32, 33 |
| ⑮ AF target.....P. 37 | |

You can switch the monitor display using the **INFO** button.



“Displaying information during playback” (P. 33)

Quick task index

Shooting



Taking pictures with automatic settings	▶ iAUTO (iAUTO)	12
Easy photography with special effects	▶ Art filter (ART)	18
Choosing an aspect ratio	▶ Aspect ratio	48
Quickly matching settings to the scene	▶ Scene (SCN)	19
Pro-level photography made simple	▶ Live guide	20
Taking pictures so that whites come out white and blacks come out black	▶ Exposure compensation	40
Taking pictures with a blurred background	▶ Live guide	20
	▶ Aperture priority shooting	51
Taking pictures that stop the subject in motion or convey a sense of motion	▶ Live guide	20
	▶ Shutter priority shooting	52
Taking pictures with the correct color	▶ White balance	43
	▶ One-touch white balance	44
Processing pictures to match the subject/ Taking monotone pictures	▶ Picture Mode	45
	▶ Art filter (ART)	18
Focus/Focusing on one area	▶ AF target	37
	▶ Zoom frame AF/zoom AF	38
When the camera won't focus on your subject	▶ Focus lock	37
Focusing on a small spot in the frame/ confirming focus before shooting	▶ Zoom frame AF/zoom AF	38
Recomposing photographs after focusing	▶ Focus lock	37
	▶ C-AF+TR (AF Tracking)	36
Turning off the beep speaker	▶ ■)) (Beep sound)	84
Disabling the flash/taking photos without the flash	▶ Flash	59
	▶ ISO/DIS Mode	48/19
Reducing camera shake	▶ Image Stabilizer	42
	▶ Anti-Shock	84
	▶ Self-timer	49
	▶ Remote cable	102
Taking pictures of a subject against backlight	▶ Flash shooting	59
	▶ Gradation (Picture Mode)	45
Photographing fireworks	▶ Bulb shooting	53
	▶ Scene (SCN)	19

Reducing image noise (mottling)	▶ Noise Reduct.	85
Taking pictures without white subjects appearing too white or black subjects appearing too dark	▶ Gradation (Picture Mode)	45
	▶ Histogram/ Exposure compensation	32/40
Optimizing the monitor/ adjusting monitor hue	▶ Tone control	34
	▶ Monitor brightness adjustment	80
	▶ Live View Boost	83
Checking set effect before taking a picture	▶ Multi view display	32, 40
	▶ Preview function	51
	▶ Test Picture	89
Taking pictures while checking the level of the camera/Shooting with deliberate composition	▶ Displayed Grid ( /Info Settings)	83
Zooming in on photos to check focus	▶ Auto  (Rec View)	80
Self-portraits	▶ Self-timer	49
Sequential shooting	▶ Sequential shooting	49
Extending the useful life of the battery	▶ Sleep	84
Increasing the number of pictures that can be taken	▶ Record mode	47

Playback/Retouch

Viewing images on a TV	▶ Playback on TV	69
Viewing slideshows with background music	▶ Slideshow	66
Brightening shadows	▶ Shadow Adj (JPEG Edit)	67
Dealing with red-eye	▶ Redeye Fix (JPEG Edit)	67
Printing made easy	▶ Direct printing	77
Commercial prints	▶ Creating a print order	76
Simple photo sharing	▶ OLYMPUS PENPAL	71

Camera Settings

Restoring default settings	▶ Reset	35
Saving the settings	▶ Myset	35
Changing the menu display language	▶ 	80

Table of Contents

Basic guide	4	Quick task index	26
Preparations for shooting	4	Basic photography/ frequently-used options	32
Charging and inserting the battery	4	Switching the information display	32
Inserting and removing cards	5	Choosing shooting controls	32
Attaching a lens to the camera	6	Displaying information during playback	33
Attaching the flash unit	7	Other uses for the INFO button	34
Power on	8	Restoring default or custom settings	35
Setting the date/time	9	Using reset settings	35
Names of parts and functions	10	Saving Myset	35
Names of parts	10	Using Myset	35
Camera	10	Choosing a focus mode (AF mode)	36
Choosing a Shooting Mode	12	Choosing a focus target (AF target)	37
Basic operations	14	Focus lock	37
Taking photographs/shooting movies	14	Quick AF target selection	37
Playback/Erasing	16	Toggling quickly between AF and MF	37
Viewing Images	16	Zoom frame AF/zoom AF	38
Volume	17	Face priority AF/ pupil detection AF	39
Erasing images	17	Taking pictures using face priority	39
Protecting images	17	Controlling exposure (exposure compensation)	40
Using art filters	18	Previewing the effects of exposure compensation and white balance	40
Shooting in scene mode	19		
Using live guides	20		
Using live control	22		
Using the menus	23		
Information displayed in the monitor	24		
Shooting	24		
Playback	25		

Changing the brightness of highlights and shadows	40
Choosing how the camera measures brightness (metering).....	41
Exposure lock (AE lock)	41
Reducing camera shake (the image stabilizer).....	42
Adjusting color (white balance)	43
White balance compensation	44
One-touch white balance.....	44
Processing options (picture mode)	45
Image quality (record mode)	47
Choosing a record mode	47
Setting the image aspect.....	48
ISO sensitivity.....	48
Sequential shooting/using the self timer	49
Other shooting options	50
“Point-and-shoot” photography (P program mode).....	50
Choosing aperture (A aperture-priority mode).....	51
Choosing shutter speed (S shutter-priority mode).....	52
Choosing aperture and shutter speed (M manual mode).....	53
Choosing when the exposure ends.....	53
Taking Panoramas.....	54
Taking pictures for a panorama	54
3D Photography.....	55
Recording multiple exposures in a single image (multiple exposure)	56
Varying settings over a series of photographs (bracketing).....	57
Digital Zoom (Digital Tele-converter)	58
Flash shooting	59
Using a flash (flash photography)	59
Adjusting flash output (Flash intensity control).....	60
Using external flash units designated for use with this camera.....	60
Other external flash units	60
Shooting and viewing movies	61
Changing the settings for movie recording.....	61
Adding effects to a movie	61
Movie sound options (recording sound with movies).....	62
Viewing movies	62
Playback options	63
Single-frame playback	63
Index display/ calendar display	63
Playback zoom (close-up playback).....	64
Selecting images	65

Table of Contents

Canceling all protections.....	65
All-frame erase	65
Rotate	65
Slideshow.....	66
Editing still images.....	67
Image overlay	68
Audio recording.....	68
Viewing camera images on TV.....	69

Sending and receiving images 71

Sending images.....	71
Receiving images/ adding a host.....	71
Editing the address book	72
Creating albums	72

Using OLYMPUS Viewer 2/ [ib] 73

Windows	73
Macintosh	74

Copying pictures to a computer without OLYMPUS Viewer 2/ [ib].....	75
--	----

Printing pictures 76

Print reservation (DPOF)	76
Creating a print order.....	76
Removing all or selected pictures from the print order.....	77
Direct printing (PictBridge)	77
Easy printing.....	78
Custom printing	78

Camera setup 80

Setup Menu	80
⌚ (Date/time setting)	80
🗨️ (Changing the display language)	80
📊 (Monitor brightness adjustment).....	80
Rec View	80
🗨️/🗨️ Menu Display.....	80
Firmware.....	80

Customizing camera settings 81

Before Using the Custom/ Accessory Port Menus	81
--	----

Custom Menu options.....	81
📷 AF/MF	81
📷 Button/Dial	82
📷 Release/📷	83
📷 Disp/📷)/PC.....	83
📷 Exp/📷/ISO.....	84
📷 ⚡ Custom.....	85
📷 ⚡/Color/WB	85
📷 Record/Erase	86
📷 Movie	87
📷 📷 Utility	88
AEL/AFL	88
📷 Function	89
Accessory port menu options... 90	
📷 OLYMPUS PENPAL Share.....	90
📷 OLYMPUS PENPAL Album	90
📷 Electronic Viewfinder	90

Using the super control panel.....	91	Exposure warning display.....	103
Recording movies with the shutter button.....	92	Flash modes that can be set by shooting mode.....	104
Taking a photograph when recording ends.....	92	Flash synchronization and shutter speed.....	105
Wireless remote control flash photography.....	93	External flash unit.....	105
Information	94	Record mode and file size/number of storable still pictures.....	106
Shooting tips and information.....	94	Menu directory.....	107
Error codes.....	96	Specifications.....	111
Cleaning and storing the camera.....	98	SAFETY PRECAUTIONS	113
Cleaning the camera.....	98	SAFETY PRECAUTIONS.....	113
Storage.....	98	System chart	122
Cleaning and checking the image pickup device.....	98	Index	124
Pixel mapping - Checking the image processing functions.....	98		
Card basics.....	99		
Usable cards.....	99		
Formatting the card.....	99		
Battery and charger.....	100		
Using your charger abroad.....	100		
Interchangeable lenses.....	100		
M.ZUIKO DIGITAL lens specifications.....	101		
Principal Accessories.....	102		
Mount adapter.....	102		
Remote cable (RM-UC1).....	102		
Converter lenses.....	102		
Macro arm light (MAL-1).....	102		
Microphone set (SEMA-1).....	102		
Electronic viewfinder (VF-2).....	102		

1

Basic photography/frequently-used options

The **INFO** button can be used to choose the information and type of controls displayed during shooting.

Switching the information display

Press the **INFO** button to choose the information displayed when shooting.

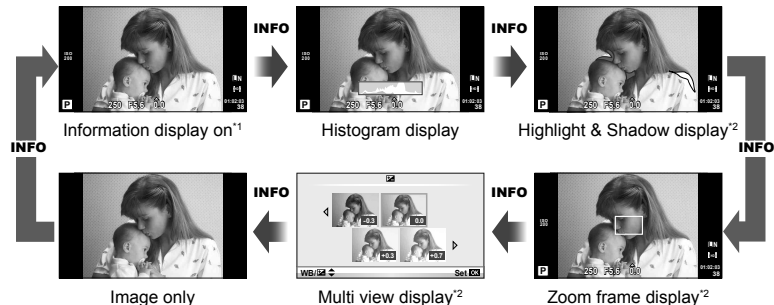

*1 You can display a framing grid or choose the type of grid displayed using [Grid]/Info Settings] > [LV-Info]. [Grid] "Customizing camera settings" (P. 81)

*2 Displayed when [On] is selected for [Grid]/Info Settings] > [LV-Info]. [Grid] "Customizing camera settings" (P. 81)

Choosing shooting controls

Shooting options can be displayed by pressing **OK**. You can choose the types of display available using the [Control Settings] option in the custom menus (P. 81).

ART/SCN

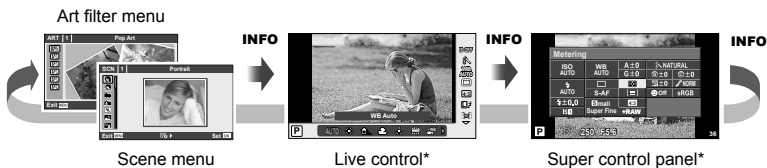

P/A/S/M

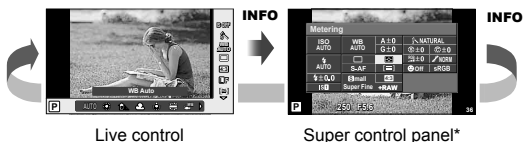

* Can be displayed using [Control Settings].

Displaying information during playback

The **INFO** button can be used to choose the information displayed during playback.

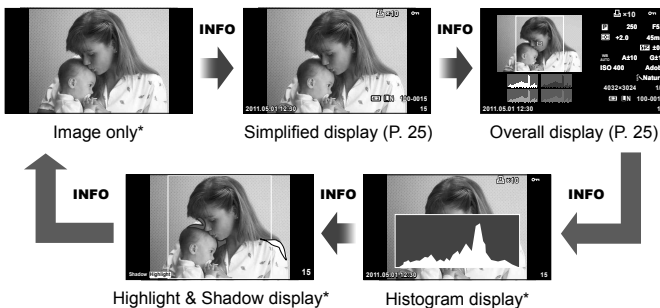

* Displayed when [On] is selected for [Info Settings] > [Info]. "Customizing camera settings" (P. 81)

Histogram display

Display a histogram showing the distribution of brightness in the image. The horizontal axis gives the brightness, the vertical axis the number of pixels of each brightness in the image. Areas above the upper limit at shooting are displayed in red, those below the lower limit in blue, and the area metered using spot metering in green.

Highlight & Shadow display

Areas above the upper limit of brightness for the image are shown in red, those below the lower limit in blue. [Histogram Settings]: "Customizing camera settings" (P. 81)

Other uses for the INFO button

■ One-touch white balance

To view the one-touch white balance dialog, press the **INFO** button in the one-touch white balance menu (P. 44).







■ Color temperature

To view the color temperature dialog, press the **INFO** button in the custom white balance menu (P. 43).







■ Tone control

Exposure compensation, aperture, and shutter speed can be adjusted by pressing the  button. The tone control dialog can be displayed by pressing the **INFO** button after pressing the  button. You can then use   to choose the tone level.  “Changing the brightness of highlights and shadows” (P. 40)



■ Focal length

To choose the focal length for image stabilization, press the **INFO** button in the IS mode dialog and use    or the control dial.  “Reducing camera shake (the image stabilizer)” (P. 42)



■ Help

Help is displayed automatically about 2 seconds after an item is selected. To disable help, press the **INFO** button. Press the **INFO** button again to re-enable help.

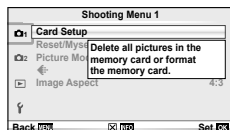

Restoring default or custom settings

Camera settings can be easily restored to one of three presets.

Reset: Restore default settings.

Myset: Restore preselected settings for **P**, **A**, **S**, or **M** mode. The shooting mode does not change. Up to four sets of preselected settings can be stored.

Quick Myset: Preset settings are used only while the **Q** button is pressed. Shooting mode is adjusted to the preset settings. [Button Function]:
☞ “Customizing camera settings” (P. 81)

Using reset settings

1 Select [Reset/Myset] in shooting menu **Q** (P. 107).

2 Select [Reset] and press **OK**.

- Highlight [Reset] and press **▷** to choose the reset type.
- Settings affected by resets: ☞ “Menu directory” (P. 107)

3 Select [Yes] and press **OK**.

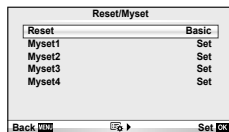

Saving Myset

1 Adjust settings in order to save.

2 Select [Reset/Myset] in shooting menu **Q** (P. 107).

3 Select the desired destination ([Myset1]–[Myset4]) and press **▷**.

- [Set] appears next to destinations ([Myset1]–[Myset4]) to which settings have already been saved. Selecting [Set] again overwrites the registered setting.
- To cancel the registration, select [Reset].

4 Select [Set] and press **OK**.

☞ “Menu directory” (P. 107)

Using Myset

1 Select [Reset/Myset] in shooting menu **Q** (P. 107).

2 Select the desired settings ([Myset1]–[Myset4]) and press **OK**.

3 Select [Set] and press **OK**.

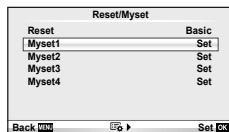

Choosing a focus mode (AF mode)

Select a focusing method (focus mode).

- 1 Display the live control (P. 22) and select the AF mode item using Δ ∇ .
- 2 Select an option with \triangleleft \triangleright and press OK .
 - The selected AF mode is displayed on the monitor.

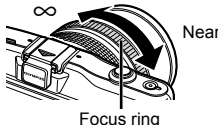

S-AF (single AF)	The camera focuses once when the shutter button is pressed halfway. When the focus is locked, a beep sounds, and the AF confirmation mark and the AF target mark light up. This mode is suitable for taking pictures of still subjects or subjects with limited movement.
C-AF (continuous AF)	The camera repeats focusing while the shutter button remains pressed halfway. When the subject is in focus, the AF confirmation mark lights up on the monitor and the beep sounds when the focus is locked at the first and second time. Even if the subject moves or you change the composition of the picture, the camera continues trying to focus. <ul style="list-style-type: none">• Four Thirds system lenses focus using [S-AF].
MF (manual focus)	This function allows you to manually focus on any subject. 
S-AF+MF (simultaneous use of S-AF mode and MF mode)	After pressing the shutter button halfway to focus in [S-AF] mode, you can turn the focus ring to fine-adjust focus manually.
C-AF+TR (AF tracking)	Press the shutter button halfway to focus; the camera then tracks and maintains focus on the current subject while the shutter button is held in this position. <ul style="list-style-type: none">• The AF target is displayed in red if the camera can no longer track the subject. Release the shutter button and then frame the subject again and press the shutter button halfway.• Four Thirds system lenses focus using [S-AF].

Tips

- The [RIs Priority S] (P. 83) and [RIs Priority C] (P. 83) options can be used to choose whether the shutter can be released when the camera is unable to focus.
- [MF Assist] (P. 82) can be used to enable automatic zoom display when the lens focus ring is rotated.
- [Focus Ring] (P. 82) allows you to change the rotational direction of the focus ring.

Cautions

- The camera may be unable to focus if the subject is poorly lit, obscured by mist or smoke, or lacks contrast.

Choosing a focus target (AF target)

Choose which of the 35 autofocus targets will be used for autofocus.

- 1 Press the **[•••]** button (◀) to display the AF target.
- 2 Use **△ ▽ ◀▶** to select the single target display and position the AF target.
 - “All targets” mode is restored if you move the cursor off the screen.
 - You can choose from the following three target types. Press the **INFO** button and use **△ ▽**.

All Targets

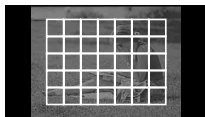

The camera automatically chooses from the full set of focus targets.

Single Target



Select the focus target manually.

Group Target

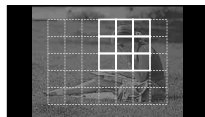

The camera automatically chooses from the targets in the selected group.

Focus lock

If the camera is unable to focus on your chosen subject, select single target mode and use focus lock to focus on another subject at about the same distance.

- 1 In [S-AF] mode, position the AF target over the subject and press the shutter button halfway.
 - Make sure that the AF confirmation mark is lighting up.
 - Focus locks while the shutter button is pressed halfway.
- 2 Keeping the shutter button pressed halfway, recompose the photograph and then press the shutter button the rest of the way down.
 - Do not change the distance between the camera and the subject while pressing the shutter button halfway.

Quick AF target selection

You can save the selected AF target for quick recall using the **⊙** button.

- Select the AF target using **[•••] Set Home** (P. 82).
- Use **[⊙ Function]** to assign this function to the button.
[Button Function]: **ⓘ** “Customizing camera settings” (P. 81)

toggling quickly between AF and MF

The **⊙** button can be used to toggle [MF].

- Use **[⊙ Function]** to assign this function to the button.
[Button Function]: **ⓘ** “Customizing camera settings” (P. 81)

Zoom frame AF/zoom AF

You can zoom in on a portion of the frame when adjusting focus. Choosing a high zoom ratio allows you to use autofocus to focus on a smaller area than is normally covered by the AF target. You can also position the focus target more precisely. Before proceeding, select [On] for [Info Settings] > [LV-Info] > [Zoom] (P. 32). [Info] “Customizing camera settings” (P. 81)

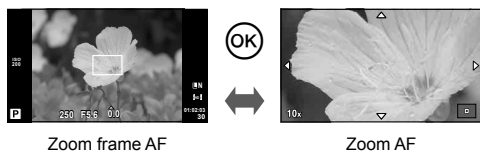

- 1 Press the **INFO** button repeatedly to display the zoom frame.
 - If the camera was focused using autofocus just before the button was pressed, the zoom frame will be displayed at the current focus position.
 - Use Δ ∇ \langle \rangle to position the zoom frame.
- 2 Press **OK** to zoom in on the zoom frame.
 - Use Δ ∇ \langle \rangle to position the zoom frame.
 - Rotate the control dial to zoom in or out.
 - Press **OK** again to exit zoom.

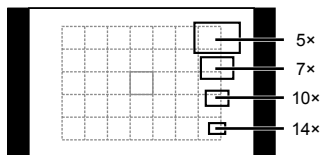

Comparison of AF and zoom frames

- 3 Press the shutter button halfway to initiate autofocus.

Notes

- Autofocus is available and pictures can be taken both when the zoom frame is displayed and when the view through the lens is zoomed in.

Tips

- You can also use the **OK** button to view the zoom frame and zoom displays.
[Button Function]: [Info] “Customizing camera settings” (P. 81)

Cautions

- Zoom is visible only in the monitor and has no effect on the resulting photographs.

Face priority AF/pupil detection AF

The camera detects faces and adjusts focus and digital ESP.

Taking pictures using face priority

- 1 Display the live control (P. 22) and select the face priority item using Δ / ∇ .
- 2 Use \triangleleft / \triangleright to select an option and press \odot .



OFF Face Priority Off	Face priority off.
☺ Face Priority On	Face priority on.
☺ Face & Eye Priority On	The autofocus system selects the pupil of the eye closest to the camera for face-priority AF.
☺ Face & R. Eye Priority On	The autofocus system selects the pupil of the eye on the right for face-priority AF.
☺ Face & L. Eye Priority On	The autofocus system selects the pupil of the eye on the left for face-priority AF.

- 3 Point the camera at your subject.
 - If a face is detected, it will be indicated by a white border.
- 4 Press the shutter button halfway to focus.
 - When the camera focuses on the face in the white border, the border will turn green.
 - If the camera is able to detect the subject's eyes, it will display a green frame over the selected eye. (pupil detection AF)

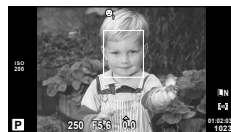

- 5 Press the shutter button the rest of the way down to shoot.

! Cautions

- Face priority applies only to the first shot in each sequence taken during sequential shooting.
- Depending on the subject, the camera may not be able to correctly detect the face.
- In metering modes other than [ESP] (Digital ESP metering), the camera will meter exposure for the selected position.

📝 Notes

- Face priority is also available in [MF]. Faces detected by the camera are indicated by white frames.

Controlling exposure (exposure compensation)

Press the  button (Δ) and use $\langle \rangle$ to adjust exposure compensation. Choose positive (“+”) values to make pictures brighter, negative (“-”) values to make pictures darker. Exposure can be adjusted by ± 3 EV.



Tips



- To change the exposure adjustment interval. [EV Step]:  “Customizing camera settings” (P. 81)

Cautions

- Exposure compensation is not available in **FAUTO**, **M**, or **SCN** modes.

Previewing the effects of exposure compensation and white balance

The effects of exposure compensation and white balance can be previewed in the 4-split screen.

1 Select [On] for [/Info Settings] > [Multi View] in the  Custom menu (P. 81).

2 Press the **INFO** button repeatedly to display the multi view display.

- This function is not available in **FAUTO**, **ART**, **SCN** or  mode.

3 Use $\langle \rangle$ to select the desired value and press .

- Use $\Delta \nabla$ to toggle between the exposure compensation and white balance displays.



Changing the brightness of highlights and shadows

To display the tone control dialog, press the  button (Δ) and press the **INFO** button. Use $\langle \rangle$ to choose a tone level. Choose “low” to darken shadows or “high” to brighten highlights.

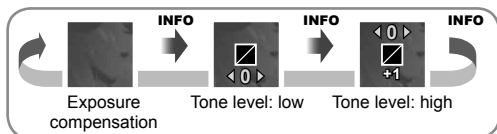







Choosing how the camera measures brightness (metering)

Choose how the camera meters subject brightness.

- 1 Display the live control (P. 22) and select the metering item using $\Delta \nabla$.
- 2 Select an option with $\triangleleft \triangleright$ and press OK .

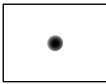

 Digital ESP metering	The camera meters exposure in 324 areas of the frame and optimizes exposure for the current scene or (if an option other than [OFF] is selected for [☺ Face Priority]) portrait subject. This mode is recommended for general use.	
 Center weighted averaging metering	This metering mode provides the average metering between the subject and the background lighting, placing more weight on the subject at the center.	
 Spot metering	Choose this option to meter a small area (about 2% of the frame) with the camera pointed at the object you wish to meter. Exposure will be adjusted according to the brightness at the metered point.	
 Spot metering - highlight control	Increases spot metering exposure. Ensures bright subjects appear bright.	
 Spot metering - shadow control	Lowers spot metering exposure. Ensures dark subjects appear dark.	

- 3 Press the shutter button halfway.
 - Normally, the camera will start metering when the shutter button is pressed halfway and lock exposure while the shutter button is held in this position.

Exposure lock (AE lock)

To lock exposure without locking focus, press the OK button. Exposure lock can be used when you want to set focus and exposure separately while recomposing photographs, or if you want to take a series of photographs at the same exposure.

- Assign AEL/AFL to the OK button using [☺ Function].  "Customizing camera settings" (P. 81)

Exposure locks and a **[AEL]** icon is displayed when the button is pressed once. Press the shutter button to take a picture.

- Press the button again to cancel AE lock.



AE lock

Tips

- To lock exposure while the button is pressed. [AEL/AFL Memo]: To activate AE lock with a set metering mode. [AEL Metering]:  "Customizing camera settings" (P. 81)

Reducing camera shake (the image stabilizer)

You can reduce the amount of camera shake that can occur when shooting in low light situations or shooting with high magnification.

- 1 Display the live control (P. 22) and select the image stabilizer item using Δ ∇ .



- 2 Select an option with \triangleleft \triangleright and press OK .

OFF IS Off	Image stabilizer is off.
IS Auto	Image stabilizer is on.
IS Vertical IS	Image stabilization applies only to vertical (IS) camera shake. Use when panning the camera horizontally.
IS Horizontal IS	Image stabilization applies only to horizontal (IS) camera shake. Use when panning the camera horizontally with the camera held in portrait orientation.

Choosing a focal length (Micro Four Thirds/Four Thirds System lenses excluded)

Use focal length information to reduce camera shake when shooting with lenses that are not Micro Four Thirds or Four Thirds system lenses.

- 1 Select the [Image Stabilizer] item in the live control (P. 22) and press the **INFO** button.

- 2 Use \triangleleft \triangleright to choose a focal length and press OK .

- Choose a focal length between 8 mm and 1000 mm.
- Choose the value that most closely matches to the one that is printed on the lens.



! Cautions

- The image stabilizer cannot correct excessive camera shake or camera shake that occurs when the shutter speed is set to the slowest speed. In these cases, it is recommended that you use a tripod.
- When using a tripod, set [Image Stabilizer] to [OFF].
- When using a lens with an image stabilization function, turn off the image stabilizer function of either the lens or the camera.
- You may notice an operating sound or vibration when the image stabilizer is activated.
- The image stabilizer will not activate at shutter speeds of over 2 seconds.

Adjusting color (white balance)

White balance (WB) ensures that white objects in images recorded by the camera appear white. [AUTO] is suitable in most circumstances, but other values can be selected according to the light source when [AUTO] fails to produce the desired results or you wish to introduce a deliberate color cast into your images.

- 1 Display the live control (P. 22) and select the white balance item using Δ ∇ .
- 2 Select an option using \triangleleft \triangleright and press OK .



WB mode		Color temperature	Light conditions
Auto white balance	AUTO	—	Used for most light conditions (when there is a white portion framed on the monitor). Use this mode for general use.
Preset white balance		5300K	For shooting outdoors on a clear day, or to capture the reds in a sunset or the colors in a fireworks display
		7500K	For shooting outdoors in the shadows on a clear day
		6000K	For shooting outdoors on a cloudy day
		3000K	For shooting under a tungsten light
		4000K	For subjects lit by fluorescent lights
		—	For underwater photography
		5500K	For flash shooting
One-touch white balance (P. 44)		Color temperature set by one-touch WB.	Choose when a white or gray subject can be used to measure white balance and the subject is under mixed lighting or lit by an unknown type of flash or other light source.
Custom white balance	CWB	2000K – 14000K	After pressing the INFO button, use \triangleleft \triangleright buttons to select a color temperature and then press OK .

White balance color temperature

As their temperature increases, objects first start to shine red and then to shine blue as the temperature rises further. Color temperature expresses the color of light in this way using absolute temperatures in degrees K (kelvin).

- Fluorescent light sources indicated by white dots in the accompanying figure have colors that differ slightly from those on the color temperature scale; the values shown in the figure have been converted to color temperatures for illustrative purposes.

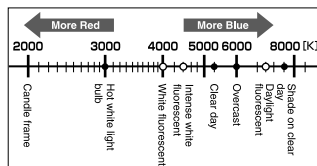







Tips

- Removing warm colors from pictures taken using auto white balance under incandescent lighting. [**WB** Keep Warm Color]:
Selecting [**WB**] for white balance only when the flash is used. [**WB** +WB]:
 "Customizing camera settings" (P. 81)

White balance compensation

This function lets you make fine changes to the auto WB and preset WB settings.

- 1 Select [WB] in  Custom Menu (P. 81) tab .
- 2 Select the option to be modified and press .
- 3 Select a slider with  and use   to choose the amount.

Adjusting the white balance in the A direction (Amber-Blue)

Higher values produce "warmer" (redder) tints, lower values "cooler" (bluer) tints.



Adjusting the white balance in the G direction (Green-Magenta)

Higher values produce greener tints, lower values tints that are more purple.



- 4 Press  to save settings and exit.

Tips

- To display a test photograph taken at the selected white balance value, press the  button.
- Adjusting all WB mode settings at once. [All **WB**]:  "Customizing camera settings" (P. 81)

One-touch white balance

Measure white balance by framing a piece of paper or other white object under the lighting that will be used in the final photograph. This is useful when shooting a subject under natural light, as well as under various light sources with different color temperatures.

- 1 Select [**1**] or [**2**] (one-touch white balance 1 or 2) and press the **INFO** button.
- 2 Photograph a piece of colorless (white or gray) paper.
 - Frame the object so that it fills the display and no shadows fall it.
 - The one-touch white balance screen appears.
- 3 Select [Yes] and press .
 - The new value is saved as a preset white balance option.
 - The new value is stored until one-touch white balance is measured again. Turning the power off does not erase the data.

Tips

- If the subject is too bright or too dark or visibly tinted, the message "WB NG Retry" will be displayed and no value will be recorded. Correct the problem and repeat the process from Step 1.

Processing options (picture mode)





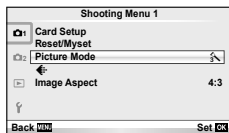





Select a picture mode and make individual adjustments to contrast, sharpness, and other parameters. Changes to each picture mode are stored separately.

- 1 Select [Picture Mode] in shooting menu  (P. 107).



- 2 Select an option with Δ ∇ and press \odot .

Picture modes

 i-Enhance	Produces more impressive-looking results suited to the scene.
 Vivid	Produces vivid colors.
 Natural	Produces natural colors.
 Muted	Produces flat tones.
 Portrait	Produces beautiful skin tones.
Monotone	Produces black and white tone.
Custom	Select one picture mode, set the parameters, and register the setting.
 Pop Art	Choose an art filter and select the desired effect.
 Soft Focus	
 Grainy Film	
 Pin Hole	
 Diorama	
 Dramatic Tone	

3 Press \blacktriangleright to display settings for the selected option.

Contrast	Distinction between light and dark	✓	✓	✓	✓
Sharpness	Sharpness of the image	✓	✓	✓	✓
Saturation	Vividness of the color	✓	✓	—	✓
Gradation	Adjust tone (gradation).				
Auto	Divides the image into detailed regions and adjusts the brightness separately for each region. This is effective for images with areas of large contrast in which the whites appear too bright or the blacks appear too dark.	✓	✓	✓	✓
Normal	Use [Normal] mode for general uses.				
High Key	Gradation for a bright subject.				
Low Key	Gradation for a dark subject.				
Effect (i-Enhance)	Sets the extent that the effect will be applied.	✓	—	—	✓
B&W Filter (Monotone)	Creates a black and white image. The filter color is brightened and the complementary color is darkened.				
N:Neutral	Creates a normal black and white image.				
Ye:Yellow	Reproduces clearly defined white cloud with natural blue sky.	—	—	✓	✓
Or:Orange	Slightly emphasizes colors in blue skies and sunsets.				
R:Red	Strongly emphasizes colors in blue skies and brightness of crimson foliage.				
G:Green	Strongly emphasizes colors in red lips and green leaves.				
Pict. Tone (Monotone)	Colors the black and white image.				
N:Neutral	Creates a normal black and white image.				
S:Sepia	Sepia	—	—	✓	✓
B:Blue	Bluish				
P:Purple	Purplish				
G:Green	Greenish				

Cautions

- Changes to contrast have no effect at settings other than [Normal].

Image quality (record mode)

Select an image quality for photographs and movies according to their intended use, for example retouching on a computer or display on the web.

Choosing a record mode

- 1 Display the live control (P. 22) and use $\Delta \nabla$ to choose a record mode for movies or photographs.
- 2 Select an option using $\triangleleft \triangleright$ and press \odot .



Record mode

Record modes (still images)

Choose from RAW and JPEG (**L**F, **M**N, **M**N, and **S**N) modes. Choose a RAW+JPEG option to record both a RAW and a JPEG image with each shot. JPEG modes combine image size (**L**, **M**, and **S**) and compression ratio (SF, F, N, and B). The options available can be selected using the $\left[\leftarrow \text{Set} \right]$ option in the custom menus. $\left[\text{Menu} \right]$ "Customizing camera settings" (P. 81)

Image size		Compression rate				Application
Name	Pixel count	SF (Super Fine)	F (Fine)	N (Normal)	B (Basic)	
L (Large)	4032×3024*	L SF	L F*	L N*	L B	Select for the print size
M (Middle)	3200×2400	M SF	M F	M N*	M B	
	2560×1920*					
	1920×1440					
1600×1200						
S (Small)	1280×960*	S SF	S F	S N*	S B	For small prints and use on a website
	1024×768					
	640×480					

* Default.

- The size of [**M**] and [**S**] images can be selected using the [Pixel Count] option in the custom menus. $\left[\text{Menu} \right]$ "Customizing camera settings" (P. 81)

RAW image data

This format (extension ".ORF") stores unprocessed image data for later processing. RAW image data can not be viewed using other cameras or software, and RAW images can not be selected for printing. JPEG copies of RAW images can be created using this camera.

$\left[\text{Menu} \right]$ "Editing still images" (P. 67)

■ Record modes (movies)

Record mode	Pixel count	Frame rate	File format	Application
Full HD Fine	1920×1080	59.94i ^{*2}	AVCHD ^{*1}	For viewing on AVCHD devices.
Full HD Normal	1920×1080	59.94i ^{*2}		
HD Fine	1280×720	59.94p ^{*2}		
HD Normal	1280×720	59.94p ^{*2}		
HD	1280×720	Approx. 30 fps ^{*3}	Motion JPEG ^{*4}	For computer playback or editing.
SD	640×480			

- Depending on the type of card used, recording may end before the maximum length is reached.

*1 Individual files can be up to 4 GB in size or 29 minutes in length.

*2 Image sensor output about 30 fps.

*3 The frame rate may drop when an art filter is used.

*4 Files may be up to 2 GB in size.

Setting the image aspect

You can change the aspect ratio (horizontal-to-vertical ratio) when taking pictures using live view. Depending on your preference, you can set the aspect ratio to [4:3] (standard), [16:9], [3:2], [6:6], or [3:4].

1 Display the live control (P. 22) and select the aspect ratio item using $\Delta \nabla$.

2 Use $\triangleleft \triangleright$ to select an aspect ratio and press OK .

! Cautions

- JPEG images are cropped to the selected aspect ratio; RAW images, however, are not cropped but are instead saved with information on the selected aspect ratio.
- When RAW images are played back, the selected aspect ratio is shown by a frame.

💡 Tips

- For information on cropping existing photographs or changing their aspect ratio, see "Editing still images" (P. 67).

ISO sensitivity

Increasing ISO sensitivity increases noise (graininess) but allows photographs to be taken when lighting is poor. The setting recommended in most situations is [AUTO], which starts at ISO 200 — a value that balances noise and dynamic range — and then adjusts ISO sensitivity according to shooting conditions.

1 Display the live control (P. 22) and select the ISO sensitivity item using $\Delta \nabla$.

2 Select an option using $\triangleleft \triangleright$ and press OK .



AUTO	The sensitivity is set automatically according to the shooting conditions.
200–12800	Sensitivity is set to the selected value.







Tips

- The default value and upper limit for auto ISO sensitivity can be selected using [ISO-Auto Set].
The options available for ISO sensitivity can be selected using [ISO Step].
Auto sensitivity can be enabled in **M** mode using [ISO-Auto].
 “Customizing camera settings” (P. 81)

Sequential shooting/using the self timer

The camera will take photos while the shutter button is pressed all the way down. Alternatively, the self-timer can be used for self- or group-portraits or to reduce camera shake when the camera is mounted on a tripod or otherwise fixed in place.

- 1 Press the  button (∇) to display the direct menu.
- 2 Select an option using \triangleleft and press .

 Single-frame shooting	Shoots 1 frame at a time when the shutter button is pressed (normal shooting mode).
 Sequential H	The camera will take photos at the selected frame rate while the shutter button is pressed all the way down. [ H fps] (P. 83)
 Sequential L	The camera will take photos at the selected frame rate while the shutter button is pressed all the way down. [ L fps] (P. 83)
 Self-timer 12 SEC	Press the shutter button halfway to focus, the rest of the way down to start the timer. First, the self-timer lamp lights up for approximately 10 seconds, then it blinks for approximately 2 seconds and the picture is taken.
 Self-timer 2 SEC	Press the shutter button halfway to focus, the rest of the way down to start the timer. The self-timer lamp blinks for approximately 2 seconds, and then the picture is taken.

Notes

- To cancel the activated self-timer, press the  button.
- In [S-AF] and [MF] focus modes, focus and exposure will be fixed at the values for the first frame in each sequence.

Cautions

- During sequential shooting, if the battery check blinks due to low battery, the camera stops shooting and starts saving the pictures you have taken on the card. The camera may not save all of the pictures depending on how much battery power remains.
- Fix the camera securely on a tripod for self-timer shooting.
- If you stand in front of the camera to press the shutter button halfway when using the self-timer, the photograph may be out of focus.

2 Other shooting options

“Point-and-shoot” photography (P program mode)

In mode **P**, the camera automatically adjusts shutter speed and aperture in response to subject brightness.

- 1 Select **P** as the shooting mode.
 -  “Choosing a Shooting Mode” (P. 12)

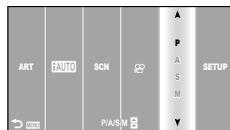

- 2 Take pictures.
 - The shutter speed and aperture selected by the camera are displayed in the monitor.

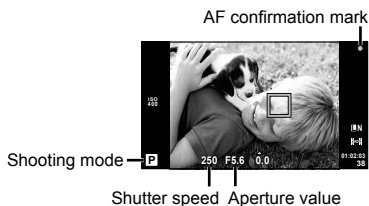

Program shift (Ps)

In **P** and **ART** modes, you can press the  button (Δ) and then use Δ ∇ to choose different combinations of aperture and shutter speed without altering exposure. This is known as “program shift.” “s” appears next to the shooting mode during program shift. To cancel program shift, press and hold Δ ∇ until “s” is no longer displayed or turn the camera off.



Program shift

⚠ Cautions

- Program shift is not available when you are using a flash.

⚠ Cautions

- The shutter speed and aperture displays flash if the camera is unable to achieve optimal exposure. See “Exposure warning display” (P. 103).

💡 Tips

- Using the control dial. [Lock]: Changing the roles of the control dial. [Dial Function]:
 “Customizing camera settings” (P. 81)

Choosing aperture (A aperture-priority mode)

In mode **A**, you choose the aperture and let the camera automatically adjust shutter speed for optimal exposure.

1 Select **A** as the shooting mode.

- "Choosing a Shooting Mode" (P. 12)

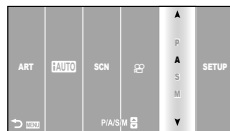

2 After pressing the button (Δ), use Δ ∇ to choose the aperture.

- Exposure compensation can also be adjusted using the control dial.



Aperture value

3 Take pictures.

- Larger apertures (lower f-numbers) decrease depth of field (the area in front of or behind the focus point that appears to be in focus), softening background details. Smaller apertures (higher f-numbers) increase depth of field.

When the aperture value (f-number) is decreased



When the aperture value (f-number) is increased

Preview function

The button can be used to preview depth of field. You can choose the function assigned to the button using the [Function] option in the custom menus. If [Preview] is selected, you can press and hold the button to stop aperture down to the selected value and preview depth of field (the distance behind and in front of the focus point that appears to be in focus) in the monitor. [Button Function]: "Customizing camera settings" (P. 81)

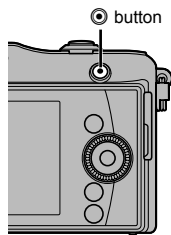

Tips

- Using the control dial to adjust aperture. [Lock]: Changing the roles of the control dial. [Dial Function]: "Customizing camera settings" (P. 81)

Choosing shutter speed (S shutter-priority mode)

In mode **S**, you choose the shutter speed and let the camera automatically adjust aperture for optimal exposure.

1 Select **S** as the shooting mode.

-  "Choosing a Shooting Mode" (P. 12)

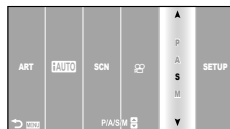

2 After pressing the button (Δ), use Δ ∇ to choose the shutter speed.

- Exposure compensation can also be adjusted using the control dial.



Shutter speed

3 Take pictures.

- A fast shutter speed can freeze a fast action scene without any blur. A slow shutter speed will blur a fast action scene. This blurring will give the impression of dynamic motion.

Fast shutter speed



Slow shutter speed

Tips

- Using the control dial to adjust shutter speed. [Lock]: Changing the roles of the control dial. [Dial Function]:  "Customizing camera settings" (P. 81)

Choosing aperture and shutter speed (M manual mode)

In mode **M**, you choose both the aperture and the shutter speed. Select a shutter speed of [BULB] for long exposures.

1 Select **M** as the shooting mode.

-  "Choosing a Shooting Mode" (P. 12)



2 Press the button (Δ) and use \triangleleft / \triangleright to set aperture and Δ / ∇ to choose a shutter speed.

- The shutter speed can be set to 1/4000 - 60 sec. or [BULB].

3 Take pictures.

Cautions

- Exposure compensation is not available in **M** mode.

Choosing when the exposure ends

Use for night landscapes and fireworks. In **M** mode, set the shutter speed to [BULB].

- [BULB] is displayed on the monitor.

Bulb photography (BULB): The shutter remains open while the shutter button is pressed. The exposure ends when the shutter button is released.

Tips

- Changing the roles of the control dial. [Dial Function]:
Ending the exposure automatically after a set time. [Bulb Timer]:
To fix the focus during manual focus shooting. [Bulb Focusing]:
 "Customizing camera settings" (P. 81)

Cautions

- To prevent blur, mount the camera on a tripod and use a remote cable (P. 102).
- The following can not be used:
Sequential shooting/self-timer shooting/AE bracket shooting/image stabilizer/
flash bracketing

Noise in images

While shooting at slow shutter speeds, noise may appear on-screen. These phenomena are caused when current is generated in those sections of the image pickup device that are not normally exposed to light, resulting in a rise in temperature in the image pickup device or image pickup device drive circuit. This can also occur when shooting with a high ISO setting in a high-temperature environment. To reduce this noise, the camera activates the noise reduction function. [Noise Reduct.]:  "Customizing camera settings" (P. 81)





Taking Panoramas

If you have installed the supplied computer software, you can use it to join pictures together to form a panorama.  "Using OLYMPUS Viewer 2/[ib]" (P. 73)

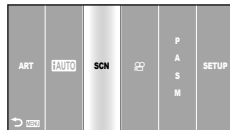
Taking pictures for a panorama

- 1 Select **SCN** as the shooting mode.
 -  "Choosing a Shooting Mode" (P. 12)



- 2 Select [Panorama] and press .
- 3 Use     to choose a pan direction.
- 4 Take a picture, using the guides to frame the shot.
 - Focus, exposure, and other settings are fixed at the values for the first shot.
- 5 Take the remaining images, framing each shot so that the guides overlap with the previous picture.





- A panorama may include up to 10 images. A warning indicator () is displayed after the tenth shot.

- 6 After taking the last shot, press  to end the series.

Cautions

- During panorama shooting, the image previously taken for position alignment will not be displayed. With the frames or other markers for display in the images as a guide, set the composition such that the edges of the overlapping images overlap within the frames.

Notes

- Pressing  before shooting the first frame returns to the scene mode selection menu. Pressing  in the midst of shooting ends the sequence of panorama shooting, and allows you to continue with the next one.

3D Photography

Take 3D photographs. The results can be viewed on devices that support 3D display. The camera monitor can not be used to view images in 3D.

- 1 Select **SCN** as the shooting mode.
 -  "Choosing a Shooting Mode" (P. 12)

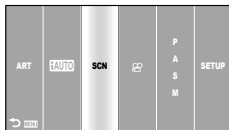

- 2 Select [3D Photo] and press **OK**.
- 3 Press the shutter button to take the first shot and keep the shutter button in this position.
 - Focus and exposure are locked at the values for the first shot.



- 4 Move the camera horizontally without rotation until the first shot is superimposed on your subject. The camera will take the second shot automatically.
 - If the camera does not take the second shot automatically or if you released the shutter button before the second shot was taken, press the shutter button all the way down again.
 - Do not adjust focus or zoom.
- 5 The two images are combined automatically.
 - If the camera displays the message [3D photo was not created.], take the photograph again. The two shots are saved to separate files.

Cautions

- Adjusting zoom after the first shot is taken cancels the first shot.
- The camera focuses on the subject in the center focus point only.
- Image size is fixed at 1920 × 1080.
- 3D and manual focus lenses can not be used.
- Depending on the lens and camera settings, the 3D effect may not be visible.
- The camera will not go to sleep during 3D photography.
- RAW photography is not available.
- Frame coverage is not 100%.

Notes

- Press **OK** to save the first shot and exit without recording a 3D image.

Recording multiple exposures in a single image (multiple exposure)

Record multiple exposures in a single image, using the option currently selected for image quality.

- 1 Select [Multiple Exposure] in shooting menu  (P. 107).
- 2 Adjust settings.

Frame	Select [2f].
Auto Gain	When set to [On], the brightness of each frame is set to 1/2 and the images are overlaid. When set to [Off], the images are overlaid with the original brightness of each frame.
Overlay	When set to [On], a RAW image recorded on a card can be overlaid with multiple exposures and stored as a separate image. The number of pictures taken is one.

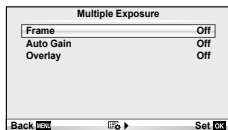



-  is displayed in the monitor while multiple exposure is in effect.

3 Take pictures.

-  is displayed in green when shooting starts.
- The previous shot is superimposed on the view through the lens as a guide to framing the next shot.



Tips

- To overlay 3 or more frames: Select RAW for [>] and use the [Overlay] option to make repeated multiple exposures.
- For more information on overlaying RAW images:  "Image overlay" (P. 68)

Cautions

- The camera will not go to sleep while multiple exposure is in effect.
- Photographs taken with other cameras can not be included in a multiple exposure.
- When [Overlay] is set to [On], the images displayed when a RAW image is selected are developed with the settings at the time of shooting.
- To set the shooting functions, cancel multiple exposure shooting first. Some functions cannot be set.
- Multiple exposure is cancelled automatically from the first picture in the following situations.
 - The camera is turned off/The  button is pressed/The **MENU** button is pressed/The shooting mode is set to a mode other than **P, A, S, M**/The battery power runs out/Any cable is connected to the camera/You switch between the monitor and electronic viewfinder
- When a RAW image is selected using [Overlay], the JPEG image for the image recorded in JPEG+RAW is displayed.
- When shooting multiple exposures using bracketing, priority is given to multiple exposure shooting. While the overlay image is being saved, bracketing is reset to the factory default setting.

Varying settings over a series of photographs (bracketing)

“Bracketing” refers to the act of varying settings automatically over a series of shots or a series of images to “bracket” the current value. Bracketing is available in **P**, **A**, **S**, and **M** modes.

1 Select [Bracketing] in shooting menu (P. 107).

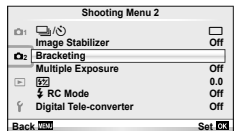

2 Choose a bracketing type.

- BKT** is displayed in the monitor.

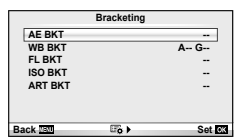

AE BKT (AE bracketing)

The camera varies exposure by 0.3EV, 0.7EV, or 1.0EV over three shots. In single-frame shooting mode, one photograph is taken each time the shutter button is pressed all the way down, while in sequential shooting mode the camera continues to take shots in the following order while the shutter button is pressed all the way down: no modification, negative, positive. Number of shots: 2, 3, 5, or 7

- The **BKT** indicator turns green during bracketing.
- The camera modifies exposure by varying aperture and shutter speed (mode **P**), shutter speed (modes **A** and **M**), or aperture (mode **S**).
- The camera brackets the value currently selected for exposure compensation.
- The size of the bracketing increment changes with the value selected for [EV Step]. “Customizing camera settings” (P. 81)

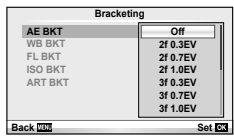

WB BKT (WB bracketing)

Three images with different white balances (adjusted in specified color directions) are automatically created from one shot, starting with the value currently selected for white balance.

- White balance can be varied by 2, 4, or 6 steps on each of the A-B (Amber-Blue) and G-M (Green-Magenta) axes.
- The camera brackets the value currently selected for white balance compensation.
- No pictures will be taken during WB bracketing if there is not enough memory on the card for the selected number of frames.

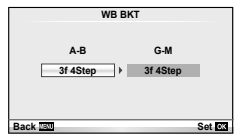

FL BKT (FL bracketing)

The camera varies flash level over three shots (no modification on the first shot, negative on the second, and positive on the third). In single-frame shooting, one shot is taken each time the shutter button is pressed; in sequential shooting, all shots are taken while the shutter button is pressed.

- The **BKT** indicator turns green during bracketing.
- The size of the bracketing increment changes with the value selected for [EV Step]. “Customizing camera settings” (P. 81)

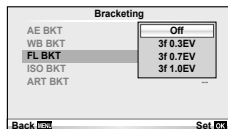

ISO BKT (ISO bracketing)

The camera varies sensitivity by 0.3EV, 0.7EV, or 1.0EV over three shots (no modification on the first shot, negative on the second, and positive on the third), bracketing the current sensitivity setting (or if auto sensitivity is selected, the optimal sensitivity setting) while keeping shutter speed and aperture fixed. In single-frame shooting, one shot is taken each time the shutter button is pressed; in sequential shooting, all shots are taken while the shutter button is pressed.

- The size of the bracketing increment does not change with the value selected for [ISO Step].
 “Customizing camera settings” (P. 81)
- Bracketing is performed regardless of the upper limit set with [ISO-Auto Set]. “Customizing camera settings” (P. 81)

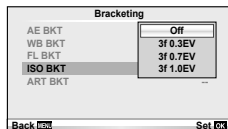

ART BKT (ART bracketing)

Each time the shutter is released, the camera records multiple images, each with a different art filter setting. You can turn art filter bracketing on or off separately for each picture mode.

- Recording may take some time.
- ART BKT can not be combined with WB BKT or ISO BKT.

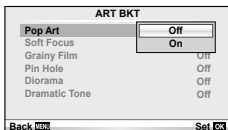

Digital Zoom (Digital Tele-converter)

Digital Tele-converter is used to zoom in beyond the current zoom ratio. The camera saves the center crop. Zoom is increased by about 2×.

- 1 Select [On] for [Digital Tele-converter] in Shooting menu (P. 107).
- 2 The view in the monitor will be enlarged by a factor of two.
 - The subject will be recorded as it appears in the monitor.

Cautions

- Digital zoom is not available with multiple exposures or when , , , , or is selected in **SCN** mode.
- When a RAW image is displayed, the area visible in the monitor is indicated by a frame.

3 Flash shooting



The flash can be set manually as required. The flash can be used for flash photography in a variety of shooting conditions.

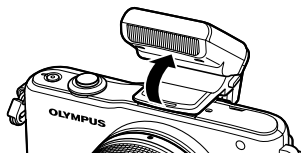

Using a flash (flash photography)

- 1 Attach the flash unit and raise the flash head.









-  "Attaching the flash unit" (P. 7)



- 2 Press the  button () to display options.

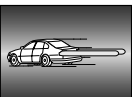

- 3 Use   to choose a flash mode and press .

- The options available and the order in which they are displayed vary depending on the shooting mode.  "Flash modes that can be set by shooting mode" (P. 104)

	AUTO Auto flash	The flash fires automatically in low light or backlight conditions.
	Fill-in flash	The flash fires regardless of the light conditions.
	Flash off	The flash does not fire.
	Red-eye reduction flash	This function allows you to reduce the red-eye phenomenon. In S and M mode, the flash always fires.
	Slow synchronization (1st curtain)	Slow shutter speeds are used to brighten dimly-lit backgrounds.
	Slow synchronization (1st curtain)/Red-eye reduction flash	Combines slow synchronization with red-eye reduction.
	Slow synchronization (2nd curtain)	The flash fires just before the shutter closes to create trails of light behind moving light sources. 
	Manual	For users who prefer manual operation.

- 4 Press the shutter button all the way.

Cautions

- In [ (Red-eye reduction flash)], after the pre-flashes, it takes about 1 second before the shutter is released. Do not move the camera until shooting is complete.
- [ (Red-eye reduction flash)] may not work effectively under some shooting conditions.
- When the flash fires, the shutter speed is set to 1/160 sec. or slower.
When shooting a subject against a bright background with the fill-in flash, the background may be overexposed.

Adjusting flash output (Flash intensity control)

Flash output can be adjusted if you find that your subject appears overexposed, or is underexposed even though the exposure in the rest of the frame is just right.

- 1 Display the live control (P. 22) and select the Flash intensity control item using Δ ∇ .
- 2 Choose the compensation value with \triangleleft \triangleright and press OK .



Tips

- For information on flash bracketing:  "FL BKT (FL bracketing)" (P. 58)

Cautions

- This setting has no effect when the flash control mode for the external flash unit is set to MANUAL.
- Changes to flash intensity made with the external flash unit are added to those made with the camera.
- When $[\text{FL}] + [\text{FL}]$ is set to [On], the flash intensity value will be added to the exposure compensation value.  "Customizing camera settings" (P. 81)

Using external flash units designated for use with this camera

Optional external flash units designated for use with this camera support a wide variety of options for flash photography, including automatic flash control, super FP, and wireless flash control (P. 93).

Other external flash units

Note the following when using a third-party flash unit mounted on the camera hot shoe:

- Using obsolete flash units that apply currents of more than about 24 V to the camera hot shoe X-contact will damage the camera.
- Connecting flash units with signal contacts that do not conform to Olympus specifications may damage the camera.
- Use only with the camera in shooting mode **M** at shutter speeds slower than 1/160s and at ISO settings other than [AUTO].
- Flash control can only be performed by manually setting the flash to the ISO sensitivity and aperture values selected with the camera. Flash brightness can be adjusted by adjusting either ISO sensitivity or aperture.
- Use a flash with an angle of illumination suited to the lens. Angle of illumination is usually expressed using 35-mm format equivalent focal lengths.

4 Shooting and viewing movies

Use the **Ⓞ** button to record High Definition (HD) movies with sound. In movie mode, you can create movies that take advantage of the effects available in modes **A** and **M**.

Changing the settings for movie recording

Adding effects to a movie

- 1 Select **📷** as the shooting mode.
 - **👉** "Choosing a Shooting Mode" (P. 12)
- 2 Display the live control (P. 22) and use **△ ▽** to highlight the shooting mode.
- 3 Use **◀ ▶** to choose a mode and press **Ⓞ**.



P	Optimal aperture is set automatically according to the brightness of the subject.
A	Depiction of background is changed by setting the aperture. Use ◀ ▶ to adjust the aperture.
S	Shutter speed affects how the subject appears. Use △ ▽ to adjust shutter speed. Shutter speed can be set to values between 1/30 s and 1/4000 s.
M	You control both aperture and shutter speed. Use ◀ ▶ to choose the aperture, △ ▽ to select the shutter speed from values between 1/30 s and 1/4000 s. Sensitivity can be set manually to values between ISO 400 and 1600; auto ISO sensitivity control is not available.
ART1-ART6	Movie can be recorded with effects of art filter mode. 👉 "Using art filters" (P. 18)

! Cautions

- When recording a movie, you cannot change the settings for exposure compensation, aperture value, and shutter speed.
- If [Image Stabilizer] is activated while recording a movie, the recorded image is enlarged slightly. Even if [Vertical IS] or [Horizontal IS] is selected, the setting for [Auto] is applied.
- Stabilization is not possible when the camera shake is excessive.
- When using a lens with the image stabilizer function, turn off the image stabilizer function of either the lens or the camera.
- When the inside of the camera becomes hot, shooting is automatically stopped to protect the camera.
- With some art filters, [C-AF] operation is limited.
- Cards with an SD speed class of 6 or above are recommended for movie recording.

Movie sound options (recording sound with movies)

- 1 Display the live control (P. 22) and select the Movie  item using Δ ∇ .
- 2 Switch ON/OFF using \triangleleft \triangleright and press \odot .

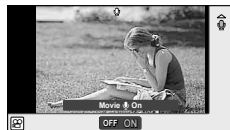

Cautions

- When recording sound in a movie, the sound made by the lens and camera operating may be recorded. If desired, you can reduce these sounds by shooting with [AF Mode] set to [S-AF], or by limiting the amount of times you press the buttons.
- No sound is recorded in [ART5] (Diorama) mode.

4



Viewing movies

- 1 Display a movie in single-frame playback and press \odot .
- 2 Select [Movie Play] using Δ ∇ and press \odot to begin playback.
 - The following operations can be performed during movie playback:



\odot	Pause or resume playback. <ul style="list-style-type: none">• While playback is paused, press Δ to display the first frame and press ∇ to display the last frame. Press \triangleleft \triangleright to rewind or advance one frame. Press and hold the button to rewind or advance in succession.	
\triangleleft \triangleright	Advance or rewind a movie.	
Δ ∇	Adjust volume.	

Tips

- Recording movies with the shutter button:  "Recording movies with the shutter button" (P. 92)
- Reducing wind noise:  "Microphone set (SEMA-1)" (P. 102)

5 Playback options









Single-frame playback

Press the  button to view pictures full frame.



- To exit to shooting mode, press the shutter button halfway.

The following operations can be performed in full-frame playback.

	View other pictures.
	Zoom in on pictures (P. 16).
	View Index display.
INFO	View information on the current picture (P. 33).
	Select pictures. Selected pictures are shown by  .
	Display the menus. JPEG Edit, RAW Data Edit,  ,  , Rotate,  , Erase

Tips

- Changing the roles of the control dial. [Dial Function]:
 “Customizing camera settings” (P. 81)

Index display/calendar display

■ Index display

To view multiple pictures, press  in full-frame playback.

■ Calendar display

Display the first picture taken on each date.

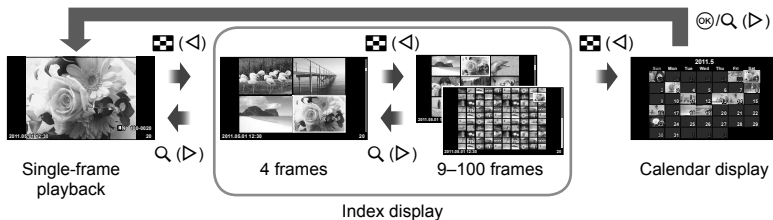

Only items for which [On] is selected are displayed. [Checkered Flag/Info Settings]:

[Magnifying Glass] "Customizing camera settings" (P. 81)

	Increase the number of pictures displayed from 4 to 9, 25, or 100. Press again to view the calendar display.
	Decrease the number of pictures displayed from 100 to 25, 9, or 4. Press again to view the current image full frame.
	Select a picture.
	Select pictures. Selected pictures are shown by .
	Index display The menus are displayed. Calendar display View the pictures taken on the selected date full frame.

Tips

- Changing the roles of the control dial. [Dial Function]:
[Magnifying Glass] "Customizing camera settings" (P. 81)

Playback zoom (close-up playback)

Zoom images in or out.

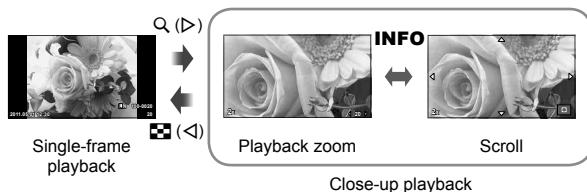

	Select a picture.
	Zoom increases each time the button is pressed, to a maximum of 14x.
INFO	Use to view other areas of the frame.

Selecting images

Select multiple pictures for protection or deletion. Press the **OK** button to select the current picture. Selected pictures are marked with **✓**. To remove **✓** and deselect the picture, press the **OK** button again.

- Multiple pictures can be selected in index playback.



Canceling all protections

This function lets you cancel the protection of several images at one time.

- 1 Select [Reset Protect] in the **▶** (playback) menu (P. 107).
- 2 Select [Yes] and press **OK**.

All-frame erase

Erase all images on the memory card.

- 1 Select [Card Setup] in shooting menu **⚙** (P. 107).
- 2 Select [All Erase] and press **OK**.
 - The [Format] option (P. 99) can be used to delete non-image data.
- 3 Select [Yes] and press **OK**.

Rotate

Choose whether to rotate photographs.

- 1 Play the photograph back and press **OK**.
- 2 Select [Rotate] and press **OK**.
- 3 Press **△** to rotate the image counterclockwise, **▽** to rotate it clockwise; the image rotates each time the button is pressed.
 - Press **OK** to save settings and exit.
 - The rotated image is saved in its current orientation.
 - Movies, 3D photos, and protected images can not be rotated.

Slideshow

This function displays images stored on the card one after another.

- 1 Press **OK** during playback and select the slideshow option.

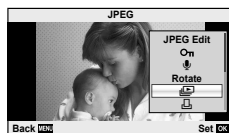

- 2 Adjust settings.

Start	Start the slideshow. Images are displayed in order, starting with the current picture.
BGM	Set BGM (4 types) or turn BGM [Off].
Effect*	Choose the transition between frames. This option can be used when slideshows are displayed on external devices using HDMI.
Slide	Set type of slideshow to execute.
Slide Interval	Choose the length of time each slide is displayed from 2 to 10 seconds.
Movie Interval	Select [Full] to include full-length movie clips in the slideshow, [Short] to include only the opening portion of each clip.

* Movies are not displayed when an effect other than [Fade] is selected.

- 3 Select [Start] and press **OK**.
 - The slideshow will start.
 - Press **OK** to stop the slideshow.

Volume

Press **Δ**/**∇** during the slideshow to adjust the overall volume of the camera speaker.
Press **<**/**>** to adjust the balance between the background music and the sound recorded with photographs or movies.

Editing still images

Recorded images can be edited and saved as new images.

- 1 Display the image to be edited and press **OK**.
 - [RAW Data Edit] is displayed if the picture is a RAW image, [JPEG Edit] if it is a JPEG image. If the image was recorded in RAW+JPEG format, the copy that will be edited is determined by your choice of [Edit] option.
- 2 Select [RAW Data Edit] or [JPEG Edit] and press **OK**.

RAW Data Edit	Create a JPEG copy of a RAW image. The JPEG copy is processed using the settings currently stored in the camera. Adjust camera settings before choosing this option.
JPEG Edit	<p>Choose from the following options:</p> <p>[Shadow Adj]: Brightens a dark backlit subject.</p> <p>[Redeye Fix]: Reduces the red-eye phenomenon during flash shooting.</p> <p>[CROP]: Use the control dial to choose the size of the crop and $\Delta \nabla \triangleleft \triangleright$ to position the crop.</p> 

! Cautions

- Movies and 3D photos can not be edited.
- Red-eye correction may not work depending on the image.
- Editing of a JPEG image is not possible in the following cases:
 - When an image is recorded in RAW, when an image is processed on a PC, when there is not enough space in the card memory, when an image is recorded on another camera.
- When resizing (**[ZOOM]**) an image, you cannot select a larger number of pixels than was originally recorded.
- **[CROP]** and [Aspect] can only be used to edit images with an aspect ratio of 4:3 (standard).

Image overlay

Up to 3 frames of RAW images taken with the camera can be overlaid and saved as a separate image. The image is saved with the record mode set at the time the image is saved. (If [RAW] is selected, the copy will be saved in [L+N+RAW] format.)

- 1 With a RAW image displayed during playback, press **OK** and select [Image Overlay].
- 2 Select the number of images in the overlay and press **OK**.
- 3 Use **Δ** **▽** **◀▶** to select the RAW images that will be used in the overlay and press **OK** to select.
 - When you have selected the number of images specified in Step 2, the overlay will be displayed.
- 4 Adjust gain.
 - Use **◀▶** to select an image and use **Δ** **▽** to adjust gain.
 - Gain can be adjusted in the range 0.1–2.0. Check the results in the monitor.
- 5 Press **OK**. A confirmation dialog will be displayed; select [Yes] and press **OK**.

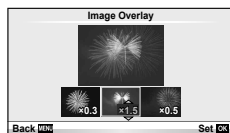

Tips

- To overlay 4 or more frames, save the overlay image as a RAW file and use [Image Overlay] repeatedly.

Audio recording

Add an audio recording (up to 30sec. long) to the current photograph.

- 1 Display the image to which you want to add an audio recording and press **OK**.
 - Audio recording is not available with protected images.
 - Audio recording is also available in the playback menu.
- 2 Select **[M]** and press **OK**.
 - To exit without adding a recording, select [No].
- 3 Select **[M] Start** and press **OK** to begin recording.
 - To stop recording part-way through, press **OK**.
- 4 Press **OK** to end recording.
 - Images with audio recordings are indicated by a **M** icon.
 - To delete a recording, select [Erase] in Step 2.

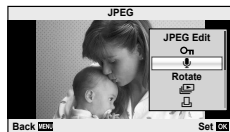

Viewing camera images on TV

Use the AV cable provided with the camera to playback recorded images on your TV. You can playback high-definition images on a high-definition TV by connecting it to the camera using a commercially available HDMI cable.

■ Connection via AV cable

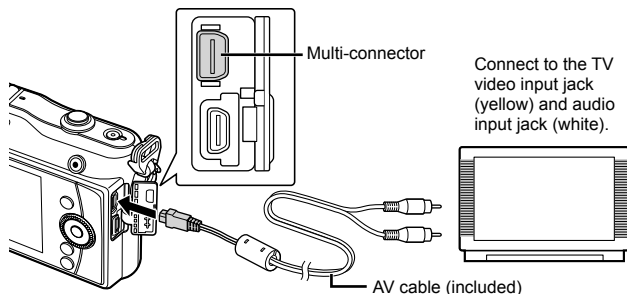

- 1 Use the camera to select the video signal format that matches that of the connected TV ([NTSC]/[PAL]).
 - [Video Out]: "Customizing camera settings" (P. 81)
- 2 Connect the TV and camera.
- 3 Turn on the TV, and change "INPUT" to "VIDEO" (an input jack connected to the camera).

! Cautions

- The camera's monitor turns off automatically when the AV cable is connected to the camera.
- Press the button when connecting via an AV cable.
- For details on changing the input source of the TV, refer to the TV's instruction manual.
- Depending on the TV's settings, the displayed images and information may become cropped.

■ Connection via HDMI cable

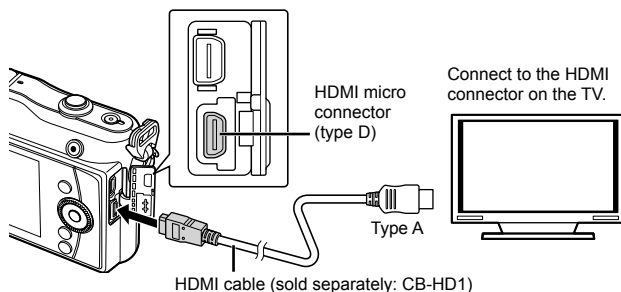

- 1 Connect the camera to the TV using the HDMI cable.
- 2 Turn on the TV and switch "INPUT" to "HDMI INPUT".
- 3 Turn on the camera.

Cautions



- For details on changing the input source of the TV, refer to the TV's instruction manual.
- When the camera and TV are connected by both an AV cable and an HDMI cable, HDMI will take priority.
- Depending on the TV's settings, the displayed images and information may become cropped.
- When you connect to a TV via an HDMI cable, you can select the format of the digital video signal. Choose a format that matches the input format selected with the TV. [HDMI]:  "Customizing camera settings" (P. 81)

1080i	Priority is given to 1080i HDMI output.
720p	Priority is given to 720p HDMI output.
480p/576p	480p/576p HDMI output. 576p is used when [PAL] is selected for [Video Out].

- You cannot shoot pictures or movies when the HDMI cable is connected.
- Do not connect the camera to other HDMI output devices. Doing so may damage the camera.
- HDMI output is not performed while connected via USB to a computer or printer.

Using the TV remote control

The camera can be operated by a TV remote control when connected to a TV that supports HDMI control.

- 1 Select [HDMI] in  Custom Menu (P. 81) tab .
- 2 Select [HDMI Control] and choose [On].
- 3 Operate the camera by using the TV remote control.
 - You can operate the camera by following the operation guide displayed on the TV.
 - During single-frame playback, you can display or hide the information display by pressing the "Red" button, and display or hide the index display by pressing the "Green" button.
 - Some televisions may not support all features.

6 Sending and receiving images

The optional OLYMPUS PENPAL can be used to upload pictures to, and receive pictures from, Bluetooth devices or other cameras connected to an OLYMPUS PENPAL. Visit the OLYMPUS website for more information on Bluetooth devices. Before sending or receiving images, select [On] for [*/ Menu Display] > [Menu Display] to make the accessory port menu accessible.

Sending images

Resize and upload JPEG images to another device. Before sending images, make sure that the receiving device is set to the mode for receiving data.

- 1 Display the picture you wish to send full frame and press **OK**.
- 2 Select [Send A Picture] and press **OK**.
 - Select [Search] and press **OK** in the next dialog. Bluetooth devices in range, or in [Address Book] will be displayed.
- 3 Select the destination and press **OK**.
 - The image will be uploaded to the receiving device.
 - If prompted to provide a PIN code, enter 0000 and press **OK**.

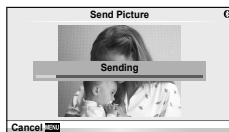
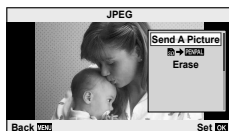

Receiving images/adding a host

Connect to the transmitting device and download JPEG images.

- 1 Select [OLYMPUS PENPAL Share] in the **PA** tab of the accessory port menu (P. 90).
- 2 Select [Please Wait] and press **OK**.
 - Perform operations for sending images on the sending device.
 - Transmission will start and a [Receive Picture Request] dialog will be displayed.
- 3 Select [Accept] and press **OK**.
 - The image will be downloaded to the camera.
 - If prompted to provide a PIN code, enter 0000 and press **OK**.

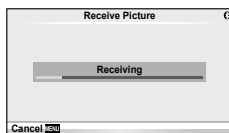
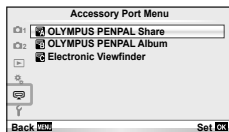

Tips

- To resize images to be transmitted or choose how long the camera searches for a destination: **Menu** "Customizing camera settings" (P. 81)

Editing the address book

The OLYMPUS PENPAL can store host information. You can assign names to hosts or delete host information.

- 1 Select [OLYMPUS PENPAL Share] in the  tab of the accessory port menu (P. 90).
 - Press \triangleright and select [Address Book].

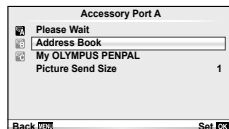

- 2 Select [Address List] and press \odot .
 - The names of existing hosts are listed.
- 3 Select the host you wish to edit and press \odot .

Deleting hosts

Select [Yes] and press \odot .

Editing host information

Press \odot to display host information. To change the host name, press \odot again and edit the current name in the rename dialog.

Creating albums

Your favorite JPEG pictures can be resized and copied to an OLYMPUS PENPAL.

- 1 Display the picture you wish to copy full frame and press \odot .
- 2 Select [$Sb \rightarrow$ PENPAL] and press \odot .
 - To copy images from an OLYMPUS PENPAL to the memory card, select [PENPAL \rightarrow Sb] and press \odot .

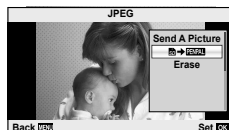

Tips

- Choosing the size at which images are copied. [Picture Copy Size]: Copying all images from the memory card. [Copy All]; Deleting or formatting albums. [Album Mem. Setup]; Removing protection from all images in the album. [Reset Protect]; Viewing album status (amount of memory remaining). [Album Mem. Usage];  "Customizing camera settings" (P. 81)



Cautions

- The OLYMPUS PENPAL can be used only in the region in which it was purchased. Depending on the areas, the usage may infringe the wave regulations and may be subject to its penalty.

7 Using OLYMPUS Viewer 2/[ib]

Windows

- 1 Insert the supplied CD in a CD-ROM drive.

Windows XP

- A "Setup" dialog will be displayed.

Windows Vista/Windows 7

- An Autorun dialog will be displayed. Click "OLYMPUS Setup" to display the "Setup" dialog.



! Caution

- If the "Setup" dialog is not displayed, select "My Computer" (Windows XP) or "Computer" (Windows Vista/Windows 7) from the start menu. Double-click the CD-ROM (OLYMPUS Setup) icon to open the "OLYMPUS Setup" window and then double-click "LAUNCHER.EXE".
- If a "User Account Control" dialog is displayed, click "Yes" or "Continue".

- 2 Follow the on-screen instructions on your computer.

! Caution

- If nothing is displayed on the camera screen even after connecting the camera to the computer, the battery may be exhausted. Use a full-charged battery.

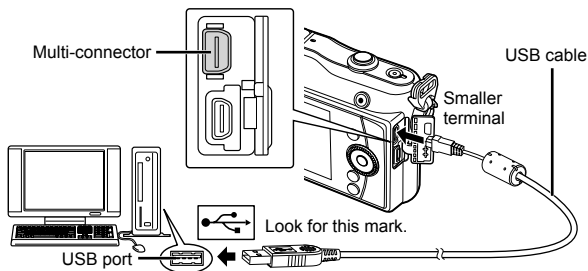

! Caution

- When the camera is connected to another device via USB, a message will be displayed prompting you to choose a connection type. Select [Storage].

- 3 Register your Olympus product.

- Click the "Registration" button and follow the on-screen instructions.

- 4 Install OLYMPUS Viewer 2 and [ib] computer software.

- Check the system requirements before beginning installation.
- Click the "OLYMPUS Viewer 2" or "OLYMPUS [ib]" button and follow the on-screen instructions to install the software.

OLYMPUS Viewer 2	
Operating System	Windows XP (Service Pack 2 or later)/Windows Vista/ Windows 7
Processor	Pentium 4 1.3 GHz or better (Pentium D 3.0 GHz or better required for movies)
RAM	1 GB or more (2 GB or more recommended)
Free Hard Drive Space	1 GB or more
Monitor Settings	1024 × 768 pixels or more Minimum 65,536 colors (16,770,000 colors recommended)

[ib]	
Operating System	Windows XP (Service Pack 2 or later)/Windows Vista/ Windows 7
Processor	Pentium 4 1.3 GHz or better (Pentium D 3.0 GHz or better required for movies)
RAM	512 MB or more (1 GB or more recommended) (1 GB or more required for movies—2 GB or more recommended)
Free Hard Drive Space	1 GB or more
Monitor Settings	1024 × 768 pixels or more Minimum 65,536 colors (16,770,000 colors recommended)
Graphics	A minimum of 64 MB video RAM with DirectX 9 or later.

- See online help for information on using the software.

Macintosh

- 1 Insert the supplied CD in a CD-ROM drive.
 - The disk contents should automatically be displayed in the Finder. If they are not, double-click the CD icon on the desktop.
 - Double-click the “Setup” icon to display the “Setup” dialog.
- 2 Install OLYMPUS Viewer 2.
 - Check the system requirements before beginning installation.
 - Click the “OLYMPUS Viewer 2” button and follow the on-screen instructions to install the software.



OLYMPUS Viewer 2	
Operating System	Mac OS X v10.4.11–v10.6
Processor	Intel Core Solo/Duo 1.5 GHz or better
RAM	1 GB or more (2 GB or more recommended)
Free Hard Drive Space	1 GB or more
Monitor Settings	1024 × 768 pixels or more Minimum 32,000 colors (16,770,000 colors recommended)

- Other languages can be selected from the language combo box. For information on using the software, see online help.
- You can make user registration via "Registration" in OLYMPUS Viewer 2 "Help".

! Cautions

- AVCHD movie file format is not supported.

Copying pictures to a computer without OLYMPUS Viewer 2/[ib]

Your camera supports the USB Mass Storage Class. You can transfer images to a computer by connecting the camera to the computer with the supplied USB cable. The following operating systems are compatible with the USB connection:

Windows: Windows XP Home Edition/
Windows XP Professional/
Windows Vista/Windows 7

Macintosh: Mac OS X version 10.3 or later

1 Turn the camera off and connect it to the computer.

- The location of the USB port varies with the computer. For details, refer to your computer's manual.

2 Turn on the camera.

- The selection screen for the USB connection is displayed.

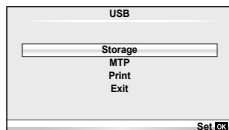

3 Press Δ ∇ to select [Storage]. Press OK .

4 The computer recognizes the camera as a new device.

! Cautions

- If your computer is running Windows Vista/Windows 7, select [MTP] in Step 3 to use Windows Photo Gallery.
- Data transfer is not guaranteed in the following environments, even if your computer is equipped with a USB port.
 - Computers with a USB port added by means of an extension card, etc.
 - Computers without a factory-installed OS and home-built computers
- Camera controls can not be used while the camera is connected to a computer.
- If the dialog shown in Step 2 is not displayed when the camera is connected, select [Auto] for [USB Mode] in the camera custom menus. "Customizing camera settings" (P. 81)

Print reservation (DPOF*)

You can save digital “print orders” to the memory card listing the pictures to be printed and the number of copies of each print. You can then have the pictures printed at a print shop that supports DPOF or print the pictures yourself by connecting the camera directly to a DPOF printer. A memory card is required when creating a print order.

- * DPOF (Digital Print Order Format) is a standard for recording the data that a printer or print service requires to automatically print pictures.

Creating a print order

- 1 Press **OK** during playback and select **[]**.

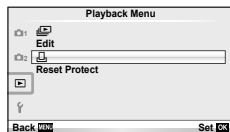

- 2 Select **[]** or **[ALL]** and press **OK**.

Individual pictures

Press **<>** to select the frame that you want to set as print reservation, then press **△▽** to set the number of prints.

- To set print reservation for several pictures, repeat this step. Press **OK** when all the desired pictures have been selected.

All pictures

Select **[ALL]** and press **OK**.

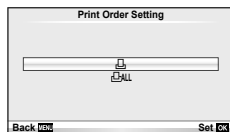

- 3 Select the date and time format and press **OK**.

No	The pictures are printed without the date and time.
Date	The pictures are printed with the shooting date.
Time	The pictures are printed with the shooting time.

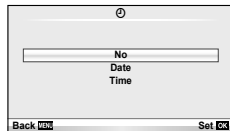

- 4 Select **[Set]** and press **OK**.

! Cautions

- The camera can not be used to modify print orders created with other devices. Creating a new print order deletes any existing print orders created with other devices.
- Not all functions may be available on all printers or at all photo labs.
- Print orders can not include 3D photos, RAW images, or movies.
- When requesting prints without a digital print order, specify the file number. Requesting prints by frame number may result in the wrong pictures being printed.

Removing all or selected pictures from the print order

You can reset all print reservation data or just the data for selected pictures.

- 1 Press **OK** during playback and select **[]**.
- 2 Select **[]** and press **OK**.
 - To remove all pictures from the print order, select **[Reset]** and press **OK**.
To exit without removing all pictures, select **[Keep]** and press **OK**.
- 3 Press **<>** to select images you wish to remove from the print order.
 - Use **∇** to set the number of prints to 0. Press **OK** once you have removed all the desired pictures from the print order.
- 4 Select the date and time format and press **OK**.
 - This setting is applied to all frames with print reservation data.
- 5 Select **[Set]** and press **OK**.

Direct printing (PictBridge)

By connecting the camera to a PictBridge-compatible printer with the USB cable, you can print out recorded pictures directly.

- 1 Connect the camera to the computer using the supplied USB cable and turn the camera on.

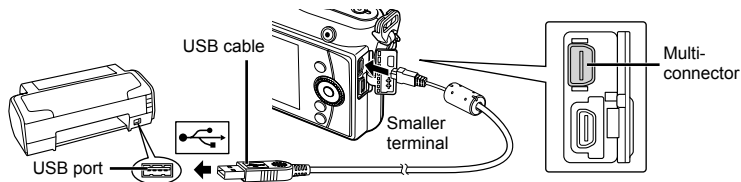

- Use a fully charged battery for printing.
- When the camera is turned on, a dialog should be displayed in the monitor prompting you to choose a host. If it is not, select **[Auto]** for **[USB Mode]** in the camera custom menu. **☞** "Customizing camera settings" (P. 81)

- 2 Use **Δ ∇** to select **[Print]**.
 - **[One Moment]** will be displayed, followed by a print-mode selection dialog.
 - If the screen is not displayed after a few minutes, disconnect the USB cable and start again from Step 1.

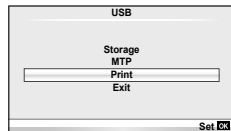

Proceed to "Custom printing" (P. 78).

! Cautions

- 3D photos, RAW images, and movies can not be printed.

Easy printing

Use the camera to display the picture you wish to print before connecting the printer via the USB cable.

- 1 Use \triangleleft \triangleright to display the pictures you want to print on the camera.
- 2 Press \triangleright .
 - The picture selection screen appears when printing is completed. To print another picture, use \triangleleft \triangleright to select the image and press \odot .
 - To exit, unplug the USB cable from the camera while the picture selection screen is displayed.

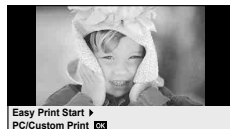

Custom printing

- 1 Follow the operation guide to set a print option.

Selecting the print mode

Select the type of printing (print mode). The available print modes are as shown below.

Print	Prints selected pictures.
All Print	Prints all the pictures stored in the card and makes one print for each picture.
Multi Print	Prints multiple copies of one image in separate frames on a single sheet.
All Index	Prints an index of all the pictures stored in the card.
Print Order	Prints according to the print reservation you made. If there is no picture with print reservation, this is not available.

Setting the print paper items

This setting varies with the type of printer. If only the printer's STANDARD setting is available, you cannot change the setting.

Size	Sets the paper size that the printer supports.
Borderless	Selects whether the picture is printed on the entire page or inside a blank frame.
Pics/sheet	Selects the number of pictures per sheet. Displayed when you have selected [Multi Print].

Selecting pictures you want to print



Select pictures you want to print. The selected pictures can be printed later (single-frame reservation) or the picture you are displaying can be printed right away.



Print (OK)	Prints the currently displayed picture. If there is a picture that [Single Print] reservation has already been applied to, only that reserved picture will be printed.
Single Print (▲)	Applies print reservation to the currently displayed picture. If you want to apply reservation to other pictures after applying [Single Print], use < > to select them.
More (▼)	Sets the number of prints and other items for the currently displayed picture, and whether or not to print it. For operation, refer to "Setting printing data" in the next section.

Setting printing data

Select whether to print printing data such as the date and time or file name on the picture when printing. When the print mode is set to [All Print] and [Option Set] is selected, the following options appears.

 x	Sets the number of prints.
Date	Prints the date and time recorded on the picture.
File Name	Prints the file name recorded on the picture.
	Trims the picture for printing. Use the control dial to choose the crop size and ▲ ▼ < > to position the crop.

2 Once you have set the pictures for printing and printing data, select [Print], then press **OK**.

- To stop and cancel printing, press **OK**. To resume printing, select [Continue].

■ Cancelling printing

To cancel printing, highlight [Cancel] and press **OK**. Note that any changes to the print order will be lost; to cancel printing and return to the previous step, where you can make changes to the current print order, press **MENU**.



9 Camera setup

Setup Menu

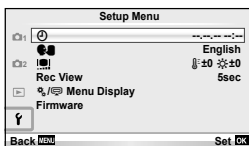

Use the Setup Menu to set the basic camera functions. For details on using the menu lists, see “Using the menus” (P. 23).





















Option	Description	
(Date/time setting)	Set the camera clock.	9
(Changing the display language)	You can change the language used for the on-screen display and error messages from English to another language.	—
(Monitor brightness adjustment)	You can adjust the brightness and color temperature of the monitor. Color temperature adjustment will affect only the monitor display during playback. Use $\leftarrow\right> \rightarrow$ to highlight (color temperature) or (brightness) and $\Delta \nabla$ to adjust the value. For information on adjusting the brightness and color temperature of the electronic viewfinder, see [EVF Adjust] (P. 90).	—
Rec View	Choose whether pictures are displayed immediately after shooting and for how long. This is useful for making a brief check of the picture you have just taken. Pressing the shutter button halfway while checking the picture lets you resume shooting immediately. [1sec]–[20sec]: Selects the number of seconds to display each picture. Can be set in units of 1 second. [Off]: The picture being recorded to the card is not displayed. [Auto]: Displays the image being recorded, and then switches to playback mode. This is useful for erasing a picture after checking it.	—
Menu Display	Choose whether to display the custom menus or accessory port menu.	81
Firmware	Your product's firmware version will be displayed. When you make inquiries about your camera or accessories or when you want to download software, you will need to state which version of each of the products you are using.	—

Camera settings can be customized using the custom and accessory menus. The  Custom menu is used to fine-tune camera settings. The  Accessory Port menu is used to adjust settings for accessory port devices.

Before Using the Custom/Accessory Port Menus

The Custom and Accessory Port menus are only available when the appropriate option is selected for the [/ Menu Display] item in the setup menu.

- 1 Press the **MENU** button to display the top menu.
- 2 Select [SETUP] using   and press .
- 3 Select the  setup menu tab (P. 80) using   and press .
- 4 Select [/ Menu Display] using   and press .
- 5 Select the desired menu using   and press .
- 6 Select [On] using   and press .
 - The selected menu will be displayed.

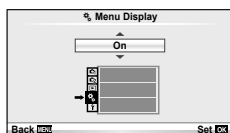
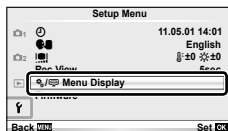

Custom Menu options

AF/MF

MENU →  → 

Option	Description	
AF Mode	Choose the AF mode.	36
Full-time AF	If [On] is selected, the camera will continue to focus even when the shutter button is not pressed halfway.	—
AF Area	Choose the AF target mode.	37
Reset Lens	When set to [On], this resets the focus of the lens (infinity) each time the power is turned off.	—
Bulb Focusing	Normally focus locks during the exposure when manual focus (MF) is selected. Select [On] to allow focusing using the focus ring.	—

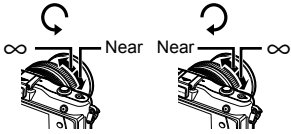
Option	Description	👉
Focus Ring	You can customize how the lens adjusts to the focal point by selecting the rotational direction of the focus ring. 	—
MF Assist	Select [On] to automatically magnify the image for precise focus when the focus ring is rotated in manual focus mode.	—
[•••] Set Home	Choose the AF target position that will be saved as the home position. [HP] appears in the AF target selection display while you choose a home position.	—
AF Illuminat.	Select [Off] to disable the AF illuminator.	—
☺ Face Priority	The camera gives priority to the faces or pupils of human portrait subjects during focusing. The camera zooms in on faces during close-up playback.	39

Button/Dial

Option	Description	👉										
AEL/AFL	Assign focus or AE lock to the Ⓞ button when the button function is set to [AEL/AFL].	88										
AEL/AFL Memo	If [Off] is selected, exposure will lock only while the button is pressed.	41										
Button Function	Choose the function assigned to the selected button.	—										
Ⓞ Function	AEL/AFL, Ⓞ REC, Preview, 📷, [•••] Home, MF, RAW ⚡, Test Picture, Myset, Backlit LCD, 📷/📷, Live Guide, Digital Tele-converter, Q, Off	89										
▶ Function	📷, ⚡, 📷, ISO, WB, Ⓞ Lock, 📷/📷	—										
▽ Function		—										
Dial Function	Choose the role played by the control dial. <table border="1" data-bbox="315 933 733 1064"> <tbody> <tr> <td>P</td> <td>📷 / Ps</td> </tr> <tr> <td>A</td> <td>Aperture value / 📷</td> </tr> <tr> <td>S</td> <td>Shutter speed / 📷</td> </tr> <tr> <td>M</td> <td>Shutter speed / Aperture value</td> </tr> <tr> <td>▶</td> <td>📷 Q / Prev/Next</td> </tr> </tbody> </table> <p>In P, A, S, and M modes, the roles played before and after 📷 is pressed are reversed.</p>	P	📷 / Ps	A	Aperture value / 📷	S	Shutter speed / 📷	M	Shutter speed / Aperture value	▶	📷 Q / Prev/Next	—
P	📷 / Ps											
A	Aperture value / 📷											
S	Shutter speed / 📷											
M	Shutter speed / Aperture value											
▶	📷 Q / Prev/Next											
Dial Direction	Choose the direction in which the dial is rotated to adjust shutter speed or aperture or to move the cursor.	—										
Ⓞ Lock	If [Off] is selected, exposure compensation and other settings can be adjusted by rotating the control dial without pressing the 📷 button.	—										

Option	Description	
Rls Priority S	If [On] is selected, the shutter can be released even when the camera is not in focus. This option can be set separately for S-AF (P. 36) and C-AF (P. 36) modes.	—
Rls Priority C		
H fps	Choose the frame advance rates for and . Figures are the approximate maximums.	49
L fps		





Option	Description																																			
HDMI	[HDMI Out]: Selecting the digital video signal format for connecting to a TV via an HDMI cable. [HDMI Control]: Select [On] to allow the camera to be operated using remotes for TVs that support HDMI control.	70																																		
Video Out	Choose the video standard ([NTSC] or [PAL]) used in your country or region.	69																																		
/Info Settings	Choose the information displayed when the INFO button is pressed. [▶]Info: Choose the information displayed in full frame playback. [LV-Info]: Choose the information displayed when the camera is in shooting mode. • To choose a framing guide from , , , or , select [Displayed Grid]. [⊞] Settings: Choose the information displayed in index and calendar playback.	32, 33, 64																																		
Control Settings	Choose the controls displayed in each shooting mode. <table border="1" style="width: 100%; border-collapse: collapse;"> <thead> <tr> <th rowspan="2">Controls</th> <th colspan="4">Shooting mode</th> </tr> <tr> <th>P/A/S/M</th> <th>ⓐUTO</th> <th>ART</th> <th>SCN</th> </tr> </thead> <tbody> <tr> <td>Live Control (P. 22)</td> <td>On/Off</td> <td>On/Off</td> <td>On/Off</td> <td>On/Off</td> </tr> <tr> <td>SCP (P. 91)</td> <td>On/Off</td> <td>On/Off</td> <td>On/Off</td> <td>On/Off</td> </tr> <tr> <td>Live Guide (P. 20)</td> <td>—</td> <td>On/Off</td> <td>—</td> <td>—</td> </tr> <tr> <td>Art Menu</td> <td>—</td> <td>—</td> <td>On/Off</td> <td>—</td> </tr> <tr> <td>Scene Menu</td> <td>—</td> <td>—</td> <td>—</td> <td>On/Off</td> </tr> </tbody> </table>	Controls	Shooting mode				P/A/S/M	ⓐUTO	ART	SCN	Live Control (P. 22)	On/Off	On/Off	On/Off	On/Off	SCP (P. 91)	On/Off	On/Off	On/Off	On/Off	Live Guide (P. 20)	—	On/Off	—	—	Art Menu	—	—	On/Off	—	Scene Menu	—	—	—	On/Off	32
Controls	Shooting mode																																			
	P/A/S/M	ⓐUTO	ART	SCN																																
Live Control (P. 22)	On/Off	On/Off	On/Off	On/Off																																
SCP (P. 91)	On/Off	On/Off	On/Off	On/Off																																
Live Guide (P. 20)	—	On/Off	—	—																																
Art Menu	—	—	On/Off	—																																
Scene Menu	—	—	—	On/Off																																
Picture Mode Settings	Display only the selected picture mode when the live control or super control panel is used to select a picture mode.	—																																		
Histogram Settings	[Highlight]: Choose the lower bound for the highlight display. [Shadow]: Choose the upper bound for the shadow display.	33																																		
Mode Guide	Select [On] to display help when choosing a shooting mode.	12																																		
Live View Boost	If [On] is selected, priority will be given to making images clearly visible; the effects exposure compensation and other settings will not be visible in the monitor.	—																																		
ART LV Mode	[mode1]: The filter effect is always displayed. [mode2]: Filter effects are not visible in the monitor while the shutter button is pressed halfway. Choose for a smooth display.	—																																		

Option	Description	
Backlit LCD	If no operations are performed for the selected period, the backlight will dim to save battery power. The backlight will not dim if [Hold] is selected.	—
Sleep	The camera will enter sleep (energy saving) mode if no operations are performed for the selected period. The camera can be reactivated by pressing the shutter button halfway.	—
■) (Beep sound)	When set to [Off], you can turn off the beep sound that is emitted when the focus locks by pressing the shutter button.	—
Volume	Adjust playback volume.	17, 62, 66
USB Mode	Choose a mode for connecting the camera to a computer or printer. Choose [Auto] to display USB mode options every time the camera is connected.	—

Option	Description	
EV Step	Choose the size of the increments used when selecting shutter speed, aperture, exposure compensation, and other exposure parameters.	—
Metering	Choose a metering mode according to the scene.	41
AEL Metering	Choose the metering method used for AE lock (P. 41). [Auto]: Use the currently selected metering method.	—
ISO	Set ISO sensitivity.	48
ISO Step	Select the increments available for choosing ISO sensitivity.	—
ISO-Auto Set	Choose the upper limit and default value used for ISO sensitivity when [Auto] is selected for [ISO]. [High Limit]: Choose the upper limit for auto ISO sensitivity selection. [Default]: Choose the default value for auto ISO sensitivity selection.	—
ISO-Auto	Choose the shooting modes in which [Auto] ISO sensitivity is available. [P/A/S]: Auto ISO sensitivity selection is available in all modes except M . ISO sensitivity is fixed at ISO 200 in mode M . [All]: Auto ISO sensitivity selection is available in all modes.	—
Bulb Timer	You can set the maximum time for bulb shooting.	—
Anti-shock [⬆]	Choose the delay between the shutter button being pressed and the shutter being released. This diminishes camera shake caused by vibrations. This feature is useful in situations such as microscope photography and astrophotography. It is also useful for sequential shooting (P. 49) and self timer photography (P. 49).	—





 **Custom**

 MENU →  → 

Option	Description	
 X-Sync.	Choose the shutter speed used when the flash fires.	104
 Slow Limit	Choose the slowest shutter speed available when a flash is used.	104
 + 	When set to [On], it will be added to the exposure compensation value and flash intensity control will be performed.	40, 60

 **Color/WB**

 MENU →  → 

Option	Description	
Noise Reduct.	This function reduces the noise that is generated during long exposures. [Auto]: Noise reduction is only performed at slow shutter speeds. [On]: Noise reduction is performed with every shot. [Off]: Noise reduction off. <ul style="list-style-type: none"> Noise reduction requires about twice the time needed to record the image. Noise reduction turns off automatically during sequential shooting. This function may not work effectively with some shooting conditions or subjects. 	53
Noise Filter	Choose the amount of noise reduction performed at high ISO sensitivities.	—
WB	Choose the white balance mode.	43
All 	[All Set]: Use the same white balance compensation in all modes except [CWB]. [All Reset]: Set white balance compensation for all modes except [CWB] to 0.	—
 Keep Warm Color	Select [Off] to eliminate “warm” colors from pictures taken under incandescent lighting.	—
 +WB	Choose a white balance setting for use with the flash.	—
Color Space	You can select how colors are reproduced on the monitor or printer.	—
Shading Comp.	Choose [On] to correct peripheral illumination according to the type of lens. <ul style="list-style-type: none"> Compensation is not available for teleconverters or extension tubes. Noise may be visible at the edges of photographs taken at high ISO sensitivities. 	—

Option	Description	
Set	<p>The record mode for JPEG photographs can be selected from four combinations of image size and compression rate. The camera offers a choice of three sizes and four compression rates for each combination.</p> <p>Modifying JPEG record modes</p> <ol style="list-style-type: none"> Use to select a combination ([-1] - [-4]) and use to change. Press . <p>Number of pixels Compression rate</p>	47
Pixel Count	<p>Choose the pixel count for []- and []-size images.</p> <ol style="list-style-type: none"> Select [Pixel Count] in the Custom Menu tab . Select [iddle] or [mall] and press . Choose a pixel count and press . 	47

Option	Description	
Quick Erase	Images can be deleted immediately by pressing the or button in the playback display.	—
RAW+JPEG Erase	<p>Choose the action performed when a photograph recorded at a setting of RAW+JPEG is erased in single-frame playback (P. 17).</p> <p>[JPEG]: Only the JPEG copy is erased. [RAW]: Only the RAW copy is erased. [RAW+JPEG]: Both copies are erased.</p> <ul style="list-style-type: none"> [All Erase] (P. 65) and [Erase Selected] (P. 65) delete both RAW and JPEG copies. 	47
File Name	<p>[Auto]: Even when a new card is inserted, the file numbers are retained from the previous card. File numbering continues from the last number used or from the highest number available on the card.</p> <p>[Reset]: When you insert a new card, the folder numbers starts at 100 and the file name starts at 0001. If a card containing images is inserted, the file numbers start at the number following the highest file number on the card.</p>	—

Option	Description	📄
Pixel Mapping	The pixel mapping feature allows the camera to check and adjust the image pickup device and image processing functions.	98
Exposure Shift	Adjust optimal exposure separately for each metering mode. <ul style="list-style-type: none"> This reduces the number of exposure compensation options available in the selected direction. The effects are not visible in the monitor. To make normal adjustments to the exposure, perform exposure compensation (P. 40). 	—
Warning Level	Choose the battery level at which the warning is displayed.	8
Eye-Fi*	Enable or disable upload when using an Eye-Fi card.	99

* The camera does not support the “endless” Eye-Fi mode. Be sure to read the following before use: 📄 “Card basics” (P. 99)

■ AEL/AFL

MENU → ⚙️ → 📄 → [AEL/AFL]

The button can be used for metering or autofocus. Choose a mode for each focus mode.

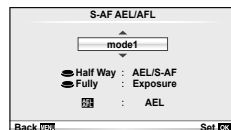























AEL/AFL

Mode		Shutter button function				📄 button function	
		Half-press		Full press		When holding down AEL/AFL	
		Focus	Exposure	Focus	Exposure	Focus	Exposure
S-AF	mode1	S-AF	Locked	—	—	—	Locked
	mode2	S-AF	—	—	Locked	—	Locked
	mode3	—	Locked	—	—	S-AF	—
C-AF	mode1	C-AF start	Locked	Locked	—	—	Locked
	mode2	C-AF start	—	Locked	Locked	—	Locked
	mode3	—	Locked	Locked	—	C-AF start	—
	mode4	—	—	Locked	Locked	C-AF start	—
MF	mode1	—	Locked	—	—	—	Locked
	mode2	—	—	—	Locked	—	Locked
	mode3	—	Locked	—	—	S-AF	—

■ Function

MENU →  →  → [Button Function] → [ Function]

The following functions can be assigned to the  button.

AEL/AFL	Press the  button to lock focus and exposure.
 REC	Press the button to record a movie. If movie recording is not assigned to a button, movies can be recorded by selecting  mode and pressing the shutter button.
Preview (electronic)	Aperture is stopped down to the selected value while the button is pressed (P. 51).
	The camera measures white balance when the button is pressed (P. 44).
[] Home	Pressing the button selects the AF target position saved with [] Set Home] (P. 82). The home AF target position is indicated by a  icon. Press the button again to return to AF target mode. If the camera is turned off when the home position is selected, the home position will be reset.
MF	Press the button to select manual focus mode. Press the button again to restore the previously selected AF mode.
RAW 	Press the button to toggle between JPEG and RAW+JPEG record modes.
Test Picture	To take a photograph and display it in the monitor without recording it to the card, press the shutter button while the  button is pressed.
Myset1 – Myset4	Pictures taken while the  button is pressed will be shot using the settings selected for [Reset/Myset] (P. 35).
Backlit LCD	Press the  button to turn the monitor off. This is useful when you are using the electronic viewfinder. Press the button again to turn the monitor on.
 / 	Press the  button to toggle between  and  when the underwater case is attached. Press and hold the  button to return to the shooting mode selected before the  button was pressed.
Live Guide	Press the button to display live guides.
Digital Tele-converter	Press the button to turn digital zoom on or off.
Q (Magnify)	Press the  button to display the zoom frame and press the  button again to zoom in. You can then choose the zoom ratio using the INFO button. Press and hold the  button to cancel zoom.
Off	No function is assigned to the button.

Accessory port menu options

OLYMPUS PENPAL Share

MENU → → →

Option	Description	
Please Wait	Receive images and add hosts to the address book.	71
Address Book	[Address List]: View the hosts that have been saved to the address book. [New Pairing]: Add a host to the address book. [Search Timer]: Choose how long the camera searches for a host.	72
My OLYMPUS PENPAL	Display information for your OLYMPUS PENPAL, including the name, address, and supported services. Press to edit the device name.	72
Picture Send Size	Choose the size at which images are transmitted. [Size 1: Small]: Images are sent at a size equivalent to 640 × 480. [Size 2: Large]: Images are sent at a size equivalent to 1920 × 1440. [Size 3: Medium]: Images are sent at a size equivalent to 1280 × 960.	71

OLYMPUS PENPAL Album

MENU → → →

Option	Description	
Copy All	All images and sound files are copied between the memory card and OLYMPUS PENPAL. Copied images are resized according to the option selected for picture copy size.	72
Reset Protect	Remove protection from all pictures in the OLYMPUS PENPAL album.	72
Album Mem. Usage	Show the number of pictures currently in the album and the number of additional pictures that can be stored at [Size 2: Medium].	72
Album Mem. Setup	[All Erase]: Delete all pictures in the album. [Format Album]: Format the album.	72
Picture Copy Size	Choose the size at which images are copied. [Size 1: Large]: Copied images are not resized. [Size 2: Medium]: Images are copied at a size equivalent to 1920 × 1440.	72

Electronic Viewfinder

MENU → → →

Option	Description	
EVF Adjust	Adjust the brightness and color temperature of the electronic viewfinder. The selected color temperature is also used in the monitor during playback. Use to select color temperature () or brightness () and use to choose from values between [+7] and [-7].	102

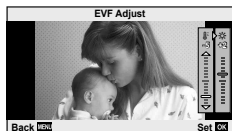

Using the super control panel

The term “super control panel” refers to the display shown below, which lists shooting settings together with the option currently selected for each.

To use the super control panel, select [On] for [Control Settings] > [SCP] (P. 83).

To choose between the live control, super control panel, and other displays, press **OK** while the camera is in shooting mode and press the **INFO** button to cycle through the different displays.



■ Settings that can be modified using super control panel

① Currently selected option	Gradation	P. 46
② ISO sensitivity.....P. 48	B&W Filter	P. 46
③ Sequential shooting/self-timer.....P. 49	Picture tone	P. 46
④ Flash mode.....P. 59	⑨ Color space.....P. 85	
⑤ Flash intensity control.....P. 60	⑩ Face priority.....P. 39, 82	
⑥ White balance.....P. 43	⑪ Metering mode.....P. 41	
White balance compensation.....P. 44	⑫ Aspect ratio.....P. 48	
⑦ Picture mode.....P. 45	⑬ Record mode.....P. 47	
⑧ Sharpness	⑭ AF mode.....P. 36	
Contrast	AF target.....P. 37	
Saturation	⑮ Image stabilizer.....P. 42	

! Cautions

- Not displayed in movie record mode.

1 After displaying the super control panel, select the desired setting using Δ ∇ \triangleleft \triangleright and press **OK**.

- You can also select settings using the control dial.

2 Select an option using \triangleleft \triangleright and press **OK**.



- Repeat steps 1 and 2 as necessary.
- The selected settings take effect automatically if no operations are performed for a few seconds.

3 Press the shutter button halfway to return to shooting mode.



Recording movies with the shutter button

Movies are usually recorded using the  button, but the shutter button can be used if other functions have been assigned to the  button.

- 1 Select  as the shooting mode.
 -  "Choosing a Shooting Mode" (P. 12)
- 2 Press the shutter button halfway down and focus on what you wish record.
 - When the subject is in focus, the AF confirmation mark lights up.

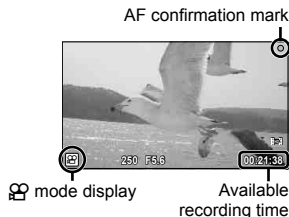



- 3 Press the shutter button all the way to begin recording.
 - **•REC** lights up while both movie and sound are recorded simultaneously.



- 4 Press the shutter button all the way to end recording.

Taking a photograph when recording ends

Select [On] for [Movie+Still] to take a still picture when movie recording is finished. This feature is useful when you want to record a still picture as well as the movie.

- 1 Select [Movie+Still] in  Custom Menu (P. 81) tab .
- 2 Select [On] and press .

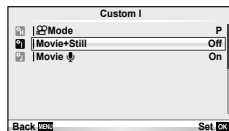

Cautions

- This option is only available when the shutter button is used to record movies.

Wireless remote control flash photography

External flash units that offer a remote control mode and are designated for use with this camera can be used for wireless flash photography. The camera can independently control up to 3 groups consisting of the supplied flash unit and/or remote flash units. See the documentation provided with the external flash units for details.

- 1 Set the remote flash units to RC mode and place them as desired.
 - Turn the external flash units on, press the MODE button, and select RC mode.
 - Select a channel and group for each external flash unit.
- 2 Select [On] for [⚡ RC Mode] in  Shooting menu 2 (P. 107).
 - The super control panel switches to RC mode.
 - You can choose a super control panel display by repeatedly pressing the **INFO** button.
 - Select a flash mode (note that red-eye reduction is not available in RC mode).
- 3 Adjust the settings for each group in the super control panel.

Group

- Select the flash control mode and adjust the flash intensity separately for each group. For MANUAL, select the flash intensity.

Adjust settings for the supplied flash unit.

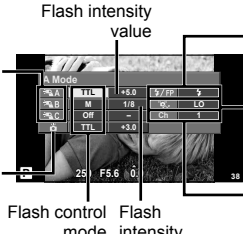

Flash intensity value

Normal flash/Super FP flash

- Switch between normal flash and Super FP flash.

Communication light level

- Set the communication light level to [HI], [MID], or [LO].

Channel

- Set the communication channel to the same channel used on the flash.

- 4 Attach the supplied flash unit and raise the flash head.
 - After confirming that the built-in and remote flash units have charged, take a test shot.

■ Wireless flash control range

Position the wireless flash units with their remote sensors facing the camera. The illustration on the right shows the approximate ranges at which the flash units can be positioned. The actual control range varies with local conditions.

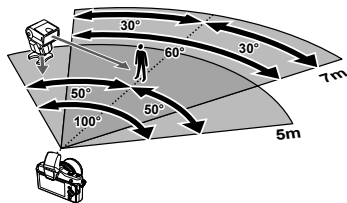

! Cautions

- We recommend using a single group of up to three remote flash units.
- Remote flash units can not be used for second curtain slow synchronization or anti-shock exposures longer than 4 seconds.
- If the subject is too close to the camera, the control flashes emitted by the supplied flash may affect exposure (this effect can be reduced by reducing the output of the supplied flash by, for example, using a diffuser).

Shooting tips and information

The camera does not turn on even when a battery is loaded

The battery is not fully charged

- Charge the battery with the charger.

The battery is temporarily unable to function because of the cold

- Battery performance drops at low temperatures. Remove the battery and warm it by putting it in your pocket for a while.

No picture is taken when the shutter button is pressed

The camera has turned off automatically

- The camera automatically enters sleep mode to reduce the drain on the battery if no operations are performed for a set period of time.  [Sleep] (P. 15)
If no operations are performed for a set time (5 minutes) after the camera has entered sleep mode, the camera will turn off automatically.

The flash is charging

- On the monitor, the  mark blinks when charging is in progress. Wait for the blinking to stop, then press the shutter button.

Unable to focus

- The camera can not focus on subjects that are too close to the camera or that are not suited to autofocus (the AF confirmation mark will blink in the monitor). Increase the distance to the subject or focus on a high contrast object at the same distance from the camera as your main subject, compose the shot, and shoot.

Subjects that are difficult to focus on

It may be difficult to focus with auto focus in the following situations.

AF confirmation mark is blinking. These subjects are not focused.

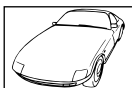

Subject with low contrast



Excessively bright light in center of frame

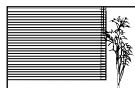

Subject containing no vertical lines

AF confirmation mark lights up but the subject is not focused.



Subjects at different distances

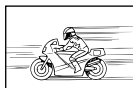

Fast-moving subject



Subject not inside AF area

Noise reduction is activated

- When shooting night scenes, shutter speeds are slower and noise tends to appear in images. The camera activates the noise-reduction process after shooting at slow shutter speeds. During which, shooting is not allowed. You can set [Noise Reduct.] to [Off].
🔗 “Customizing camera settings” (P. 81)

The date and time has not been set

The camera is used with the settings at the time of purchase

- The date and time of the camera is not set when purchased. Set the date and time before using the camera. 🔗 “Setting the date/time” (P. 9)

The battery has been removed from the camera

- The date and time settings will be returned to the factory default settings if the camera is left without the battery for approximately 1 day. The settings will be cancelled more quickly if the battery was only loaded in the camera for a short time before being removed. Before taking important pictures, check that the date and time settings are correct.

Set functions are restored to their factory default settings

In modes other than **P**, **A**, **S**, and **M**, default settings are restored when another shooting mode is selected or the camera is turned off.

Image taken appears whitish

This may occur when the picture is taken in backlight or semi-backlight conditions. This is due to a phenomenon called flare or ghosting. As far as possible, consider a composition where strong light source is not taken in the picture. Flare may occur even when a light source is not present in the picture. Use a lens hood to shade the lens from the light source. If a lens hood does not have effect, use your hand to shade the lens from the light.

🔗 “Interchangeable lenses” (P. 100)

Unknown bright dot(s) appear on the subject in the picture taken

This may be due to stuck pixel(s) on the image pickup device. Perform [Pixel Mapping]. If the problem persists, repeat pixel mapping a few times.









🔗 “Pixel mapping - Checking the image processing functions” (P. 98)









Functions that cannot be selected from menus

Some items may not be selectable from the menus when using the arrow pad.

- Items that cannot be set with the current shooting mode
- Items that cannot be set because of an item that has already been set:
Combination of [📷] and [Noise Reduct.], etc.

Error codes

Monitor indication	Possible cause	Corrective action
 No Card	The card is not inserted, or it cannot be recognized.	Insert a card or insert a different card.
 Card Error	There is a problem with the card.	Insert the card again. If the problem persists, format the card. If the card cannot be formatted, it cannot be used.
 Write Protect	Writing to the card is prohibited.	The card write-protect switch is set to the "LOCK" side. Release the switch. (P. 99)
 Card Full	<ul style="list-style-type: none"> The card is full. No more pictures can be taken or no more information such as print reservation can be recorded. There is no space in the card and print reservation or new images cannot be recorded. 	Replace the card or erase unwanted pictures. Before erasing, download important images to a PC.
 Card Setup Clean the contact area of the card with a dry cloth. Clean Card Format	Card cannot be read. Card may not have been formatted.	<ul style="list-style-type: none"> Select [Clean Card], press \odot and turn off the camera. Remove the card and wipe dry the metallic surface with a soft, dry cloth. Select [Format] \blacktriangleright [Yes], and then press \odot to format the card. Formatting the card erases all data on the card.
 No Picture	There are no pictures on the card.	The card contains no pictures. Record pictures and play back.
 Picture Error	The selected picture cannot be displayed for playback due to a problem with this picture. Or the picture cannot be used for playback on this camera.	Use image processing software to view the picture on a PC. If that cannot be done, the image file is damaged.
 The Image Cannot Be Edited	Pictures taken with another camera cannot be edited on this camera.	Use image processing software to edit the picture.
 Picture Error	Images can not be transferred between devices that are currently receiving or transmitting data.	Increase the amount of memory available on the card, for example by deleting unwanted images, or choose a smaller size for the images being transmitted.

Monitor indication	Possible cause	Corrective action
 °C/°F		Turn off the camera and wait for the internal temperature to cool.
 Internal camera temperature is too high. Please wait for cooling before camera use.	The internal temperature of the camera has risen due to sequential shooting.	Wait a moment for the camera to turn off automatically. Allow the internal temperature of the camera to cool before resuming operations.
 Battery Empty	The battery is drained.	Charge the battery.
 No Connection	The camera is not correctly connected to a computer, printer, HDMI display, or other device.	Reconnect the camera.
 No Paper	There is no paper in the printer.	Load some paper in the printer.
 No Ink	The printer has run out of ink.	Replace the ink cartridge in the printer.
 Jammed	The paper is jammed.	Remove the jammed paper.
Settings Changed	The printer's paper cassette has been removed or the printer has been manipulated while making settings on the camera.	Do not manipulate the printer while making settings on the camera.
 Print Error	There is a problem with the printer and/or camera.	Turn off camera and printer. Check the printer and remedy any problems before turning the power on again.
 Cannot Print	Pictures recorded on other cameras may not be printed on this camera.	Use a personal computer to print.
The lens is locked. Please extend the lens.	The lens of the retractable lens stays retracted.	Extend the lens. (P. 14)
Please check the status of a lens.	An abnormality has occurred between the camera and the lens.	Turn off the camera, check the connection with the lens, and turn the power on again.

Cleaning and storing the camera

Cleaning the camera

Turn off the camera and remove the battery before cleaning the camera.

Exterior:

- Wipe gently with a soft cloth. If the camera is very dirty, soak the cloth in mild soapy water and wring well. Wipe the camera with the damp cloth and then dry it with a dry cloth. If you have used the camera at the beach, use a cloth soaked in clean water and well wrung.

Monitor:

- Wipe gently with a soft cloth.

Lens:

- Blow dust off the lens with a commercially available blower. For the lens, wipe gently with a lens cleaning paper.

Storage

- When not using the camera for a prolonged period, remove the battery and card. Store the camera in a cool, dry place that is well ventilated.
- Insert the battery periodically and test the camera's functions.
- Remove dust and other foreign matter from the body and rear caps before attaching them.
- Attach the body cap to the camera to prevent dust from getting inside when no lens is attached. Be sure to replace the front and rear lens caps before putting the lens away.
- Clean the camera after use.
- Do not store with insect repellent.

Cleaning and checking the image pickup device

This camera incorporates a dust reduction function to keep dust from getting on the image pickup device and to remove any dust or dirt from the image pickup device surface with ultrasonic vibrations. The dust reduction function operates when the camera is turned on.

The dust reduction function operates at the same time as the pixel mapping, which checks the image pickup device and image processing circuitry. Since dust reduction is activated every time the camera's power is turned on, the camera should be held upright for the dust reduction function to be effective.

Cautions

- Do not use strong solvents such as benzene or alcohol, or a chemically treated cloth.
- Avoid storing the camera in places where chemicals are treated, in order to protect the camera from corrosion.
- Mold may form on the lens surface if the lens is left dirty.
- Check each part of the camera before use if it has not been used for a long time. Before taking important pictures, be sure to take a test shot and check that the camera works properly.

Pixel mapping - Checking the image processing functions

The pixel mapping feature allows the camera to check and adjust the image pickup device and image processing functions. After using the monitor or taking continuous shots, wait for at least one minute before using the pixel mapping function to ensure that it operates correctly.

- 1 Select [Pixel Mapping] in Custom Menu (P. 81) tab .
- 2 Press , then press .
 - The [Busy] bar is displayed when pixel mapping is in progress. When pixel mapping is finished, the menu is restored.

Cautions

- If you accidentally turn the camera off during pixel mapping, start again from Step 1.

Card basics

Usable cards

In this manual, all storage devices are referred to as “cards.” The following types of SD memory card (commercially available) can be used with this camera: SD, SDHC, SDXC, and Eye-Fi. For the latest information, please visit the Olympus website.



SD card write protect switch

The SD card body has a write protect switch. If you set the switch to the “LOCK” side, you will not be able to write to the card, delete data or format. Return the switch to the unlock position enable writing.

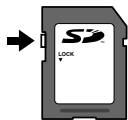

Cautions

- The data in the card will not be erased completely even after formatting the card or deleting the data. When discarding, destroy the card to prevent leakage of personal information.
- Use the Eye-Fi card in compliance with the laws and regulations of the country where the camera is used.
- In locations such as on an airplane, where the Eye-Fi communication is prohibited, remove the Eye-Fi card from the camera, or set [Eye-Fi] (P. 88) to [Off].
- The Eye-Fi card may become hot during use.
- When using an Eye-Fi card, the battery may run out faster.
- When using an Eye-Fi card, the camera may function more slowly.

Formatting the card

Cards must be formatted with this camera before first use or after being used with other cameras or computers.

All data stored on the card, including protected images, is erased when the card is formatted. When formatting a used card, confirm there are no images that you still want to keep on the card.

- 1 Select [Card Setup] in shooting menu (P. 107).
- 2 Select [Format].
- 3 Select [Yes] and press .
 - Formatting is performed.

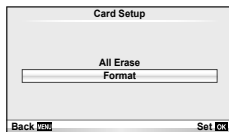

Battery and charger

- Use the single Olympus lithium-ion battery. Use only genuine OLYMPUS rechargeable batteries.
- Use only compatible battery chargers to charge rechargeable batteries. BLS-1 batteries must be charged using the BCS-1, BLS-5 batteries using the BCS-5.
- The camera's power consumption varies widely with usage and other conditions.
- As the following consume a lot of power even without shooting, the battery will be drained quickly.
 - Performing auto focus repeatedly by pressing the shutter button halfway in shooting mode.
 - Displaying images on the monitor for a prolonged period.
 - When connected to a computer or printer.
- When using a drained battery, the camera may turn off without the low battery warning being displayed.
- The battery will not be fully charged at the time of purchase. Charge the battery using the supplied charger before use.
- The normal charging time using the supplied charger is approximately 3 hours 30 minutes (estimated).
- Do not attempt to use chargers not specifically designated for use with the supplied battery, or to use batteries not specifically designated for use with the supplied charger.

Cautions

- There is a risk of explosion if the battery is replaced with the incorrect battery type. Dispose of the used battery following the instructions. "Battery Handling Precautions" (P. 114)

Using your charger abroad

- The charger can be used in most home electrical sources within the range of 100V to 240V AC (50/60 Hz) around the world. However, depending on the country or area you are in, the AC wall outlet may be shaped differently and the charger may require a plug adapter to match the wall outlet. For details, ask at your local electrical shop or travel agent.
- Do not use commercially available travel adapters as the charger may malfunction.

Interchangeable lenses

Choose a lens according to the scene and your creative intent. Use lenses designed exclusively for the Micro Four Thirds system and bearing the M. ZUIKO label or the symbol shown at right. With an adapter, you can also use Four Thirds System and OM System lenses.



Cautions

- When you attach or remove the body cap and lens from the camera, keep the lens mount on the camera pointed downward. This helps prevent dust and other foreign matter from getting inside the camera.
- Do not remove the body cap or attach the lens in dusty places.
- Do not point the lens attached to the camera toward the sun. This may cause the camera to malfunction or even ignite due to the magnifying effect of sunlight focusing through the lens.
- Be careful not to lose the body cap and rear cap.

M.ZUIKO DIGITAL lens specifications

Names of parts

- ① Filter mount thread
- ② Zoom ring (zoom lenses only)
- ③ Focus ring
- ④ Mount index
- ⑤ Electrical contacts
- ⑥ Front cap
- ⑦ Rear cap

If the hood is attached to a lens with a decorative ring, rotate the ring to the left.

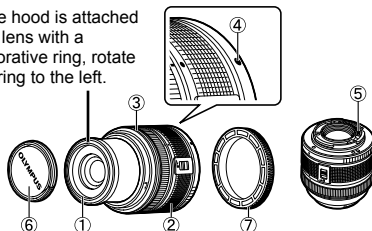

Lens and camera combinations

Lens	Camera	Attachment	AF	Metering
Micro Four Thirds system lens	Micro Four Thirds system camera	Yes	Yes	Yes
Four Thirds system lens		Attachment possible with mount adapter	Yes*1	Yes
OM System lenses			No	Yes*2
Micro Four Thirds system lens	Four Thirds System Camera	No	No	No

*1 [C-AF] and [C-AF+TR] of [AF Mode] cannot be used.

*2 Accurate metering not possible.

Main Specifications

Items	14–42 mm II R	17 mm	40–150 mm R	14–150 mm
Mount	Micro Four Thirds mount			
Focal length	14–42 mm	17 mm	40–150 mm	14–150 mm
Max. aperture	f/3.5–5.6	f/2.8	f/4.0–5.6	f/4.0–5.6
Image angle	75°–29°	64.9°	30.3°–8.2°	75°–8.2°
Lens configuration	7 groups, 8 lenses	4 groups, 6 lenses	10 groups, 13 lenses	11 groups, 15 lenses
	Multilayer film coating			
Iris control	f/3.5–22	f/2.8–22	f/4.0–22	f/4.0–22
Shooting range (Focal length)	• 0.25 m–∞ (14–19 mm) • 0.3 m–∞ (20–42 mm)	0.2 m–∞	0.9 m–∞	0.5 m–∞
Focus adjustment	AF/MF switching			
Weight (excluding hood and cap)	115 g	71 g	190 g	260 g
Dimensions (Max. diameter × overall length)	ø56.5×50 mm	ø57×22 mm	ø63.5×83 mm	ø63.5×83 mm
Filter mount thread diameter	37 mm	37 mm	58 mm	58 mm

⚠ Cautions

- Edges of pictures may be cut off if more than one filter is used or if a thick filter is used.

Principal Accessories

Mount adapter

Mount adapter allows the camera to be used with lenses that do not conform to the Micro Four Thirds System standard.

■ Four Thirds lens adapter (MMF-2)

The camera requires MMF-2 Four Thirds lens adapter to attach Four Thirds lenses. Some features, such as autofocus, may not be available.

■ OM adapter (MF-2)

Use with existing OLYMPUS OM System lenses. Focus and aperture must be adjusted manually. Image stabilization can be used. Input the focal length of the lens being used in the camera image stabilization settings.

Remote cable (RM-UC1)

Use when the slightest camera movement can result in blurred pictures, for example for macro or bulb photography. The remote cable attaches via the camera USB connector.

Converter lenses

Converter lenses attach to the camera lens for quick and easy fish-eye or macro photography. See the OLYMPUS website for information on the lenses that can be used.

- Use the appropriate lens attachment for **SCN** mode (📷, 📷, or 📷).

Macro arm light (MAL-1)

Use to illuminate subjects for macro photography, even at ranges at which vignetting would occur with the flash.

Microphone set (SEMA-1)













Produces higher-quality recordings than the camera's built-in microphone. The microphone can be placed at a distance from the camera to avoid recording ambient sounds or wind noise. Third-party commercial microphones can also be used depending on your creative intent (power supplied via ø3.5 mm stereo mini-plug).

Electronic viewfinder (VF-2)

Electronic viewfinder can be used to view the shooting display. This is convenient when you are in a very bright location, such as under direct sunlight, where it is difficult to view the monitor, or are using the camera at a low angle.











Exposure warning display

If the optimum exposure cannot be obtained when pressing the shutter button halfway, the display will blink on the monitor.



Shooting mode	Warning display example (blinking)	Status	Action
P	 	The subject is too dark.	<ul style="list-style-type: none"> • Increase the ISO sensitivity. • Use the flash.
	 	The subject is too bright.	<ul style="list-style-type: none"> • Decrease the ISO sensitivity. • Use a commercially available ND filter (for adjusting the amount of light).
A	 	The subject is underexposed.	<ul style="list-style-type: none"> • Decrease the aperture value. • Increase the ISO sensitivity.
	 	The subject is overexposed.	<ul style="list-style-type: none"> • Increase the aperture value. • Decrease the ISO sensitivity or use a commercially available ND filter (for adjusting the amount of light).
S	 	The subject is underexposed.	<ul style="list-style-type: none"> • Set the shutter speed slower. • Increase the ISO sensitivity.
	 	The subject is overexposed.	<ul style="list-style-type: none"> • Set the shutter speed faster. • Decrease the ISO sensitivity or use a commercially available ND filter (for adjusting the amount of light).

- The aperture value at the moment when its indication blinks varies with the lens type and focal length of the lens.

Flash modes that can be set by shooting mode

Shooting Mode	Super control panel	Flash Mode	Flash timing	Conditions for firing the flash	Shutter speed limit
P/A		Auto flash	1st curtain	Fires automatically in dark/backlit* conditions	1/30 sec. – 1/160 sec.
		Auto flash (red-eye reduction)			
		Fill-in flash		Always fires	
		Flash off	—	—	—
	 SLOW	Slow synchronization (red-eye reduction)	1st curtain	Fires automatically in dark/backlit* conditions	60 sec. – 1/160 sec.
		Slow synchronization (1st curtain)			
	 SLOW2	Slow synchronization (2nd curtain)	2nd curtain		
S/M		Fill-in flash	1st curtain	Always fires	60 sec. – 1/160 sec.
		Fill-in flash (red-eye reduction)			
		Flash off	—	—	—
	 2nd-C	Fill-in flash/Slow synchronization (2nd curtain)	2nd curtain	Always fires	60 sec. – 1/160 sec.

* In Super FP mode, external flash units for use with this camera detect backlighting and emit a longer-than-normal flash.

-  **AUTO**,  can be set in **AUTO** mode.

Minimum range

The lens may cast shadows over objects close to the camera, causing vignetting, or be too bright even at minimum output.

Lens	Approximate distance at which vignetting occurs
14–42 mm	1.0 m
17 mm	0.25 m
40–150 mm	1.0 m
14–150 mm	Flash can not be used

- External flash units can be used to prevent vignetting. To prevent photographs from being overexposed, select mode **A** or **M** and choose a high f-number, or reduce ISO sensitivity.

Flash synchronization and shutter speed

Shooting mode	Flash timing	Upper limit of synchronization timing ^{*1}	Fixed timing when flash fires ^{*2}
P	1/ (lens focal length × 2) or synchronization timing, whichever is slower	1/160	1/60
A			
S	The set shutter speed		—
M			

*1 Can be changed using menu: 1/60–1/160 [⚡ X-Sync.]: "Customizing camera settings" (P. 81)

*2 Can be changed using menu: 30–1/160 [⚡ Slow Limit]: "Customizing camera settings" (P. 81)

External flash unit

Optional flash units designed for use with this camera can be used for a variety of flash effects. The external flashes communicate with the camera, allowing you to control the camera's flash modes with various available flash control modes, such as TTL-AUTO and Super FP flash.

An external flash unit specified for use with this camera can be mounted on the camera by attaching it to the camera's hot shoe. You can also attach the flash to the flash bracket on the camera using the bracket cable (optional). Refer to the documentation provided with the external flash units as well.

Functions available with external flash units

Optional flash	Flash control mode	GN (Guide number) (ISO100)	RC mode
FL-50R	TTL-AUTO, AUTO, MANUAL,	GN50 (85 mm*) GN28 (24 mm*)	✓
FL-36R	FP TTL AUTO, FP MANUAL	GN36 (85 mm*) GN20 (24 mm*)	✓
FL-300R	TTL-AUTO, MANUAL	GN20 (28 mm*)	✓
FL-14	TTL-AUTO, AUTO, MANUAL	GN14 (28 mm*)	—
RF-11	TTL-AUTO, MANUAL	GN11	—
TF-22		GN22	—

* The focal length of the lens that can be used (Calculated based on 35 mm film camera).

Record mode and file size/number of storable still pictures

The file size in the table is approximate for files with a 4:3 aspect ratio.

Record mode	Number of pixels (Pixel Count)	Compression	File format	File size (MB)	Number of storable still picture*1						
RAW	4032×3024	Loss-less compression	ORF	Approx. 13.8	55						
L SF		1/2.7		Approx. 8.4	102						
L F		1/4		Approx. 5.9	146						
L N		1/8		Approx. 2.7	322						
L B		1/12		Approx. 1.8	480						
M SF	3200×2400	1/2.7		JPEG	Approx. 5.6	155					
M F		1/4			Approx. 3.4	257					
M N		1/8			Approx. 1.7	508					
M B		1/12			Approx. 1.2	753					
M SF	2560×1920	1/2.7			JPEG	Approx. 3.2	271				
M F		1/4				Approx. 2.2	398				
M N		1/8				Approx. 1.1	782				
M B		1/12				Approx. 0.8	1151				
M SF	1920×1440	1/2.7				JPEG	Approx. 1.8	476			
M F		1/4					Approx. 1.3	701			
M N		1/8					Approx. 0.7	1356			
M B		1/12					Approx. 0.5	1968			
M SF	1600×1200	1/2.7					JPEG	Approx. 1.3	678		
M F		1/4						Approx. 0.9	984		
M N		1/8						Approx. 0.5	1906		
M B		1/12						Approx. 0.4	2653		
S SF	1280×960	1/2.7						JPEG	Approx. 0.9	1034	
S F		1/4							Approx. 0.6	1488	
S N		1/8							Approx. 0.4	2773	
S B		1/12							Approx. 0.3	3813	
S SF	1024×768	1/2.7							JPEG	Approx. 0.6	1564
S F		1/4	Approx. 0.4							2260	
S N		1/8	Approx. 0.3							4068	
S B		1/12	Approx. 0.2							5547	
S SF	640×480	1/2.7	JPEG							Approx. 0.3	3589
S F		1/4								Approx. 0.2	5085
S N		1/8		Approx. 0.2						7627	
S B		1/12		Approx. 0.1						10170	

*1 Assumes a 1 GB SD card.

⚠ Cautions

- The number of remaining pictures may change according to the subject, whether or not print reservations have been made, and other factors. In certain instances, the number of remaining pictures displayed on the monitor will not change even when you take pictures or erase stored images.
- The actual file size varies according to the subject.
- The maximum number of storable still pictures displayed on the monitor is 9999.
- For the available recording time for movies, see the Olympus website.













Menu directory

*1: Can be added to [Myset].





*2: Default can be restored by selecting [Full] for [Reset].

*3: Default can be restored by selecting [Basic] for [Reset].

Shooting Menu

Tab	Function		Default	*1	*2	*3		
	Card Setup		—				65, 99	
	Reset/Myset		—		✓		35	
	Picture Mode		 Natural	✓	✓	✓	45	
		Still Picture	 N	✓	✓	✓	47	
		Movie	AVCHD FullHD <i>25</i> 					
Image Aspect		4:3	✓	✓	✓	48		
				✓	✓	✓	49	
	Image Stabilizer			✓	✓	✓	42	
	Bracketing	AE BKT		Off				57
		WB BKT	A–B	Off				57
			G–M					
		FL BKT		Off	✓	✓	✓	58
		ISO BKT		Off				58
	ART BKT		Off				58	
	Multiple Exposure	Frame		Off				56
		Auto Gain		Off		✓	✓	
		Overlay		Off				
			±0.0	✓	✓	✓	60	
			Off	✓	✓	✓	93	
Digital Tele-converter		Off	✓	✓	✓	58		

Playback Menu

Tab	Function		Default	*1	*2	*3		
		Start	—				66	
		BGM	Melancholy		✓	✓		
		Effect	Fade		✓	✓		
		Slide	All		✓	✓		
		Slide Interval	3 sec		✓			
		Movie Interval	Short		✓			
	Edit	Sel. Image	RAW Data Edit	—				67
			JPEG Edit	—				67
		Image Overlay			—			
			—					76
Reset Protect		—					65	

☰ Setup Menu

Tab	Function	Default	*1	*2	*3	☞	
☰		—				9	
	*	—				80	
		± 0 , $\text{☼} \pm 0$		✓	✓	80	
	Rec View	5 sec	✓	✓	✓	80	
	/ Menu Display	Menu Display	Off		✓		80
		Menu Display	Off				
	Firmware	—				80	

* Settings differ depending on the region where the camera is purchased.

⚙️ Custom Menu

Tab	Function	Default	*1	*2	*3	☞	
⚙️	☞ AF/MF						
	AF Mode	Still Picture	S-AF				81
		Movie	C-AF	✓	✓	✓	
	Full-time AF	Off	✓	✓	✓		
	AF Area		✓	✓	✓		
	Reset Lens	On		✓	✓		
	Bulb Focusing	On		✓	✓		
	Focus Ring		✓	✓	✓	82	
	MF Assist	Off	✓	✓			
	Set Home			✓	✓		
	AF Illuminat.	On	✓	✓	✓		
	Face Priority		✓	✓			
	Face Priority		✓	✓			
	☞ Button/dial						
	AEL/AFL	S-AF	mode1	✓	✓	✓	82
		C-AF	mode2				
		MF	mode1				
	AEL/AFL Memo	On	✓	✓	✓		
	Button Function	Function		✓	✓	✓	
		Function					
		Function	/				
	Dial Function	P		✓	✓		
		A	FNo.				
		S	Shutter				
		M	Shutter				
			Prev/Next				
	Dial Direction	Exposure	Dial1	✓	✓		
Menu		Dial1					
Lock	On	✓	✓				
☞ Release/							
RIs Priority S	Off	✓	✓	✓	83		
RIs Priority C	On	✓	✓	✓			
H fps	5 fps	✓	✓	✓			
L fps	3 fps	✓	✓	✓			

Tab	Function	Default	*1	*2	*3		
	Disp/)/PC						
	HDMI	HDMI Out	1080i		✓		83
		HDMI Control	Off		✓		
	Video Out*		—				
		Info	Image Only, Overall	✓	✓	✓	
		LV-Info	Image Only,	✓	✓		
		Settings	25, Calendar	✓	✓		
		iAUTO	Live Guide		✓		
		P/A/S/M	Live Control		✓		
		ART	Art Menu		✓		
		SCN	Scene Menu		✓		
	Picture Mode Settings		On	✓	✓		
	Histogram Settings	Highlight	255				
		Shadow	0		✓		
	Mode Guide		On		✓		
	Live View Boost		Off	✓	✓	✓	
	ART LV Mode		mode1		✓		
Backlit LCD		Hold	✓	✓	✓		
Sleep		1 min	✓	✓	✓		
		On	✓	✓	✓		
Volume		3		✓			
USB Mode		Auto		✓	✓		
	Exp/ISO						
	EV Step		1/3EV	✓	✓	✓	
	Metering			✓	✓	✓	
	AEL Metering		Auto	✓	✓	✓	
	ISO		Auto	✓	✓	✓	
	ISO Step		1/3EV	✓	✓	✓	
	ISO-Auto Set		High Limit: 1600 Default: 200	✓	✓	✓	
	ISO-Auto		P/A/S	✓	✓		
	Bulb Timer		8 min	✓	✓	✓	
Anti-Shock [♦]		Off	✓	✓	✓		
	Custom						
	X-Sync.		1/160	✓	✓	✓	
	Slow Limit		1/60	✓	✓	✓	
	+		Off	✓	✓	✓	
	Color/WB						
	Noise Reduct.		Auto	✓	✓	✓	
	Noise Filter		Standard	✓	✓	✓	
	WB		Auto	A:0, G:0	✓	✓	
	All	All Set	—	✓	✓		
		All Reset	—		✓		
	Keep Warm Color		On	✓	✓	✓	
	+ WB		Off	✓	✓	✓	
Color Space		sRGB	✓	✓	✓		

* Settings differ depending on the region where the camera is purchased.

Tab	Function	Default	*1	*2	*3		
	Shading Comp.	Off	✓	✓	✓	85	
	Set	—	✓	✓	✓		
	Pixel Count	Middle	2560×1920	✓	✓	✓	86
		Small	1280×960				
		Record/Erase					
	Quick Erase	Off	✓	✓	✓	86	
	RAW+JPEG Erase	RAW+JPEG	✓	✓	✓		
	File Name	Auto		✓			
	Edit Filename	Off		✓		87	
	Priority Set	No		✓	✓		
	dpi Setting	Auto		✓			
	Copyright Settings	Copyright Info.	Off		✓		
		Artist Name	—				
		Copyright Name	—				
		Movie					
	Mode	P			✓	✓	87
	Movie+Still	Off		✓	✓	✓	
	Movie	On		✓	✓	✓	
	Utility						
Pixel Mapping		—				88	
Exposure Shift		±0	✓	✓			
Warning Level		±0		✓			
Eye-Fi		Off		✓	✓		

Accessory Port Menu

Tab	Function	Default	*1	*2	*3		
	OLYMPUS PENPAL Share						
	Please Wait		—			71, 90	
	Address Book	Address List		—			90
		Search Timer	30sec		✓		
	New Pairing		—				
	My OLYMPUS PENPAL		—				
	Picture Send Size		Size 1: Small		✓		
		OLYMPUS PENPAL Album					
	Copy All		—				90
	Reset Protect		—				
	Album Mem. Usage		—				
	Album Mem. Setup		—				
Picture Copy Size		Size 2: Medium		✓			
	Electronic Viewfinder						
EVF Adjust		±0, ±0		✓	✓	90	

Specifications

■ Camera

Product type	
Product type	Digital camera with interchangeable lens system
Lens	M.Zuiko Digital, Micro Four Thirds System Lens
Lens mount	Micro Four Thirds mount
Equivalent focal length on a 35 mm film camera	Approx. twice the focal length of the lens
Image pickup device	
Product type	4/3" Live MOS sensor
No. of total pixels	Approx. 13,060,000 pixels
No. of effective pixels	Approx. 12,300,000 pixels
Screen size	17.3 mm (H) × 13.0 mm (V)
Aspect ratio	1.33 (4:3)
Live view	
Sensor	Uses Live MOS sensor
Field of view	100%
Monitor	
Product type	3.0" TFT color LCD
Total no. of pixels	Approx. 460,000 dots (aspect ratio 16:9)
Shutter	
Product type	Computerized focal-plane shutter
Shutter	1/4000–60 sec., Bulb
Auto focus	
Product type	Imager contrast detection system
Focusing points	35 points
Selection of focusing point	Auto, Optional
Exposure control	
Metering system	TTL metering system (imager metering) Digital ESP metering/Center weighted averaging metering/Spot metering
Metered range	EV 0 - 20 (Digital ESP metering/Center weighted averaging metering/ Spot metering)
Shooting modes	i AUTO/ P : Program AE (Program shift can be performed)/ A : Aperture priority AE/ S : Shutter priority AE/ M : Manual/ ART : Art filter/ SCN : Scene/ MOV : Movie
ISO sensitivity	200 - 12800 (1/3, 1 EV step)
Exposure compensation	±3EV (1/3, 1/2, 1 EV step)
White balance	
Product type	Image pickup device
Mode setting	Auto/Preset WB (7 settings)/Customized WB/One-touch WB
Recording	
Memory	SD/SDHC/SDXC/Eye-Fi card
Recording system	Digital recording, JPEG (in accordance with Design rule for Camera File system (DCF)), RAW Data, MP format
Applicable standards	Exif 2.2, Digital Print Order Format (DPOF), PRINT Image Matching III, PictBridge
Sound with still pictures	Wave format
Movie	AVI Motion JPEG/AVCHD
Audio	PCM 48kHz/Dolby Digital
Playback	
Display format	Single-frame playback/Close-up playback/Index display/Calendar display

Drive	
Drive mode	Single-frame shooting/Sequential shooting/Self-timer
Sequential shooting	Approx. 4 frames/sec. (📷, IS:IS1), Approx. 5 frames/sec. (📷, IS:OFF)
Self-timer	Operation time: 12 sec., 2 sec.
External flash	
Sync speed	1/160 s or slower
Flash control mode	TTL-AUTO (TTL pre-flash mode)
External connector	
Multi-connector (USB connector, AV connector)/HDMI micro connector (type D)/Accessory port	
Power supply	
Battery	Li-ion Battery ×1
Dimensions/weight	
Dimensions	109.5 mm (W) × 63.7 mm (H) × 34.0 mm (D) (4.8" × 2.5" × 1.3") (excluding protrusions)
Weight	Approx. 265 g (0.6 lb.) (including battery and memory card)
Operating environment	
Temperature	0 °C - 40 °C (32 °F - 104 °F) (operation)/-20 °C - 60 °C (-4 °F - 140 °F) (storage)
Humidity	30% - 90% (operation)/10% - 90% (storage)

HDMI, the HDMI logo and High-Definition Multimedia Interface are trademarks or registered trademarks of HDMI Licensing LLC.



■ FL-LM1 Flash

Guide number	10 (ISO200)
Firing angle	Covers the picture angle of a 14 mm lens (equivalent to 28 mm in 35 mm format)
Dimensions	Approx. 39.2 mm (W) × 32.2 mm (H) × 43.4 mm (D) (1.5" × 1.3" × 1.7")
Weight	Approx. 25 g (0.06 lb.)

■ Lithium ion battery

MODEL NO.	BLS-1 (PS-BLS1)	BLS-5
Product type	Rechargeable Lithium ion battery	
Nominal voltage	DC 7.2 V	
Nominal capacity	1150 mAh	
No. of charge and discharge times	Approx. 500 times (varies with usage conditions)	
Ambient temperature	0 °C - 40 °C (32 °F - 104 °F) (charging)	
Dimensions	Approx. 35.5 mm (W) × 12.8 mm (H) × 55 mm (D) (1.4" × 0.5" × 2.2")	
Weight	Approx. 46 g (0.1 lb.)	Approx. 44 g (0.1 lb.)

■ Lithium ion charger

MODEL NO.	BCS-1 (PS-BCS1)	BCS-5
Rated input	AC 100 V - 240 V (50/60Hz)	
Rated output	DC 8.35V, 400mA	
Charging time	Approx. 3 hours 30 minutes (room temperature)	
Ambient temperature	0 °C - 40 °C (32 °F - 104 °F) (operation)/ -20 °C - 60 °C (-4 °F - 140 °F) (storage)	
Dimensions	Approx. 62 mm (W) × 38 mm (H) × 83 mm (D) (2.4" × 1.5" × 3.3")	
Weight (without AC cable)	Approx. 72 g (0.2 lb.)	Approx. 70 g (0.2 lb.)

- The AC cable supplied with this device is for use only with this device and should not be used with other devices. Do not use cables for other devices with this device.

SPECIFICATIONS ARE SUBJECT TO CHANGE WITHOUT ANY NOTICE OR OBLIGATION ON THE PART OF THE MANUFACTURER.

SAFETY PRECAUTIONS



CAUTION

RISK OF ELECTRICAL SHOCK
DO NOT OPEN



CAUTION: TO REDUCE THE RISK OF ELECTRICAL SHOCK, DO NOT REMOVE COVER (OR BACK). NO USER-SERVICEABLE PARTS INSIDE. REFER SERVICING TO QUALIFIED OLYMPUS SERVICE PERSONNEL.



An exclamation mark enclosed in a triangle alerts you to important operating and maintenance instructions in the documentation provided with the product.



DANGER

If the product is used without observing the information given under this symbol, serious injury or death may result.



WARNING

If the product is used without observing the information given under this symbol, injury or death may result.



CAUTION

If the product is used without observing the information given under this symbol, minor personal injury, damage to the equipment, or loss of valuable data may result.

WARNING!

TO AVOID THE RISK OF FIRE OR ELECTRICAL SHOCK, NEVER DISASSEMBLE, EXPOSE THIS PRODUCT TO WATER OR OPERATE IN A HIGH HUMIDITY ENVIRONMENT.

General Precautions

Read All Instructions — Before you use the product, read all operating instructions. Save all manuals and documentation for future reference.

Cleaning — Always unplug this product from the wall outlet before cleaning. Use only a damp cloth for cleaning. Never use any type of liquid or aerosol cleaner, or any type of organic solvent to clean this product.

Attachments — For your safety, and to avoid damaging the product, use only accessories recommended by Olympus.

Water and Moisture — For precautions on products with weatherproof designs, read the weatherproofing sections.

Location — To avoid damage to the product, mount the product securely on a stable tripod, stand, or bracket.

Power Source — Connect this product only to the power source described on the product label.

Foreign Objects — To avoid personal injury, never insert a metal object into the product.

Heat — Never use or store this product near any heat source such as a radiator, heat register,

stove, or any type of equipment or appliance that generates heat, including stereo amplifiers.

Product Handling Precautions

WARNING

- Do not use the camera near flammable or explosive gases.
- Do not use the flash and LED on people (infants, small children, etc.) at close range.
 - You must be at least 1 m (3 ft.) away from the faces of your subjects. Firing the flash too close to the subject's eyes could cause a momentary loss of vision.
- Keep young children and infants away from the camera.

Always use and store the camera out of the reach of young children and infants to prevent the following dangerous situations which could cause serious injury:

- Becoming entangled in the camera strap, causing strangulation.
- Accidentally swallowing the battery, cards or other small parts.

- Accidentally firing the flash into their own eyes or those of another child.
- Accidentally being injured by the moving parts of the camera.
- **Do not look at the sun or strong lights with the camera.**
- **Do not use or store the camera in dusty or humid places.**
- **Do not cover the flash with a hand while firing.**

CAUTION

- **Stop using the camera immediately if you notice any unusual odors, noise, or smoke around it.**
Never remove the batteries with bare hands, which may cause a fire or burn your hands.
- **Never hold or operate the camera with wet hands.**
- **Do not leave the camera in places where it may be subject to extremely high temperatures.**
Doing so may cause parts to deteriorate and, in some circumstances, cause the camera to catch fire.
Do not use the charger if it is covered (such as a blanket). This could cause overheating, resulting in fire.

- **Handle the camera with care to avoid getting a low-temperature burn.**

When the camera contains metal parts, overheating can result in a low-temperature burn. Pay attention to the following:

- When used for a long period, the camera will get hot. If you hold on to the camera in this state, a low temperature burn may be caused.
- In places subject to extremely cold temperatures, the temperature of the camera's body may be lower than the environmental temperature. If possible, wear gloves when handling the camera in cold temperatures.
- **Be careful with the strap.**
Be careful with the strap when you carry the camera. It could easily catch on stray objects - and cause serious damage.

Battery Handling Precautions

Follow these important guidelines to prevent batteries from leaking, overheating, burning, exploding, or causing electrical shocks or burns.

DANGER

- The camera uses a lithium ion battery specified by Olympus. Charge the battery with the specified charger. Do not use any other chargers.

- Never heat or incinerate batteries.
- Take precautions when carrying or storing batteries to prevent them from coming into contact with any metal objects such as jewelry, pins, fasteners, etc.
- Never store batteries where they will be exposed to direct sunlight, or subjected to high temperatures in a hot vehicle, near a heat source, etc.
- To prevent causing battery leaks or damaging their terminals, carefully follow all instructions regarding the use of batteries. Never attempt to disassemble a battery or modify it in any way, by soldering, etc.
- If battery fluid gets into your eyes, flush your eyes immediately with clear, cold running water and seek medical attention immediately.
- Always store batteries out of the reach of small children. If a child accidentally swallows a battery, seek medical attention immediately.
- Should you notice that the charger is emitting smoke, heat, or an unusual noise or smell, immediately cease use and unplug the charger from the power outlet, and then contact an authorized distributor or service center.

WARNING

- Keep batteries dry at all times.
- To prevent batteries from leaking, overheating, or causing a fire or explosion, use only batteries recommended for use with this product.
- Insert the battery carefully as described in the operating instructions.
- If rechargeable batteries have not been recharged within the specified time, stop charging them and do not use them.
- Do not use a battery if it is cracked or broken.
- If a battery leaks, becomes discolored or deformed, or becomes abnormal in any other way during operation, stop using the camera.
- If a battery leaks fluid onto your clothing or skin, remove the clothing and flush the affected area with clean, running cold water immediately. If the fluid burns your skin, seek medical attention immediately.
- Never subject batteries to strong shocks or continuous vibration.

CAUTION

- Before loading, always inspect the battery carefully for leaks, discoloration, warping, or any other abnormality.
- The battery may become hot during prolonged use. To avoid minor burns, do not remove it immediately after using the camera.

- Always unload the battery from the camera before storing the camera for a long period.
 - This camera uses a lithium ion battery specified by Olympus. Do not use any other type of battery. For safe and proper use, read the battery's instruction manual carefully before using it.
 - If the battery's terminals get wet or greasy, camera contact failure may result. Wipe the battery well with a dry cloth before use.
 - Always charge a battery when using it for the first time, or if it has not been used for a long period.
 - When operating the camera with battery power at low temperatures, try to keep the camera and spare battery as warm as possible. A battery that has run down at low temperatures may be restored after it is warmed at room temperature.
 - The number of pictures you can take may vary depending on the shooting conditions or battery.
 - Before going on a long trip, and especially before traveling abroad, purchase extra batteries. A recommended battery may be difficult to obtain while traveling.
 - When the camera will not be used for an extended period, store it in a cool place.
 - Please recycle batteries to help save our planet's resources. When you throw away dead batteries, be sure to cover their terminals and always observe local laws and regulations.
- Do not leave the camera pointed directly at the sun. This may cause lens or shutter curtain damage, color failure, ghosting on the image pickup device, or may possibly cause fires.
 - Do not touch electric contacts on cameras and interchangeable lenses. Remember to attach the body cap when removing the lens.
 - Before storing the camera for a long period, remove the battery. Select a cool, dry location for storage to prevent condensation or mold from forming inside the camera. After storage, test the camera by turning it on and pressing the shutter release button to make sure that it is operating normally.
 - The camera may malfunction if it is used in a location where it is subject to a magnetic/ electromagnetic field, radio waves, or high voltage, such as near a TV set, microwave, video game, loud speakers, large monitor unit, TV/radio tower, or transmission towers. In such cases, turn the camera off and on again before further operation.
 - Always observe the operating environment restrictions described in the camera's manual.
 - Do not directly touch or wipe the image pickup device of the camera.

Caution for Usage Environment

- To protect the high-precision technology contained in this product, never leave the camera in the places listed below, no matter if in use or storage:
 - Places where temperatures and/or humidity are high or go through extreme changes. Direct sunlight, beaches, locked cars, or near other heat sources (stove, radiator, etc.) or humidifiers.
 - In sandy or dusty environments.
 - Near flammable items or explosives.
 - In wet places, such as bathrooms or in the rain. When using products with weatherproof designs, read their manuals as well.
 - In places prone to strong vibrations.
- Never drop the camera or subject it to severe shocks or vibrations.
- When mounted on a tripod, adjust the position of the camera with the tripod head. Do not twist the camera.

Monitor

The display on the rear of the camera is an LCD monitor.

- In the unlikely event that the monitor breaks, do not put the liquid crystal in your mouth. Any of the material adhering to your hands, feet, or clothing should be rinsed off immediately.
- A strip of light may appear on the top/bottom of the monitor, but this is not a malfunction.
- When a subject is viewed diagonally in the camera, the edges may appear zigzagged on the monitor. This is not a malfunction; it will be less noticeable in playback mode.
- In places subject to low temperatures, the monitor may take a long time to turn on or its color may change temporarily. When using the camera in extremely cold places, it is a good idea to occasionally place it in a warm place. An monitor exhibiting poor performance due to low temperatures will recover in normal temperatures.
- The monitor is made with high-precision technology. However, black spots or bright spots of light may appear constantly on the monitor. Due to its characteristics or the angle at which you are viewing the monitor, the spot may not be uniform in color and brightness. This is not a malfunction.

Lens

- Do not immerse in water or splash with water.
- Do not drop or exert strong force on the lens.
- Do not hold at the moving part of the lens.
- Do not touch the lens surface directly.
- Do not touch the contact points directly.
- Do not subject to abrupt temperature changes.
- The operating temperature range is -10°C -40°C (14°F – 104°F). Always use within this temperature range.

Legal and Other Notices

- Olympus makes no representations or warranties regarding any damages, or benefit expected by using this unit lawfully, or any request from a third person, which are caused by the inappropriate use of this product.
- Olympus makes no representations or warranties regarding any damages or any benefit expected by using this unit lawfully which are caused by erasing picture data.

Disclaimer of Warranty

- Olympus makes no representations or warranties, either expressed or implied, by or concerning any content of these written materials or software, and in no event shall be liable for any implied warranty of merchantability or fitness for any particular purpose or for any consequential, incidental or indirect damages (including but not limited to damages for loss of business profits, business interruption and loss of business information) arising from the use or inability to use these written materials or software or equipment. Some countries do not allow the exclusion or limitation of liability for consequential or incidental damages, so the above limitations may not apply to you.
- Olympus reserves all rights to this manual.

Warning

Unauthorized photographing or use of copyrighted material may violate applicable copyright laws. Olympus assumes no responsibility for unauthorized photographing, use or other acts that infringe upon the rights of copyright owners.

Copyright Notice

All rights reserved. No part of these written materials or this software may be reproduced or used in any form or by any means, electronic or mechanical, including photocopying and recording or the use of any type of information storage and retrieval system, without the prior written permission of Olympus. No liability

is assumed with respect to the use of the information contained in these written materials or software, or for damages resulting from the use of the information contained therein. Olympus reserves the right to alter the features and contents of this publication or software without obligation or advance notice.

FCC Notice

- Radio and Television Interference
Changes or modifications not expressly approved by the manufacturer may void the user's authority to operate this equipment. This equipment has been tested and found to comply with the limits for a Class B digital device, pursuant to Part 15 of the FCC Rules. These limits are designed to provide reasonable protection against harmful interference in a residential installation. This equipment generates, uses, and can radiate radio frequency energy and, if not installed and used in accordance with the instructions, may cause harmful interference to radio communications. However, there is no guarantee that interference will not occur in a particular installation. If this equipment does cause harmful interference to radio or television reception, which can be determined by turning the equipment off and on, the user is encouraged to try to correct the interference by one or more of the following measures:
 - Adjust or relocate the receiving antenna.
 - Increase the distance between the camera and receiver.
 - Connect the equipment to an outlet on a circuit different from that to which the receiver is connected.
 - Consult your dealer or an experienced radio/TV technician for help. Only the OLYMPUS-supplied USB cable should be used to connect the camera to USB enabled personal computers (PC).

Any unauthorized changes or modifications to this equipment would void the user's authority to operate it.

Use Only Dedicated Rechargeable Battery and Battery Charger

We strongly recommend that you use only the genuine Olympus dedicated rechargeable battery and battery charger with this camera. Using a non-genuine rechargeable battery and/or battery charger may result in fire or personal injury due to leakage, heating, ignition or damage to the battery. Olympus does not assume any liability for accidents or damage that may result from the use of a battery and/or battery charger that are not genuine Olympus accessories.

For customers in North and South America

For customers in USA

Declaration of Conformity

Model Number : E-PM1

Trade Name : OLYMPUS

Responsible Party : **OLYMPUS IMAGING AMERICA INC.**

Address : 3500 Corporate Parkway, P. O. Box 610, Center Valley, PA 18034-0610, USA

Telephone Number : 484-896-5000

Tested To Comply With FCC Standards

FOR HOME OR OFFICE USE

This device complies with Part 15 of the FCC rules. Operation is subject to the following two conditions:

- (1) This device may not cause harmful interference.
- (2) This device must accept any interference received, including interference that may cause undesired operation.

For customers in Canada

This Class B digital apparatus complies with Canadian ICES-003.

OLYMPUS WORLDWIDE LIMITED WARRANTY - IMAGING PRODUCTS

Olympus warrants that the enclosed Olympus® imaging product(s) and related Olympus® accessories (individually a "Product" and collectively the "Products") will be free from defects in materials and workmanship under normal use and service for a period of one (1) year from the date of purchase.

If any Product proves to be defective within the one-year warranty period, the customer must return the defective Product to any of Olympus Service Centers, following the procedure set forth below (See "WHAT TO DO WHEN SERVICE IS NEEDED").

Olympus, at its sole discretion, will repair, replace, or adjust the defective Product, provided that Olympus investigation and factory inspection disclose that (a) such defect developed under normal and proper use and (b) the Product is covered under this limited warranty.

Repair, replacement, or adjustment of defective Products shall be Olympus's sole obligation and the customer's sole remedy hereunder.

The customer is liable and shall pay for shipment of the Products to the Olympus Service Center.

Olympus shall not be obligated to perform preventive maintenance, installation, deinstallation, or maintenance.

Olympus reserves the right to (i) use reconditioned, refurbished, and/or serviceable used parts (that meet Olympus's quality assurance standards) for warranty or any other repairs and (ii) make any internal or external design and/or feature changes on or to its products without any liability to incorporate such changes on or to the Products.

WHAT IS NOT COVERED BY THIS LIMITED WARRANTY

Excluded from this limited warranty and not warranted by Olympus in any fashion, either express, implied, or by statute, are:

- (a) products and accessories not manufactured by Olympus and/or not bearing the "OLYMPUS" brand label (the warranty coverage for products and accessories of other manufacturers, which may be distributed by Olympus, is the responsibility of the manufacturers of such products and accessories in accordance with the terms and duration of such manufacturers' warranties);
- (b) any Product which has been disassembled, repaired, tampered with, altered, changed, or modified by persons other than Olympus's own authorized service personnel unless repair by others is made with the written consent of Olympus;
- (c) defects or damage to the Products resulting from wear, tear, misuse, abuse, negligence, sand, liquids, impact, improper storage, nonperformance of scheduled operator and maintenance items, battery leakage, use of non-"OLYMPUS" brand accessories, consumables, or supplies, or use of the Products in combination with non-compatible devices;
- (d) software programs;
- (e) supplies and consumables (including but not limited to lamps, ink, paper, film, prints, negatives, cables and batteries); and/or
- (f) Products which do not contain a validly placed and recorded Olympus serial number, unless they are a model on which Olympus does not place and record serial numbers.

EXCEPT FOR THE LIMITED WARRANTY SET FORTH ABOVE, OLYMPUS MAKES NO AND DISCLAIMS ALL OTHER REPRESENTATIONS, GUARANTIES, CONDITIONS, AND WARRANTIES CONCERNING THE PRODUCTS, WHETHER DIRECT OR INDIRECT, EXPRESS OR IMPLIED, OR ARISING UNDER ANY STATUTE, ORDINANCE, COMMERCIAL USAGE OR OTHERWISE, INCLUDING BUT NOT LIMITED TO ANY WARRANTY OR REPRESENTATION AS TO THE SUITABILITY, DURABILITY, DESIGN, OPERATION, OR CONDITION OF THE PRODUCTS (OR ANY PART THEREOF) OR THE MERCHANTABILITY OF THE PRODUCTS OR THEIR FITNESS FOR A PARTICULAR PURPOSE, OR RELATING TO THE INFRINGEMENT OF ANY PATENT, COPYRIGHT, OR OTHER PROPRIETARY RIGHT USED OR INCLUDED THEREIN.

IF ANY IMPLIED WARRANTIES APPLY AS A MATTER OF LAW, THEY ARE LIMITED IN DURATION TO THE LENGTH OF THIS LIMITED WARRANTY.

SOME STATES MAY NOT RECOGNIZE A DISCLAIMER OR LIMITATION OF WARRANTIES AND/OR LIMITATION OF LIABILITY SO THE ABOVE DISCLAIMERS AND EXCLUSIONS MAY NOT APPLY. THE CUSTOMER MAY ALSO HAVE DIFFERENT AND/OR ADDITIONAL RIGHTS AND REMEDIES THAT VARY FROM STATE TO STATE.

THE CUSTOMER ACKNOWLEDGES AND AGREES THAT OLYMPUS SHALL NOT BE RESPONSIBLE FOR ANY DAMAGES THAT THE CUSTOMER MAY INCUR FROM DELAYED SHIPMENT, PRODUCT FAILURE, PRODUCT DESIGN, SELECTION, OR PRODUCTION, IMAGE OR DATA LOSS OR IMPAIRMENT OR FROM ANY OTHER CAUSE, WHETHER LIABILITY IS ASSERTED IN CONTRACT, TORT (INCLUDING NEGLIGENCE AND STRICT PRODUCT LIABILITY) OR OTHERWISE. IN NO EVENT SHALL OLYMPUS BE LIABLE FOR ANY INDIRECT, INCIDENTAL, CONSEQUENTIAL OR SPECIAL DAMAGES OF ANY KIND (INCLUDING WITHOUT LIMITATION LOSS OF PROFITS OR LOSS OF USE), WHETHER OR NOT OLYMPUS SHALL BE OR SHOULD BE AWARE OF THE POSSIBILITY OF SUCH POTENTIAL LOSS OR DAMAGE.

Representations and warranties made by any person, including but not limited to dealers, representatives, salespersons, or agents of Olympus, which are inconsistent or in conflict with or in addition to the terms of this limited warranty, shall not be binding upon Olympus unless reduced to writing and approved by an expressly authorized officer of Olympus.

This limited warranty is the complete and exclusive statement of warranty which Olympus agrees to provide with respect to the Products and it shall supersede all prior and contemporaneous oral or written agreements, understandings, proposals, and communications pertaining to the subject matter hereof.

This limited warranty is exclusively for the benefit of the original customer and cannot be transferred or assigned.

WHAT TO DO WHEN SERVICE IS NEEDED

The customer must transfer any image or other data saved on a Product to another image or data storage medium and/or remove any film from the Product prior to sending the Product to Olympus for service.

IN NO EVENT SHALL OLYMPUS BE RESPONSIBLE FOR SAVING, KEEPING OR MAINTAINING ANY IMAGE OR DATA SAVED ON A PRODUCT RECEIVED BY IT FOR SERVICE, OR ON ANY FILM CONTAINED WITHIN A PRODUCT RECEIVED BY IT FOR SERVICE, NOR SHALL OLYMPUS BE RESPONSIBLE FOR ANY DAMAGES IN THE EVENT ANY IMAGE OR DATA IS LOST OR IMPAIRED WHILE SERVICE IS BEING PERFORMED (INCLUDING, WITHOUT LIMITATION, DIRECT, INDIRECT, INCIDENTAL, CONSEQUENTIAL OR SPECIAL DAMAGES, LOSS OF PROFITS OR LOSS OF USE), WHETHER OR NOT OLYMPUS SHALL BE OR SHOULD BE AWARE OF THE POSSIBILITY OF SUCH POTENTIAL LOSS OR IMPAIRMENT.

Package the Product carefully using ample padding material to prevent damage in transit and either deliver it to the Authorized Olympus Dealer that sold you the Product or ship it postage prepaid and insured to any of our Olympus Service Centers.

When returning Products for service, your package should include the following:

- 1 Sales receipt showing date and place of purchase.
- 2 Copy of this limited warranty **bearing the Product serial number corresponding to the serial number on the Product** (unless it is a model on which Olympus does not place and record serial numbers).

- 3 A detailed description of the problem.
 - 4 Sample prints, negatives, digital prints (or files on disk) if available and related to the problem.
- When service is completed, the Product will be returned to you postage prepaid.

WHERE TO SEND PRODUCT FOR SERVICE

See "WORLDWIDE WARRANTY" for the nearest service center.

INTERNATIONAL WARRANTY SERVICE

International warranty service is available under this warranty.

For customers in Europe



"CE" mark indicates that this product complies with the European requirements for safety, health, environment and customer protection. "CE" mark cameras are intended for sales in Europe.



This symbol [crossed-out wheeled bin WEEE Annex IV] indicates separate collection of waste electrical and electronic equipment in the EU countries. Please do not throw the equipment into the domestic refuse.

Please use the return and collection systems available in your country for the disposal of this product.



This symbol [crossed-out wheeled bin Directive 2006/66/EC Annex II] indicates separate collection of waste batteries in the EU countries.

Please do not throw the batteries into the domestic refuse.

Please use the return and collection systems available in your country for the disposal of the waste batteries.

Provisions of warranty

- 1 If this product proves to be defective, although it has been used properly (in accordance with the written Handling Care and Operating instructions supplied with it), during the applicable national warranty period and has been purchased from an authorized Olympus distributor within the business area of Olympus Europa Holding GmbH as stipulated on the website: <http://www.olympus.com> this product will be repaired, or at Olympus's option replaced, free of charge. To claim under this warranty the customer must take the product before the end of the applicable national warranty period to the dealer where the product was purchased or any other Olympus service station within the business area of Olympus Europa Holding GmbH as stipulated on the website: <http://www.olympus.com>. During the one year period of the World Wide Guarantee the customer may turn the product in at any Olympus service station. Please notice that not in all countries such Olympus service station exists.
- 2 The customer shall transport the product to the dealer or Olympus authorized service station at his own risk and shall be responsible for any costs incurred in transporting the product.

Provisions of Guarantee



- 1 "OLYMPUS IMAGING CORP., Shinjuku Monolith, 2-3-1 Nishi-Shinjuku, Shinjuku-ku, Tokyo 163-0914, Japan grants a one year World Wide Guarantee. This worldwide Guarantee must be presented at an Olympus authorized repair service station before any repair can be made under conditions of this Guarantee. This Guarantee is valid only if the Guarantee Certificate and proof of purchase are presented at the Olympus repair service station. Please note that this Guarantee is in addition to and does not affect the customer's legal warranty rights under the applicable national legislation governing the sale of consumer goods mentioned above.
- 2 This Guarantee does not cover the following and the customer will be required to pay repair charge, even for defects occurring within the Guarantee period referred to above.
 - (a) Any defect that occurs due to mishandling (such as an operation performed that is not mentioned in the Handling Care or other sections of the instructions, etc.)
 - (b) Any defect that occurs due to repair, modification, cleaning, etc. performed by anyone other than Olympus or an Olympus authorized service station.
 - (c) Any defect or damage that occurs due to transport, a fall, shock, etc. after purchase of the product.

- (d) Any defect or damage that occurs due to fire, earthquake, flood damage, thunderbolt, other natural disasters, environmental pollution and irregular voltage sources.
 - (e) Any defect that occurs due to careless or improper storage (such as keeping the product under conditions of high temperature and humidity, near insect repellents such as naphthalene or harmful drugs, etc.), improper maintenance, etc.
 - (f) Any defect that occurs due to exhausted batteries, etc.
 - (g) Any defect that occurs due to sand, mud, etc. entering the inside of the product casing.
 - (h) When the Guarantee Certificate is not returned with the product.
 - (i) When any alterations whatsoever are made to the Guarantee Certificate regarding the year, month and date of purchase, the customer's name, the dealer's name, and the serial number.
 - (j) When proof of purchase is not presented with this Guarantee Certificate.
- 3 This Guarantee applies to the product only; the Guarantee does not apply to any other accessory equipment, such as the case, strap, lens cap and batteries.
 - 4 Olympus's sole liability under this Guarantee shall be limited to repairing or replacing the product. Any liability under the Guarantee for indirect or consequential loss or damage of any kind incurred or suffered by the customer due to a defect of the product, and in particular any loss or damage caused to any lenses, films, other equipment or accessories used with the product or for any loss resulting from a delay in repair or loss of data, is excluded. Compelling regulations by law remain unaffected by this.

Notes regarding Guarantee maintenance

- 1 This Guarantee will only be valid if the Guarantee Certificate is duly completed by Olympus or an authorized dealer or other documents contain sufficient proof. Therefore, please make sure that your name, the name of the dealer, the serial number and the year, month and date of purchase are all completed or the original invoice or the sales receipt (indicating the dealer's name, the date of purchase and product type) is attached to this Guarantee Certificate. Olympus reserves the right to refuse free-of-charge service if neither Guarantee Certificate is completed nor the above document is attached or if the information contained in it is incomplete or illegible.
- 2 Since this Guarantee Certificate will not be re-issued, keep it in a safe place.
 - Please refer to the list on the website: [http:// www.olympus.com](http://www.olympus.com) for the authorized international Olympus service network.

Trademarks

- IBM is a registered trademark of International Business Machines Corporation.
 - Microsoft and Windows are registered trademarks of Microsoft Corporation.
 - Macintosh is a trademark of Apple Inc.
 - The SDHC and SDXC logos are trademarks.
 - Eye-Fi is a trademark of Eye-Fi, Inc.
 - "Shadow Adjustment Technology" function contains patented technologies from Apical Limited.
- 
- apical**
- AVCHD and the AVCHD logo are trademarks of the Sony and Panasonic corporations.
 - Manufactured with an implementation license from Dolby Laboratories. Dolby and the double-D logo are trademarks of Dolby Laboratories.
 - Slideshow transition technology supplied by HI Corporation.
- 
- MASCOT CAPSULE**
- All other company and product names are registered trademarks and/or trademarks of their respective owners.
 - Micro Four Thirds and the Micro Four Thirds logo are trademarks or registered trademarks of OLYMPUS IMAGING Corporation in Japan, the United States, the countries of the European Union, and other countries.
 - "PENPAL" is used in reference to the OLYMPUS PENPAL.
 - The standards for camera file systems referred to in this manual are the "Design Rule for Camera File System/DCF" standards stipulated by the Japan Electronics and Information Technology Industries Association (JEITA).

THIS PRODUCT IS LICENSED UNDER THE AVC PATENT PORTFOLIO LICENSE FOR THE PERSONAL AND NONCOMMERCIAL USE OF A CONSUMER TO (i) ENCODE VIDEO IN COMPLIANCE WITH THE AVC STANDARD ("AVC VIDEO") AND/OR (ii) DECODE AVC VIDEO THAT WAS ENCODED BY A CONSUMER ENGAGED IN A PERSONAL AND NON-COMMERCIAL ACTIVITY AND/OR WAS OBTAINED FROM A VIDEO PROVIDER LICENSED TO PROVIDE AVC VIDEO. NO LICENSE IS GRANTED OR SHALL BE IMPLIED FOR ANY OTHER USE. ADDITIONAL INFORMATION MAY BE OBTAINED FROM MPEG LA, L.L.C. SEE [HTTP://WWW.MPEGLA.COM](http://www.mpegla.com)

System chart

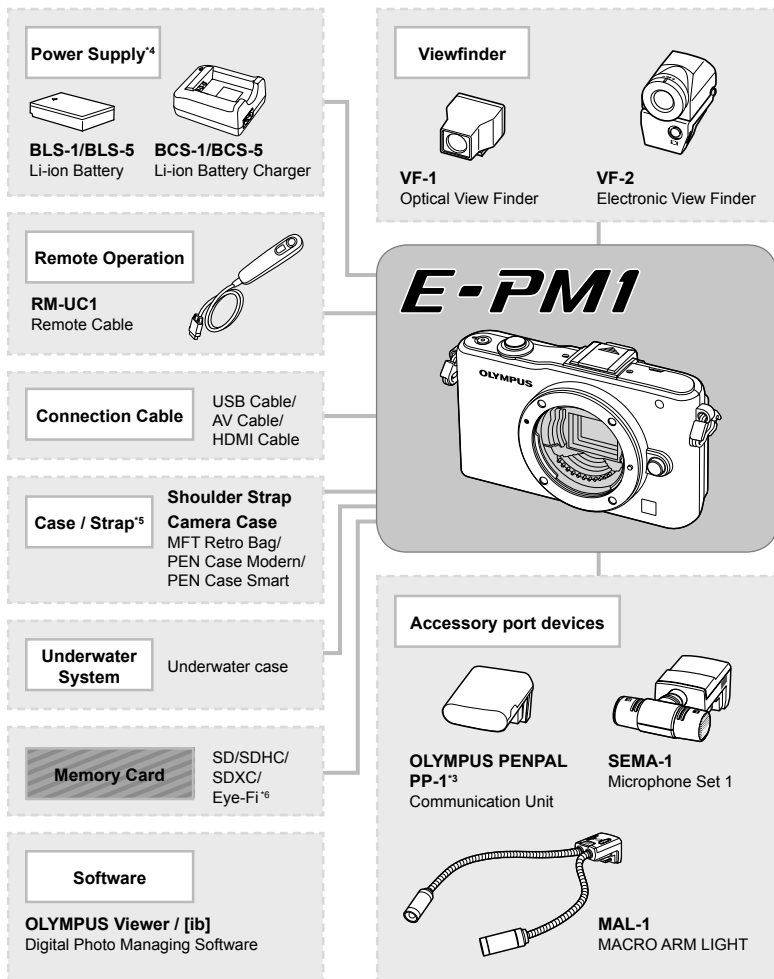



*1 Not all lenses can be used with adapter. For details, refer to the Olympus official website. Also, please note that manufacture of OM System Lenses has been discontinued.

*2 For compatible lens, refer to the Olympus official website.

*3 The OLYMPUS PENPAL can be used only in the region in which it was purchased. Depending on the areas, the usage may infringe the wave regulations and may be subject to its penalty.

*4 Use only compatible battery chargers to charge rechargeable batteries.

 : E-PM1 compatible products

 : Commercially available products

For the latest information, please visit the Olympus website.

Lens



M.ZUIKO DIGITAL ED 12mm f2.0
M.ZUIKO DIGITAL 17mm f2.8
M.ZUIKO DIGITAL 45mm f1.8
M.ZUIKO DIGITAL 14-42mm f3.5-5.6 II R
M.ZUIKO DIGITAL ED 9-18mm f4.0-5.6
M.ZUIKO DIGITAL ED 14-150mm f4.0-5.6
M.ZUIKO DIGITAL ED 40-150mm f4.0-5.6 R
M.ZUIKO DIGITAL ED 75-300mm f4.8-6.7



MMF-2^{*1}
Four Thirds Adapter



Four Thirds System Lenses



MF-2^{*1}
OM Adapter 2

OM System Lenses

Converter Lens^{*2}



FCON-P01
Fisheye



WCON-P01
Wide



MCON-P01
Macro

Flash

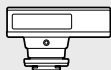

FL-14
Electronic Flash

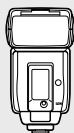

FL-50R
Electronic Flash



FL-36R
Electronic Flash



FL-300R
Electronic Flash

SRF-11 Ring Flash Set



RF-11^{*2}
Ring Flash

STF-22 Twin Flash Set



TF-22^{*2}
Twin Flash

FC-1 Macro Flash Controller

*5 Some accessories may not be available in your region.

*6 Use in accordance with local regulations.

Index

Symbols



	Shooting Menu 1	107
	Shooting Menu 2	107
	Playback Menu	107
	Setup Menu	80, 108
	Custom Menu	81, 108
	Accessory port menu	90, 110
	AF/MF	81
	Button/Dial	82
	Release/Menu	83
	Disp/PC	83
	Exp/ISO	84
	Custom	85
	Color/WB	85
	Record/Erase	86
	Movie	87
	Utility	88
	OLYMPUS PENPAL Share	90
	OLYMPUS PENPAL Album	90
	Electronic Viewfinder	90
	L (Large)	47
	M (Middle)	47, 86
	S (Small)	47, 86
	RC Mode	93
	(Language selection)	80
	Menu Display	80, 81
	Set Home	82
	Face Priority	39, 82
	Lock	82
	H fps	83
	L fps	83
	Info Settings	83
	Control Settings	83
	(Beep sound)	84
	Slow Limit	85
	X-Sync	85
	Keep Warm Color	85



	+WB	85
	Set	86
	Warning Level	88
	REC	89
	Home	89
	AEL (AE lock)	41
	ART (Art filter mode)	18
	SCN (Scene mode)	19
	(Movie mode)	61
	(Close-up playback/Magnify)	16, 64/89
	(Index display)	63

A





	Adding sound to still pictures	68
	Address Book	72, 90
	AE BKT	57
	AEL Metering	84
	AEL/AFL	82, 88, 89
	AEL/AFL Memo	82
	AF Area	37
	AF illuminator	82
	AF Mode	36, 81
	AF target	37
	Album Mem. Setup	90
	Album Mem. Usage	90
	All WB	85
	All Erase	65
	All Targets	37
	Anti-Shock	84
	Aperture priority shooting	51
	Aperture value	14, 51, 53
	ART BKT	58
	ART LV Mode	83
	Aspect	67
	Auto flash	59
	Auto focus	14, 36, 94
	Auto white balance	43

B	
B&W Filter	46
Backlit LCD	84, 89
Battery	4, 8, 100
BGM	66
Black & White	67
Bracketing	57
Bulb Focusing	81
Bulb shooting	53
Bulb Timer	84
Button Function	82





C	
C-AF (continuous AF)	36
C-AF+TR (AF Tracking)	36
Calendar display	63
Card	5, 99
Card Setup	65, 99
Center weighted averaging metering 	41
Color Space	85
Compression rate	47
Continuous AF (C-AF)	36
Converter lenses	102
Contrast	46
Copy All	72
Copyright Settings	87
Custom 	45
Custom white balance CWB	43



D	
Date/time setting 	9
Dial Direction	82
Dial Function	82
Digital ESP metering 	41
Digital Tele-converter	58, 89
Direct print	77
dpi Setting	87
Dust reduction	8, 98

E	
Easy printing	78
Easy shooting modes	12
Edit Filename	87
Effect	46
Electronic viewfinder	102
e-Portrait	67
EV Step	84
EVF Adjust	90
Exposure compensation 	40
Exposure Shift	88
Eye-Fi	88
Eye-Fi card	5, 99

F	
File Name	86
Fill-in flash 	59
Firmware	80
FL BKT	58
Flash	59
Flash intensity control 	60
Flash mode 	59
Flash off 	59
Focus lock	37
Focus Ring	82
Format	99
Four Thirds system lenses	100
Full-time AF	81

G	
Gradation	46
Group Target	37
H	
HD	48
High Key	46
Histogram	32, 33
Histogram Settings	83
Home position 	82

I	
iAUTO shooting IAUTO	12, 13, 20
i-Enhance 	45
Image Aspect	48
Image Overlay	68
Image size	47
Image Stabilizer IS	42
INFO button.....	11, 32, 33, 34
Information display	32, 33
IS (Image stabilizer).....	42
ISO	48, 84
ISO BKT	58
ISO Step	84
ISO-Auto.....	84
ISO-Auto Set	84
J	
JPEG	47
JPEG Edit.....	67
L	
Lens.....	6, 100
Lithium ion battery	4, 100, 114
Lithium ion charger	4, 100
Live Control	22
Live Guide	20, 89
Live View Boost.....	83
Low Key.....	46
M	
Manual focus (MF).....	36
Manual shooting M	53
Metering.....	41
MF (manual focus).....	36, 89
MF Assist.....	82
Micro Four Thirds system lenses.....	100
Mode Guide	83
Monitor brightness adjustment 	80
Monotone M	45
Movie Play.....	62
Movie 	62, 87
Movie shooting 	15, 61

Movie+Still	87, 92
MTP.....	75
Multi view display.....	32, 40
Multiple Exposure 	56
Muted 	45
My OLYMPUS PENPAL.....	90
Myset	35, 89



N

Natural 	45
Noise Filter	85
Noise Reduct.....	85
NTSC.....	69, 83

O

OLYMPUS PENPAL	71, 90
One-touch white balance 	43, 44, 89





P

PAL	69, 83
Panorama	54
Pict. Tone.....	46
PictBridge	77
Picture Copy Size	90
Picture Mode	45
Picture Mode Settings	83
Picture Send Size	90
Pixel Count	86
Pixel Mapping	98
Playback on TV	69
Please Wait	71, 90
Portrait 	45
Preset white balance	43
Preview.....	51, 89
Print	77
Print reservation 	76
Priority Set.....	87
Program shift Ps	50
Program shooting P	50





Q







Quick Erase.....	86
------------------	----

R

RAW	47
RAW Data Edit	67
RAW 	89
RAW+JPEG Erase	86
Rec View	80
Record mode 	47, 107
Redeye Fix	67
Red-eye reduction flash 	59
Reset Lens	81
Reset/Myset	35
Reset Protect	65, 90
Resizing 	67
RIs Priority C	83
RIs Priority S	83
Rotate	65

S



S-AF (single AF)	36
S-AF+MF	36
Saturation	46, 67
SD	48
SD/SDHC/SDXC card	5, 99
Self-timer 	49
Sepia	67
Sequential shooting 	49
Shading Comp.	85
Shadow Adj.	67
Sharpness	46
Shutter priority shooting S	52
Shutter speed	14, 52, 53
Single AF (S-AF)	36
Single Target	37
Single-frame shooting 	49
Sleep	84
Slide	66
Slideshow 	66
Slow synchronization (1st curtain)  SLOW	59

Slow synchronization (1st curtain)/ Red-eye reduction flash  SLOW	59
Slow synchronization (2nd curtain)  SLOW2/  2nd-C	59
Spot metering - highlight control  HI	41
Spot metering - shadow control  SH	41
Spot metering 	41
Storage	75
Strap	3
Super control panel	91
Super FP flash	105

T

Test Picture	89
Tone control	34, 40
Trimming 	67, 79

U

Underwater wide/Underwater macro  / 	89
USB Mode	84

V

Video Out	83
Vivid 	45
Volume	84

W

WB	43, 85
WB BKT	57
White balance compensation 	44
White balance WB	43

Z

Zoom display	38
Zoom frame AF	38

OLYMPUS EUROPA HOLDING GMBH

Premises: Consumer Product Division
Wendenstrasse 14 – 18, 20097 Hamburg, Germany
Tel.: +49 40 - 23 77 3-0 / Fax: +49 40 - 23 07 61

Goods delivery: Bredowstrasse 20, 22113 Hamburg, Germany

Letters: Postfach 10 49 08, 20034 Hamburg, Germany

European Technical Customer Support:

Please visit our homepage <http://www.olympus-europa.com>
or call our TOLL FREE NUMBER*: **00800 - 67 10 83 00**

for Austria, Belgium, Denmark, Finland, France, Germany, Luxemburg, Netherlands,
Norway, Portugal, Spain, Sweden, Switzerland, United Kingdom.

* Please note some (mobile) phone services / provider do not permit access or request an
additional prefix to +800 numbers.

For all not listed European Countries and in case that you can't get connected
to the above mentioned number please make use of the following

CHARGED NUMBERS: **+49 180 5 - 67 10 83** or **+49 40 - 237 73 48 99**.

Our Technical Customer Support is available from 9 am to 6 pm MET (Monday to Friday).

Authorized Distributors

United Kingdom: **Olympus Service Department**
/Eire

Olympus Imaging & Audio
KeyMed House
Stock Road
Southend-on-Sea
Essex
SS2 5QH
United Kingdom

South Africa: **Tudor Photographic**

4th floor, Park on Long
66 Long Street
Cape Town 8001
South Africa
Tel: +27 (0) 21 423 4150
Fax: +27 (0) 21 424 4632

Sales - 0800 111 4777
Service - 0800 111 4888
Facsimile - +44 (0)1702 445134
email - consumer@olympus.co.uk
www.olympus.co.uk



<http://www.olympus.com/>

OLYMPUS IMAGING CORP.

Shinjuku Monolith, 3-1 Nishi-Shinjuku 2-chome, Shinjuku-ku, Tokyo, Japan

OLYMPUS IMAGING AMERICA INC.

3500 Corporate Parkway, P.O. Box 610, Center Valley, PA 18034-0610, U.S.A. Tel. 484-896-5000

Technical Support (U.S.A.)

24/7 online automated help: <http://www.olympusamerica.com/DSLR>

Phone customer support: Tel. 1-800-260-1625 (Toll-free)

Our phone customer support is available from 9am to 9pm (Monday to Friday) ET

E-Mail: e-slrpro@olympus.com

Olympus software updates can be obtained at: <http://www.olympusamerica.com/digital>

To find the nearest Service Centers, please visit: <http://www.olympusamerica.com/digital>, and click on the Worldwide Warranty icon at the bottom of the page.

Service Centers

U.S.A.:

New York

Olympus Imaging America Inc.

400 Rabro Drive

Hauppauge, NY 11788-4258

Tel: (800) 260-1625

FAX: (631) 881-6510

Canada:

Trinitek Electronics Inc.

3105 Unity Drive, Unit 20

Mississauga Ontario Canada

L5L4L3

Tel: (800) 260-1625

Mexico:

Olympus Imaging de Mexico

S.A. de C.V.

WTC Mexico, Montecito

No.38 - Planta Baja Local 12

Col. Nápoles, Mexico D.F. 03810

Tel: (01800) 900-1280/900-1281