

Nikon

DIGITAL CAMERA

COOLPIX S9500
S9400
Reference Manual

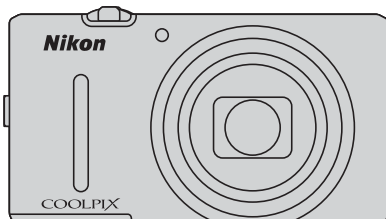

En



COOLPIX S9500/S9400 Recommended Features



Quick Effects **32**

You can apply various effects to images immediately after releasing the shutter. While you check the end results of an image on the preview screen of each effect, you can create a picture to suit the scene or your mood. You can also apply effects to images later by pressing the  button during playback.

(Movie) **82**

You can record movies by simply pressing the  ( movie-record) button. You can change the color tones of a movie in accordance with the shooting mode and white balance settings. Movies that can be played back in slow motion or fast motion can be recorded.

GPS Function (COOLPIX S9500 only) **88**

You can record position information (latitude and longitude) on the pictures to be shot using the camera's internal GPS unit.

Wi-Fi (Wireless LAN) Feature (COOLPIX S9500 only) **93**

You can use the camera's internal Wi-Fi feature to automatically transfer pictures that you shot to your smart device or operate the camera using relevant software of the smart device.

Introduction	
Parts of the Camera and Main Functions	
The Basics of Shooting and Playback	
Shooting Features	
Playback Features	
Recording and Playing Back Movies	
Using GPS/Electronic Compass (COOLPIX S9500 only)	
Using the Wi-Fi (Wireless LAN) Feature (COOLPIX S9500 only)	
General Camera Setup	
Reference Section	
Technical Notes and Index	

Introduction

Read This First

Thank you for purchasing the Nikon COOLPIX S9500 or COOLPIX S9400 digital camera.

Before using the camera, please read the information in “For Your Safety” (📖vi to 📖viii) and familiarize yourself with the information provided in this manual. After reading, please keep this manual handy and refer to it to enhance your enjoyment of your new camera.

About This Manual





If you want to start using the camera right away, see “The Basics of Shooting and Playback” (📖 12).

See “Parts of the Camera and Main Functions” (📖 1) for more information on the names and principle functions of the camera parts.

Other Information

- Symbols and Conventions

To make it easier to find the information you need, the following symbols and conventions are used in this manual:

Icon	Description
	This icon indicates cautions and information that should be read before using the camera.
	This icon marks notes, information that should be read before using the camera.
	These icons indicate other pages containing relevant information;  : “Reference Section,”  : “Technical Notes and Index.”

- SD, SDHC and SDXC memory cards are referred to as “memory cards” in this manual.
- The setting at the time of purchase is referred to as the “default setting.”
- The names of menu items displayed in the monitor screen, and the names of buttons or messages displayed on a computer monitor appear in bold.
- In this manual, images are sometimes omitted from monitor screen samples so that monitor indicators can be more clearly shown.
- The illustrations of monitor content and camera may differ from the actual product.
- The COOLPIX S9500 is used for the illustrations and monitor contents in this manual. Illustrations for both the COOLPIX S9500 and the COOLPIX S9400 are provided when necessary.

Information and Precautions

Life-Long Learning

As part of Nikon's "Life-Long Learning" commitment to ongoing product support and education, continually updated information is available online at the following sites:

- For users in the U.S.A.: <http://www.nikonusa.com/>
- For users in Europe and Africa: <http://www.europe-nikon.com/support/>
- For users in Asia, Oceania, and the Middle East: <http://www.nikon-asia.com/>

Visit these sites to keep up-to-date with the latest product information, tips, answers to frequently asked questions (FAQs), and general advice on digital imaging and photography. Additional information may be available from the Nikon representative in your area. Visit the site below for contact information:

<http://imaging.nikon.com/>

Use Only Nikon Brand Electronic Accessories

Nikon COOLPIX cameras are designed to the highest standards and include complex electronic circuitry. Only Nikon brand electronic accessories (including battery chargers, batteries, Charging AC Adapter and AC adapters) certified by Nikon specifically for use with this Nikon digital camera are engineered and proven to operate within the operational and safety requirements of this electronic circuitry.

THE USE OF NON-NIKON ELECTRONIC ACCESSORIES COULD DAMAGE THE CAMERA AND MAY VOID YOUR NIKON WARRANTY.

The use of third-party rechargeable Li-ion batteries not bearing the Nikon holographic seal could interfere with normal operation of the camera or result in the batteries overheating, igniting, rupturing, or leaking.

For more information about Nikon brand accessories, contact a local authorized Nikon dealer.

Holographic seal: Identifies this device as an authentic Nikon product.



Before Taking Important Pictures

Before taking pictures on important occasions (such as at weddings or before taking the camera on a trip), take a test shot to ensure that the camera is functioning normally. Nikon will not be held liable for damages or lost profits that may result from product malfunction.

About the Manuals

- No part of the manuals included with this product may be reproduced, transmitted, transcribed, stored in a retrieval system, or translated into any language in any form, by any means, without Nikon's prior written permission.
- Nikon will not be held liable for any damages resulting from the use of this product.
- Nikon reserves the right to change the specifications of the hardware and software described in the documentation at any time and without prior notice.
- While every effort was made to ensure that the information in the documentation is accurate and complete, we would appreciate it were you to bring any errors or omissions to the attention of the Nikon representative in your area (address provided separately).

Notice Concerning Prohibition of Copying or Reproduction

Note that simply being in possession of material that was digitally copied or reproduced by means of a scanner, digital camera or other device may be punishable by law.

• Items prohibited by law from being copied or reproduced

Do not copy or reproduce paper money, coins, securities, government bonds or local government bonds, even if such copies or reproductions are stamped "Sample." The copying or reproduction of paper money, coins, or securities which are circulated in a foreign country is prohibited. Unless the prior permission of the government was obtained, the copying or reproduction of unused postage stamps or post cards issued by the government is prohibited.

The copying or reproduction of stamps issued by the government and of certified documents stipulated by law is prohibited.

• Cautions on certain copies and reproductions

The government has issued cautions on copies or reproductions of securities issued by private companies (shares, bills, checks, gift certificates, etc.), commuter passes, or coupon tickets, except when a minimum of necessary copies are to be provided for business use by a company. Also, do not copy or reproduce passports issued by the government, licenses issued by public agencies and private groups, ID cards and tickets, such as passes and meal coupons.

• Comply with copyright notices

The copying or reproduction of copyrighted creative works such as books, music, paintings, woodcut prints, maps, drawings, movies, and photographs is governed by national and international copyright laws. Do not use this product for the purpose of making illegal copies or to infringe copyright laws.

Disposing of Data Storage Devices

Please note that deleting images or formatting data storage devices such as memory cards or built-in camera memory does not completely erase the original image data. Deleted files can sometimes be recovered from discarded storage devices using commercially available software, potentially resulting in the malicious use of personal image data. Ensuring the privacy of such data is the user's responsibility.

Before discarding a data storage device or transferring ownership to another person, erase all data using commercial deletion software, or format the device and then completely refill it with images containing no private information (for example, pictures of empty sky) (For the COOLPIX S9500, set the **Record GPS data** of the **GPS options** (☞91) to **Off**). Be sure to also replace any pictures selected for the **Select an image** option in the **Welcome screen** setting (☞96). Care should be taken to avoid injury or damage to property when physically destroying data storage devices.

- For the COOLPIX S9500, the log data saved on the memory card is handled in the same way as other data. To erase the log data that is obtained but not stored on the memory card, select **Create log** → **End log** → **Erase log**.
- For the COOLPIX S9500, you can clear the **Wi-Fi options** (☞98) setting using **Reset all** in the setup menu.

For Your Safety

To prevent damage to your Nikon product or injury to yourself or to others, read the following safety precautions in their entirety before using this equipment. Keep these safety instructions where all those who use the product will read them.



This icon marks warnings, information that should be read before using this Nikon product, to prevent possible injury.

WARNINGS

Turn off in the event of malfunction

Should you notice smoke or an unusual smell coming from the camera or Charging AC Adapter, unplug the Charging AC Adapter and remove the battery immediately, taking care to avoid burns. Continued operation could result in injury. After removing or disconnecting the power source, take the equipment to a Nikon-authorized service representative for inspection.

Do not disassemble

Touching the internal parts of the camera or Charging AC Adapter could result in injury. Repairs should be performed only by qualified technicians. Should the camera or Charging AC Adapter break open as the result of a fall or other accident, take the product to a Nikon-authorized service representative for inspection, after unplugging the product and/or removing the battery.

Do not use the camera or Charging AC Adapter in the presence of flammable gas

Using the camera in the presence of flammable gases such as propane and gasoline, as well as flammable sprays or dust could result in explosion or fire.

Handle the camera strap with care

Never place the strap around the neck of an infant or child.

Keep out of reach of children

Do not keep the products within reach of children. Doing so may cause injury. Particular care should be taken to prevent infants from putting the battery or other small parts into their mouths.

Do not remain in contact with the camera, Charging AC Adapter, or AC adapter for extended periods while the devices are on or in use.

Parts of the devices become hot. Leaving the devices in direct contact with the skin for extended periods may result in low-temperature burns.

⚠ Observe caution when handling the battery

The battery may leak, overheat, or explode if improperly handled. Observe the following precautions when handling the battery for use in this product:

- Before replacing the battery, turn the product off. If you are using the Charging AC Adapter/AC adapter, be sure it is unplugged.
- Use only the Rechargeable Li-ion Battery EN-EL12 (included). Charge the battery by inserting it into the camera and connecting the Charging AC Adapter EH-70P (included).
- When inserting the battery, do not attempt to insert it upside down or backwards.
- Do not disassemble the battery or attempt to remove or break the battery insulation or casing.
- Do not expose the battery to flame or to excessive heat.
- Do not immerse in or expose to water.
- Replace the terminal cover when transporting the battery. Do not transport or store with metal objects such as necklaces or hairpins.
- The battery is prone to leakage when fully discharged. To avoid damage to the product, be sure to remove the battery when no charge remains.
- Discontinue use immediately should you notice any change in the battery, such as discoloration or deformation.
- If liquid from the damaged battery comes in contact with clothing or skin, rinse immediately with plenty of water.

⚠ Observe the following precautions when handling the Charging AC Adapter

- Keep dry. Failure to observe this precaution could result in fire or electric shock.
- Dust on or near the metal parts of the plug should be removed with a dry cloth. Continued use could result in fire.
- Do not handle the plug or go near the Charging AC Adapter during lightning storms. Failure to observe this precaution could result in electric shock.
- Do not damage, modify, forcibly tug or bend the USB cable, place it under heavy objects, or expose it to heat or flames. Should the insulation be damaged and the wires become exposed, take it to a Nikon-authorized service representative for inspection. Failure to observe these precautions could result in fire or electric shock.
- Do not handle the plug or Charging AC Adapter with wet hands. Failure to observe this precaution could result in electric shock.
- Do not use with travel converters or adapters designed to convert from one voltage to another or with DC-to-AC inverters. Failure to observe this precaution could damage the product or cause overheating or fire.

⚠ Use appropriate cables

When connecting cables to the input and output jacks, use only the cables provided or sold by Nikon for the purpose, to maintain compliance with product regulations.

⚠ Handle moving parts with care

Be careful that your fingers or other objects are not pinched by the lens cover or other moving parts.

⚠ CD-ROMs

The CD-ROMs included with this device should not be played back on audio CD equipment. Playing CD-ROMs on an audio CD player could cause hearing loss or damage the equipment.

⚠ Observe caution when using the flash

Using the flash close to your subject's eyes could cause temporary visual impairment. Particular care should be observed if photographing infants, when the flash should be no less than 1 m (3 ft 4 in.) from the subject.

⚠ Do not operate the flash with the flash window touching a person or object

Failure to observe this precaution could result in burns or fire.

⚠ Turn the power off when using inside an airplane or the hospital

Turn the power off while inside the airplane during take off or landing. When using the COOLPIX S9500, disable the GPS position information recording function before boarding an airplane. Follow the instructions of the hospital when using while in a hospital. The electromagnetic waves emitted by this camera may disrupt the electronic systems of the airplane or the instruments of the hospital. Remove the Eye-Fi card, which can be the cause of the disruption, beforehand if inserted in the camera.

⚠ Drivers should not operate the camera while driving.

This could cause a traffic accident.

⚠ 3D Images

Do not continuously view 3D images recorded with this device for extended periods, whether on a television, monitor, or other display. In the case of children whose visual systems are still maturing, consult a pediatrician or ophthalmologist prior to use and follow their instructions. Prolonged viewing of 3D images may cause eye strain, nausea, or discomfort. Cease use should any of these symptoms occur and consult a physician if necessary.

Notices

Notices for Customers in the U.S.A.

IMPORTANT SAFETY INSTRUCTIONS -

SAVE THESE INSTRUCTIONS.

DANGER - TO REDUCE THE RISK OF FIRE OR ELECTRIC SHOCK, CAREFULLY FOLLOW THESE INSTRUCTIONS

For connection to a supply not in the U.S.A., use an attachment plug adapter of the proper configuration for the power outlet if needed.

The power supply unit is intended to be correctly orientated in a vertical or floor mount position.

Federal Communications Commission (FCC) Radio Frequency Interference Statement

This equipment has been tested and found to comply with the limits for a Class B digital device, pursuant to Part 15 of the FCC rules. These limits are designed to provide reasonable protection against harmful interference in a residential installation. This equipment generates, uses, and can radiate radio frequency energy and, if not installed and used in accordance with the instructions, may cause harmful interference to radio communications. However, there is no guarantee that interference will not occur in a particular installation. If this

equipment does cause harmful interference to radio or television reception, which can be determined by turning the equipment off and on, the user is encouraged to try to correct the interference by one or more of the following measures:

- Reorient or relocate the receiving antenna.
- Increase the separation between the equipment and receiver.
- Connect the equipment into an outlet on a circuit different from that to which the receiver is connected.
- Consult the dealer or an experienced radio/television technician for help.



Nikon
COOLPIX S9500
COOLPIX S9400

CAUTIONS

Modifications

The FCC requires the user to be notified that any changes or modifications made to this device that are not expressly approved by Nikon Corporation may void the user's authority to operate the equipment.

Interface Cables

Use the interface cables sold or provided by Nikon for your equipment. Using other interface cables may exceed the limits of Class B Part 15 of the FCC rules.

Notice for Customers in the State of California

WARNING

Handling the cord on this product will expose you to lead, a chemical known to the State of California to cause birth defects or other reproductive harm.

Wash hands after handling.

Nikon Inc.,
1300 Walt Whitman Road,
Melville, New York 11747-3064
USA
Tel: 631-547-4200

Notice for Customers in Canada

CAUTION

This Class B digital apparatus complies with Canadian ICES-003.

ATTENTION

Cet appareil numérique de la classe B est conforme à la norme NMB-003 du Canada.

Notices for Customers in Europe

CAUTIONS

RISK OF EXPLOSION IF BATTERY IS REPLACED BY AN INCORRECT TYPE.

DISPOSE OF USED BATTERIES ACCORDING TO THE INSTRUCTIONS.

This symbol indicates that this product is to be collected separately.



The following apply only to users in European countries:

- This product is designated for separate collection at an appropriate collection point. Do not dispose of as household waste.
- For more information, contact the retailer or the local authorities in charge of waste management.

This symbol on the battery indicates that the battery is to be collected separately.



The following apply only to users in European countries:

- All batteries, whether marked with this symbol or not, are designated for separate collection at an appropriate collection point. Do not dispose of as household waste.
- For more information, contact the retailer or the local authorities in charge of waste management.

<Important> Notes on GPS/Electronic Compass (COOLPIX S9500 only)

● Location name data of this camera

Before using the GPS function, make sure to read “USER LICENSE AGREEMENT FOR LOCATION NAME DATA (COOLPIX S9500)” (📖:15) and agree to the terms.

- The location name information (Point of Interest: POI) stands as of April 2012. The location name information will not be updated.
- Use the location name information only as a guide.
- The location name information (Point of Interest: POI) of the People's Republic of China (“China”) and the Republic of Korea is not provided for the COOLPIX S9500.

● Notes on GPS Functions

- When **Record GPS data** in **GPS options** of the GPS options menu is set to **On**, GPS functions will continue to operate even after the camera is turned off (📖89).

The electromagnetic waves emitted from this product may affect the measuring instruments of an airplane or medical equipment. When use of the product is prohibited or limited during airplane takeoffs and landings or inside a hospital, set **Record GPS data** to **Off** and then turn off the camera.

- An individual may be identified from still pictures or movies that have been recorded with location information.

Observe caution when you transfer still pictures or movies recorded with location information, or GPS log files to a third party or upload them to a network such as the Internet where the public can view them.

Be sure to read “Disposing of Data Storage Devices” (📖v).

● Notes on GPS and electronic compass

The COOLPIX S9500 is a camera. Do not use this camera as a navigation device or measuring instrument.

- Do not operate the electronic compass while you are driving a car.
- Use information (such as direction) measured by the camera as a guideline only. Do not use this information for navigation of an airplane, car, and person or land survey applications.
- When you use the camera for mountain climbing or trekking, be sure to take a map, navigation device, or measuring instrument separately.

● Using the camera overseas

- Before taking the camera with GPS function overseas for travel, consult your travel agency or embassy of the country you are visiting to confirm whether there is any restriction on use.

For example, you cannot record location information logs without permission from the government in China.

Set the **Record GPS data** to **Off**.

- The GPS may not function properly in China and on the borders between China and neighboring countries (as of December 2012).

Wi-Fi (Wireless LAN Network) Function (COOLPIX S9500 only)

This product is controlled by the United States Export Administration Regulations, and you are required to obtain permission from the United States government if you export or re-export this product to any country to which the United States embargoes goods. The following countries were subject to embargo: Cuba, Iran, North Korea, Sudan, and Syria. Since the target countries are subject to change, please contact the United States Department of Commerce for the latest information.

Restrictions on Wireless Devices

The wireless transceiver included in this product conforms to wireless regulations in the country of sale and is not for use in other countries (products purchased in the EU or EFTA can be used anywhere within the EU and EFTA). Nikon does not accept liability for use in other countries. Users who are unsure as to the original country of sale should consult with their local Nikon service center or Nikon-authorized service representative. This restriction applies to wireless operation only and not to any other use of the product.

Notice for Customers in the U.S.A. and Canada

Federal Communications Commission (FCC) and Industry of Canada (IC) Declaration of Conformity

This device complies with Part 15 of FCC Rules and Industry Canada licence-exempt RSS standard(s). Operation is subject to the following two conditions: (1) this device may not cause interference, and (2) this device must accept any interference, including interference that may cause undesired operation of this device.

FCC/IC RF Exposure Statement

This transmitter must not be co-located or operated in conjunction with any other antenna or transmitter.

The available scientific evidence does not show that any health problems are associated with using low power wireless devices. There is no proof, however, that these low power wireless devices are absolutely safe. Low power wireless devices emit low levels of radio frequency energy (RF) in the microwave range while being used. Whereas high levels of RF can produce health effects (by heating tissue), exposure of low-level RF that does not produce heating effects causes no known adverse health effects. Many studies of low-level RF exposures have not found any biological effects. Some studies have suggested that some biological effects might occur, but such findings have not been confirmed by additional research.

COOLPIX S9500, which is equipped with a DW092 (FCC ID:EW4DW092 / IC ID:4634A-3149EC) Wireless LAN Module, has been tested and found to comply with FCC/IC radiation exposure limits set forth for an uncontrolled environment and meets the FCC radio frequency (RF) Exposure Guidelines in Supplement C to OET65 and RSS-102 of the IC radio frequency (RF) Exposure rules. Please refer to the SAR test report that was uploaded to FCC website.

Declaration of Conformity

Hereby, Nikon Corporation, declares that this Wireless LAN Module (DW092) is in compliance with the essential requirements and other relevant provisions of Directive 1999/5/EC. The declaration of conformity may be consulted at http://imaging.nikon.com/support/pdf/DoC_S9500.pdf.

Precautions when Using Radio Transmissions

- Always keep in mind that radio transmission or reception of data is subject to interception by third parties. Note that Nikon is not responsible for data or information leaks that may occur during data transfer.
- Using the Wi-Fi (wireless LAN) function may cause radio wave interference, resulting in decreased communication speed or network disconnection. If you experience a problem with the connection, stop using the Wi-Fi (wireless LAN) function.
- The operating frequency band of this equipment is used by industrial, scientific, consumer and medical equipment including microwave ovens, premises radio stations for identifying mobile units used in the manufacturing lines of plants, and amateur radio stations (hereinafter referred to as "another station"). 1. Before using this equipment, confirm that another station is not being operated nearby. 2. In the event of this equipment causing harmful radio wave interference with another station, promptly change the operating frequency or stop radio wave emission by turning off the power, etc. 3. If you have further questions, contact a Nikon service center or Nikon authorized service representative.





































Personal Information Management and Disclaimer

- User information registered and configured on the product, including wireless LAN connection settings and other personal information, is susceptible to alteration and loss resulting from operational error, static electricity, accident, malfunction, repair or other handling. Always keep separate copies of important information. Nikon is not responsible for any direct or indirect damages or lost profits resulting from alteration or loss of content that is not attributable to Nikon.
- Before discarding this product or transferring it to another owner, it is recommended that you apply the reset option from **Reset all** in the setup menu (📖96), to delete all user information registered and configured with the product, including wireless LAN connection settings and other personal information.
- Nikon is not responsible for any communication charges stemming from unauthorized access to a public wireless LAN by third parties, or any other damages resulting from theft of the product.
- Nikon is not responsible for any damages stemming from unauthorized use of email addresses stored in the camera resulting from theft of the product.

Table of Contents

Introduction	ii
Read This First.....	ii
About This Manual.....	iii
Information and Precautions.....	iv
For Your Safety	vi
WARNINGS	vi
Notices	ix
<Important> Notes on GPS/Electronic Compass (COOLPIX S9500 only).....	xi
Wi-Fi (Wireless LAN Network) Function (COOLPIX S9500 only)	xiii
Parts of the Camera and Main Functions.....	1
The Camera Body.....	1
Principle Functions of the Controls.....	3
Attaching the Camera Strap	5
Basic Menu Operations.....	6
Monitor Screen	8
The Basics of Shooting and Playback.....	12
Preparation 1 Insert the Battery.....	12
Preparation 2 Charge the Battery.....	14
Preparation 3 Insert a Memory Card	16
Internal Memory and Memory Cards.....	17
Approved Memory Cards.....	17
Step 1 Turn the Camera On	18
Turning the Camera On and Off.....	19
Setting the Display Language, Date, and Time.....	20
Step 2 Select a Shooting Mode.....	22
Available Shooting Modes.....	23
Step 3 Frame a Picture.....	24
Using the Zoom.....	25
Step 4 Focus and Shoot	26
Step 5 Play Back Images	28
Step 6 Delete Unwanted Images.....	29
Shooting Features.....	31
📷 (Auto) Mode	31
Using Quick Effects	32
Scene Mode (Shooting Suited to Scenes).....	33
Viewing a Description (Help Information) of Each Scene	33
Characteristics of Each Scene	34
Smart Portrait Mode (Shooting Smiling Faces).....	45
Using Skin Softening	46
Special Effects Mode (Applying Effects When Shooting).....	47

Features That Can Be Set Using the Multi Selector	49
Available Functions	49
Using the Flash (Flash Modes)	50
Using the Self-timer	53
Using Macro Mode	54
Adjusting Brightness (Exposure Compensation), Vividness, and Hue (Creative Slider)	55
Adjusting Brightness (Exposure Compensation)	58
List of the Default Settings	59
Features That Can Be Set Using the MENU (Menu) Button (Shooting Mode)	61
Options Available in the Shooting Menu ( (Auto) Mode)	62
Options Available in the Smart Portrait Menu	63
Features Not Available in Combination	64
Focusing on Subject	66
Using the Target Finding AF	66
Using Face Detection	67
Focus Lock	68
Autofocus	68
<hr/>	
Playback Features	69
Playback Zoom	69
Viewing Several Images (Thumbnail Playback and Calendar Display)	70
Selecting Certain Types of Images for Playback	71
Available Playback Modes	71
Switching Between Playback Modes	71
Features That Can Be Set Using the MENU (Menu) Button (Playback Mode)	73
Available Playback Menus	74
Using the Screen for Selecting Images	76
Connecting the Camera to a TV, Computer, or Printer	77
Using ViewNX 2	78
Installing ViewNX 2	78
Transferring Images to the Computer	80
Viewing Images	81
<hr/>	
Recording and Playing Back Movies	82
Recording Movies	82
Features That Can Be Set Using the MENU (Menu) Button (Movie Menu)	86
Available Movie Menu	86
Playing Back Movies	87
<hr/>	
Using GPS/Electronic Compass (COOLPIX S9500 only)	88
Starting GPS Data Recording	88
Features That Can Be Set Using the MENU (Menu) Button (GPS Options Menu)	91
Available GPS Options Menu	91

Using the Wi-Fi (Wireless LAN) Feature (COOLPIX S9500 only)	93
Functions that Can Be Performed Using Wi-Fi	93
Installing the Software on the Smart Device	93
Connecting the Smart Device to the Camera	94
General Camera Setup	96
The Setup Menu	96
Reference Section	 1
Using Easy Panorama (Shooting and Playing back)	 2
Taking Pictures with Easy Panorama	 2
Viewing Easy Panorama (Scroll)	 4
Favorite Pictures Mode	 5
Adding Images to Albums	 5
Playing Back Images in Albums	 6
Removing Images From Albums	 6
Changing the Favorites Album Icon	 7
Auto Sort Mode	 8
List by Date Mode	 10
Playing Images in a Sequence	 11
Editing Still Images	 13
Editing Features	 13
Quick effects: Applying effects to pictures	 15
Quick Retouch: Enhancing Contrast and Saturation	 16
D-Lighting: Enhancing Brightness and Contrast	 16
Glamour Retouch: Making Facial Skin Tones Softer, Face Smaller, or Eyes Larger	 17
Small Picture: Reducing the Size of an Image	 18
Crop: Creating a Cropped Copy	 19
Connecting the Camera to a TV (Viewing Images on a TV)	 20
Connecting the Camera to a Printer (Direct Print)	 22
Connecting the Camera to a Printer	 22
Printing Individual Images	 23
Printing Multiple Images	 24
Editing Movies	 27
Extracting Only the Desired Portions of the Movie	 27
The Shooting Menu ( (Auto) Mode)	 29
Image Mode (Image Size and Quality)	 29
White Balance (Adjusting Hue)	 31
Metering	 33
Continuous Shooting	 34
ISO Sensitivity	 37
AF Area Mode	 38
Autofocus Mode	 41
Quick Effects	 42

The Smart Portrait Menu	43
Image Mode (Image Size and Quality)	43
Skin Softening	43
Smile Timer	43
Blink Proof	44
Movie Menu	45
Movie Options	45
Open with HS Footage	49
Autofocus Mode	49
Wind Noise Reduction	50
The Playback Menu	51
Print Order (Creating a DPOF Print Order)	51
Slide Show	54
Protect	55
Rotate Image	55
Voice Memo	56
Copy (Copy Between Internal Memory and Memory Card)	57
Sequence Display Options	58
Choose Key Picture	58
GPS Options Menu (COOLPIX S9500 only)	59
GPS Options	59
Points of Interest (POI) (Recording and Displaying Location Name Information)	61
Create Log (Record the Log of Moving Information)	62
View Log	64
Synchronize	64
Electronic Compass	65
The Setup Menu	67
Welcome Screen	67
Time Zone and Date	68
Monitor Settings	70
Print Date (Imprinting Date and Time on Pictures)	72
Vibration Reduction	73
Motion Detection	74
AF Assist	75
Digital Zoom	76
Sound Settings	77
Auto Off	77
Format Memory/Format Card	78
Language	78
TV Settings	79
Charge by Computer	80
Blink Warning	82
Wi-Fi Options (COOLPIX S9500 only)	83
Eye-Fi Upload	85
Filmstrip	86
Reset All	87
Firmware Version	90

Table of Contents

Error Messages	91
File and Folder Names	97
Optional Accessories	99



Technical Notes and Index 1

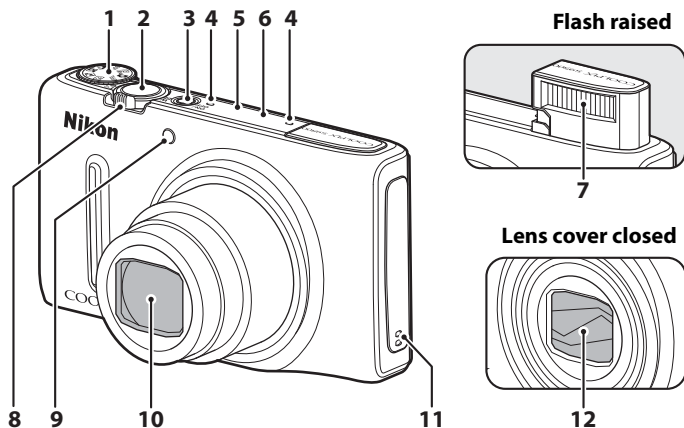

Caring for the Products	2
The Camera	2
The Battery	3
Charging AC Adapter	4
The Memory Cards	5
Caring for the Camera	6
Cleaning	6
Storage	6
Troubleshooting	7
USER LICENSE AGREEMENT FOR LOCATION NAME DATA (COOLPIX S9500)	15
Specifications	19
Supported Standards	23
Index	26

Parts of the Camera and Main Functions

The Camera Body



1	Mode dial.....	22
2	Shutter-release button.....	3, 26
3	Power switch/power-on lamp.....	19
4	Microphone (stereo).....	74, 82
5	 GPS antenna (COOLPIX S9500 only).....	88
6	 Wi-Fi (wireless LAN) antenna (COOLPIX S9500 only).....	93
7	Flash.....	50

8	Zoom control.....	25
	W : Wide.....	25
	T : Tele.....	25
	 Thumbnail playback.....	70
	 Playback zoom.....	69
	 Help.....	33
9	Self-timer lamp.....	53
	AF-assist illuminator.....	97
10	Lens	
11	Speaker.....	74, 87, 97
12	Lens cover	

The Camera Body

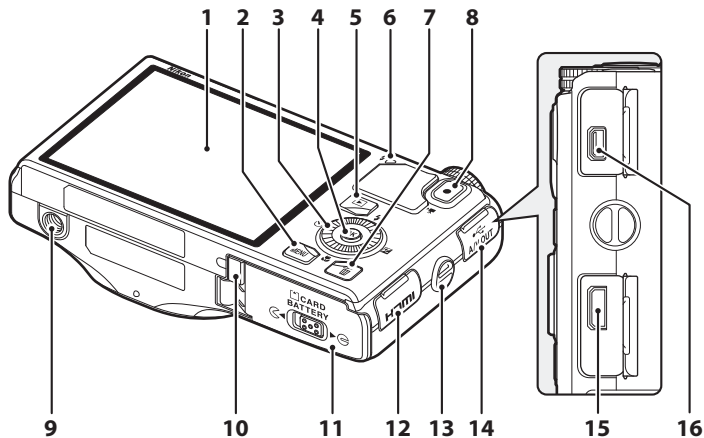

1	OLED monitor (monitor) ¹8, 22
2	MENU (menu) button.....6
3	Rotary multi selector (multi selector) ²3, 4
4	OK (apply selection) button.....3, 4
5	▶ (playback) button.....4, 28
6	Charge lamp.....14, 81 Flash lamp.....50
7	(delete) button.....29, 87
8	(movie-record) button.....28, 82













9	Tripod socket
10	Power connector cover (for an optional AC adapter).....99
11	Battery-chamber/memory card slot cover.....12, 16
12	HDMI connector cover.....77
13	Eyelet for camera strap.....5
14	USB connector cover.....14, 77, 80
15	HDMI micro connector (Type D).....77
16	USB/Audio video connector.....14, 77, 80

¹ The OLED monitor is sometimes referred to as "monitor" in this manual.

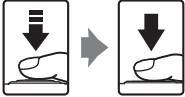

² The rotary multi selector is sometimes referred to as "multi selector" in this manual.

Principle Functions of the Controls



















For Shooting





Control	Main Function	
 <p>Mode dial</p>	Change the shooting mode.	22
 <p>Zoom control</p>	Rotate toward T (🔍) (telephoto zoom position) to zoom in, and rotate toward W (📐) (wide-angle position) to zoom out.	25
 <p>Rotary multi selector</p>	<ul style="list-style-type: none"> While the shooting screen is displayed: Display the setting screen for  (flash mode) by pressing up (▲), for  (self-timer) by pressing left (◀), for  (macro mode) by pressing down (▼) and for creative slider or  (exposure compensation) by pressing right (▶). While the setting screen is displayed: Select an item using ▲, ▼, ◀ or ▶, or by rotating the rotary multi selector; apply the selection by pressing the  button. 	49 6
 <p>MENU (menu) button</p>	Display and hide the menu.	6
 <p>Shutter-release button</p>	<p>When pressed halfway (i.e., if you stop pressing when you feel resistance slightly): Set focus and exposure.</p> <p>When pressed all the way (i.e., if you press the button all the way): Release the shutter.</p>	26
 <p> movie-record button</p>	Start and stop movie recording.	82

The Camera Body

Control	Main Function	
 Playback button	Play back images.	28
 Delete button	Delete the last image that was saved.	29

For Playback

Control	Main Function	
 Playback button	<ul style="list-style-type: none"> When the camera is turned off, press and hold this button to turn the camera on in playback mode. Return to shooting mode. 	19 28
 Zoom control	<ul style="list-style-type: none"> Enlarge the image when rotated toward T () , display image thumbnail or the calendar when rotated toward W () . Adjust the volume for voice memo and movie playback. 	69, 70 74, 87
 Rotary multi selector	<ul style="list-style-type: none"> While the playback screen is displayed: Change the displayed image by pressing up () , down () , left () and right () , or by rotating the rotary multi selector. While the setting screen is displayed: Select an item using , ,  or  or by rotating the rotary multi selector. While the enlarged image is displayed: Move the display position. 	28 6 69
 Apply selection button	<ul style="list-style-type: none"> Display individual images of a sequence in full-frame. Scroll an image recorded with Easy panorama. Play back movies. Apply effects to pictures using quick effects. Switch from image thumbnail or zoomed image display to full-frame playback mode. While the setting screen is displayed, apply the selection. 	28,  11 41,  4 87 28,  15 70 6

Control	Main Function	
 <p>MENU (menu) button</p>	Display and hide the menu.	6
 <p>Delete button</p>	Delete images.	29
 <p>Shutter-release button</p>	Return to shooting mode.	-
 <p>● (▶ movie-record) button</p>		

Attaching the Camera Strap

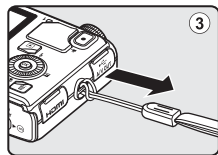
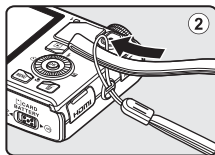
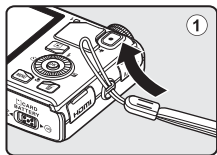

Basic Menu Operations

Once the menu is displayed, various settings can be changed.

1 Press the MENU button.

- The menu that matches the status of the camera, such as shooting or playback mode, is displayed.

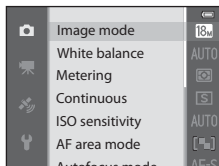
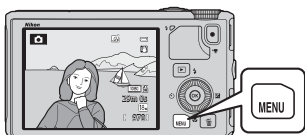

2 Use the Rotary multi selector to select a menu item.

- ▲ or ▼: Select an item above or below. Item can also be selected by rotating the multi selector.
- ◀ or ▶: Select an item on the left or right, or move between menu levels.
- OK: Apply a selection. Pressing ▶ also applies a selection.
- See "Switching Between Menu Icons" (📖7) for more information.



Apply selection

3 After completing the settings, press the MENU button or shutter-release button.

- Press the shutter-release button to display the shooting screen.

Switching Between Menu Icons

To display a different menu, such as the setup menu (🔧 96), use the multi selector to switch to another menu icon.

Menu icons

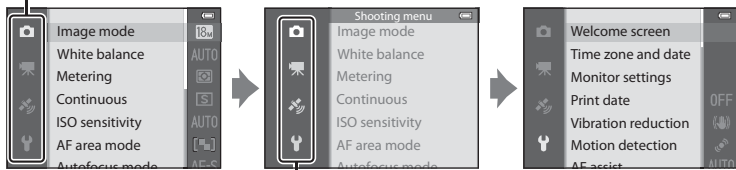

Press ◀ to move to the menu icon.

Press ▲ or ▼ to select the menu icon, and press the ⓧ button or ▶ to apply the selection.

Types of Menu Icons

For Shooting	For Playback
<p>📷 menu icon: Displays available settings in the current shooting mode (📖23). Depending on the current shooting mode, the menu icon that is displayed will be different.</p> <p>🎥 menu icon: Displays the settings that deal with movie recording.</p> <p>📶 menu icon (COOLPIX S9500 only): Displays the GPS options menu (📖91) items.</p> <p>🔧 menu icon: Displays the setup menu, where you can change general settings.</p>	<p>MODE menu icon: Selects the playback mode (📖71).</p> <p>▶ menu icon: Displays the settings available for the playback mode.</p>



Monitor Screen

The information that is displayed on the monitor during shooting and playback changes depending on the camera's settings and state of use. In the default setting, information is displayed when the camera is turned on and when you operate the camera, and turns off after a few seconds (when **Photo info** in **Monitor settings** (📖96) is set to **Auto info**).

For Shooting

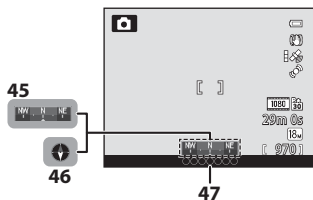
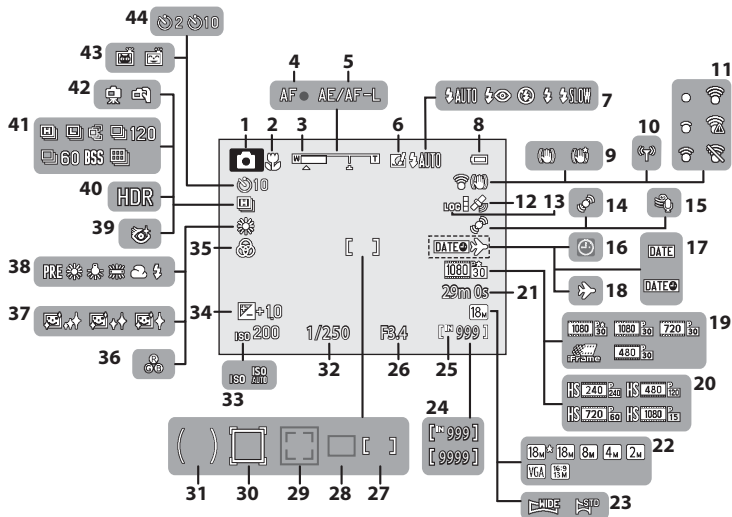
Parts of the Camera and Main Functions



1	Shooting mode.....	22, 23	27	Focus area (for manual, center)	27, 62
2	Macro mode	54	28	Focus area (for target finding AF)	62, 66
3	Zoom indicator	25, 54	29	Focus area (for face detection, pet detection)	42, 62, 67
4	Focus indicator.....	26	30	Focus area (for subject tracking)	62
5	AE/AF-L indicator.....	43	31	Center-weighted area	62
6	Quick effects	32	32	Shutter speed	27
7	Flash mode	50	33	ISO sensitivity.....	62
8	Battery level indicator	18	34	Exposure compensation value.....	57, 58
9	Vibration reduction icon	97	35	Vividness.....	57
10	Wi-Fi communication indicator (COOLPIX S9500 only).....	93	36	Hue.....	57
11	Eye-Fi communication indicator	98, 	37	Skin softening.....	63
12	GPS reception (COOLPIX S9500 only).....	90	38	White balance	62
13	Log display (COOLPIX S9500 only) ...	92	39	Blink proof icon	63
14	Motion detection icon.....	97	40	Backlighting (HDR)	37
15	Wind noise reduction.....	86	41	Continuous shooting mode	62
16	"Date not set" indicator.....	21, 96	42	Hand-held/Tripod.....	35, 36
17	Print date.....	96	43	Smile timer	63
18	Travel destination indicator.....	96	44	Pet portrait auto release	42
19	Movie options (normal speed movies)	86	44	Self-timer	53
20	Movie options (HS movies).....	86	45	Compass display (direction gauge) (COOLPIX S9500 only).....	92
21	Movie length	82, 	46	Compass display (compass) (COOLPIX S9500 only).....	92
22	Image mode	62, 63	47	Location name information (POI information) (COOLPIX S9500 only).....	91
23	Easy panorama	41			
24	Number of exposures remaining (still pictures).....	18, 			
25	Internal memory indicator	18			
26	Aperture value	27			

For Playback

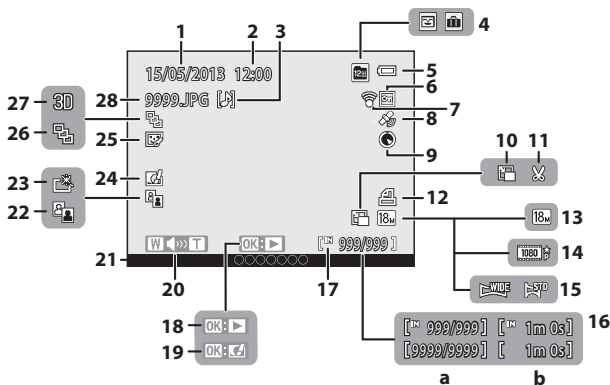

1	Date of recording.....	20
2	Time of recording	20
3	Voice memo indicator	74
	Album icon in favorite pictures mode	71
4	Category icon in auto sort mode.....	71
	List by date mode.....	71
5	Battery level indicator.....	18
6	Protect icon	74
7	Eye-Fi communication indicator	98, 85
8	Recorded GPS information indicator (COOLPIX S9500 only).....	90
9	Compass display (compass) (COOLPIX S9500 only).....	92
10	Small picture	74, 18
11	Crop.....	69, 19
12	Print order icon.....	74
13	Image mode.....	62, 63
14	Movie options	86
15	Easy panorama indicator.....	41

16	(a) Current image number/total number of images.....	28
	(b) Movie length	87
17	Internal memory indicator	28
	Easy panorama playback guide	4
18	Sequence playback guide	11
	Movie playback guide	87
19	Quick effects.....	32
20	Volume indicator	74, 87
21	Location name information (POI information) (COOLPIX S9500 only).....	91
22	D-Lighting icon	74
23	Quick retouch icon.....	74
24	Quick effects icon.....	28
25	Glamour retouch icon	74
26	Sequence display (when Individual pictures is set)	74
27	3D image indicator	43
28	File number and type.....	97



A series of horizontal dashed lines spanning the width of the page, intended for handwriting practice. There are 18 lines in total, starting from the top right and extending to the bottom left.

The Basics of Shooting and Playback

Preparation 1 Insert the Battery

- 1 Open the battery-chamber/memory card slot cover.

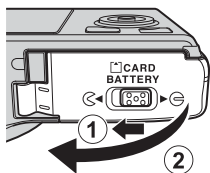

- 2 Insert the included battery (Rechargeable Li-ion Battery EN-EL12).

- Use the battery to push the orange battery latch up in the direction indicated by the arrow (1), and fully insert the battery (2).
- When the battery is inserted correctly, the battery latch will lock the battery in place.

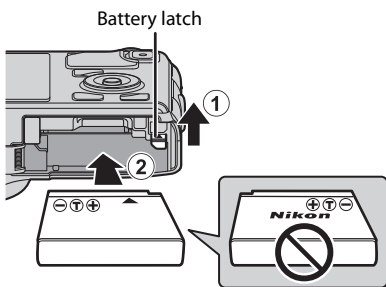

✓ Inserting the Battery Correctly

Inserting the battery upside down or backwards could damage the camera. Be sure to check that the battery is in the correct orientation.

- 3 Close the battery-chamber/memory card slot cover.

- Charge the battery before the first use or when the battery is running low (18).

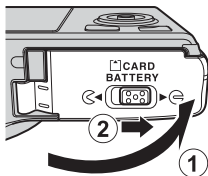

Removing the Battery

Turn the camera off (📖19) and be sure that the power-on lamp and the monitor have turned off before opening the battery-chamber/memory card slot cover.

To eject the battery, open the battery-chamber/memory card slot cover and push the orange battery latch in the direction shown (①). Then, remove the battery straight (②).

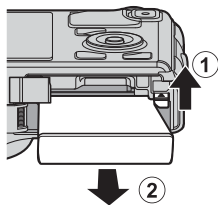

✔ High Temperature Caution

The camera, battery, and memory card may be hot immediately after using the camera. Observe caution when removing the battery or memory card.

✔ Notes on Battery

- Be sure to read and follow the warnings of “For Your Safety” (📖vi) thoroughly before using the battery.
- Be sure to read and follow the warnings for “The Battery” (🔋3) before using the battery.

Preparation 2 Charge the Battery

1 Prepare the included Charging AC Adapter EH-70P.

If a plug adapter* is included with your camera, attach the plug adapter to the plug on the Charging AC Adapter. Push the plug adapter firmly until it is securely held in place. Once the two are connected, attempting to forcibly remove the plug adapter could damage the product.

* The shape of the plug adapter varies according to the country or region in which the camera was purchased. The Charging AC Adapter comes with the plug adapter attached in Argentina and Korea.

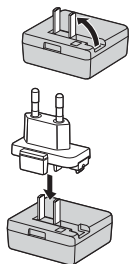

2 Make sure the battery is inserted in the camera, and then connect the camera to the Charging AC Adapter in order of ① to ③.

- Keep the camera turned off.
- When connecting the cable, be sure that the plug is properly oriented. Do not use force when connecting the cable to the camera. When disconnecting the cable, do not pull the plug at an angle.

Charge lamp

Electrical outlet

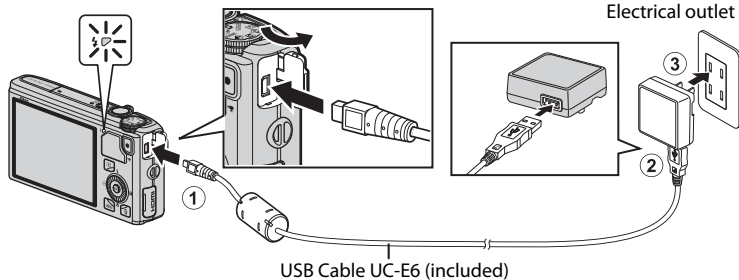

- When charging starts, the charge lamp flashes slowly in green.
- About 3 hours and 50 minutes is required to charge a fully exhausted battery.
- When the battery has been completely charged, the charge lamp turns off.
- See "Understanding the Charge Lamp" (📖15) for more information.

3 Disconnect the Charging AC Adapter from the electrical outlet and then disconnect the USB cable.

Understanding the Charge Lamp

Status	Description
Flashes slowly (green)	The battery is charging.
Off	The battery is not charging. When charging is complete, the charge lamp flashing slowly in green stops and is turned off.
Flashes quickly (green)	<ul style="list-style-type: none"> The ambient temperature is not suited to charging. Charge the battery indoors with an ambient temperature of 5°C to 35°C (41°F to 95°F). The USB cable or Charging AC Adapter is not properly connected, or there is a problem with the battery. Disconnect the USB cable or unplug the Charging AC Adapter and correctly connect it again, or change the battery.

Notes on Charging AC Adapter

- Be sure to read and follow the warnings of “For Your Safety” (📖vi) thoroughly before using the Charging AC Adapter.
- Be sure to read thoroughly and follow the warnings for “Charging AC Adapter” (🔌4) before use.

Charging Using Computer or Battery Charger

- You can also charge the COOLPIX S9500/S9400 Rechargeable Li-ion Battery EN-EL12 by connecting the camera to a computer (📖77, 98).
- The EN-EL12 can be charged without using the camera by using the Battery Charger MH-65 (available separately; 📞99).

Operating the Camera During Charging

If you press the power switch while using the Charging AC Adapter to charge the battery in the camera, the camera turns on in playback mode, and you can play back images. Shooting is not possible.

AC Power Source

- You can take pictures and play back images while using the AC Adapter EH-62F (available separately; 📞99) to power the camera from an electrical outlet.
- Do not, under any circumstances, use another make or model of AC adapter other than the EH-62F. Failure to observe this precaution could result in overheating or damage to the camera.

Preparation 3 Insert a Memory Card

- 1 Confirm that the power-on lamp and the monitor are turned off and open the battery-chamber/memory card slot cover.

- Be sure to turn off the camera before opening the cover.

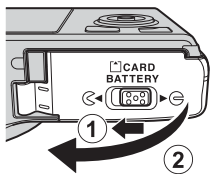

- 2 Insert the memory card.

- Slide the memory card until it clicks into place.

✓ Inserting the Memory Card Correctly

Inserting the memory card upside down or backwards could damage the camera or the memory card. Be sure to confirm that the memory card is in the correct orientation.

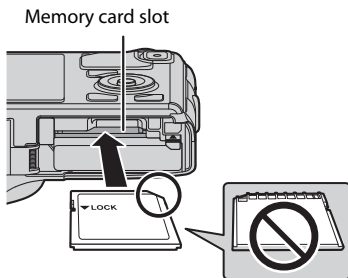

- 3 Close the battery-chamber/memory card slot cover.

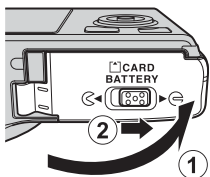

✓ Formatting a Memory Card

- The first time you insert a memory card that has been used in another device into this camera, be sure to format it with this camera.
- **All data stored on a memory card is permanently deleted when the card is formatted.** Be sure to make copies of any data you wish to keep before formatting the memory card.
- To format a memory card, insert the memory card into the camera, press the **MENU** button and select **Format card** from the setup menu (📖96).

✓ Note on Memory Cards

Refer to the documentation included with the memory card, as well as "The Memory Cards" (🔍5) in "Caring for the Products."

Removing Memory Cards

Before opening the battery-chamber/memory card slot cover, turn the camera off and confirm that the power-on lamp and the monitor are off.

Press the memory card in lightly with your finger (①) to partially eject it, and then pull it out straight (②).

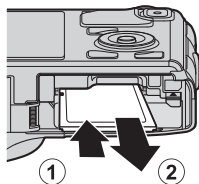

High Temperature Caution

The camera, battery, and memory card may be hot immediately after using the camera. Observe caution when removing the battery or memory card.

Internal Memory and Memory Cards

Camera data, including images and movies, can be saved in either the camera's internal memory (COOLPIX S9500: approximately 23 MB, COOLPIX S9400: approximately 65 MB) or on a memory card. To use the camera's internal memory for shooting or playback, first remove the memory card.

Approved Memory Cards

The following Secure Digital (SD) memory cards have been tested and approved for use in this camera.

- When recording a movie onto a memory card, a memory card with an SD speed class of Class 6 or higher is recommended. If the transfer speed of the card is slow, the movie recording may end unexpectedly.

	SD memory cards	SDHC memory cards ²	SDXC memory cards ³
SanDisk	2 GB ¹	4 GB, 8 GB, 16 GB, 32 GB	64 GB, 128 GB
TOSHIBA	2 GB ¹	4 GB, 8 GB, 16 GB, 32 GB	64 GB
Panasonic	2 GB ¹	4 GB, 8 GB, 16 GB, 32 GB	64 GB
Lexar	-	4 GB, 8 GB, 16 GB, 32 GB	64 GB, 128 GB

- Before using a card reader or similar device, check that the device supports 2 GB cards.
- SDHC-compliant. Before using a card reader or similar device, check that the device supports SDHC.
- SDXC-compliant. Before using a card reader or similar device, check that the device supports SDXC.

- Contact the manufacturer for details on the above cards.



Step 1 Turn the Camera On

1 Press the power switch to turn on the camera.

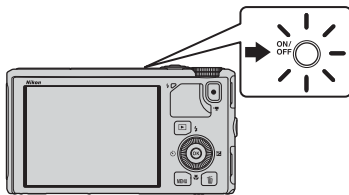

- **If you are turning the camera on for the first time, see “Setting the Display Language, Date, and Time”** (📖20).
- The lens extends, and the monitor is turned on.

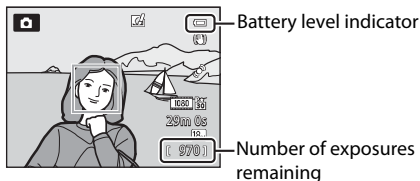

2 Check the battery level and number of exposures remaining.



Battery Level



Display	Description
	Battery level high.
	Battery level low. Prepare to charge or replace the battery.
 Battery exhausted.	Cannot take pictures. Charge or replace the battery.

Number of Exposures Remaining

The number of exposures remaining is displayed.



- When a memory card is not inserted,  is displayed and pictures are recorded to the internal memory (COOLPIX S9500: approximately 23 MB, COOLPIX S9400: approximately 65 MB).
- The number of pictures that can be stored depends on the remaining capacity of the internal memory or memory card, the image quality, and the image size (image mode) (📖62).
- The number of exposures remaining shown in the illustration differs from the actual value.

Turning the Camera On and Off

- When the camera is turned on, the power-on lamp (green) lights and the monitor is turned on (the power-on lamp turns off when the monitor is turned on).
- To turn off the camera, press the power switch. Both the monitor and the power-on lamp are turned off.
- To turn on the camera in playback mode, press and hold the  (playback) button. At this time, the lens does not extend.
- When **Record GPS data** in **GPS options** of the GPS options menu is set to **On**, GPS functions will continue to operate even after the camera is turned off (89).

Power Saving Function (Auto Off)

If no operations are performed for a while, the monitor will turn off, the camera will enter standby mode, and the power-on lamp will flash. If no operations are performed for another 3 minutes, the camera will turn off automatically.

- To turn on the monitor again in standby mode, perform either one of the following operations.
 - Press the power switch, shutter-release button,  button, or  movie-record) button.
 - Rotate the mode dial.
- The time that elapses before the camera enters standby mode can be changed using the **Auto off** setting in the setup menu (96).
- By default, the camera enters standby mode in about 1 minute when you are using shooting mode or playback mode.
- If you are using the AC Adapter EH-62F (available separately), the camera enters standby mode after 30 minutes. This setting cannot be changed.

Note on Battery Drain

Battery power drains faster than usual while the camera is recording log data (92) or using a Wi-Fi connection (93).

Setting the Display Language, Date, and Time

Dialogs for language selection and camera clock setting are displayed the first time the camera is turned on.

- 1 Press the multi selector ▲ or ▼ to choose the desired language and press the **OK** button.

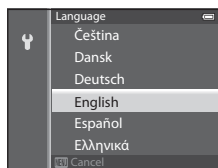

- 2 Press ▲ or ▼ to choose **Yes** and press the **OK** button.

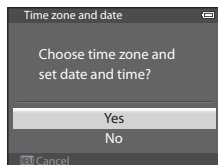

- 3 Press ◀ or ▶ to select your home time zone, and press the **OK** button.

- In regions where daylight saving time applies, press ▲ to enable the daylight saving time function. ☀ will be displayed. To disable the daylight saving time function, press ▼.

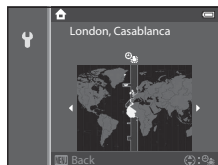

- 4 Press ▲ or ▼ to choose the date display order and press the **OK** button or ▶.

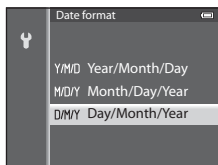

5 Press ▲, ▼, ◀ or ▶ to set date and time, and press the **OK** button.

- Choose an item: Press ▶ or ◀ (selected in the following order: **D** (day) → **M** (month) → **Y** (year) → **hour** → **minute**).
- Set the contents: Press ▲ or ▼. Date and time can also be set by rotating the multi selector.
- Confirm the settings: Select the **minute** field and press the **OK** button or ▶.

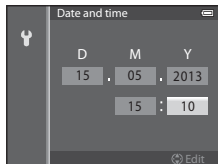

6 Press ▲ or ▼ to choose **Yes** and press the **OK** button.

- After finishing the setting, the lens extends and the shooting screen is displayed.

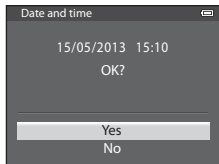

The Clock Battery

- The camera's clock is powered by an backup battery. The backup battery charges after about 10 hours of charging when the main battery is inserted into the camera or when the camera is connected to an optional AC adapter. The backup battery operates the clock for several days.
- If the camera's backup battery becomes exhausted, the date and time setting screen is displayed when the camera is turned on. Set the date and time again. See step 2 of "Setting the Display Language, Date, and Time" (□□20) for more information.

Changing the Language Setting and the Date and Time Setting



- You can change these settings using the **Language** and **Time zone and date** settings in **Y** setup menu (□□96).
- In the **Time zone** setting of **Time zone and date** in **Y** setup menu, when the daylight saving time function is enabled, the camera's clock is set forward by one hour, and when disabled, set back by one hour.
- If you exit without setting the date and time,  flashes when the shooting screen is displayed. Use the **Time zone and date** setting in the setup menu to set the date and time.

Imprinting the Shooting Date in Printed Images



- Set the date and time before shooting.
- You can imprint the shooting date in images as they are captured by setting **Print date** in the setup menu.
- If you want the shooting date to be printed without using the **Print date** setting, print using the ViewNX 2 software (□□78).

Step 2 Select a Shooting Mode

Rotate the mode dial to select the shooting mode.

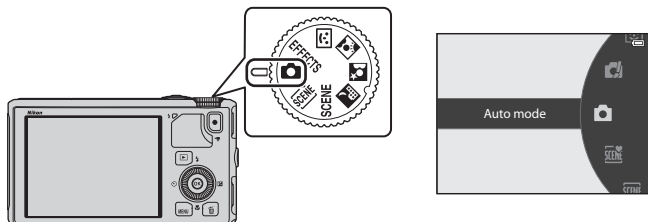
- The following describes how to take pictures in  (auto) mode as an example. Rotate the mode dial to .



- The camera switches to  (auto) mode and the shooting mode icon changes to .

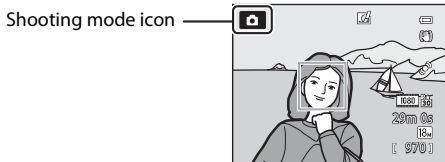

- See “Monitor Screen” ()8 for more information.

Available Shooting Modes

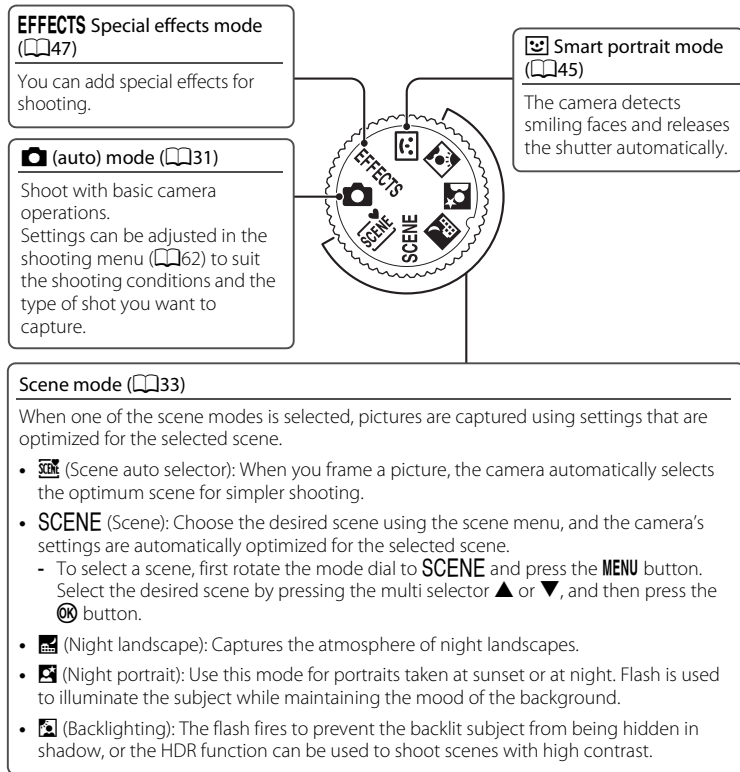

Changing the Settings When Shooting

- Features That Can Be Set Using the Multi Selector → 📖49
- Features That Can Be Set Using the **MENU** (Menu) Button
 - Shooting menu → 📖61
 - Setup menu → 📖96

Step 3 Frame a Picture

1 Ready the camera.

- Keep your fingers, hair, strap and other objects away from the lens, flash, AF-assist illuminator and microphone.
- To shoot in the "tall" orientation, hold the camera so that the flash is above the lens.

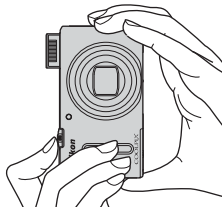
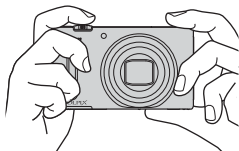

2 Frame the picture.

- Point the camera at the subject.

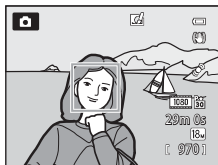

Using a Tripod

- In the following situations, use of a tripod is recommended to avoid the effects of camera shake:
 - When shooting in a dark location, with the flash mode (📖50) set to ⚡ (off) or in a mode in which flash is disabled
 - When shooting in the telephoto zoom position
- To take a picture with the camera attached to a tripod, set **Vibration reduction** in the setup menu (📖96) to **Off**.



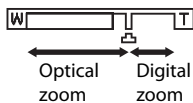
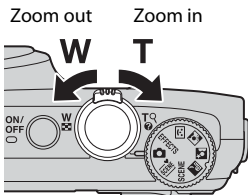

Using the Zoom

Rotate the zoom control to activate the optical zoom.

- To zoom in so that the subject fills a larger area of the frame, rotate the zoom control toward **T** (telephoto zoom position).
- To zoom out so that the area visible increases in the frame, rotate the zoom control toward **W** (wide-angle position).
- Amount of zoom is displayed at the top of the monitor screen when the zoom control is rotated.
- Rotating the zoom control toward **T** at the maximum optical zoom ratio triggers the digital zoom and the digital zoom can magnify up to about 4x beyond the maximum magnification of the optical zoom.



Digital Zoom and Interpolation

- When the digital zoom is used, the image quality starts to deteriorate if the zoom position is increased beyond the  position on the zoom bar. The  position moves to the right as the image size (62) becomes smaller.
- Using **Digital zoom** in the setup menu (96), it is possible to set the digital zoom so that it does not operate.



Step 4 Focus and Shoot

1 Press the shutter-release button halfway to adjust the focus.

- “Pressing halfway” is the action of pressing the shutter-release button slightly until you feel resistance and then holding in that position.
- When the subject is in focus, the focus area or focus indicator (📖8) lights in green. If the focus area or focus indicator flashes in red, the subject is out of focus. Press the shutter-release button halfway again.
- See “Focus and Exposure” (📖27) for more information.

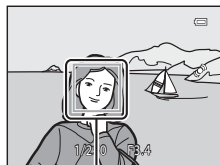
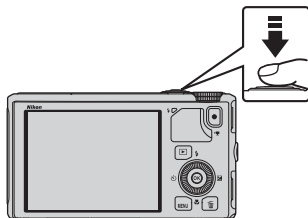

Focus area

2 Press the shutter-release button all the way to take a picture.

- “Pressing all the way” is the action of pressing the shutter-release button the rest of the way down.



✔ Note on Recording Images and Saving Movies

The indicator showing the number of exposures remaining or the indicator showing the maximum movie length flashes while images are being recorded or while a movie is being saved. **Do not open the battery-chamber/memory card slot cover or remove the battery or memory card while an indicator is flashing.** Doing this could result in loss of data, or in damage to the camera or the memory card.

✍ AF-assist Illuminator

In dark places, the AF-assist illuminator (📖97) may light when the shutter-release button is pressed halfway.

✍ To Make Sure You Do Not Miss a Shot

If you are concerned that you might miss a shot, press the shutter-release button all the way without first pressing it halfway.

✍ Note on Quick Effects Function

In 📷 (auto) mode, you can apply effects to images immediately after releasing the shutter (📖32).

Focus and Exposure

When the shutter-release button is pressed halfway, the camera sets the focus and exposure (combination of shutter speed and aperture value). The focus and exposure remain locked while the shutter-release button is pressed halfway.

- When the digital zoom is in effect, the camera focuses on the subject at the center of the frame, and the focus area is not displayed. When the subject is in focus, the focus indicator lights in green.
- The camera may not be able to focus on certain subjects. See “Autofocus” (📖68) for more information.
- When the camera detects the main subject in auto mode, it focuses on that subject (Target finding AF) (📖66).

When the subject is in focus, the focus areas light in green (multiple areas may light up).

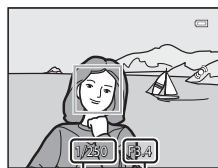

Shutter speed Aperture value

- The areas to be used for focusing can be set using **AF area mode** (📖62) in the shooting menu.
- The areas to be used for focusing in scene mode vary depending on the selected scene (📖34).
- In smart portrait mode, the camera focuses on the face around which a double border (focus area) is displayed.
- In **EFFECTS** (special effects) mode, the camera focuses at the center of the frame.

More Information

See “Focusing on Subject” (📖66) for more information.

Flash

- If the subject is dimly lit, the flash will pop up automatically when you press the shutter-release button halfway when the flash mode is set to **⚡AUTO** (auto; default setting). The flash will fire when you press the shutter-release button all the way. See “Using the Flash (Flash Modes)” (📖50) for more information.
- Lower the flash by gently pushing it down. When not taking pictures, lower the flash.

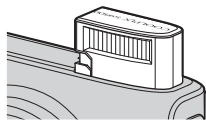





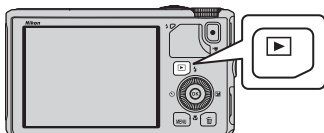

Step 5 Play Back Images

1 Press the (playback) button.

- When you switch from shooting mode to playback mode, the last image saved will be displayed in full-frame playback mode.







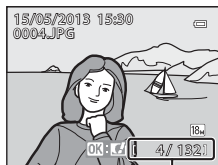

2 Use the multi selector to view previous or next images.

- To view previous images:  or 
- To view next images:  or 
- Images can also be selected by rotating the multi selector.
- To play back images that are saved in the internal memory, remove the memory card.  is displayed in brackets, before “Current image number/total number of images” on the playback screen.
- To return to shooting mode, press the  button again, or press the shutter-release button, or  (movie-record) button.





Current image number/
Total number of images

Viewing Pictures

- When the orientation of the camera is changed during playback, the displayed images are rotated automatically.
- Pictures taken in “tall” orientation will be rotated automatically. Pictures taken using face detection (67) or pet detection (42) will be rotated automatically when displayed in full-frame playback mode according to the orientation of the face.
- The orientation of an image can be changed using **Rotate image** in the playback menu (74).
- Press the  button to display a sequence of images shot continuously as individual images. Press  on the multi selector to return to the original display (see 11 for more information on the sequence display).
- Images may be displayed at low resolution immediately after switching to the previous or next image.

Note on Quick Effects Function

When   is displayed in full-frame playback mode, you can apply effects to the images. When you press the  button, the quick effects selection menu is displayed.

The images applied with the effects are saved as a separate file with a different name.

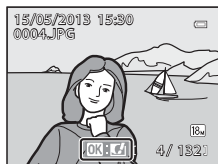

See “Quick effects: Applying effects to pictures” (15) for more information.



Step 6 Delete Unwanted Images

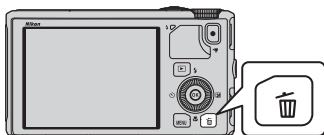

- 1 Press the  button to delete the image currently displayed on the monitor.



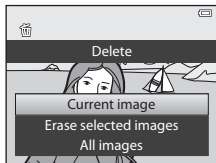

- 2 Press the multi selector  or  to select the desired deletion method and press the  button.

- **Current image:** Only the current image is deleted. If the key picture of a sequence is selected, all images in the sequence are deleted.
- **Erase selected images:** Multiple images can be selected and deleted. See “Operating the Erase Selected Images Screen” (📖30) for more information.
- **All images:** All images are deleted.
- To exit without deleting, press the **MENU** button.



- 3 Press  or  to select **Yes** and press the  button.

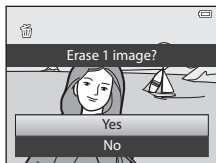

- Deleted images cannot be recovered.
- To cancel, press  or  to select **No** and press the  button.



Notes on Deletion

- Deleted images cannot be recovered. Transfer important images to a computer before deleting them.
- Protected images (📖74) cannot be deleted.
- When images are taken with continuous shooting, each series of images is treated as a group (pictures in a sequence) and only the first picture in a group (key picture) is displayed in the default setting.

When you press the  button during key picture playback, all images in the key picture's sequence can be deleted.





To delete each picture in a sequence, before pressing the  button, press the  button to display each image in the sequence individually.

Deleting the Last Image Captured While in Shooting Mode



When using shooting mode, press the  button to delete the last image that was saved.

Operating the Erase Selected Images Screen

1 Press the multi selector ◀ or ▶ to select an image to be deleted, and then press ▲ to display .

- To cancel the selection, press ▼ to remove .
- Rotate the zoom control (25) toward **T** () to switch back to full-frame playback or **W** () to display thumbnails.



2 Add  to all images that you want to delete and then press the  button to apply the selection.

- A confirmation dialog is displayed. Follow the instructions displayed on the monitor.

Selecting Certain Types of Images for Deletion

When using favorite pictures mode, auto sort mode, or list by date mode, you can select images registered as favorites, images in a certain category, or images captured on a specific date for deletion (76).

Shooting Features

(Auto) Mode

Basic shooting operations can be performed. In addition, the options of shooting menu (📖62) can be adjusted according to the shooting conditions and the kind of images you want to capture.

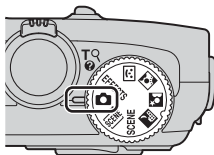

- The focus area for autofocus differs depending on the setting of **AF area mode** that can be selected in the  menu icon after pressing the **MENU** button.
- When the camera detects the main subject, it focuses on that subject (target finding AF).
- The camera has 9 focus areas, and if it does not detect the main subject, it automatically selects the focus areas containing the subject closest to the camera.
- See “Using the Target Finding AF” (📖66) for more information.
- See “Focus and Exposure” (📖27) for more information.

Changing (Auto) Mode Settings

- Features That Can Be Set Using the Multi Selector → 📖49
- Features That Can Be Set Using the **MENU** (Menu) Button
 - Shooting menu → 📖61
 - Setup menu → 📖96

Using Quick Effects

When in 📷 (auto) mode, you can apply effects to images immediately after releasing the shutter.

- The edited image is saved as a separate file with a different name (📷97).

1 Press the Ⓞ button on the screen displayed after taking a picture in 📷 (auto) mode.

- When you press the MENU button or when no operations are performed for about 5 seconds, the monitor display returns to the shooting screen.
- To not display the confirmation screen shown on the right, set **Quick effects** to **Off** (📖62).

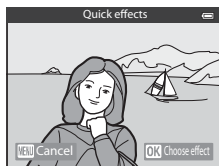

2 Press the multi selector ◀ or ▶ to select an effect and then press the Ⓞ button.

- See “Quick Effects” (📷15) for information about the effect types.
- Rotate the zoom control toward **T** (telephoto zoom position) to display a confirmation screen for the applied effect. Rotate the zoom control toward **W** (wide-angle position) to return to the selection screen for effects.

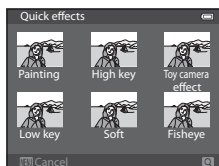

3 Choose **Yes** and press the Ⓞ button.

- A new, edited copy is created and the monitor display returns to the shooting screen.
- Copies created with the quick effects function are indicated by the 📷 icon displayed during playback (📖10).

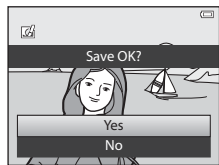

✔ Note on Quick Effects

If the camera detects eyes that are blinking (not open) when **Blink warning** in the setup menu (📖96) is set to **On**, the quick effects function cannot be used.

Scene Mode (Shooting Suited to Scenes)

When one of the following scenes is selected using the mode dial or the scene menu, images are captured using settings that are optimized for the selected scene.

SCN (Scene auto selector) (📖34)

When you frame a picture, the camera automatically selects the optimum scene for simpler shooting.

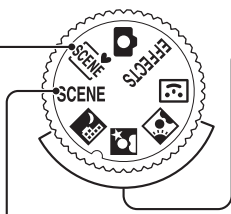

🌃 (Night landscape) (📖35)

👤 (Night portrait) (📖36)
🌃 (Backlighting) (📖37)

Rotate the mode dial to 🌃 or 👤 and take pictures.

SCENE (Scene)

Press the **MENU** button to display the scene menu and choose one of the following shooting scenes.

👤 Portrait (default setting) (📖38)	🌿 Close-up (📖39)
🏞 Landscape (📖38)	🍴 Food (📖40)
🏊 Sports (📖38)	🏛 Museum (📖40)
🎉 Party/indoor (📖38)	🎆 Fireworks show (📖40)
🏖 Beach (📖39)	🖨 Black and white copy (📖41)
❄ Snow (📖39)	🏠 Easy panorama (📖41)
🌅 Sunset (📖39)	🐾 Pet portrait (📖42)
🌄 Dusk/dawn (📖39)	3D 3D photography (📖43)

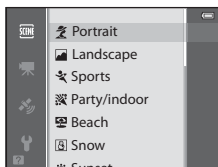
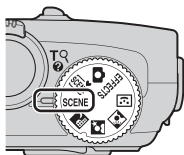



Viewing a Description (Help Information) of Each Scene

Select the desired scene from the scene menu and rotate the zoom control (📖1) toward **T** (🔍) to view a description of that scene. To return to the original screen, rotate the zoom control toward **T** (🔍) again.



📌 More Information

See "Basic Menu Operations" (📖6) for more information.









Changing Scene Mode Settings

- Features That Can Be Set Using the Multi Selector → 49
- Features That Can Be Set Using the **MENU** (Menu) Button
 - Image mode → 62
 - Setup menu → 96



Characteristics of Each Scene

- Use of a tripod is recommended in scene modes with  indicated due to slow shutter speed.
- Set **Vibration reduction** in the setup menu (96) to **Off** when using a tripod to stabilize the camera.



Scene auto selector

- When you point the camera at the subject, the camera automatically selects the optimum scene mode from the list below and adjusts the shooting settings accordingly. : Portrait, : Landscape, : Night portrait, : Night landscape, : Close-up, : Backlighting, : Other scenes
- The camera automatically selects the focus area for autofocus in accordance with the composition. The camera detects and focuses on faces (67).
- If the camera switches to night landscape or night portrait scene mode, it shoots a single picture at a slow shutter speed.
- The digital zoom is not available.







Note on Selecting a Scene Mode Using Scene Auto Selector

Depending upon shooting conditions, the camera may not select the desired scene mode. Should this occur, switch to  (auto) mode (31) or select the optimum scene mode for the subject manually.

Night landscape

- Press the **MENU** button to select  **Hand-held** or  **Tripod** in **Night landscape**.
-  **Hand-held** (default setting): This enables you to shoot with the minimum of camera shake and noise even when holding the camera by hand.
 - When the shutter-release button is pressed all the way, pictures are shot continuously, and the camera combines these pictures to save a single picture.
 - Once the shutter-release button is pressed all the way, hold the camera steady without moving it until a still picture is displayed. After taking a picture, do not turn the camera off before the monitor switches to the shooting screen.
-  **Tripod**: Select this mode when the camera is stabilized, such as with a tripod.
 - Vibration reduction is not used even if **Vibration reduction** in the setup menu (96) is set to **On**.
 - Press the shutter-release button all the way to shoot a single picture at a slow shutter speed.
- When the shutter-release button is pressed halfway, the camera adjusts the focus to infinity. The focus area or focus indicator (8) always lights in green.
- The digital zoom is not available.



Night portrait

- Press the **MENU** button to select  **Hand-held** or  **Tripod** in **Night portrait**.
-  **Hand-held** (default setting): This enables you to shoot with the minimum of camera shake and noise even when holding the camera by hand.
 - For a scene with a dark background, when the shutter-release button is pressed all the way, pictures are shot continuously. The camera combines these pictures to save a single picture.
 - When shooting at the telephoto zoom position, the camera may not shoot pictures continuously even if a scene has a dark background.
 - Once the shutter-release button is pressed all the way, hold the camera steady without moving it until a still picture is displayed. After taking a picture, do not turn the camera off before the monitor switches to the shooting screen.
 - If the subject moves while the camera is shooting continuously, the image may be distorted, overlapped or blurred.
-  **Tripod**: Select this mode when the camera is stabilized, such as with a tripod.
 - Vibration reduction is not used even if **Vibration reduction** in the setup menu ( 96) is set to **On**.
 - Press the shutter-release button all the way to shoot a single picture at a slow shutter speed.
- The flash always fires.
- The camera detects and focuses on a face ( 67).
- The skin softening feature makes the skin tones in people's faces appear softer ( 46).
- If no faces are detected, the camera focuses on the subject at the center of the frame.
- The digital zoom is not available.

 Backlighting

- Press the **MENU** button to select **On** or **Off** for HDR (high dynamic range) composition on the screen displayed after **Backlighting** is selected.
- **Off** (default setting): The flash fires to prevent the backlit subject from being hidden in shadow.
- **On**: Use when taking pictures with very bright and dark areas in the same frame.
- The camera focuses at the center area of the frame.

 **Notes on HDR**

- Use of a tripod is recommended. Set **Vibration reduction** in the setup menu (96) to **Off** when using a tripod to stabilize the camera.
- The angle of view (i.e., the area visible in the frame) seen in the saved image is narrower than that seen on the monitor at the time of shooting.
- When the shutter-release button is pressed all the way, the camera shoots pictures continuously and saves the following 2 images.
 - An image processed by D-Lighting (74) at the time of shooting (image compensated to make a dark area brighter)
 - HDR composite image (loss of detail is reduced in highlights and shadows)
 - If there is only enough memory to save one image, one image processed by D-Lighting is the only image saved.
- Once the shutter-release button is pressed all the way, hold the camera steady without moving it until a still picture is displayed. After taking a picture, do not turn the camera off before the monitor switches to the shooting screen.
- Depending on the shooting conditions, dark shadows may appear around bright subjects and bright areas may appear around dark subjects.

Scene Mode (Shooting Suited to Scenes)

SCENE → Portrait

- The camera detects and focuses on a face (📖67).
- The skin softening feature makes the subject's skin appear softer (📖46).
- If no faces are detected, the camera focuses on the subject at the center of the frame.
- The digital zoom is not available.

SCENE → Landscape

- When the shutter-release button is pressed halfway, the camera adjusts the focus to infinity. The focus area or focus indicator (📖8) always lights in green.

SCENE → Sports

- The camera focuses at the center area of the frame.
- When you continue to press the shutter-release button all the way, up to 5 pictures are shot at a rate of about 7.5 frames per second (fps) (when image mode is set to **18M 4896x3672**).
- The camera focuses on the subject even when the shutter-release button is not pressed halfway. You may hear the sound of the camera focusing.
- Focus, exposure, and hue are fixed at the values determined with the first image in each series.
- The frame rate with continuous shooting may become slow depending upon the current image mode setting, the memory card used, or shooting condition.

SCENE → Party/indoor

- The camera focuses at the center area of the frame.
- As images are easily affected by camera shake, hold the camera steadily. Set **Vibration reduction** to **Off** in the setup menu (📖96) when shooting using a tripod to stabilize the camera.

SCENE →  Beach

- The camera focuses at the center area of the frame.

SCENE →  Snow

- The camera focuses at the center area of the frame.







SCENE →  Sunset

- The camera focuses at the center area of the frame.

SCENE →  Dusk/dawn

- When the shutter-release button is pressed halfway, the camera adjusts the focus to infinity. The focus area or focus indicator (8) always lights in green.

SCENE →  Close-up

- The macro mode (54) will be set to on, and the camera automatically zooms to the closest position to the subject where the camera can shoot.
- You can move the focus area that the camera focuses on. Press the  button and then press the multi selector , ,  or  to move the focus area. To adjust the following settings, press the  button to temporarily cancel focus area selection, and then adjust each setting.
 - Flash mode, self-timer or exposure compensation
- The camera focuses on the subject even when the shutter-release button is not pressed halfway. You may hear the sound of the camera focusing.

SCENE → 🍴 Food

- The macro mode (📖54) will be set to on, and the camera automatically zooms to the closest position to the subject where the camera can shoot.
- You can adjust the hue by pressing the multi selector ▲ or ▼. The hue adjustment setting is saved in the camera's memory even after the camera is turned off.
- You can move the focus area that the camera focuses on. Press the OK button and then press the multi selector, ▲, ▼, ◀ or ▶ to move the focus area. To adjust the following settings, press the OK button to temporarily cancel focus area selection, and then adjust each setting.
 - Hue, self-timer or exposure compensation
- The camera focuses on the subject even when the shutter-release button is not pressed halfway. You may hear the sound of the camera focusing.

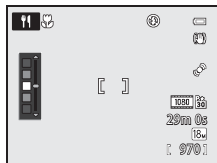

SCENE → 🏛️ Museum

- The camera focuses at the center area of the frame.
- The camera captures up to 10 images while the shutter-release button is pressed all the way, and the sharpest image in the series is automatically selected and saved (BSS (Best Shot Selector) (📖62)).

SCENE → 🎆 Fireworks show





- The shutter speed is fixed at 4 seconds.
- The camera focuses at infinity. When the shutter-release button is pressed halfway, the focus indicator (📖8) always lights in green.

SCENE →  **Black and white copy**

- The camera focuses at the center area of the frame.
- When shooting nearby object, shoot with macro mode (54).

SCENE →  **Easy panorama**

You can take a panorama picture simply by moving the camera in the desired direction.

- Select the shooting range from **Normal (180°)** (default setting) or **Wide (360°)** on the screen that is displayed when  **Easy panorama** scene mode is selected.
- Press the shutter-release button all the way, remove your finger from the button, and then slowly pan the camera horizontally. Shooting automatically ends when the camera captures the specified shooting range.
- When shooting starts, the camera focuses on the subject at the center area of the frame.
- The zoom is fixed at the wide-angle position.
- When the  button is pressed while the picture recorded with Easy panorama is displayed in full-frame playback mode, the camera scrolls the displayed area automatically.

See “Using Easy Panorama (Shooting and Playing back)” (2).

 **Note on Printing Panorama Pictures**

When printing panorama pictures, a full view may not be printed depending on the printer settings. Additionally, printing may not be available depending on the printer.

For more information, see your printer’s manual or contact a digital photo lab.

SCENE → 🐾 Pet portrait

- When the camera is pointed at a dog or cat, it detects and focuses on its face. In the default setting, the shutter is automatically released when the camera has focused on the pet (pet portrait auto release).
- On the screen that appears when 🐾 **Pet portrait** is selected, select **Single** or **Continuous**.
 - **Single**: One picture is captured at a time.
 - **Continuous**: The camera automatically captures 3 pictures continuously at a rate of about 1.9 frames per second when it has focused on the detected face. When the shutter is released manually, about 31 pictures are shot at a rate of about 1.9 frames per second while you hold the shutter-release button all the way (when image mode is set to [8] 4896x3672).

✔ **Pet Portrait Auto Release**

- To change **Pet portrait auto release** settings, press the multi selector ◀ (🔊).
 - [📷]: When the camera detects a pet's face, it focuses and then releases the shutter automatically.
 - **OFF**: The camera does not release the shutter automatically, even if a pet's face is detected. Press the shutter-release button to release the shutter. The camera also detects human faces ([67]). When both human and pet's faces are detected, the camera focuses on the pet's face.
 - In the following situations, **Pet portrait auto release** is automatically switched to **OFF**.
 - When a continuous shooting series with pet portrait auto release is repeated 5 times
 - When the internal memory or the memory card is full
- To continue shooting with **Pet portrait auto release**, press the multi selector ◀ (🔊) to set again.

✔ **Focus Area**

- The detected face is framed by a yellow double border (focus area). When the camera has focused on the face, the double border turns green.
- When the camera detects more than one face of dog or cat (up to 5), the largest face displayed on the monitor is framed by a double border (focus area) and the others by single borders.
- If no human or pet's faces are detected, the camera focuses on the subject at the center of the frame.

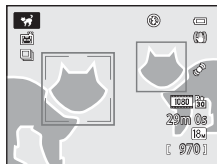

✔ **Notes on Pet Portrait**

- The digital zoom is not available.
- Under some shooting conditions, such as subject-to-camera distance, speed of moving pets, direction in which the pets are facing, and brightness of the faces, the camera may be unable to detect a face, or may display a border around something other than a dog or cat.

✔ **Viewing Pictures Taken Using Pet Detection**

When zooming in on an image displayed in full-frame playback mode by rotating the zoom control toward **T** (🔍), the image is enlarged at the center of a pet's face detected during shooting ([69]) (except for pictures taken with continuous shooting).

SCENE → 3D 3D photography

- The camera takes one picture for each eye to simulate a three-dimensional image on a 3D-compatible TV or monitor.
- After pressing the shutter-release button to shoot the first frame, move the camera horizontally to the right until the guide on the screen overlaps the subject. The camera automatically captures the second image when it detects that the subject is aligned with the guide.

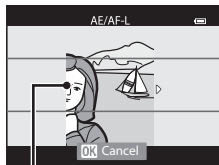

Guide

- The focus area that the camera focuses on can be moved. To move the focus area, press the **OK** button, and then press the multi selector **▲**, **▼**, **◀** or **▶**. To adjust the following settings, press the **OK** button to cancel the status in which the focus area can be selected, and then perform each setting.
 - Macro mode
 - Exposure compensation
- The focus, exposure, and white balance are fixed when the first frame is shot, and **AE/AF-L** is displayed on the screen.
- The angle of view (i.e., the area visible in the frame) seen in the saved image is narrower than that seen on the monitor at the time of shooting.
- The image mode to be saved is set to **1920x1080**.
- The two captured images are saved as a 3D image (MPO file). The first image (the left eye image) is also saved as a JPEG file.

✓ Notes on 3D Photography

- Moving subjects are not suited to 3D photography.
- Pictures have a less pronounced 3D feel as the distance between the camera and subject is increased.
- Pictures may have a less pronounced 3D feel when the subject is dark or when the second picture is not aligned precisely.
- Pictures taken under dim lighting may appear grainy with noise.
- The telephoto zoom position is restricted to an angle of view equivalent to that of about 134 mm lens in 35mm [135] format.
- The operation is canceled when the **OK** button is pressed after shooting the first frame or the camera cannot detect that the guide is on the subject within 10 seconds.
- If the camera does not take the second picture and cancels the shooting even when you align the guide with the subject, try shooting with the shutter-release button.
- This camera cannot record 3D movies.

Viewing 3D Photography

- 3D images cannot be played back in 3D on the camera monitor screen. Only the left eye image is displayed during playback.
- To view 3D images in 3D, a 3D-compatible TV or monitor is required. 3D images can be played back in 3D by connecting the camera to a 3D-compatible TV or monitor using a 3D-compatible HDMI cable (📖77).
- When connecting the camera using an HDMI cable, set the following for the **TV settings** in the setup menu (📖96).
 - **HDMI: Auto** (default setting) or **1080i**
 - **HDMI 3D output: On** (default setting)
- When the camera is connected using an HDMI cable for playback, it may take a while to switch the display between 3D images and non-3D images. The images played back in 3D cannot be enlarged.
- See the documentation included with your TV or monitor to perform settings of the TV or monitor.

Note on Viewing 3D Images

When viewing 3D images on a 3D-compatible TV or monitor for an extended period of time, you may experience discomfort such as eye strain or nausea. Carefully read the documentation included with your TV or monitor to ensure proper use.

Smart Portrait Mode (Shooting Smiling Faces)

If the camera detects smiling faces, the shutter is automatically released without pressing the shutter-release button (smile timer). The skin softening function makes facial skin tones softer.

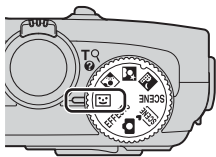

1 Frame the picture and wait for the subject to smile.

- When the camera detects a human face, a yellow double border (focus area) is displayed around that face. When the camera has focused on that face, the double border will light in green for a moment and focus is locked.
- Up to 3 faces can be detected. When more than one face is detected, the face closest to the center of the frame is framed by a double border and the others by single borders.
- If the camera detects that the face framed by the double border is smiling, the **Smile timer** (📖63) feature is activated and the shutter is automatically released.
- Each time the shutter is released, automatic shooting using face detection and smile detection is repeated.



2 Shooting ends.

- To finish automatic shooting of smile detection, perform any of the following operations.
 - Set the **Smile timer** to **Off**.
 - Rotate the mode dial to switch to a shooting mode other than 😊 (smart portrait) mode.
 - Turn off the camera.

✓ Notes on Smart Portrait Mode

- The digital zoom is not available.
- Under some shooting conditions, faces and smiling faces may not be detected properly.
- See "Notes on Face Detection" (📖67) for more information.



📌 When the Self-timer Lamp Flashes

When the camera detects a face, the self-timer lamp flashes. The lamp quickly flashes immediately after the shutter is released.

📌 Releasing the Shutter Manually







The shutter can also be released by pressing the shutter-release button. If no faces are detected, the camera focuses on the subject at the center of the frame.

Changing Smart Portrait Mode Settings

- Features That Can Be Set Using the Multi Selector → 49
- Features That Can Be Set Using the **MENU** (Menu) Button
 - Smart portrait menu → 63
 - Setup menu → 96



Using Skin Softening

In the following shooting modes, the camera detects up to 3 human faces when the shutter is released, and processes the image to make facial skin tones softer before saving the image.

-  (Scene auto selector) (34),  (Night portrait) (36) or **Portrait** (38) in scene mode
- Smart portrait mode (45)

Skin softening in **Glamour retouch** (74) can also be applied to saved images, even after shooting.

Notes on Skin Softening

- It may take more time to save images.
- Under some shooting conditions, the desired skin softening results may not be achieved, and skin softening may be applied to areas of the image where there are no faces.
- The skin softening level cannot be adjusted when shooting in  (Scene auto selector), or  (Night portrait) or **Portrait** scene mode.

Special Effects Mode (Applying Effects When Shooting)

You can select one of the special effects to shoot pictures.

To select an effect, press the **MENU** button to display the special effects menu.

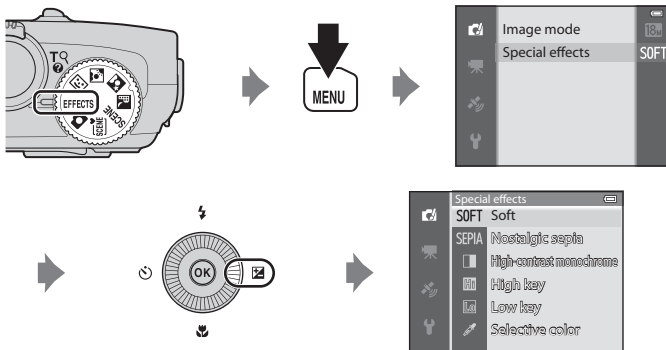

- The camera focuses on the subject at the center area of the frame.

More Information

See "Basic Menu Operations" (📖6) for more information.

Special Effects Mode (Applying Effects When Shooting)

Option	Description
Soft	Soften the image by adding a slight blur to the overall image.
Nostalgic sepia	Add a sepia tone and reduce the contrast to simulate the qualities of an old photograph.
High-contrast monochrome	Change the image to black and white and gives it sharp contrast.
High key	Give the overall image a bright tone.
Low key	Give the overall image a dark tone.
Selective color	<p>Create a black and white image in which only the specified color remains.</p> <ul style="list-style-type: none">Use the multi selector ▲ or ▼ to select the color to be retained from the slider. <p>To adjust the following settings, press the OK button to temporarily cancel color selection, and then adjust each setting.</p> <ul style="list-style-type: none">- Flash mode (📖50)- Macro mode (📖54) <p>To return to the color selection screen, press the OK button again.</p>

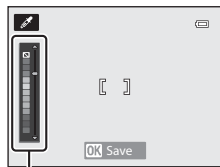

Slider

Changing Special Effects Mode Settings

- Features That Can Be Set Using the Multi Selector → 📖49
- Features That Can Be Set Using the **MENU** (Menu) Button
 - Image mode → 📖62
 - Setup menu → 📖96

Features That Can Be Set Using the Multi Selector

Press the multi selector or while shooting to operate the following functions.

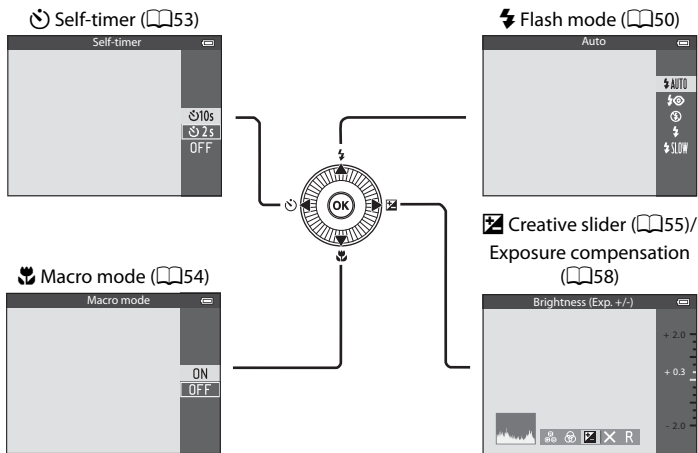

Available Functions

Available functions differ according to the shooting mode as follows.

- See "List of the Default Settings" (59) for more information on the default settings in each shooting mode.

Function		SCENE, 		EFFECTS
Flash mode (50)	✓	1	✓ ²	✓
Self-timer (53)	✓		✓ ²	✓
Macro mode (54)	✓		-	✓
Creative slider Brightness (Exposure compensation)/ Vividness / Hue (55)	✓		-	-
Exposure compensation (58)	-		✓	✓

¹ The setting varies with scene mode. See "List of the Default Settings" (59) for more information.

² The setting varies with the smart portrait setting. See "List of the Default Settings" (59) for more information.

Using the Flash (Flash Modes)

You can set a flash mode that suits the shooting conditions.

- 1 Press ▲ (⚡ flash mode) on the multi selector.

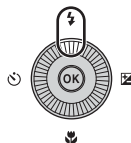

- 2 Press the multi selector to select the desired mode and press the OK button.

- See “Available Flash Modes” (📖51) for more information.
- If the OK button is not pressed within a few seconds, the selection will be canceled.
- When ⚡AUTO (auto) is applied, ~~⚡AUTO~~ is only displayed for a few seconds regardless of **Photo info** settings (📖96).

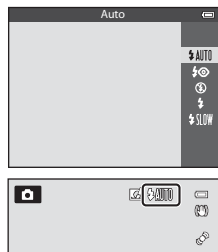

- 3 Frame the subject and shoot.

- The flash lamp indicates the status of the flash when you press the shutter-release button halfway.
 - On: The flash will fire when you press the shutter-release button all the way.
 - Flashing: The flash is charging. The camera cannot take pictures.
 - Off: The flash will not fire when a picture is taken.
- If the battery is low, the monitor will be turned off while the flash is charging.

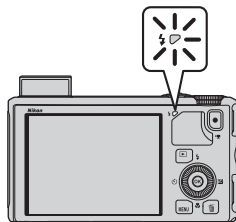

Raising the Flash

When you press the shutter-release button halfway, the flash will automatically pop up if the conditions required for flash photography are met.

- Auto flash (⚡AUTO auto, ⚡👁 auto with redeye reduction, or ⚡SLOW slow sync): If the lighting is dim, the flash automatically pops up when the shutter-release button is pressed halfway. The camera determines whether or not the flash pops up based on the brightness of the subject and the settings used during shooting.
- 🚫 off: The flash does not pop up, even when the shutter-release button is pressed halfway. The camera can shoot pictures with the flash lowered.
- ⚡ fill flash: The flash pops up when the shutter-release button is pressed halfway during shooting.



Lowering the Flash

When not using the flash, gently push to lower the flash until it clicks shut.

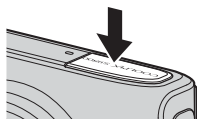

Available Flash Modes

- | | |
|--------------|---|
| ⚡AUTO | Auto |
| | Flash fires automatically when lighting is dim. |
| ⚡👁 | Auto with red-eye reduction |
| | Best choice for portraits. Reduces red-eye effect caused by flash in portraits (📖52). |
| 🚫 | Off |
| | Flash does not fire. |
| ⚡ | Fill flash |
| | The flash fires when a picture is taken, regardless of how bright the subject is. Use to “fill-in” (illuminate) shadows and backlit subjects. |
| ⚡SLOW | Slow sync |
| | Auto flash is combined with a slow shutter speed.
Suitable for portraits of human subjects shot at night or under dim light. Flash illuminates main subject; slow shutter speeds are used to capture background. |

Effective Range of the Flash

The flash has a range of about 0.5 to 6.0 m (1 ft 8 in. to 19 ft) for wide-angle position, and about 1.5 to 3.5 m (5 ft to 11 ft) for telephoto zoom position (when **ISO sensitivity** is set to **Auto**).

Flash Mode Setting

- The setting varies with shooting mode. See “Available Functions” (📖49) and “List of the Default Settings” (📖59) for more information.
- Some features cannot be used in combination with other menu settings. See “Features Not Available in Combination” (📖64) for more information.
- The changed flash mode setting applied in  (auto) mode is saved in the camera’s memory even after the camera is turned off.

Auto with Red-eye Reduction

This camera uses **advanced red-eye reduction (“In-Camera Red-Eye Fix”)**.

Pre-flashes are fired repeatedly at low intensity before the main flash, reducing the red-eye effect. If the camera detects “red-eye” when a picture is taken, Nikon’s own In-Camera Red-Eye Fix processes the image before it is recorded.

Note the following when taking pictures:

- Because pre-flashes are fired, there is a slight lag between when the shutter-release button is pressed and when the picture is shot.
- The time required to save the picture increases slightly.
- Advanced red-eye reduction may not produce the desired results in some situations.
- In extremely rare instances, areas not subject to red-eye may be affected by advanced red-eye reduction processing. In these cases, choose another mode and try again.

Using the Self-timer

The self-timer is suitable for taking group shots including yourself and reducing the vibration when the shutter-release button is pressed.

When using the self-timer, use of a tripod is recommended. Set **Vibration reduction** in the setup menu (📖96) to **Off** when using a tripod to stabilize the camera.

- 1** Press ◀ (🕒 self-timer) on the multi selector.

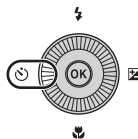

- 2** Use the multi selector to select 🕒10s (or 🕒2s) and press the OK button.

- 🕒10s (10 seconds): suitable for group pictures.
- 🕒2s (2 seconds): suitable for preventing camera shake.
- When the shooting mode is set to **Pet portrait** in scene mode, 🐾 (pet portrait auto release) is displayed (📖42). The self-timer is not available.
- The mode selected for the self-timer is displayed.
- If the OK button is not pressed within a few seconds, the selection will be canceled.

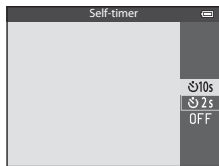

- 3** Frame the picture and press the shutter-release button halfway.

- Set the focus and exposure.

- 4** Press the shutter-release button all the way.

- The self-timer starts, and the number of seconds remaining before the shutter is released is displayed. The self-timer lamp flashes while the timer is counting down. About one second before the shutter is released, the lamp stops flashing and remains lit.
- When the shutter is released, the self-timer turns **OFF**.
- To stop the timer before a picture is taken, press the shutter-release button again.

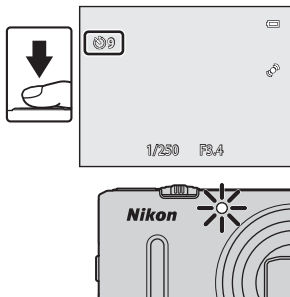

Using Macro Mode

When using macro mode, the camera can focus on subjects as close as 1 cm (0.4 in.) from the front of the lens.

This feature is useful when taking close-up pictures of flowers and other small subjects.

- 1 Press **▼** (🌸 macro mode) on the multi selector.

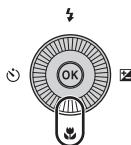

- 2 Press the multi selector **▲** or **▼** to select **ON** and press the **OK** button.

- If the **OK** button is not pressed within a few seconds, the selection will be canceled.

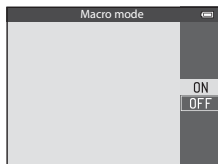

- 3 Use the zoom control to set the zoom ratio to a position where 🌸 and the zoom indicator light in green.

- How close you can be to the subject when shooting depends on the zoom ratio.

At the zoom position where 🌸 and the zoom indicator light in green, the camera can focus on subjects as close as about 10 cm (4 in.) or farther from the lens. At the 🌸 zoom position, it can focus on subjects as close as about 1 cm (0.4 in.) or farther from the lens.

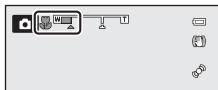

✔ Note on Using the Flash

The flash may be unable to light the entire subject at distances of less than 50 cm (1 ft 8 in.).

📎 Autofocus

In shooting modes such as scene modes that cannot use the **Autofocus mode** (📖62), **Full-time AF** may be turned on and the camera will adjust focus even if the shutter-release button is not pressed halfway when macro mode is set. You may hear the sound of the camera focusing.

📎 The Macro Mode Setting

- Macro mode cannot be used when using certain shooting modes. See “Available Functions” (📖49) and “List of the Default Settings” (📖59) for more information.
- The changed macro mode setting applied in 📷 (auto) mode is saved in the camera’s memory even after the camera is turned off.

Adjusting Brightness (Exposure Compensation), Vividness, and Hue (Creative Slider)



When the shooting mode is set to  (auto) mode, use the creative slider to adjust brightness (exposure compensation), vividness, and hue for taking pictures.

Operating the Creative Slider

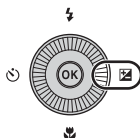
- 1** Press the multi selector .













- 2** Press the multi selector  or  to select ,  or .

- : Brightness (Exp. +/-) (exposure compensation)
- : Vividness (saturation adjustment)
- : Hue (white balance adjustment)



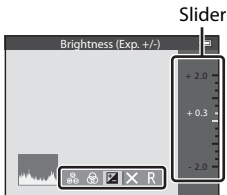

- 3** Adjust the brightness, vividness, or hue.

- Use the multi selector as explained below.
 -  : The slider moves. The effect can be adjusted while confirming the results on the monitor. The effect can also be adjusted by rotating the multi selector.
 -  : Switches between Brightness (Exp. +/-) (exposure compensation), vividness, and hue.
- For more information on each item, see the following:
 - : "Adjusting Brightness (Exposure Compensation)" (📖57)
 - : "Adjusting Vividness (Saturation Adjustment)" (📖57)
 - : "Adjusting Hue (White Balance Adjustment)" (📖57)
- To turn off the effects of the creative slider, press  or  to select , and press the  button.



4 When adjustment is complete, press ◀ or ▶ to select **X** and press the **OK** button.

- If the **OK** button (except when **R** is selected) or the shutter-release button is pressed in step 3, the selected amount of effect is applied. When the effect is applied, the camera returns to the shooting screen.
- If brightness is adjusted,  and the compensation value are displayed.
- If vividness is adjusted,  is displayed.
- If hue is adjusted,  is displayed.

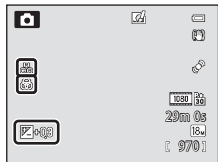
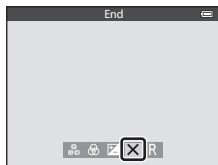

5 Press the shutter-release button to take a picture.

 **Creative Slider Settings**

- This feature may not be used in combination with certain features. See "Features Not Available in Combination" (p.64) for more information.
- The settings for Brightness (Exp. +/-) (exposure compensation), Vividness and Hue are saved in the camera's memory even when the camera is turned off.

Adjusting Brightness (Exposure Compensation)

Adjust the overall brightness of the image.

Setting	Explanation
"+" side	Make the subject brighter than the exposure set by the camera.
"-" side	Make the subject darker than the exposure set by the camera.
"0.0"	Cancel the exposure compensation.

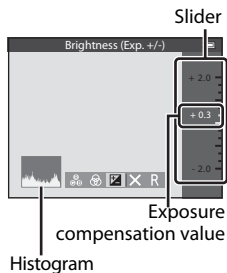

Using the Histogram

A histogram is a graph showing the distribution of tones in the image. Use as a guide when using exposure compensation and shooting without the flash.

- The horizontal axis corresponds to pixel brightness, with dark tones to the left and bright tones to the right. The vertical axis shows the number of pixels.
- Increasing exposure compensation shifts tone distribution to the right, and decreasing it shifts tone distribution to the left.

Adjusting Vividness (Saturation Adjustment)

Adjust the overall vividness of the image.

- The overall image vividness increases as the slider is moved up. The overall image vividness decreases as the slider is moved down.

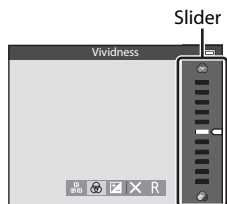

Adjusting Hue (White Balance Adjustment)

Adjust the overall hue of the image.

- The overall image becomes more reddish as the slider is moved up. The overall image becomes more bluish as the slider is moved down.

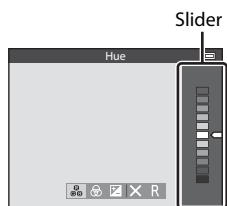

Note On White Balance Adjustment

When hue is adjusted using the creative slider, **White balance** in the shooting menu (📖62) cannot be set. To set **White balance**, select **R** in the creative slider setting screen to reset the brightness, vividness, and hue.

Adjusting Brightness (Exposure Compensation)

When the shooting mode is set to scene mode, smart portrait mode or special effects mode, you can adjust the brightness (exposure compensation).

- 1 Press **▶** (Exposure compensation) on the multi selector.

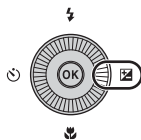

- 2 Press the multi selector **▲** or **▼** to select a compensation value.

Setting	Explanation
"+" side	Make the subject brighter than the exposure set by the camera.
"-" side	Make the subject darker than the exposure set by the camera.
"0.0"	Cancel the exposure compensation.

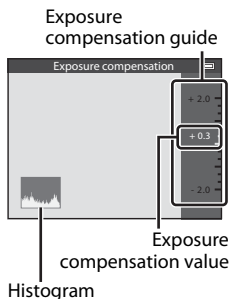

- 3 Press the **OK** button.

- If the **OK** button is not pressed within a few seconds, the selection is set and the setting menu disappears.
- Even when the shutter-release button is pressed without pressing the **OK** button, a picture can be shot using the selected compensation value.
- When an exposure compensation value other than **0.0** is applied, the value is displayed with the **Exposure compensation** icon on the monitor screen.

- 4 Press the shutter-release button to take a picture.

- To turn off exposure compensation, return to step 1, and change the value to **0.0**.

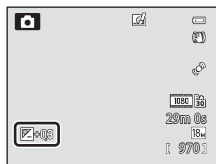

Exposure Compensation Value

- When the shooting mode is the **Fireworks show** (40) in scene mode, the exposure compensation cannot be used.
- When the exposure compensation is set while using a flash, the compensation is applied to both the background exposure and to the flash output.





Histogram

See "Using the Histogram" (57) for more information.

List of the Default Settings

The default settings in each shooting mode are described below.

- Similar information about scene mode can be found on the next page.

Shooting mode	Flash mode (📖50)	Self-timer (📖53)	Macro mode (📖54)	Creative slider (📖55)	Exposure compensation (📖57,58)
 (Auto) mode (📖31)	 AUTO	OFF	OFF	OFF	0.0
 (Smart portrait) (📖45)	 AUTO ¹	OFF ²	OFF ³	-	0.0
EFFECTS (Special effects) (📖47)		OFF	OFF	-	0.0

¹ Cannot be used when **Blink proof** is set to **On**.

² Can be set when **Smile timer** is set to **Off**.

³ The setting cannot be changed.





































































- Settings applied in  (auto) mode are saved in the camera's memory even after the camera is turned off (except for self-timer).



Features Not Available in Combination

Some features cannot be used in combination with other menu settings (📖64).

Features That Can Be Set Using the Multi Selector

Default settings in scene mode are described below.

	Flash mode ( 50)	Self-timer ( 53)	Macro mode ( 54)	Exposure compensation ( 58)
 ( 34)	 AUTO ¹	OFF	OFF ²	0.0
 ( 35)	 ²	OFF	OFF ²	0.0
 ( 36)	  ⁴	OFF	OFF ²	0.0
 ( 37)	  ³	OFF	OFF ²	0.0
 ( 38)	 	OFF	OFF ²	0.0
 ( 38)	 ²	OFF	OFF ²	0.0
 ( 38)	 ²	OFF ²	OFF ²	0.0
 ( 38)	  ⁵	OFF	OFF ²	0.0
 ( 39)	 AUTO	OFF	OFF ²	0.0
 ( 39)	 AUTO	OFF	OFF ²	0.0
 ( 39)	 ²	OFF	OFF ²	0.0
 ( 39)	 ²	OFF	OFF ²	0.0
 ( 39)	 ²	OFF	ON ²	0.0
 ( 40)	 ²	OFF	ON ²	0.0
 ( 40)	 ²	OFF	OFF	0.0
 ( 40)	 ²	OFF ²	OFF ²	0.0 ²
 ( 41)	 ²	OFF	OFF	0.0
 ( 41)	 ²	OFF ²	OFF ²	0.0
 ( 42)	 ²	 ⁶	OFF	0.0
3D ( 43)	 ²	OFF ²	OFF	0.0

¹  AUTO (auto) or  (off) can be selected. When  AUTO (auto) is selected, the camera automatically selects the flash mode appropriate for the scene it has selected.

² The setting cannot be changed.

³ Flash is fixed at  (fill flash) when **HDR** is set to **Off**, and is fixed at  (off) when **HDR** is set to **On**.

⁴ The setting cannot be changed. Fill flash fires for red-eye reduction.

⁵ May switch to slow sync with red-eye reduction flash mode. Other settings can be selected.

⁶ The self-timer is not available. Pet portrait auto release (42) can be set to on or off.

Features That Can Be Set Using the MENU (Menu) Button (Shooting Mode)

The shooting menu can be set by pressing the **MENU** button in shooting mode.

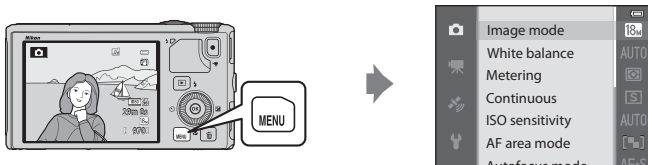

Available functions differ according to the shooting mode.

Function		SCENE ¹ 		EFFECTS ²
Image mode (📖62)	✓	✓	✓	✓
White balance (📖62)	✓	-	-	-
Metering (📖62)	✓	-	-	-
Continuous (📖62)	✓	-	-	-
ISO sensitivity (📖62)	✓	-	-	-
AF area mode (📖62)	✓	-	-	-
Autofocus mode (📖62)	✓	-	-	-
Quick effects (📖62)	✓	-	-	-
Skin softening (📖63)	-	-	✓	-
Smile timer (📖63)	-	-	✓	-
Blink proof (📖63)	-	-	✓	-

¹ When the mode dial is set to **SCENE**, you can select the desired scene from the scene menu. Other options may also be set for some selected scene modes. See “Characteristics of Each Scene” (📖34) for more information.

² The type of effects can be selected in **Special effects** mode. See 📖47 for more information.

Features Not Available in Combination

Some features cannot be used in combination with other menu settings (📖64).







More Information

See “Basic Menu Operations” (📖6) for more information.

Options Available in the Shooting Menu (📷 (Auto) Mode)

Option	Description	📖
Image mode	Allow you to select the combination of image size and image quality used when saving images. The default setting is 18M 4896x3672 .	📷29
White balance	Adjust colors in the image closer to the colors as they appear to the eye. Although Auto (default setting) can be used under most types of lighting, you can apply the white balance setting suited to the sky conditions or light source to achieve better results if default setting results are unsatisfactory.	📷31
Metering	Select the method that the camera uses to measure the brightness of the subject. The camera adjusts the exposure, which is a combination of shutter speed and aperture value, based on the brightness measurement. The default setting is Matrix .	📷33
Continuous	Set the mode used for taking a series of pictures. <ul style="list-style-type: none"> The default setting is Single (i.e., only one picture is captured at a time). When Continuous H, Continuous L, Pre-shooting cache or BSS (📖40) is set, the pictures are shot continuously while the shutter-release button is pressed all the way. If Continuous H: 120 fps, Continuous H: 60 fps or Multi-shot 16 is set, the specified number of pictures are shot continuously when the shutter-release button is pressed all the way. 	📷34
ISO sensitivity	Higher ISO sensitivity allows you to take pictures of darker subjects. Additionally, even with subjects of similar brightness, pictures can be taken with faster shutter speeds, and blurring caused by camera shake and subject movement can be reduced. When set to Auto (default setting), the camera sets the ISO sensitivity automatically.	📷37
AF area mode	Set how the camera determines the focus areas using the autofocus to Face priority (📖67), Manual, Center, Subject tracking or Target finding AF (📖66) (default setting).	📷38
Autofocus mode	When Single AF (default setting) is selected, the camera focuses only while the shutter-release button is pressed halfway. When Full-time AF is selected, the camera focuses even when the shutter-release button is not pressed halfway. You may hear the sound of the camera focusing.	📷41
Quick effects	Allow you to enable or disable the quick effects function (📖32). The default setting is On .	📷42

Options Available in the Smart Portrait Menu

Option	Description	
Image mode	Allow you to select the combination of image size and image quality used when saving images. The default setting is  4896x3672 .	 29
Skin softening	Enable skin softening. The camera makes facial skin tones softer before saving images. The extent of effect applied can be selected. The default setting is Normal .	 43
Smile timer	<p>The camera detects human faces and then automatically releases the shutter whenever a smile is detected.</p> <ul style="list-style-type: none"> • The default setting is On (single) (i.e., only one picture is captured at a time). • If On (continuous) is set, 5 pictures are shot continuously. • If On (BSS) is set, pictures are shot continuously using the BSS (Best Shot Selector) mode (40). • Self-timer cannot be used with this feature. 	 43
Blink proof	When On is selected, the camera automatically releases the shutter twice each time a picture is taken. Of the two shots, one in which the subject's eyes are open is saved. The flash cannot be used. The default setting is Off .	 44

Features Not Available in Combination

Some features cannot be used in combination with other menu settings.

Restricted function	Option	Descriptions
Flash mode	Continuous (📖62)	When Continuous is used for shooting, the flash cannot be used.
	Blink proof (📖63)	When Blink proof is set to On , the flash cannot be used.
Self-timer	AF area mode (📖62)	When Subject tracking is used for shooting, the self-timer cannot be used.
	Smile timer (📖63)	When Smile timer is used for shooting, the self-timer cannot be used.
Macro mode	AF area mode (📖62)	When Subject tracking is used for shooting, the macro mode cannot be used.
Image mode	Continuous (📖62)	<p>Image mode is fixed at the following depending on the continuous shooting settings.</p> <ul style="list-style-type: none"> • Pre-shooting cache: 2M (image size: 1600 × 1200 pixels). • Continuous H: 120 fps: VGA (image size: 640 × 480 pixels). • Continuous H: 60 fps: 1M (image size: 1280 × 960 pixels). • Multi-shot 16: 5M (image size: 2560 × 1920 pixels).
White balance	Hue (using the creative slider) (📖57)	When hue is adjusted using the creative slider, White balance in the shooting menu cannot be set. To set White balance , select R in the creative slider setting screen to reset the brightness, vividness, and hue.
Continuous	Self-timer (📖53)	If the self-timer is set when Pre-shooting cache is selected for shooting, Single is automatically selected.
ISO sensitivity	Continuous (📖62)	When Pre-shooting cache , Continuous H: 120 fps , Continuous H: 60 fps or Multi-shot 16 is selected for shooting, ISO sensitivity is fixed at Auto .
Quick effects	Continuous (📖62)	When Continuous is used, the quick effects in shooting mode cannot be used.
Monitor settings	Quick effects (📖62)	When Quick effects is set to On , Image review is fixed at On .

Restricted function	Option	Descriptions
Print date	Continuous (📖62)	When Continuous H, Continuous L, Pre-shooting cache, Continuous H: 120 fps, Continuous H: 60 fps or BSS is used for shooting, the print date cannot be used.
Motion detection	Continuous (📖62)	When Pre-shooting cache, Continuous H: 120 fps, Continuous H: 60 fps or Multi-shot 16 is used for shooting, Motion detection is disabled.
	ISO sensitivity (📖62)	When the ISO sensitivity is fixed to a setting other than Auto, Motion detection is disabled.
	AF area mode (📖62)	When Subject tracking is used for shooting, Motion detection is disabled.
Blink warning	Continuous (📖62)	When Continuous is used for shooting, the blink warning is disabled.
Digital zoom	Continuous (📖62)	When Multi-shot 16 is used for shooting, the digital zoom cannot be used.
	AF area mode (📖62)	When Subject tracking is used for shooting, the digital zoom cannot be used.

👍 Notes on Digital Zoom

- The digital zoom is not available depending on the shooting mode.
- When the digital zoom is in effect, selectable options for AF area mode or metering mode are restricted (👁️76).

Focusing on Subject

The focus area or focus range varies depending on the shooting mode.

- In  (auto) mode, focus area can be set by selecting **AF area mode** (📖62) in the shooting menu.

Using the Target Finding AF

When **AF area mode** is set to **Target finding AF**, the camera will adjust the focus during the following operations if you press the shutter-release button halfway.

- When the camera detects the main subject, it focuses on that subject. When the subject is in focus, the focus areas that match up with the size of the subject will light in green (multiple areas may light up).

When detecting a human face, the camera focuses on it as a priority.

- The camera has 9 focus areas, and if it does not detect the main subject, it automatically selects the focus areas containing the subject closest to the camera. When the subject is in focus, the focus areas that are in focus light in green.

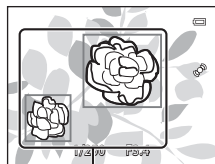

Focus area

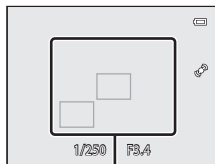

Focus area

✓ Notes on Target Finding AF

- Depending on shooting conditions, the subject that the camera determines to be the main subject may vary.
- When **White balance** is set to any setting other than **Auto**, the camera does not detect the main subject.
- The camera may not detect the main subject appropriately in the following situations:
 - When the subject is very dark or bright
 - When the main subject lacks clearly defined colors
 - When the shot is framed so that the main subject is on the edge of the monitor
 - When the main subject is composed of a repeating pattern

Using Face Detection

In the following settings, the camera uses face detection to automatically focus on human faces. If the camera detects more than one face, a double border is displayed around the face that the camera will focus on, and single borders are displayed around the other faces.

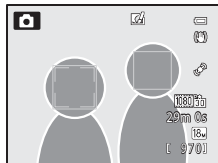

Setting	Number of faces that can be detected	Focus area (double border)
Face priority is selected for AF area mode (📖62) 📷 (Scene auto selector), 🌙 (Night portrait), Portrait , Pet portrait * scene modes (📖33)	Up to 12	The face closest to the camera
😊 Smart portrait mode (📖45)	Up to 3	The face closest to the center of the frame

* If **Pet portrait auto release** is switched to **OFF** when **Pet portrait** is selected, the camera will detect human faces (📖42).

- When using **Face priority**, if the shutter-release button is pressed halfway while no faces are detected or while framing a shot with no faces in it, the camera automatically selects the focus areas (up to 9) that contain the subject closest to the camera.
- When 📷 (Scene auto selector) is selected, the focus area changes depending on which scene the camera selects.
- When using 🌙 (Night portrait), **Portrait** or Smart portrait mode, if no faces are detected when the shutter-release button is pressed halfway, the camera will focus on the subject at the center of the frame.

✓ Notes on Face Detection

- The camera's ability to detect faces depends on a variety of factors, including whether or not the subject is facing the camera. Additionally, the camera may be unable to detect faces in the following situations:
 - When faces are partially hidden by sunglasses or otherwise obstructed
 - When faces take up too much or too little of the frame
- When the frame includes more than one face, the faces detected by the camera and the face on which the camera focuses depend upon a variety of factors, including the direction in which the subject is facing.
- In some rare cases, such as those described in "Autofocus" (📖68), the subject may not be in focus even though the double border turns green. If the camera does not focus, try "Focus Lock" (📖68).

📄 Viewing Pictures Taken Using Face Detection

When zooming in on an image displayed in full-frame playback mode by rotating the zoom control **T** (📖), the image is enlarged at the center of the face that was detected during shooting (📖69).

Focus Lock

Use focus lock to focus on off-center subjects when center is selected for AF area mode.

- Be sure that the distance between the camera and the subject does not change.
- When the shutter-release button is pressed halfway, the exposure is locked.

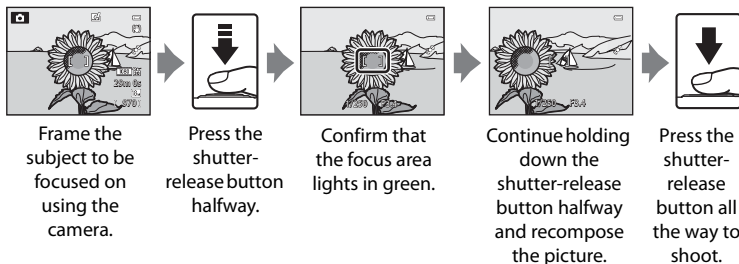

Autofocus

Autofocus may not perform as expected in the following situations. In some rare cases, the subject may not be in focus despite the fact that the focus area or focus indicator lights in green.

- Subject is very dark
- Objects of sharply differing brightness are included in the scene (e.g. the sun behind the subject makes that subject appear very dark)
- No contrast between the subject and surroundings (e.g. a portrait subject, wearing a white shirt, is standing in front of a white wall)
- Several objects are at different distances from the camera (e.g., an animal inside a cage)
- Subjects with repeating patterns (window blinds, buildings with multiple rows of similarly shaped windows, etc.)
- Subject is moving rapidly

In these situations, try pressing the shutter-release button halfway to refocus several times, or focus on another subject and use focus lock. When using focus lock, be sure that the distance between the camera and the subject with which focus was locked is the same as that for the actual subject.

Playback Features

Playback Zoom

Select an image to be enlarged in playback mode and rotate the zoom control toward **T** (Q).

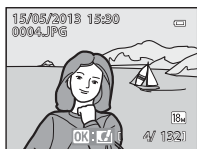
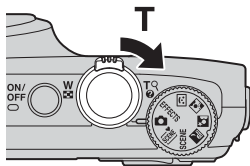

Image is displayed in full-frame playback mode.

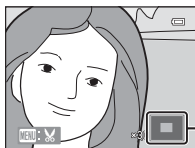



Image is zoomed in.

Display position guide

Operations During Playback Zoom

Function	Operation	Description
Adjusting the magnification	W (Q) / T (Q)	The zoom increases up to 10x.
Moving the display position		Move the display position.
Cropping	MENU	Crop only the displayed area of the image and save as a separate file (Q19).
Returning to full-frame playback mode	OK	Return to full-frame playback mode.

Enlarging Images Recorded with Face Detection or Pet Detection

Pictures taken using face detection (Q67) or pet detection (Q42) are enlarged at the center of the face that was detected during shooting (excepting images recorded by **Continuous** (Q62)). If the camera detected multiple faces, use ▲, ▼, ◀ and ▶ to display a different face. Change the zoom ratio and press ▲, ▼, ◀ or ▶ to zoom in on an area of the image where there are no faces.





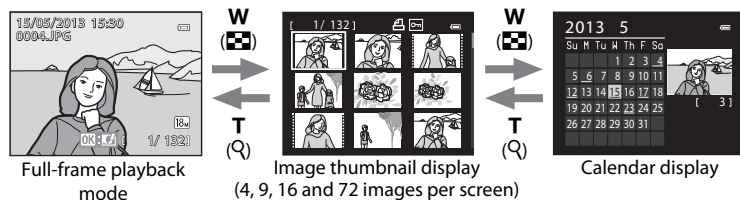
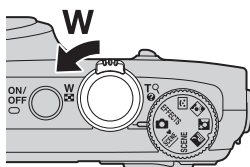

Viewing Several Images (Thumbnail Playback and Calendar Display)

Rotate the zoom control toward **W** () in playback mode.

This function will display several images at the same time, making it easy to find the desired image.



Operations During Thumbnail Playback and Calendar Display

Function	Operation	Description
Changing the number of images displayed	W () / T ()	<ul style="list-style-type: none"> Change the number of images to be displayed (4, 9, 16 and 72 images per screen). When 72 images are displayed, rotate the zoom control toward W () to switch to calendar display. When calendar is displayed, rotate the zoom control toward T () to switch to 72-image display.
Selecting an image or date		<ul style="list-style-type: none"> In thumbnail display mode, select an image. In calendar display mode, select a date.
Returning to full-frame playback mode		<ul style="list-style-type: none"> In thumbnail display mode, the selected image is displayed in full-frame playback mode. In calendar display mode, the first image captured on the selected date is displayed in full-frame playback mode.











Note on Calendar Display

Pictures taken when the camera's date is not set are treated as images captured on "January 1, 2013."

Selecting Certain Types of Images for Playback

Playback mode can be changed according to the type of images you want to view.

Available Playback Modes

Mode	Description	
 Play	All images are played back without selecting types of images. When you switch from shooting mode to playback mode, this mode is selected.	28
 Favorite pictures	Play back only the images added to an album. Before switching to this mode, images must be added to the album ( 74,  5).	 5
 Auto sort	The pictures taken are automatically sorted into categories such as portrait, landscape, and movies. Only images of the same category are played back.	 8
 List by date	Only images captured on the same date are played back.	 10

Switching Between Playback Modes



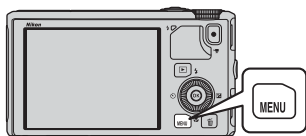

- 1 When viewing images, press the **MENU** button.

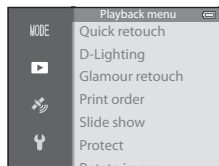
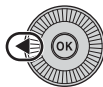

- 2 Press the multi selector .

- Menu icon selection is enabled.



- 3 Press  or  to choose the **MODE** menu icon and then press the  button or .

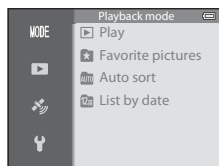

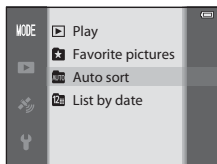

4 Press ▲ or ▼ to select a mode and then press the **OK** button.

- If you select **Play**, the playback screen is displayed.
- If you select other than **Play**, go to step 5.



5 Select an album, category, or shooting date and then press the **OK** button.

-  See "Favorite Pictures Mode" (5) for more information.
-  See "Auto Sort Mode" (8) for more information.
-  See "List by Date Mode" (10) for more information.
- To select the album, category, or shooting date again, repeat the operation from step 1.

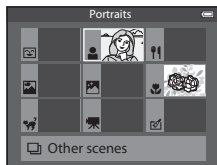

Auto sort mode

Features That Can Be Set Using the MENU (Menu) Button (Playback Mode)

When viewing images in full-frame playback mode or thumbnail playback mode, press the **MENU** button to set the playback menu (📖6).

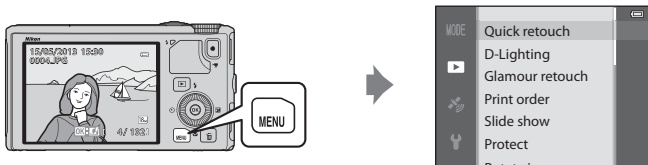

















Available functions differ according to the playback mode.

Feature	Play	Favorite pictures	Auto sort	List by date
Quick retouch (📖74)	✓	✓	✓	✓
D-Lighting (📖74)	✓	✓	✓	✓
Glamour retouch (📖74)	✓	✓	✓	✓
Print order (📖74)	✓	✓	✓	✓*
Slide show (📖74)	✓	✓	✓	✓*
Protect (📖74)	✓	✓	✓	✓*
Rotate image (📖74)	✓	✓	✓	✓
Small picture (📖74)	✓	✓	✓	✓
Voice memo (📖74)	✓	✓	✓	✓
Copy (📖74)	✓	–	–	–
Sequence display options (📖74)	✓	✓	✓	✓
Choose key picture (📖74)	✓	✓	✓	✓
Favorite pictures (📖74)	✓	–	✓	✓
Remove from favorites (📖74)	–	✓	–	–

* When using list by date mode, press the **MENU** button from the list by date screen (📖10) to apply the same setting to all images captured on the selected date.

Available Playback Menus

Option	Description	
Quick retouch ^{1, 2}	Create retouched copies in which contrast and saturation have been enhanced.	 16
D-Lighting ^{1, 2}	Create copies with enhanced brightness and contrast, brightening dark portions of an image.	 16
Glamour retouch ^{1, 2}	Make facial skin tones softer and make faces look smaller with larger eyes.	 17
Print order ^{3, 4}	When using a printer to print images saved on the memory card, the print order function can be used to select which images are printed, and how many copies of each image are printed.	 51
Slide show	Images saved in the internal memory or on a memory card are played back in an automatic slide show.	 54
Protect ⁴	Protect selected images and movies from accidental deletion.	 55
Rotate image ^{2, 3, 4}	Specify the orientation in which saved images are displayed in playback mode.	 55
Small picture ^{1, 2}	Create a small copy of the picture taken. This feature is useful for creating copies for display on Web pages or e-mail attachments.	 18
Voice memo ²	Use the camera's microphone to record voice memos and attach them to pictures taken. Playback and deletion of voice memos can also be performed.	 56
Copy ⁴	Copy images between the internal memory and a memory card. This function can also be used to copy movies.	 57
Sequence display options	Display a sequence of images shot continuously as individual images, or display only the key picture of a sequence.	 58
Choose key picture ⁴	Change the key picture for the series of pictures that were shot continuously (Pictures in a sequence,  11). • When changing this setting, select the desired sequence before displaying the menu.	 58
Favorite pictures ⁴	Select and add pictures to an album.	 5
Remove from favorites ⁴	Remove a picture from an album.	 6

Features That Can Be Set Using the MENU (Menu) Button (Playback Mode)

- ¹ This function is used to edit the currently selected image and save it as a separate file from the original file.
Note, however, that pictures taken using **Easy panorama** or **3D photography** cannot be edited.
Note also that there is a restriction on retouching edited images (📷14).
- ² This function cannot be used for pictures in the sequence when only the key picture is displayed. To use this function, press the 📷 button to display individual images before displaying the menu.
- ³ The function cannot be applied to pictures taken in scene mode **3D photography**.
- ⁴ Select an image in the image selection screen. See “Using the Screen for Selecting Images” (📖 76) for more information.

See “Editing Still Images” (📷13) and “The Playback Menu” (📷51) in the Reference Section for more information about each function.

Using the Screen for Selecting Images

The image selection screen is displayed in the following menus.

Only one image can be selected for some menu items, while for other menu items, multiple images can be selected.

Functions for which only one image can be selected	Functions for which multiple images can be selected
<ul style="list-style-type: none"> • Playback menu: Rotate image (👁55), Choose key picture (👁58) • Setup menu: Select an image in Welcome screen (👁67) • PictBridge (A printer is connected) : Print selection (👁24) 	<ul style="list-style-type: none"> • Playback menu: Select images in Print order (👁51), Protect (👁55), Selected images in Copy (👁57), Favorite pictures (👁5), Remove from favorites (👁6) • PictBridge (A printer is connected) : Print selection in Print menu (👁24) • Erase selected images in Delete (📖29)

Follow the procedure described below to select images.

1 Press the multi selector, ◀ or ▶ to choose the desired image.

- Rotate the zoom control toward **T** (👁) to switch to full-frame playback mode, or **W** (📖) to switch to 6-thumbnail display.
- For functions for which only one image can be selected, proceed to step 3.



2 Press ▲ or ▼ to select ON or OFF (or the number of copies).

- When **ON** is selected, an icon is displayed on the selected image. Repeat steps 1 and 2 to select additional images.



3 Press the Ⓞ button to apply the image selection.

- With selections such as **Erase selected images**, the confirmation dialog is displayed. Follow the instructions on the screen.

Connecting the Camera to a TV, Computer, or Printer

You can enhance your enjoyment of images and movies by connecting the camera to a TV, computer, or printer.

- Before connecting the camera to an external device, make sure the remaining battery level is sufficient and turn the camera off. For information about the connection methods and subsequent operations, refer to the documentation included with the device in addition to this document.

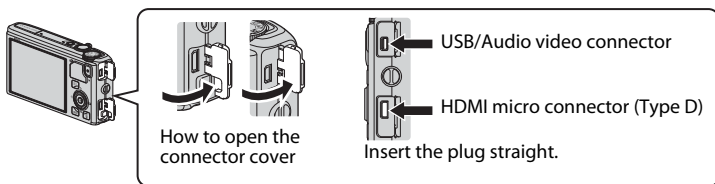

Viewing images on a TV

20



You can view the camera's images and movies on a TV.

Connection method: Connect the video and audio plugs of the included Audio Video Cable EG-CP16 to the TV's input jacks. Alternatively, connect a commercially available HDMI cable (Type D) to the TV's HDMI input jack.

Viewing and organizing images on a computer

78



If you transfer images to a computer, you can perform simple retouching and manage image data in addition to playing back images and movies.

Connection method: Connect the camera to the computer's USB input jack with the included USB Cable UC-E6.

- Before connecting to a computer, install ViewNX 2 on the computer using the included ViewNX 2 CD-ROM. See 80 for more information about using the included ViewNX 2 CD-ROM and transferring images to a computer.
- If any USB devices that draw the power from the computer are connected, disconnect them from the computer before you connect the camera to it. Connecting the camera and other USB-powered devices to the same computer simultaneously may cause a camera malfunction or excessive power supply from the computer, which could damage the camera or memory card.

Printing images without using a computer

22



If you connect the camera to a PictBridge-compatible printer, you can print images without using a computer.

Connection method: Connect the camera directly to the printer's USB input jack with the included USB cable.

Using ViewNX 2

ViewNX 2 is an all-in-one software package which enables you to transfer, view, edit and share images.

Install ViewNX 2 using the included ViewNX 2 CD-ROM.



Installing ViewNX 2

- An Internet connection is required.

Compatible Operating Systems

Windows

Windows 8, Windows 7, Windows Vista, Windows XP

Macintosh

Mac OS X 10.6, 10.7, 10.8

Refer to the Nikon website for details on system requirements, including the latest information on operating system compatibility.

1 Start the computer and insert the ViewNX 2 CD-ROM into the CD-ROM drive.

- Windows: If instructions for operating the CD-ROM are displayed in the window, follow the instructions to proceed to the installation window.
- Mac OS: When the **ViewNX 2** window is displayed, double-click the **Welcome** icon.

2 Select a language in the language selection dialog to open the installation window.

- If the desired language is not available, click **Region Selection** to choose a different region and then choose the desired language (the **Region Selection** button is not available in the European release).
- Click **Next** to display the installation window.

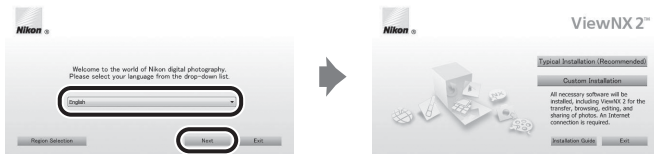

3 Start the installer.

- We recommend clicking **Installation Guide** in the installation window to check the installation help information and system requirements before installing **ViewNX 2**.
- Click **Typical Installation (Recommended)** in the installation window.

4 Download the software.

- When the **Software Download** screen is displayed, click **I agree - Begin download**.
- Follow the on-screen instructions to install the software.

5 Exit the installer when the installation completion screen is displayed.

- Windows: Click **Yes**.
- Mac OS: Click **OK**.

The following software is installed:

- ViewNX 2 (consisting of the three modules below)
 - Nikon Transfer 2: For transferring images to the computer
 - ViewNX 2: For viewing, editing, and printing transferred images
 - Nikon Movie Editor: For basic editing of transferred movies
- Panorama Maker (for creating a single panorama image of a landscape, etc. from a series of images that each captured a separate portion of the subject)

6 Remove the ViewNX 2 CD-ROM from the CD-ROM drive.

Transferring Images to the Computer

1 Choose how images will be copied to the computer.

Choose one of the following methods:

- **Direct USB connection:** Turn the camera off and ensure that the memory card is inserted in the camera. Connect the camera to the computer using the included USB cable. The camera automatically turns on. To transfer images that are saved in the camera's internal memory, remove the memory card from the camera before connecting it to the computer.

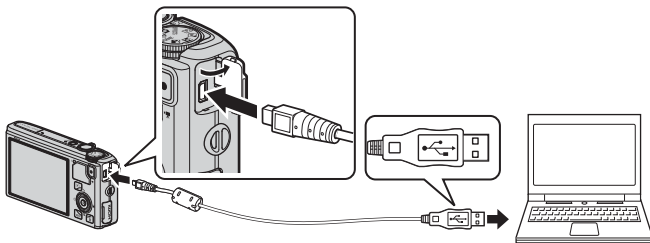

- **SD card slot:** If your computer is equipped with an SD card slot, the card can be inserted directly in the slot.
- **SD card reader:** Connect a card reader (available separately from third-party suppliers) to the computer and insert the memory card.

If a message is displayed prompting you to choose a program, select Nikon Transfer 2.

• When using Windows 7

If the dialog shown at right is displayed, follow the steps below to select Nikon Transfer 2.

- 1 Under **Import pictures and videos**, click **Change program**. A program selection dialog will be displayed; select **Import File using Nikon Transfer 2** and click **OK**.
- 2 Double-click **Import File**.



If the memory card contains a large number of images, it may take a while for Nikon Transfer 2 to start. Wait until Nikon Transfer 2 starts.

✓ Connecting the USB Cable

The connection may not be recognized if the camera is connected to the computer via a USB hub.

2 Transfer images to the computer.

- Confirm that the name of the connected camera or removable disk is displayed as the “Source” on the “Options” title bar of Nikon Transfer 2 (①).
- Click **Start Transfer** (②).

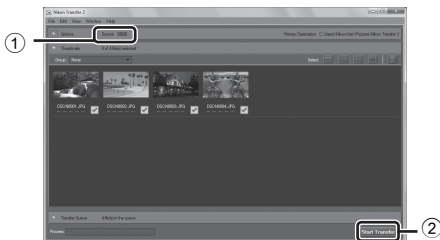

- At default settings, all the images on the memory card will be copied to the computer.

3 Terminate the connection.

- If the camera is connected to the computer, turn the camera off and disconnect the USB cable.
- If you are using a card reader or card slot, choose the appropriate option in the computer operating system to eject the removable disk corresponding to the memory card and then remove the card from the card reader or card slot.

Viewing Images

Start ViewNX 2.

- Images are displayed in ViewNX 2 when transfer is complete.
- Consult online help for more information on using ViewNX 2.



Starting ViewNX 2 Manually

- **Windows:** Double-click the **ViewNX 2** shortcut on the desktop.
- **Mac OS:** Click the **ViewNX 2** icon in the Dock.

Recording and Playing Back Movies

Recording Movies

You can record movies by simply pressing the **●** (🎥 movie-record) button. Color tones, white balance, and other settings are the same as they are when taking still images.

1 Turn on the camera and display the shooting screen.

- The movie options icon indicates the type of movie recorded (📖 86).
- When recording movies, the angle of view (i.e., the area visible in the frame) is narrower than that of still pictures. When **Photo info** (📖 96) is set to **Movie frame+auto info**, you can confirm the area visible in the frame before recording movies.

* The maximum movie length shown in the illustration differs from the actual value.

Movie option

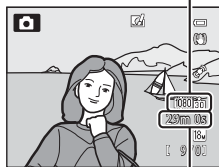

Maximum movie length*

2 Press the **●** (🎥 movie-record) button to start movie recording.

- The camera focuses on the subject at the center of the frame. Focus areas are not displayed during recording.
- See "Focus and Exposure During Movie Recording" (📖 83) for more information.
- See "Pausing Movie Recording" (📖 83) for more information.
- The approximate remaining movie length is displayed on the monitor screen. When a memory card is not inserted, **IN** is displayed and movie is saved to the internal memory.
- Recording stops automatically when the maximum movie length has been recorded.

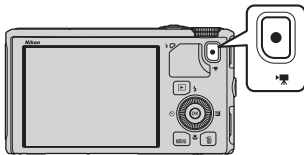

3 Press the **●** (🎥 movie-record) button again to end recording.

Focus and Exposure During Movie Recording

- The focus can be adjusted during movie recording in the following manner in accordance with the **Autofocus mode** (📖86) setting of the movie menu.
 - **AF-S Single AF** (default setting): The focus is locked when ● (▶📹 movie-record) button is pressed to start movie recording.
 - **AF-F Full-time AF**: The focus is adjusted repeatedly even during movie recording.
- Autofocus may not perform as expected (📖68). Should this occur, try to set **Autofocus mode** in the movie menu to **AF-S Single AF** (default setting) and then use focus lock (📖68) to record.

Pausing Movie Recording

When the multi selector ▶ is pressed during movie recording, recording is paused (except when using  **iFrame 540/30p** or HS movies). To resume recording, press ▶ again. If recording remains paused for more than five minutes or the ● (▶📹 movie-record) button is pressed, recording ends.

✔ Notes on Using Zoom During Movie Recording

- The zoom indicator is not displayed during movie recording.
- When the digital zoom is used, the image quality will deteriorate.
- If you start recording a movie without using digital zoom, and you keep rotating the zoom control toward **T(Q)**, the zoom stops at the maximum optical zoom ratio. Remove your finger from the zoom control and then rotate it again toward **T(Q)** to activate digital zoom. When movie recording ends, digital zoom is cancelled.

✔ Note on Recording Images and Saving Movies

The indicator showing the number of exposures remaining or the indicator showing the maximum movie length flashes while images are being recorded or while a movie is being saved. **Do not open the battery-chamber/memory card slot cover or remove the battery or memory card while an indicator is flashing.** Doing this could result in loss of data, or in damage to the camera or the memory card.





✔ Notes on Movie Recording

- When saving a movie onto a memory card, a memory card with an SD speed class of Class 6 or higher is recommended (📖17). If the transfer speed of the card is slow, the movie recording may end unexpectedly.
- The sounds of zoom control operation, zoom, autofocus, vibration reduction or aperture control when the brightness changes may be recorded.
- The following phenomena may be seen on the monitor screen while recording movies. These phenomena are saved in the recorded movies.
 - Banding may occur in images under fluorescent, mercury-vapor, or sodium-vapor lighting
 - Subjects that move quickly from one side of the frame to the other, such as a moving train or car, may appear skewed
 - The entire movie image may be skewed when the camera is panned
 - Lighting or other bright areas may leave residual images when the camera is moved





✔ Notes on the Camera Temperature

- The camera may become warm when recording movies for an extended period of time or when the camera is used in a hot area.
- When the temperature inside the camera becomes extremely high during movie recording, the camera may automatically stop recording to prevent internal damage to the camera. The message **"The camera will turn off to prevent overheating."** and a 10-second countdown indicator (🕒10s) are displayed on the monitor until the camera automatically stops recording and is turned off when it automatically stops recording. Leave the camera off until the inside of the camera has cooled and then use it.



Functions Available in Movie Recording

- The exposure compensation and **White balance** settings in shooting menu (61) are also applied with movie recording.
- When macro mode is enabled, movies of subjects closer to the camera can be recorded. Confirm settings before starting movie recording.
- The self-timer (53) can be used. If the self-timer is set and the  (movie-record) button is pressed, the camera starts movie recording after 10 or 2 seconds.
- The flash does not fire.
- Press the **MENU** button before starting to record the movie to display the  (movie) menu icon and select movie menu settings (86).

Recording HS (High Speed) Movies

When **Movie options** (86) in movie menu is set to  **HS 240/8x**,  **HS 480/4x**,  **HS 720/2x** or  **HS 1080/0.5x**, movies that can be played back in slow motion or fast motion can be recorded.

More Information

- See “Maximum Movie Length” (47) for more information.
- See “File and Folder Names” (97) for more information.

Features That Can Be Set Using the MENU (Menu) Button (Movie Menu)

Display the shooting screen → MENU button (📖6) → 📺 menu icon (📖7)

Press the **MENU** button on the shooting screen to display the menu screen and then select the 📺 menu icon to set the following options on the movie menu.

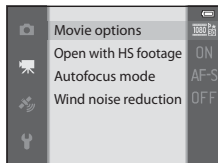

Available Movie Menu

Option	Description	📖
Movie options	Select the type of movie to be recorded. The camera can record normal speed movies and HS (high speed) movies, which can be played back in slow motion or fast motion. The default setting is 1080★/30p .	📖45
Open with HS footage	When HS movie recording is selected in Movie options , select whether or not to record HS movies from the start of recording. The default setting is On . When Off is selected, normal speed movies are recorded from the start of recording. When the button is pressed during recording, recording switches to HS movie recording.	📖49
Autofocus mode	Select how the camera focuses when recording normal speed movies. Single AF (default setting) where the focus is locked when movie recording begins, or Full-time AF where the camera focuses continuously during movie recording can be selected. When Full-time AF is selected, the sound of the camera focusing may be heard in recorded movies. If you want to prevent the sound of the camera focusing from being recorded, select Single AF .	📖49
Wind noise reduction	Set whether or not to reduce wind noise from the microphone during normal speed movie recording. During playback, not only wind noise, but other sounds may also become difficult to hear. The default setting is Off .	📖50

More Information

See "Basic Menu Operations" (📖 6) for more information.

Playing Back Movies

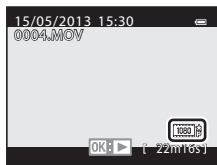

1 Press the  (playback) button to select playback mode.

- Use the multi selector to select a movie.
- Movies can be recognized by the movie options icon ()86).









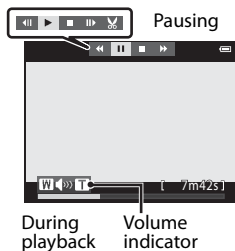





2 Press the  button to play back a movie.





Operations Available During Movie Playback

Rotate the multi selector to fast forward or rewind. Playback controls appear at the top of the monitor. Press the multi selector  or  to select an icon of playback control, then press the  button to perform the following operations.



To	Use	Description
Rewind		Rewind the movie while the  button is pressed down.
Advance		Advance the movie while the  button is pressed down.
Pause		The following operations can be performed with the playback controls at the top of the monitor while playback is paused.
		 Rewind the movie by one frame. Hold down the  button to rewind continuously.*
		 Advance the movie by one frame. Hold down the  button to advance continuously.*
		 Extract and save only the required parts of the movie ()27).
		Resume playback.
End		Return to full-frame playback mode.

* The movie can also be advanced or rewound by rotating the multi selector.

To delete a movie, use full-frame playback mode ()28) or thumbnail playback mode ()70) to select a movie and press the  button ()29).

Adjusting the Volume

Operate the zoom control **T/W** ()1) during playback.

Using GPS/Electronic Compass (COOLPIX S9500 only)

Starting GPS Data Recording

The camera's internal GPS receives signals from the GPS satellites and identifies its current time and position.

The position information (latitude and longitude) can be recorded on the pictures to be shot.

Turn the GPS Functions On

Press the MENU button → (GPS options) menu icon (📖7) → GPS options

Set **Time zone and date** (📖96) correctly before using the GPS function.

- 1 Use the multi selector to select **Record GPS data**, and then press the **OK** button.

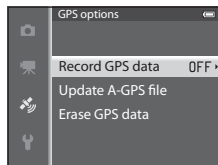

- 2 Select **On** and press the **OK** button.
 - Signals are received from the GPS satellites and positioning starts.
 - The default setting is **Off**.

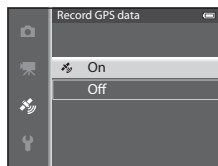

- 3 Press the MENU button.
 - The camera returns to shooting screen.
 - Operate in an open-air area when starting to receive signals from GPS satellites.





✓ Notes on GPS

- Before using the GPS functions, read “<Important> Notes on GPS/Electronic Compass (COOLPIX S9500 only)” (□xi).
- It takes a few minutes to obtain position information when positioning is performed for the first time or in a situation where positioning cannot be performed for a long period of time, or just after the battery is replaced.
- Positions of the GPS satellites change constantly.
You may not be able to determine the position or it may take some time depending on your location and the time.
To use the GPS feature, use the camera in an open-air area with few obstacles in the sky. Signal receiving will be smoother if the GPS antenna (□1) is facing the sky.
- The following locations which block or reflect signals may result in failed or inaccurate positioning.
 - Inside buildings or underground locations
 - Between high-rise buildings
 - Under overpasses
 - Inside tunnels
 - Near high-voltage electrical power lines
 - Between clusters of trees
- Using a mobile phone of 1.5 GHz band near this camera may disrupt positioning.
- When carrying this camera around while positioning, do not place it in a metal bag. Positioning cannot be performed if the camera is covered with metal materials.
- When there is a significant difference in the signals from the GPS satellites, there could be a deviation of up to several hundred meters.
- Be aware of your surroundings when positioning.
- The shooting date and time that is displayed when playing back images is determined by the camera's internal clock at the time of shooting.
The time obtained by the position information and recorded on images will not be displayed on the camera.
- Position information for the first frame will be recorded on a series of pictures shot using continuous shooting.

✓ Battery Drain While Recording GPS Data



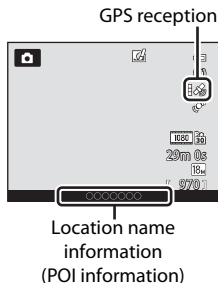

- When **Record GPS data** is set to **On**, GPS functions will continue to operate at the specified interval for approximately 6 hours even after the camera is turned off. Also, GPS functions will continue to operate while recording log data (□92) even after the camera is turned off.
- When **Record GPS data** is set to **On**, battery power drains faster than usual. Confirm the battery level especially when the camera is recording log data.

GPS Reception Indicator and Point of Interest (POI) Information

- GPS reception can be checked on the shooting screen.
 - : Signals are being received from four or more satellites and positioning is being performed. Position information is recorded on the image.
 - : Signals are being received from three satellites and positioning is being performed. Position information is recorded on the image.
 - : Signals are being received from the satellites, but positioning is not possible. The position information is not recorded on the image.
 - : Signals cannot be received from the satellites, and positioning is not possible. The position information is not recorded on the image.
- POI information is location name information for the nearest landmarks (facilities) and other details.
 - When **Display POI** in **Points of interest (POI)** of the GPS options menu (91) is set to **On**, the nearest location name information for the current location is displayed during shooting.
 - When **Embed POI** is set to **On**, location name information can be recorded on the image during shooting.
 - If the location name information is recorded on the image during shooting, this information is displayed when **Display POI** is set to **On** during playback.
- “----” may be displayed for the location name information depending on the setting level in **Level of detail** of **Points of interest (POI)**. Also, certain landmark names may not be registered, or the landmark name may be different.



Pictures with Recorded Position Information

- The  icon is displayed during playback for images which have the position information recorded (10).
- Position information recorded on a picture can be checked on a map with ViewNX 2 after transferring the image to a computer (78).
- The actual place of shooting may differ from the GPS information recorded on the image files due to the accuracy of the position information obtained and a difference in the geodetic system used.
- The position information and POI information recorded on pictures can be erased using **Erase GPS data** in **GPS options** (91). The erased information cannot be recovered.



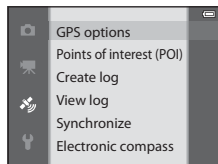

Features That Can Be Set Using the MENU (Menu) Button (GPS Options Menu)

Press the MENU button →  (GPS options) menu icon ()







From the menu screen, select the  menu icon to display the GPS options menu, and then you can change the following settings.



Available GPS Options Menu

Option	Description	
GPS options	<p>Record GPS data: When set to On, signals are being received from the GPS satellites and positioning starts (88). The default setting is Off.</p> <p>Update A-GPS file: A memory card is used to update the A-GPS (assist GPS) file. Using the latest A-GPS file can shorten the time needed for tracking the position information.</p> <ul style="list-style-type: none"> Download the latest A-GPS file from the website below, and use it to update the file. http://nikonimglib.com/agps/index.html <p>Erase GPS data: The position information and POI information recorded on pictures are erased.</p>	 59
Points of interest (POI)	<p>Make the settings for the POI (points of interest, location name information).</p> <p>Embed POI: When set to On, the location name information is recorded on the pictures to be shot. The default setting is Off.</p> <p>Display POI: When set to On, the location name information is displayed on the shooting screen or playback screen. If Embed POI is set to On and a picture is taken, the location name information for the picture is displayed on the playback screen. The default setting is Off.</p> <p>Level of detail: Set the display level of the location name information. A higher display level shows more detailed regional information, and a lower display level shows regional information for a wider area (such as country names).</p> <p>Edit POI: The level of the location name information recorded on the image can be changed, and the regional information can be deleted.</p>	 61

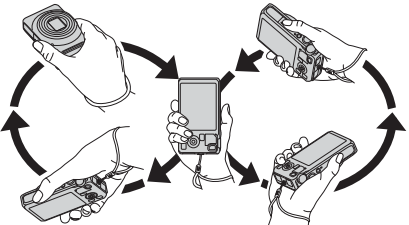
Features That Can Be Set Using the MENU (Menu) Button (GPS Options Menu)

Option	Description	
Create log	<p>The measured position information is recorded at the interval set for Log interval until a preset time set using Start log is reached (only when Record GPS data in GPS options of the GPS options menu is set to On).</p> <ul style="list-style-type: none"> To display the log data, select End log and save the log to a memory card. 	 62
View log	<p>You can delete log data that was recorded to a memory card using End log in Create log.</p> <ul style="list-style-type: none"> To delete a log, select it and press the  button. 	 64
Synchronize	<p>Signals from the GPS satellites are used to set the date and time of the camera's internal clock (only when Record GPS data in GPS options of the GPS options menu is set to On).</p>	 64
Electronic compass	<p>Compass display: When set to On, the direction the camera is pointing is displayed on the shooting screen. When the monitor faces upward, the compass indicator switches to a circle compass with a red arrow that points north. The default setting is Off.</p> <p>Compass correction: Corrects the compass when the compass direction is not displayed correctly. Swing the camera to draw a figure eight in the air while turning your wrist to face the camera forward and backward, side to side, or up and down.</p> 	 65

Using the Wi-Fi (Wireless LAN) Feature (COOLPIX S9500 only)

Functions that Can Be Performed Using Wi-Fi

You can perform the following functions if you install the dedicated software "Wireless Mobile Utility" on your smart device that runs on Android OS or iOS, and connect it to the camera.

Take Photos

You can display the shooting screen of the camera on your smart device and operate the camera by remote control.*

The pictures shot by remote control can be copied to your smart device.

* Operations other than turning on and off the camera cannot be performed during remote control operation.

View Photos

You can copy the pictures saved in the camera's memory card to your smart device.

Installing the Software on the Smart Device

- 1** Use your smart device to connect to Google Play Store, App Store or other online apps marketplace and search for "Wireless Mobile Utility."
 - Check the user's manual provided with your smart device for further details.
- 2** Check the description and other information and install the software.
 - For more information about how to operate the software, download the user's manual from the website below.
 - Android OS : <http://nikonimglib.com/ManDL/WMAU/>
 - iOS : <http://nikonimglib.com/ManDL/WMAU-ios/>

Connecting the Smart Device to the Camera

Press the **MENU** button → **Y** (setup) menu icon (📖7) → Wi-Fi options → Wi-Fi network

- 1 Press the multi selector to select the **Wi-Fi network** and press the **OK** button.



- 2 Select **On** and press the **OK** button.



- SSID and the password are displayed.
- When **Auth./encryp.** is set to **Open** (default setting), the password is not displayed.
- If no connection confirmation is received from the smart device within 3 minutes, the setting returns to **Off**.

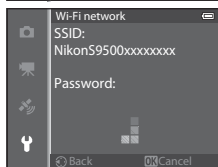

- 3 Set the Wi-Fi setting on the smart device to **On**.

- Check the user's manual provided with your smart device for further details.
- After the network name (SSID) that can be used for the smart device is displayed, select the SSID displayed on the camera.
- When the message for entering a password (📖95) is displayed, enter the password that is displayed on the camera.
- When the camera is successfully connected to a Wi-Fi network, the shooting screen is displayed with the Wi-Fi icon (📖8).



- 4 Start the dedicated software installed on the smart device.

- The screen for selecting "Take photos" or "View photos" is displayed.
- When the message "Cannot connect to camera." is displayed, retry the **Wi-Fi network** setting.

To Terminate the Wi-Fi Connection

- Turn off the camera.
- Set the Wi-Fi setting on the smart device to Off.

Notes on Wi-Fi Connection

- Set the **Wi-Fi network** to **Off** in a place where the use of radio waves is prohibited.
- When a memory card is not inserted in the camera, the Wi-Fi feature cannot be used. When Eye-Fi card (E-F85) is inserted in the camera, the Wi-Fi feature cannot be used.
- When Wi-Fi is connected, **Auto off** is disabled.
- When the **Wi-Fi network** is set to **On**, the battery will drain faster than normal.
- The **Wi-Fi network** cannot be selected when the battery level indicator in the monitor indicates . In addition, if the battery level indicator indicates  while a Wi-Fi connection is established, the connection is terminated.

Note on Security Settings

If the camera is installed with the Wi-Fi feature without proper security settings (encryption and password), unauthorized third parties may access the network and cause harm. We strongly recommend performing the required security settings before using the Wi-Fi feature.

Use **Wi-Fi options** of the setup menu (96) to perform the security settings.









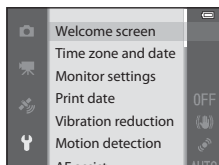

General Camera Setup















The Setup Menu

Press the **MENU** button →  (setup) menu icon ()











From the menu screen, select the  menu icon to display the setup menu, and then you can change the following settings.



Option	Description	
Welcome screen	Set whether or not the welcome screen is displayed when power is turned on. The welcome screen image can be selected. The default setting is None .	 67
Time zone and date	Set settings related to the camera's date and time. The Time zone setting allows you to specify the time zone where the camera is mainly used and whether or not daylight saving time is in effect. When the  travel destination is set, the camera automatically calculates the time difference between the travel destination and the  home time zone, and saves images using the date and time of the travel destination.	 68
Monitor settings	Set the image display after shooting and the screen brightness. In Photo info , select the kind of information that is displayed on the monitor during shooting mode and playback mode. If you select Framing grid+auto info , a framing grid is displayed when shooting to help you frame the picture.	 70
Print date	Imprint the shooting date and time on pictures at the time of shooting. The default setting is Off . Dates cannot be imprinted in the following situations. <ul style="list-style-type: none">• When  (Night landscape) (using Hand-held),  (Night portrait) (using Hand-held),  (Backlighting) (with HDR set to On), Sports, Museum, Easy panorama, Pet portrait (using Continuous) or 3D photography is selected in scene mode.• When Continuous H, Continuous L, Pre-shooting cache, Continuous H: 120 fps, Continuous H: 60 fps or BSS is selected for Continuous shooting mode (62).• During movie recording	 72

Option	Description	
Vibration reduction	Reduce blurring caused by camera shake when shooting. The default setting is On . <ul style="list-style-type: none"> When using a tripod to stabilize the camera, set this feature to Off to prevent this feature from malfunctioning. 	 73
Motion detection	When the camera detects camera shake or subject movement at the time of shooting, it automatically increases ISO sensitivity and shutter speed to reduce blurring. The default setting is Auto . The  indicator lights in green when the camera detects camera shake or subject movement and increases shutter speed. <ul style="list-style-type: none"> When using certain shooting modes or settings, motion is not detected. In this case the  indicator is not displayed. 	 74
AF assist	When set to Auto (default setting), the AF-assist illuminator ( 26) lights if shooting in dark surroundings to help the camera focus. <ul style="list-style-type: none"> Even if Auto is selected, the AF-assist illuminator may not light depending on the position of the focus area or the scene mode that is selected. 	 75
Digital zoom	When set to On (default setting), rotating the zoom control toward T () triggers the digital zoom ( 25) if the optical zoom is at the maximum telephoto zoom position. When set to Crop , the digital zoom is limited to the range (to the zoom position ) at which image quality of the shot still picture does not deteriorate. <ul style="list-style-type: none"> The digital zoom cannot be used simultaneously depending on settings in the shooting mode and other modes. 	 76
Sound settings	Turn various camera sounds on and off. In the default setting, beep sounds are on. <ul style="list-style-type: none"> The operation sound is disabled depending on settings in the shooting mode and other modes. 	 77
Auto off	Set the amount of time that passes before the monitor is turned off to save power. The default setting is 1 min .	 77
Format memory/ Format card	Format the internal memory (only when a memory card is not inserted) or the memory card (when a memory card is inserted). <ul style="list-style-type: none"> All data stored in the internal memory or on the memory card is deleted during formatting and cannot be restored. Be sure to transfer important images to a computer and save them before formatting. 	 78
Language	Change the camera's display language.	 78

The Setup Menu

Option	Description	
TV settings	Adjust settings for connection to television. <ul style="list-style-type: none"> When the camera is connected to a television using an audio/video cable but no picture is displayed on the television, set Video mode to NTSC or PAL according to the type of signal compatible with the television. HDMI settings can be set. 	 79
Charge by computer	When set to Auto (default setting), you can charge the camera's battery by connecting the camera to a computer (provided that the computer is able to supply power). <ul style="list-style-type: none"> When charging by computer, it may take more time to charge the battery than when using the Charging AC Adapter EH-70P. 	 80
Blink warning	When the camera detects that a human subject may have closed the eyes immediately after taking a picture using face detection while shooting with modes other than the smart portrait ( 67), the Did someone blink? screen is displayed on the monitor to check the picture taken. The default setting is Off .	 82
Wi-Fi options (COOLPIX S9500 only)	To connect the camera to your smart device, set the Wi-Fi network (wireless LAN) to on. You can also change network information such as the camera's SSID and password.	 83
Eye-Fi upload	Set whether or not to enable the function for sending images to a computer using a commercially available Eye-Fi card. The default setting is Enable .	 85
Filmstrip	When On is selected, thumbnails of previous and subsequent images are displayed at the bottom of the monitor when you rotate the multi selector quickly while viewing an image in full-frame playback mode ( 28). The default setting is Off .	 86
Reset all	Reset the camera's settings to their default values. <ul style="list-style-type: none"> Some of the settings such as Time zone and date and Language are not reset. 	 87
Firmware version	Display the current camera firmware version.	 90









Reference Section

The Reference Section provides detailed information and hints for using the camera.

Shooting

Using Easy Panorama (Shooting and Playing back)  02







Playback

Favorite Pictures Mode.....  05
Auto Sort Mode  08
List by Date Mode  10
Playing Images in a Sequence  11
Editing Still Images  13
Connecting the Camera to a TV (Viewing Images on a TV).....  20
Connecting the Camera to a Printer (Direct Print)  22



Movies

Editing Movies  27

Menu

The Shooting Menu ( Auto Mode)  29
The Smart Portrait Menu.....  43
Movie Menu.....  45
The Playback Menu.....  51
GPS Options Menu (COOLPIX S9500 only).....  59
The Setup Menu.....  67

Additional Information

Error Messages  91
File and Folder Names  97
Optional Accessories.....  99

Using Easy Panorama (Shooting and Playing back)

Taking Pictures with Easy Panorama

Rotate the mode dial to SCENE → MENU button → Easy panorama

1 Select the shooting range from **STD Normal (180°)** or **WIDE Wide (360°)**, and press the **OK** button.

- The image sizes (W × H) when the camera is held in landscape orientation are as follows.
 - **STD Normal (180°)**:
4800 × 920 when the camera is moved horizontally,
1536 × 4800 when the camera is moved vertically
 - **WIDE Wide (360°)**:
9600 × 920 when the camera is moved horizontally,
1536 × 9600 when the camera is moved vertically
- For the image sizes when the camera is held in "tall" orientation, the combinations of the moving direction and W × H are the opposites of the above.

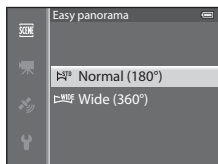

2 Frame the first portion of the panorama scene, and press the shutter-release button halfway to adjust the focus.

- The zoom is fixed at the wide-angle position.
- The framing guide is displayed on the monitor.
- The camera focuses on the subject at the center of the frame.
- Exposure compensation (Fn58) can be adjusted.
- If the focus or exposure cannot be set for the main subject, try the focus lock (Fn68).

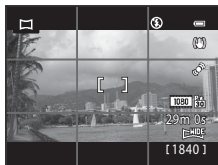

3 Press the shutter-release button all the way, and release it.

- The **▷** icons showing the panorama direction are displayed.



4 Move the camera straight and slowly in one of the four directions to start shooting.

- When the camera detects the panorama direction, the shooting starts.
- The guide showing the current shooting point is displayed.
- When the guide showing the shooting point reaches the end, the shooting ends.



Guide

Example of Moving the Camera

- The user, without shifting position, moves the camera, from end to end of the guide, horizontally or vertically in an arc.
- If about 15 seconds (in **STD Normal (180°)**) or 30 seconds (in **WIDE Wide (360°)**) pass from the start of the shooting, and before the guide showing the shooting point reaches the end, the shooting ends.



✓ Notes on Easy Panorama Shooting

- The image area seen in the saved image will be narrower than that seen on the monitor at the time of shooting.
- When the camera movement speed is too fast, there is a large amount of camera shake or there is little change in subject such as wall or in the dark, the shooting ends in an error.
- Panorama pictures are not saved when the shooting stops before reaching half of the panorama range.
- When the shooting reaches more than half of the panorama range but finishes before the end point, the range that is not shot will be recorded as a gray area.

Viewing Easy Panorama (Scroll)

Switch to playback mode (📖28), display the picture recorded with Easy panorama in full-frame playback mode and press the **OK** button. The camera displays the short side of the picture filling the entire screen and scrolls the displayed area automatically.

- **STD** or **WIDE** is displayed for pictures recorded with Easy panorama.
- The picture is scrolled in the direction of the panorama shooting.
- Rotate the multi selector to advance or rewind.

Playback controls are displayed at the top of the monitor during playback. When you choose a playback control with the multi selector ◀ or ▶ and press the **OK** button, the following operations can be performed.

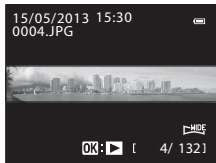

To	Use	Description	
Rewind	◀	Scroll quickly back while the OK button is pressed.*	
Advance	▶	Scroll quickly forward while the OK button is pressed.*	
Pause	⏸	The following operations can be performed with the playback controls at the top of the monitor while playback is paused.	
		◀	Rewind while the OK button is pressed.*
		▶	Scroll while the OK button is pressed.*
End	■	Restart the automatic scroll.	
End	■	Return to full-frame playback mode.	

* These operations can also be performed by rotating the multi selector.

✔ Note on Viewing Pictures Recorded with Easy Panorama

Panorama pictures recorded with functions other than Easy panorama of the COOLPIX S9500/S9400 may not be scrolled or zoomed on this camera.

Favorite Pictures Mode

You can sort your images (except movies) into nine albums and add them as favorite pictures (added images are not copied or moved).

After you add images to albums, you can choose to play back only the added images by using favorite pictures mode.





- It is easier to find the images when they are added to separate albums in accordance with events or type of subjects.
- The same image can be added to multiple albums.
- The maximum number of images that can be added to an album is 200.

Adding Images to Albums

Press the  button (Playback mode*) → MENU button →  or  or  menu icon (71) → Favorite pictures

* Images cannot be added in favorite pictures playback mode.

1 Press the multi selector or , and then choose an image and press to display .

- To add more images to the same album, repeat this step as necessary.
- To cancel the selection, press  to remove .
- When the zoom control () is rotated toward **T** () , the display is switched to full-frame playback mode. When the zoom control is rotated toward **W** () , the display is switched to thumbnails display mode.



2 Display for all images to be added to an album and press the button.

3 Use the multi selector to choose the album to which the images will be added and press the button.



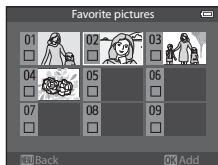

- The selected images are added and the camera switches to the playback menu.
- To add the same image to multiple albums, select **Favorite pictures** and repeat from step 1.



Playing Back Images in Albums

Press the  button (Playback mode) → MENU button → MODE menu icon (71) →  Favorite pictures

Use the multi selector to select an album and press the  button to play back only images added to the same album.

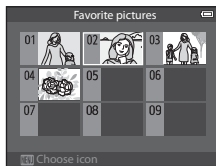

- The following operations can be performed on the album list screen.
 -  (delete) button: Delete all images in the currently selected album.
 - MENU button: Change album icon (color and design) (7).
- When viewing images in full-frame playback mode or thumbnail playback mode, if you press the MENU button to display the menu and then select the  menu icon (favorite pictures menu), you can then select a feature from the playback menu (73).









Note on Deletion

If an image is deleted while using favorite pictures mode, the image will not only be removed from the album, but the corresponding image file will also be permanently deleted from the internal memory or the memory card.

Removing Images From Albums



Select favorite pictures mode → Select an album from which images are removed (6) →  button → MENU button → Remove from favorites

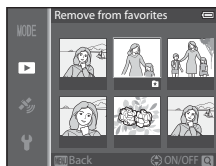

- Press the multi selector  or , choose an image to be removed and then press  to remove .
 - To remove more images from the same album, repeat this step as necessary.
 - Rotate the zoom control (25) toward **T** () to switch back to full-frame playback mode, or toward **W** () to display thumbnails.







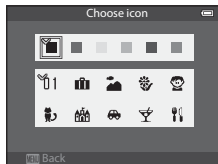

- Choose **Yes** and press the  button.

Changing the Favorites Album Icon

Press the  button (Playback mode) → MENU button → **MODE** menu icon (📖71) →  Favorite pictures → Choose the desired album → MENU button

- 1 Press the multi selector  or  to choose an icon color and press the  button.



- 2 Press , ,  or  to choose an icon and press the  button.
 - The icon changes and the monitor display returns to the list of albums screen.

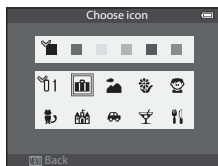

Notes on Album Icons

Set the album icons separately for the internal memory and for the memory card.



- To change the album icons for the internal memory, first remove the memory card from the camera.
- The default setting for the icon is the number icon (black).

Auto Sort Mode

Captured images are automatically sorted into categories, such as portraits, landscape, and movie.







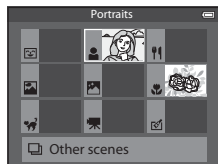









Press the  button (Playback mode) → **MENU** button → **MODE** menu icon () →  Auto sort

Use the multi selector to select a category and then press the  button to play back images in the selected category.

- The following operation can be performed while the category selection screen is displayed.
 -  (delete) button: Delete all images in the selected category.
- When viewing images in full-frame playback mode or thumbnail playback mode, if you press the **MENU** button to display the menu and then select the  menu icon (auto sort mode menu), you can then select a feature from the playback menu ()73).



Auto Sort Mode Categories

Option	Description
 Smile	Images captured in  Smart portrait mode (📖45) with the smile timer setting set to On .
 Portraits	Images captured in  (auto) mode (📖31) with the face detection (📖67) Images captured in the following scene modes (📖33): <ul style="list-style-type: none"> •  (Night portrait)* •  (Backlighting)* • Portrait* or Party/indoor Images captured in  Smart portrait mode (📖45) with the smile timer setting set to Off
 Food	Images captured in Food scene mode (📖33)
 Landscape	Images captured in Landscape* scene mode (📖33)
 Dusk to dawn	Images captured in the following scene modes (📖33): <ul style="list-style-type: none"> •  (Night landscape) * • Sunset, Dusk/dawn or Fireworks show
 Close-ups	Images captured in  (auto) mode with macro mode (📖54) Images captured in Close-up* scene mode (📖33)
 Pet portrait	Images captured in Pet portrait scene mode (📖33)
 Movie	Movies (📖82)
 Retouched copies	Copies created using the editing function (📖13)
 Other scenes	All other images that cannot be defined by the categories described above

* Images captured in  (Scene auto selector) mode (📖34) are also sorted to the appropriate categories.







Notes on Auto Sort Mode

- Up to 999 images and movie files can be sorted to each category in auto sort mode. If 999 images or movies have already been sorted to a specific category, new images and movies cannot be sorted to that category nor can they be displayed in auto sort mode. You can play back images and movies that could not be sorted to a category by using normal playback mode (📖28) or list by date mode (📖10).
- Images or movies copied from the internal memory or a memory card cannot be displayed in auto sort mode.
- Images or movies saved by a camera other than the COOLPIX S9500/S9400 cannot be played back in auto sort mode.

List by Date Mode

Press the  button (Playback mode) → MENU button → MODE menu icon () →  List by date

Use the multi selector to select a date and then press the  button to play back images captured on the selected date.

- The first picture taken on the selected date is displayed.
- The following operations can be performed while the shooting date list screen is displayed.
 - **MENU** button: If you select the  menu icon (list by date menu) from the menu screen to display the playback menu ()73), you can select one of the following features and apply that feature to the images captured on the selected date.
 - Print order, Slide show, or Protect
 -  (delete) button: Delete all images captured on the selected date.
- When viewing images in full-frame playback mode or thumbnail playback mode, if you press the **MENU** button to display the menu and then select the  menu icon (list by date menu), you can then select a feature from the playback menu ()73).
- Calendar display mode ()70) cannot be used in list by date mode.

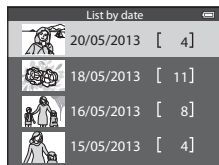

Notes on List by Date Mode

- Up to 29 dates can be selected. If images exist for more than 29 dates, all images saved earlier than most recent 29 dates will be combined under **Others**.
- The 9,000 most recent images can be displayed in list by date mode.
- Pictures taken when the camera's date is not set are treated as images captured on January 1, 2013.

Playing Images in a Sequence

The images shot in the following continuous shooting mode are saved as a group (called a “sequence”) each time you shoot.

- **Continuous H, Continuous L, Pre-shooting cache, Continuous H: 120 fps** or **Continuous H: 60 fps** in **Continuous** (📷34) in the shooting menu
- **Sports** (📖38) or **Continuous** in the **Pet portrait** (📖42) scene mode

In full-frame playback mode or thumbnail playback mode (📖70), the first image of a sequence is used as the “key picture,” i.e., it is displayed to represent the images in the sequence.

Sequence display



While the key picture of a sequence is displayed in full-frame playback mode, press the **OK** button to display each image in the sequence individually. To return to key picture only display, press the multi selector **▲**.

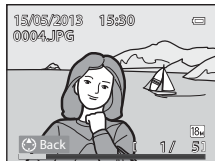

The following operations can be performed when each image in a sequence is displayed individually.

- Select an image: Rotate the multi selector or press **◀** or **▶**.
- Zoom in: Rotate the zoom control toward **T** (📷) (📖69).

✓ Notes on Sequence

- Pictures captured continuously with cameras other than the COOLPIX S9500/S9400 cannot be displayed as a sequence.
- When only one image is shot in continuous shooting mode, it cannot be displayed as a sequence.

📌 Sequence Display Options

Select **Sequence display options** (📷58) in the playback menu to set all sequences to be displayed using their key pictures or to display them as individual images.

If an image in the sequence is selected when **Sequence display options** is set to **Individual pictures**, 📷 icon is displayed on the monitor.

📌 Changing Key Picture in Sequence

A sequence's key picture can be changed using **Choose key picture** (📷58) in the playback menu.

Deleting Images in a Sequence

When **Sequence display options** (👁️58) is set to **Key picture only** in the playback menu, if the 🗑️ button is pressed and the deletion method is selected, the following images are deleted.

- When a sequence is displayed by its key picture only:
 - **Current image:** When the sequence is selected, all images in the sequence are deleted.
 - **Erase selected images:** When the key picture is selected in the erase selected images screen (📖30), all images in the sequence are deleted.
 - **All images:** All images including the sequence that is displayed are deleted.
- If the key picture is selected and the Ⓞ button is pressed to display individual images in the sequence before pressing the 🗑️ button:

The deletion methods change to the followings.

 - **Current image:** Delete the image that is displayed.
 - **Erase selected images:** Select multiple images in the sequence to delete in the erase selected images screen (📖30).
 - **Entire sequence:** All images in the sequence, including the image that is displayed, are deleted.

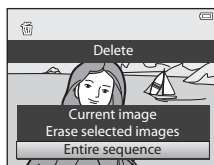

Playback Menu Options Available When Using Sequence

When the **MENU** button is pressed during an image sequence playback, the following menu operations are available.

- | | | | |
|--------------------------------|--------|----------------------------------|--------|
| • Quick retouch ¹ | → 👁️16 | • Small picture ¹ | → 👁️18 |
| • D-Lighting ¹ | → 👁️16 | • Voice memo ¹ | → 👁️56 |
| • Glamour retouch ¹ | → 👁️17 | • Copy ² | → 👁️57 |
| • Print order ² | → 👁️51 | • Sequence display options | → 👁️58 |
| • Slide show | → 👁️54 | • Choose key picture | → 👁️58 |
| • Protect ² | → 👁️55 | • Favorite pictures ² | → 👁️5 |
| • Rotate image ¹ | → 👁️55 | | |

¹ Press the **MENU** button after displaying individual images. Settings can be applied to individual images.

² When the **MENU** button is pressed during displaying only the key picture, the same settings can be applied to all images in that sequence. Press the **MENU** button after displaying individual images to apply settings to individual images.

Editing Still Images

Editing Features

Images can be easily edited with this camera using the functions below. Edited images are stored as separate files (📷97).

Editing function	Application
Quick effects (📷15)	Apply a variety of effects to images.
Quick retouch (📷16)	Easily create a copy with enhanced contrast and richer colors.
D-Lighting (📷16)	Create a copy of the current picture with enhanced brightness and contrast, brightening dark portions of the picture.
Glamour retouch (📷17)	Make facial skin tones softer and make faces look smaller with larger eyes.
Small picture (📷18)	Create a small copy of pictures suitable for uses such as e-mail attachments.
Crop (📷19)	Crop a portion of the picture. Use to zoom in on a subject or arrange a composition.



Original Pictures and Edited Copies

- Copies created with editing functions are not deleted if the original pictures are deleted. The original pictures are not deleted if copies created with editing functions are deleted.
- Edited copies are stored with the same shooting date and time as the original.
- Even if the pictures that are marked for **Print order** (📷51) or **Protect** (📷55) are used for editing, these settings are not reflected on the edited copies.

More Information

See "File and Folder Names" (📷97) for more information.

Notes on Image Editing

- The following pictures cannot be edited.
 - Pictures taken using **Easy panorama** or **3D photography**
 - Pictures taken with cameras other than the COOLPIX S9500/S9400
- When no faces are detected in the picture, glamour retouch function cannot be applied.
- If a copy created using the COOLPIX S9500/S9400 is viewed on a different digital camera, it may not be possible to display the picture properly or transfer it to a computer.
- Editing functions are not available when there is not enough free space in the internal memory or on the memory card.
- For a sequence displayed using the key picture only setting (11), perform one of the following operations before editing.
 - Press the  button to display individual images, and then select an image in the sequence.
 - Set **Sequence display options** (58) to **Individual pictures** so that each image is displayed individually, and then select an image.

Restrictions on Image Editing

The following restrictions apply when editing pictures that were created by editing.

Editing functions used	Editing functions to add
Quick effects Quick retouch D-Lighting	Glamour retouch, Small picture or Crop can be used.
Glamour retouch	Quick effects, Quick retouch, D-Lighting, Small picture or Crop can be used.
Small picture Crop	No additional editing functions can be used.

- Copies created by editing cannot be edited again using the same editing function.
- To use an editing function together with small picture or crop function, use the other editing function first, and use small picture or crop function as the last editing function performed on that picture.
- Retouch effects such as the glamour retouch function's skin softening effect can be applied to pictures taken with the skin softening function during shooting.

Quick effects: Applying effects to pictures

Effects selected from the following 23 types can be applied to an image with the **OK**:  mark while this image is displayed in full-frame playback mode. The effect results can be previewed on the screen shown in step 2.

Effect	Description
Painting, High key, Toy camera effect and Low key	Mainly adjusts hue and creates a different look for the image.
Soft, Fisheye, Cross screen, and Miniature effect	Processes images with a variety of effects.
High-contrast monochrome, Sepia, Cyanotype, and Selective color (12 colors)	Turns multicolor images into single color images. Selective color transforms all colors, except a specified color, to black and white.

- 1 Display the image to which you want to apply an effect in full-frame playback mode and press the **OK** button.

- The effect selection screen is displayed.

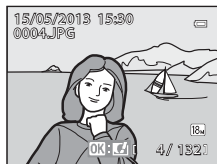

- 2 Press the multi selector **◀** or **▶** to select effect and press the **OK** button.

- Rotate the zoom control toward **T** (telephoto zoom position) to display a confirmation screen for the applied effect. Rotate the zoom control toward **W** (wide-angle position) to return to the selection screen for effects.

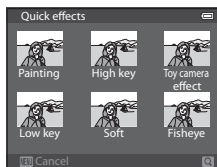

- 3 Choose **Yes** and press the **OK** button.

- Copies created with the quick effects function are stored as separate files and recognized by the  icon displayed in playback mode (10).

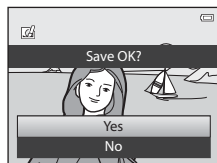

Quick Retouch: Enhancing Contrast and Saturation

Select a picture (📖28) → MENU button (📖6) → Quick retouch

Press the multi selector ▲ or ▼ to choose the setting level, and press the **OK** button.

- The original version is displayed on the left and the edited version is displayed on the right.
- To cancel, press ◀.
- Quick retouched copies are stored as separate files and recognized by the 📷 icon displayed in playback mode (📖10).

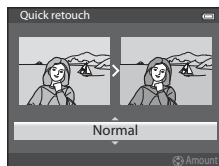

D-Lighting: Enhancing Brightness and Contrast

Select a picture (📖28) → MENU button (📖6) → D-Lighting

Press the multi selector ▲ or ▼ to choose **OK**, and press the **OK** button.

- The original version is displayed on the left and the edited version is displayed on the right.
- D-Lighting copies are stored as separate files and recognized by the 📷 icon displayed in playback mode (📖10).

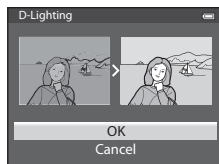

Glamour Retouch: Making Facial Skin Tones Softer, Face Smaller, or Eyes Larger

Select a picture (📖28) → MENU button (📖6) → Glamour retouch

- 1** If an image contains more than one face detected by the camera, select the face to be edited by pressing the multi selector ▲, ▼, ◀ or ▶ and press the **OK** button.

- To cancel, press the **MENU** button.
- When only one face is detected, proceed to step 2.
- You can edit only one face.

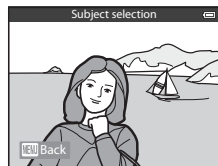

- 2** Press ◀ or ▶ to select the item to be adjusted and press ▲ or ▼ to set the extent of the effect to be applied.

- **Skin softening:** Make facial skin tones softer.
- **Small face:** Apply the effect to make faces look smaller.
- **Big eyes:** Apply the effect to make eyes look larger.
- **Brighten faces:** Make facial skin brighter.
- **Hide eye bags:** Reduce dark circles under the eyes.
- **Whiten eyes:** Make the whites of the eyes brighter.
- **Whiten teeth:** Make teeth whiter.
- **Redden cheeks:** Add blush colors to the cheeks. There are four cheek colors to select from.
- Press the **OK** button to set the effects to be applied.
- A confirmation screen is displayed, and the image is displayed zoomed in on the edited face.





- 3** Confirm the results and press the **OK** button.

- To change the effect type of glamour retouch, press ◀ and return to step 2.



4 Choose **Yes** and press the **OK** button.

- Copies created with the glamour retouch function are stored as separate files and recognized by the  icon displayed in playback mode (10).

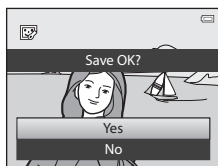

Notes on Glamour Retouch

- Depending on conditions such as the direction the subject is facing or the brightness of the face, the face may not be detected properly, or the desired effect may not be achieved.
- If no faces are detected in the image, a warning is displayed and the screen returns to the playback menu.

Small Picture: Reducing the Size of an Image



Select a picture ()28) → MENU button ()6) → Small picture

1 Press the multi selector or to choose the desired copy size and press the **OK** button.

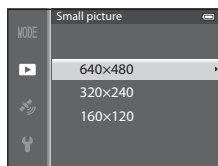
- The image size that can be selected varies depending on the aspect ratio of pictures ()29) (image mode) to be edited.
 - Pictures with 4:3 aspect ratio: **640×480**, **320×240** or **160×120**
 - Pictures with 16:9 aspect ratio: **640×360**



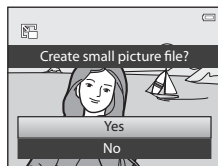

2 Choose **Yes** and press the **OK** button.

- The created copies are stored as separate files (compression ratio of about 1:16).
- Images created using small picture are displayed as small images in playback mode and  is displayed ()10).









Crop: Creating a Cropped Copy

Create a copy containing only the portion visible on the monitor screen when **MENU**:  is displayed with playback zoom (69) enabled.

1 Enlarge the picture for cropping (69).

2 Refine copy composition.



- Rotate the zoom control toward **T** () or **W** () to adjust the zoom ratio.
- Press the multi selector , ,  or  to scroll the picture until only the portion you want to copy is visible on the monitor.

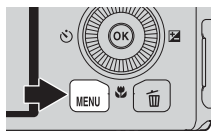

3 Press the **MENU** button.



4 Use the multi selector to choose **Yes** and press the **OK** button.

- Cropped copies are stored as separate files and recognized by the  icon displayed in playback mode (10).

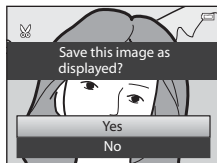



Image Size

The narrower the cropping range, the smaller the size (amount of pixels) of the cropped picture copy. When the image size setting for a cropped copy is 320 × 240 or 160 × 120, a small image is displayed in playback mode.

Cropping the Picture in its Current “Tall” Orientation

Use the **Rotate image** option (55) to rotate the picture so that it is displayed in landscape orientation. After cropping the picture, rotate the cropped picture back to “tall” orientation. The picture displayed in “tall” orientation can be cropped by zooming in on the picture until the black bars displayed on the both sides of the monitor disappear. The cropped picture is displayed in landscape orientation.

Connecting the Camera to a TV (Viewing Images on a TV)

Connect the camera to a television to play back pictures on the television. If your television is equipped with an HDMI connector, you can connect it to the camera with a commercially available HDMI cable to play back pictures.

1 Turn off the camera.

2 Connect the camera to the TV.

When connecting using the included audio/video cable

- Connect the yellow plug to the video-in jack on the TV, and the red and white plugs to the audio-in jacks.

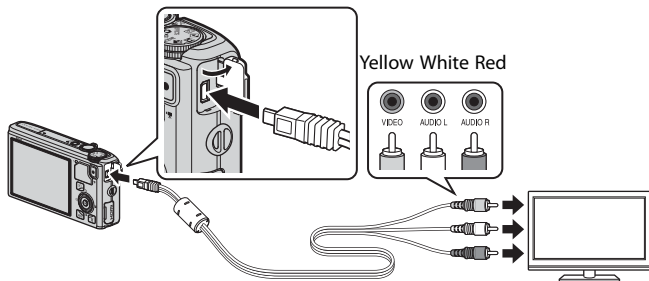

When connecting using a commercially available HDMI cable

- Connect the plug to the HDMI input connector on the TV.

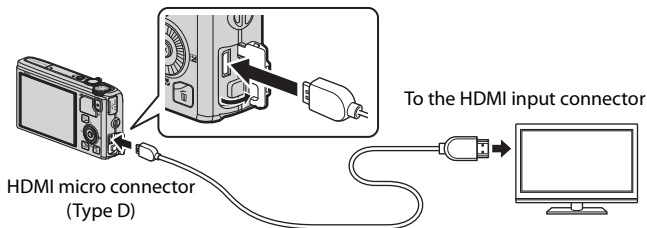

3 Tune the television to the video channel.

- See the instruction manual provided with your TV for details.

4 Hold down the button to turn on the camera.

- The camera enters playback mode, and the recorded pictures are displayed on the TV.
- While the camera is connected to the TV, the monitor remains off.



Note on Connecting an HDMI Cable

An HDMI cable is not included. Use a commercially available HDMI cable to connect the camera to a TV. The output terminal on this camera is an HDMI micro connector (Type D). When purchasing an HDMI cable, be sure that the device end of the cable is an HDMI micro connector.

Note on Connecting the Cable

When connecting the cable, be sure that the plug is oriented correctly. Do not force the plug into the camera. When disconnecting the cable, do not pull the plug at an angle.

When Nothing Appears on the TV

Make sure that **TV settings** (79) in the setup menu is appropriate for your television.

Using the TV's Remote Control (HDMI Device Control)

The remote control of a TV that conforms to the HDMI-CEC standard can be used to operate the camera during playback.

Instead of the multi selector or zoom control, the remote control can be used for picture selection, playback/pause of movies, switching between full-frame playback and 4-picture thumbnail display, etc.

- Set **HDMI device control** (79) of **TV settings** to **On** (default setting) in the setup menu, and connect the camera to the TV with an HDMI cable.
- Point the remote control at the TV to operate.
- See your TV's instruction manual or other related documentation to check whether your TV conforms to the HDMI-CEC standard.

HDMI and HDMI-CEC

"HDMI" is an abbreviation of High-Definition Multimedia Interface, which is one type of multimedia interface.

"HDMI-CEC" is an abbreviation of HDMI-Consumer Electronics Control, which enables operations to be linked between compatible devices.

Connecting the Camera to a Printer (Direct Print)

Users of PictBridge-compatible (🔌23) printers can connect the camera directly to the printer and print pictures without using a computer.

Connecting the Camera to a Printer

- 1 Turn off the camera.
- 2 Turn on the printer.
 - Check the printer settings.
- 3 Connect the camera to the printer using the included USB cable.
 - Be sure that the plug is oriented correctly. When disconnecting the cable, do not pull the plug at an angle.

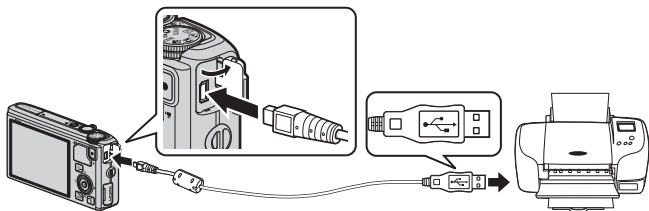

- 4 The camera is automatically turned on.
 - When connected correctly, the **PictBridge** startup screen (①) is displayed on the monitor screen of the camera. Then the **Print selection** screen (②) is displayed.

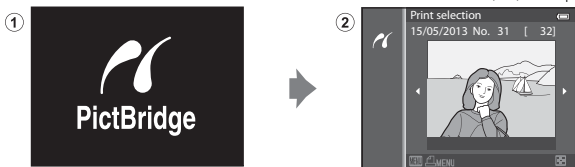

✔ If the PictBridge Startup Screen Is Not Displayed

Turn the camera off and disconnect the USB cable. Set the **Charge by computer** option (🔌80) in the camera's setup menu to **Off** and reconnect the cable.

✔ Notes on Power Source

- When connecting the camera to a printer, use a fully charged battery to prevent the camera from turning off unexpectedly.
- If the AC Adapter EH-62F (available separately) (🔌99) is used, the COOLPIX S9500/S9400 can be powered from an electrical outlet. Do not, under any circumstances, use an AC adapter other than the EH-62F. Failure to observe this precaution could result in overheating or damage to the camera.

Printing Individual Images

After connecting the camera to the printer correctly (📷22), print pictures by following the procedure below.

1 Use the multi selector to choose the picture to be printed, and press the **OK** button.

- Rotate the zoom control toward **W** (📷) to display 6 thumbnails, or toward **T** (📷) to switch back to full-frame playback mode.



2 Set the number of copies and paper size.

- Choose **Copies** and press the **OK** button to set the number of copies (up to 9).
- Choose **Paper size** and press the **OK** button to set the paper size (📷26).
To prioritize the printer settings, select **Default**.

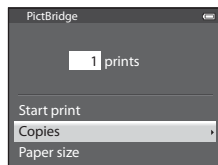

3 Choose **Start print** and press the **OK** button.

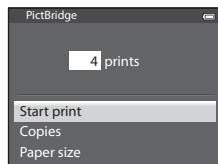

4 Printing starts.

- The monitor display returns to that shown in step 1 when printing is complete.
- When printing is complete, turn the camera off and then disconnect the USB cable.

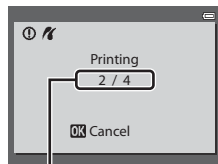

Current print/total number of prints

Printing Multiple Images

After connecting the camera to the printer correctly (📷22), print pictures by following the procedure below.

- 1 When the **Print selection** screen is displayed, press the **MENU** button.

- To exit the print menu, press the **MENU** button.

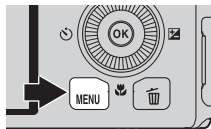

- 2 Choose **Print selection**, **Print all images** or **DPOF printing** and press the **OK** button.

- Choose **Paper size** and press the **OK** button to set the paper size (📄26).
To prioritize the printer settings, select **Default**.

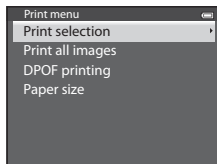

Print selection

Choose the pictures (up to a maximum of 99) and number of copies (up to 9 per picture).

- Press the multi selector ◀ or ▶ to choose the pictures, and press ▲ or ▼ to set the number of copies for each.
- Pictures selected for printing can be recognized by the 📄 icon and the numeral indicating the number of copies to be printed.
If the numeral is set to 0, the print selection is cancelled.
- Rotate the zoom control toward **T** (📷) to switch to full-frame playback mode, or **W** (📄) to switch to 6-thumb nail display.
- Press the **OK** button when setting is complete.
- When the menu shown on the right is displayed, choose **Start print** and press the **OK** button to start printing.

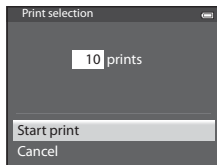

Print all images

All pictures stored in the internal memory or on the memory card are printed one per each.

- When the menu shown on the right is displayed, choose **Start print** and press the **OK** button to start printing.

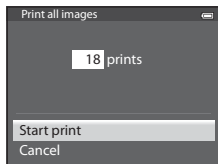

DPOF printing

Pictures for which a print order was created in **Print order** option (P51) can be printed.

- When the menu shown on the right is displayed, choose **Start print** and press the **OK** button to start printing.

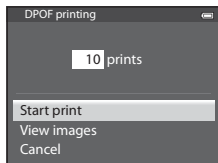

- To view the current print order, choose **View images** and press the **OK** button. To print pictures, press the **OK** button again.



3 Printing starts.

- The monitor display returns to that shown in step 2 when printing is complete.

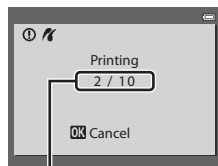

Current print/total number of prints

Connecting the Camera to a Printer (Direct Print)

Paper Size

The camera supports the following paper sizes: **Default** (the default paper size for the current printer), **3.5×5 in.**, **5×7 in.**, **100×150 mm**, **4×6 in.**, **8×10 in.**, **Letter**, **A3**, and **A4**. Only sizes supported by the current printer are displayed.

Printing Pictures

In addition to printing pictures transferred to a computer and printing pictures with a direct camera-to-printer connection, the following options are also available for printing pictures recorded on the memory card:

- Insert a memory card into a DPOF-compatible printer's card slot.
- Take a memory card to a digital photo lab.





For printing using these methods, specify the pictures and the number of prints each using the **Print order** (51) option in the playback menu.

Editing Movies

Extracting Only the Desired Portions of the Movie



The desired portions of a recorded movie can be saved as a separate file (except for movies recorded with  **iFrame 540/30p**).





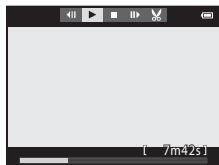

1 Play back the movie to be edited and pause at the start point of the portion that is to be extracted (87).

2 Use the multi selector  or  to choose  on the playback control, and press the  button.



- The movie editing screen is displayed.





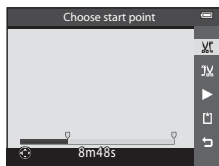

3 Press  or  to choose  (Choose start point) on the editing playback control.





- Rotate the multi selector or press  or  to adjust the start position.
- To cancel, press  or  to choose  (back) and press the  button.

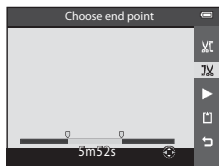

4 Press  or  to choose  (Choose end point).

- Press  or  to move the end point at the right end to the end position of the required section.
- To check the playback of the movie in the specified range before saving it, choose  (Preview) and press the  button. During preview playback, the volume can be adjusted with the zoom control **T/W**. Use the multi selector to fast forward or rewind. To stop the preview playback, press the  button again.



5 After finishing the settings, press  or  to choose  (Save) and press the  button.

6 Choose **Yes** and press the  button.

- The edited movie is saved.

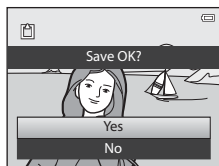

Notes on Editing Movies

- Use a fully charged battery to prevent the camera from turning off during editing. When the battery level is , movie editing is not possible.
- Once a movie is created through editing, it cannot be used again for extracting a movie. To extract another range, select and edit the original movie.
- Because the edited movies are extracted in one-second units, they may vary slightly from the set start point and end point. Sections shorter than two seconds cannot be extracted.
- Editing functions are not available when there is not enough free space in the internal memory or on the memory card.

More Information

See “File and Folder Names” ( 97) for more information.

The Shooting Menu (📷 (Auto) Mode)

Image Mode (Image Size and Quality)

Display the shooting screen → MENU button → 📷 menu icon (📖6) → Image mode

Select the combination of image size and image quality (compression ratio) that is used when saving images.

The higher the image mode setting, the larger the size with which it can be printed, and the lower the compression ratio, the higher the image quality that is achieved, but the number of images that can be saved (🔑30) is reduced.

Option ¹	Compression ratio (approx.)	Aspect ratio (horizontal : vertical)	Print size ² (cm/in.) (approx.)
18_M* 4896×3672★	1:4	4:3	41 × 31/16 × 12
18_M 4896×3672 (default setting)	1:8	4:3	41 × 31/16 × 12
8_M 3264×2448	1:8	4:3	28 × 21/11 × 8
4_M 2272×1704	1:8	4:3	19 × 14/7.5 × 5.6
2_M 1600×1200	1:8	4:3	13 × 10/5.3 × 4
VGA 640×480	1:8	4:3	5 × 4/2 × 1.5
13_M 4864×2736	1:8	16:9	41 × 23/16 × 9

¹ The total number of pixels captured and the number of pixels captured horizontally and vertically.

Example: **18_M** 4896×3672 = Approx. 18 megapixels, 4896 × 3672 pixels

² Print size at an output resolution of 300 dpi.

Print sizes are calculated by dividing the number of pixels by printer resolution (dpi) and multiplying by 2.54 cm (1 in.). However, at the same image size, images printed at higher resolutions will print smaller than the size indicated, and those printed at lower resolutions will print larger than the size indicated.

The icon for the current setting is displayed on the monitor in shooting and playback modes (📖8, 10).

Image Mode Setting

- The setting is also applied to other shooting modes.
- When **Easy panorama** (📖41) or **3D photography** (📖43) in scene mode is selected, the image mode cannot be selected.
- Some features cannot be used in combination with other menu settings. See “Features Not Available in Combination” (📖64) for more information.

Number of Exposures Remaining

The following table lists the approximate number of images that can be saved on a 4 GB memory card.

Note that due to JPEG compression, there is a significant difference in the number of images that can be actually saved depending on the composition of the image, even when the memory cards have the same capacity and the image mode is the same.

In addition, the number of images that can be saved may differ depending on the make of the memory card.

Image mode	Number of exposures remaining (4 GB)
18M* 4896×3672 ★	430
18M 4896×3672	860
8M 3264×2448	1910
4M 2272×1704	3770
2M 1600×1200	7100
VGA 640×480	24,100
18:9 13M 4864×2736	1160

- If the number of exposures remaining is 10,000 or more, “9999” is displayed.
- After removing the memory card, check the indicator showing the number of exposures that can be stored in the internal memory (COOLPIX S9500: approximately 23 MB, COOLPIX S9400: approximately 65 MB) on the screen during shooting.

White Balance (Adjusting Hue)

Display the shooting screen in 📷 (Auto) mode (📖31) → MENU button → 📷 menu icon (📖6) → White balance

The color of light reflected from an object varies with the color of the light source. The human brain is able to adapt to changes in the color of the light source, with the result that white objects appear white whether seen in the shade, direct sunlight, or under incandescent lighting. Digital cameras can mimic this adjustment of the human eye by processing images according to the color of the light source. This is known as “white balance.”

Although the default setting, **Auto**, can be used under most types of lighting, you can apply the white balance setting suited to a particular light source to achieve more accurate results.

Option	Description
AUTO Auto (default setting)	White balance is automatically adjusted to suit lighting conditions. Best choice in most situations.
PRE Preset manual	Useful when shooting under unusual lighting. See “Using Preset Manual” for more information (🔧32).
☀ Daylight	White balance adjusted for direct sunlight.
💡 Incandescent	Use under incandescent lighting.
⚡ Fluorescent	Use under fluorescent lighting.
☁ Cloudy	Use when taking pictures under overcast skies.
⚡ Flash	Use with the flash.

The icon for the current setting other than **Auto** is displayed on the monitor (📖8).

📌 Notes on White Balance

- At white-balance settings other than **Auto** or **Flash**, set the flash mode to 📷 (off) (📖50).
- Some features cannot be used in combination with other menu settings. See “Features Not Available in Combination” (📖64) for more information.

Using Preset Manual

Use when you want to make pictures taken under unusual lighting conditions (e.g., lamps with reddish-light) look as though they were shot in normal light.

Use the procedure below to measure the white balance value under the lighting used during shooting.

1 Place a white or gray reference object under the lighting that will be used during shooting.

2 Display the shooting menu (📖61), use the multi selector to set **White balance to PRE Preset manual**, then press the **OK** button.

- The lens extends to the zoom position for measurement.

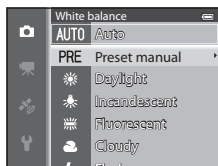

3 Choose **Measure**.

- To apply the most recently measured white balance value, select **Cancel** and press the **OK** button. The most recently measured white balance value will be set without re-measuring the value.

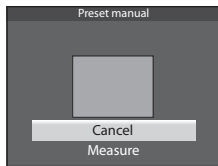

4 Frame a white or gray reference object in the reference object frame and press the **OK** button.

- The shutter is released and the new white balance preset value is set (no picture is recorded).

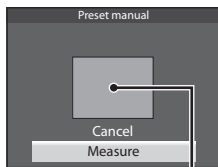

Reference object frame

✔ Note on Preset Manual



The camera cannot measure a white balance value for when the flash fires. When shooting with the flash, set **White balance to Auto or Flash**.

Metering

Display the shooting screen in 📷 (Auto) mode (📖31) → MENU button → 📷 menu icon (📖6) → Metering

The process of measuring the brightness of the subject to determine the exposure is known as “metering.”

Use this option to choose how the camera meters exposure.

Option	Description
 Matrix (default setting)	The camera uses a wide area of the screen for metering. This metering mode provides the appropriate exposure for a variety of shooting conditions. Recommended for typical shooting.
 Center-weighted	The camera meters the entire frame but assigns greatest weight to the subject at the center of the frame. The classic metering for portraits; it preserves background details while letting lighting conditions at the center of the frame determine exposure. Can be used with focus lock (📖68) to meter off-center subjects.

✔ Notes on Metering

- When the digital zoom is in effect, **Metering** is set to **Center-weighted** or spot metering (where the center of the frame is metered) depending on the magnification of an enlargement.
- Some features cannot be used in combination with other menu settings. See “Features Not Available in Combination” (📖64) for more information.







📌 Metering Area



When **Center-weighted** is selected for **Metering**, the metering range guide (📖8) is displayed (except when digital zoom is used).

Continuous Shooting

Display the shooting screen in 📷 (Auto) mode (📖31) → MENU button → 📷 menu icon (📖6) → Continuous

Change the settings for continuous shooting and BSS (Best Shot Selector).

Option	Description
 Single (default setting)	One picture is shot each time the shutter-release button is pressed.
 Continuous H	<p>Pictures are continuously shot while the shutter-release button is pressed all the way. Shooting ends when the shutter-release button is released or when the maximum number of continuous shooting frames is reached.</p> <ul style="list-style-type: none"> • Continuous H: Up to 5 pictures are continuously shot at a rate of about 7.5 frames per second. • Continuous L: About 31 pictures are continuously shot at a rate of about 1.9 frames per second (when the image mode is 18M 4896x3672).
 Continuous L	
 Pre-shooting cache	<p>Pre-shooting cache makes it easy to capture perfect moments, by saving images from before the shutter-release button was pressed all the way. Pre-shooting cache shooting begins when the shutter-release button is pressed halfway, and shooting continues while the shutter-release button is pressed all the way (📷36).</p> <ul style="list-style-type: none"> • Frame rate: up to 12 frames per second • Number of frames: up to 25 frames (including up to 5 frames captured in the pre-shooting cache) <p>Shooting ends when the shutter-release button is released or when the maximum number of frames has been shot. The image mode is fixed at 2M (1600 × 1200 pixels.)</p>
 Continuous H: 120 fps	<p>Each time the shutter-release button is pressed all the way, pictures are continuously shot using a high shutter speed.</p> <ul style="list-style-type: none"> • Continuous H: 120 fps: 50 frames are captured at a speed of about 1/120 seconds or faster. The image mode is fixed at VGA (640 × 480 pixels.) • Continuous H: 60 fps: 25 frames are captured at a speed of about 1/60 seconds or faster. The image mode is fixed at 1M (1280 × 960 pixels.)
 Continuous H: 60 fps	
BSS BSS (Best Shot Selector)	<p>BSS is recommended for shooting under low lighting without the flash, with the camera zoomed in, or in other situations in which camera shake is likely to blur pictures. Keep pressing the shutter-release button all the way, and up to 10 pictures are shot and the camera automatically selects and saves only the sharpest picture in the series.</p>

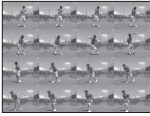
Option	Description
 Multi-shot 16	Each time the shutter-release button is pressed all the way, the camera shoots 16 pictures at a rate of about 30 frames per second and arranges them in a single picture. <ul style="list-style-type: none"> • The image mode is fixed at  (2560 × 1920 pixels). • The digital zoom is not available. 

The icon for the current setting other than **Single** is displayed on the monitor (📖8).

✔ Notes on Continuous Shooting

- Focus, exposure and white balance are fixed at the values determined with the first shot in each series.
- The frame rate may become slower depending on the image quality, image size, memory card type or shooting conditions.
- The frame rate may become slower when **ISO sensitivity** (🔍37) in the shooting menu is set to **1600** or **3200**.
- Some features cannot be used in combination with other menu settings. See “Features Not Available in Combination” (📖64) for more information.

✔ Notes on Continuous H

- It may take some time to save the images after shooting. The amount of time it takes to finish saving the captured images depends on the number of images, the write speed of the memory card, etc.
- When ISO sensitivity increases, noise may appear in captured images.
- Banding or variance in brightness or hue may occur in images that were captured under lighting that flashes quickly at high speeds, such as fluorescent, mercury-vapor, or sodium-vapor lighting.

✔ Note on BSS

BSS is suited for shooting stationary subjects. **BSS** may not produce the desired results if the subject moves or the composition changes.

✔ Note on Multi-shot 16

Banding or variance in brightness or hue may occur in images that were captured under lighting that flashes quickly at high speeds, such as fluorescent, mercury-vapor, or sodium-vapor lighting.

📎 Using Continuous shooting mode in combination with the self-timer

If you use **Continuous** shooting mode in combination with the self-timer (📖53) with an **2s** (2 seconds) setting, pictures can be shot continuously by reducing camera shake.

To use the self-timer (📖53) when **Continuous H**, **Continuous L** or **BSS** is selected for the **Continuous** setting, keep pressing the shutter-release button all the way. When you release the shutter-release button, **Single** is automatically selected and the camera captures only one picture at a time.

Pre-shooting Cache

When **Pre-shooting cache** is selected, shooting begins when the shutter-release button is pressed halfway for 0.5 seconds or longer, and images captured before the shutter-release button is pressed all the way are saved along with images captured after the shutter-release button is pressed all the way. Up to 5 images can be saved in the pre-shooting cache.

The current pre-shooting cache setting is indicated by an icon when shooting (📷8). The pre-shooting cache icon lights in green while the shutter-release button is pressed halfway.

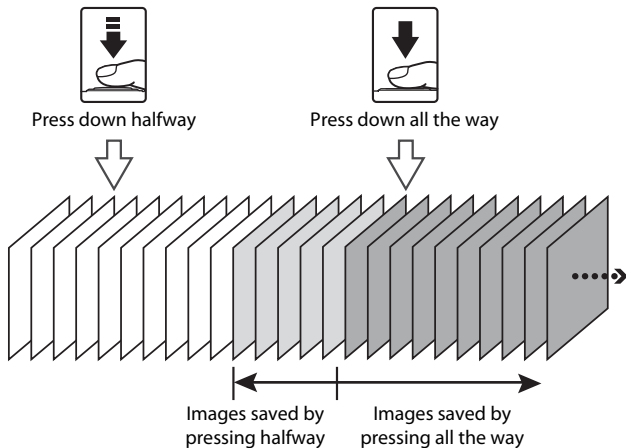

- If the number of exposures remaining is less than 5, the pictures taken with the pre-shooting cache are not recorded. Before shooting, check that there are 5 or more exposures remaining.

ISO Sensitivity

Display the shooting screen in 📷 (Auto) mode (📖31) → MENU button → 📷 menu icon (📖6) → ISO sensitivity

The higher the ISO sensitivity, the less light needed for taking pictures.

The higher the ISO sensitivity, the darker the subject that can be shot. Additionally, even with subjects of similar brightness, pictures can be taken at faster shutter speeds, and blurring caused by camera shake and subject movement can be reduced.

- Setting the ISO sensitivity to a high level is effective when shooting dark subjects, not using the flash, shooting at the telephoto zoom position and similar situations, but the pictures taken may be slightly grainy.

Option	Description
Auto (default setting)	The sensitivity is ISO 125 in bright places; in dark places the camera automatically raises the sensitivity to a maximum of ISO 1600.
Fixed range auto	Choose the range in which the camera automatically adjusts ISO sensitivity from ISO 125-400 (default setting) and ISO 125-800 . The camera does not raise sensitivity beyond the maximum value in the selected range. Set the maximum value for ISO sensitivity to control "grain" that appears in images.
125, 200, 400, 800, 1600, 3200	ISO sensitivity is locked at the specified value.

The icon for the current setting is displayed on the monitor during shooting (📖8).

- When **Auto** is selected, the **ISO** icon is not displayed at ISO 125, but is displayed if the ISO sensitivity automatically increases to higher than ISO 125.
- When **Fixed range auto** is selected, the **ISO** icon and the maximum ISO sensitivity value are displayed.



✔ Note on ISO Sensitivity

Some features cannot be used in combination with other menu settings. See "Features Not Available in Combination" (📖64) for more information.

AF Area Mode

Display the shooting screen in 📷 (Auto) mode (📖31) → MENU button → 📷 menu icon (📖6) → AF area mode

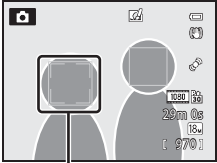
You can set how the focus area is determined for autofocus.

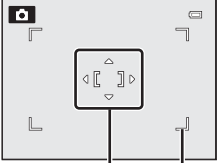
Option	Description
 Face priority	<p>The camera automatically detects and focuses on a face (see “Using Face Detection” (📖67) for more information). If the camera detects multiple faces, the camera focuses on the face closest to the camera. When non-human subjects are photographed, or a subject with which no face can be detected is framed, the camera automatically selects the focus areas (up to 9) that contain the subject closest to the camera. When the shutter-release button is pressed halfway, the focus area selected by the camera is displayed on the monitor (multiple areas may light up).</p>  <p style="text-align: center;">Focus area</p>
 Manual	<p>Choose manually the focus position from 99 areas in the screen. This option is suited to situations in which the intended subject is relatively still and not positioned at the center of the frame. Rotate the multi selector or press ▲, ▼, ◀ or ▶ to move the focus area to where the subject is, and take a picture.</p> <ul style="list-style-type: none"> To adjust the following settings, press the OK button to temporarily cancel focus area selection, and then adjust each setting. <ul style="list-style-type: none"> Flash mode, macro mode, self-timer or exposure compensation <p>To return to the focus area selection screen, press the OK button again.</p>  <p style="text-align: center;">Focus area Selectable areas</p>

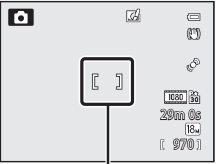
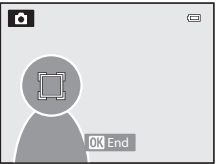
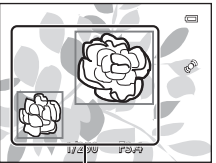
Option	Description	
[▪] Center	<p>The camera focuses at the center of the frame.</p> <p>The focus area is always displayed at the center of the frame.</p>	 <p style="text-align: center;">Focus area</p>
👤 Subject tracking	<p>Subject tracking begins once you select a subject to be focused on, and the focus area will move and follow the subject. See “Using Subject Tracking” (📖40).</p>	
[🔍] Target finding AF	<p>When the camera detects the main subject, it focuses on that subject. See “Using the Target Finding AF” (📖66) for more information.</p>	 <p style="text-align: center;">Focus areas</p>

✔ Notes on AF Area Mode

- When the digital zoom is in effect, the camera focuses on the subject at the center of the frame regardless of the applied **AF area mode** option.
- In some rare cases of shooting subjects for which autofocus does not perform as expected (📖68), the subject may not be in focus.
- Some features cannot be used in combination with other menu settings. See “Features Not Available in Combination” (📖64) for more information.
- If the camera does not focus on the desired subject when using a feature that selects and focuses on the subject, such as Target finding AF, set **AF area mode** to **Manual** or **Center** and align the focus area with the desired subject. You can also try using focus lock (📖68).

Using Subject Tracking

Display the shooting screen in 📷 (Auto) mode (📖31) → MENU button → 📷 menu icon (📖6) → AF area mode

Choose this mode to shoot moving subjects. Subject tracking begins once you select a subject to be focused on, and the focus area will move and follow the subject.

1 Rotate the multi selector to select Subject tracking, and press the button.

- Press the MENU button after changing the settings and return to the shooting screen.

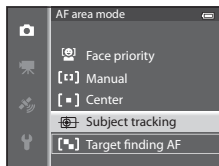

2 Frame the subject at the center of the border, and press the button.

- The subject is registered.
- When the camera is unable to focus on the subject, the border lights in red. Change the composition and try again.
- Once the subject is registered, it is framed by a yellow focus area display, and subject tracking begins.
- Press the  button to cancel the registration of the subject.
- If the camera loses sight of the subject, the focus area display disappears; register the subject again.

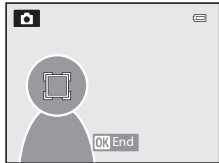

3 Press the shutter-release button all the way to take the picture.

- If the camera focuses on the focus area when the shutter-release button is pressed halfway, the focus area display lights in green and the focus is locked.
- If the shutter-release button is pressed halfway while the focus area is not displayed, the camera focuses on the subject at the center of the frame.

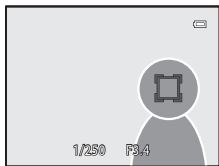

✔ Notes on Subject Tracking

- The digital zoom is not available.
- Set the zoom position, flash mode, or menu settings before registering a subject. If any of these are changed after a subject is registered, the subject will be canceled.
- During certain conditions, such as when the subject is moving quickly, when there is a large amount of camera shake, or when there are multiple subjects that look alike, the camera may not be able to register or track a subject, or the camera may track a different subject. Additionally, the subject may not be tracked properly depending on factors such as the subject's size and brightness.
- When the camera enters standby mode (📖19), the registration of the subject is canceled. To prevent this, setting a longer time for the auto off function (🔌77) is recommended.
- Some features cannot be used in combination with other menu settings. See "Features Not Available in Combination" (📖64) for more information.

Autofocus Mode

Display the shooting screen in 📷 (Auto) mode (📖31) → MENU button → 📷 menu icon (📖6) → Autofocus mode

Choose how the camera focuses.

Option	Description
AF-S Single AF (default setting)	The camera focuses only when the shutter-release button is pressed halfway.
AF-F Full-time AF	The camera focuses continuously until the shutter-release button is pressed halfway. Use with moving subjects. A sound will be heard while the camera focuses.

✔ Note on Autofocus Mode

Some features cannot be used in combination with other menu settings. See "Features Not Available in Combination" (📖64) for more information.

📌 Autofocus Mode for Movie Recording

Autofocus mode for movie recording can be set with **Autofocus mode** (🔌49) in the movie menu.

Quick Effects

Display the shooting screen in 📷 (Auto) mode (📖31) → MENU button → 📷 menu icon (📖6) → Quick effects

Enable or disable the quick effects function.

Option	Description
<input checked="" type="checkbox"/> On (default setting)	When in 📷 (auto) mode, you can apply effects to images immediately after releasing the shutter. <ul style="list-style-type: none">• See “Using Quick Effects” (📖32) for more information.
OFF Off	Disables the quick effects function (during shooting).

Note on Quick Effects

Some features cannot be used in combination with other menu settings. See “Features Not Available in Combination” (📖64) for more information.

The Smart Portrait Menu

Image Mode (Image Size and Quality)

See “Image Mode (Image Size and Quality)” (📷29) for more information on **Image mode**.

Skin Softening

Display the shooting screen in smart portrait mode (📖45) → MENU button → 😊 menu icon (📖6) → Skin softening

Enable skin softening.

Option	Description
⬆️⬆️ High	When the shutter is released, the camera detects one or more human faces (up to 3), and processes the image to make facial skin tones softer before saving the image. The degree of skin softening applied can be selected.
⬆️ Normal (default setting)	
⬆️ Low	
OFF Off	Disables skin softening.

When skin softening is enabled, the icon for the current setting is displayed on the monitor during shooting (📖8). When **Off** is selected, an icon for the current setting is not displayed. The effects of skin softening are not visible when framing pictures for shooting. Check the degree of skin softening performed in playback mode.

Smile Timer

Display the shooting screen in smart portrait mode (📖45) → MENU button → 😊 menu icon (📖6) → Smile timer

The camera detects human faces and then automatically releases the shutter whenever a smile is detected.



Option	Description
😊 On (single) (default setting)	When the camera detects a human face with smile, it automatically takes a single picture.
😊📷 On (continuous)	When the camera detects a human face with smile, it automatically takes 5 pictures continuously at a rate of 3 frames per second.
😊BSS On (BSS)	When the camera detects a human face with smile, it automatically takes pictures using BSS (Best Shot Selector) (📷34).
OFF Off	Disables smile timer.

When smile timer is enabled, the icon for the current setting is displayed on the monitor during shooting (📖8). When **Off** is selected, an icon for the current setting is not displayed.

Blink Proof

Display the shooting screen in smart portrait mode (📖45) → MENU button → 📷 menu icon (📖6) → Blink proof



The camera automatically releases the shutter twice each time a picture is taken. Of the two shots, one in which the subject's eyes are open is saved.

Option	Description
 On	Enables blink proof. Flash cannot be used when On is selected. If the camera saved an image in which the subject's eyes may have been closed, the dialog shown on the right is displayed for a few seconds. 
OFF Off (default setting)	Disables blink proof.

When blink proof is enabled, the icon for the current setting is displayed on the monitor during shooting (📖8). When **Off** is selected, an icon for the current setting is not displayed.

Movie Menu

Movie Options





Display the shooting screen → MENU button →  (Movie) menu icon () → Movie options

You can select the type of movie to record.

The camera can record normal speed movies, and HS (high speed) movies ()46, which can be played back in slow motion or fast motion.

The larger the image size and bitrate, the higher the image quality; however, the file size also becomes larger.

Normal Speed Movies

Option	Image size (pixels) Aspect ratio (horizontal : vertical)	Movie bitrate
 1080★/30p (default setting)	1920 × 1080 16:9	15 Mbps
 1080/30p	1920 × 1080 16:9	12 Mbps
 720/30p	1280 × 720 16:9	9 Mbps
 iFrame 540/30p*	960 × 540 16:9	24 Mbps
 480/30p	640 × 480 4:3	6 Mbps

- The frame rate is approximately 30 fps for all options.

* iFrame is one of the formats supported by Apple Inc. The movie editing functions ()27 cannot be used. When using the camera's internal memory for recording, the movie recording may end abruptly for some image compositions. Using a memory card (Class 6 or higher) is recommended when taking important movies.





Note on Bitrate

The movie bitrate is the volume of movie data recorded per second. As a variable bitrate (VBR) system has been adopted, the movie bitrate varies automatically according to the subject so that more data is recorded per second for movies containing frequently moving subjects, thus increasing movie file size.

HS Movie

When recorded movies are played back, the camera plays back the movies in slow motion or fast motion.

See “Recording Movies in Slow Motion and Fast Motion (HS Movie)” (📷47) for more information.

Option	Image size (pixels) Aspect ratio (horizontal : vertical)	Description
 HS 240/8×	320 × 240 4:3	Movies are recorded at 8× speed faster than normal speed and played back at 1/8-speed slow motion. <ul style="list-style-type: none"> • Max. movie length*: 10 s (playback time: 1 min 20 s)
 HS 480/4×	640 × 480 4:3	Movies are recorded at 4× speed faster than normal speed and played back at 1/4-speed slow motion. <ul style="list-style-type: none"> • Max. movie length*: 15 s (playback time: 1 min)
 HS 720/2×	1280 × 720 16:9	Movies are recorded at 2× speed faster than normal speed and played back at 1/2-speed slow motion. <ul style="list-style-type: none"> • Max. movie length*: 30 s (playback time: 1 min)
 HS 1080/0.5×	1920 × 1080 16:9	Movies are recorded at 0.5× speed of normal speed and played back at 2× speed fast motion. <ul style="list-style-type: none"> • Max. movie length*: 2 min (playback time: 1 min)





* While recording movies, the camera can be switched between normal speed movie recording and slow motion or fast motion movie recording. The maximum movie length in the table indicates the movie recording time of the slow motion or fast motion playback portion only.

Maximum Movie Length

The following table lists the approximate maximum movie length that can be saved on a 4 GB memory card.

Note that the maximum movie length and file size that can be actually saved can be different depending on the image composition and subject motion even when the memory cards have the same capacity and movie options setting are the same.

Also, the maximum movie length that can be saved may differ depending on the make of the memory card.

Movie options (🔑45)	Maximum movie length* (4 GB)
 1080★/30p	30 min
 1080/30p	40 min
 720/30p	55 min
 iFrame 540/30p	20 min
 480/30p	2 h 45 min

* The maximum movie recording time (maximum movie length for a single movie) is 4 GB or 29 minutes, even when there is sufficient free space on the memory card. The maximum movie length for a single movie is displayed on the screen during movie recording. If the camera becomes hot, a movie recording in progress may be terminated even if there is more time available for recording.

- After removing the memory card, check the indicator showing maximum movie length that can be stored in the internal memory (COOLPIX S9500: approximately 23 MB, COOLPIX S9400: approximately 65 MB) on the screen during recording.

More Information

See "File and Folder Names" (🔑97) for more information.

Recording Movies in Slow Motion and Fast Motion (HS Movie)

When **Movie options** in the movie menu is set to HS movie (🔑46), HS (high speed) movies can be recorded. Movies recorded using HS movie can be played back in slow motion at 1/8 to 1/2 of normal playback speed, or played back in fast motion at a speed two times faster than normal speed.

- 1 Press the  (🔑 movie-record) button to start recording.

- Movie recording starts in HS mode when **Open with HS footage** in the movie menu is set to **On**.

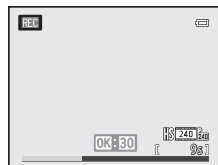

Movie Menu

- Movie recording starts at normal speed when **Open with HS footage** in the movie menu is set to **Off**. Press the **OK** button at the point where the camera should record for slow motion or fast motion playback in order to switch to HS movie recording.

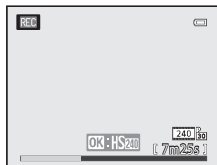

- When an HS movie reaches the maximum length for HS movies (0:46), or when the **OK** button is pressed, the camera switches to normal speed movie recording. The camera switches between normal speed movie recording and HS movie recording each time the **OK** button is pressed.
- When recording HS movies, the maximum movie length display changes and displays the remaining movie length for HS movie recording.
- The movie options icon changes when switching between HS movie recording and normal speed movie recording.

2 Press the **●** (movie-record) button to end recording.

When a movie is recorded at **480p HS 480/4x**:

Movies are recorded at a speed with a four times higher frame rate than normal speed (maximum movie length: 15 seconds).

Movies are played back in slow motion that takes four times longer than normal speed.

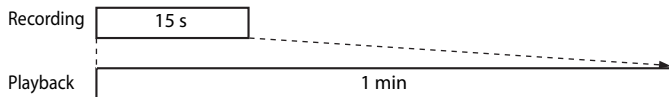

When a movie is recorded at **1080p HS 1080/0.5x**:

Movies are recorded at half (0.5x) the frame rate of normal speed (maximum movie length: 2 minutes).

Movies are played back in fast motion at a speed two times faster than normal speed.

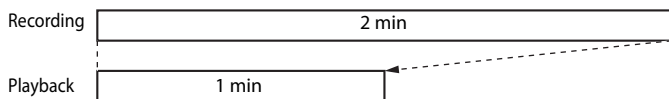

✓ Notes on HS Movie

- The sound is not recorded.
- Zoom position, focus, exposure and white balance are locked when movie recording starts.



Open with HS Footage

Display the shooting screen → MENU button →  (Movie) menu icon (6) → Open with HS footage

Select whether or not to record slow motion or fast motion movies from the start of the recording when HS movies are recorded.

Option	Description
On (default setting)	HS movies are recorded when recording begins.
Off	Normal speed movies are recorded when recording begins. Press the  button to switch to HS movie recording at the point where the camera should record for slow motion or fast motion playback.

Autofocus Mode

Display the shooting screen → MENU button →  (Movie) menu icon (6) → Autofocus mode

Select how the camera focuses when recording normal speed movies (45).

Option	Description
AF-S Single AF (default setting)	Lock on the focus when the ● () button is pressed to start recording. Select this option when the distance between the camera and the subject remains fairly consistent.
AF-F Full-time AF	The camera focuses continuously during movie recording. Suitable for recording when the distance between the camera and subject changes. The operation sound when the camera focuses may be recorded. Setting to Single AF is recommended if the sound is noticeable.

- When an HS movie option is selected in **Movie options**, the setting is fixed at **Single AF**.

Wind Noise Reduction

Display the shooting screen → MENU button →  (Movie) menu icon (📖6) → Wind noise reduction

Option	Description
 On	Record movies with the reduced wind noise from the microphone. This setting is suitable for recording in strong winds. During playback, not only wind noise, but other sounds may also become difficult to hear.
OFF Off (default setting)	Wind noise is not reduced.



When **On** is selected, an icon for this setting is displayed on the monitor (📖8).

- When an HS movie option is selected in **Movie options**, the setting is fixed at **Off**.

The Playback Menu

For more information about image editing functions; (**Quick retouch**, **D-Lighting**, **Glamour retouch** and **Small picture**), see “Editing Still Images” (🔗13).

Print Order (Creating a DPOF Print Order)

Press the  button (Playback mode) → MENU button (6) → Print order

If you choose to use one of the following methods to print pictures that are stored on a memory card, the pictures to print and the number of copies can be set in advance on the memory card.







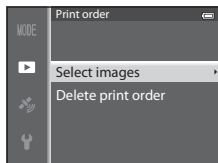

- Printing with a DPOF-compatible (🔗23) printer that is equipped with a card slot.
- Ordering the prints to a digital photo lab that has a DPOF service.
- Printing by connecting the camera to a PictBridge-compatible (🔗23) printer (🔗22). (When the memory card is removed from the camera, the print order can also be performed for the pictures stored on the internal memory.)

1 Use the multi selector to choose **Select images**, and press the button.

- When favorite pictures mode, auto sort mode or list by date mode is selected, the menu shown on the right is not displayed. Proceed to step 2.





2 Choose the pictures (up to a maximum of 99) and number of copies (up to 9 per picture).

- Rotate the multi selector or press  or  to choose the pictures, and press  or  to set the number of copies for each.
- Pictures selected for printing can be recognized by the  icon and the numeral indicating the number of copies to be printed. If the numeral is set to 0, the print selection is cancelled.
- Rotate the zoom control toward **T** () to switch to full-frame playback mode, or **W** () to switch to 6-thumb display.
- Press the  button when setting is complete.



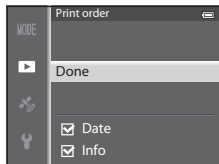

3 Choose whether or not to also print shooting date and shooting information.

- Choose **Date** and press the **OK** button to print the shooting date on all pictures in the print order.
- Choose **Info** and press the **OK** button to print shooting information (shutter speed and aperture value) on all pictures in the print order.
- Choose **Done** and press the **OK** button to complete the print order.
- Pictures with the print orders are recognized by the  icon displayed in playback mode (10).



Notes on Printing Shooting Date and Shooting Information

When the **Date** and **Info** options are enabled in the print order menu, shooting date and shooting information can be printed on pictures when a DPOF-compatible () 23 printer which supports printing of shooting date and shooting information is used.

- Shooting information cannot be printed when the camera is connected directly to a printer, via the included USB cable, for DPOF printing (25).
- **Date** and **Info** are reset each time the **Print order** menu is displayed.
- The date printed on the picture is the same as those set on the camera when the picture was taken. The date printed using this option is not affected if the camera's **Time zone and date** setting is changed from the setup menu after the pictures are taken.



✓ Notes on Print Order

When a print order is created in favorite pictures mode, auto sort mode, or list by date mode, the screen shown below is displayed if pictures other than those in the selected album, category, or shooting date have been marked for printing.

- Select **Yes** to add the print order setting to the existing print order.
- Select **No** to remove the existing print order and restrict the print order setting.

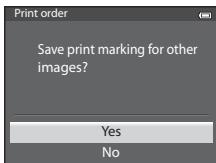

Favorite pictures mode
or auto sort mode

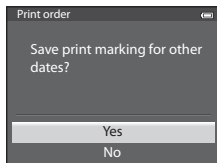

List by date mode

Additionally, if there are more than 99 pictures as a result of adding the current print order setting, the screen shown below will be displayed.

- Select **Yes** to remove the existing print order and restrict the print order setting.
- Select **Cancel** to retain the existing print order and remove the print order setting.

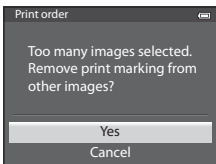

Favorite pictures mode
or auto sort mode

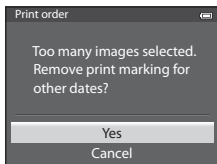

List by date mode



✂ Deleting All Print Orders

In step 1 of the print order procedure (0651), choose **Delete print order** and press the **OK** button to delete the print orders for all pictures.

✂ Print Date



The shooting date and time can be imprinted on pictures at the time of shooting by using **Print date** (0672) in the setup menu. This information can be printed even from printers that do not support printing of the date. Only the date of print date on the pictures are printed, even if **Print order** is enabled with the date selected in the print order screen.

Slide Show

Press the  button (Playback mode) → MENU button () → Slide show



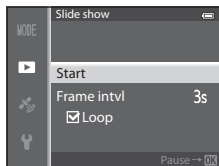

View pictures stored in the internal memory or on a memory card in an automatic slide show.

1 Use the multi selector to choose **Start**, and press the button.

- To change the interval between pictures, choose **Frame intvl**, and press the  button, and then select the desired interval time before choosing **Start**.
- To repeat the slide show automatically, enable **Loop** and press the  button before choosing **Start**. The check mark () is added to the loop option when enabled.





2 The slide show begins.

- Press the multi selector  to display the next picture, or  to display the previous picture. (Press and hold  to fast forward, or  to rewind.)
- To exit partway or pause, press the  button.





3 Choose End or Restart.



- After the last frame is played back or during playback pause, the screen shown on the right is displayed. Choose  and press the  button to return to step 1. Choose  to play the slide show again.



Notes on Slide Shows

- Only the first frame of movies () included in slide shows is displayed.
- For sequences () whose sequence display in options are set to **Key picture only**, only the key picture is displayed.
- Images captured using Easy panorama are displayed in full-frame when played back in a slide show. They do not scroll.
- Slide shows play for a maximum of about 30 minutes ()



Protect

Press the  button (Playback mode) → MENU button () → Protect



Protect selected pictures from accidental deletion.

In the image selection screen, choose a picture and set or cancel protection. See “Using the Screen for Selecting Images” () for more information.

Note, however, that formatting the camera’s internal memory or the memory card () permanently erases the protected files.



Protected pictures are recognized by the  icon in playback mode ()

Rotate Image

Press the  button (Playback mode) → MENU button () → Rotate image

Change the orientation of pictures played back on the camera’s monitor after shooting. Still pictures can be rotated 90° clockwise or counterclockwise.

Pictures that were recorded in the “tall” orientation can be rotated up to 180° in either direction.

Select a picture in the image selection screen () to display the rotate image screen. Rotate the multi-selector, or press  or  to rotate the picture 90°.

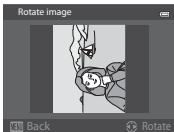

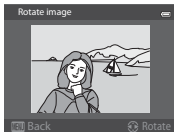

Rotated 90°
counterclockwise





Rotated 90°
clockwise

Press the  button to set the orientation displayed and save the orientation data with the picture.

Notes on Image Rotation

- Images captured using 3D photography cannot be rotated.
- While only the key picture of a sequence is displayed, images cannot be rotated. Apply the setting after displaying individual images (, )



Voice Memo

Press the  button (Playback mode) → Select a picture → MENU button ()
→ Voice memo

Use the camera's microphone to record voice memos for pictures.



- The recording screen is displayed for a picture without voice memo, while the voice memo playback screen is displayed for a picture with voice memo (a picture marked with  in full-frame playback mode).

Recording Voice Memos

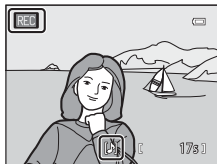
- Voice memo can be recorded for up to about 20 seconds while the  button is pressed.
- Do not touch the microphone during recording.
- During recording, **REC** and  flash on the monitor.
- When recording ends, the voice memo playback screen is displayed.







Playing Voice Memos

- Press the  button to play back a voice memo. To end playback, press the  button again.
- Rotate the zoom control toward **T** or **W** during playback to adjust playback volume.
- Press the multi selector  before or after playing a voice memo to return to the playback menu. Press the MENU button to exit the playback menu.



Deleting Voice Memos

Press the  button on the voice memo playback screen. Press the multi selector  or  to select **Yes** and press the  button to delete only the voice memo.

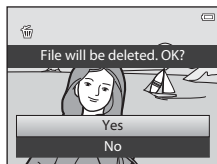



Notes on Voice Memos

- When a picture with a voice memo attached is deleted, both the picture and its voice memo are deleted.
- Voice memos cannot be recorded for a picture that already has a voice memo attached to it. The current voice memo must be deleted before a new voice memo can be recorded.
- Voice memos cannot be attached to pictures taken with cameras other than the COOLPIX S9500/S9400.
- Voice memos of the images with the **Protect** setting () cannot be deleted.

More Information

See "File and Folder Names" () for more information.

Copy (Copy Between Internal Memory and Memory Card)

Press the  button (Playback mode) → MENU button () → Copy



Copy pictures or movies between the internal memory and a memory card.

1 Use the multi selector to select an option from the copy screen, and press the button.

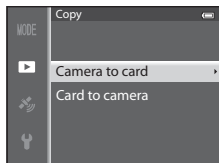
- **Camera to card:** Copy pictures from the internal memory to the memory card.
- **Card to camera:** Copy pictures from the memory card to the internal memory.







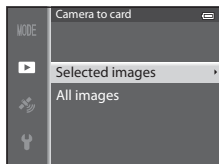



2 Select a copy option and press the button.

- **Selected images:** Copy pictures selected from the image selection screen ()76). If a sequence for which only a key picture is displayed is selected ()11), all pictures in the displayed sequence are copied.
- **All images:** Copy all pictures. If a picture in a sequence is selected, this option is not displayed.
- **Current sequence:** This option is displayed when a picture in a sequence has been selected before displaying the playback menu. All pictures in the current sequence are copied.



Notes on Copying Pictures

- JPEG-, MOV-, WAV-, and MPO-format files can be copied. Files recorded in any other format cannot be copied.
- **Voice memo** ()56) attached to pictures and **Protect** setting ()55) are also copied with the pictures.
- Pictures recorded with another make or model of camera or that have been modified on a computer cannot be copied.
- **Print order** settings ()51) and the contents of the album ()5) are not copied with the pictures.
- Pictures or movies copied from the internal memory or a memory card cannot be displayed in auto sort mode ()8).
- If **Sequence display options** ()58) is set to **Key picture only** and a picture in the sequence is selected and the  button is pressed to display individual pictures ()11), only **Card to camera** image copy is available.

Message: “Memory contains no images.”



If there are no pictures stored on the memory card when playback mode is selected, the message, **Memory contains no images.**, is displayed. Press the **MENU** button and select **Copy** from the playback menu to copy the pictures stored in the camera’s internal memory to the memory card.

More Information

See “File and Folder Names” (97) for more information.

Sequence Display Options



Press the  button (Playback mode) → **MENU** button (6) → Sequence display options



Choose the method used to display a series of pictures shot continuously (sequence, 11) when viewing them in full-frame playback mode (28) or in thumbnail playback mode (70).

Settings are applied to all sequences, and the setting is saved in the camera’s memory even if the camera is turned off.

Option	Description
Individual pictures	Each picture in a sequence is displayed.
Key picture only (default setting)	Return a sequence in which pictures are displayed individually to the key picture only display.

Choose Key Picture



Press the  button (Playback mode) → Select the desired sequence → **MENU** button (6) → Choose key picture



When **Sequence display options** is set to **Key picture only**, the key picture displayed in full-frame playback mode (28) or thumbnail playback mode (70) can be set for each sequence of pictures.

- When changing this setting, before pressing the **MENU** button, first select the desired sequence using full-frame playback mode or thumbnail playback mode.
- When the key picture selection screen is displayed, select a picture. See “Using the Screen for Selecting Images” (76) for more information.

GPS Options Menu (COOLPIX S9500 only)

GPS Options

Press the **MENU** button →  (GPS options) menu icon (6) → GPS options

Option	Description
Record GPS data	When set to On , signals are being received from the GPS satellites, and positioning starts ( 88). <ul style="list-style-type: none">• The default setting is Off.
Update A-GPS file	A memory card is used to update the A-GPS (assist GPS) file. Using the latest A-GPS file can shorten the time needed for tracking of the position information. See "Updating the A-GPS File" ( 60) for more information.
Erase GPS data	The position information and POI information recorded on pictures are erased. <ul style="list-style-type: none">• The deleted position information or POI information cannot be recovered.

Note on Erasing GPS Data

Pictures taken with cameras other than the COOLPIX S9500 cannot be edited.

Updating the A-GPS File

Download the latest A-GPS file from the website below, and use it to update the file.

<http://nikonimglib.com/agps/index.html>

- The A-GPS file for the COOLPIX S9500 is only available from the website above.
- To update the A-GPS file, set **Record GPS data** to **Off**. When **On** is selected, the A-GPS file cannot be updated.

-
- 1** Download the latest A-GPS file to the computer from the website.

 - 2** Use a card reader or other device to copy the downloaded file to the "NCFL" folder of the memory card.
 - The "NCFL" folder is located directly under the memory card root directory. If the memory card does not have "NCFL" folder, create a new folder.

 - 3** Insert the memory card containing the copied file into the camera.

 - 4** Turn on the camera.



 - 5** Press the **MENU** button to display the GPS options menu, and use the multi selector to select **GPS options**.

 - 6** Select **Update A-GPS file**, and update the file.
 - About 2 minutes are needed to update the A-GPS file.

Notes on Updating A-GPS File

- The A-GPS file is disabled when a position is determined for the first time after the camera is purchased. The A-GPS file becomes active from the second operation for determining a location.
- The validity period of the A-GPS file can be checked on the update screen. If the validity period has expired, it is displayed in gray.
- Once the validity period of the A-GPS file has expired, tracking of the position information will not become faster. Updating of the A-GPS file before using the GPS feature is recommended.

Points of Interest (POI) (Recording and Displaying Location Name Information)

Press the **MENU** button →  (GPS options) menu icon () → Points of interest (POI)

This shows how to set the POI (point of interest, location name information).

Option	Description
Embed POI	<p>When set to On, the location name information is recorded on the pictures to be shot.</p> <ul style="list-style-type: none"> The default setting is Off. The location name information can be recorded on a still image or movie.
Display POI	<p>When set to On, the location name information is displayed on the shooting screen or playback screen (, 10).</p> <ul style="list-style-type: none"> If Embed POI was set to On when a picture was taken, the location name information for the picture is displayed on the playback screen. The default setting is Off.
Level of detail	<p>Set the display level of the location name information. A higher display level shows more detailed regional information.</p> <ul style="list-style-type: none"> When set to level 1: country names are displayed. When set to levels 2 to 5: the information displayed varies depending on the country. When set to level 6: landmark names (facilities) are displayed.
Edit POI	<p>If Update POI is selected during playback mode, the location name information recorded on the image can be changed. Select the image whose location name information you want to edit, before pressing the MENU button.</p> <ul style="list-style-type: none"> When level 6 is selected, press the multi selector ◀ or ▶ to change the landmark name. To change the POI information level, press the multi selector ▲ or ▼. <p>If Remove POI is selected, the location name information recorded on the image is deleted.</p>

POI Display

- If there is no location name information in the display level that was set, “---” is displayed.
- The location name information (Point of Interest: POI) function is not provided for the COOLPIX S9500 sold in China and the Republic of Korea.

Create Log (Record the Log of Moving Information)

Press the **MENU** button →  (GPS options) menu icon ()6 → Create log

When log recording starts, the measured position information is recorded until a preset time has elapsed at the interval set for **Log interval**.

- The recorded log data cannot be used as is. To use the data, select **End log** and save it to a memory card.

1 Use the multi selector to select **Start log**, and press the  button.

- Before selecting **Start log**, select **Log interval** and press the  button to select the intervals of log recording. The default setting is **15 s**.

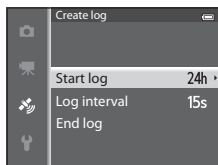

2 Select the duration that the log will be recorded, and press the  button.

- Log recording starts.
- The log data is recorded at the interval set for the **Log interval** until the preset time is reached.
- LOG** is displayed on the screen during log recording ()8).

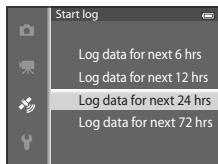

3 When log recording is completed, select **End log** in **Create log** in the GPS options menu, and press the  button.

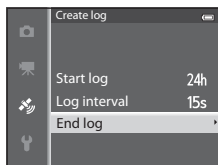

4 Select **Save log**, and press the  button.

- The log data is saved to a memory card.

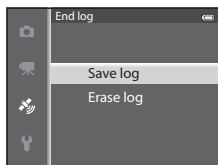

Notes on Log Recording

- If the date and time are not set, the log cannot be recorded.
- Use a fully charged battery to prevent the camera from turning off during log recording. When the battery power becomes exhausted, log recording ends.
- Log recording ends due to the operations below even when there is time remaining for log recording.
 - The USB cable is connected.
 - **Record GPS data** in **GPS options** is set to **Off** (same as when **Reset all** is performed).
 - The setting of the internal clock (time zone or date and time) is changed.
- Even when the camera is turned off, log recording is continuously performed until the preset time has elapsed if there is still time remaining for log recording.
- The log data is temporarily stored in the camera. New logs cannot be recorded if the log data remains in the camera. After recording log data, save it to a memory card.
- See "GPS Log Data Saved on Memory Cards" (0098) for more information.

To Erase Log Data

- To erase the log data that is temporarily stored in the camera, select **Erase log** in step 4.
- To erase the log data that is stored on the memory card, press the  button in **View log** (0064).

View Log

Press the **MENU** button →  (GPS options) menu icon (📖6) → View log

Check or erase the log data stored on the memory card using **Create log** (🔑62).

- See "GPS Log Data Saved on Memory Cards" (🔑98) for more information.

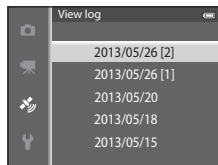

To Erase Log Data

Press the  button to select either function.

- **Selected log:** The selected log data is erased.
- **All logs:** All log data stored on the memory card is erased.

Log Data

Log data is NMEA format-compliant. However, display in any NMEA format-compliant software or on any NMEA format-compliant camera is not guaranteed.

Synchronize

Press the **MENU** button →  (GPS options) menu icon (📖6) → Synchronize

Signals from the GPS satellites are used to set the date and time of the camera's internal clock (only when **Record GPS data** in **GPS options** of the GPS options menu is set to **On**). Check the positioning status before starting synchronize.

Notes on Synchronize

- Date/time adjustment by **Synchronize** is set according to the time zone set in **Time zone and date** (📖20, 🔑68) of the setup menu. Check the time zone before setting **Synchronize**.
- The date/time set using **Synchronize** is not as accurate as radio clocks. Use **Time zone and date** in the setup menu to set the time if it is not accurate in **Synchronize**.

Electronic Compass

Press the **MENU** button →  (GPS options) menu icon (📖6) → Electronic compass

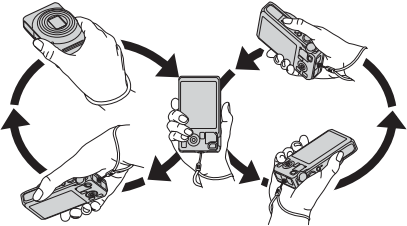
Option	Description
Compass display	<p>When set to On, a compass is displayed on the shooting screen.</p> <ul style="list-style-type: none"> • The default setting is Off. • The direction the camera is pointing is displayed based on measured direction information. • When the monitor faces upward, the compass indicator switches to a circle compass with a red arrow that points north. <ul style="list-style-type: none"> - Display style: north, east, south and west - Display range: 16 cardinal points
Compass correction	<p>Correct the compass when the compass direction is not displayed correctly.</p> <p>When the screen shown on the right is displayed, swing the camera to draw a figure 8 in the air while turning your wrist to face the camera forward and backward, side to side, or up and down.</p> <div data-bbox="681 540 928 722" style="border: 1px solid black; padding: 5px; margin: 10px 0;"> <p>Compass correction</p> <p>Move camera in a figure eight</p>  </div> 

Notes on Using the Electronic Compass





- The electronic compass is not displayed when the camera lens is facing upwards.
- Do not use the electronic compass in this camera for mountain climbing and other specialized applications. The displayed information is intended as a general guide only.
- Direction may not be measured correctly near the following objects:
magnets, metals, electrical motors, electrical home appliances or electrical power cables.
- Direction may not be measured correctly in the following places:
in automobiles, trains, ships, airplanes, inside buildings or in underground malls
- Direction may not be measured correctly if the position information is not recorded.

The Setup Menu

Welcome Screen

Press the **MENU** button →  menu icon (6) → Welcome screen

Select whether or not to display the welcome screen on the monitor when the camera is turned on.

Option	Description
None (default setting)	Display the shooting or playback screen without displaying the welcome screen.
COOLPIX	Display the welcome screen before displaying the shooting or playback screen.
Select an image	<p>Select a picture taken to display as the welcome screen. Display the image selection screen, choose an image (76), and press the .</p> <ul style="list-style-type: none">• Because the selected image is stored in the camera, the image appears in the welcome screen even if the original image is deleted.• The following pictures cannot be registered.<ul style="list-style-type: none">- Pictures reduced to 320 × 240 or smaller using small picture editing (18) or crop (19)- Pictures taken with Easy panorama- Pictures taken using 3D photography

Time Zone and Date

Press the **MENU** button → **Y** menu icon (📖) → Time zone and date

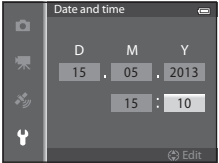
Option	Description
Date and time	<p>Set the camera clock to the current date and time. Use the multi selector to set the date and time.</p> <ul style="list-style-type: none"> Choose an item: Press ▶ or ◀ (selected in the following order: D (day) → M (month) → Y (year) → hour → minute). Set the contents: Press ▲ or ▼. Date and time can also be set by rotating the multi selector. Finish setting: Choose minute and press the OK button or ▶. 
Date format	<p>Choose the order in which the day, month, and year are displayed (Year/Month/Day, Month/Day/Year or Day/Month/Year).</p>
Time zone	<p>🏠 Home time zone can be specified and daylight saving can be enabled or disabled. When ➡ travel destination is registered, the time difference from the 🏠 home time zone is automatically calculated and the local date and time are recorded. Useful when traveling.</p>

Setting the Travel Destination Time Zone

1 Use the multi selector to choose **Time zone**, and press the **OK** button.

- The **Time zone** screen is displayed.

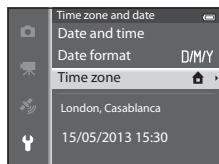

2 Choose **Travel destination** and press the **OK** button.

- The date and time displayed on the monitor change according to the region currently selected.

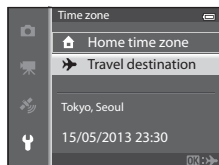

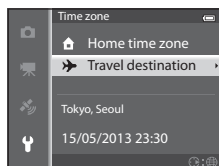

3 Press **▶**.

- The time zone selection screen is displayed.



4 Press **◀** or **▶** to choose the travel destination (time zone).

- The time difference between home and the travel destination is displayed.
- In regions where daylight saving time applies, press **▲** to enable the daylight saving time function. When this function is set to on, the  icon will be displayed at the top of the monitor and the camera clock advances one hour. To disable the daylight saving time function, press **▼**.
- If the time difference cannot be selected, set the correct time using **Date and time**.
- Press the **OK** button to register the travel destination time zone.
- While the travel destination time zone is selected, the  icon is displayed on the monitor when the camera is in shooting mode.

Time difference

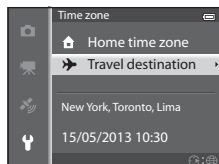
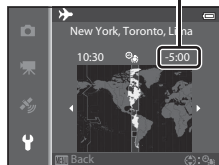

Home Time Zone

- To switch to the home time zone, choose **Home time zone** in step 2 and press the **OK** button.
- To change the home time zone, choose **Home time zone** in step 2 and perform the same procedure as for **Travel destination** to set the home time zone.



Monitor Settings

Press the MENU button →  menu icon (📖6) → Monitor settings

Option	Description
Photo info	Select information displayed on the monitor during shooting and playback modes.
Image review	On (default setting): Picture is displayed on the monitor immediately after shooting and the monitor display returns to shooting screen. Off : Picture is not displayed immediately after shooting.
Brightness	Choose from 5 settings to select the monitor brightness. The default setting is 3 .

Photo Info

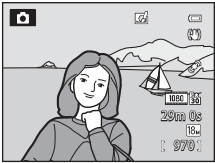
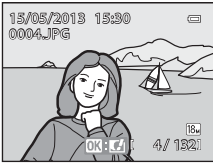
Select whether or not the photo information is displayed on the monitor screen. See “Monitor Screen” (📖8) for more information on indicators displayed on the monitor.

	For Shooting	For Playback
Show info		
Auto info (default setting)	The same information as in Show info is displayed. If no operations are performed after a few seconds, the display will be the same as Hide info . The information is displayed again when an operation is performed.	
Hide info		

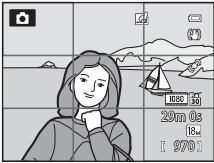
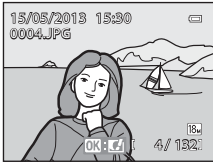
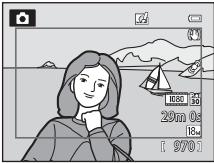
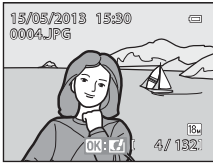
	For Shooting	For Playback
Framing grid+auto info	 <p>In addition to information shown with Auto info, a framing grid is displayed to help frame pictures. It is not displayed while recording movies.</p>	 <p>The same information as in Auto info is displayed.</p>
Movie frame+auto info	 <p>In addition to information shown with Auto info, the movie frame is displayed before recording movies.</p>	 <p>The same information as in Auto info is displayed.</p>

Print Date (Imprinting Date and Time on Pictures)

Press the **MENU** button → **Y** menu icon (📖6) → Print date

The shooting date and time can be imprinted on pictures at the time of shooting. This information can be printed even from printers that do not support printing of the date (🔧52).



Option	Description
DATE Date	The date is imprinted on pictures.
DATE Date and time	The date and time are imprinted on pictures.
OFF Off (default setting)	The date and time are not imprinted on pictures.

The icon for the current setting other than **Off** is displayed on the monitor (📖8).

✓ Notes on Print Date

- Imprinted date and time cannot be deleted from the image, nor can date and time be imprinted after the picture has been taken.
- Date and time cannot be imprinted in the following situations.
 - When the scene mode is set to **🌃** (Night landscape) (when set to **Hand-held**), **🌃** (Night portrait) (when set to **Hand-held**), **📷** (Backlighting) (when **HDR** is **On**), **Sports**, **Museum**, **Easy panorama**, **Pet portrait** (when set to **Continuous**) or **3D photography**
 - When **Continuous H**, **Continuous L**, **Pre-shooting cache**, **Continuous H: 120 fps**, **Continuous H: 60 fps** or **BSS** is selected for **Continuous** (🔧34)
 - During movie recording
- Dates imprinted with an **Image mode** (🔧29) setting of **VGA 640x480** may be difficult to read. Set the image mode to **2M 1600x1200** or higher.
- The date is recorded using the format selected in the setup menu's **Time zone and date** option (📖20, 🔧68).



✍ Print Date and Print Order

When printing from DPOF-compatible printers which support printing of shooting date and shooting information, the date and information can be printed on pictures without the date and time being imprinted on them with **Print date**, using options in the **Print order** menu (🔧51).

Vibration Reduction

Press the MENU button →  menu icon (📖6) → Vibration reduction

Specify the vibration reduction setting for shooting still pictures or movies. Correct blur, caused by slight hand movement known as camera shake, that commonly occurs when shooting with zoom applied or at slow shutter speeds.

Option	Description
 * On (hybrid)	<p>Record with optical compensation for camera shake during still picture shooting using the lens shift method, and under the following conditions, also performs electronic VR using image enhancement.</p> <ul style="list-style-type: none"> • When the shutter speed is slower than 1/30 second at the maximum wide-angle position and 1/250 second at the maximum telephoto position. • When the flash does not fire • When Single is selected for the Continuous setting • When the self-timer is off
 On (default setting)	<p>Compensate for camera shake using the lens shift method. The camera automatically detects the panning direction and only corrects for vibration caused by camera shake. When the camera is panned horizontally, for example, vibration reduction only reduces vertical shake. If the camera is panned vertically, vibration reduction only compensates for horizontal shake.</p>
OFF Off	Vibration reduction is not enabled.

The icon for the current setting other than **Off** is displayed on the monitor (📖8).

- When using a tripod to stabilize the camera, set vibration reduction to **Off**.







Notes on Vibration Reduction

- Immediately after the power is turned on or the camera enters shooting mode from playback mode, wait until the monitor screen stabilizes before shooting.
- Due to characteristics of the vibration reduction function, images displayed on the camera's monitor immediately after shooting may appear blurry.
- Vibration reduction may be unable to completely eliminate the effects of camera shake in some situations.
- When the camera shake is extremely high or low, picture compensation with electronic VR may not be possible even when **On (hybrid)** is set.
- When the shutter speed is fast or extremely slow, electronic VR may not operate even when **On (hybrid)** is set.
- When electronic VR in **On (hybrid)** operates, saving the picture takes longer than normal, because when the picture is shot, the shutter is released twice automatically to perform picture compensation. **Shutter sound** (📖77) is heard only once. One frame is recorded.

Motion Detection

Press the **MENU** button →  menu icon (📖6) → Motion detection

Enable motion detection to reduce the effects of camera shake and subject movement when shooting still pictures.

Option	Description
 Auto (default setting)	<p>If the camera detects the movement of the subject or camera shake, the ISO sensitivity is raised and the shutter speed is increased to reduce their effects.</p> <p>However, motion detection does not function in the following situations.</p> <ul style="list-style-type: none"> • When the flash fires • In the following scene modes:  (Night landscape),  (Night portrait),  (Backlighting), Sports, Dusk/dawn, Museum, Fireworks show, Easy panorama, Pet portrait, 3D photography • When Continuous (34) is set to Pre-shooting cache, Continuous H: 120 fps, Continuous H: 60 fps or Multi-shot 16 • When ISO sensitivity (37) is set to other than Auto
OFF Off	Motion detection is not enabled.

When **Auto** is selected, an icon for this setting is displayed on the monitor (📖8). The motion detection icon lights in green when the camera detects any vibration and increases the shutter speed.

Notes on Motion Detection

- Motion detection may be unable to completely reduce effects of camera shake and subject movement in some situations.
- Motion detection may not function if the subject exhibits significant movement or is too dark.
- The pictures taken may become grainy.
- Some features cannot be used in combination with other menu settings. See “Features Not Available in Combination” (📖64) for more information.

AF Assist

Press the **MENU** button →  menu icon (📖6) → AF assist







Enable or disable the AF-assist illuminator that assists the autofocus when the lighting is dim.

Option	Description
Auto (default setting)	AF-assist illuminator lights automatically if the lighting is dim. The illuminator has a range of about 5.0 m (16 ft) at the maximum wide-angle position and about 5.0 m (16 ft) at the maximum telephoto position. <ul style="list-style-type: none"> For some focus areas and scene modes such as Museum (📖40) and Pet portrait (📖42), AF-assist illuminator does not turn on even if Auto is set.
Off	AF-assist illuminator does not light. The camera may be unable to focus if lighting is dim.







Digital Zoom

Press the MENU button →  menu icon (6) → Digital zoom

Enable or disable the digital zoom.

Option	Description
On (default setting)	When the camera is zoomed in to the maximum optical zoom position, rotating the zoom control toward T () triggers the digital zoom ( 25).
 Crop	Limit zoom magnification up to the  mark position of the zoom indicator. Also limit digital zoom to a range in which the image quality of the pictures to be shot does not deteriorate. <ul style="list-style-type: none"> The digital zoom is not available when the image size is  4896×3672 ★,  4896×3672,  4864×2736. This setting functions in the same way as the On setting during movie recording.
Off	The digital zoom is not activated.

Notes on Digital Zoom

- When the digital zoom is used, the focus will be at the center of the frame.
- Digital zoom cannot be used with the following shooting modes.
 - When the scene mode is  (Scene auto selector),  (Night landscape),  (Night portrait),  (Backlighting) with **HDR** set to **On, Portrait, Easy panorama, Pet portrait, 3D photography**.
 - Smart portrait mode
- Some features cannot be used in combination with other menu settings. See “Features Not Available in Combination” (64) for more information.
- When the digital zoom is in effect, **Metering** (33) is set to **Center-weighted** or spot metering (where the center of the frame is metered) depending on the magnification of an enlargement.

Sound Settings

Press the **MENU** button →  menu icon (📖6) → Sound settings

Adjust the following sound settings.

Option	Description
Button sound	Set the following all sound settings to On (default setting) or Off . <ul style="list-style-type: none"> • Setting beep (beep sounds once when the settings are completed) • Focus beep (beep sounds twice when the camera focuses on the subject) • Error beep (beep sounds three times when an error is detected) • Start-up sounds to be emitted when the camera is turned on.
Shutter sound	Choose whether to set the shutter sound to On (default setting) or Off .

Notes on Sound Settings

- In **Pet portrait** scene mode, even when **On** is set, the button sound and shutter sound are disabled.
- Even when **On** is set, the shutter sound is disabled during movie recording.
- Some features cannot be used in combination with other menu settings. See “Features Not Available in Combination” (📖64) for more information.

Auto Off

Press the **MENU** button →  menu icon (📖6) → Auto off

If no operations are performed for a certain period while the camera is on, the monitor is turned off to save power and the camera enters standby mode (📖19). In this menu, set the time before the camera enters standby mode. Choose from **30 s**, **1 min** (default setting), **5 min** and **30 min**.

Auto Off Setting

- In the following situations, the time taken for the camera to enter standby mode is fixed.
 - When menus are displayed: 3 minutes (when auto off is set to **30 s** or **1 min**.)
 - During slideshow playback: maximum of 30 minutes
 - When the AC Adapter EH-62F is connected: 30 minutes
- The camera does not enter standby mode when transferring images using the Eye-Fi card.

Format Memory/Format Card

Press the MENU button →  menu icon (📖6) → Format memory/Format card

Format the internal memory or a memory card.

Formatting permanently deletes all data in the internal memory or memory card. The deleted data cannot be recovered. Be sure to transfer important pictures to a computer before formatting.

Formatting the Internal Memory

To format the internal memory, remove the memory card from the camera. The **Format memory** option is displayed on the setup menu.

Formatting Memory Cards

When a memory card is inserted in the camera, the memory card can be formatted. The **Format card** option is displayed on the setup menu.

Formatting Internal Memory and Memory Card

- When formatting the camera's internal memory or the memory card, album icons (📖7) are reset to their default icons (number icon).
- Do not turn off the camera or open the battery-chamber/memory card slot cover during formatting.
- The first time you insert a memory card that has been used in another device into this camera, be sure to format it with this camera.

Language

Press the MENU button →  menu icon (📖6) → Language

Choose one of 34 languages for displaying the camera menus and messages.

Čeština	Czech	Norsk	Norwegian	عربي	Arabic
Dansk	Danish	Polski	Polish	বাংলা	Bengali
Deutsch	German	Português (BR)	Brazilian Portuguese	简体中文	Simplified Chinese
English	(default setting)	Português (PT)	Portuguese	繁體中文	Traditional Chinese
Español	Spanish	Русский	Russian	हिन्दी	Hindi
Ελληνικά	Greek	Română	Romanian	日本語	Japanese
Français	French	Suomi	Finnish	한국어	Korean
Indonesia	Indonesian	Svenska	Swedish	मराठी	Marathi
Italiano	Italian	Tiếng Việt	Vietnamese	فارسی	Persian
Magyar	Hungarian	Türkçe	Turkish	தமிழ்	Tamil
Nederlands	Dutch	Українська	Ukrainian	తెలుగు	Telugu
				ภาษาไทย	Thai

TV Settings

Press the **MENU** button →  menu icon (📖6) → TV settings

Adjust the settings for connecting to a TV.

Option	Description
Video mode	Select the analog video output system from NTSC or PAL in accordance with your TV.
HDMI	Select a picture resolution for HDMI output from Auto (default setting), 480p , 720p or 1080i . When Auto is set, the output resolution that is best suited to the connected TV is selected automatically from 480p , 720p or 1080i .
HDMI device control	Select whether or not the camera receives signals from a TV when a TV that conforms to the HDMI-CEC standard is connected with an HDMI cable. When set to On (default setting), the television remote control can be used to operate the camera during playback. See “Using the TV’s Remote Control (HDMI Device Control)” (🔑21) for more information.
HDMI 3D output	Set the method used to output 3D images to HDMI devices. Select On (default setting) to three-dimensionally play back 3D images taken with this camera on a TV or monitor that is connected via HDMI.

Charge by Computer

Press the **MENU** button → **Y** menu icon (📖6) → **Charge by computer**

Select whether or not the battery inserted into the camera is charged when the camera is connected to a computer via the USB cable (📖77).

Option	Description
Auto (default setting)	When the camera is connected to a computer that is running, the battery inserted into the camera is automatically charged using power supplied by the computer.
Off	The battery inserted into the camera is not charged when the camera is connected to a computer.

✔ Notes on Connecting the Camera to a Printer

- The battery cannot be charged with connection to a printer, even if the printer complies with the PictBridge standard.
- When **Auto** is selected for **Charge by computer**, it may be impossible to print images with direct connection of the camera to some printers. If the PictBridge startup screen is not displayed on the monitor after the camera is connected to a printer and turned on, turn the camera off and disconnect the USB cable. Set **Charge by computer** to **Off** and reconnect the camera to the printer.

✔ Notes on Charging with Connection to a Computer

- The battery cannot be charged, nor can data be transferred, when the camera is connected to a computer before the camera's display language and date and time have been set (📖20). If the camera's clock battery (📖21) has been exhausted, the date and time must be reset before the battery can be charged or images can be transferred with connection to a computer. In this case, use the Charging AC Adapter EH-70P (📖14) to charge the battery and then set the camera's date and time.
- If the camera is turned off, charging will also stop.
- If the computer enters sleep mode while charging, charging will stop and the camera may be turned off.
- When disconnecting the camera from the computer, turn the camera off and then disconnect the USB cable.
- It may take longer to charge the battery with connection to a computer than with charging using the Charging AC Adapter EH-70P. Charging time increases when images are transferred while the battery is charging.
- When the camera is connected to a computer, an application installed on the computer, such as Nikon Transfer 2, may start. If the camera was connected to the computer for the sole purpose of charging the battery, exit the application.
- The camera turns off automatically if there is no communication with the computer for 30 minutes after the battery has finished charging.
- Depending upon computer specifications, settings, and power supply and allocation, it may be impossible to charge the battery using a computer connection while it is inserted into the camera.

The Charge Lamp

The following chart explains charge lamp status when the camera is connected to a computer.

Option	Description
Flashes slowly (green)	Battery charging.
Off	Battery not charging. If the charge lamp changes from slow flashing (green) to off while the power-on lamp is lit, charging is complete.
Flashes quickly (green)	<ul style="list-style-type: none"> • The ambient temperature is not suited to charging. Charge the battery indoors with an ambient temperature of 5°C to 35°C (41°F to 95°F). • The USB cable is not connected correctly, or the battery is faulty. Make sure the USB cable is connected correctly and replace the battery if necessary. • The computer is in sleep mode and is not supplying power. Wake up the computer. • The battery cannot be charged because the computer cannot supply power to the camera, due to the computer's settings or its specifications.

Blink Warning

Press the **MENU** button → **Y** menu icon (📖6) → Blink warning

Choose whether or not blinking eyes are detected when using face detection (📖67) in the following shooting modes.

- In the following scene modes:
 - **SCN** (Scene auto selector) (📖34)
 - **NP** (Night portrait) (when **Tripod** is selected) (📖36)
 - **Portrait** (📖38)
- **📷** (Auto) mode (when **Face priority** (📷38) is selected for **AF area mode**)

Option	Description
On	The Did someone blink? screen is displayed on the monitor if the camera detects that a human subject may have closed the eyes immediately after taking a picture using face detection. The face of the human subject that may have closed his/her eyes is framed by a yellow border. You can check the picture taken and determine if you need to take the picture again.
Off (default setting)	The camera does not detect blinks.

The Did someone blink? Screen

- To zoom in the face for which blinking was detected, rotate the zoom control toward **T** (🔍). To return to full-frame playback mode, rotate the zoom control toward **W** (📷).
- When the camera detects that one or more human subjects have closed their eyes, press ◀ or ▶ during playback zoom to display other faces.
- Press the **🗑️** button to delete the picture taken.
- Press the **OK** button or the shutter-release button to return to shooting screen.
- If no operations are performed for a few seconds, the screen automatically returns to the shooting screen.



✔ Note on Blink Warning

Some features cannot be used in combination with other menu settings. See "Features Not Available in Combination" (📖64) for more information.

Wi-Fi Options (COOLPIX S9500 only)

Press the **MENU** button → **Y** menu icon (📖6) → Wi-Fi options

Configure the Wi-Fi (wireless LAN) settings to connect the camera and a smart device.

Option	Description
Wi-Fi network	When wirelessly connecting the camera and a smart device, set Wi-Fi network to On . The default setting is Off . See “Using the Wi-Fi (Wireless LAN) Feature (COOLPIX S9500 only)” (📖93) for more information.
SSID	Change the SSID. The SSID configured here is displayed on the smart device. Set a 1- to 24-character alphanumeric SSID.
Auth./encryp.	Select whether or not to encrypt the communications between the camera and the connected smart device. <ul style="list-style-type: none"> Communications are not encrypted when Open (default setting) is selected.
Password	Set the password. Set a 8- to 16-character alphanumeric password. <ul style="list-style-type: none"> When Auth./encryp. is set to Open, the password cannot be set.
Channel	Change the channel used for wireless connections. If you experience a problem with the connection to a smart device due to radio wave interference from another device or radio station, change the channel number and retry the connection.
Subnet mask	Set the subnet mask. <ul style="list-style-type: none"> The default setting is 255.255.255.0. Use the default setting under normal conditions.
DHCP server IP address	Set the DHCP server IP address. <ul style="list-style-type: none"> The default setting is 192.168.0.10. Use the default setting under normal conditions.
Current settings	Display the current settings. <ul style="list-style-type: none"> When Auth./encryp. is set to Open, the password field is left blank.
Restore factory defaults	Restore the Wi-Fi settings to their default values.

Operating the Text Input Keyboard

Character Input for SSID and Password

- Press the ▲, ▼, ◀ or ▶ to select alphanumeric characters. Press the OK button to enter the selected character in the text field and move the cursor to the next space.
- To move the cursor in the text field, select ← or → on the keyboard, and press the OK button.
- To delete one character, press the 🗑️ button.
- To apply the setting, select ↩ on the keyboard and press the OK button.



Character Input for Channel, Subnet mask and DHCP server IP address

- Press the ▲ or ▼ to set the numbers. To move to the next digit, press the ▶ or OK button. To return to the previous digit, press the ◀ button.
- To apply the setting, select the last digit and press the OK button.





✓ Notes on Wi-Fi Network

Wi-Fi network cannot be selected in the following situations:

- When an HDMI, USB or audio/video cable is connected to the camera
- When no memory card is inserted in the camera
- When an Eye-Fi card is inserted in the camera
- When the battery level indicator in the monitor indicates

Eye-Fi Upload

Press the MENU button →  menu icon (📖6) → Eye-Fi upload





Option	Description
 Enable (default setting)	Upload images created by the camera to a preselected destination when an Eye-Fi card is in the camera.
 Disable	Images will not be uploaded.

Notes on Eye-Fi Cards

- Note that images may not be uploaded if signal strength is insufficient even if **Enable** is selected.
- Remove the Eye-Fi card from the camera in a place where the use of radio waves is prohibited. Signals may be transmitted even if **Disable** is selected.
- Refer to the instruction manual of your Eye-Fi card for more information. In the event of malfunction, contact the card manufacturer.
- The camera can be used to turn Eye-Fi cards on and off, but may not support other Eye-Fi functions.
- The camera is not compatible with the endless memory function. When it is set on a computer, disable the function. If the endless memory function is enabled, the number of pictures taken may not be displayed correctly.
- Eye-Fi cards are for use only in the country of purchase. Observe all local laws concerning wireless devices.
- Leaving the setting as **Enable** will result in the battery being depleted in a shorter period of time.

Eye-Fi Communication Indicator

The communication status of the Eye-Fi card in the camera can be confirmed on the monitor (📖8).

- : **Eye-Fi upload** is set to **Disable**.
-  (lights): Eye-Fi upload enabled; waiting to begin upload.
-  (flashes): Eye-Fi upload enabled; uploading data.
- : An error occurred. The camera cannot control the Eye-Fi card.

Filmstrip

Press the **MENU** button → **Y** menu icon (📖6) → Filmstrip

Allows you to select whether or not filmstrips are displayed when you rotate the multi selector quickly in full-frame playback mode (📖28).

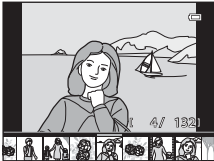
Option	Description
On	<p>Image thumbnails are displayed at the bottom of the monitor when you rotate the multi selector quickly while viewing an image in full-frame playback mode.</p> <p>You can view thumbnails of previous and subsequent images, and select an image.</p> <p>While the filmstrip is displayed, you can hide it by pressing the OK button.</p> 
Off (default setting)	Disables the filmstrip.

✓ Notes on Filmstrip Display





- In order to display the filmstrip, at least 10 images must be saved in the camera's internal memory or on the memory card.
- For favorite pictures, auto sort, or list by date playback mode, the selected album, category, or shooting date must have at least 10 images.
- When each picture in a sequence (📷11) is displayed by pressing the **OK** button, the filmstrip cannot be displayed.

Reset All





Press the MENU button →  menu icon () → Reset all

When **Reset** is selected, the camera settings are restored to the default values.

Basic Shooting Functions

Option	Default value
Flash mode ()50)	Auto
Self-timer ()53)	OFF
Macro mode ()54)	OFF
Creative slider adjustment ()55)	Center
Exposure compensation ()58)	0.0

Scene Mode

Option	Default value
Scene menu ()33)	Portrait
Hue adjustment in Food mode ()40)	Center
Easy panorama ()41)	Normal (180°)
Pet portrait ()42)	Pet portrait auto release: ON Continuous: Continuous

Night Landscape Menu

Option	Default value
Night landscape ()35)	Hand-held

Night Portrait Menu

Option	Default value
Night portrait ()36)	Hand-held

Backlighting Menu

Option	Default value
HDR ()37)	Off

Smart Portrait Menu

Option	Default value
Skin softening (🔍43)	Normal
Smile timer (🔍43)	On (single)
Blink proof (🔍44)	Off

Special Effects Menu

Option	Default value
Special effects (📖47)	Soft

Shooting Menu

Option	Default value
Image mode (🔍29)	 4896x3672
White balance (🔍31)	Auto
Metering (🔍33)	Matrix
Continuous (🔍34)	Single
ISO sensitivity (🔍37)	Auto
AF area mode (🔍38)	Target finding AF
Autofocus mode (🔍41)	Single AF
Quick effects (🔍42)	On

Movie Menu

Option	Default value
Movie options (🔍45)	 1080★/30p
Open with HS footage (🔍49)	On
Autofocus mode (🔍49)	Single AF
Wind noise reduction (🔍50)	Off

GPS Options Menu (COOLPIX S9500 only)

Option	Default value
Record GPS data (Fn659)	Off
Embed POI (Fn61)	Off
Display POI (Fn61)	Off
Level of detail (Fn61)	Level 6 (detailed)
Log recording duration (Fn62)	Log data for next 24 hrs
Compass display (Fn65)	Off

Setup Menu

Option	Default value
Welcome screen (Fn67)	None
Photo info (Fn70)	Auto info
Image review (Fn70)	On
Brightness (Fn70)	3
Print date (Fn72)	Off
Vibration reduction (Fn73)	On
Motion detection (Fn74)	Auto
AF assist (Fn75)	Auto
Digital zoom (Fn76)	On
Button sound (Fn77)	On
Shutter sound (Fn77)	On
Auto off (Fn77)	1 min
HDMI (Fn79)	Auto
HDMI device control (Fn79)	On
HDMI 3D output (Fn79)	On
Charge by computer (Fn80)	Auto
Blink warning (Fn82)	Off
Wi-Fi network (Fn83) (COOLPIX S9500 only)	Off
SSID (Fn83) (COOLPIX S9500 only)	Nikon S9500xxxxxxx (8-digit serial number)
Auth./encryp. (Fn83) (COOLPIX S9500 only)	Open
Password (Fn83) (COOLPIX S9500 only)	NikonCoolpix

The Setup Menu

Option	Default value
Channel (📷83) (COOLPIX S9500 only)	6
Subnet mask (📷83) (COOLPIX S9500 only)	255.255.255.0
DHCP server IP address (📷83) (COOLPIX S9500 only)	192.168.0.10
Eye-Fi upload (📷85)	Enable
Filmstrip (📷86)	Off

Others

Option	Default value
Paper size (📷23, 📷24)	Default
Frame intvl for Slide show (📷54)	3 s
Sequence display options (📷58)	Key picture only

- Choosing **Reset all** also clears the current file number (📷97) in the memory. After resetting, numbering continues from the lowest number available in the internal memory or the memory card. If **Reset all** is performed after all pictures are deleted from the internal memory or memory card (📖29), the file numbers for the next pictures taken start from **0001**.
- The following settings remain unaffected even if **Reset all** is performed.
 - **Shooting menu:** Preset manual data for **White balance** (📷32)
 - **Playback menu:** **Favorite pictures** (📷5) and **Choose key picture** (📷58)
 - **Setup menu:** **Time zone and date** (📷68), **Language** (📷78) and **Video mode** (📷79) in **TV settings**
 - Album icon and color (📷7)

Firmware Version



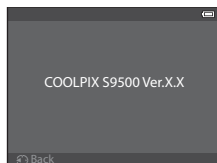

Press the MENU button → 📷 menu icon (📖6) → Firmware version

Displays the current camera firmware version.

















Error Messages

The following table lists the error messages and other warnings displayed on the monitor, as well as the solutions for dealing with them.





Display	Cause/Solution	
 (flashes)	Clock not set. Set date and time.	 68
Battery exhausted.	Battery exhausted. Charge or replace the battery.	12, 14
Battery temperature is elevated. The camera will turn off.	Battery temperature is high. Turn off camera, and allow battery to cool down before resuming use. 5 seconds after this message appears, the monitor is turned off, and the power-on lamp starts flashing quickly. After the lamps flash for 3 minutes, the camera turns off automatically, but you can also press the power switch to turn it off manually.	19
The camera will turn off to prevent overheating.	Inside of the camera has become hot. The camera turns off automatically. Leave the camera off until the inside of the camera has cooled and then turn it on again.	–
 (flashes red)	Camera cannot focus. <ul style="list-style-type: none"> • Refocus. • Use focus lock. 	26 68
Please wait for the camera to finish recording.	Camera cannot perform other operations until recording is complete. Wait until message clears from display automatically when recording is complete.	–
Memory card is write protected.	Write-protect switch of the memory card is in “lock” position. Slide the write-protect switch to “write” position.	–
Not available if Eye-Fi card is locked.	Write-protect switch of Eye-Fi card is in “lock” position. Slide the write-protect switch to “write” position.	–
	Error accessing Eye-Fi card. <ul style="list-style-type: none"> • Check that the terminal is clean. • Confirm that memory card is correctly inserted. 	16 16
This card cannot be used.	Error accessing memory card. <ul style="list-style-type: none"> • Use an approved card. • Check that the terminal is clean. • Confirm that memory card is correctly inserted. 	17 16 16
This card cannot be read.		



Error Messages

Display	Cause/Solution	
Card is not formatted. Format card? Yes No	Memory card has not been formatted for use in this camera. All data stored on the memory card is deleted when formatted. If there is any data on the card that you want to keep, select No , and backup the data to a computer before formatting the memory card. To format the memory card, select Yes and press the OK button.	16
Out of memory.	Memory card is full. <ul style="list-style-type: none"> • Choose smaller image mode. • Delete pictures and movies. • Replace memory card. • Remove memory card and use internal memory. 	 29 29, 87 16 17
Image cannot be saved.	Error occurred while recording picture. Format the internal memory or memory card.	 78
	Camera has run out of file numbers. Replace the memory card, or format the internal memory/ memory card.	16,  78
	Picture cannot be used for welcome screen.	 67
	There is insufficient space to save a copy. Delete pictures from destination.	29
Album is full. No further pictures can be added.	200 pictures have already been added to the album. <ul style="list-style-type: none"> • Remove pictures from the album • Add the picture to another album 	 6  5
A blink was detected in the picture just taken.	Someone may have had their eyes closed when the picture was taken. Check the picture in playback mode.	 44
Unable to create panorama.	Cannot perform Easy panorama shooting. Easy panorama shooting may not be available in the following situations. <ul style="list-style-type: none"> • When shooting has not finished after a certain period of time • When the camera movement speed is too fast • When the camera is not straight relative to the panorama direction 	 2
Unable to create panorama. Pan the camera in one direction only.		
Unable to create panorama. Pan the camera more slowly.		
Shooting failed	Failed to shoot the first image for 3D photography. <ul style="list-style-type: none"> • Try shooting again. • In some shooting conditions, such as when the subject moves or the subject is dark or low in contrast, the picture may not be taken. 	43 —









Display	Cause/Solution	
Failed to take second shot	When taking 3D images, the second shot could not be successfully taken after the first shot. <ul style="list-style-type: none"> Try shooting again. After taking the first shot, move the camera horizontally and frame the subject so that it is aligned with the guide. In some shooting conditions, such as when the subject moves or the subject is dark or low in contrast, the second shot may not be taken. 	43 –
Failed to save 3D image	Failed to save the 3D images. <ul style="list-style-type: none"> Try shooting again. Delete unnecessary pictures. In some shooting conditions, such as when the subject moves or the subject is dark or low in contrast, the 3D images may not be created, resulting in failure to save them. 	43 29 –
Sound file cannot be saved.	A voice memo cannot be attached to this file. <ul style="list-style-type: none"> Voice memos cannot be attached to movies. Select a picture taken with this camera. 	–  56
Image cannot be modified.	Cannot edit selected picture. <ul style="list-style-type: none"> Confirm the conditions that are required for editing. These options cannot be used with movies. 	 14 –
Cannot record movie.	Time out error while recording movie. Choose memory card with faster write speed.	17
Memory contains no images.	No pictures in the internal memory or memory card. <ul style="list-style-type: none"> To view the pictures stored in the internal memory, remove the memory card. To copy pictures from internal memory to a memory card, press the MENU button and select Copy from the playback menu. 	17  57
File contains no image data.	File not created with the COOLPIX S9500/S9400. File cannot be viewed on this camera.	–
This file cannot be played back.	View file using the computer or any other devices which was used to create or edit this file.	–
All images are hidden.	No images available for a slide show.	–
This image cannot be deleted.	Picture is protected. Disable protection.	 55
Travel destination is in the current time zone.	Destination in same time zone as home.	–

Error Messages

Display	Cause/Solution	
Mode dial is not in the proper position.	Mode dial is between two modes. Rotate the mode dial to select the desired mode.	22
Lens error	Lens error occurred. Turn the camera off and then on again. If the error persists, contact retailer or Nikon-authorized service representative.	19
Communications error	Error occurred during communication with printer. Turn off camera and reconnect the USB cable.	 22
System error	Error has occurred in camera's internal circuitry. Turn off camera, remove and reinsert battery, and turn on camera. If the error persists, contact retailer or Nikon-authorized service representative.	19
Could not obtain GPS data.	(COOLPIX S9500 only) The camera clock is not set correctly. Change the location or time and determine the location again.	–
No A-GPS file found on card	(COOLPIX S9500 only) An A-GPS file that can be updated is not found on the memory card. Check the following items. <ul style="list-style-type: none"> • Whether the memory card is inserted • Whether the A-GPS file is stored on the memory card • Whether the A-GPS file saved on the memory card is more recent than the A-GPS file saved in the camera • Whether the A-GPS file is still valid 	–
Update failed	(COOLPIX S9500 only) Unable to update A-GPS file. The A-GPS file may be corrupted. Download the file from the website once more.	 60
Cannot save to card	A memory card is not inserted. Insert a memory card.	16
	(COOLPIX S9500 only) 36 log data events have been already saved in one day.	–
	(COOLPIX S9500 only) 100 log data events have been already saved. Delete log data that is no longer required from a memory card or replace the memory card with a new one.	 64
Unable to correct compass	(COOLPIX S9500 only) Unable to correct the electronic compass correctly. Swing the camera to draw a figure 8 in the air outdoors while turning your wrist to face the camera forward and backward, side to side, or up and down.	 65

Display	Cause/Solution	
The memory card has been removed. Wi-Fi is now disabled.	(COOLPIX S9500 only) The storage media of the smart device or memory card of the camera has been removed while the camera and smart device are connected wirelessly. The wireless connection is terminated. Insert the storage media or memory card and perform reconnection.	94
No access	(COOLPIX S9500 only) Unable to receive communication signals from the smart device. Perform the operation on the smart device for wireless connection to the camera.	94
Could not connect	(COOLPIX S9500 only) The connection failed while receiving communication signals from the smart device. Change the communication channel to another number using Channel of Wi-Fi options in the setup menu to retry the operation for wireless connection.	94,  83

Error Messages

Display	Cause/Solution	
Printer error: check printer status.	Printer error Check printer. After solving the problem, select Resume and press the  button to resume printing.*	–
Printer error: check paper	Specified size of paper is not loaded. Load the specified size of paper, select Resume and press the  button to resume printing.*	–
Printer error: paper jam	Paper has jammed in the printer. Remove the jammed paper, select Resume and press the  button to resume printing.*	–
Printer error: out of paper	No paper is loaded in the printer. Load the specified size of paper, select Resume and press the  button to resume printing.*	–
Printer error: check ink	Ink error Check ink, select Resume and press the  button to resume printing.*	–
Printer error: out of ink	Ink cartridge is empty. Replace ink cartridge, select Resume and press the  button to resume printing.*	–
Printer error: file corrupt	An error caused by the image file has occurred. Select Cancel and press the  button to cancel printing.	–

* See the instruction manual provided with your printer for further guidance and information.

File and Folder Names

Pictures, movies and voice memos are assigned file names as follows.

File name : DSCN0001.JPG

(1) (2) (3)

(1) Identifier	Not displayed on camera monitor.	
	DSCN	Original still pictures, movies
	SSCN	Small copies
	RSCN	Cropped copies
	FSCN	Pictures created with picture editing other than crop and small picture*, movies created with movie editing
(2) File number	Assigned automatically in ascending order, starting from "0001" to "9999." <ul style="list-style-type: none">When the file numbers in a folder reach "9999," a new folder is created and the next file number returns to "0001."	
(3) Extension	Signifies the file type.	
	.JPG	JPEG still pictures
	.MOV	Movies
	.WAV	Voice memos <ul style="list-style-type: none">Identifier and file number are the same as the picture to which the voice memo is attached.
	.MPO	3D images

* Includes quick effects (📷32) of 📷 (auto) mode



Folder name : 100NIKON

(1) (2)

(1) Folder number	Assigned automatically in ascending order, starting from "100" to "999." <ul style="list-style-type: none">A new folder is created under the following conditions.<ul style="list-style-type: none">When the number of files in a folder reaches 200When the file numbers in a folder reach 9999
(2) Folder name	NIKON

File and Folder Names

Notes

- When image files or voice files are copied to or from the internal memory or memory card ()57), the file naming conventions are as follows:
 - Selected images:
Files copied using selected images are copied to the current folder (or to the folder used for subsequent pictures), where they are assigned file numbers in ascending order following the largest file number in memory.
 - All images:
Files copied using all images, along with their folder, are copied together. Folder numbers are assigned in ascending order, following the largest folder number on the destination medium. File names are not changed.
- When the current folder is numbered 999, if there are 200 files in the folder or if a file is numbered 9999, no further pictures can be shot until the internal memory or memory card is formatted ()78), or a new memory card is inserted.

GPS Log Data Saved on Memory Cards

The log data is saved in the "NCFL" folder.

- The file names consist of "N", "date (the last two digits of the year, month, and date in YYMMDD format)", "identification number (0 to 9 and A to Z)" and "extension (.log)."
Example: the first GPS log recorded on 15 May 2013 is
N1305150.log
- Up to 36 files can be recorded a day and up to 100 files can be recorded on a memory card.

Optional Accessories

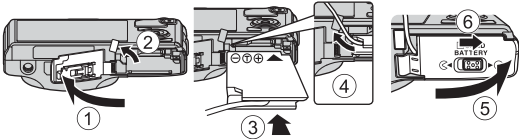
Battery charger	Battery Charger MH-65 (Charging time when the battery is completely used up: Approx. 2 hours 30 minutes)
AC adapter	<p data-bbox="274 235 634 259">AC Adapter EH-62F (connect as shown)</p> <p data-bbox="274 267 880 459">1 2 3</p>  <p data-bbox="274 481 917 634">Properly align the power connector cord in the power connector groove, and then insert the AC adapter. Before closing the battery-chamber/memory card slot cover, properly align the power connector cord in the battery chamber groove. If part of the cord runs out of the grooves, the cover or cord may be damaged when the cover is closed.</p>

See our websites or product catalogs for up-to-date information on accessories for the COOLPIX S9500/S9400.



A series of horizontal dashed lines spanning the width of the page, intended for handwriting practice.



Technical Notes and Index

Caring for the Products	2
The Camera.....	2
The Battery.....	3
Charging AC Adapter.....	4
The Memory Cards.....	5
Caring for the Camera	6
Cleaning.....	6
Storage.....	6
Troubleshooting	7
USER LICENSE AGREEMENT FOR LOCATION NAME	
DATA (COOLPIX S9500).....	15
Specifications.....	19
Supported Standards.....	23
Index	26

Caring for the Products

The Camera

To ensure continued enjoyment of this Nikon product, observe the following precautions when using or storing the device.

Be sure to read and follow the warnings of “For Your Safety” (📖 vi to viii) thoroughly before using the products.

✔ **Keep Dry**

The device will be damaged if immersed in water or subjected to high humidity.

✔ **Do Not Drop**

The product may malfunction if subjected to strong shock or vibration.

✔ **Handle the Lens and All Moving Parts with Care**

Do not apply force to the lens, lens cover, monitor, memory card slot, or battery chamber. These parts are easily damaged. Applying force to the lens cover could result in camera malfunction or damage to the lens.

✔ **Do Not Point the Lens at Strong Light Sources for Extended Periods**

Avoid pointing the lens at the sun or other strong light sources for extended periods when using or storing the camera. Intense light may cause deterioration of the image sensor, producing a white blur effect in photographs.

✔ **Keep away from Strong Magnetic Fields**

Do not use or store this device in the vicinity of equipment that generates strong electromagnetic radiation or magnetic fields. Strong static charge or the magnetic fields produced by equipment such as radio transmitters could interfere with the monitor, damage data saved on the memory card, or affect the product's internal circuitry.

✔ **Avoid Sudden Changes in Temperature**

Sudden changes in temperature, such as when entering or leaving a heated building on a cold day, can cause condensation to form inside the device. To prevent condensation, place the device in a carrying case or a plastic bag before exposing it to sudden changes in temperature.

✔ **Turn the Product off Before Removing or Disconnecting the Power Source or the Memory Card**

Do not remove the battery while the product is on, or while images are being saved or deleted. Forcibly cutting power in these circumstances could result in loss of data or in damage to product memory or internal circuitry.

Notes on the Monitor

- Monitors and electronic viewfinders are constructed with extremely high precision; at least 99.99% of pixels are effective, with no more than 0.01% being missing or defective. Hence while these displays may contain pixels that are always lit (white, red, blue, or green) or always off (black), this is not a malfunction and has no effect on images recorded with the device.
- Due to the general characteristics of OLED monitors, prolonged or repeated display of the same screen or image may result in screen burn. Screen burn can be recognized by decreased brightness in portions of the monitor or mottled display. In some cases, screen burn may become permanent. However, images are in no way affected by screen burn.
To prevent screen burn, do not set monitor brightness higher than necessary and do not display the same screen or image for an extended period of time.
- Images on the monitor may be difficult to see under bright lighting.
- The monitor is lit by an LED backlight. Should the monitor begin to dim or flicker, contact your Nikon-authorized service representative.

The Battery

- Be sure to read and follow the warnings of “For Your Safety” (vi to viii) thoroughly before using the battery.
- Check the battery level before using the camera and replace or charge the battery if necessary. Do not continue charging once the battery is fully charged as this will result in reduced battery performance. Whenever possible, carry a fully charged spare battery when taking pictures on important occasions.
- Do not use the battery at ambient temperatures below 0°C (32°F) or above 40°C (104°F).
- Charge the battery indoors with an ambient temperature of 5°C to 35°C (41°F to 95°F) before use.
- When the battery temperature is between 0°C and 10°C (32°F to 50°F) or 45°C to 60°C (113°F to 140°F), the chargeable capacity may decrease.
- The battery is not charged at ambient temperatures below 0°C (32°F) or above 60°C (140°F).
- Note that the battery may become hot during use; wait for the battery to cool before charging. Failure to observe these precautions could damage the battery, impair its performance, or prevent it from charging normally.
- On cold days, the capacity of batteries tends to decrease. Be sure that the battery is fully charged before heading outside to take pictures in cold weather. Keep spare batteries in a warm place and exchange as necessary. Once warmed, a cold battery may recover some of its charge.
- Dirt on the battery terminals can prevent the camera from functioning. Should the battery terminals become dirty, wipe them off with a clean, dry cloth before use.

Caring for the Products

- If the battery will not be used for some time, insert it in the camera and run it flat before removing it for storage. The battery should be stored in a cool location with an ambient temperature of 15°C to 25°C (59°F to 77°F). Do not store the battery in hot or extremely cold locations.
- Always remove the battery from the camera or battery charger when it is not being used. When inserted, minute amounts of current are drawn from the battery even when not in use. This may result in excessive draining of the battery and complete loss of function. Turning the camera on or off while the battery is exhausted can result in reduced battery life. When the battery level is low, be sure to charge the battery before using it.
- Recharge the battery at least once every six months and completely exhaust it before returning it to storage.
- After removing the battery from the camera or battery charger, attach the included terminal cover to the battery and store it in a cool place.
- A marked drop in the time a fully-charged battery retains its charge, when used at room temperature, indicates that the battery needs to be replaced. Purchase a new EN-EL12 battery.
- Replace the battery when it no longer holds a charge. Used batteries are a valuable resource. Please recycle used batteries in accordance with local regulations.

Charging AC Adapter

- Be sure to read and follow the warnings of "For Your Safety" (📖vi to viii) thoroughly before using the Charging AC Adapter.
- The Charging AC Adapter EH-70P is for use only with compatible devices. Do not use with another make or model of device.
- The EH-70P is compatible with AC 100-240 V, 50/60 Hz electrical outlets. When using in other countries, use a plug adapter (commercially available) as necessary. For more information about plug adapters, consult your travel agency.
- Do not, under any circumstances, use another make or model of AC adapter other than the Charging AC Adapter EH-70P or USB-AC adapter. Failure to observe this precaution could result in overheating or in damage to the camera.

The Memory Cards

- Use only Secure Digital memory cards. See “Approved Memory Cards” (📖17).
- Be sure to observe the precautions in the memory card documentation when you use the memory card.
- Do not affix labels or stickers to the memory card.
- Do not format the memory card using a computer.
- When a memory card that has been used in another device is used for the first time, be sure to format it with this camera.
When a new memory card is used, it is recommended to format it with this camera first.
- Formatting permanently deletes all data in the memory card. Be sure to transfer important pictures to a computer before formatting.
- If the error message “Card is not formatted. Format card?” is displayed when you insert a memory card into this camera, the memory card must be formatted. If the memory card contains images you wish to keep, select **No** and save those images on your computer before formatting the memory card. To format the card, select **Yes** and press the **OK** button.
- Do not perform the following during formatting, while data is being written to or deleted from the memory card, or during data transfer to a computer. Failure to observe this precaution could result in loss of data or damage to the memory card:
 - Open the battery-chamber/memory card slot cover to remove the battery or memory card.
 - Turn off the camera
 - Disconnect the AC adapter

Caring for the Camera

Cleaning

Lens	Avoid touching glass parts with your fingers. Remove dust or lint with a blower (typically a small device with a rubber bulb attached to one end that is pumped to produce a stream of air out the other end). To remove fingerprints, oily substances, or other stains that cannot be removed with a blower, carefully wipe the lens with a dry soft cloth or eyewear cleaning cloth, using a spiral motion that starts at the center of the lens and working toward the edges. Do not wipe the lens forcibly or with a hard material. Failure to observe this precaution could result in damage or trouble. If this fails, clean the lens using a cloth lightly dampened with commercial lens cleaner.
Monitor	Remove dust or lint with a blower. To remove fingerprints, oily substances or other stains, carefully wipe the monitor with a dry soft cloth or eyewear cleaning cloth. Do not wipe the monitor forcibly or with a hard material. Failure to observe this precaution could result in damage or trouble.
Body	Use a blower to remove dust, dirt, or sand, then wipe gently with a soft, dry cloth. After using the camera at the beach or other sandy or dusty environment, wipe off any sand, dust, or salt with a dry cloth lightly dampened with fresh water and dry thoroughly. Note that foreign matter inside the camera could cause damage not covered by the warranty.

Do not use volatile organic solvents such as alcohol or thinner, chemical detergents, anticorrosive agents, or anti-fogging agents.

Storage

Remove the battery if the camera will not be used for an extended period. Do not store the camera with naphtha or camphor moth balls, or in any of the following locations:

- Next to equipment that produces strong electromagnetic fields, such as televisions or radios
- Exposed to temperatures below -10°C (14°F) or above 50°C (122°F)
- Places that are poorly ventilated or subject to humidity of over 60%

To prevent mold or mildew, take the camera out of storage at least once a month. Turn the camera on and release the shutter a few times before putting the camera away again.

Be sure to read and follow the warnings given in "The Battery" (🔋:3) of "Caring for the Products" to store the battery.

Troubleshooting











If the camera fails to function as expected, check the list of common problems below before consulting your retailer or Nikon-authorized service representative. Refer to the page numbers in the right-most column for more information.

- See “Error Messages” (🔍91) for more information.

Power, Display, Settings Issues







Problem	Cause/Solution	
The camera is on but does not respond.	<ul style="list-style-type: none"> • Wait for recording to end. • If the problem persists, turn the camera off. If the camera does not turn off, remove and reinsert the battery or batteries or, if you are using an AC adapter, disconnect and reconnect the AC adapter. <p>Note that although any data currently being recorded will be lost, data that have already been recorded will not be affected by removing or disconnecting the power source.</p>	– 19
The battery inserted in the camera cannot be charged.	Confirm all connections.	12
The battery cannot be charged by connecting the camera to a computer.	<ul style="list-style-type: none"> • Off is selected for Charge by computer in the setup menu. • When charging by connecting the camera to a computer, battery charging stops when the camera is turned off. • When charging by connecting the camera to a computer, battery charging stops when the computer is suspended (sleeping), and the camera may turn off. • Depending upon computer specifications, settings, and status, charging the battery inserted in the camera may not be possible via computer connection. 	98, 🔍80 🔍80 🔍80 –
Camera cannot be turned on.	Battery is exhausted.	18
Camera turns off without warning.	<ul style="list-style-type: none"> • Battery is exhausted. • If no operations are performed for a while, camera has turned off automatically by auto off to save power. • The camera turns off if the Charging AC Adapter is connected while the camera is on. • The camera turns off if the USB cable connecting it to a computer or printer is disconnected. Reconnect the USB cable. • Inside of the camera has become hot. Leave the camera off until the inside of the camera has cooled. • At low temperatures, the camera and the battery may not function normally. 	18 19 14 77, 80, 🔍22 – 🔍3

Troubleshooting











Problem	Cause/Solution	
The monitor is blank.	<ul style="list-style-type: none"> • Camera is off. • Battery is exhausted. • Standby mode for saving power: Press the power switch, shutter-release button,  button or  movie-record) button, or rotate the mode dial. • When flash lamp flashes, wait until flash has charged. • Camera and computer are connected via USB cable. • Camera and TV are connected via audio/video cable or HDMI cable. • Camera and smart device are connected using Wi-Fi connection and the camera is operated by remote control. 	19 18 19 50 77, 80 77,  20 93
Monitor screen is hard to see.	<ul style="list-style-type: none"> • Adjust monitor screen brightness. • Monitor is dirty. Clean monitor screen. 	96,  70  6
Date and time of recording are not correct.	<ul style="list-style-type: none"> • If the camera clock has not been set ("Date not set" indicator flashes during shooting), still pictures have a time stamp of "00/00/0000 00:00"; and movies are dated "01/01/2013 00:00." Set the correct date and time using Time zone and date in the setup menu. • The camera clock is not as accurate as a normal clock, such as watches. Check camera clock regularly against more accurate timepieces and reset as required. 	20, 96,  68 96,  68
No information displayed on the monitor.	Hide info is selected for Photo info under Monitor settings in the setup menu.	96  70
Print date not available.	Time zone and date in the setup menu has not been set.	20, 96,  68
Date not appearing on pictures even when Print date is enabled.	<ul style="list-style-type: none"> • A shooting mode that does not support print date is selected. • Another function that is set now is restricting the print date. • The date cannot be imprinted onto a movie. 	96,  72 64 –
Screen for setting time zone and date is displayed when camera is turned on. Camera settings reset.	Clock battery is exhausted; all settings were restored to their default values.	21















Problem	Cause/Solution	
Monitor is turned off, and the power-on lamp flashes quickly.	Battery temperature is high. Turn off camera, and allow battery to cool down before resuming use. After the lamp flashes for 3 minutes, the camera turns off automatically, but you can also press the power switch to turn it off manually.	19
Camera temperature rises.	When functions such as movie recording or sending images using an Eye-Fi card are used for a long time, or when the camera is used in a location with a high ambient temperature, the camera temperature may rise. This is not a malfunction.	84

Shooting Issues



Problem	Cause/Solution	
Cannot set to shooting mode.	Disconnect the HDMI cable or USB cable.	77, 80,  20,  22
No picture can be taken.	<ul style="list-style-type: none"> When the camera is in playback mode, press the  button,  (movie-record) button or shutter-release button. When menus are displayed, press the MENU button. Battery is exhausted. When flash lamp flashes, wait until flash has charged. Camera and smart device are connected using Wi-Fi connection and the camera is operated by remote control. 	28 6 18 50 93
Cannot take 3D images	In some shooting conditions, such as when the subject moves or the subject is dark or low in contrast, the second shot may not be taken or the 3D image may not be saved.	–
Camera cannot focus.	<ul style="list-style-type: none"> Subject is too close to the camera. Try shooting with Macro mode,  (Scene auto selector) or Close-up scene mode. The intended subject is one with which autofocus does not perform well. Set AF assist in the setup menu to Auto. Subject is not in focus area when shutter-release button is pressed halfway. Turn camera off and then on again. 	34, 39, 54 68 97,  75 26, 62 19
Colored stripes appear on the monitor when shooting.	Colored stripes may appear when shooting subjects with repeating patterns (such as window blinds); this is not a malfunction. The colored stripes will not appear in captured images or recorded movies. However, when using Continuous H: 120 fps , HS 240/8x or HS 480/4x , the colored stripes may be seen in the captured images and recorded movies.	–

Troubleshooting





Problem	Cause/Solution	
Pictures are blurred.	<ul style="list-style-type: none"> Use flash. Use vibration reduction or motion detection. Use BSS (Best Shot Selector). Use a tripod to stabilize the camera (use with the self-timer for better results). Specify a higher ISO sensitivity setting and resume shooting. 	50 97, 97 62 53 62,  37
Bright specks appear in pictures shot using flash.	Flash is reflecting off particles in air. Set the flash to  (off).	51
Flash does not fire.	<ul style="list-style-type: none"> Flash is set to  (off). A shooting mode where flash cannot fire is selected. Another function that is set now is restricting the flash. 	51 59 64
The digital zoom is not available.	<ul style="list-style-type: none"> Off or Crop is selected for Digital zoom in the setup menu. Digital zoom cannot be used with the following shooting modes. <ul style="list-style-type: none"> When the scene mode is  (Scene auto selector),  (Night landscape),  (Night portrait),  (Backlighting) with HDR set to On, Portrait, Easy panorama, Pet portrait or 3D photography. Smart portrait mode Other functions that restrict the use of digital zoom are set. 	97 34, 35, 36, 37, 38, 41, 42, 43 45 64
Image mode not available.	<ul style="list-style-type: none"> Another function that is set now is restricting Image mode. When the scene mode is set to Easy panorama or 3D photography, the image size is fixed. 	64 41, 43
No sound when shutter is released.	<ul style="list-style-type: none"> Off is selected for Shutter sound under Sound settings in the setup menu. Sports, Museum or Pet portrait is selected in scene mode. Other functions that restrict the use of the shutter sound are set. Do not block the speaker. 	97 38, 40, 42 64 1
AF-assist illuminator does not light.	Off is selected for AF assist in the setup menu. Even when Auto is set, AF-assist illuminator may not light depending on the focus area position or scene mode.	97
Pictures appear smeared.	Lens is dirty. Clean lens.	 6
Colors are unnatural.	White balance does not match light source.	62,  31
Ring-shaped or rainbow-colored bands are seen on the screen or the shot image.	When the subject is backlit or when shooting with an extremely bright light source in the display, such as in sunlight, ring-shaped or rainbow-colored bands may appear on the image. Change the position of the light source or remove it from the display, and try shooting again.	–





Problem	Cause/Solution	
The image taken becomes grainy.	As the subject is dark, shutter speed is too slow or ISO sensitivity is too high. <ul style="list-style-type: none"> • Use flash. • Specify a lower ISO sensitivity setting. 	50 62,  37
Pictures are too dark.	<ul style="list-style-type: none"> • Flash is set to  (off). • Flash window is blocked. • Subject is beyond flash range. • Adjust exposure compensation. • Raise the ISO sensitivity. • Subject is backlit. Set the scene mode to  (Backlighting) with HDR set to Off, or set the flash mode to  (fill flash). 	51 24 50 58 62,  37 37, 50
Pictures are too bright.	Adjust exposure compensation.	58
Areas not affected by red-eye are also corrected.	When  (auto with red-eye reduction) or “fill flash with red-eye reduction” of the  (Night portrait) scene mode is applied during shooting, In-Camera Red-Eye Fix may, in very rare cases, be applied to areas not affected by red-eye. Set the flash mode to other than  (auto with red-eye reduction), select a scene mode other than  (Night portrait), and resume shooting.	36, 50
Skin softening results are not as expected.	Skin softening may not produce the desired results depending on shooting conditions.	46
Saving images takes time.	It may take more time to save images in the following situations. <ul style="list-style-type: none"> • When the noise reduction function is in operation • When flash is set to  (auto with red-eye reduction) • When taking pictures in the following scene modes. <ul style="list-style-type: none"> - Hand-held in  (Night landscape),  (Night portrait) - HDR set to On in  (Backlighting) - Easy panorama • Continuous in the shooting menu is set to Pre-shooting cache, Continuous H: 120 fps or Continuous H: 60 fps • When using smile timer while shooting 	– 51 35 37 41 62,  34 63
Cannot set or use Continuous .	Another function that is set now is restricting Continuous .	64

Playback Issues



Problem	Cause/Solution	
File cannot be played back.	<ul style="list-style-type: none"> • File was overwritten or renamed by computer or another make or model of camera. • Movies recorded with cameras other than the COOLPIX S9500/S9400 cannot be played back. 	– 82
Cannot play a sequence.	<ul style="list-style-type: none"> • Pictures shot continuously with cameras other than the COOLPIX S9500/S9400 cannot be played as a sequence. • Check the Sequence display options setting. 	– 74,  58

Troubleshooting







Problem	Cause/Solution	
Cannot zoom in on picture.	<ul style="list-style-type: none"> Playback zoom cannot be used with movies, small picture, or cropped copies of size 320 × 240 pixels or smaller. Playback zoom may not be available for pictures taken with cameras other than the COOLPIX S9500/S9400. 3D images cannot be enlarged when the camera is connected via HDMI and they are played back in 3D. 	<p>–</p> <p>–</p> <p>43</p>
Cannot record or play back voice memo.	<ul style="list-style-type: none"> Voice memos cannot be attached to movies. Voice memos cannot be attached to pictures taken with cameras other than the COOLPIX S9500/S9400, and voice memos recorded by other cameras cannot be played back. 	<p>87</p> <p>74</p>
Pictures and movies cannot be edited.	<ul style="list-style-type: none"> Confirm the conditions that are required for editing pictures or movies. Pictures and movies taken with cameras other than the COOLPIX S9500/S9400 cannot be edited. 	<p>75, 14,</p> <p>27</p> <p>–</p>
Pictures are not displayed on television.	<ul style="list-style-type: none"> Video mode or HDMI is not correctly set in the TV settings setup menu. HDMI output is disabled when the camera is connected to either a computer or printer with a USB cable. Memory card contains no pictures. Replace memory card. Remove memory card to play back pictures from internal memory. 	<p>98,</p> <p>79</p> <p>77</p> <p>16</p>
Album icons are reset to their default icons, or images added to albums cannot be displayed in favorite pictures mode.	<p>Data saved in the internal memory or on the memory card may not be played back if overwritten by a computer.</p>	<p>–</p>
The saved images are not displayed in auto sort mode.	<ul style="list-style-type: none"> The desired image was sorted to a category other than the category currently displayed. Images saved by cameras other than the COOLPIX S9500/S9400 and images copied using the Copy option cannot be displayed in auto sort mode. Images saved in the internal memory or on the memory card may not be played back correctly if overwritten by a computer. Up to 999 images and movies in total can be added to each category. If the desired category already contains 999 images or movies in total, new images or movies cannot be added. 	<p>–</p>

Problem	Cause/Solution	
Nikon Transfer 2 does not start when camera is connected to a computer.	<ul style="list-style-type: none"> • Camera is off. • Battery is exhausted. • USB cable is not correctly connected. • Camera is not recognized by the computer. • Confirm that the operating system used is compatible with the camera. • Computer is not set to launch Nikon Transfer 2 automatically. For more information on Nikon Transfer 2, refer to help information contained in ViewNX 2. 	19 18 77 – 78 81
The PictBridge startup screen is not displayed when the camera is connected to a printer.	With some PictBridge-compatible printers, the PictBridge startup screen may not be displayed and it may be impossible to print images when Auto is selected for the Charge by computer option in the setup menu. Set the Charge by computer option to Off and reconnect the camera to the printer.	98,  80
Pictures to be printed are not displayed.	<ul style="list-style-type: none"> • Memory card contains no pictures. Replace memory card. • Remove memory card to print pictures from internal memory. • Pictures taken by 3D photography cannot be printed. 	16 17 43
Cannot select paper size with camera.	<p>Paper size cannot be selected from the camera in the following situations, even for PictBridge compatible printers. Use the printer to select paper size.</p> <ul style="list-style-type: none"> • The paper size selected using the camera is not compatible with the printer. • A printer that automatically sets the paper size is being used. 	 23,  24 –

GPS (COOLPIX S9500 only)

Problem	Cause/Solution	
Unable to identify the location or it takes time to identify the location.	<ul style="list-style-type: none"> • The camera may not be able to identify the location in some shooting environments. To use the GPS feature, use the camera as much as possible in an open-air area. • When positioning for the first time or when positioning was unable to be performed for about two hours, it takes a few minutes to obtain the positioning information. 	89 89
Unable to record position information on shot images.	When  or  is displayed on the shooting screen, the position information is not recorded. Before shooting pictures, make sure that the camera is receiving a GPS signal at sufficient strength.	90
Difference between the actual shooting location and recorded position information.	The acquired position information may deviate in some shooting environments. When there is a significant difference in the signals from the GPS satellites, there could be a deviation of up to several hundred meters.	89

Troubleshooting

Problem	Cause/Solution	
An incorrect location name is recorded or the correct location name is not displayed.	The desired landmark name may not be registered or an incorrect landmark name may be displayed.	–
Unable to update the A-GPS file.	<ul style="list-style-type: none"> • Check the following items. <ul style="list-style-type: none"> - Whether the memory card is inserted - Whether the A-GPS file is stored on the memory card - Whether the A-GPS file saved on the memory card is more recent than the A-GPS file saved in the camera - Whether the A-GPS file is still valid • The A-GPS file may be corrupted. Download the file from the website once more. 	–  60
Unable to select Create log in the GPS options menu.	Clock not set. Set date and time.	96,  69
Unable to select Start log .	<ul style="list-style-type: none"> • Record GPS data in GPS options of the GPS options menu is set to Off. • The camera is recording log data. To record a new log, select End log, and end the log currently being recorded. 	88 92,  62
Unable to save log data.	<ul style="list-style-type: none"> • Be sure that a memory card is inserted in the camera. • Up to 36 log data events can be recorded in a day. • Up to 100 log data events can be stored on a single memory card. Delete log data that is no longer required from a memory card or replace the memory card with a new one. 	– –  63,  64

Wi-Fi

Problem	Cause/Solution	
SSID (network name) of the camera is not displayed on the smart device.	Check whether the Wi-Fi network is set to On . Turn off the Wi-Fi function of the smart device and then turn it on again.	94

USER LICENSE AGREEMENT FOR LOCATION NAME DATA (COOLPIX S9500)

The location name data that are stored in COOLPIX S9500 ("Data") is provided for your personal, internal use only and not for resale. It is protected by copyright, and is subject to the following terms and conditions which are agreed to by you, on the one hand, and Nikon Corporation ("Nikon") and its licensors (including their licensors and suppliers) on the other hand.

Terms and Conditions

Personal Use Only. You agree to use this Data together with this digital camera and the image data taken by the digital camera for the solely personal, non-commercial purposes for which you were licensed, and not for service bureau, time-sharing or other similar purposes. Accordingly, but subject to the restrictions set forth in the following paragraphs, you agree not to otherwise reproduce, copy, modify, decompile, disassemble or reverse engineer any portion of this Data, and may not transfer or distribute it in any form, for any purpose, except to the extent permitted by mandatory laws.

Restrictions. Except where you have been specifically licensed to do so by Nikon, and without limiting the preceding paragraph, you may not (a) use this Data with any products, systems, or applications installed or otherwise connected to or in communication with vehicles, capable of vehicle navigation, positioning, dispatch, real time route guidance, fleet management or similar applications; or (b) with or in communication with any positioning devices or any mobile or wireless-connected electronic or computer devices, including without limitation cellular phones, palmtop and handheld computers, pagers, and personal digital assistants or PDAs.

Warning. The Data may contain inaccurate or incomplete information due to the passage of time, changing circumstances, sources used

and the nature of collecting comprehensive geographic data, any of which may lead to incorrect results.

No Warranty. This Data is provided to you "as is," and you agree to use it at your own risk. Nikon and its licensors (and their licensors and suppliers) make no guarantees, representations or warranties of any kind, express or implied, arising by law or otherwise, including but not limited to, content, quality, accuracy, completeness, effectiveness, reliability, fitness for a particular purpose, usefulness, use or results to be obtained from this Data, or that the Data or server will be uninterrupted or error-free.

Disclaimer of Warranty: NIKON AND ITS LICENSORS (INCLUDING THEIR LICENSORS AND SUPPLIERS) DISCLAIM ANY WARRANTIES, EXPRESS OR IMPLIED, OF QUALITY, PERFORMANCE, MERCHANTABILITY, FITNESS FOR A PARTICULAR PURPOSE OR NON-INFRINGEMENT. Some States, Territories and Countries do not allow certain warranty exclusions, so to that extent the above exclusion may not apply to you.

Disclaimer of Liability: NIKON AND ITS LICENSORS (INCLUDING THEIR LICENSORS AND SUPPLIERS) SHALL NOT BE LIABLE TO YOU: IN RESPECT OF ANY CLAIM, DEMAND OR ACTION, IRRESPECTIVE OF THE NATURE OF THE CAUSE OF THE CLAIM, DEMAND OR ACTION ALLEGING ANY LOSS, INJURY OR DAMAGES, DIRECT OR INDIRECT, WHICH MAY RESULT FROM THE USE OR POSSESSION OF THE INFORMATION; OR FOR ANY LOSS OF PROFIT, REVENUE, CONTRACTS OR SAVINGS, OR ANY OTHER DIRECT, INDIRECT, INCIDENTAL, SPECIAL OR CONSEQUENTIAL DAMAGES ARISING OUT OF YOUR USE OF OR INABILITY TO USE THIS INFORMATION, ANY DEFECT IN THE INFORMATION, OR THE BREACH OF THESE TERMS OR CONDITIONS, WHETHER IN AN ACTION IN CONTRACT OR TORT OR BASED ON A WARRANTY, EVEN IF NIKON OR ITS

USER LICENSE AGREEMENT FOR LOCATION NAME DATA (COOLPIX S9500)

LICENSORS HAVE BEEN ADVISED OF THE POSSIBILITY OF SUCH DAMAGES. Some States, Territories and Countries do not allow certain liability exclusions or damages limitations, so to that extent the above may not apply to you.

Export Control. You agree not to export from anywhere any part of the Data or any direct product thereof except in compliance with, and with all licenses and approvals required under, applicable export laws, rules and regulations, including but not limited to the laws, rules and regulations administered by the Office of Foreign Assets Control of the U.S. Department of Commerce and the Bureau of Industry and Security of the U.S. Department of Commerce. To the extent that any such export laws, rules or regulations prohibit Nikon and its licensors from complying with any of its obligations hereunder to deliver or distribute Data, such failure shall be excused and shall not constitute a breach of this Agreement.

Entire Agreement. These terms and conditions constitute the entire agreement between Nikon (and its licensors, including their licensors and suppliers) and you pertaining to the subject matter hereof, and supersedes in their entirety any and all written or oral agreements previously existing between us with respect to such subject matter.

Governing Law. The above terms and conditions shall be governed by the laws of the Japan, without giving effect to (i) its conflict of laws provisions, or (ii) the United Nations Convention for Contracts for the International Sale of Goods, which is explicitly excluded; provided that in the event that the laws of the Japan is not deemed applicable to this Agreement for any reason in the country where you obtained the Data, this Agreement shall be governed with the laws of the country where you obtained the Data. You agree to submit to the jurisdiction of Japan for any and all disputes, claims and actions arising from or in connection with the Data provided to you hereunder.

Government End Users. If the Data supplied by NAVTEQ is being acquired by or on behalf of

the United States government or any other entity seeking or applying rights similar to those customarily claimed by the United States government, the Data is a "commercial item" as that term is defined at 48 C.F.R. ("FAR") 2.101, is licensed in accordance with the End-User Terms under which this Data was provided, and each instruction manual accompanying the Client device containing a copy of the Data delivered or otherwise furnished shall be marked and embedded as appropriate with the following "Notice of Use," and shall be treated in accordance with such Notice:

Notice of Use
Contractor (Manufacturer/ Supplier) Name:
NAVTEQ
Contractor (Manufacturer/Supplier)
Address:
c/o Nokia 425 West Randolph Street,
Chicago, Illinois 60606
This Data is a commercial item as defined in
FAR 2.101 and is subject to the End-User
Terms under which this Data was provided.
© 2012 NAVTEQ - All rights reserved.

If the Contracting Officer, federal government agency, or any federal official refuses to use the legend provided herein, the Contracting Officer, federal government agency, or any federal official must notify NAVTEQ prior to seeking additional or alternative rights in the Data.

Notices related to licensed software copyright holders.

- Location name data for Japan



© 2012 ZENRIN CO., LTD. All rights reserved.

This service uses POI data of ZENRIN CO., LTD.

"ZENRIN" is a registered trademark of ZENRIN CO., LTD.

- Location name data except for Japan



© 1993-2012 NAVTEQ. All rights reserved.

NAVTEQ Maps is a trademark of NAVTEQ.

Austria	© Bundesamt für Eich- und Vermessungswesen
Croatia Cyprus Estonia Latvia Lithuania Moldova Poland Slovenia Ukraine	© EuroGeographics
France	source: © IGN 2009 - BD TOPO ®
Germany	"Die Grundlagendaten wurden mit Genehmigung der zuständigen Behörden entnommen"
Great Britain	Contains Ordnance Survey data © Crown copyright and database right 2010 Contains Royal Mail data © Royal Mail copyright and database right 2010
Greece	Copyright Geomatics Ltd.
Hungary	Copyright © 2003; Top-Map Ltd.
Italy	La Banca Dati Italiana è stata prodotta usando quale riferimento anche cartografia numerica ed al tratto prodotta e fornita dalla Regione Toscana.
Norway	Copyright © 2000; Norwegian Mapping Authority
Portugal	Source: IgeoE - Portugal
Spain	Información geográfica propiedad del CNIG
Sweden	Based upon electronic data © National Land Survey Sweden.
Switzerland	Topografische Grundlage: © Bundesamt für Landestopographie

USER LICENSE AGREEMENT FOR LOCATION NAME DATA (COOLPIX S9500)

Canada	This data includes information taken with permission from Canadian authorities, including © Her Majesty, © Queen's Printer for Ontario, © Canada Post, GeoBase ®, © Department of Natural Resources Canada. All rights reserved.
Mexico	Fuente: INEGI (Instituto Nacional de Estadística y Geografía.)
United States	© United States Postal Service ® 2012. Prices are not established, controlled or approved by the United States Postal Service ®. The following trademarks and registrations are owned by the USPS: United States Postal Service, USPS, and ZIP+4.
Australia	Copyright. Based on data provided under license from PSMA Australia Limited (www.psm.com.au). Product incorporates data which is © 2012 Telstra Corporation Limited, GM Holden Limited, Intelomatics Australia Pty Ltd and Continental Pty Ltd.
Nepal	Copyright © Survey Department, Government of Nepal.
Sri Lanka	This product incorporates original source digital data obtained from the Survey Department of Sri Lanka © 2009 Survey Department of Sri Lanka The data has been used with the permission of the Survey Department of Sri Lanka
Israel	© Survey of Israel data source
Jordan	"© Royal Jordanian Geographic Centre".
Mozambique	Certain Data for Mozambique provided by Cenacarta © 2012 by Cenacarta
Réunion	source: © IGN 2009 - BD TOPO ®
Ecuador	INSTITUTO GEOGRAFICO MILITAR DEL ECUADRO AUTORIZACION N° IGM-2011-01- PCO-01 DEL 25 DE ENERO DE 2011
Guadeloupe	source: © IGN 2009 - BD TOPO ®
Guatemala	Aprobado por el INSTITUTO GEOGRAFICO NACIONAL - Resolución del IGN N° 186-2011
French Guiana	source: © IGN 2009 - BD TOPO ®
Martinique	source: © IGN 2009 - BD TOPO ®
Mexico	Fuente: INEGI (Instituto Nacional de Estadística y Geografía)

Specifications

Nikon COOLPIX S9500 or COOLPIX S9400 Digital Camera

Type	Compact digital camera
Number of effective pixels	18.1 million
Image sensor	1/2.3-in. type CMOS; approx. 18.91 million total pixels
Lens	NIKKOR lens with 22× optical zoom (COOLPIX S9500)/18× optical zoom (COOLPIX S9400)
Focal length	COOLPIX S9500: 4.5-99.0 mm (angle of view equivalent to that of 25-550 mm lens in 35mm [135] format) COOLPIX S9400: 4.5-81.0 mm (angle of view equivalent to that of 25-450 mm lens in 35mm [135] format)
f/-number	f/3.4-6.3
Construction	12 elements in 10 groups (1 ED lens element)
Digital zoom magnification	Up to 4× (angle of view equivalent to that of approx. 2200 mm (COOLPIX S9500)/approx. 1800 mm (COOLPIX S9400) lens in 35mm [135] format)
Vibration reduction	Combination of lens shift and electronic VR (still pictures) Lens shift (movies)
Motion blur reduction	Motion detection (still pictures)
Autofocus (AF)	Contrast-detect AF
Focus range	<ul style="list-style-type: none">[W]: Approx. 50 cm (1 ft 8 in.) - ∞,[T]: Approx. 1.5 m (5 ft) - ∞• Macro mode: Approx. 1 cm (0.4 in.) (at a wide-angle zoom position) - ∞ (All distances measured from center of front surface of lens)
Focus-area selection	Face priority, center, manual with 99 focus areas, subject tracking, target finding AF
Monitor	7.5 cm (3-in.), approx. 614k-dot, wide viewing angle OLED monitor with anti-reflection coating and 5-level brightness adjustment
Frame coverage (shooting mode)	Approx. 98% horizontal and 98% vertical (compared to actual picture)
Frame coverage (playback mode)	Approx. 100% horizontal and 100% vertical (compared to actual picture)
Storage	
Media	Internal memory (COOLPIX S9500: approx. 23 MB) (COOLPIX S9400: approx. 65 MB) SD/SDHC/SDXC memory card
File system	DCF, Exif 2.3, DPOF, and MPF compliant
File formats	Still pictures: JPEG 3D images: MPO Sound files (voice memo): WAV Movies: MOV (Video: H.264/MPEG-4 AVC, Audio: AAC stereo)

Specifications

Image size (pixels)	<ul style="list-style-type: none"> • 18M (High) 4896×3672★ • 18M 4896×3672 • 8M 3264×2448 • 4M 2272×1704 • 2M 1600×1200 • VGA 640×480 • 16:9 13M 4864×2736
ISO sensitivity (Standard output sensitivity)	<ul style="list-style-type: none"> • ISO 125-1600 • ISO 3200 (available when using Auto mode)
Exposure	
Metering mode	Matrix, center-weighted, spot (when digital zoom is 2x or higher)
Exposure control	Programmed auto exposure and exposure compensation (-2.0 – +2.0 EV in steps of 1/3 EV)
Shutter	Mechanical and CMOS electronic shutter
Speed	<ul style="list-style-type: none"> • 1/1500 - 1 s • 1/4000 - 1/120 s (Continuous H: 120 fps) • 1/4000 - 1/60 s (Continuous H: 60 fps) • 4 s (Fireworks show scene mode)
Aperture	Electronically-controlled ND filter (-2 AV) selection mode
Range	2 steps (f/3.4, f/6.8 [W])
Self-timer	Durations of 2 or 10 seconds can be selected
Flash	
Range (approx.) (ISO sensitivity: Auto)	[W]: 0.5 - 6.0 m (1 ft 8 in. - 19 ft) [T]: 1.5 - 3.5 m (5 - 11 ft)
Flash control	TTL auto flash with monitor pre-flashes
Interface	Hi-Speed USB
Data transfer protocol	MTP, PTP
Video output	Can be selected from NTSC and PAL
HDMI output	Can be selected from Auto, 480p, 720p, and 1080i
I/O terminal	<ul style="list-style-type: none"> • Audio/video output; digital I/O (USB) • HDMI micro connector (Type D) (HDMI output)

Wi-Fi (Wireless LAN) (COOLPIX S9500 only)	
Standards	IEEE 802.11b/g/n (standard wireless LAN protocol), ARIB STD-T66 (standard for low power data communications systems)
Communications protocols	IEEE 802.11b: DBPSK, DQPSK, CCK IEEE 802.11g: OFDM IEEE 802.11n: OFDM
Range (line of sight)	Approx. 30 m (32 yd) (varies with location)
Operating frequency	2412-2462 MHz (1-11 channels)
Data rates (actual measured values)	IEEE 802.11b: 5 Mbps IEEE 802.11g: 12 Mbps IEEE 802.11n: 12 Mbps
Security	OPEN/WPA2
Access protocols	CSMA/CA
Electronic compass (COOLPIX S9500 only)	16 cardinal points (position correction using 3-axis acceleration sensor, automatic correction for the deviated angle, and automatic offset adjustment)
GPS (COOLPIX S9500 only)	Receiver frequency 1575.42 MHz (C/A code), geodetic system WGS 84
Supported languages	Arabic, Bengali, Chinese (Simplified and Traditional), Czech, Danish, Dutch, English, Finnish, French, German, Greek, Hindi, Hungarian, Indonesian, Italian, Japanese, Korean, Marathi, Norwegian, Persian, Polish, Portuguese (European and Brazilian), Romanian, Russian, Spanish, Swedish, Tamil, Telugu, Thai, Turkish, Ukrainian, Vietnamese
Power sources	<ul style="list-style-type: none"> • One Rechargeable Li-ion Battery EN-EL12 (included) • AC Adapter EH-62F (available separately)
Charging time	Approx. 3 h and 50 min (when using Charging AC Adapter EH-70P and when no charge remains)
Battery life¹	
Still pictures	Approx. 230 shots when using EN-EL12
Movie recording (actual battery life for recording)²	Approx. 50 min when using EN-EL12
Tripod socket	1/4 (ISO 1222)
Dimensions (W × H × D)	Approx. 110.1 × 60.3 × 30.7 mm (4.4 × 2.4 × 1.3 in.) (excluding projections)
Weight	COOLPIX S9500: approx. 205 g (7.3 oz) (including battery and SD memory card) COOLPIX S9400: approx. 200 g (7.1 oz) (including battery and SD memory card)
Operating environment	
Temperature	0°C - 40°C (32°F - 104°F)
Humidity	85% or less (no condensation)

Specifications

- Unless otherwise stated, all figures assume a fully-charged battery and an ambient temperature of $23 \pm 3^{\circ}\text{C}$ ($73.4 \pm 5.4^{\circ}\text{F}$) as specified by the Camera and Imaging Products Association (CIPA) standards.

¹ Figures based on the Camera and Imaging Products Association (CIPA) standards for measuring the endurance of camera batteries. Performance for still pictures measured under the following test conditions: **18M 4896x3672** selected for Image mode, zoom adjusted with each shot, and flash fired with every other shot. Movie recording time assumes that **1080 60p 1080★/30p** is selected for Movie options. The values may vary depending on operating conditions such as the interval between shots and the length of time menus and images are displayed.

² Individual movie files cannot exceed 4 GB in size or 29 minutes in length. Recording may end before this limit is reached if camera temperature becomes elevated.

Rechargeable Li-ion Battery EN-EL12

Type	Rechargeable lithium-ion battery
Rated capacity	DC 3.7 V, 1050 mAh
Operating temperature	0°C - 40°C (32°F - 104°F)
Dimensions (W × H × D)	Approx. 32 × 43.8 × 7.9 mm (1.3 × 1.7 × 0.3 in.)
Weight	Approx. 22.5 g (0.8 oz) (excluding terminal cover)

Charging AC Adapter EH-70P

Rated input	AC 100-240 V, 50/60 Hz, 0.07-0.044 A
Rated output	DC 5.0 V, 550 mA
Operating temperature	0°C - 40°C (32°F - 104°F)
Dimensions (W × H × D)	Approx. 55 × 22 × 54 mm (2.2 × 0.9 × 2.2 in.) (excluding plug adapter) For Argentina: Approx. 55 × 59 × 63 mm (2.2 × 2.4 × 2.5 in.) For Korea: Approx. 55 × 59 × 66.5 mm (2.2 × 2.4 × 2.7 in.)
Weight	Approx. 47 g (1.7 oz) (excluding plug adapter) For Argentina and Korea: Approx. 72 g (2.6 oz)

Specifications

- Nikon will not be held liable for any errors this manual may contain.
- The appearance of this product and its specifications are subject to change without notice.

Supported Standards

- **DCF:** Design Rule for Camera File System is a standard widely used in the digital camera industry to ensure compatibility among different makes of camera.
- **DPOF:** Digital Print Order Format is an industry-wide standard that allows pictures to be printed at a digital photo lab or with a household printer from print orders stored on the memory card.
- **Exif version 2.3:** This camera supports Exif (Exchangeable Image File Format for Digital Still Cameras) version 2.3, a standard that allows information stored with photographs to be used for optimal color reproduction when images are output from Exif-compliant printers.
See the instruction manual of the printer for further details.
- **PictBridge:** A standard developed cooperatively by the digital camera and printer industries, allowing photographs to be output directly to a printer without connecting the camera to a computer.

AVC Patent Portfolio License

This product is licensed under the AVC Patent Portfolio License for the personal and non-commercial use of a consumer to (i) encode video in compliance with the AVC standard ("AVC video") and/or (ii) decode AVC video that was encoded by a consumer engaged in a personal and non-commercial activity and/or was obtained from a video provider licensed to provide AVC video. No license is granted or shall be implied for any other use. Additional information may be obtained from MPEG LA, L.L.C.

See <http://www.mpegla.com>.

FreeType License (FreeType2)

Portions of this software are copyright © 2013 The FreeType Project ("www.freetype.org"). All rights reserved.

MIT License (Harfbuzz)

Portions of this software are copyright © 2013 The Harfbuzz Project ("<http://www.freedesktop.org/wiki/Software/HarfBuzz>"). All rights reserved.

Trademark Information

- Microsoft, Windows and Windows Vista are either registered trademarks or trademarks of Microsoft Corporation in the United States and/or other countries.
- Macintosh, Mac OS, and QuickTime are trademarks of Apple Inc., registered in the U.S. and other countries. The iFrame logo and the iFrame symbol are trademarks of Apple Inc.
- Adobe and Acrobat are registered trademarks of Adobe Systems Inc.
- SDXC, SDHC and SD Logos are trademarks of SD-3C, LLC.
- PictBridge is a trademark.
- HDMI, HDMI logo and High-Definition Multimedia Interface are trademarks or registered trademarks of HDMI Licensing LLC.

HDMI

- Wi-Fi and the Wi-Fi logo are trademarks or registered trademarks of the Wi-Fi Alliance.
- Android and Google Play are trademarks or registered trademarks of Google Inc.
- All other trade names mentioned in this manual or the other documentation provided with your Nikon product are trademarks or registered trademarks of their respective holders.

Index

Symbols

AE/AF-L 43

Adjusting Brightness 58

Apply selection button 4

Auto mode 31

Auto sort mode 71, 8

Backlighting 37

Delete button 29, 87, 12, 56

Exposure compensation 49

Favorite pictures mode 71, 5

Flash mode 49, 50

List by Date Mode 71, 10

Macro mode 49, 54

MENU Menu button 6, 61, 73, 86, 91, 96

Night landscape 35

Night portrait 36

Playback button 4, 28

Playback zoom 69

Scene auto selector 34

SCENE Scene mode 33

Self-timer 49, 53

Smart portrait mode 45

EFFECTS Special effects mode 47

T Tele 25

Thumbnail display 70

W Wide 25

(movie-record) button 82

JPG 97

.MOV 97

.MPO 97

.WAV 97

Numerics

3D photography **3D** 43

A

AC adapter 15, 99

AF area mode 62, 38

AF assist 97, 75

AF/access lamp 26

A-GPS file 91, 59

Album 5, 7

Aperture value 27

Audio/video cable 77, 20

Audio/video-in jack 77, 20

Auto 51

Auto off 19, 97, 77

Auto sort mode 71, 8

Auto with red-eye reduction 51, 52

Autofocus 54, 62, 86, 41, 49

Autofocus mode 62, 86, 41, 49

AV cable 77, 20

B

Backlighting 37

Battery 12, 14

Battery charger 12, 15, 99

Battery latch 12

Battery level indicator 18

Battery-chamber/memory card slot cover 12, 16

Beach 39

Best shot selector 40, 34

Black and white copy 41

Blink proof 63, 44

Blink warning 98, 82

Brightness (exposure compensation) 55

BSS 40, 62, 34

Button sound 97, 77

C

Calendar display 70

Camera strap 5

Charge by computer 98, 80

Charge lamp 14

Charger 15

Charging AC Adapter 14

Choose key picture 74, 58

Close-up 39

Compression ratio 29

Computer 77, 80











Continuous 62, 34

Contrast 16







Create log 62

Creative slider 55
 Crop 19, 27

















D







Date and time 20, 68
 Daylight saving time 20, 69
 Delete 29, 87, 12, 56
 Digital zoom 25, 97, 76
 Direct Print 77, 22
 D-Lighting 74, 16
 DPOF printing 25
 DSCN 97
 Dusk/dawn 39

E

Easy panorama 41, 2
 Editing movies 27
 Editing pictures 13
 Electronic compass 92, 65
 Exposure compensation 49, 57
 Extension 97
 Eye-Fi upload 98, 85

F









Face detection 67
 Face priority 62, 38
 Fast motion movies 85, 47
 Favorite pictures 74, 5
 Favorite pictures mode 71, 5
 Features not available in combination 64
 File name 97
 Fill flash 51
 Filmstrip 98, 86
 Fireworks show 40
 Firmware version 98, 90
 Fixed auto range 37
 Flash 50
 Flash mode 50, 51
 Focal length 19
 Focus 26, 38, 41, 49
 Focus area 26, 38
 Focus lock 68
 Folder name 97
 Food 40
 Format 16, 97, 78

Format the internal memory 97, 78
 Format the memory card 16, 97, 78
 Framing grid 96, 71
 FSCN 97
 Full-frame playback 28
 Full-time AF 62, 86, 41, 49





G

Glamour retouch 74, 17
 GPS 88
 GPS options 91, 59
 GPS options menu 91, 59





H

HDMI 77, 98, 20, 79
 HDMI 3D output 98, 79
 HDMI device control 98, 79
 HDMI micro connector 77, 20
 HDR 37
 Help Information 33
 High-speed continuous 62, 34
 Histogram 57
 HS movie 85, 46, 47
 Hue 55



I

Identifier 97
 Image copy 74, 57
 Image mode 62, 63, 29
 Internal memory indicator 18
 ISO sensitivity 62, 37

L

Landscape 38
 Language 97, 78
 Lens 1, 6, 19
 Lens cover 1
 List by date mode 71, 10

M

Macro mode 49, 54
 Memory capacity 18
 Memory card 16, 17
 Memory card slot 16
 Metering 62, 33
 Microphone 1, 74, 82, 86, 50, 56

Index

Mode dial 22, 33
Monitor 8, 10, 6
Monitor brightness 96, 70
Monitor settings 96, 70
Motion detection 97, 74
Movie length 82, 47
Movie mode 82
Movie options 86, 45
Movie playback 87
Movie recording 82
Multi selector 3, 4, 49
Multi-shot 16 62, 35
Museum 40

N
Night landscape 35
Night portrait 36
Number of exposures remaining 18, 30

O
Off 51
Open with HS footage 86, 49
Optical zoom 25
Optional accessories 99







P
Paper size 26
Party/indoor 38
Pet portrait auto release 42
Pet portrait 42
Photo info 96, 70
PictBridge 77, 22, 23
Playback 28, 71, 87, 56
Playback menu 73, 51
Playback mode 28, 71
Playback zoom 69
Points of interest (POI) 90, 91, 61
Portrait 38
Power 18, 19, 20
Power switch/power-on lamp 19
Preset manual 32
Pre-shooting cache 62, 34
Pressing halfway 3, 26
Print 22, 23, 24

Print date 96, 72
Print order 74, 51
Print order date option 52
Printer 77, 22
Protect 74, 55





Q
Quick effects 32, 62, 15, 42
Quick retouch 74, 16

R
Recording slow motion movies 85, 47
Remove from favorites 74, 6
Reset all 98, 87
Rotary multi selector 3, 4, 49
Rotate image 74, 55
RSCN 97



S
Scene mode 33
Scroll 4
Self-timer 49, 53
Self-timer lamp 53
Sequence 28, 11
Sequence display options 74, 58
Setup menu 96, 67
Shooting 22
Shooting date information 8
Shooting menu 61, 29
Shooting mode 23
Shutter sound 97, 77
Shutter speed 27
Shutter-release button 3, 26
Single 62, 34
Single AF 62, 86, 41, 49
Skin softening 46, 63, 43
Slide show 74, 54
Slow sync 51
Small picture 74, 18
Smart portrait menu 63, 43
Smart portrait mode 45
Smile timer 45, 63, 43
Snow 39
Sound settings 97, 77

Special effects mode 47
Sports  38
SSCN  97
Subject tracking 62,  39,  40
Sunset  39
Switching between menu icons 7
Synchronize 92,  64





I

Target finding AF 62, 66,  39
Tele 25
Thumbnail playback 70
Time difference  69
Time zone 20,  69
Time zone and date 20, 96,  68
Tripod socket 2
TV settings 98,  79





U

USB cable 77, 80,  22
USB/Audio video connector 77, 80,
 20,  22
Using the screen for selecting images 76

V

Vibration reduction 97,  73
Video mode 98,  79
View log 92,  64
ViewNX 2 78
Vividness 55
Voice memo 74,  56
Volume 87

W

Welcome screen 96,  67
White balance 62,  31
Wide 25
Wi-Fi options 98,  83
Wind noise reduction 86,  50

Z

Zoom 25
Zoom control 25



A series of horizontal dashed lines spanning the width of the page, intended for handwriting practice. There are 15 lines in total, starting from the top right and extending to the bottom left.



A series of horizontal dashed lines for handwriting practice, starting from the first line below the pen illustration and extending to the bottom of the page.

No reproduction in any form of this manual, in whole or in part (except for brief quotation in critical articles or reviews), may be made without written authorization from NIKON CORPORATION.