

***Nikon***

DIGITAL CAMERA

# COOLPIX S32

## Reference Manual

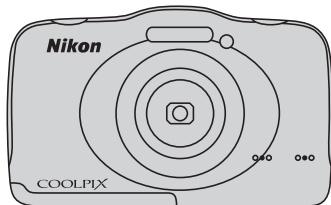

En

# Waterproofing

The following are important notes about the camera's waterproofing. Before using the camera, please thoroughly read the information in "<Important> Shockproof, Waterproof, Dustproof, Condensation" (📖 xv).

## Waterproofing-related Messages

The camera will display messages related to its waterproof capabilities when you select certain settings or perform certain operations. Read and follow the information displayed in the messages when they are displayed.

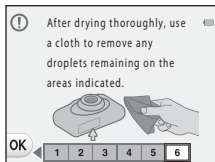
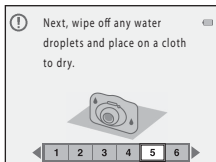
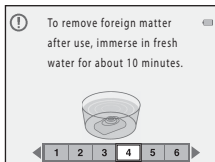
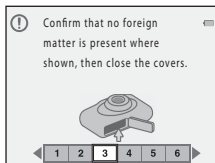
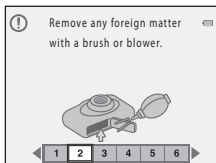
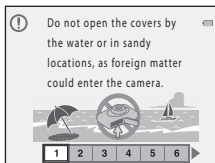

Waterproofing-related messages are displayed in the following situations.

- When turning on and setting the camera for the first time
- When setting the camera to **Shoot under water** (📖 39)
- When turning the camera on after charging

Note: If the cover is closed without removing foreign particles, water may seep inside the camera or the camera may become damaged. Make sure to inspect and clean the cover.

<b>Introduction</b>	
<b>Parts of the Camera</b>	
<b>The Basics of Shooting and Playback</b>	
<b>Shooting Features</b>	
<b>Playback Features</b>	
<b>Recording and Playing Back Movies</b>	
<b>General Camera Setup</b>	
<b>Connecting the Camera to a TV, Computer, or Printer</b>	
<b>Reference Section</b>	
<b>Technical Notes and Index</b>	

# Introduction

## Read This First

Thank you for purchasing the Nikon COOLPIX S32 digital camera. Before using the camera, please read the information in "For Your Safety" (📖 viii-xi) and "<Important> Shockproof, Waterproof, Dustproof, Condensation" (📖 xv-xxi), and familiarize yourself with the information provided in this manual. After reading, please keep this manual handy and refer to it to enhance your enjoyment of your new camera.

## About This Manual





If you want to start using the camera right away, see “The Basics of Shooting and Playback” (📖 8).

To learn about the parts of the camera and basic operations, see “Parts of the Camera” (📖 1).

## Other Information

- Symbols and Conventions

To make it easier to find the information you need, the following symbols and conventions are used in this manual:

Icon	Description
	This icon indicates cautions and information that should be read before using the camera.
	This icon indicates notes and information that should be read before using the camera.
	These icons indicate other pages containing relevant information;  : "Reference Section",  : "Technical Notes and Index."

- SD, SDHC, and SDXC memory cards are referred to as "memory cards" in this manual.
- The setting at the time of purchase is referred to as the "default setting."
- The names of menu items displayed in the camera monitor, and the names of buttons or messages displayed on a computer monitor appear in bold.
- In this manual, images are sometimes omitted from monitor display samples so that monitor indicators can be more clearly shown.
- Illustrations and monitor content shown in this manual may differ from the actual product.

# Information and Precautions

## Life-Long Learning

As part of Nikon's "Life-Long Learning" commitment to ongoing product support and education, continually updated information is available online at the following sites:

- For users in the U.S.A.: <http://www.nikonusa.com/>
- For users in Europe and Africa: <http://www.europe-nikon.com/support/>
- For users in Asia, Oceania, and the Middle East: <http://www.nikon-asia.com/>

Visit these sites to keep up-to-date with the latest product information, tips, answers to frequently asked questions (FAQs), and general advice on digital imaging and photography. Additional information may be available from the Nikon representative in your area. Visit the site below for contact information:

<http://imaging.nikon.com/>

## Use Only Nikon Brand Electronic Accessories

Nikon COOLPIX cameras are designed to the highest standards and include complex electronic circuitry. Only Nikon brand electronic accessories (including battery chargers, batteries, Charging AC adapters, and AC adapters) certified by Nikon specifically for use with this Nikon digital camera are engineered and proven to operate within the operational and safety requirements of this electronic circuitry.

THE USE OF NON-NIKON ELECTRONIC ACCESSORIES COULD DAMAGE THE CAMERA AND MAY VOID YOUR NIKON WARRANTY.

The use of third-party rechargeable Li-ion batteries not bearing the Nikon holographic seal could interfere with normal operation of the camera or result in the batteries overheating, igniting, rupturing, or leaking.

For more information about Nikon brand accessories, contact a local authorized Nikon dealer.

**Holographic seal:** Identifies this device as an authentic Nikon product.



## Before Taking Important Pictures

Before taking pictures on important occasions (such as at weddings or before taking the camera on a trip), take a test shot to ensure that the camera is functioning normally. Nikon will not be held liable for damages or lost profits that may result from product malfunction.

## About the Manuals

- No part of the manuals included with this product may be reproduced, transmitted, transcribed, stored in a retrieval system, or translated into any language in any form, by any means, without Nikon's prior written permission.
- Nikon reserves the right to change the specifications of the hardware and software described in these manuals at any time and without prior notice.
- Nikon will not be held liable for any damages resulting from the use of this product.
- While every effort was made to ensure that the information in these manuals is accurate and complete, we would appreciate it were you to bring any errors or omissions to the attention of the Nikon representative in your area (address provided separately).

## Notice Concerning Prohibition of Copying or Reproduction

Note that simply being in possession of material that was digitally copied or reproduced by means of a scanner, digital camera or other device may be punishable by law.

### • **Items prohibited by law from being copied or reproduced**

Do not copy or reproduce paper money, coins, securities, government bonds or local government bonds, even if such copies or reproductions are stamped "Sample." The copying or reproduction of paper money, coins, or securities which are circulated in a foreign country is prohibited. Unless the prior permission of the government was obtained, the copying or reproduction of unused postage stamps or post cards issued by the government is prohibited.

The copying or reproduction of stamps issued by the government and of certified documents stipulated by law is prohibited.

### • **Cautions on certain copies and reproductions**

The government has issued cautions on copies or reproductions of securities issued by private companies (shares, bills, checks, gift certificates, etc.), commuter passes, or coupon tickets, except when a minimum of necessary copies are to be provided for business use by a company. Also, do not copy or reproduce passports issued by the government, licenses issued by public agencies and private groups, ID cards and tickets, such as passes and meal coupons.

### • **Comply with copyright notices**

The copying or reproduction of copyrighted creative works such as books, music, paintings, woodcut prints, maps, drawings, movies, and photographs is governed by national and international copyright laws. Do not use this product for the purpose of making illegal copies or to infringe copyright laws.



## Disposing of Data Storage Devices

Please note that deleting images or formatting data storage devices such as memory cards or built-in camera memory does not completely erase the original image data. Deleted files can sometimes be recovered from discarded storage devices using commercially available software, potentially resulting in the malicious use of personal image data. Ensuring the privacy of such data is the user's responsibility.

Before discarding a data storage device or transferring ownership to another person, erase all data using commercial deletion software, or format the device and then completely refill it with images containing no private information (for example, pictures of empty sky). Care should be taken to avoid injury or damage to property when physically destroying data storage devices.

## For Your Safety

To prevent damage to your Nikon product or injury to yourself or to others, read the following safety precautions in their entirety before using this equipment. Keep these safety instructions where all those who use the product will read them.



This icon marks warnings, information that should be read before using this Nikon product, to prevent possible injury.

### WARNINGS

#### **Turn off in the event of malfunction**

Should you notice smoke or an unusual smell coming from the camera or Charging AC Adapter, unplug the Charging AC Adapter and remove the battery immediately, taking care to avoid burns. Continued operation could result in injury. After removing or disconnecting the power source, take the equipment to a Nikon-authorized service representative for inspection.

#### **Do not disassemble**

Touching the internal parts of the camera or Charging AC Adapter could result in injury. Repairs should be performed only by qualified

technicians. Should the camera or Charging AC Adapter break open as the result of a fall or other accident, take the product to a Nikon-authorized service representative for inspection, after unplugging the product and/or removing the battery.

#### **Do not use the camera or Charging AC Adapter in the presence of flammable gas**

Do not use electronic equipment in the presence of flammable gas, as this could result in explosion or fire.

#### **Handle the camera strap with care**

Never place the strap around the neck of an infant or child.

** Keep out of reach of children**

Particular care should be taken to prevent infants from putting the battery, brush, or other small parts into their mouths.

** Do not remain in contact with the camera, Charging AC Adapter, or AC adapter for extended periods while the devices are on or in use**

Parts of the devices become hot. Leaving the devices in direct contact with the skin for extended periods may result in low-temperature burns.

** Do not leave the product where it will be exposed to extremely high temperatures, such as in an enclosed automobile or in direct sunlight**

Failure to observe this precaution could cause damage or fire.

** Observe caution when handling the battery**

The battery may leak, overheat, or explode if improperly handled. Observe the following precautions when handling the battery for use in this product:

- Before replacing the battery, turn the product off. If you are using the Charging AC Adapter/AC adapter, be sure it is unplugged.
- Use only a Rechargeable Li-ion Battery EN-EL19 (included). Charge the battery by using a camera that supports battery charging or by using a Battery Charger MH-66 (available separately). To charge the battery with the camera, use either Charging AC Adapter EH-70P (included) or the **Charge by computer** function.
- When inserting the battery, do not attempt to insert it upside down or backwards.
- Do not short or disassemble the battery or attempt to remove or break battery insulation or casing.
- Do not expose the battery to flame or to excessive heat.

- Do not immerse in or expose to water.
  - Put the battery in a plastic bag before transporting it. Do not transport or store with metal objects such as necklaces or hairpins.
  - The battery is prone to leakage when fully discharged. To avoid damage to the product, be sure to remove the battery when no charge remains.
  - Discontinue use immediately should you notice any change in the battery, such as discoloration or deformation.
  - If liquid from the damaged battery comes in contact with clothing or skin, rinse immediately with plenty of water.
-  **Observe the following precautions when handling the Charging AC Adapter**
- Keep dry. Failure to observe this precaution could result in fire or electric shock.
  - Dust on or near the metal parts of the plug should be removed with a dry cloth. Continued use could result in fire.
- Do not handle the plug or go near the Charging AC Adapter during lightning storms. Failure to observe this precaution could result in electric shock.
  - Do not damage, modify, forcibly tug or bend the USB cable, place it under heavy objects, or expose it to heat or flames. Should the insulation be damaged and the wires become exposed, take it to a Nikon-authorized service representative for inspection. Failure to observe these precautions could result in fire or electric shock.
  - Do not handle the plug or Charging AC Adapter with wet hands. Failure to observe this precaution could result in electric shock.
  - Do not use with travel converters or adapters designed to convert from one voltage to another or with DC-to-AC inverters. Failure to observe this precaution could damage the product or result in overheating or fire.

** Use appropriate cables**

When connecting cables to the input and output jacks, use only the cables provided or sold by Nikon for the purpose, to maintain compliance with product regulations.

** Handle moving parts with care**

Be careful that your fingers or other objects are not pinched by the lens cover or other moving parts.

** Observe caution when using the flash**

Using the flash close to your subject's eyes could cause temporary visual impairment. The flash should be no less than 1 m (3 ft 4 in.) from the subject. Particular care should be observed when photographing infants.

** Do not operate the flash with the flash window touching a person or object**

Failure to observe this precaution could result in burns or fire.

** Avoid contact with liquid crystal**

Should the monitor break, care should be taken to avoid injury caused by broken glass and to prevent liquid crystal from the monitor touching the skin or entering the eyes or mouth.

** Turn the power off when using inside an airplane or the hospital**

Turn the power off while inside the airplane during take off or landing. Follow the instructions of the hospital when using while in a hospital.

The electromagnetic waves emitted by this camera may disrupt the electronic systems of the airplane or the instruments of the hospital.

## Notices

### **Notice for Customers in the U.S.A.**

#### **IMPORTANT SAFETY INSTRUCTIONS -**

#### **SAVE THESE INSTRUCTIONS.**

#### **DANGER - TO REDUCE THE RISK OF FIRE OR ELECTRIC SHOCK, CAREFULLY FOLLOW THESE INSTRUCTIONS**

For connection to a supply not in the U.S.A., use an attachment plug adapter of the proper configuration for the power outlet if needed. The power supply unit is intended to be correctly orientated in a vertical or floor mount position.

#### **Federal Communications Commission (FCC) Radio Frequency Interference Statement**

This equipment has been tested and found to comply with the limits for a Class B digital device, pursuant to Part 15 of the FCC rules. These limits are designed to provide reasonable protection against harmful interference in a residential installation. This

equipment generates, uses, and can radiate radio frequency energy and, if not installed and used in accordance with the instructions, may cause harmful interference to radio communications. However, there is no guarantee that interference will not occur in a particular installation. If this equipment does cause harmful interference to radio or television reception, which can be determined by turning the equipment off and on, the user is encouraged to try to correct the interference by one or more of the following measures:

- Reorient or relocate the receiving antenna.
- Increase the separation between the equipment and receiver.
- Connect the equipment into an outlet on a circuit different from that to which the receiver is connected.
- Consult the dealer or an experienced radio/television technician for help.



**Nikon**

**COOLPIX S32**

## CAUTIONS

### Modifications

The FCC requires the user to be notified that any changes or modifications made to this device that are not expressly approved by Nikon Corporation may void the user's authority to operate the equipment.

### Interface Cables

Use the interface cables sold or provided by Nikon for your equipment. Using other interface cables may exceed the limits of Class B Part 15 of the FCC rules.

### Notice for customers in the State of California

#### WARNING

Handling the cord on this product will expose you to lead, a chemical known to the State of California to cause birth defects or other reproductive harm.

#### ***Wash hands after handling.***

Nikon Inc.,  
1300 Walt Whitman Road Melville,  
New York 11747-3064 USA  
Tel: 631-547-4200

### Notice for customers in Canada

CAN ICES-3 B / NMB-3 B

## Notice for Customers in Europe

### CAUTIONS

### **RISK OF EXPLOSION IF BATTERY IS REPLACED BY AN INCORRECT TYPE.**

### **DISPOSE OF USED BATTERIES ACCORDING TO THE INSTRUCTIONS.**

This symbol indicates that electrical and electronic equipment is to be collected separately.



The following apply only to users in European countries:

- This product is designated for separate collection at an appropriate collection point. Do not dispose of as household waste.
- Separate collection and recycling helps conserve natural resources and prevent negative consequences for human health and the environment that might result from incorrect disposal.
- For more information, contact the retailer or the local authorities in charge of waste management.

This symbol on the battery indicates that the battery is to be collected separately.



The following apply only to users in European countries:

- All batteries, whether marked with this symbol or not, are designated for separate collection at an appropriate collection point. Do not dispose of as household waste.
- For more information, contact the retailer or the local authorities in charge of waste management.



## <Important> Shockproof, Waterproof, Dustproof, Condensation

- Make sure to read the following instructions as well as the instructions provided in “Caring for the Product” (p. 2).

### Notes About Shockproof Performance

This camera has passed Nikon’s in-house test (drop test from a height of 1.5 m (5 ft) on a 5 cm (2 in.) thick plywood panel) compliant with MIL-STD 810F Method 516.5-Shock\*.

This test does not guarantee the waterproof performance of the camera or that the camera will be free from damage or trouble under all conditions.

Changes in appearance, such as paint peeling off and deformation of the drop shock portion are not subject to the Nikon’s in-house test.

\* U.S. Department of Defense test method standard.

This drop test drops 5 cameras in 26 directions (8 edges, 12 corners, and 6 faces) from a height of 122 cm (48 in.) to make sure that one to five cameras pass the test (if any defect is detected during the test, another five cameras are tested to make sure that the test criteria are satisfied for one to five cameras).

### ● Do not subject the camera to excessive shock, vibration or pressure by dropping or hitting it.

Failure to observe this precaution could cause water to seep inside the camera and result in camera malfunction.

- Do not use the camera deeper than 10 m (33 ft) underwater.
- Do not subject the camera to water pressure by exposing it to high-pressure running water.
- Do not sit down with the camera in the pocket of your trousers.  
Do not forcibly stuff the camera into a bag.

## Notes About Waterproof and Dustproof Performances

The camera is equivalent to IEC/JIS waterproof grade 8 (IPX8) and IEC/JIS dustproof grade 6 (IP6X) and enables shooting pictures underwater at a depth of 10 m (33 ft) for up to 60 minutes.\*

This rating does not guarantee the waterproof performance of the camera or that the camera will be free from damage or trouble under all conditions.

\* This rating indicates that the camera has been designed to withstand the specified water pressure for the specified period of time when the camera is used according to the methods defined by Nikon.

### ● If the camera is subjected to excessive shock, vibration or pressure by dropping or hitting it, the waterproof performance is not guaranteed.

- If the camera is exposed to shocks, it is recommended to consult your retailer or Nikon-authorized service representative to confirm the waterproof performance (charged service).
  - Do not use the camera deeper than 10 m (33 ft) underwater.
  - Do not subject the camera to water pressure by exposing it to rapid flowing water or waterfalls.
  - Your Nikon warranty may not cover troubles caused by water seeping inside the camera due to improper handling of the camera.
- The waterproof performance of this camera is designed to work for fresh water and seawater only.
- The inner portion of this camera is not waterproof. Water seeping inside the camera could cause a malfunction.
- Accessories are not waterproof.
- If liquids or water droplets come into contact with the outside of the camera or the inside of the battery-chamber/memory card slot cover, immediately wipe the liquids off with a soft dry cloth. Do not insert wet memory cards or the battery.

If the battery-chamber/memory card slot cover is opened or closed under wet conditions near a waterfront or underwater, this could cause water to seep inside the camera or result in camera malfunction.

Do not open or close the cover with wet hands. This could cause water to seep inside the camera or result in camera malfunction.

- If a foreign substance adheres to the outside of the camera or the inside of the battery-chamber/memory card slot cover (such as the hinge, memory card slot, and connectors), remove it immediately with a blower. If a foreign substance adheres to the waterproof packing inside the battery-chamber/memory card slot cover, remove it with the included brush. Do not use the included brush for anything other than cleaning the waterproof packing.
- If a foreign substance such as suntan oil, sunscreen lotion, hot spring, bath mix powder, detergent, soap, organic solvent, oil, or alcohol adheres to the camera, immediately wipe it off.
- Do not leave the camera in high-temperature conditions of 40°C (104°F) or more (in particular, a place exposed to direct sunlight, inside the cabin of a car, on a boat, on the beach, or near a heating device) for a long period of time. This could cause deterioration of the waterproof performance.

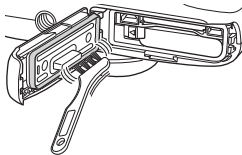

## Before Using the Camera Underwater

### 1. Make sure that there are no foreign substances inside the battery-chamber/memory card slot cover.

- Any foreign substances such as sand, dust or hair inside the battery-chamber/memory card slot cover should be removed with a blower.
- Any liquid such as water droplets inside the battery-chamber/memory card slot cover should be wiped off with a soft dry cloth.

### 2. Make sure that the waterproof packing (📖 2) of the battery-chamber/memory card slot cover is not cracked or deformed.

- The waterproof performance of waterproof packing may start to deteriorate after one year.  
If the waterproof packing begins to deteriorate, consult your retailer or Nikon-authorized service representative.

### 3. Make sure that the battery-chamber/memory card slot cover is firmly closed.

- Slide the cover until it clicks into place.

## Notes About Using the Camera Underwater

**Observe the following precautions to prevent water from seeping inside the camera.**

- Do not dive into water deeper than 10 m (33 ft) with the camera.
- Do not continuously use the camera underwater for 60 minutes or more.
- Use the camera in the water temperature range 0°C–40°C (32°F–104°F) when using it underwater.  
Do not use the camera at hot springs.
- Do not open or close the battery-chamber/memory card slot cover underwater.
- Do not subject the camera to shock when using it underwater.  
Do not jump into water with the camera or subject it to high water pressure conditions such as rapids or waterfalls.
- This camera does not float in water. Make sure not to drop the camera underwater.

## Cleaning After Using the Camera Underwater

- After using the camera underwater, clean the camera within 60 minutes. If you leave the camera in wet conditions where salt particles or other foreign substances adhere to it, this could cause damage, discoloration, corrosion, a bad smell or deterioration of waterproof performance.
- Before cleaning the camera, thoroughly remove water droplets, sand, salt particles, or other foreign substances from your hands, body, and hair.
- It is recommended to clean the camera indoors to avoid a place where it could be exposed to water spray or sand.
- Do not open the battery-chamber/memory card slot cover until all foreign substances are washed off with water and all moisture is wiped off.

## 1. Keep the battery-chamber/memory card slot cover closed and wash off the camera with fresh water.

Lightly rinse the camera with tap water, or immerse the camera in a shallow basin filled with fresh water for about 10 minutes.

- If the buttons or switches do not operate properly, foreign substances may have adhered to the camera.  
Foreign substances can cause the camera to malfunction; wash the camera thoroughly.

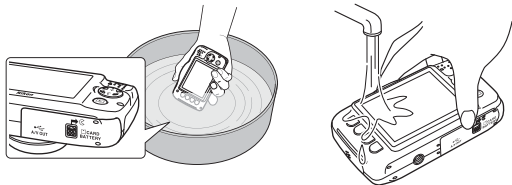

## 2. Wipe off water droplets with a soft cloth and dry the camera in the well-ventilated and shady place.

- Place the camera on a dry cloth to dry it.  
Water will flow out from openings in the microphone or speakers.
- Do not dry the camera with hot air from a hair dryer or clothes dryer.
- Do not use chemicals (such as benzine, thinner, alcohol, or cleanser), soap, or neutral detergents.

If the waterproof packing or body of the camera becomes deformed, the waterproof performance will deteriorate.

**3. After making sure that there are no water droplets on the camera, open the battery-chamber/memory card slot cover, gently wipe off any water remaining inside the camera with a dry soft cloth, and use the blower to remove any foreign substances.**

- If you open the cover before the camera is thoroughly dried, water droplets may fall on the memory card or battery.  
The water droplets may also seep inside the battery-chamber/memory card slot cover (in locations such as waterproof packing, hinges, memory card slot, or terminals). If that happens, wipe the water off with a dry soft cloth.
- If the cover is closed when the inside is wet, this could cause condensation or malfunction.
- If the microphone or speaker openings are clogged with water droplets, the sound may deteriorate or become distorted.
  - Wipe the water off with a dry soft cloth.
  - Do not puncture the microphone or speaker openings with a sharp implement. If the inside of the camera is damaged, the waterproof performance will deteriorate.

## Notes About Operating Temperature and Humidity and Condensation

The operation of this camera has been tested at temperatures  $-10^{\circ}\text{C}$  –  $+40^{\circ}\text{C}$  ( $14^{\circ}\text{F}$ – $104^{\circ}\text{F}$ ).

When you use the camera in cold climate regions, observe the following precautions. Keep the camera and spare batteries in a warm place before use.

- The performance of the batteries (number of pictures shot and shooting time) will drop temporarily.
- If the camera is in a very cold state, the performance may drop temporarily, for example, the monitor may be darker than normal immediately after the camera is turned on or residual images may be produced.
- When snow or water droplets adhere to the exterior of the camera, immediately wipe them off.
  - If the buttons or switches are frozen, they may not operate smoothly.
  - If the microphone or speaker openings are clogged with water droplets, the sound may deteriorate or become distorted.

- **Operating environmental conditions such as temperature and humidity may cause fogging (condensation) on the inside of the monitor, lens, or flash window. This is not a camera malfunction or defect.**

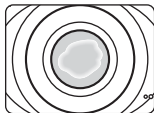

- **Environmental conditions that are likely to cause condensation inside of the camera**

Fogging (condensation) may occur on the inside of the monitor, lens, or flash window in the following environmental conditions where there are sharp temperature changes or high humidity.

- The camera is suddenly immersed in low temperature underwater from high temperature on land.
- The camera is moved from a cold place to a warm place, such as inside a building.
- The battery-chamber/memory card slot cover is open or closed in a high-humidity environment.

- **Clearing the fogging**

- Open the battery-chamber/memory card slot cover after turning off the camera in a place where the ambient temperature is stable (avoid any place that has high temperature/high humidity, sand or dust).

To clear the fogging, remove the battery and memory card, and leave the camera with the battery-chamber/memory card slot cover open to allow the camera to adjust to the ambient temperature.

- If the fogging does not clear, consult your retailer or Nikon-authorized service representative.

# Table of Contents

Introduction .....	ii	The Basics of Shooting and Playback ....	8
Read This First .....	ii	Preparation 1 Insert the Battery .....	8
About This Manual .....	iii	Preparation 2 Charge the Battery .....	10
Information and Precautions .....	v	Preparation 3 Insert a Memory Card .....	12
For Your Safety .....	viii	Internal Memory and Memory Cards .....	13
WARNINGS .....	viii	Preparation 4 Setting the Display Language, Date, and Time .....	14
Notices .....	xii	Step 1 Turn the Camera On .....	18
<Important> Shockproof, Waterproof, Dustproof, Condensation .....	xv	Step 2 Frame a Picture .....	20
Notes About Shockproof Performance .....	xv	Using the Zoom .....	21
Notes About Waterproof and Dustproof Performances .....	xvi	Step 3 Focus and Shoot .....	22
Before Using the Camera Underwater .....	xvii	The Shutter-release Button .....	23
Notes About Using the Camera Underwater .....	xviii	Step 4 Play Back Images .....	24
Cleaning After Using the Camera Underwater .....	xviii	Step 5 Delete Images .....	25
Notes About Operating Temperature and Humidity and Condensation .....	xxi	Restrict Image Deletion (Image Lock) .....	27
Parts of the Camera .....	1	Shooting Features .....	28
The Camera Body .....	1	Functions Available in Shooting Mode (Shooting Menu) .....	28
Attaching the Camera Strap .....	3	 Point and Shoot .....	30
The Monitor .....	4	Using the Flash .....	31
Shooting Mode .....	4	Using the Self-timer .....	33
Playback Mode .....	5	Using the Smile Timer .....	35
Using the Flexible Buttons .....	6	Choose a Style (Shooting Suited to Scenes and Effects) .....	37
		Tips and Notes .....	38
		Decorate .....	43
		Change Colors .....	44
		Change Sounds .....	47



Choose a Size.....	49	Reference Section .....	1
Choose a Photo Size.....	49	Have Fun with Pictures.....	2
Choose a Movie Frame Size.....	50	Exchange Messages.....	2
Functions That Cannot Be Used		Leave a Message.....	2
Simultaneously.....	51	Leave a Reply.....	4
Focusing.....	53	Play Recordings.....	5
Using Face Detection.....	53	Erase Recordings.....	5
Using Skin Softening.....	54	Picture Play.....	7
Subjects Not Suitable for Autofocus.....	54	Before Editing Images .....	7
Focus Lock.....	55	Make Photo Albums.....	8
		Add a Fisheye Effect.....	10
Playback Features.....	56	Toy Camera .....	10
Playback Zoom .....	56	Soften Pictures.....	11
Thumbnail Playback .....	57	Add Starbursts.....	11
Functions Available in Playback Mode		Add a Diorama Effect.....	12
(Playback Menu).....	58	Change Colors.....	13
		Highlight Colors.....	14
Recording and Playing Back Movies....	60	Decorate.....	15
Recording Movies .....	60	Grading .....	16
Playing Back Movies .....	63	Grade Pictures .....	16
		View Graded Pictures.....	18
General Camera Setup.....	65	Remove All Grades .....	19
Camera Settings Menu .....	65	View .....	20
		View by Date.....	20
Connecting the Camera to a TV, Computer, or Printer .....	67	Slide Show.....	21
Connection Methods.....	67	Choose Pictures.....	21
Using ViewNX 2 .....	69	Choose a Theme .....	25
Installing ViewNX 2 .....	69	View Movie.....	26
Transferring Images to the Computer .....	70		
Viewing Images.....	72		

Settings.....	27	Technical Notes and Index .....	1
☑ Retouch .....	27	Caring for the Product.....	2
🖨 Copy .....	27	The Camera.....	2
🔄 Rotate Pictures.....	30	The Battery.....	5
🖨 Small Picture .....	31	Charging AC Adapter.....	6
🖨 Print Order.....	32	Memory Cards .....	7
📷 Camera Settings .....	34	Cleaning and Storage.....	8
Welcome Screen.....	34	Cleaning.....	8
Date and Time.....	35	Storage.....	9
Brightness .....	36	Troubleshooting .....	10
Print Date .....	37	Specifications .....	18
Electronic VR .....	38	Approved Memory Cards.....	23
AF Assist .....	39	Index.....	26
Format Memory/Format Card.....	40		
Language.....	41		
Menu Background.....	41		
Video Mode .....	42		
Charge by Computer.....	43		
Reset All.....	44		
Firmware Version.....	44		
Connections.....	45		
Connecting the Camera to a TV.....	45		
Connecting the Camera to a Printer ...	47		
Connecting the Camera to a Printer...	48		
Printing Individual Images.....	50		
Printing Multiple Images .....	52		
Additional Information .....	55		
Error Messages.....	55		
File Names .....	58		
Optional Accessories .....	59		

# Parts of the Camera

## The Camera Body

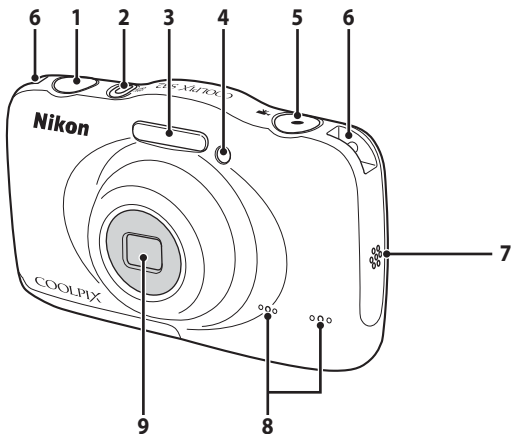

<b>1</b>	Shutter-release button.....	22
<b>2</b>	Power switch/power-on lamp.....	18
<b>3</b>	Flash.....	31
<b>4</b>	Self-timer lamp.....	33
	AF-assist illuminator.....	65

<b>5</b>	● (▶ movie-record) button.....	60
<b>6</b>	Eyelet for camera strap.....	3
<b>7</b>	Speaker.....	64
<b>8</b>	Microphone (stereo).....	60
<b>9</b>	Lens (with protective glass)	

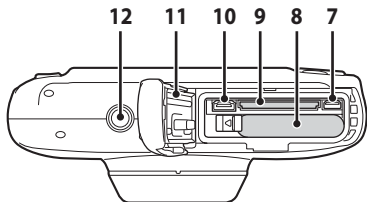
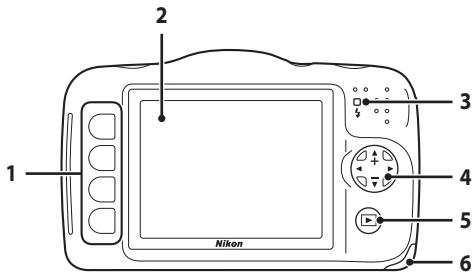

<b>1</b>	Flexible buttons.....	6, 28, 58	<b>6</b>	Battery-chamber/ memory card slot cover.....	8, 12
<b>2</b>	Monitor .....	4	<b>7</b>	USB/audio/video output connector.....	67
<b>3</b>	Charge lamp.....	11	<b>8</b>	Battery chamber.....	8
	Flash lamp.....	32	<b>9</b>	Memory card slot.....	12
	Multi selector		<b>10</b>	HDMI micro connector (Type D).....	67
<b>4</b>	▲: telephoto .....	21	<b>11</b>	Waterproof packing .....	xvi, xvii
	▼: wide-angle .....	21	<b>12</b>	Tripod socket.....	20
<b>5</b>	(shooting/playback mode) button....	24			

## Attaching the Camera Strap

Pass the strap through either the left or right strap eyelet and attach the strap.

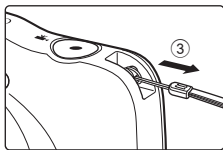
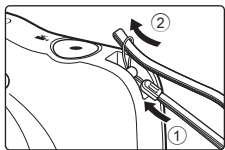

# The Monitor

The information that is displayed in the monitor during shooting and playback changes depending on the camera's settings and state of use.

## Shooting Mode

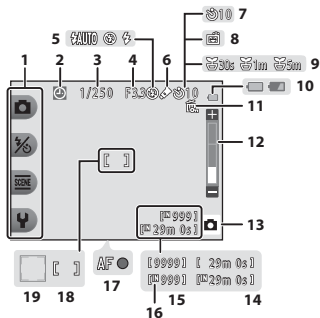

<b>1</b>	Flexible icons.....	6
<b>2</b>	"Date not set" indicator.....	14, 65
<b>3</b>	Shutter speed .....	23
<b>4</b>	Aperture value.....	23
<b>5</b>	Flash mode.....	31
<b>6</b>	<b>Change colors</b> icon.....	44
<b>7</b>	Self-timer indicator.....	33
<b>8</b>	Smile timer.....	35
<b>9</b>	<b>Shoot at intervals</b> icon .....	39
<b>10</b>	Battery level indicator .....	18

<b>11</b>	Image lock icon.....	27
<b>12</b>	Zoom indicator .....	21
<b>13</b>	Shooting mode.....	30, 37
<b>14</b>	Movie recording time remaining.....	60
<b>15</b>	Number of exposures remaining (still images).....	18, 50
<b>16</b>	Internal memory indicator .....	18
<b>17</b>	Focus indicator.....	22
<b>18</b>	Focus area.....	22
<b>19</b>	Focus area (face detection) .....	22

# Playback Mode

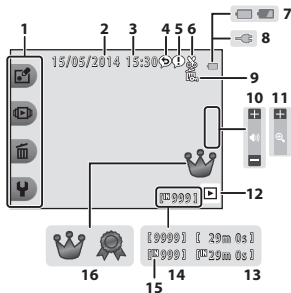

<b>1</b>	Flexible icons.....	6	<b>9</b>	Image lock icon.....	27
<b>2</b>	Date of recording .....	14	<b>10</b>	Volume indicator.....	64
<b>3</b>	Time of recording.....	14	<b>11</b>	Switch to full-frame .....	57
<b>4</b>	Message (reply).....	58, 📧 4	<b>12</b>	Playback mode.....	58
<b>5</b>	Message .....	58, 📧 2	<b>13</b>	Movie/message recording time	
<b>6</b>	Crop indicator.....	56	<b>14</b>	Current image number	
<b>7</b>	Battery level indicator .....	18	<b>15</b>	Internal memory indicator .....	13
<b>8</b>	Charging AC Adapter connection indicator		<b>16</b>	Grade mark.....	58, 📧 16

## **If Information Is Not Displayed During Shooting Mode and Playback Mode**

Apart from certain information, information is not displayed if no operations are performed for several seconds. Information is displayed again when either a flexible button or the multi selector is pressed.

## Using the Flexible Buttons

If you press a flexible button while the shooting screen or playback screen is displayed, the menu for the current mode is displayed. Once the menu is displayed, you can change various settings.

In this document, the flexible buttons are referred to as “flexible button 1” through “flexible button 4”, in order from top to bottom.

Shooting mode

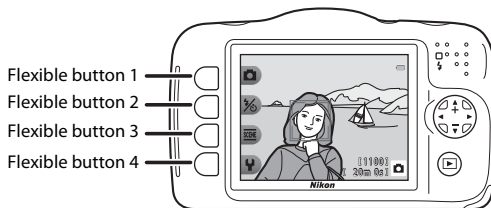

Playback mode

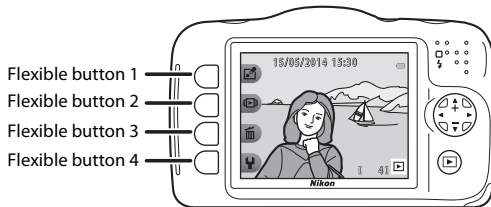



## Selecting Items

- To select an item, press the flexible button next to it.
- When  is displayed, press flexible button 1 to return to the previous screen.

### Shooting mode

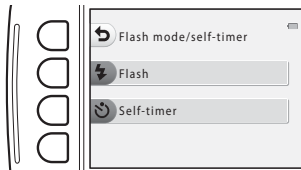

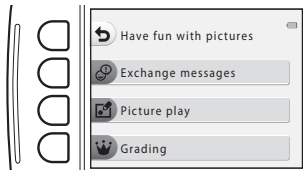

### Playback mode

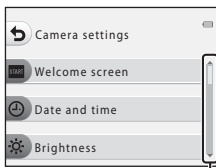

- When the menu content continues on another page, a guide indicating the page position is displayed.

Press the multi selector   to display other pages.



Use   to display other pages.

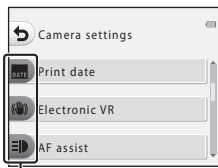

To select an item, press the flexible button next to the item.

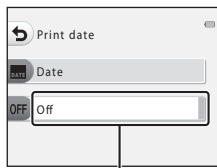

The last setting selected (including the default setting) is displayed in white.

## Notes About Setting Menu Options

Some menu options cannot be selected depending on how the camera is set up. These options are displayed in gray.

# The Basics of Shooting and Playback

## Preparation 1 Insert the Battery

- 1 Open the battery-chamber/memory card slot cover.

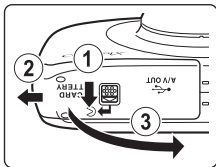

- 2 Insert the battery.

- Push the orange battery latch in the direction indicated by the arrow (1), and fully insert the battery (2).
- The battery locks into place when inserted correctly.

Battery latch

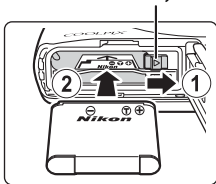

- ✓ Be Careful to Insert the Battery in Correct Direction**

*Inserting the battery upside down or backwards could damage the camera.*



### 3 Close the battery-chamber/memory card slot cover.

- Lay the cover completely flat in the direction indicated by the arrow (①), and fully slide it in (②).

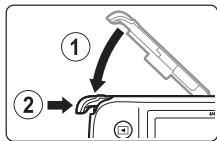

#### ✓ **Damage Caution**

*Sliding the cover while it is open may damage the camera.*



### Removing the Battery

Turn the camera off and make sure that the power-on lamp and the monitor have turned off, and then open the battery-chamber/memory card slot cover.

Move the battery latch in the direction indicated by the arrow (①) to eject the battery (②).

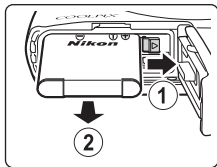

#### ✓ **High Temperature Caution**

The camera, battery, and memory card may be hot immediately after using the camera.

#### ✓ **Opening and Closing the Battery-chamber/Memory Card Slot Cover**

Do not open and close the battery chamber/memory card slot cover in a sandy or dusty environment or with wet hands. If the cover is closed without removing foreign particles, water may seep inside the camera or the camera may become damaged.

- If foreign particles get inside the cover or camera, immediately remove them with a blower or brush.
- If liquid such as water gets inside the cover or camera, immediately wipe it off with a soft and dry cloth.

## Preparation 2 Charge the Battery

- 1 Turn off the camera and open the battery-chamber/memory card slot cover.

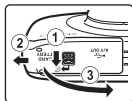

- 2 Prepare the included Charging AC Adapter.

If a plug adapter\* is included with your camera, attach the plug adapter to the plug on the Charging AC Adapter. Push the plug adapter firmly until it is securely held in place. Once the two are connected, attempting to forcibly remove the plug adapter could damage the product.

\* The shape of the plug adapter varies according to the country or region in which the camera was purchased.

The Charging AC Adapter comes with the plug adapter attached in Argentina and Korea.

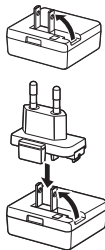

- 3 Make sure the battery is installed in the camera, and then connect the camera to the Charging AC Adapter in order of ① to ③.

- Keep the camera turned off.
- Make sure that the plugs are properly oriented. Do not insert or remove the plugs at an angle when connecting or disconnecting them.

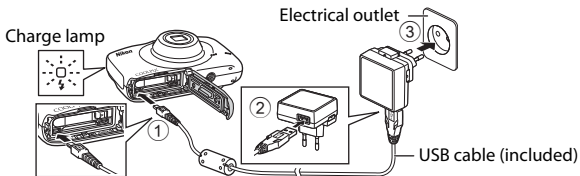



- The charge lamp slowly flashes green to indicate that the battery is charging.
- Shooting is not possible while the camera is connected to the Charging AC Adapter.

Charge lamp	Description
Flashes slowly (green)	The battery is charging.
Off	When charging is complete, the charge lamp stops flashing green and turns off. About 2 hours and 35 minutes are required to charge a fully exhausted battery.
Flashes quickly (green)	<ul style="list-style-type: none"> <li>The ambient temperature is not suited to charging. Charge the battery indoors with an ambient temperature of 5°C to 35°C (41°F to 95°F).</li> <li>The USB cable or Charging AC Adapter is not properly connected, or there is a problem with the battery. Disconnect the USB cable or unplug the Charging AC Adapter and correctly connect it again, or change the battery.</li> </ul>

#### **4** Disconnect the Charging AC Adapter from the electrical outlet and then disconnect the USB cable.

#### **Charging Using a Computer or Battery Charger**

- You can also charge the battery by connecting the camera to a computer ( 67,  43).
- You can use the Battery Charger MH-66 (available separately;  59) to charge the battery without using the camera.

## Preparation 3 Insert a Memory Card

- 1 Turn off the camera and open the battery-chamber/memory card slot cover.

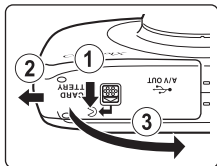

- 2 Insert the memory card.

- Slide the memory card in until it clicks into place.

Memory card slot

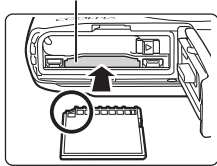

- ✓ Be Careful to Insert the Memory Card in Correct Direction**

*Inserting the memory card upside down or backwards could damage the camera and the memory card.*



### 3 Close the battery-chamber/memory card slot cover.

- Lay the cover completely flat in the direction indicated by the arrow (①), and fully slide it in (②).

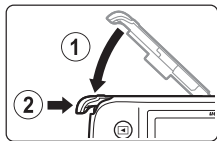

#### ✓ **Damage Caution**

*Sliding the cover while it is open may damage the camera.*



#### ✓ **Formatting Memory Cards**

The first time you insert a memory card that has been used in another device into this camera, make sure to format it with this camera. Insert the card into the camera and select **Format card** in the camera settings menu.

#### Removing Memory Cards

Turn the camera off and make sure that the power-on lamp and the monitor have turned off, and then open the battery-chamber/memory card slot cover.

Gently push the memory card into the camera (①) to partially eject the card (②).

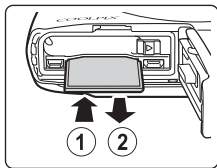

#### ✓ **High Temperature Caution**

The camera, battery, and memory card may be hot immediately after using the camera.

#### Internal Memory and Memory Cards

Camera data, including images and movies, can be saved either in the camera's internal memory or on a memory card. To use the camera's internal memory, first remove the memory card.

## Preparation 4 Setting the Display Language, Date, and Time

When the camera is turned on for the first time, the language-selection screen, the date and time setting screen for the camera clock, and the menu background setting screen are displayed.

- If you exit without setting the date and time,  will flash when the shooting screen is displayed.

- 1 Press the power switch to turn on the camera.

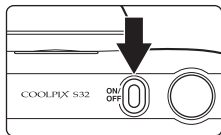

- 2 Use the multi selector  to select the desired language and press flexible button 4 (OK).

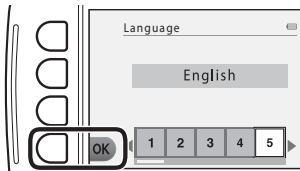

- 3 Press flexible button 3 (O Yes).

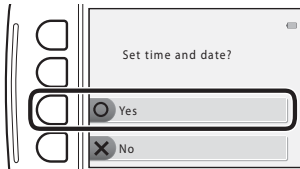



#### 4 Use flexible button 2, 3, or 4 to select the date format.

- Select **Y/M/D Year/Month/Day**, **M/D/Y Month/Day/Year**, or **D/M/Y Day/Month/Year**.

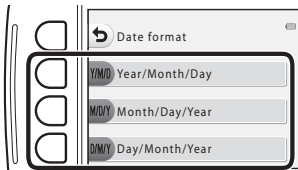

#### 5 Set the date and time, and press flexible button 4 (OK).

- Select a field: Press ◀ (changes between **D**, **M**, **Y**, **h**, and **m**).
- Edit the date and time: Press ▲▼.
- Apply the setting: Select **m** and press flexible button 4 (**OK**).
- To enable daylight saving time, press flexible button 3 (☀). When the daylight saving time function is enabled, ☀ is displayed in the monitor. To turn off the daylight saving time function, press flexible button 3 (☀) again.

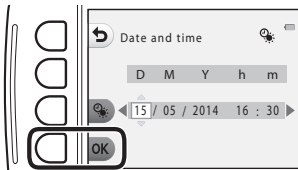

#### 6 Press flexible button 3 (○ Yes).

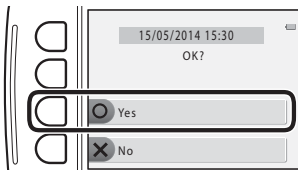

- 7** Use ◀▶ to select the background image to be displayed when a menu or setting screen is displayed, and press flexible button 4 (OK).

- To restore the default background image, press flexible button 3 (RESET).

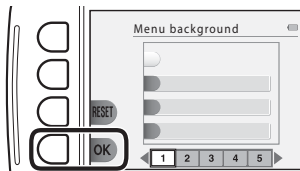

- 8** Confirm the waterproofing-related message and press ▶.

- There are six message screens.

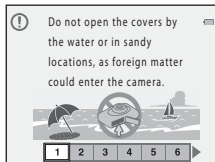

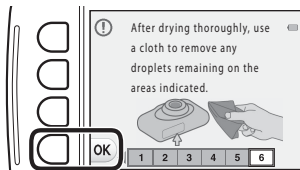

- 9** Confirm the message on the screen shown at right and press flexible button 4 (OK).

- The monitor changes to the shooting screen (📖 18).





## Changing the Language Setting, the Date and Time Setting, and the Menu Background Setting

- You can change the **Language, Date and time**, and **Menu background** settings in the  camera settings menu ( 65).
- You can enable or disable daylight saving time in the  camera settings menu by selecting **Date and time**. When enabled, the clock moves forward one hour; when disabled, the clock moves back one hour.





## The Clock Battery

- The camera's clock is powered by a built-in backup battery. The backup battery charges when the main battery is inserted into the camera or when the camera is connected to an optional AC adapter, and it can run the clock for several days after about ten hours of charging.
- If the camera's backup battery becomes exhausted, the date and time setting screen is displayed when the camera is turned on. Set the date and time again. → Step 3 of "Preparation 4 Setting the Display Language, Date, and Time" ( 14)



## Imprinting the Shooting Date on Printed Images

- You can permanently imprint the shooting date on images as they are captured by setting **Print date** in the camera settings menu ( 65).
- If you want the shooting date to be printed without using the **Print date** setting, print using the ViewNX 2 software ( 69).

# Step 1 Turn the Camera On

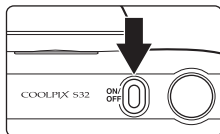

## 1 Press the power switch.

- The monitor turns on.
- To turn the camera off, press the power switch again.



## 2 Check the battery level indicator and the number of exposures remaining.

### Battery level indicator

Display	Description
	The battery level is high.
	The battery level is low.
<b>Battery exhausted.</b>	The camera cannot capture images. Recharge the battery.

### Number of Exposures Remaining

The number of images that can be taken is displayed.

-  is displayed when no memory card is inserted in the camera, and images are saved in the internal memory.



### Battery level indicator

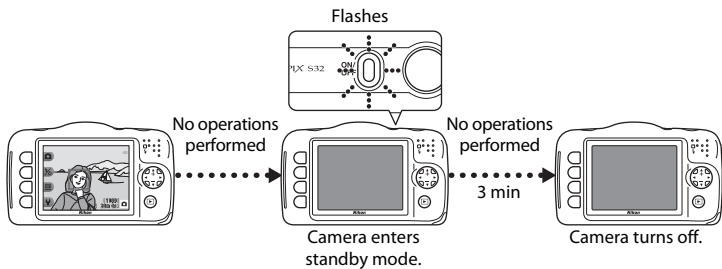

### Number of exposures remaining

## The Auto Off Function



- The time that elapses before the camera enters standby mode is about three minutes.
- While the camera is in standby mode, the monitor turns back on if you perform any of the following operations:
  - Press the power switch, shutter-release button,  (shooting/playback mode) button, or  (movie-record) button

## Step 2 Frame a Picture

### 1 Hold the camera steady.

- Keep fingers and other objects away from the lens, flash, AF-assist illuminator, microphone, and speaker.

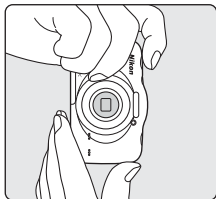
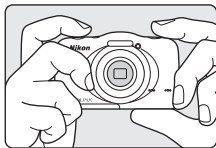



### 2 Frame the picture.



### When Using a Tripod

We recommend using a tripod to stabilize the camera in the following situations.

- When shooting in dim lighting
- When shooting with the flash mode ( 31) set to  **Flash off**
- When using the telephoto setting

## Using the Zoom

When you press the multi selector ▲▼, the zoom lens position changes.

- To zoom in closer to the subject: Press ▲ (telephoto)
- To zoom out and view a larger area: Press ▼ (wide-angle)

When you turn the camera on, the zoom moves to the maximum wide-angle position.

- A zoom indicator is displayed in the monitor when the multi selector ▲▼ is pressed.

Zoom in



Zoom out

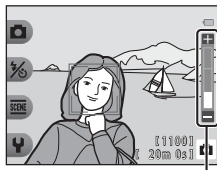

Zoom indicator

- If you press ▲ when the camera is zoomed in to the maximum optical zoom position, you can use the digital zoom to magnify the image further by up to about 4x.

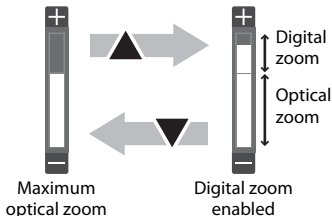

### Digital Zoom and Interpolation

While using digital zoom, the image quality decreases due to interpolation depending on the image size and the amount of digital zoom magnification.

When using digital zoom, we recommend reducing the image size in  **Photo size** under

 **Choose a size** in order to minimize image deterioration ( 49).

## Step 3 Focus and Shoot

### 1 Press the shutter-release button halfway.

- When the subject is in focus, the focus area glows green (multiple focus areas can glow green).
- When you are using digital zoom, the camera focuses on the subject in the center of the frame and the focus area is not displayed. When the camera has focused, the focus indicator (📖 4) glows green.
- If the focus area or focus indicator flashes, the camera is unable to focus. Modify the composition and try pressing the shutter-release button halfway again.

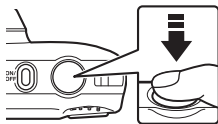



### 2 Without lifting your finger, press the shutter-release button the rest of the way down.





## The Shutter-release Button

<p>Press halfway</p> 	<p>To set focus and exposure (shutter speed and aperture value), press the shutter-release button lightly until you feel a slight resistance. Focus and exposure remain locked while the shutter-release button is pressed halfway.</p>
<p>Press all the way</p> 	<p>Press the shutter-release button all the way to release the shutter and take an image. Do not use force when pressing the shutter-release button, as this may result in camera shake and blurred images. Press the button gently.</p>

### Notes About Saving Images and Recording Movies

The indicator showing the number of exposures remaining or the indicator showing the maximum movie length flashes while images are being saved or while a movie is being recorded. **Do not open the battery-chamber/memory card slot cover or remove the battery or memory card** while an indicator is flashing. Doing this could result in loss of data, or in damage to the camera or the memory card.



## Step 4 Play Back Images

### 1 Press the (shooting/playback mode) button.

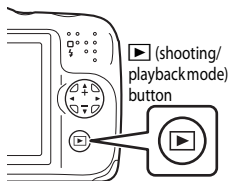
- If you press and hold down the  (shooting/playback mode) button while the camera is turned off, the camera turns on in playback mode.



### 2 Use the multi selector to select an image to display.

- Press and hold down  to scroll through the images quickly.
- To return to shooting mode, press the  (shooting/playback mode) button or shutter-release button.

Display  
the  
previous  
image



Display  
the  
next  
image

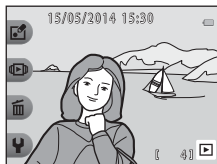

## Step 5 Delete Images

- 1 Display the image you want to delete in the monitor and then press flexible button 3 (🗑️).

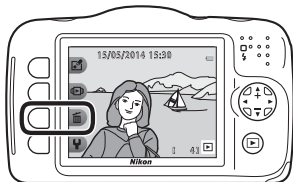

- 2 Use flexible button 2, 3, or 4 to select the deletion method.

- Select 🗑️ **Erase this picture only**, 🗑️ **Erase selected pictures** (📖 26), or **ALL Erase all pictures**.
- To exit without deleting, press flexible button 1 (⏪).

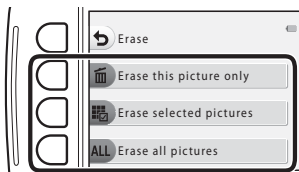

- 3 Press flexible button 3 (⊙ Yes).

- Deleted images cannot be recovered.
- To exit without deleting, press flexible button 4 (✖ No).

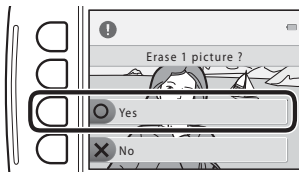

## Selecting Which Images You Want to Delete

**1** Use the multi selector ◀▶ to select an image to be deleted, and then press flexible button 2 (✔).

- The selected image is indicated by a check mark.
- A check mark is displayed or removed every time you press flexible button 2 (✔).
- Press flexible button 3 (RESET) to remove all check marks.

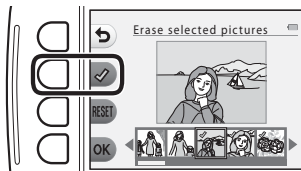

**2** Add check marks to all images that you want to delete and press flexible button 4 (OK) to confirm the selection.

- A confirmation dialog is displayed. Follow the instructions displayed in the monitor.

## Restrict Image Deletion (Image Lock)

To prevent accidental deletion of images, you can lock image deletion (🔒 25) and formatting (📄 65, 🗑️ 40).

- 1 Press and hold down flexible buttons 1 and 4 at the same time while in shooting mode or playback mode.

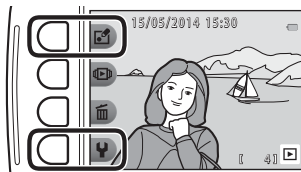

- 2 Press flexible button 3 (○ Yes).

- Image lock is set.
- When image lock is set, 🔒 is displayed in the monitor.

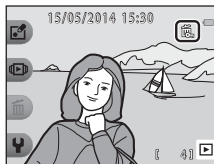
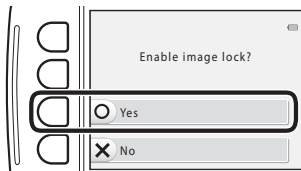









## Removing Image Lock



The procedure for removing image lock is the same as for setting image lock.

# Shooting Features

## Functions Available in Shooting Mode (Shooting Menu)

Press a flexible button to display a menu. You can change the following settings.



Flexible button	Option	Description	
 Point and shoot	–	Sets the shooting mode to  Point and shoot.	30
 Flash mode/ self-timer	Flash	Allows you to set the flash mode.	31
	Self-timer	The camera is equipped with a self-timer that releases the shutter about ten seconds after you press the shutter-release button. You can also set the smile timer.	33, 35
 More picture options	Choose a style	Allows you to select the scene settings and effects used for shooting.	37
	Decorate	Allows you to add a frame around your images when taking images.	43
	Change colors	Allows you to select  <b>Brighter/darker</b> or  <b>More vivid/less vivid</b> from the menu, or use  <b>Highlight colors</b> to keep one specified color in the image, and change the other colors to black and white.	44

Flexible button	Option	Description	
 Settings	Change sounds	Allows you to configure the shutter and button sounds.	47
	Choose a size	Allows you to set the size of photos (still images) and movies.	49
	Camera settings	Allows you to change a number of general settings.	65



## Point and Shoot

When this camera is used for the first time, the shooting mode is set to  Point and shoot. The camera automatically selects the optimum scene when you frame an image, making it even easier to take images using settings that suit the scene.

 Point and shoot is the default shooting mode for this camera.

- The area of the frame that the camera focuses on varies depending on the composition of the image.
- When the camera detects a human face, it focuses on that face ( 53). The skin softening feature makes the skin tones in human faces appear smoother ( 54).
- The flash may fire when shooting in low light.
- When shooting in low light, the use of a tripod is recommended.
- The camera does not detect the scene when the digital zoom is being used.

### Notes About Motion Detection

In  Point and shoot and **Shoot close-ups** ( 38), when the camera detects subject movement or camera shake, ISO sensitivity and shutter speed are increased to reduce blurring.



## Using the Flash

You can select the flash mode to match the shooting conditions.

Enter shooting mode → flexible button 2 (Ⓜ) → flexible button 2 (⚡ Flash)

### Available Flash Modes

#### ⚡AUTO Auto flash

The flash fires when necessary, such as in dim lighting.

#### Ⓜ Flash off

The flash does not fire.

- We recommend using a tripod to stabilize the camera when shooting in dark surroundings.

#### ⚡ Always fire flash

The flash fires whenever an image is taken. Use to “fill-in” (illuminate) shadows and backlit subjects.

Use flexible button 2, 3, or 4 to select the flash mode.

- Select **⚡AUTO Auto flash**, **Ⓜ Flash off**, or **⚡ Always fire flash**.
- To cancel, press flexible button 1 (⏪).

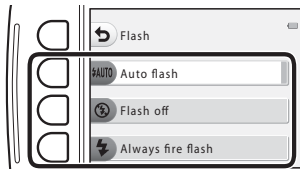

## The Flash Lamp

The status of the flash can be confirmed by pressing the shutter-release button halfway.

- On: The flash fires when you press the shutter-release button all the way down.
- Flashing: The flash is charging. The camera cannot shoot images.
- Off: The flash does not fire when an image is taken.

If the battery level is low, the monitor turns off while the flash is charging.

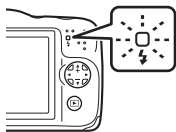

## The Flash Mode Setting

- The setting may not be changed when using some shooting modes or settings.
- The setting applied in  Point and shoot is saved in the camera's memory even after the camera is turned off.

## Using the Self-timer

The camera is equipped with a self-timer that releases the shutter about ten seconds after you press the shutter-release button.

Enter shooting mode → flexible button 2 (1/30) → flexible button 3 (Self-timer)

### 1 Press flexible button 2 (10s 10 s).

- When  **Smile timer** is selected, the camera uses face detection to detect a human face, and then automatically releases the shutter when a smile is detected (📖 35).

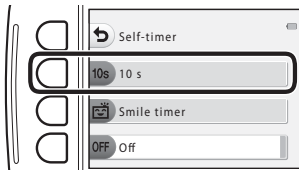

### 2 Frame the picture and press the shutter-release button halfway.

- Focus and exposure are set.



### 3 Press the shutter-release button the rest of the way down.

- Countdown starts. The self-timer lamp flashes and then glows steadily about one second before the shutter is released.
- When the shutter is released, the self-timer is set to **OFF off**.
- To stop the countdown, press the shutter-release button again.



## Using the Smile Timer

When the camera detects a smiling face, you can take an image automatically without pressing the shutter-release button. The skin softening function makes the skin tones of human faces smoother.

Enter shooting mode → flexible button 2 (📷) → flexible button 3 (⌚ Self-timer)

- 1 Press flexible button 3 (📷 Smile timer).

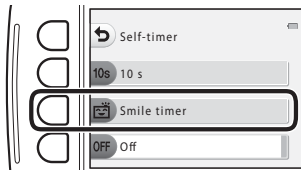

- 2 Frame the picture.
  - Point the camera at a human face.
- 3 Without pressing the shutter-release button, wait for the subject to smile.
  - If the camera detects that the face framed by the double border is smiling, the shutter is automatically released.
  - Whenever the camera detects a smiling face, it automatically releases the shutter.
- 4 End automatic shooting.
  - To end automatic shooting, set the self-timer to **OFF off**.

### **Notes About Smile Timer**

Under some shooting conditions, the camera may be unable to detect faces or detect smiles (📖 53). The shutter-release button can also be used for shooting.

### **When the Self-timer Lamp Flashes**

When using smile timer, the self-timer lamp flashes when the camera detects a face and flashes quickly immediately after the shutter is released.

## Choose a Style (Shooting Suited to Scenes and Effects)









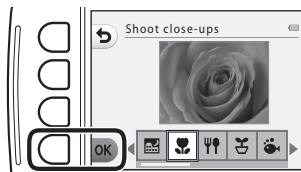





When a style (shooting scenes and effects) is selected, camera settings are automatically optimized for the selected scene. The expected effect may not be achieved depending on the subject.

Enter shooting mode → flexible button 3 (SCENE) → flexible button 2 (SCENE) Choose a style)

Use the multi selector ◀▶ to select the desired style (shooting scene and effect) and press flexible button 4 (OK).

- To cancel, press flexible button 1 (↶).



 Shoot night scenes <sup>1</sup> (📖 38) (default setting)	 Shoot close-ups <sup>2,3</sup> (📖 38)
 Photograph food <sup>2</sup> (📖 38)	 Shoot at intervals (📖 39)
 Shoot under water <sup>2,3</sup> (📖 39)	 Take a series of pictures (📖 40)
 Photograph fireworks <sup>1,4</sup> (📖 40)	 Shoot backlit scenes <sup>5</sup> (📖 40)
 Mirror <sup>2,3</sup> (📖 41)	 Add a bubble effect <sup>2,3</sup> (📖 41)
 Add a neon effect <sup>2,3</sup> (📖 41)	 Add a cartoon effect <sup>2,3</sup> (📖 42)
 Take soft pictures <sup>2,3</sup> (📖 42)	 Create a diorama effect <sup>2,3</sup> (📖 42)

<sup>1</sup> The camera focuses at infinity.

<sup>2</sup> The camera focuses on the area in the center of the frame. When the zoom is set to a position where the zoom indicator turns green, the camera can focus on subjects as close as about 20 cm (8 in.) from the front of the protective glass, or about 5 cm (2 in.) at the maximum wide-angle position.



<sup>3</sup> The flash may be unable to light the entire subject at distances of less than 30 cm (1 ft).

<sup>4</sup> Use of a tripod is recommended, because the shutter speed is slow.



<sup>5</sup> The camera focuses on the area in the center of the frame.

## Tips and Notes



### Shoot night scenes

- When the shutter-release button is pressed all the way, the camera captures a series of images which are combined into a single image and saved.
- Once the shutter-release button is pressed all the way, hold the camera still until a still image is displayed. After taking an image, do not turn the camera off before the monitor switches to the shooting screen.
- The angle of view (i.e., the area visible in the frame) seen in the saved image is narrower than that seen in the monitor at the time of shooting.
- The flash setting is fixed at  **Flash off** (📖 31).
- The self-timer can be set, but  **Smile timer** is not available (📖 33, 35).

### Shoot close-ups

- The camera automatically zooms to the closest position at which it can focus.
- The flash is set to  **Flash off**, but the setting can be changed (📖 31).
- The self-timer can be set, but  **Smile timer** is not available (📖 33, 35).

### Photograph food

- The camera automatically zooms to the closest position at which it can focus.
- Use the multi selector  to adjust the hue setting and press flexible button 4 (**OK**). The hue setting is saved in the camera's memory even after the camera is turned off.
- The flash setting is fixed at  **Flash off** (📖 31).
- The self-timer can be set, but  **Smile timer** is not available (📖 33, 35).







## Shoot at intervals

- The camera can automatically capture still images at pre-determined intervals. Images captured in one shooting are saved in one folder and can be viewed in a slide show (📖 58).
- Press flexible button 2 (**30s Shoot every 30 seconds**), flexible button 3 (**1m Shoot once a minute**), or flexible button 4 (**5m Shoot every 5 minutes**) to set the shooting interval.
- The maximum number of images that can be captured depends on the selected interval.
  - **Shoot every 30 seconds:** Approx. 280 images
  - **Shoot once a minute:** Approx. 140 images
  - **Shoot every 5 minutes:** Approx. 30 images
- Use a sufficiently charged battery to prevent the camera from turning off during shooting.
- Press the shutter-release button all the way down to capture the first image. In between each shot, the monitor turns off and the power-on lamp flashes. The monitor automatically turns on again just before the next image is captured.
- Press the shutter-release button halfway to stop shooting.
- The flash is set to **⚡AUTO Auto flash**, but the setting can be changed (📖 31).
- The self-timer is not available (📖 33).



## Shoot under water

- When **Shoot under water** is set, the waterproofing-related messages are displayed. Confirm each message and press the multi selector ▶ to display the next message. Press flexible button 4 (**OK**) to skip the messages and change to the shooting screen.
- See “<Important> Shockproof, Waterproof, Dustproof, Condensation” (📖 xv-xxi) for more information about using the camera underwater.
- The flash is set to **🔇Flash off**, but the setting can be changed (📖 31).
- The self-timer can be set, but **📷Smile timer** is not available (📖 33, 35).





## Take a series of pictures

- The camera captures a series of still images that allow you to clearly see detailed movements in a moving subject.
- While the shutter-release button is held all the way down, the camera shoots up to 11 images continuously at a rate of about 4.7 frames per second (fps) (when **Choose a size > Photo size** is set to  **Large (13 megapixels)**).
- The frame rate for continuous shooting may vary depending upon the current photo size setting, the memory card used, or shooting condition.
- Focus, exposure, and hue are fixed at the values determined with the first image in each series.
- The flash setting is fixed at  **Flash off** ( 31).
- The self-timer is not available ( 33).



## Photograph fireworks



- The shutter speed is fixed at about four seconds.
- The flash setting is fixed at  **Flash off** ( 31).
- The self-timer is not available ( 33).

## Shoot backlit scenes

- When taking images with very bright and dark areas in the same frame, such as backlit scenes, the high dynamic range (HDR) compositing is applied and loss of details in highlights or shadows is minimized.
- When the shutter-release button is pressed all the way, the camera shoots images continuously at high speed, and saves the following two images.
  - A non-HDR composite image
  - An HDR composite image in which the loss of details in highlights or shadows is minimized
- If there is only enough memory to save one image, an image processed at the time of shooting, in which dark areas of the image are corrected, is the only image saved.
- Once the shutter-release button is pressed all the way, hold the camera still until a still image is displayed. After taking an image, do not turn the camera off before the monitor switches to the shooting screen.
- The angle of view (i.e., the area visible in the frame) seen in the saved image is narrower than that seen in the monitor at the time of shooting.
- The flash setting is fixed at  **Flash off** ( 31).
- The self-timer can be set, but  **Smile timer** is not available ( 33, 35).





## Mirror

- You can take images that are vertically or horizontally symmetrical over the center of the frame.
- Press flexible button 2 ( **Top → bottom**) or flexible button 3 ( **Left → right**) to set the flip direction.



When  **Top → bottom** is selected, the top half of the screen is flipped over the bottom half, and the image is composited and displayed. When  **Left → right** is selected, the left half of the screen is flipped over the right half.

- The flash is set to  **AUTO Auto flash**, but the setting can be changed ( 31).
- The self-timer can be set, but  **Smile timer** is not available ( 33, 35).

## Add a bubble effect

- This effect makes the image appear to be projected on a bubble.
- A guide is displayed in the monitor. Compose the shot so that the main subject is contained within the guide.
- The flash setting is fixed at  **AUTO Auto flash**, but the setting can be changed ( 31).
- The self-timer can be set, but  **Smile timer** is not available ( 33, 35).

## Add a neon effect

- This effect makes the outlines of the image appear to glow with neon tubing.
- Use the multi selector  to select the outline color and press flexible button 4 (**OK**). The color setting is saved in the camera's memory even after the camera is turned off.
- After taking an image, do not turn the camera off before the monitor switches to the shooting screen.
- The flash setting is fixed at  **AUTO Auto flash**, but the setting can be changed ( 31).
- The self-timer can be set, but  **Smile timer** is not available ( 33, 35).



### Add a cartoon effect

- Performs tone compensation and makes the image appear like a cartoon.
- After taking an image, do not turn the camera off before the monitor switches to the shooting screen.
- The flash setting is fixed at **⚡AUTO Auto flash**, but the setting can be changed (📖 31).
- The self-timer can be set, but  **Smile timer** is not available (📖 33, 35).

### Take soft pictures

- Softens the image by adding a slight blur to areas outside of the guide displayed in the monitor.
- A guide is displayed in the monitor. Compose the shot so that the main subject is contained within the guide.
- The flash is set to **⚡AUTO Auto flash**, but the setting can be changed (📖 31).
- The self-timer can be set, but  **Smile timer** is not available (📖 33, 35).

### Create a diorama effect

- This effect is well-suited for images captured from a high vantage point with the main subject in the center of the image.
- A guide is displayed in the monitor. Compose the shot so that the main subject is contained within the guide.
- The flash is set to  **Flash off**, but the setting can be changed (📖 31).
- The self-timer can be set, but  **Smile timer** is not available (📖 33, 35).

# Decorate

You can add a frame around your images when taking images. Nine different frames are available.

Enter shooting mode → flexible button 3 (SCENE) → flexible button 3 (Decorate)

- The **Choose a size** > **Photo size** setting is fixed at **Small (2 megapixels)** (49).

**1** Use the multi selector ◀▶ to select the desired frame and press flexible button 4 (OK).

- To cancel, press flexible button 1 (↵).
- You can press flexible button 3 (🗑️) to remove the frame.

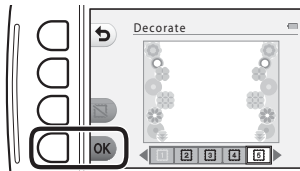



**2** Frame the subject and take a picture.

## ✓ Notes About Decorate

- The area that is captured becomes smaller when a thicker frame is selected.
- When using borderless printing to print images that you have added frames to, the frames may not be printed.

# Change Colors

You can adjust brightness (exposure compensation) and vividness when taking images. You can also select one color to keep in your images and turn the rest of the colors to shades of black and white. See  46 for details on each effect.

Enter shooting mode → flexible button 3 () → flexible button 4 ( Change colors)

**1** Use flexible button 2, 3, or 4 to select the setting.

- Select  **Brighter/darker**,  **More vivid/less vivid**, or  **Highlight colors**.



**2** Use the multi selector  to select the brightness, vividness, or to select the color you want to highlight.

- The screen displayed when  **Brighter/darker** is selected in step 1 is used here as an example.
- Press flexible button 3 (**RESET**) to turn the effect off.

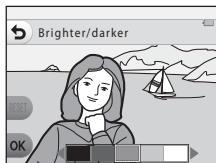

### 3 Press flexible button 4 (OK).

- To cancel, press flexible button 1 (↩).

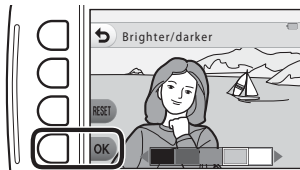

### 4 Frame the subject and take a picture.

#### Notes About Change Colors

- The setting is saved in the camera's memory even after the camera is turned off.
- Images adjusted with **Change colors** are indicated by .

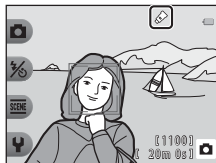

## Brighter/Darker (Exposure Compensation)

You can adjust overall image brightness.

- Use ◀ to move the cursor to the left to make the overall image darker. Use ▶ to move the cursor to the right to make it brighter.

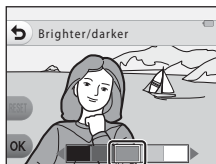

Cursor

## ◆ More Vivid/Less Vivid (Saturation)

You can adjust the overall vividness of the image.

- Use ◀ to move the cursor to the left to make the overall image more dull. Use ▶ to move the cursor to the right to make it more vivid.



Cursor

## Highlight Colors

You can create a black and white image in which only the specified color remains.

- Use ◀▶ to move the cursor and select the color to highlight.

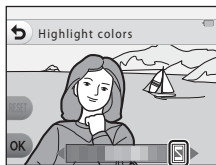

Cursor



## Change Sounds

Allows you to configure the shutter and button sounds. You can select one of eight different sounds, or turn sounds off.

Enter shooting mode → flexible button 4 (👉) → flexible button 2 (🎵 Change sounds)

### 📷 Pick a shutter sound

Allows you to select the sound heard when the shutter is released and when the focus has been locked.

When using **Take a series of pictures** (📖 40) or when recording movies, the shutter sound is not heard.

- If you select 🚫, the shutter sound and the sound heard when the focus has been locked are muted.

### 📷 Pick a button sound

Allows you to select the beep heard when the camera switches between shooting and playback modes, when using the menus, when the camera is connected to a computer or printer, etc.

- Regardless of this setting, sounds that are heard when an error occurs and when the camera is turned on do not change.
- If you select 🚫, button sounds and the sounds heard when an error occurs and when the camera is turned on are muted.

### 🎵 Turn sounds on or off



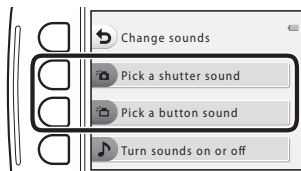

Turn all sounds on or off. When the mute is canceled after muting sounds once, the shutter sound and button sound used before muting will be used again.

## 1 Press flexible button 2 or flexible button 3.

- 📷 **Pick a shutter sound:** Set the shutter sound.
- 📷 **Pick a button sound:** Set the button sound.



## 2 Use the multi selector ◀▶ to select the type of sound.

- : Set the standard sounds.
- : Sounds are not heard.
- Press flexible button 3 (▶) to play the selected sound.
- To cancel, press flexible button 1 (◀).
- The screen displayed when  **Pick a shutter sound** was selected in step 1 is shown here as an example, but the procedure is the same if you select  **Pick a button sound**.

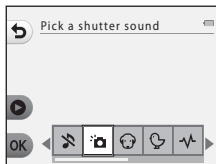

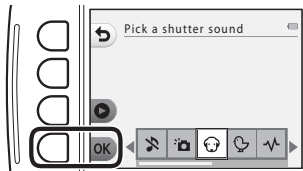

## 3 Press flexible button 4 (OK).

- The sound is set.



### **Muting All Sounds**

On the screen displayed in step 1, press flexible button 4 ( **Turn sounds on or off**) → flexible button 3 ( **Turn sounds off**), in that order, to mute all sounds.

To cancel the mute, press flexible button 4 ( **Turn sounds on or off**) → flexible button 2 ( **Turn sounds on**), in that order.

## Choose a Size

Set the size of photos (still images) and movies.

### Choose a Photo Size

Select the combination of image size and compression ratio that is used when saving images. The higher the image mode setting, the larger the size at which images can be printed, and the lower the compression ratio, the higher the quality of the images, but the number of images that can be saved is reduced.

Enter shooting mode → flexible button 4 (📷) → flexible button 3 (📷 Choose a size) → flexible button 2 (📷 Photo size)

Option*	Size* (pixels)	Compression ratio	Aspect ratio (horizontal to vertical)
■ Large (13 megapixels) (default setting)	4160 × 3120	Approx. 1:4	4:3
■ Medium (4 megapixels)	2272 × 1704	Approx. 1:8	4:3
■ Small (2 megapixels)	1600 × 1200	Approx. 1:8	4:3

\* The total number of pixels captured, and the number of pixels captured horizontally and vertically.  
Example: ■ **Large (13 megapixels)** = approx. 13 megapixels, 4160 × 3120 pixels

### Setting the Photo Size



- This setting also applies to **Choose a style** and **Change colors**.
- The setting may not be changed when using certain settings of other functions.



## Number of Images That Can Be Saved



- The approximate number of images that can be saved can be checked in the monitor when shooting ( 18).
- Note that due to JPEG compression, the number of images that can be saved may vary greatly depending on the image content, even when using memory cards with the same capacity and the same photo size setting. In addition, the number of images that can be saved may vary depending on the make of the memory card.
- If the number of exposures remaining is 10,000 or more, the number of exposures remaining display shows “9999”.

## Choose a Movie Frame Size

Select the desired movie option to record.

Enter shooting mode → flexible button 4 () → flexible button 3 ( Choose a size) → flexible button 3 ( Movie frame size)

Option	Image size	Aspect ratio (horizontal to vertical)	Frame rate
 Large (1080p) (default setting) <sup>1</sup>	1920 × 1080	16:9	Approx. 30 fps
 Small (640)	640 × 480	4:3	Approx. 30 fps
 Small (old-fashioned) <sup>2</sup>	640 × 480	4:3	Approx. 15 fps

<sup>1</sup> When no memory card is inserted (i.e., when using the camera's internal memory), you can select  **Small (640)** or  **Small (old-fashioned)**.

<sup>2</sup> Allows you to record movies with an atmosphere and hue similar to movies shot on old 8mm film.

## Functions That Cannot Be Used Simultaneously

Some functions cannot be used with other menu options.

Restricted function	Option	Description
Flash	Choose a style (📖 37)	When <b>Shoot night scenes</b> , <b>Photograph food</b> , <b>Take a series of pictures</b> , <b>Photograph fireworks</b> , or <b>Shoot backlit scenes</b> is selected, the flash cannot be used.
Self-timer	Choose a style (📖 37)	When <b>Shoot at intervals</b> , <b>Take a series of pictures</b> , or <b>Photograph fireworks</b> is selected, the self-timer cannot be used.
Smile timer	Choose a style (📖 37)	When any option in <b>Choose a style</b> is enabled, <b>Smile timer</b> cannot be used.
	Highlight colors (📖 46)	When <b>Highlight colors</b> is enabled, <b>Smile timer</b> cannot be used.
Decorate	Smile timer (📖 35)	When <b>Smile timer</b> is selected, <b>Decorate</b> cannot be used.
	Choose a style (📖 37)	When any option in <b>Choose a style</b> is enabled, <b>Decorate</b> cannot be used.
Change colors	Smile timer (📖 35)	When <b>Smile timer</b> is selected, <b>Change colors</b> cannot be used.
	Choose a style (📖 37)	When any option in <b>Choose a style</b> is enabled, <b>Change colors</b> cannot be used.
Pick a shutter sound	Take a series of pictures (📖 40)	When <b>Take a series of pictures</b> is selected, the shutter sound is disabled.
Photo size	Decorate (📖 43)	When <b>Decorate</b> is selected, the <b>Photo size</b> setting is fixed at <b>Small (2 megapixels)</b> .
Print date	Take a series of pictures (📖 40)	When <b>Take a series of pictures</b> is selected, the date cannot be imprinted on images.

Restricted function	Option	Description
Electronic VR	Choose a style (📖 37)	When <b>Shoot night scenes, Shoot at intervals, Take a series of pictures, Photograph fireworks, or Shoot backlit scenes</b> is selected, electronic VR is disabled.
Digital zoom	Smile timer (📖 35)	When <b>Smile timer</b> is selected, digital zoom cannot be used.
	Choose a style (📖 37)	When <b>Shoot night scenes, Shoot under water, Shoot backlit scenes, Take soft pictures, or Create a diorama effect</b> is selected, digital zoom cannot be used.

## Focusing

The focus area varies depending on the shooting mode and settings.

### Using Face Detection

In the following shooting modes and settings, the camera uses face detection to automatically focus on human faces.

-  Point and shoot (📖 30)
- **Shoot at intervals** (📖 39) and **Take a series of pictures** (📖 40) when using **Choose a style**
- **Smile timer** (📖 35)

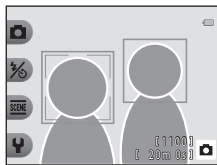

If the camera detects more than one face, a double border is displayed around the face that the camera focuses on, and single borders are displayed around the other faces.

If no faces are detected when the shutter-release button is pressed halfway, the camera focuses on the subject in the center of the frame.

#### **Notes About Face Detection**

- The camera's ability to detect faces depends on a variety of factors, including the direction in which the faces are looking.
- The camera may be unable to detect faces in the following situations:
  - When faces are partially hidden by sunglasses or otherwise obstructed
  - When faces take up too much or too little of the frame

## Using Skin Softening

When the shutter is released while using one of the shooting modes and settings listed below, the camera detects human faces and processes the image to soften facial skin tones (up to three faces).

-  Point and shoot (📖 30)
- **Smile timer** (📖 35)

### Notes About Skin Softening

- It may take more time than usual to save images after shooting.
- Under some shooting conditions, the desired skin softening results may not be achieved, and skin softening may be applied to areas of the image where there are no faces.

## Subjects Not Suitable for Autofocus

The camera may not focus as expected in the following situations. In some rare cases, the subject may not be in focus despite the fact that the focus area or the focus indicator glows green:

- Subject is very dark
- Objects of sharply differing brightness are included in the scene (e.g. the sun behind the subject makes that subject appear very dark)
- No contrast between the subject and surroundings (e.g. a portrait subject wearing a white shirt is standing in front of a white wall)
- Several objects are at different distances from the camera (e.g. the subject is inside a cage)
- Subjects with repeating patterns (window blinds, buildings with multiple rows of similarly shaped windows, etc.)
- Subject is moving rapidly

In the situations noted above, try pressing the shutter-release button halfway to refocus several times, or focus on another subject positioned at the same distance from the camera as the actual desired subject, and use focus lock (📖 55).



## Focus Lock

Focus lock shooting is recommended when the camera does not activate the focus area that contains the desired subject. The following explains how to use focus lock when  Point and shoot is enabled and the focus area is displayed in the center of the frame.

### 1 Position the subject in the center of the frame and press the shutter-release button halfway.

- Confirm that the focus area glows green.
- Focus and exposure are locked.

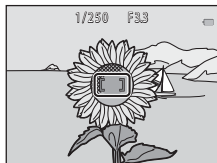

### 2 Without lifting your finger, recompose the picture.

- Make sure to maintain the same distance between the camera and the subject.

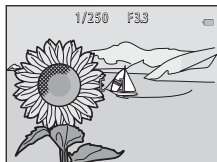

### 3 Press the shutter-release button the rest of the way down to take the picture.



# Playback Features

## Playback Zoom

Pressing the multi selector ▲ in full-frame playback mode (📖 24) zooms in on the image.

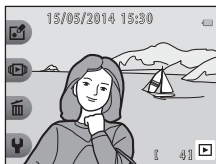

Image is displayed full-frame.



Image is zoomed in.

- You can change the zoom ratio by pressing ▲▼.
- To view a different area of the image, press flexible button 3 (🔒) to lock the zoom ratio and press ▲▼◀▶.
- If you want to change the zoom ratio, press flexible button 3 (🔓) and then change the zoom ratio as desired.
- If you are viewing an image that was captured using face detection, the camera zooms in on the face detected at the time of shooting (except when viewing an image size smaller than 320 × 240). To zoom in on an area of the image where there are no faces, press flexible button 3 (🔓) and then press ▲.
- When a zoomed image is displayed, press flexible button 1 (✕) to return to full-frame playback mode.

### ✂️ Crop: Creating a Cropped Copy

When using playback zoom, you can crop the image and save the displayed area of the image as a separate file by pressing flexible button 4 (✂️).

## Thumbnail Playback



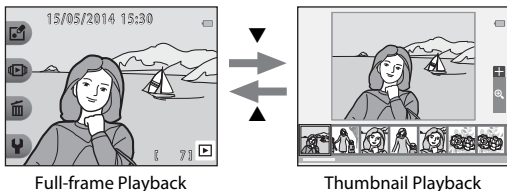







Press the multi selector ▼ in full-frame playback mode (📖 24) to display images in contact sheets of thumbnail images.















- While using thumbnail playback mode, press ◀▶ to select an image, and the selected image is magnified and displayed at the center of the screen. Select an image and press ▲, and the selected image is displayed in the full-frame playback mode.

## Functions Available in Playback Mode (Playback Menu)

When viewing images in full-frame playback mode, you can select one of the flexible buttons ( 6) and display the corresponding menu.

Playback menu	Option	Description	
 Have fun with pictures	Exchange messages <sup>1</sup>	Allows you to add voice messages to your images.	 2
	Picture play <sup>1</sup>	Allows you to edit your images using a variety of functions.	 7
	Grading	Allows you to add grade marks to your images. You can play back only images that have grade marks. Protects selected images from accidental deletion.	 16
 View	View by date	Allows you to play back images by selecting the shooting date from the calendar.	 20
	Slide show	Allows you to view images in an automatic slide show.	 21
	View movie <sup>2</sup>	Allows you to play back movies (  63).	 63

Playback menu	Option	Description	
 Erase	Erase this picture only	Allows you to delete only the image currently displayed (  25).	 25
	Erase selected pictures	Allows you to select multiple images and delete them (  26).	 26
	Erase all pictures	Allows you to delete all images (  25).	 25
 Settings	Retouch	Allows you to copy or rotate images or create a small copy of the current image.	 27
	Print order	Allows you to specify the image to be printed and the number of copies to be printed.	 32
	Camera settings	Allows you to change a number of general settings (  65).	 34

<sup>1</sup> Available when a still image is displayed.

<sup>2</sup> Available when a movie is displayed.

# Recording and Playing Back Movies

## Recording Movies

When no memory card is inserted (i.e., when using the camera's internal memory), the movie frame size (📄 50) can be set to 📺 **Small (640)** or 📺 **Small (old-fashioned)**.

### 1 Display the shooting screen.

- Check the remaining amount of movie recording time.



Movie recording time remaining

### 2 Press the ● (📺 movie-record) button to start movie recording.

- The camera focuses on the subject in the center of the frame.

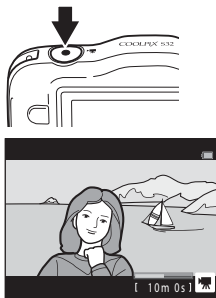

### 3 Press the ● (📺 movie-record) button again to end recording.

## Maximum Movie Length

Individual movie files cannot exceed 4 GB in size or 29 minutes in length, even when there is sufficient free space on the memory card for longer recording.

- The maximum movie length for a single movie is displayed on the shooting screen.
- Recording may end before either limit is reached if camera temperature becomes elevated.
- The actual movie length may vary depending on the movie content, subject movement, or type of memory card.

## Notes About Saving Movies

After a movie has been recorded, it is not fully saved to the internal memory or memory card until monitor display returns to the shooting display. **Do not open the battery-chamber/memory card slot cover or remove the battery or memory card.** Removing the memory card or the battery while a movie is being saved may result in loss of the movie data or damage to the camera or to the memory card.

## Notes About Movie Recording

- Memory cards with an SD Speed Class rating of 6 or faster are recommended when recording movies (🔋:23). Movie recording may stop unexpectedly when memory cards with a lower Speed Class rating are used.
- When recording movies while **Electronic VR** (📖 65, 📷38) in the camera settings is set to **Auto**, the angle of view (i.e., the area visible in the frame) is narrow compared to that of still images.
- The optical zoom ratio cannot be changed once recording starts.
- There may be some degradation in image quality when digital zoom is used.
- The sounds of multi selector operation, autofocus lens drive movement, and aperture operation when brightness changes may be recorded.
- The following phenomena may be seen in the monitor while recording movies. These phenomena are saved in the recorded movies.
  - Banding may occur in images under fluorescent, mercury-vapor, or sodium-vapor lighting.
  - Subjects that move quickly from one side of the frame to the other, such as a moving train or car, may appear skewed.
  - The entire movie image may be skewed when the camera is panned.
  - Lighting or other bright areas may leave residual images when the camera is moved.
- Depending on the distance to the subject or the amount of zoom applied, subjects with repeating patterns (fabrics, lattice windows, etc.) may have colored stripes (interference patterns, moire, etc.) in them during movie recording and playback. This occurs when the pattern in the subject and the layout of the image sensor interfere with each other; it is not a malfunction.

## **Camera Temperature**

- The camera may become warm when shooting movies for an extended period of time or when the camera is used in a hot area.
- If the inside of the camera becomes extremely hot when recording movies, the camera will automatically stop recording.

The amount of time remaining until the camera stops recording ( 10s) is displayed.

After the camera stops recording, it turns itself off.

Leave the camera off until the inside of the camera has cooled.

## **Notes About Autofocus**



Autofocus may not perform as expected ( 54). Should this occur, try the following:

Frame another subject—positioned at the same distance from the camera as the intended subject—in the center of the frame, press the  ( movie-record) button to start recording, and then modify the composition.





## Playing Back Movies

**1** Press the  (shooting/playback mode) button to switch to playback mode.

**2** Use the multi selector  to select the desired movie and press flexible button 2 (.

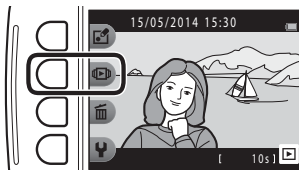
- Movies can be identified by the movie recording time indicator ( 5).



**3** Press flexible button 4 ( **View movie**).

- You can play movies.

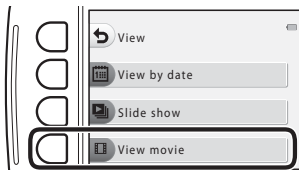

## Functions Available During Playback

You can use the flexible buttons to perform the following operations.

Paused

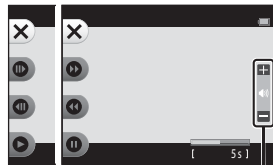

During playback

Volume indicator

Function	Icon	Description
Advance	⏭	Hold down the button to advance the movie.
Rewind	⏮	Hold down the button to rewind the movie.
Pause	⏸	Pause playback. The operations listed below can be performed while paused.
		⏭ Advance the movie one frame. Hold down the button for continuous advancing.
		⏮ Rewind the movie one frame. Hold down the button for continuous rewinding.
		▶ Resume playback.
End	✕	Return to full-frame playback mode.

## Adjusting Volume

Press the multi selector ▲▼ during playback.

## Deleting movies













To delete a movie, select the desired movie in full-frame playback mode (📖 24) and press flexible button 3 (🗑) (📖 25).



# General Camera Setup

## Camera Settings Menu

Enter shooting mode or playback mode → flexible button 4 (P) → flexible button 4 (P Camera settings)

The settings of the menu options listed below can be configured.

Option	Description	
Welcome screen	Allows you to select whether or not the welcome screen is displayed when the camera is turned on.	 34
Date and time	Allows you to set the camera clock.	 35
Brightness	Allows you to adjust the brightness of the monitor.	 36
Print date	Allows you to imprint the shooting date on images.	 37
Electronic VR	Allows you to choose whether to use electronic VR (vibration reduction) when shooting.	 38
AF assist	Allows you to enable or disable the AF-assist illuminator.	 39
Format memory/ Format card	Allows you to format the internal memory or the memory card.	 40
Language	Allows you to change the camera's display language.	 41
Menu background	Allows you to change the background used on the menu screen.	 41
Video mode	Allows you to adjust TV-connection settings.	 42
Charge by computer	Allows you to set whether or not the battery in the camera is charged when the camera is connected to a computer.	 43

Option	Description	
Reset all	Allows you to reset the camera's settings to their default values.	 44
Firmware version	View the current camera firmware version.	 44

# Connecting the Camera to a TV, Computer, or Printer

## Connection Methods

You can enhance your enjoyment of images and movies by connecting the camera to a TV, computer, or printer.

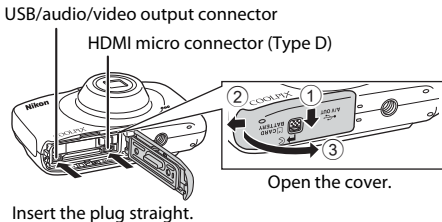

- Before connecting the camera to an external device, make sure the remaining battery level is sufficient and turn the camera off. Before disconnecting, make sure to turn the camera off.
- If the AC Adapter EH-62G (available separately) is used, this camera can be powered from an electrical outlet. Do not use any other make or model of AC adapter as it may cause the camera to heat up or malfunction.
- For information about the connection methods and subsequent operations, refer to the documentation included with the device in addition to this document.

## Viewing images on a TV

45



Images and movies captured with the camera can be viewed on a TV. Connection method: Connect the video and audio (stereo) plugs of the optional audio video cable to the TV's input jacks. Alternatively, connect a commercially available HDMI cable to the TV's HDMI input jack.

## Viewing and organizing images on a computer

69



You can transfer images to a computer to perform simple retouching and manage image data.

Connection method: Connect the camera to the computer's USB port with the USB cable.

- Before connecting to a computer, install ViewNX 2 on the computer (69).
- If any USB devices that draw the power from the computer are connected, disconnect them from the computer before you connect the camera to it. Connecting the camera and other USB-powered devices to the same computer simultaneously may cause a camera malfunction or excessive power supply from the computer, which could damage the camera or memory card.

## Printing images without using a computer

48



If you connect the camera to a PictBridge-compatible printer, you can print images without using a computer.

Connection method: Connect the camera directly to the printer's USB port with the USB cable.

## Using ViewNX 2

Install ViewNX 2 to upload, view, edit, and share photos and movies.



### Installing ViewNX 2

An Internet connection is required.

For system requirements and other information, see the Nikon website for your region.

- 1** Download the ViewNX 2 installer.  
Start the computer and download the installer from:  
*<http://nikonimglib.com/nvnx/>*
- 2** Double-click the downloaded file.
- 3** Follow the on-screen instructions.
- 4** Exit the installer.  
Click **Yes** (Windows) or **OK** (Mac).

# Transferring Images to the Computer

## 1 Choose how images will be copied to the computer.

Choose one of the following methods:

- **Direct USB connection:** Turn the camera off and ensure that the memory card is inserted in the camera. Connect the camera to the computer using the USB cable. The camera automatically turns on.  
To transfer images that are saved in the camera's internal memory, remove the memory card from the camera before connecting it to the computer.

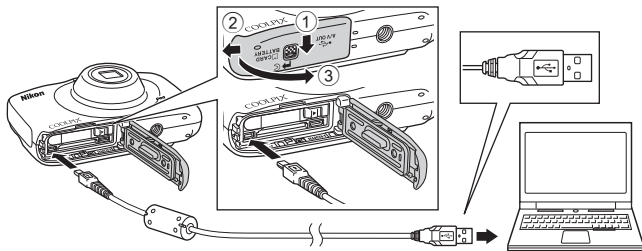

- **SD card slot:** If your computer is equipped with an SD card slot, the card can be inserted directly in the slot.
- **SD card reader:** Connect a card reader (available separately from third-party suppliers) to the computer and insert the memory card.



If a message is displayed prompting you to choose a program, select Nikon Transfer 2.

- **When using Windows 7**

If the dialog shown at right is displayed, follow the steps below to select Nikon Transfer 2.

- 1 Under **Import pictures and videos**, click **Change program**. A program selection dialog will be displayed; select **Import File using Nikon Transfer 2** and click **OK**.
- 2 Double-click **Import File**.



If the memory card contains a large number of images, it may take a while for Nikon Transfer 2 to start. Wait until Nikon Transfer 2 starts.

## Connecting the USB Cable

The connection may not be recognized if the camera is connected to the computer via a USB hub.

## 2 Transfer images to the computer.

- Click **Start Transfer**.

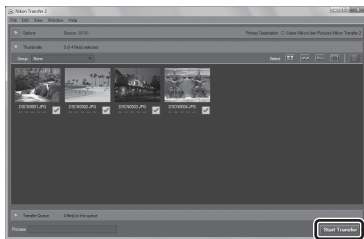

- At default settings, all the images on the memory card will be copied to the computer.

### 3 Terminate the connection.

- If the camera is connected to the computer, turn the camera off and disconnect the USB cable. If you are using a card reader or card slot, choose the appropriate option in the computer operating system to eject the removable disk corresponding to the memory card, and then remove the card from the card reader or card slot.

## Viewing Images

### Start ViewNX 2.

- Images are displayed in ViewNX 2 when transfer is complete.
- Consult online help for more information on using ViewNX 2.

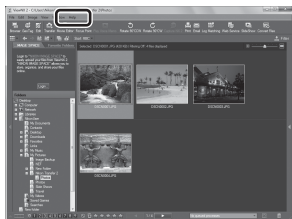

### Starting ViewNX 2 Manually

- **Windows:** Double-click the **ViewNX 2** shortcut icon on the desktop.
- **Mac:** Click the **ViewNX 2** icon in the Dock.







# Reference Section

The Reference Section provides detailed information and hints about using the camera.







## Have Fun with Pictures

---

 Exchange Messages.....	 2
 Picture Play .....	 7
 Grading .....	 16

## View

---

 View by Date .....	 20
 Slide Show .....	 21
 View Movie .....	 26



## Settings

---

 Retouch.....	 27
 Print Order .....	 32
 Camera Settings.....	 34



## Connections

---

Connecting the Camera to a TV .....	 45
Connecting the Camera to a Printer.....	 47

## Additional Information



---

Error Messages .....	 55
File Names.....	 58
Optional Accessories.....	 59

## Exchange Messages

Voice messages can be recorded and attached to images.

- You can attach up to two messages to each image.

Enter playback mode → select an image → flexible button 1 () → flexible button 2 ( Exchange messages)

## Leave a Message

- 1 Press flexible button 2 ( **Record**).



- 2 Press flexible button 2 ( **Leave a message**).

- You cannot select this option if the image already has a message attached to it. → "Leave a Reply" ()



### 3 Press flexible button 2 (○).

- Recording starts. You can record for up to about 20 seconds.
- Do not touch the microphone.
- Press flexible button 2 (○) again to stop recording.
- If battery power runs out, recording stops automatically.
- The message is saved when you press flexible button 4 (OK) in step 4. You can re-record the message as long as you do not press flexible button 4.
- Press flexible button 3 (●) to play back the message.
- Press flexible button 1 (↶) before or after recording a message to return to step 2.

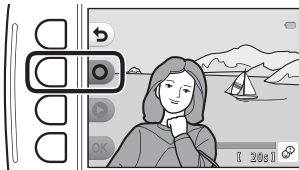

### 4 Press flexible button 4 (OK).

- **Message recorded.** is displayed and the message is attached to the image.
- Delete the current message before recording a new message (↶5).

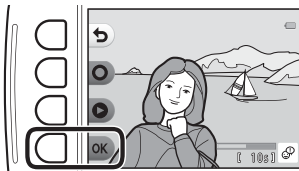

# Leave a Reply

1 Press flexible button 2 (○ Record).



2 Press flexible button 3 (🗨️ Leave a reply).

- You cannot select this option if the image does not have a message attached to it. → "Leave a Message" (🗨️)



3 Press flexible button 2 (○).

- Once recording starts, the operations are the same as explained in "Leave a Message" (🗨️).

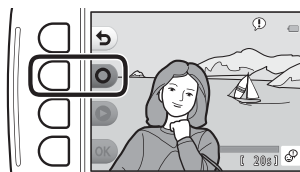

## Play Recordings

Press flexible button 3 (▶ **Play recordings**).

- The camera plays the message. If two messages have been recorded, they are played back to back.
- Press flexible button 1 (⏸) to stop playback.
- Use the multi selector ▲▼ during playback to adjust playback volume.
- If battery power runs out, playback stops automatically.

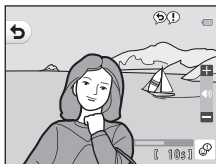

## Erase Recordings

**1** Press flexible button 4 (🗑 **Erase recordings**).

- If you select an image that has a grade mark (📐16), a confirmation message is displayed.
  - **○ Yes:** Removes the grade and displays the screen displayed in step 2.
  - **✗ No:** Returns to step 1.

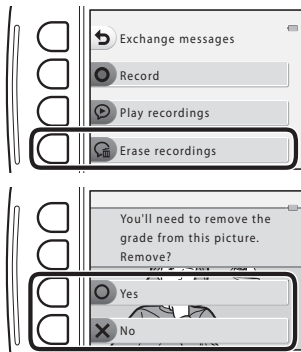

## 2 When the confirmation message is displayed, press flexible button 3 (O Yes).

- Only the recording is deleted. If both a message and a reply have been recorded, they are both deleted.

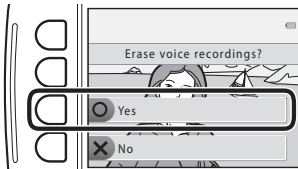



## **Picture Play**

### **Before Editing Images**





You can easily edit images on this camera. Edited copies are saved as separate files (except for **Rotate pictures**).

- Edited copies are saved with the same shooting date and time as the original.

### **Restrictions on Editing**

- An image can be edited up to ten times (there is no restriction on the number of times **Rotate pictures** can be applied).
- Images with an image size of 160 × 120 or smaller cannot be edited using **Picture play**.

## Make Photo Albums

Enter playback mode → flexible button 1 () → flexible button 3 ( Picture play) → use  to select  → flexible button 4 (**OK**)

Display images similarly to a photo album. Five different photo album designs are available. The created album is saved as a separate image of 13 megapixels (4160 × 3120) in size.

### 1 Use the multi selector to select an image.



### 2 Press flexible button 2 () .

- A check mark is displayed.
- A check mark is displayed or removed every time you press flexible button 2 () .
- Press flexible button 3 (**RESET**) to remove all check marks.
- Images are arranged in an album in the order the check marks were added.
- Up to 20 images can be selected.

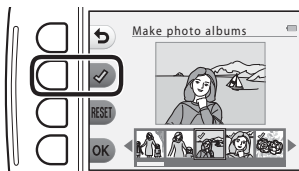

**3** Press flexible button 4 (**OK**).

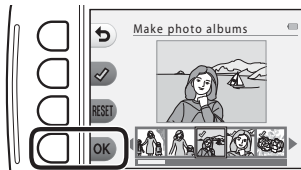

**4** Use ◀▶ to select the desired photo album design and press flexible button 4 (**OK**).

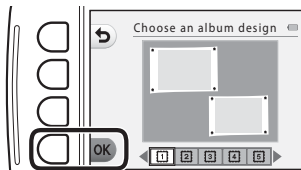



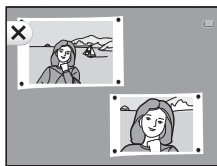

- Photo albums are displayed one page at a time. After all pages have been displayed, the camera returns to **Have fun with pictures** menu.
- To cancel before the photo album has been created, press flexible button 1 (**X**).



### **✓** Notes About Make Photo Albums

- Movies cannot be selected.
- This camera is unable to select images captured with other cameras.

## Add a Fisheye Effect

Enter playback mode → select an image → flexible button 1 () → flexible button 3 () → use   to select  → flexible button 4 (**OK**)



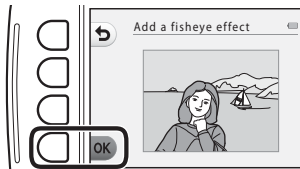

Make an image look as if it were captured with a fisheye lens. This effect is well-suited for images captured using **Shoot close-ups** in the shooting menu.

Confirm the effect and press flexible button 4 (**OK**).

- To cancel, press flexible button 1 ()



## Toy Camera

Enter playback mode → select an image → flexible button 1 () → flexible button 3 () → use   to select  → flexible button 4 (**OK**)

Make an image look as if it were shot with a toy camera. This effect is well-suited for landscapes.

Confirm the effect and press flexible button 4 (**OK**).

- To cancel, press flexible button 1 ()

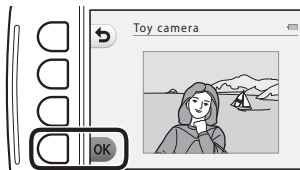

## 🌀 Soften Pictures

Enter playback mode → select an image → flexible button 1 (📺) → flexible button 3 (🖼️ Picture play) → use ◀▶ to select 🌀 → flexible button 4 (OK)

Soften the image by adding a slight blur around the center of the image. Four blur regions are available.

Use the multi selector ◀▶ to select the area to be blurred and press flexible button 4 (OK).

- To add a slight blur to the entire image, press **ALL**.
- To cancel, press flexible button 1 (📺).

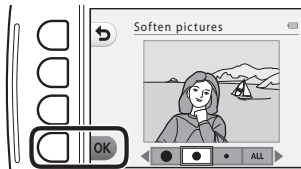

## ✳ Add Starbursts

Enter playback mode → select an image → flexible button 1 (📺) → flexible button 3 (🖼️ Picture play) → use ◀▶ to select ✳ → flexible button 4 (OK)



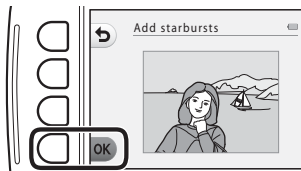

Produce star-like rays of light that radiate outward from bright objects such as sunlight reflections or street lights. This effect is suitable for night scenes.

Confirm the effect and press flexible button 4 (OK).

- To cancel, press flexible button 1 (📺).



## Add a Diorama Effect

Enter playback mode → select an image → flexible button 1 () → flexible button 3 (Picture play) → use  to select  → flexible button 4 (**OK**)

Make an image look like a miniature scene captured in macro mode. This effect is well-suited for images captured from a high vantage point with the main subject at the center of the image.

Confirm the effect and press flexible button 4 (**OK**).

- To cancel, press flexible button 1 ()

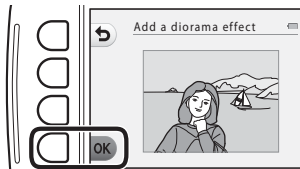

## Change Colors

Enter playback mode → select an image → flexible button 1 (⏪) → flexible button 3 (⏩) → flexible button 3 (Picture play) → use ◀▶ to select  → flexible button 4 (OK)

Adjust image colors.

Use the multi selector ◀▶ to select the desired setting and press flexible button 4 (OK).

- The following image color settings are available.
  - 1 Vivid color (default setting): Use to achieve a vivid, photoprint effect.
  - 2 Black-and-white: Save images in black-and-white.
  - 3 Sepia: Save images in sepia tones.
  - 4 Cyanotype: Save images in cyan-blue monochrome.
- To cancel, press flexible button 1 (⏪).

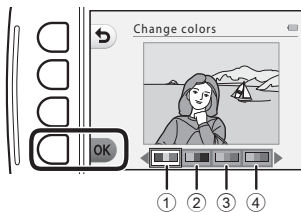

## Highlight Colors

Enter playback mode → select an image → flexible button 1 (Picture play) → flexible button 3 (Picture play) → use ◀▶ to select  → flexible button 4 (OK)

Keep one specified color in the image, and change the other colors to black and white.



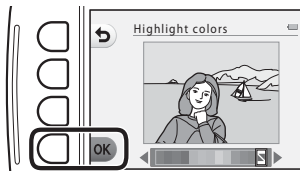

Use the multi selector ◀▶ to select a color and press flexible button 4 (OK).

- To cancel, press flexible button 1 (Picture play).







## Decorate

Enter playback mode → select an image → flexible button 1 () → flexible button 3 () → use  to select  → flexible button 4 (**OK**)

Add a frame around your images. Nine different frames are available. The image size of the edited copy varies depending on the size of the original image, as described below.

- When the original image is 2 megapixels (1600 × 1200) or larger, the copy is saved at 2 megapixels (1600 × 1200).
- When the original image is smaller than 2 megapixels (1600 × 1200), the copy is saved at the same size as the original.

Use the multi selector  to select the desired frame and press flexible button 4 (**OK**).

- The frame is added to the image and saved as a new copy.
- To cancel, press flexible button 1 () .
- Press flexible button 3 () to remove the frame.

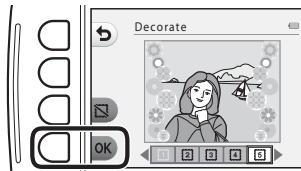

### Notes About Decorate

- The frame is placed on top of the image and therefore replaces the area of the image underneath it. Thicker frames cover up a larger area of the image.
- When using borderless printing to print images that you have added frames to, the frames may not be printed.

## Grading



Grade images by using  **Excellent** or  **Good**. You can use **View graded pictures** to play back only the images that have grade marks.

Enter playback mode → flexible button 1 () → flexible button 4 ( Grading)

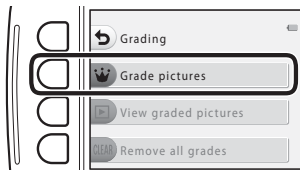

### Grade Pictures

- 1 Press flexible button 2 ( **Grade pictures**).

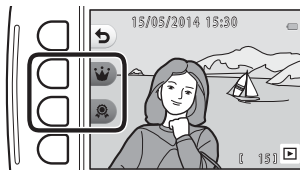

- 2 Use the multi selector  to select an image and press flexible button 2 () or flexible button 3 (.



- Grade marks ( or ) are displayed when viewing graded images.
- You cannot add two grade marks to a single image.
- Each grade mark can be added to up to 200 images.

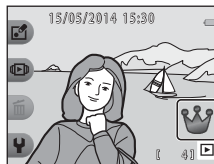

## Changing or Removing Grades from Individual Images

- 1 In step 2 (🔍16) of “Grade Pictures”, select the image with the grade you want to change or remove.

- Grade marks 👑 or 🚫 are added to graded images.

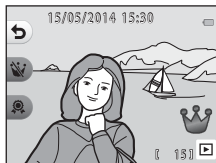

- 2 Change or remove the grade.

- Press flexible button 2 (👑) or flexible button 3 (🚫) to change the current grade to the selected grade.
- Press flexible button 2 (🚫) or flexible button 3 (👑) to remove the grade of the selected image.

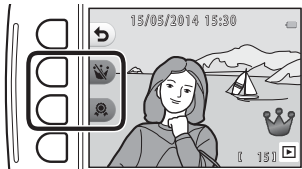

# View Graded Pictures

- 1** Press flexible button 3 (▶ **View graded pictures**).

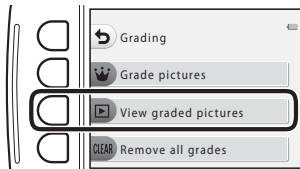

- 2** Press flexible button 2 (👑 **Excellent**) or flexible button 3 (👍 **Good**).

- Only images with the grade mark you selected are displayed.

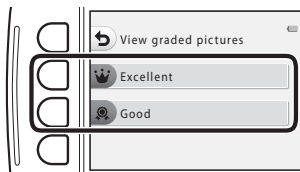

- 3** Use the multi selector ◀▶ to view images.

- Press ▲ to magnify the image.
- Press ▼ to switch to thumbnail playback mode.
- Press flexible button 1 (↶) to return to the screen displayed in step 2.
- Press flexible button 4 (✕) to return to full-frame playback mode (📖 24).



## ✓ Notes About View Graded Pictures

- Images cannot be edited, including changing or removing grades, when they are played back using **View graded pictures**.
- When movie files are played back, only the first frame of each movie is displayed.

# Remove All Grades

- 1 Press flexible button 4 (**CLEAR Remove all grades**).

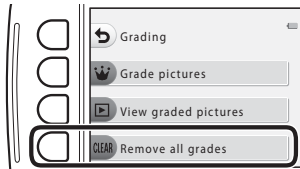

- 2 Press flexible button 2 (**Excellent**) or flexible button 3 (**Good**).

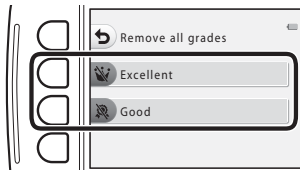

- 3 Press flexible button 3 (**Yes**).
  - The selected grade mark is removed from all images.

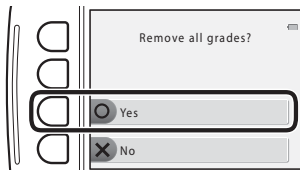



## ✓ Notes About Graded Images



When an image is graded, it is protected from accidental deletion. Note that formatting the camera's internal memory or the memory card (0040) permanently deletes graded images.

## View by Date

Play back images by selecting the shooting date from the calendar.



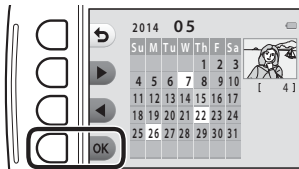

Enter playback mode → flexible button 2 () → flexible button 2 ( View by date)

### 1 Use the multi selector to select the desired date and press flexible button 4 (OK).

- Images are selected based on the selected date. The first image captured on that date is displayed.
- A white background of a date indicates that images were recorded on that date.
- Press flexible button 2 () to display the next month. Press flexible button 3 () to display the previous month.



### 2 Use to view images.

- Press  to magnify the image.
- Press  to switch to thumbnail playback mode.
- Press flexible button 1 () to return to the screen displayed in step 1.
- Press flexible button 4 () to return to full-frame playback mode ( 24).







### Notes About View by Date

- The 9000 most recent images can be displayed.
- Images captured when the camera's date is not set are treated as images captured on January 1, 2014.
- When movie files are played back, only the first frame of each movie is displayed.
- Images cannot be edited when they are played back using **View by date**.

## Slide Show

Play back images one by one in an automated “slide show.” When movie files are played back in the slide show, only the first frame of each movie is displayed.

Background music is played during playback. Background music varies depending on the theme selected under  **Choose a theme** (25).

Enter playback mode → flexible button 2 () → flexible button 3 ( Slide show)



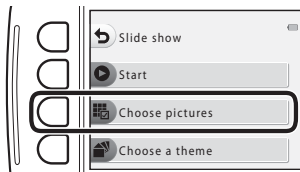

## Choose Pictures

### 1 Press flexible button 3 ( **Choose pictures**).

- To play back all images → step 3.



### 2 Use flexible button 2, 3, or 4 to select the images you want to play back.

-  **View graded pictures:** Only graded images are played back. Proceed to step 3.
-  **Choose by date:** Only images captured on the same day are played back. Select a date from the calendar, press flexible button 4 (**OK**), and continue from step 3.
-  **Pick a series:** Images captured using **Shoot at intervals** (39) are played back consecutively. This option can be selected only when images have been captured using **Shoot at intervals** (23).

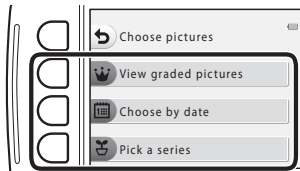

### 3 Press flexible button 2 (▶ Start).

- The slide show begins.

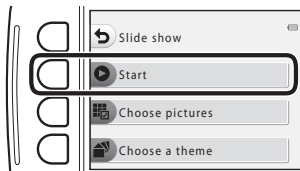

- To pause playback, press flexible button 4 (⏸).
- To exit, press flexible button 1 (↶).
- While the slide show is in progress, press the multi selector ▶ to display the next image or ◀ to display the previous image. Press and hold ▶ or ◀ to fast forward or rewind.
- Press ▲▼ during playback to adjust the volume of the background music.



### 4 End the slide show or restart it.

- The screen shown on the right is displayed when the slide show is paused.
  - ✕: Returns to the screen displayed in step 1.
  - ⏸: Displays the next image.
  - ◀: Displays the previous image.
  - ▶: Resumes playback.





## Pick a Series

### 1 Press flexible button 2 (📁 **Choose pictures**).

- The first image in the folder where images captured using **Shoot at intervals** are saved is displayed.

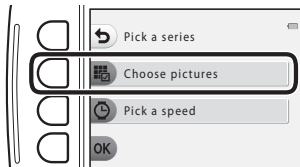

### 2 Use flexible button 2 (▶ **Next series**) or flexible button 3 (◀ **Previous series**) to select the folder and press flexible button 4 (OK).

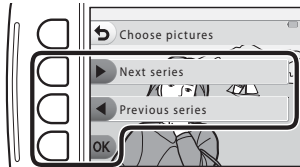

### 3 Press flexible button 3 (🕒 **Pick a speed**).

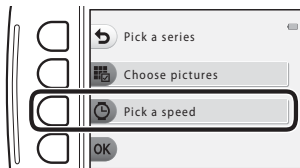

### 4 Use flexible button 2, 3, or 4 to select a desired speed.

- Select **Fast**, **Normal** (default setting), or **Slow**.

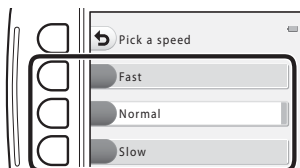

**5** Press flexible button 4 (**OK**).

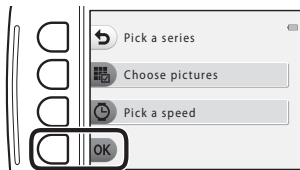

**6** Press flexible button 2 (**▶ Start**).

- The slide show begins.

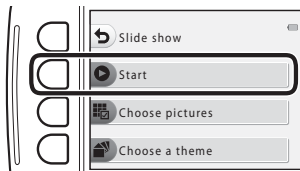

# Choose a Theme

- 1** Press flexible button 4 (🖱️ **Choose a theme**).

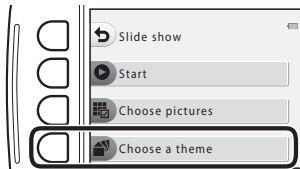

- 2** Use flexible button 2, 3, or 4 to select a playback theme.

- You can select  **Animated** (default setting),  **Pop art**, or  **Classic**.

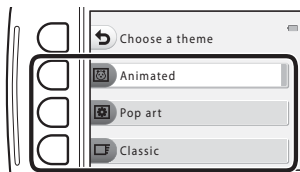

- 3** Press flexible button 2 (▶️ **Start**).

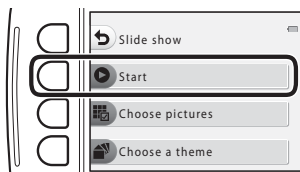

- The slide show begins.



## ✓ **Notes About Slide Show**

The maximum playback time is up to about 30 minutes.

## View Movie

Enter playback mode → flexible button 2 () → flexible button 4 ( View movie)

Play back movies ( 63). Available when a movie is displayed.

## Retouch

Copy or rotate images or create a small copy of the current image.

Enter playback mode → flexible button 4 (⏮) → flexible button 2 (🔍 Retouch)

## Copy

Copy images between the internal memory and a memory card.

**1** Press flexible button 2 (🔍 **Copy**).

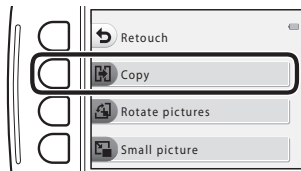

**2** Use flexible button 2 (📷 **Camera to card**) or flexible button 3 (📷 **Card to camera**) to select the copy source and destination.

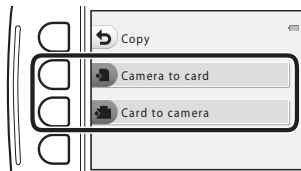

### 3 Use flexible button 2 (Selected images) or flexible button 3 (All images) to select the copy method.

- When All images is selected, proceed to step 7.



### 4 Use the multi selector ◀▶ to select an image.



### 5 Press flexible button 2 (✓).

- The selected image is indicated by a check mark.
- A check mark is displayed or removed each time you press flexible button 2 (✓).
- Press flexible button 3 (RESET) to remove all check marks.
- Repeat steps 4 and 5 to select additional images.

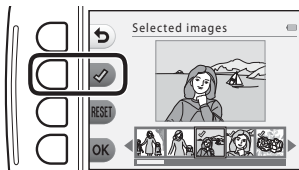



### 6 Press flexible button 4 (OK) to apply image selection.

- A confirmation dialog is displayed.

### 7 Press flexible button 3 (Yes).

- Images are copied.

## Notes About Copy

- Only files in formats that this camera can record can be copied.
- Operation is not guaranteed with images captured with another make of camera or that have been modified on a computer.
- The **Grade pictures** (16) and **Print order** (32) settings configured for images are not copied.

## Copying to a Memory Card That Contains No Images

When the camera is switched to playback mode, **Memory contains no images.** is displayed. You can select **Copy** by pressing any flexible button and selecting flexible button 2 ( **Retouch**).



## Rotate Pictures

Specify the orientation in which saved images are displayed during playback.

Still images can be rotated 90 degrees clockwise or 90 degrees counterclockwise.

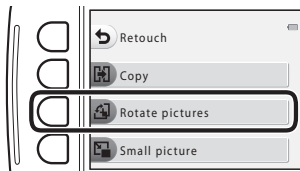
- 1 Press flexible button 3 ( **Rotate pictures**).



- 2 Press flexible button 2 () or flexible button 3 ().

- The image is rotated 90 degrees.

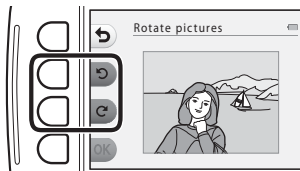

- 3 Press flexible button 4 (**OK**).

- The displayed orientation is applied, and the orientation information is saved with the image.

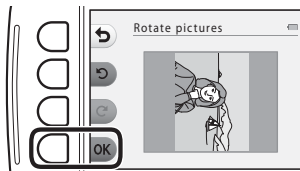





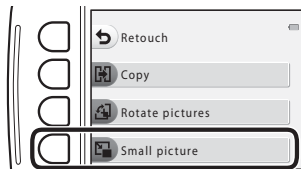

## **Small Picture**

Create a small copy of images.

- 1** Press flexible button 4 ( **Small picture**).



- 2** Use flexible button 2 () or flexible button 3 () to select the desired copy size and press flexible button 4 (**OK**).

- A new, edited copy is saved as a separate image with a compression ratio of about 1:16.
- To cancel, press flexible button 1 (.

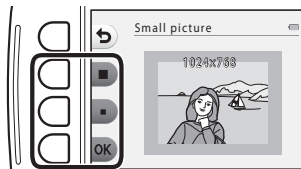

### **Notes About Small Picture**

Images with an image size of 640 × 480 or smaller cannot be edited using **Small picture**.

## Print Order

Enter playback mode → flexible button 4 (P) → flexible button 3 (Print order)

If you configure print order settings in advance, you can use them with the printing methods listed below.

- Taking the memory card to a digital photo lab that supports DPOF (Digital Print Order Format) printing.
- Inserting the memory card into a DPOF-compatible printer's card slot.
- Connecting the camera to a PictBridge-compatible printer (P47).

### 1 Press flexible button 2 (Select images).



### 2 Select images (up to 99) and the number of copies (up to nine) of each.

- Use the multi selector (◀▶) to select images and use flexible button 2 (+) or flexible button 3 (-) to set the number of copies for each.
- Images selected for printing are indicated by a check mark icon and the numeral indicating the number of copies to be printed. If no copies have been specified for images, the selection is canceled.
- Press flexible button 4 (OK) when setting is complete.

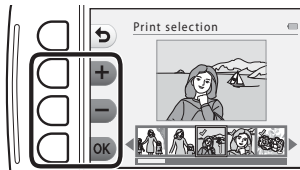

### 3 Use flexible button 2 or flexible button 3 to select whether or not to print shooting date and shooting information.

- **Date:** Print the shooting date on all images in the print order.
- **Info:** Print shutter speed and aperture value on all images in the print order.
- **Date** and **Info** turn on and off each time you press the corresponding flexible button.
- Lastly, press flexible button 4 (**OK**) to complete the print order.

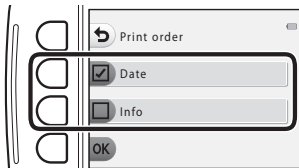

When Date is selected

### ✓ Notes About Printing Shooting Date and Shooting Information

- Some printers may not be able to print the shooting date and shooting information.
- Shooting information is not printed when the camera is connected to a printer.
- The **Date** and **Info** settings are reset each time the **Print order** option is displayed.
- The date printed is that saved when the image was captured.
- For images taken with the **Print date** (☞37) option enabled, only the date imprinted at the time of shooting is printed, even if the **Print order** date option is enabled for the images.



### ✂ Canceling Existing Print Order



Press flexible button 3 (**RESET Delete print order**) in step 1 of "Print Order" (☞32).

# Camera Settings

## Welcome Screen

Enter shooting mode or playback mode → flexible button 4 ( ) → flexible button 4 ( Camera settings) → flexible button 2 ( Welcome screen)

Select whether or not the welcome screen is displayed when you turn on the camera.

Option	Description
 Off	Does not display the welcome screen.
 On (default setting)	Displays an animated welcome screen. How often you use the camera and how many images you have taken with the camera affect the displayed characters.

## Date and Time

Enter shooting mode or playback mode → flexible button 4 (P) → flexible button 4 (P Camera settings) → flexible button 3 (⊕ Date and time)

Set the camera clock.

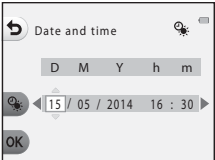
Option	Description
⊕ Date format	Select <b>Year/Month/Day</b> , <b>Month/Day/Year</b> , or <b>Day/Month/Year</b> .
⊕ Date and time	<ul style="list-style-type: none"><li>Select an item: Press the multi selector ◀▶ (changes between <b>D</b>, <b>M</b>, <b>Y</b>, <b>h</b>, and <b>m</b>).</li><li>Edit the date and time: Press ▲▼.</li><li>Apply the setting: Select <b>m</b> and press flexible button 4 (OK).</li><li>Press flexible button 3 (☀) to enable daylight saving time. When the daylight saving time function is enabled, ☀ is displayed in the monitor and the time advances one hour. Press flexible button 3 (☀) again to disable the daylight saving time function.</li></ul> 

## Brightness

Enter shooting mode or playback mode → flexible button 4 (P) → flexible button 4 (P Camera settings) → flexible button 4 (⚙️ Brightness)

Select from five settings. The default setting is 3.

- Use the multi selector ◀▶ to select the desired brightness and press flexible button 4 (OK).

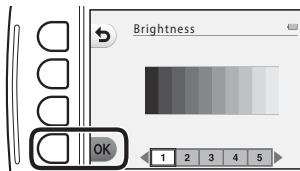

## Print Date

Enter shooting mode or playback mode → flexible button 4 (P) → flexible button 4 (P Camera settings) → press ▼ → flexible button 2 (DATE) Print date)

The shooting date can be imprinted on the images when shooting, allowing the information to be printed even from printers that do not support date printing (📷33).



Option	Description
 Date	Date is imprinted on images.
<b>OFF</b> Off (default setting)	Date is not imprinted on images.



### Notes About Print Date

- Imprinted dates form a permanent part of image data and cannot be deleted. The date cannot be imprinted on images after they have been captured.
- The date cannot be imprinted in the following situations:
  - When using **Take a series of pictures**
  - When shooting movies

# Electronic VR

Enter shooting mode or playback mode → flexible button 4 (P) → flexible button 4 (P Camera settings) → press ▼ → flexible button 3 (M) Electronic VR)

Select whether to use electronic VR (vibration reduction) when shooting.

Option	Description
 Auto	<p>In the following conditions, the effects of camera shake are reduced when shooting.</p> <ul style="list-style-type: none"><li>• When the flash mode is set to  <b>Flash off</b></li><li>• When the shutter speed is slow</li><li>• When the subject is dark</li></ul> <p>Vibration reduction is always applied during movie recording.</p>
<b>OFF</b> Off (default setting)	Electronic VR is disabled.

## Notes About Electronic VR

- Electronic VR is disabled while the flash is used.
- If the exposure period exceeds a certain period of time, electronic VR will not function.
- Electronic VR cannot be used when using the following styles.
  - **Shoot night scenes** (📖 38)
  - **Shoot at intervals** (📖 39)
  - **Take a series of pictures** (📖 40)
  - **Photograph fireworks** (📖 40)
  - **Shoot backlit scenes** (📖 40)
- Even when electronic VR is set to **Auto**, depending on the scene (📖 30) automatically selected by the camera when using  Point and shoot mode, the electronic VR may not function.
- The effectiveness of electronic VR decreases as camera shake increases.
- The images captured may be somewhat “grainy” in appearance.



## AF Assist

Enter shooting mode or playback mode → flexible button 4 (P) → flexible button 4 (P Camera settings) → press ▼ → flexible button 4 (AF) AF assist

Enable or disable the AF-assist illuminator which assists autofocus operation.

Option	Description
<b>AUTO</b> Auto (default setting)	The AF-assist illuminator automatically lights up when the subject is dimly lit. The illuminator has a range of about 1.7 m (5 ft 6 in.) at the maximum wide-angle position and about 1.5 m (4 ft 11 in.) at the maximum telephoto position. <ul style="list-style-type: none"><li>Note that for some settings, the AF-assist illuminator may not light.</li></ul>
<b>OFF</b> Off	The AF-assist illuminator does not light.

## Format Memory/Format Card

Enter shooting mode or playback mode → flexible button 4 (P) → flexible button 4 (P Camera settings) → press ▼ twice → flexible button 2 (Format memory/Format card)

Use this option to format the internal memory or a memory card.

**Formatting the internal memory or memory cards permanently deletes all data. Data that has been deleted cannot be recovered.** Make sure to transfer important images to a computer before formatting.

- Do not turn the camera off or open the battery-chamber/memory card slot cover during formatting.

### Formatting the Internal Memory

Remove the memory card from the camera. The **Format memory** option is displayed in the camera settings menu.

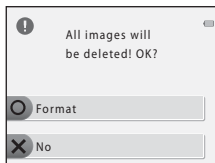

### Formatting Memory Cards

Insert a memory card in the camera. The **Format card** option is displayed in the camera settings menu.

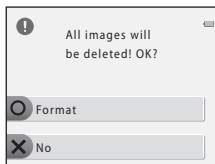

## Language

Enter shooting mode or playback mode → flexible button 4 (P) → flexible button 4 (P Camera settings) → press ▼ twice → flexible button 3 (Language)

Select a language for display of camera menus and messages.

---

## Menu Background

Enter shooting mode or playback mode → flexible button 4 (P) → flexible button 4 (P Camera settings) → press ▼ twice → flexible button 4 (Menu background)

Select one of five background designs to be used for a menu screen or thumbnail playback mode.

- Use the multi selector ◀▶ to select the desired design and press flexible button 4 (OK).
- To restore the default background image, press flexible button 3 (RESET).

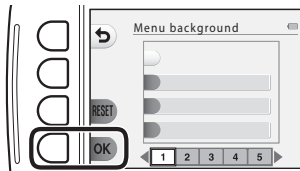

## Video Mode

Enter shooting mode or playback mode → flexible button 4 (⏏) → flexible button 4 (⏏ Camera settings) → press ▼ three times → flexible button 2 (📺 Video mode)

Adjust settings for connection to a TV.

Select from **NTSC** and **PAL**.

Both **NTSC** and **PAL** are standards for analog color television broadcasting.

## Charge by Computer

Enter shooting mode or playback mode → flexible button 4 (P) → flexible button 4 (P Camera settings) → press ▼ three times → flexible button 3 (Charge by computer)

Option	Description
<b>AUTO</b> Auto (default setting)	When the camera is connected to a computer that is running (67), the battery inserted into the camera is automatically charged using power supplied by the computer.
<b>OFF</b> Off	The battery inserted into the camera is not charged when the camera is connected to a computer.

### Notes About Charging with a Computer

- When connected to a computer, the camera automatically turns on and starts charging. If the camera is turned off, charging stops.
- About 2 hours and 40 minutes are required to charge a fully exhausted battery. Charging time increases when images are transferred while the battery is charging.
- The camera turns off automatically if there is no communication with the computer for 30 minutes after the battery has finished charging.

### When the Charge Lamp Quickly Flashes Green

Charging cannot be performed, possibly due to one of the reasons described below.

- The ambient temperature is not suited to charging. Charge the battery indoors with an ambient temperature of 5°C to 35°C (41°F to 95°F).
- The USB cable is not connected correctly, or the battery is faulty. Make sure the USB cable is connected correctly and replace the battery if necessary.
- The computer is in sleep mode and is not supplying power. Wake up the computer.
- The battery cannot be charged because the computer cannot supply power to the camera due to the computer's settings or its specifications.

## Reset All

Enter shooting mode or playback mode → flexible button 4 (P) → flexible button 4 (P Camera settings) → press ▼ three times → flexible button 4 (CLEAR Reset all)

When flexible button 3 (O **Reset**) is selected, the camera's settings are restored to their default values.

- Some settings, such as **Date and time** or **Language**, are not reset.



### Resetting File Numbering

To reset file numbering to "0001", delete all images saved in the internal memory or on the memory card (📖 25) before selecting **Reset all**.

---

## Firmware Version

Enter shooting mode or playback mode → flexible button 4 (P) → flexible button 4 (P Camera settings) → press ▼ four times → flexible button 2 (Ver. Firmware version)

View the current camera firmware version.

# Connecting the Camera to a TV

## 1 Turn off the camera and connect it to the TV.

- Make sure that the plugs are properly oriented. Do not insert or remove the plugs at an angle when connecting or disconnecting them.

### When using the audio/video cable

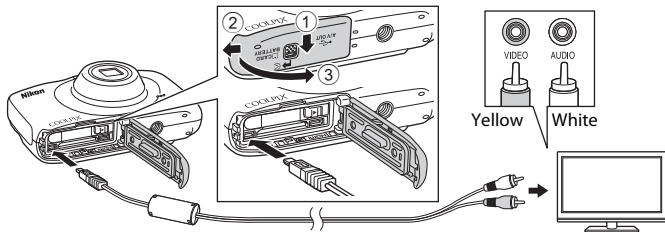

### When using a commercially available HDMI cable

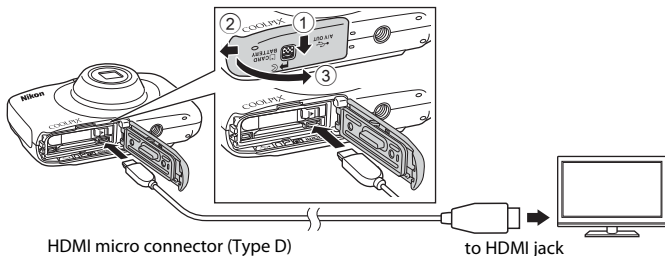

## 2 Set the TV's input to external video input.

- See the documentation provided with your TV for details.

## 3 Hold down the (shooting/playback mode) button to turn on the camera.

- Images are displayed on the TV.
- The camera monitor does not turn on.

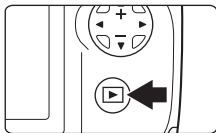

### If Images Are Not Displayed on the TV

Make sure that the camera's **Video mode** () setting in the camera settings menu conforms to the standard used by your TV.

### Using a TV Remote Control

The remote control of an HDMI-CEC-compatible TV can be used to select images, start and pause movie playback, switch between full-screen playback mode and thumbnail display, etc.

- Connect the camera and TV using an HDMI cable.
- Aim the remote control at the TV when operating it.

### HDMI and HDMI-CEC

HDMI (High-Definition Multimedia Interface) is a multimedia interface. HDMI-CEC (HDMI-Consumer Electronics Control) allows compatible devices to inter-operate.



## Connecting the Camera to a Printer

Users of PictBridge-compatible printers can connect the camera directly to the printer and print images without using a computer.

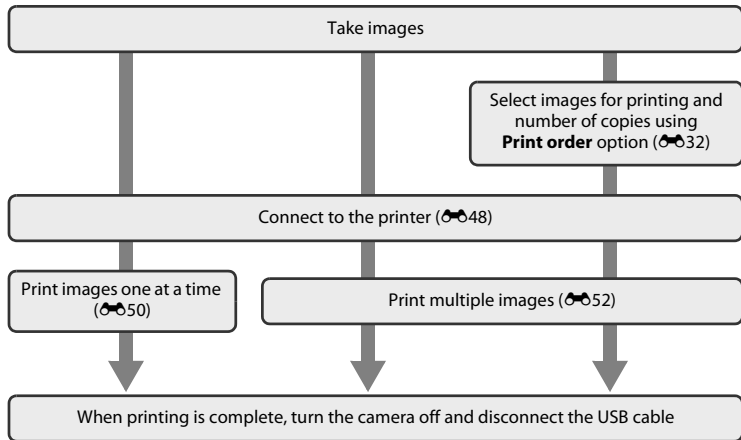

# Connecting the Camera to a Printer

- 1 Turn off the camera.
- 2 Turn on the printer.
  - Check printer settings.
- 3 Connect the camera to the printer using the USB cable.
  - Make sure that the plugs are properly oriented. Do not insert or remove the plugs at an angle when connecting or disconnecting them.

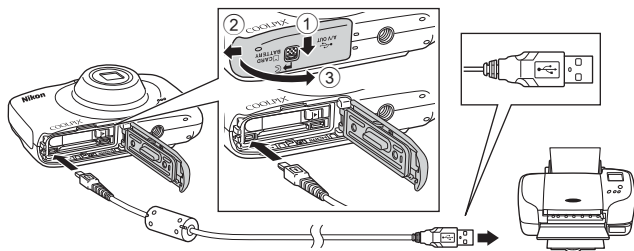

## 4 The camera is automatically turned on.

- The **PictBridge** startup screen (①) is displayed in the camera monitor, followed by the **Print selection** screen (②).

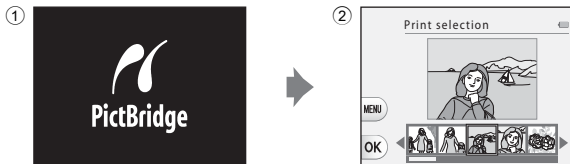

### ✔ If the PictBridge Startup Screen Is Not Displayed

When **Auto** is selected for **Charge by computer** (0643), it may be impossible to print images with direct connection of the camera to some printers. If the PictBridge startup screen is not displayed after the camera is turned on, turn the camera off and disconnect the USB cable. Set **Charge by computer** to **Off** and reconnect the camera to the printer.

# Printing Individual Images

- 1 Use the multi selector ◀▶ to select an image to be printed and press flexible button 4 (OK).

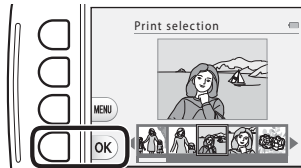

- 2 Press flexible button 3 (Copies).

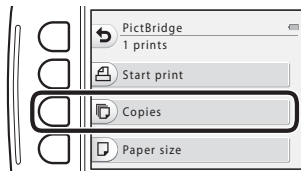

- 3 Use ▲▼ to select the desired number of copies (up to nine) and press flexible button 4 (OK).

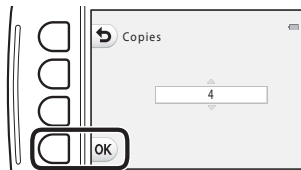

#### 4 Press flexible button 4 (📄 Paper size).

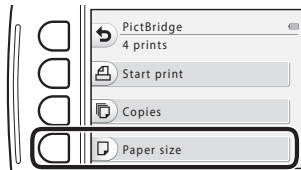

#### 5 Use ◀▶ to select the paper size and press flexible button 4 (OK).

- To apply the paper size setting configured on the printer, select **Default** as the paper size option.
- The paper size options available on the camera vary depending on the printer that you use.

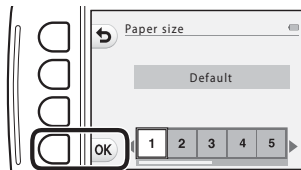

#### 6 Press flexible button 2 (🖨️ Start print).

- Printing starts.
- To cancel printing, press flexible button 4 (✖ Cancel).

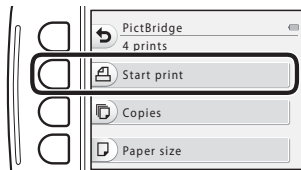

# Printing Multiple Images

- 1 When the **Print selection** screen is displayed, press flexible button 3 (**MENU**).

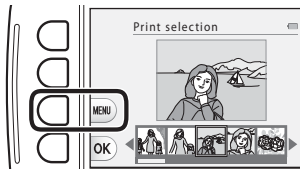

- 2 Press the multi selector ▼ and press flexible button 2 (□ **Paper size**).

- To exit the print menu, press flexible button 1 (↶).

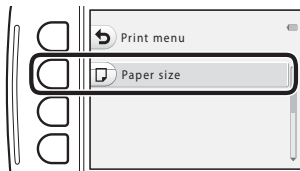

- 3 Use ◀▶ to select the paper size and press flexible button 4 (**OK**).

- To apply the paper size setting configured on the printer, select **Default** in the paper size option.
- The paper size options available on the camera vary depending on the printer that you use.

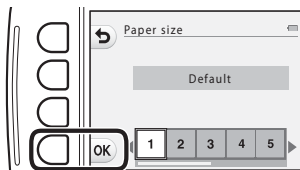

**4** Press ▲, and then press flexible button 2, 3, or 4 to select the print method.

- Select  **Print selection**, **ALL Print all images**, or **DPOF DPOF printing**.

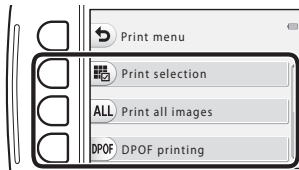

### Print selection

Select images (up to 99) and the number of copies (up to nine) of each.

- Use the multi selector ◀▶ to select images and use flexible button 2 (⊕) or flexible button 3 (⊖) to specify the number of copies to be printed.
- Images selected for printing are indicated by a check mark and the numeral indicating the number of copies to be printed. If no copies have been specified for images, the selection is canceled.
- Press flexible button 4 (OK) when setting is complete.
- When the screen shown on the right is displayed, press flexible button 2 (🖨️) to start printing. **Start print**

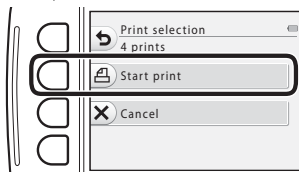
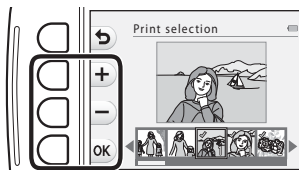

## Print all images

One copy each of all images saved in the internal memory, or on the memory card, is printed.

- When the screen shown on the right is displayed, press flexible button 2 (🖨️ **Start print**) to start printing.

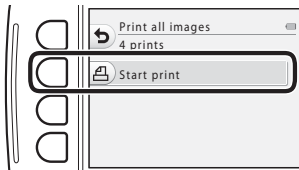

## DPOF printing

Print images for which a print order was created using the **Print order** option (032).

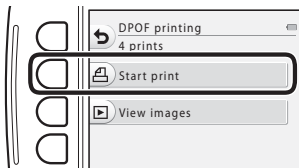

- When the screen shown on the right is displayed, press flexible button 2 (🖨️ **Start print**) to start printing. To view the current print order, press flexible button 3 (🖼️ **View images**). To start printing, press flexible button 4 (OK).























## Error Messages

Refer to the table below if an error message is displayed.

Display	Cause/Solution	
Battery temperature is elevated. The camera will turn off.	The camera turns off automatically. Wait until the camera or battery temperature has cooled before resuming use.	-
The camera will turn off to prevent overheating.		
Memory card is write protected.	The write-protect switch is in the "lock" position. Slide the write-protect switch to the "write" position.	-
This card cannot be used.	An error occurred while accessing the memory card. <ul style="list-style-type: none"> <li>• Use an approved card.</li> <li>• Check that the terminals are clean.</li> <li>• Confirm that the memory card is correctly inserted.</li> </ul>	 23 12 12
This card cannot be read.		
Card is not formatted. Format card?	The memory card has not been formatted for use in the camera. Formatting deletes all data saved on the memory card. If you need to keep copies of any images, make sure to press flexible button 4 ( <b>X No</b> ) and save the copies to a computer or other medium before formatting the memory card. Press flexible button 3 ( <b>O Yes</b> ) to format the memory card.	 7
Out of memory.	Delete images or insert a new memory card.	12, 25, 64

Display	Cause/Solution	
Image cannot be saved.	An error occurred while saving the image. Insert a new memory card or format the internal memory or memory card.	 40
	The camera has run out of file numbers. Insert a new memory card or format the internal memory or memory card.	 40
	There is insufficient space to save the copy. Delete images from the destination.	25
No further pictures can be graded.	200 images have already been graded. Remove some grades.	 17,  19
Image cannot be modified.	Select images that support the editing function.	 7,  16
Cannot record movie.	A time-out error occurred while saving the movie on the memory card. Select a memory card with a faster write speed.	61,  23
Memory contains no images.	There are no images in the internal memory or on the memory card. <ul style="list-style-type: none"> <li>Remove the memory card from the camera to play back images in the camera's internal memory.</li> <li>To copy the images saved in the camera's internal memory to the memory card, select <b>Copy</b> in the retouch menu.</li> </ul>	13  27
File contains no image data.	The file was not created or edited with this camera. The file cannot be viewed on this camera. View the file using a computer or the device used to create or edit this file.	–
All images are hidden.	There are no images available for a slide show.	 21
Lens error	A lens error occurred. Turn the camera off and then on again. If the error persists, contact your retailer or Nikon-authorized service representative.	18

Display	Cause/Solution	
Communications error	An error occurred while communicating with the printer. Turn the camera off and reconnect the USB cable.	 48
System error	An error occurred in the camera's internal circuitry. Turn the camera off, remove and reinsert the battery, and turn the camera on. If the error persists, contact your retailer or Nikon-authorized service representative.	8, 18
Printer error: check printer status.	After solving the problem, press flexible button 3 (  <b>Resume</b> ) to resume printing.*	–
Printer error: check paper.	Load the specified size of paper and press flexible button 3 (  <b>Resume</b> ) to resume printing.*	–
Printer error: paper jam.	Remove the jammed paper and press flexible button 3 (  <b>Resume</b> ) to resume printing.*	–
Printer error: out of paper.	Load the specified size of paper and press flexible button 3 (  <b>Resume</b> ) to resume printing.*	–
Printer error: check ink.	There is a problem with the printer's ink. Check the ink and press flexible button 3 (  <b>Resume</b> ) to resume printing.*	–
Printer error: out of ink.	Replace the ink cartridge and press flexible button 3 (  <b>Resume</b> ) to resume printing.*	–
Printer error: file corrupt.	There is a problem with the image file to be printed. Select flexible button 4 (  <b>Cancel</b> ) to cancel printing.	–

\* See the documentation provided with your printer for further guidance and information.

# File Names

Images, movies, or messages are assigned file names as follows.

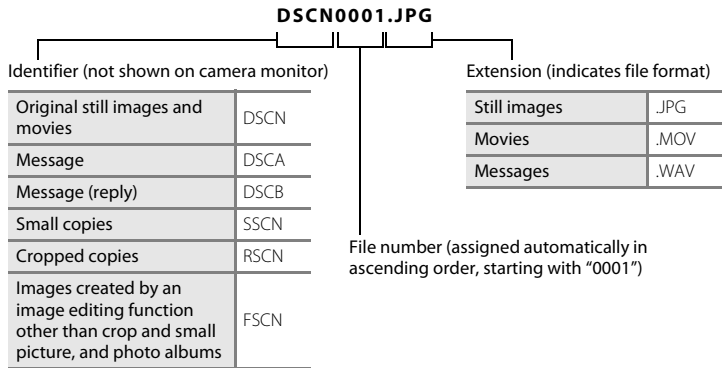

- Voice message file numbers are the same numbers as the images to which the messages are attached.

## Optional Accessories

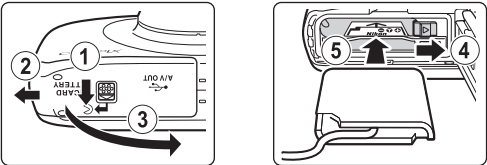
Battery charger	Battery Charger MH-66 (Charging time when no charge remains: Approx. 1 h 50 min)
AC adapter	<p data-bbox="274 188 613 209">AC Adapter EH-62G (connect as shown)</p> <div data-bbox="319 225 874 412"></div> <p data-bbox="274 426 928 470">Make sure that the power connector cord has been properly aligned in power connector grooves, then insert the AC adapter in the battery chamber.</p> <ul data-bbox="274 474 928 567" style="list-style-type: none"><li>• While using the AC adapter, the battery-chamber/memory card slot cover cannot be closed. Do not pull the power cord. If the cord is pulled, the connection between the camera and power source is interrupted, and the camera turns off.</li></ul>
Audio/video cable	Audio Video Cable EG-CP14

Accessories are not waterproof.

Availability may vary with country or region.

See our website or brochures for the latest information.



A series of ten horizontal dashed lines spanning the width of the page, intended for handwriting practice.



# Technical Notes and Index

<b>Caring for the Product</b> .....	<b>2</b>
The Camera.....	2
The Battery.....	5
Charging AC Adapter.....	6
Memory Cards .....	7
<b>Cleaning and Storage</b> .....	<b>8</b>
Cleaning.....	8
Storage.....	9
<b>Troubleshooting</b> .....	<b>10</b>
<b>Specifications</b> .....	<b>18</b>
Approved Memory Cards .....	23
<b>Index</b> .....	<b>26</b>

# Caring for the Product

## The Camera

To ensure continued enjoyment of this Nikon product, observe the precautions described below in addition to the warnings in "For Your Safety" (📖 viii-xi) and "<Important> Shockproof, Waterproof, Dustproof, Condensation" (📖 xv-xxi) when using or storing the device.

### **Do Not Drop**

The product may malfunction if subjected to strong shock or vibration. Additionally, do not touch or apply force to the lens.

### **Handle the Lens and All Moving Parts with Care**

Do not apply force to the lens, lens cover, monitor, memory card slot, or battery chamber. These parts are easily damaged. Applying force to the lens cover could result in camera malfunction or damage to the lens. Should the monitor break, care should be taken to avoid injury caused by broken glass and to prevent the liquid crystal from the display touching the skin or entering the eyes or mouth.

### **Do Not Allow Damp to Enter Inside the Camera**

This camera is provided with JIS/IEC protection class 8 (IPX8) equivalent waterproofing. If water seeps inside the camera, however, this could cause the components to rust and result in a high repair charge or the camera may not be repairable.

After using the camera at the beach or underwater, make sure that the battery-chamber/memory card slot cover is firmly closed, and then immerse the camera in a shallow container filled with freshwater for 10 minutes.

After using the camera underwater, do not leave the camera wet for 60 minutes or more. This could cause deterioration of the waterproofing performance.



## **Prevent Water From Seeping Inside the Camera**

If the inside of the camera becomes wet, this could result in camera malfunction and the camera may not be repairable. To prevent water seeping (water submersion) accidents, be sure to observe the following cautions when using the camera.

- When the battery-chamber/memory card slot cover is closed, make sure that the camera strap, hair, lint, dust, sand grains, other foreign substances, or dirt are not attached on the waterproofing packing and portions that make a contact with the waterproofing packing.
- Do not open or close the battery-chamber/memory card slot cover in areas exposed to water spray, high winds, dust or sand.
- When an external force is applied on the camera, it could become deformed or the airtight seals may become damaged and cause water to seep inside the camera. Do not place a heavy object on the camera, drop the camera, or apply excessive force on the camera.
- If water seeps inside the camera, immediately stop using the camera. Wipe off moisture from the camera, and at once take the camera to your Nikon-authorized service representative.

## **Shock and Vibration**

Do not drop the camera, strike it against a hard object such as a rock, or throw it at a water surface.

Do not leave the camera in an area subject to vibration. If the camera is subjected to excessive shock, this could result in camera malfunction or damage.

## **Maximum Depth**

This camera is designed to withstand water pressure up to a depth of 10 m (33 ft) for approx. 60 minutes. At greater depth, water could seep inside the camera, resulting in camera malfunction.

## **Avoid Sudden Changes in Temperature**

- Sudden changes in temperature, such as when entering or leaving a heated building on a cold day, can cause condensation to form inside the device. To prevent condensation, place the device in a carrying case or a plastic bag before exposing it to sudden changes in temperature.
- Do not expose the camera to high temperatures by leaving it on the beach or in direct sunlight before entering the water.

### **Keep away from Strong Magnetic Fields**

Do not use or store this device in the vicinity of equipment that generates strong electromagnetic radiation or magnetic fields. Strong static charge or the magnetic fields produced by equipment such as radio transmitters could interfere with the monitor, damage data saved on the memory card, or affect the product's internal circuitry.

### **Do Not Point the Lens at Strong Light Sources for Extended Periods**

Avoid pointing the lens at the sun or other strong light sources for extended periods when using or storing the camera. Intense light may cause deterioration of the image sensor, producing a white blur effect in photographs.

### **Turn the Product off Before Removing or Disconnecting the Power Source**

Do not remove the battery while the product is on, or while images are being saved or deleted. Forcibly cutting power in these circumstances could result in loss of data or in damage to product memory or internal circuitry.

### **Notes About the Monitor**

- Monitors and electronic viewfinders are constructed with extremely high precision; at least 99.99% of pixels are effective, with no more than 0.01% being missing or defective. Hence while these displays may contain pixels that are always lit (white, red, blue, or green) or always off (black), this is not a malfunction and has no effect on images recorded with the device.
- Images in the monitor may be difficult to see under bright lighting.
- The monitor is lit by an LED backlight. Should the monitor begin to dim or flicker, contact your Nikon-authorized service representative.

## The Battery

- Be sure to read and follow the warnings in “For Your Safety” (📖 viii-xi) before use.
- Check the battery level before using the camera and replace or charge the battery if necessary. Do not continue charging once the battery is fully charged as this will result in reduced battery performance. Whenever possible, carry a fully charged spare battery when taking pictures on important occasions.
- Do not use the battery at ambient temperatures below 0°C (32°F) or above 40°C (104°F).
- Charge the battery indoors with an ambient temperature of 5°C to 35°C (41°F to 95°F) before use.
- When the battery temperature is between 45°C–55°C (113°F–131°F), the chargeable capacity may decrease.
- When charging the battery inserted into this camera using the Charging AC Adapter or a computer, the battery is not charged at ambient temperatures below 5°C (41°F) or above 55°C (131°F).
- Note that the battery may become hot during use; wait for the battery to cool before charging. Failure to observe these precautions could damage the battery, impair its performance, or prevent it from charging normally.
- On cold days, the capacity of batteries tends to decrease. If an exhausted battery is used at a low temperature, the camera will not turn on. Be sure that the battery is fully charged before heading outside to take pictures in cold weather. Keep spare batteries in a warm place and exchange as necessary. Once warmed, a cold battery may recover some of its charge.
- Dirt on the battery terminals can prevent the camera from functioning. Should the battery terminals become dirty, wipe them off with a clean, dry cloth before use.
- If the battery will not be used for some time, insert it in the camera and completely exhaust it before removing it for storage. The battery should be stored in a cool location with an ambient temperature of 15°C–25°C (59°F–77°F). Do not store the battery in hot or extremely cold locations.
- Always remove the battery from the camera or battery charger when it is not being used. When inserted, minute amounts of current are drawn from the battery even when not in use. This may result in excessive draining of the battery and complete loss of function. Turning the camera on or off while the battery is exhausted can result in reduced battery life.
- Recharge the battery at least once every six months and completely exhaust it before returning it to storage.

- After removing the battery from the camera or battery charger, put the battery in a plastic bag and store it in a cool place.
- A marked drop in the time a fully-charged battery retains its charge, when used at room temperature, indicates that the battery needs to be replaced. Purchase a new EN-EL19 battery.
- Replace the battery when it no longer holds a charge. Used batteries are a valuable resource. Please recycle used batteries in accordance with local regulations.

## Charging AC Adapter

- Be sure to read and follow the warnings of “For Your Safety” (📖 viii-xi) thoroughly before using the battery charger.
- The Charging AC Adapter EH-70P is for use only with compatible devices. Do not use with another make or model of device.
- The EH-70P is compatible with AC 100-240 V, 50/60 Hz electrical outlets. When using in other countries, use a plug adapter (commercially available) as necessary. For more information about plug adapters, consult your travel agency.
- Do not, under any circumstances, use another make or model of AC adapter other than Charging AC Adapter EH-70P or USB-AC adapter. Failure to observe this precaution could result in overheating or in damage to the camera.

## Memory Cards

- Use only Secure Digital memory cards. See “Approved Memory Cards” (🔍:23) for recommended memory cards.
- Observe the precautions noted in the documentation included with your memory card.
- Do not affix labels or stickers to the memory card.
- Do not format the memory card using a computer.
- The first time you insert a memory card that has been used in another device into this camera, be sure to format it with this camera. We recommend formatting new memory cards with this camera before using them with this camera.
- Note that **formatting a memory card permanently deletes all images and other data on the memory card**. If there is data saved on the memory card that you wish to keep, copy that data to a computer before formatting.
- If the message **Card is not formatted. Format card?** is displayed when the camera is turned on, the memory card must be formatted. If there is data on the memory card that you do not want to delete, press flexible button 4 (❌ No). Copy that data to a computer before formatting. To format the memory card, press flexible button 3 (⊙ Yes).
- Observe the following precautions while formatting the memory card, saving and deleting images, and copying images to a computer, otherwise data on the memory card itself may be damaged.
  - Do not open the battery-chamber/memory card slot cover to remove the battery or memory card.
  - Do not turn off the camera.
  - Do not disconnect the AC adapter.

# Cleaning and Storage

## Cleaning

Do not use alcohol, thinner, or other volatile chemicals.

Lens	Avoid touching glass parts with your fingers. Remove dust or lint with a blower (typically a small device with a rubber bulb attached to one end that is pumped to produce a stream of air out the other end). To remove fingerprints or other stains that cannot be removed with a blower, wipe the lens with a soft, dry cloth or an eyeglass cleaning cloth, using a spiral motion that starts at the center of them and working toward the edges. If this fails, clean the lens using a cloth lightly dampened with commercial lens cleaner.
Monitor	Remove dust or lint with a blower. To remove fingerprints and other stains, clean the monitor with a soft, dry cloth, being careful not to apply pressure.
Body	Use a blower to remove dust, dirt, or sand, then wipe gently with a soft, dry cloth. After using the camera underwater or at the beach, gently wipe off any sand or salt with a soft cloth lightly dampened with fresh water and dry thoroughly. <ul style="list-style-type: none"><li>• If you handle the camera using hands where sunscreen lotion is applied, this could cause deterioration of the camera exterior.</li></ul> <b>Note that foreign matter inside the camera could cause damage not covered by the warranty.</b>



### More Information

See "Notes About Waterproof and Dustproof Performances" (📖 xvii) and "Cleaning After Using the Camera Underwater" (📖 xviii) for more information.

## Storage

Turn the camera off when not in use. Be sure that the power-on lamp is off before putting the camera away. Remove the battery if the camera will not be used for an extended period. Do not store the camera with naphtha or camphor moth balls, or in any of the following locations:

- Next to equipment that produces strong electromagnetic fields, such as televisions or radios
- Exposed to temperatures below  $-10^{\circ}\text{C}$  ( $14^{\circ}\text{F}$ ) or above  $50^{\circ}\text{C}$  ( $122^{\circ}\text{F}$ )
- Places that are poorly ventilated or subject to humidity of over 60%



To prevent mold or mildew, take the camera out of storage at least once a month. Turn the camera on and release the shutter a few times before putting the camera away again.

For storing the battery, follow the precautions in "The Battery" (🔋:5) in "Caring for the Product".











# Troubleshooting



If the camera fails to function as expected, check the list of common problems below before consulting your retailer or Nikon-authorized service representative.

## Power, Display, Settings Issues









Problem	Cause/Solution	
The camera is on but does not respond.	Wait for recording to end. If the problem persists, turn the camera off. If the camera does not turn off, remove and reinsert the battery or batteries or, if you are using an AC adapter, disconnect and reconnect the AC adapter. Note that although any data currently being recorded will be lost, data that have already been recorded will not be affected by removing or disconnecting the power source.	– 8, 18,  59
Battery inserted in the camera cannot be charged.	<ul style="list-style-type: none"><li>• Confirm all connections.</li><li>• When connected to a computer, the camera may not charge for any of the reasons described below.<ul style="list-style-type: none"><li>- <b>Off</b> is selected for <b>Charge by computer</b> in the camera settings menu.</li><li>- Battery charging stops if the camera is turned off.</li><li>- Battery charging is not possible if the camera's display language and date and time have not been set, or the date and time were reset after the camera's clock battery was exhausted. Use the Charging AC Adapter to charge the battery.</li><li>- Battery charging may stop if the computer is in sleep mode.</li><li>- Depending upon the computer specifications, settings, and status, battery charging may not be possible.</li></ul></li></ul>	10 65,  43 – 14, 17 – –
Camera cannot be turned on.	The battery is exhausted.	18











Problem	Cause/Solution	
Camera turns off without warning.	<ul style="list-style-type: none"> <li>• The camera automatically turns off to save power (auto off function).</li> <li>• The camera or battery have become too cold and cannot operate properly.</li> <li>• The inside of the camera has become hot. Leave the camera off until the inside of the camera has cooled, and then try turning it on again.</li> <li>• The camera turns off if the USB cable connecting it to a computer or printer is disconnected. Reconnect the USB cable.</li> </ul>	19  5 – 67, 70,  48
Monitor is blank.	<ul style="list-style-type: none"> <li>• The camera is off.</li> <li>• The battery is exhausted.</li> <li>• The camera has entered standby mode to save power. Press the power switch, shutter-release button,  (shooting/playback mode) button, or  (movie-record) button.</li> <li>• The flash lamp flashes while the flash is charging. Wait for the flash to charge.</li> <li>• The camera and computer are connected via a USB cable.</li> <li>• The camera and TV are connected via an audio/video cable or an HDMI cable.</li> </ul>	18 18 1, 19  32  67, 70 67,  45
Monitor is hard to read.	<ul style="list-style-type: none"> <li>• Adjust the monitor brightness.</li> <li>• The monitor is dirty. Clean the monitor.</li> </ul>	65,  36  8
Date and time of recording are not correct.	<ul style="list-style-type: none"> <li>• If the camera clock has not been set,  flashes during shooting and movie recording. Images and movies saved before the clock is set are dated "00/00/0000 00:00" or "01.01.14 00:00" respectively. The shooting date and time of still images is not displayed during playback. Set the correct time and date using <b>Date and time</b> in the camera settings menu.</li> <li>• The camera clock is not as accurate as ordinary watches or clocks. Periodically compare the time of the camera clock with that of a more accurate timepiece and reset as required.</li> </ul>	14, 65,  35

Problem	Cause/Solution	
<b>Print date</b> not available.	<b>Date and time</b> in the camera settings menu has not been set.	14, 65,  35
Date not imprinted on images even when <b>Print date</b> is enabled.	The date cannot be imprinted on movies and images captured using <b>Take a series of pictures</b> .	65,  37
Screen for setting time and date is displayed when camera is turned on.	The clock battery is exhausted; all settings were restored to their default values.	14, 17
Camera settings reset.		
Cannot select <b>Format memory</b> or <b>Format card</b> .	You cannot format while image lock is set. Remove image lock.	27
Camera becomes hot.	The camera may become warm when shooting movies for an extended period of time or when the camera is used in a hot area; this is not a malfunction.	–
Camera makes sound.	Depending on the settings, the camera may produce an audible focusing sound.	–



## Shooting Issues











Problem	Cause/Solution	
Cannot switch to shooting mode.	<ul style="list-style-type: none"> <li>• Disconnect the HDMI cable or USB cable.</li> <li>• The camera cannot be switched to shooting mode while connected to a power outlet via the Charging AC Adapter.</li> </ul>	67, 70,  45,  48 10
No image captured when the shutter-release button is pressed.	<ul style="list-style-type: none"> <li>• When the camera is in playback mode, press the  (shooting/playback mode) button or the shutter-release button.</li> <li>• When menus are displayed, press the  (shooting/playback mode) button or the shutter-release button.</li> <li>• The battery is exhausted.</li> <li>• When the flash lamp is flashing, the flash is charging.</li> </ul>	1, 24  1  18 32
Camera cannot focus.	<ul style="list-style-type: none"> <li>• The subject is too close. Try moving away from the subject or setting <b>Choose a style to Shoot close-ups</b>.</li> <li>• The subject is hard to focus on.</li> <li>• Set <b>AF assist</b> in the camera settings menu to <b>Auto</b>.</li> <li>• Turn the camera off and then on again.</li> </ul>	38  54 65,  39 18
Images are blurred.	<ul style="list-style-type: none"> <li>• Use the flash.</li> <li>• Enable electronic VR.</li> <li>• Use a tripod to stabilize the camera when shooting (using the self-timer at the same time is more effective).</li> </ul>	31 65,  38 33
Bright specks appear in images captured with flash.	The flash is reflecting off particles in the air. Set the flash mode setting to  <b>Flash off</b> .	31





Problem	Cause/Solution	
Flash does not fire.	<ul style="list-style-type: none"> <li>The flash mode is set to  <b>Flash off</b>.</li> <li><b>Choose a style</b> is set to a function that disables the flash.</li> </ul>	31 38
Digital zoom cannot be used.	When <b>Choose a style</b> is set to <b>Shoot night scenes</b> , <b>Shoot under water</b> , <b>Shoot backlit scenes</b> , <b>Take soft pictures</b> , or <b>Create a diorama effect</b> , digital zoom cannot be used.	38, 39, 40, 42
No sound when shutter is released.	<ul style="list-style-type: none"> <li><b>Turn sounds on or off</b> in <b>Change sounds</b> is set to <b>Turn sounds off</b>, or <b>Pick a shutter sound</b> is set to  in the shooting menu.</li> <li>Shutter sound is not heard when <b>Choose a style</b> is set to <b>Take a series of pictures</b>.</li> <li>Do not block the speaker.</li> </ul>	47  40  1
AF-assist illuminator does not light.	<b>Off</b> is selected for <b>AF assist</b> in the camera settings menu. AF-assist illuminator may not light depending on the current settings, even when <b>Auto</b> is selected.	65,  39
Images appear smeared.	The lens is dirty. Clean the lens.	 8
Colors are unnatural.	Hue is not adjusted properly.	38, 44
Randomly spaced bright pixels ("noise") appear in image.	The subject is dark, and the shutter speed is too slow or ISO sensitivity is too high. Noise can be reduced by using the flash.	31
Images are too dark (underexposed).	<ul style="list-style-type: none"> <li>The flash mode is set to  <b>Flash off</b>.</li> <li>The flash window is blocked.</li> <li>The subject is beyond the range of the flash.</li> <li>Adjust exposure compensation.</li> </ul>	31 20  19 46
Images are too bright (overexposed).	Adjust exposure compensation.	46

Problem	Cause/Solution	
Saving images takes time.	<p>It may take more time to save images in the following situations.</p> <ul style="list-style-type: none"> <li>• When the noise reduction function is in operation, such as when shooting in a dark environment</li> <li>• When the skin softening function is applied while shooting</li> <li>• When <b>Choose a style</b> is set to <b>Shoot night scenes</b>, <b>Take a series of pictures</b>, <b>Shoot backlit scenes</b>, <b>Add a neon effect</b>, or <b>Add a cartoon effect</b></li> </ul>	– 54 38, 40, 41, 42
A ring-shaped belt or rainbow-colored stripe appears in the monitor or images.	When shooting with backlighting or when a very strong light source (such as sunlight) is in the frame, a ring-shaped belt or rainbow-colored stripe (ghosting) may occur. Change the position of the light source, or frame the image so that the light source does not enter the frame, and try again.	–

## Playback Issues

Problem	Cause/Solution	
File cannot be played back.	<ul style="list-style-type: none"> <li>• This camera may not be able to play back images saved with another make or model of digital camera.</li> <li>• This camera cannot play back movies recorded with another make or model of digital camera.</li> <li>• This camera may not be able to play back data edited on a computer.</li> </ul>	–
Cannot zoom in on image.	<ul style="list-style-type: none"> <li>• Playback zoom cannot be used with movies, and images with an image size of 160 × 120 or smaller.</li> <li>• When viewing small images, the playback zoom ratio that is displayed may not match the actual image zoom ratio.</li> <li>• This camera may not be able to zoom in on images captured with another make or model of digital camera.</li> </ul>	–
Cannot record messages.	<ul style="list-style-type: none"> <li>• Messages cannot be attached to movies.</li> <li>• Messages cannot be attached to images captured with other cameras.</li> </ul>	– 58,  2

Problem	Cause/Solution	
Cannot edit image.	<ul style="list-style-type: none"> <li>• Some images cannot be edited. Images that have already been edited may not be edited again.</li> <li>• There is not enough free space in the internal memory or on the memory card.</li> <li>• This camera is unable to edit images captured with other cameras.</li> <li>• Editing functions used for images are not available for movies.</li> </ul>	43,  , 49, 58,  , 60,  , 61,  – – –
Cannot rotate image.	This camera cannot rotate images captured with another make or model of digital camera.	–
Cannot delete image.	<ul style="list-style-type: none"> <li>• Images cannot be deleted while image lock is set. Remove image lock.</li> <li>• Graded images are protected. Remove the grades.</li> </ul>	27 58,  , 17, 61, 
Images are not displayed on TV.	<ul style="list-style-type: none"> <li>• <b>Video mode</b> is not correctly set in the camera settings menu.</li> <li>• The cables are connected to the HDMI micro connector (Type D) and to the USB/audio/video output connector simultaneously.</li> <li>• The memory card contains no images. Replace the memory card. Remove the memory card to play back images from the internal memory.</li> </ul>	65,  42 67, 70, 71,  , 45, 46,  47 12
Nikon Transfer 2 does not start when camera is connected.	<ul style="list-style-type: none"> <li>• The camera is off.</li> <li>• The battery is exhausted.</li> <li>• The USB cable is not correctly connected.</li> <li>• The camera is not recognized by the computer.</li> <li>• The computer is not set to start Nikon Transfer 2 automatically. For more information about Nikon Transfer 2, refer to help information contained in ViewNX 2.</li> </ul>	18 18 67, 70 – 70

Problem	Cause/Solution	
<p>The PictBridge startup screen is not displayed when the camera is connected to a printer.</p>	<p>With some PictBridge-compatible printers, the PictBridge startup screen may not be displayed and it may be impossible to print images when <b>Auto</b> is selected for the <b>Charge by computer</b> option in the setup menu. Set the <b>Charge by computer</b> option to <b>Off</b> and reconnect the camera to the printer.</p>	<p>65, 43</p>
<p>Images to be printed are not displayed.</p>	<ul style="list-style-type: none"> <li>• The memory card contains no images. Replace the memory card.</li> <li>• Remove the memory card to print images from the internal memory.</li> </ul>	<p>12</p>
<p>Cannot select paper size with camera.</p>	<p>The camera cannot be used to select the paper size in the following situations, even when printing from a PictBridge-compatible printer. Use the printer to select the paper size.</p> <ul style="list-style-type: none"> <li>• The printer does not support the paper sizes specified by the camera.</li> <li>• The printer automatically selects the paper size.</li> </ul>	<p>67, 51,  52            –</p>

# Specifications

## Nikon COOLPIX S32 Digital Camera

Type	Compact digital camera
Number of effective pixels	13.2 million
Image sensor	$\frac{1}{3}$ -in. type CMOS; approx. 14.17 million total pixels
Lens	NIKKOR lens with 3 $\times$ optical zoom
Focal length	4.1–12.3 mm (angle of view equivalent to that of 30–90 mm lens in 35mm [135] format)
f/-number	f/3.3–5.9
Construction	6 elements in 5 groups
Digital zoom magnification	Up to 4 $\times$ (angle of view equivalent to that of approx. 360 mm lens in 35mm [135] format)
Vibration reduction	Electronic VR (movies)
Motion blur reduction	Motion detection (still pictures), electronic VR (still pictures)
Autofocus (AF)	Contrast-detect AF
Focus range	<ul style="list-style-type: none"><li>• [W]: Approx. 30 cm (1 ft)–<math>\infty</math>, [T]: Approx. 50 cm (1 ft 8 in.)–<math>\infty</math></li><li>• <b>Shoot close-ups, Photograph food, Shoot under water, Mirror, Add a bubble effect, Add a neon effect, Add a cartoon effect, Take soft pictures, Create a diorama effect, Highlight colors:</b> Approx. 5 cm (2 in.) (wide-angle position)–<math>\infty</math></li></ul> (All distances measured from center of front surface of the protective glass)
Focus-area selection	Center, face detection
Monitor	6.7 cm (2.7-in.), approx. 230k-dot, TFT LCD with anti-reflection coating and 5-level brightness adjustment
Frame coverage (shooting mode)	Approx. 96% horizontal and 96% vertical (compared to actual picture)
Frame coverage (playback mode)	Approx. 100% horizontal and 100% vertical (compared to actual picture)



<b>Storage</b>	
Media	Internal memory (approx. 25 MB), SD/SDHC/SDXC memory card
File system	DCF, Exif 2.3, and DPOF compliant
File formats	Still pictures: JPEG Voice messages: WAV Movies: MOV (Video: H.264/MPEG-4 AVC, Audio: LPCM stereo)
Image size (photo size)	<ul style="list-style-type: none"> <li>• 13 megapixels [4160 × 3120]</li> <li>• 4 megapixels [2272 × 1704]</li> <li>• 2 megapixels [1600 × 1200]</li> </ul>
ISO sensitivity (Standard output sensitivity)	ISO 125–1600
<b>Exposure</b>	
Metering mode	Matrix, center-weighted (digital zoom less than 2×), spot (digital zoom 2× or more)
Exposure control	Programmed auto exposure and exposure compensation (–2.0 – +2.0 EV in steps of 1 EV)
<b>Shutter</b>	
Speed	<ul style="list-style-type: none"> <li>• <math>\frac{1}{2000}</math>–1 s</li> <li>• 4 s (<b>Choose a style</b> is set to <b>Photograph fireworks</b>)</li> </ul>
<b>Aperture</b>	
Range	Electronically-controlled ND filter (–2 AV) selection 2 steps (f/3.3 and f/6.6 [W])
Self-timer	Approx. 10 s, smile timer
<b>Flash</b>	
Range (approx.) (ISO sensitivity: Auto)	[W]: 0.3–3.1 m (1–10 ft) [T]: 0.6–1.7 m (2 ft–5 ft 6 in.)
Flash control	TTL auto flash with monitor preflashes
<b>Interface</b>	
Data transfer protocol	Hi-Speed USB MTP, PTP
Video output	Can be selected from <b>NTSC</b> and <b>PAL</b>
HDMI output	Automatically selected from 480p, 720p, and 1080i

<b>I/O terminal</b>	Audio/video (A/V) output; digital I/O (USB) HDMI micro connector (Type D) (HDMI output)
<b>Supported languages</b>	Arabic, Bengali, Bulgarian, Chinese (Simplified and Traditional), Czech, Danish, Dutch, English, Finnish, French, German, Greek, Hindi, Hungarian, Indonesian, Italian, Japanese, Korean, Marathi, Norwegian, Persian, Polish, Portuguese (European and Brazilian), Romanian, Russian, Serbian, Spanish, Swedish, Tamil, Telugu, Thai, Turkish, Ukrainian, Vietnamese
<b>Power sources</b>	<ul style="list-style-type: none"> <li>• One Rechargeable Li-ion Battery EN-EL19 (included)</li> <li>• AC Adapter EH-62G (available separately)</li> </ul>
<b>Charging time</b>	Approx. 2 h 35 min (when using Charging AC Adapter EH-70P and when no charge remains)
<b>Battery life<sup>1</sup></b>	
<b>Still pictures</b>	Approx. 220 shots when using EN-EL19
<b>Movies (actual battery life for recording)<sup>2</sup></b>	Approx. 1 h 35 min when using EN-EL19
<b>Tripod socket</b>	1/4 (ISO 1222)
<b>Dimensions (W × H × D)</b>	Approx. 107.6 × 66.1 × 40.4 mm (4.3 × 2.7 × 1.6 in.) (excluding projections)
<b>Weight</b>	Approx. 175 g (6.2 oz) (including battery and SD memory card)
<b>Operating environment</b>	
<b>Temperature</b>	-10°C – +40°C (14°F–104°F) (for land use) 0°C–40°C (32°F–104°F) (for underwater use)
<b>Humidity</b>	85% or less (no condensation)
<b>Waterproof</b>	JIS/IEC protection class 8 (IPX8) equivalent (under our testing conditions) Capacity to shoot pictures underwater up to a depth of 10 m (33 ft) and for 60 minutes
<b>Dustproof</b>	JIS/IEC protection class 6 (IP6X) equivalent (under our testing conditions)
<b>Shockproof</b>	Cleared our testing conditions <sup>3</sup> compliant with MIL-STD 810F Method 516.5-Shock

- Unless otherwise stated, all figures assume a fully-charged battery and an ambient temperature of  $23 \pm 3^{\circ}\text{C}$  ( $73.4 \pm 5.4^{\circ}\text{F}$ ) as specified by the Camera and Imaging Products Association (CIPA).
- <sup>1</sup> Battery life may vary depending on conditions of use, such as the interval between shots or the length of time that menus and images are displayed.
  - <sup>2</sup> Individual movie files cannot exceed 4 GB in size or 29 minutes in length. Recording may end before this limit is reached if camera temperature becomes elevated.
  - <sup>3</sup> Dropped from a height of 1.5 m (5 ft) onto a surface of 5 cm (2 in.) thick plywood (changes in appearance, such as paint peeling off and deformation of the drop shock portion and waterproof performance are not subject to the test).  
These tests do not guarantee that the camera will be free from damage or trouble under all conditions.

## Rechargeable Li-ion Battery EN-EL19

Type	Rechargeable lithium-ion battery
Rated capacity	DC 3.7 V, 700 mAh
Operating temperature	0°C–40°C (32°F–104°F)
Dimensions (W × H × D)	Approx. 31.5 × 39.5 × 6 mm (1.3 × 1.6 × 0.3 in.)
Weight	Approx. 14.5 g (0.5 oz)

## Charging AC Adapter EH-70P

Rated input	AC 100–240 V, 50/60 Hz, 0.07–0.044 A
Rated output	DC 5.0 V, 550 mA
Operating temperature	0°C–40°C (32°F–104°F)
Dimensions (W × H × D)	Approx. 55 × 22 × 54 mm (2.2 × 0.9 × 2.2 in.) (excluding plug adapter) For Argentina: Approx. 55 × 59 × 63 mm (2.2 × 2.4 × 2.5 in.) For Korea: Approx. 55 × 59 × 66.5 mm (2.2 × 2.4 × 2.7 in.)
Weight	Approx. 47 g (1.7 oz) (excluding plug adapter) For Argentina and Korea: Approx. 72 g (2.6 oz)

### Specifications

- Nikon will not be held liable for any errors this manual may contain.
- The appearance of this product and its specifications are subject to change without notice.

## Approved Memory Cards

The following Secure Digital (SD) memory cards have been tested and approved for use in this camera.

- Memory cards with an SD Speed Class rating of 6 or faster are recommended for recording movies. When using a memory card with a lower Speed Class rating, movie recording may stop unexpectedly.

	SD memory card	SDHC memory card <sup>2</sup>	SDXC memory card <sup>3</sup>
SanDisk	2 GB <sup>1</sup>	4 GB, 8 GB, 16 GB, 32 GB	64 GB, 128 GB
TOSHIBA	–	4 GB, 8 GB, 16 GB, 32 GB	64 GB
Panasonic	2 GB <sup>1</sup>	4 GB, 8 GB, 16 GB, 32 GB	64 GB
Lexar	–	4 GB, 8 GB, 16 GB, 32 GB	64 GB, 128 GB

<sup>1</sup> If the memory card will be used with a card reader or similar device, make sure that the device supports 2 GB cards.

<sup>2</sup> SDHC compliant. If the memory card will be used with a card reader or similar device, make sure that the device supports SDHC.

<sup>3</sup> SDXC compliant. If the memory card will be used with a card reader or similar device, make sure that the device supports SDXC.

- Contact the manufacturer for details on the above cards. We cannot guarantee camera performance when using memory cards made by other manufacturers.



## **AVC Patent Portfolio License**

This product is licensed under the AVC Patent Portfolio License for the personal and noncommercial use of a consumer to (i) encode video in compliance with the AVC standard (“AVC video”) and/or (ii) decode AVC video that was encoded by a consumer engaged in a personal and non-commercial activity and/or was obtained from a video provider licensed to provide AVC video. No license is granted or shall be implied for any other use.

Additional information may be obtained from MPEG LA, L.L.C.

See **<http://www.mpegla.com>**.

## Trademark Information

- Microsoft, Windows and Windows Vista are either registered trademarks or trademarks of Microsoft Corporation in the United States and/or other countries.
- Mac and OS X are trademarks or registered trademarks of Apple Inc. in the U.S. and other countries.
- Adobe and Acrobat are registered trademarks of Adobe Systems Inc.
- SDXC, SDHC and SD Logos are trademarks of SD-3C, LLC.
- PictBridge is a trademark.
- HDMI, HDMI logo and High-Definition Multimedia Interface are trademarks or registered trademarks of HDMI Licensing LLC.

## HDMI

- All other trade names mentioned in this manual or the other documentation provided with your Nikon product are trademarks or registered trademarks of their respective holders.

## FreeType License (FreeType2)

Portions of this software are copyright © 2012 The FreeType Project (<http://www.freetype.org>). All rights reserved.

## MIT License (HarfBuzz)

Portions of this software are copyright © 2014 The HarfBuzz Project (<http://www.freedesktop.org/wiki/Software/HarfBuzz>). All rights reserved.

# Index

## Symbols

Point and shoot.....	30
Playback mode.....	24
Camera settings menu.....	65
movie-record) button .....	1, 60
(shooting/playback mode) button .....	2, 24
.JPG.....	58
.MOV.....	58
.WAV.....	58

## A

AC adapter .....	67,  59
Add a bubble effect  .....	37, 41
Add a cartoon effect  .....	37, 42
Add a diorama effect .....	12
Add a fisheye effect .....	10
Add a neon effect  .....	37, 41
Add starbursts.....	11
AF-assist illuminator .....	1, 65,  39
Always fire flash.....	31
Aperture value .....	23
Audio/video cable.....	68,  45,  59
Audio/video-in jack.....	68,  45
Auto flash.....	31
Auto off.....	19
Autofocus.....	54







## B





Battery .....	8, 10, 17
Battery chamber .....	2
Battery charger .....	11,  59
Battery level .....	18
Battery-chamber/memory card slot cover .....	2, 8, 12
Brightness.....	46
Brush.....	xvi
Button sound.....	47



## C





Camera settings .....	29,  34
Camera settings menu .....	65
Change colors (playback mode).....	13
Change colors (shooting mode) ...	28, 44
Change sounds .....	29, 47
Charge by computer.....	65,  43
Charge lamp.....	2, 11
Choose a size .....	29, 49
Choose a style .....	28, 37
Compression ratio .....	49
Computer.....	68, 70
Copy.....	27
Create a diorama effect  .....	37, 42
Crop.....	56





<b>D</b>	
Date and time .....	14, 65,  35
Date format.....	15,  35
Daylight saving time .....	15,  35
Decorate (playback mode).....	 15
Decorate (shooting mode) .....	28, 43
Delete .....	25
Digital zoom.....	21
Direct print.....	68,  47
DPOF print.....	 54
DSCN.....	 58



<b>E</b>	
Electronic VR.....	65,  38
Erase recordings .....	 5
Exchange messages .....	58,  2
Exposure compensation.....	46
Extension.....	 58
Eyelet for camera strap.....	1



<b>F</b>	
Face detection.....	53
File name.....	 58
Firmware version.....	66,  44
Flash .....	1, 28, 31
Flash lamp .....	2, 32
Flash mode .....	31
Flash off.....	31
Flexible buttons .....	6
Focus.....	22, 53

Focus indicator.....	4
Focus lock.....	55
Format internal memory .....	65,  40
Format memory cards.....	13, 65,  40
Formatting .....	13, 65,  40
FSCN.....	 58
Full-frame playback mode .....	24

<b>G</b>	
Grade pictures.....	 16
Grading.....	58,  16

<b>H</b>	
Have fun with pictures.....	58
HDMI cable.....	68,  45
HDMI micro connector.....	2
Highlight colors (playback mode) .....	 14
Highlight colors (shooting mode).....	46

<b>I</b>	
Identifier.....	 58
Image lock.....	27
Imprinting date and time.....	17,  37
Internal memory .....	13

<b>L</b>	
Language .....	65,  41
Leave a message (recording a message) .....	 2
Leave a reply (recording a message) .....	 4

Lens..... 1, 18

## **M**

Make photo albums ..... 8

Memory card..... 12, 23

Memory card slot ..... 2, 12

Menu background..... 16, 65, 41

Microphone (stereo) ..... 1

Mirror ..... 37, 41

Monitor..... 2, 4, 8

Monitor brightness ..... 65, 36

Movie frame size..... 50

Movie length..... 60

Movie playback ..... 63

Movie recording ..... 60

Movie-record button ..... 1, 60

Multi selector ..... 2

## **N**

Nikon Transfer 2..... 70

Number of exposures remaining... 18, 50

## **O**

Optical zoom ..... 21

Optional accessories ..... 59

## **P**

Paper size ..... 51, 52

Photo size..... 49

Photograph fireworks ..... 37, 40

Photograph food ..... 37, 38

PictBridge..... 68, 47

Picture play ..... 58, 7

Play recordings ..... 5

Playback..... 24, 63

Playback menu ..... 58

Playback mode ..... 24

Playback zoom..... 56

Power..... 18

Power switch/power-on lamp..... 1, 18

Power-on..... 11

Pressing halfway ..... 23

Print..... 68, 32, 50, 52

Print date ..... 17, 65, 37

Print order..... 59, 32

Print order option ..... 17, 33

Printer ..... 68, 47

## **R**

Rechargeable battery ..... 10

Rechargeable Li-ion battery..... 8, 10

Recording movies ..... 60

Reset all ..... 66, 44

Restrict image deletion ..... 27

Retouch..... 59, 27

Rotate pictures..... 30



RSCN..... 58

## **S**

Saturation..... 46

Self-timer ..... 28, 33

Self-timer lamp ..... 1, 34

Shoot at intervals 	37, 39	Using skin softening.....	54
Shoot backlit scenes 	37, 40	<b>V</b>	
Shoot close-ups 	37, 38	Video mode.....	65,  42
Shoot night scenes 	37, 38	View.....	58
Shoot under water 	37, 39	View by date.....	58,  20
Shooting.....	18, 20, 22	View graded pictures.....	 18
Shooting/playback mode button.....	2, 24	View movie.....	58,  26
Shutter sound.....	47	ViewNX 2.....	69
Shutter speed.....	23	Vividness.....	46
Shutter-release button.....	1, 22	Volume.....	64,  5
Slide show.....	58,  21	<b>W</b>	
Small picture.....	 31	Welcome screen.....	65,  34
Smile timer.....	35	<b>Z</b>	
Soften pictures.....	 11	Zoom.....	21
Speaker.....	1	Zoom in.....	21
SSCN.....	 58	Zoom out.....	21
Strap.....	3		
<b>I</b>			
Take a series of pictures 	37, 40		
Take soft pictures 	37, 42		
Thumbnail playback.....	57		
Toy camera.....	 10		
Tripod socket.....	2,  20		
TV.....	68,  45		
<b>U</b>			
USB cable.....	68, 70,  48		
USB/audio/video output connector .....	2, 67, 70,  45,  47		

No reproduction in any form of this manual, in whole or in part (except for brief quotation in critical articles or reviews), may be made without written authorization from NIKON CORPORATION.

**NIKON CORPORATION**

© 2014 Nikon Corporation



CT3L02(11)  
6MN39011-02