

Nikon

DIGITAL CAMERA

COOLPIX P7100

Reference Manual



En

Trademark Information

- Microsoft, Windows and Windows Vista are either registered trademarks or trademarks of Microsoft Corporation in the United States and/or other countries.
- Macintosh, Mac OS, and QuickTime are trademarks of Apple Inc., registered in the U.S. and other countries.
- Adobe and Acrobat are registered trademarks of Adobe Systems Inc.
- SDXC, SDHC and SD Logos are trademarks of SD-3C, LLC.
- PictBridge is a trademark.
- HDMI, **HDMI** logo and High-Definition Multimedia Interface are trademarks or registered trademarks of HDMI Licensing LLC.
- All other trade names mentioned in this manual or the other documentation provided with your Nikon product are trademarks or registered trademarks of their respective holders.

AVC Patent Portfolio License

This product is licensed under the AVC Patent Portfolio License for the personal and non-commercial use of a consumer to (i) encode video in compliance with the AVC standard ("AVC video") and/or (ii) decode AVC video that was encoded by a consumer engaged in a personal and non-commercial activity and/or was obtained from a video provider licensed to provide AVC video. No license is granted or shall be implied for any other use. Additional information may be obtained from MPEG LA, L.L.C.

See <http://www.mpegla.com>.

Introduction

Parts of the Camera and Basic Operations

The Basics of Shooting and Playback

Shooting Features

Playback Features

Recording and Playing Back Movies

General Camera Setup

Reference Section

Technical Notes and Index

Read This First

Thank you for purchasing the Nikon COOLPIX P7100 digital camera. Before using the camera, please read the information in "For Your Safety" (vi) and familiarize yourself with the information provided in this manual. After reading, please keep this manual handy and refer to it to enhance your enjoyment of your new camera.

Confirming the Package Contents

In the event that any items are missing, please contact the store where you purchased the camera.



COOLPIX P7100
Digital Camera (with
Accessory Shoe Cover BS-1)



Camera Strap



Rechargeable Li-ion
Battery EN-EL14
(with terminal cover)

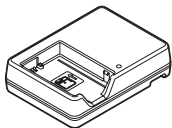

Battery Charger MH-24*

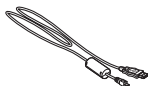

USB Cable UC-E6

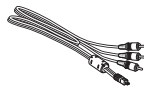

Audio Video Cable EG-CP16



ViewNX 2 CD



Reference Manual CD

- Warranty

* A plug adapter is included if the camera was purchased in a country or region that requires a plug adapter. The shape of the plug adapter varies with the country or region of purchase.

NOTE: A memory card is not included with the camera.

About This Manual







If you want to start using the camera right away, see “The Basics of Shooting and Playback” (📖17).

To learn about the parts of the camera and basic operations, see “Parts of the Camera and Basic Operations” (📖1).

Other Information

- Symbols and Conventions

To make it easier to find the information you need, the following symbols and conventions are used in this manual:

Icon	Description
	This icon indicates cautions and information that should be read before using the camera.
	This icon marks notes, information that should be read before using the camera.
  	These icons indicate other pages containing relevant information;  : “Reference Section”,  : “Technical Notes and Index.”

- SD, SDHC and SDXC memory cards are referred to as “memory cards” in this manual.
- The setting at the time of purchase is referred to as the “default setting.”
- The names of menu items displayed in the camera monitor, and the names of buttons or messages displayed on a computer monitor appear in bold.
- In this manual, images are sometimes omitted from monitor and viewfinder display samples so that monitor indicators can be more clearly shown.
- Illustrations and monitor content shown in this manual may differ from the actual product.

Information and Precautions

Life-Long Learning

As part of Nikon's "Life-Long Learning" commitment to ongoing product support and education, continually updated information is available online at the following sites:

- For users in the U.S.A.: <http://www.nikonusa.com/>
- For users in Europe and Africa: <http://www.europe-nikon.com/support/>
- For users in Asia, Oceania, and the Middle East: <http://www.nikon-asia.com/>

Visit these sites to keep up-to-date with the latest product information, tips, answers to frequently asked questions (FAQs), and general advice on digital imaging and photography. Additional information may be available from the Nikon representative in your area. Visit the site below for contact information:

<http://imaging.nikon.com/>

Use Only Nikon Brand Electronic Accessories

Nikon COOLPIX cameras are designed to the highest standards and include complex electronic circuitry. Only Nikon brand electronic accessories (including battery chargers, batteries, and AC adapters) certified by Nikon specifically for use with this Nikon digital camera are engineered and proven to operate within the operational and safety requirements of this electronic circuitry.

THE USE OF NON-NIKON ELECTRONIC ACCESSORIES COULD DAMAGE THE CAMERA AND MAY VOID YOUR NIKON WARRANTY.

The use of third-party rechargeable Li-ion batteries not bearing the Nikon holographic seal could interfere with normal operation of the camera or result in the batteries overheating, igniting, rupturing, or leaking.

For more information about Nikon brand accessories, contact a local authorized Nikon dealer.

Holographic seal: Identifies this device as an authentic Nikon product.



Before Taking Important Pictures

Before taking pictures on important occasions (such as at weddings or before taking the camera on a trip), take a test shot to ensure that the camera is functioning normally. Nikon will not be held liable for damages or lost profits that may result from product malfunction.

About the User's Manual

- No part of the documentation included with this product may be reproduced, transmitted, transcribed, stored in a retrieval system, or translated into any language in any form, by any means, without Nikon's prior written permission.
- Nikon will not be held liable for any damages resulting from the use of this product.
- Nikon reserves the right to change the specifications of the hardware and software described in the documentation at any time and without prior notice.
- While every effort was made to ensure that the information in the documentation is accurate and complete, we would appreciate it were you to bring any errors or omissions to the attention of the Nikon representative in your area (address provided separately).

Notice Concerning Prohibition of Copying or Reproduction

Note that simply being in possession of material that was digitally copied or reproduced by means of a scanner, digital camera or other device may be punishable by law.

• Items prohibited by law from being copied or reproduced

Do not copy or reproduce paper money, coins, securities, government bonds or local government bonds, even if such copies or reproductions are stamped "Sample." The copying or reproduction of paper money, coins, or securities which are circulated in a foreign country is prohibited. Unless the prior permission of the government was obtained, the copying or reproduction of unused postage stamps or post cards issued by the government is prohibited.

The copying or reproduction of stamps issued by the government and of certified documents stipulated by law is prohibited.

• Cautions on certain copies and reproductions

The government has issued cautions on copies or reproductions of securities issued by private companies (shares, bills, checks, gift certificates, etc.), commuter passes, or coupon tickets, except when a minimum of necessary copies are to be provided for business use by a company. Also, do not copy or reproduce passports issued by the government, licenses issued by public agencies and private groups, ID cards and tickets, such as passes and meal coupons.

• Comply with copyright notices

The copying or reproduction of copyrighted creative works such as books, music, paintings, woodcut prints, maps, drawings, movies, and photographs is governed by national and international copyright laws. Do not use this product for the purpose of making illegal copies or to infringe copyright laws.

Disposing of Data Storage Devices

Please note that deleting images or formatting data storage devices such as memory cards or built-in camera memory does not completely erase the original image data. Deleted files can sometimes be recovered from discarded storage devices using commercially available software, potentially resulting in the malicious use of personal image data. Ensuring the privacy of such data is the user's responsibility.

Before discarding a data storage device or transferring ownership to another person, erase all data using commercial deletion software, or format the device and then completely refill it with images containing no private information (for example, pictures of empty sky). Be sure to also replace any pictures selected for the **Select an image** option in the **Welcome screen** setting (📷104). Care should be taken to avoid injury or damage to property when physically destroying data storage devices.

For Your Safety

To prevent damage to your Nikon product or injury to yourself or to others, read the following safety precautions in their entirety before using this equipment. Keep these safety instructions where all those who use the product will read them.



This icon marks warnings, information that should be read before using this Nikon product, to prevent possible injury.

WARNINGS

Turn off in the event of malfunction

Should you notice smoke or an unusual smell coming from the camera or Battery Charger, unplug the Battery Charger and remove the battery immediately, taking care to avoid burns. Continued operation could result in injury. After removing or disconnecting the power source, take the equipment to a Nikon-authorized service representative for inspection.

Do not disassemble

Touching the internal parts of the camera or Battery Charger could result in injury. Repairs should be performed only by qualified technicians. Should the camera or Battery Charger break open as the result of a fall or other accident, take the product to a Nikon-authorized service representative for inspection, after unplugging the product and/or removing the battery.

Do not use the camera or Battery Charger in the presence of flammable gas

Using the camera in the presence of flammable gases such as propane and gasoline, as well as flammable sprays or dust could result in explosion or fire.

Do not look at the sun through the viewfinder

Viewing the sun or other strong light source through the viewfinder could cause permanent visual impairment.

Handle the camera strap with care

Never place the strap around the neck of an infant or child.

Keep out of reach of children

Do not keep the products within reach of children. Doing so may cause injury. Particular care should be taken to prevent infants from putting the battery or other small parts into their mouths.

Do not remain in contact with the camera, battery charger, or AC adapter for extended periods while the devices are on or in use.

Parts of the devices become hot. Leaving the devices in direct contact with the skin for extended periods may result in low-temperature burns.

Observe caution when handling the battery

The battery may leak, overheat, or explode if improperly handled. Observe the following precautions when handling the battery for use in this product:

- Before replacing the battery, turn the product off. If you are using the Battery Charger/AC adapter, be sure it is unplugged.
- Use only a Rechargeable Li-ion Battery EN-EL14 (included). Charge the battery by inserting it in a Battery Charger MH-24 (included). For Remote Control ML-L3 (available separately), use only 3 V CR2025 lithium battery.
- When inserting the battery, do not attempt to insert it upside down or backwards.
- Do not short or disassemble the battery or attempt to remove or break the battery insulation or casing.
- Do not expose the battery to flame or to excessive heat.
- Do not immerse in or expose to water.
- Replace the terminal cover when transporting the battery. Do not transport or store with metal objects such as necklaces or hairpins.
- The battery is prone to leakage when fully discharged. To avoid damage to the product, be sure to remove the battery when no charge remains.
- Discontinue use immediately should you notice any change in the battery, such as discoloration or deformation.

- If liquid from the damaged battery comes in contact with clothing or skin, rinse immediately with plenty of water.
- If leaked battery fluid gets into your eyes, rinse them out immediately with clean running water and get medical treatment.
- Do not attempt to charge batteries that are not rechargeable.

Observe the following precautions when handling the Battery Charger

- Keep dry. Failure to observe this precaution could result in fire or electric shock.
- Dust on or near the metal parts of the plug should be removed with a dry cloth. Continued use could result in fire.
- Do not handle the plug or go near the Battery Charger during lightning storms. Failure to observe this precaution could result in electric shock.
- Do not damage, modify, forcibly tug or bend the USB cable, place it under heavy objects, or expose it to heat or flames. Should the insulation be damaged and the wires become exposed, take it to a Nikon-authorized service representative for inspection. Failure to observe these precautions could result in fire or electric shock.

- Do not handle the plug or Battery Charger with wet hands. Failure to observe this precaution could result in electric shock.
- Do not use with travel converters or adapters designed to convert from one voltage to another or with DC-to-AC inverters. Failure to observe this precaution could damage the product or cause overheating or fire.

⚠ Use appropriate cables

When connecting cables to the input and output jacks, use only the cables provided or sold by Nikon for the purpose, to maintain compliance with product regulations.

⚠ Handle moving parts with care

Be careful that your fingers or other objects are not pinched by the lens cover or other moving parts.

⚠ CD-ROMs

The CD-ROMs included with this device should not be played back on audio CD equipment. Playing CD-ROMs on an audio CD player could cause hearing loss or damage the equipment.

⚠ Observe caution when using the flash

Using the flash close to your subject's eyes could cause temporary visual impairment. Particular care should be observed if photographing infants, when the flash should be no less than 1 m (3 ft 4 in.) from the subject.

⚠ Do not operate the flash with the flash window touching a person or object

Failure to observe this precaution could result in burns or fire.

⚠ Avoid contact with liquid crystal

Should the monitor break, care should be taken to avoid injury caused by broken glass and to prevent liquid crystal from the monitor touching the skin or entering the eyes or mouth.

⚠ Turn the power off when using inside an airplane or the hospital

Turn the power off while inside the airplane during take off or landing. Follow the instructions of the hospital when using while in a hospital. The electromagnetic waves given out by this camera may disrupt the electronic systems of the airplane or the instruments of the hospital.

Notices

Notices for Customers in the U.S.A.

IMPORTANT SAFETY INSTRUCTIONS -

SAVE THESE INSTRUCTIONS.

DANGER - TO REDUCE THE RISK OF FIRE OR ELECTRIC SHOCK, CAREFULLY FOLLOW THESE INSTRUCTIONS

For connection to a supply not in the U.S.A., use an attachment plug adapter of the proper configuration for the power outlet if needed.

The power supply unit is intended to be correctly orientated in a vertical or floor mount position.

Federal Communications Commission (FCC) Radio Frequency Interference Statement

This equipment has been tested and found to comply with the limits for a Class B digital device, pursuant to Part 15 of the FCC rules. These limits are designed to provide reasonable protection against harmful interference in a residential installation. This equipment generates, uses, and can radiate radio frequency energy and, if not installed and used in accordance with the instructions, may cause harmful interference to radio communications. However, there is no guarantee that interference will not occur in a particular installation. If this

equipment does cause harmful interference to radio or television reception, which can be determined by turning the equipment off and on, the user is encouraged to try to correct the interference by one or more of the following measures:

- Reorient or relocate the receiving antenna.
- Increase the separation between the equipment and receiver.
- Connect the equipment into an outlet on a circuit different from that to which the receiver is connected.
- Consult the dealer or an experienced radio/television technician for help.



Nikon

COOLPIX P7100

CAUTIONS

Modifications

The FCC requires the user to be notified that any changes or modifications made to this device that are not expressly approved by Nikon Corporation may void the user's authority to operate the equipment.

Interface Cables

Use the interface cables sold or provided by Nikon for your equipment. Using other interface cables may exceed the limits of Class B Part 15 of the FCC rules.

Notice for Customers in the State of California

WARNING

Handling the cord on this product will expose you to lead, a chemical known to the State of California to cause birth defects or other reproductive harm.

Wash hands after handling.

Nikon Inc.,
1300 Walt Whitman Road,
Melville, New York 11747-3064
USA
Tel: 631-547-4200

Notice for Customers in Canada

CAUTION

This Class B digital apparatus complies with Canadian ICES-003.

ATTENTION

Cet appareil numérique de la classe B est conforme à la norme NMB-003 du Canada.

Notices for Customers in Europe

CAUTIONS

RISK OF EXPLOSION IF BATTERY IS REPLACED BY AN INCORRECT TYPE.

DISPOSE OF USED BATTERIES ACCORDING TO THE INSTRUCTIONS.

This symbol indicates that this product is to be collected separately.



The following apply only to users in European countries:

- This product is designated for separate collection at an appropriate collection point. Do not dispose of as household waste.
- For more information, contact the retailer or the local authorities in charge of waste management.

This symbol on the battery indicates that the battery is to be collected separately.





























The following apply only to users in European countries:

- All batteries, whether marked with this symbol or not, are designated for separate collection at an appropriate collection point. Do not dispose of as household waste.
- For more information, contact the retailer or the local authorities in charge of waste management.

Table of Contents





































Introduction	ii
Read This First	ii
Confirming the Package Contents.....	ii
About This Manual.....	iii
Information and Precautions.....	iv
For Your Safety	vi
WARNINGS	vi
Notices	ix
Parts of the Camera and Basic Operations	1
Parts of the Camera	2
The Camera Body.....	2
Controls Used in Shooting Mode.....	4
Controls Used in Playback Mode	6
Changing the Angle of the Monitor	7
Raising and Lowering the Flash.....	7
Attaching the Camera Strap	7
The Monitor.....	8
Basic Operations	11
Switching Between Shooting Mode and Playback Mode	11
Using the Rotary Multi Selector.....	12
Using Menus (the MENU Button).....	13
Switching the Monitor Display (the [] Button)	15
Using the Viewfinder	16
The Basics of Shooting and Playback	17
Preparation 1 Charge the Battery	18
Preparation 2 Insert the Battery	20
Preparation 3 Insert a Memory Card	22
Internal Memory and Memory Cards.....	23
Approved Memory Cards.....	23
Step 1 Turn the Camera On	24
Turning the Camera On and Off.....	25
Setting the Display Language, Date, and Time.....	26
Step 2 Select a Shooting Mode	28
Available Shooting Modes.....	29
Step 3 Frame a Picture	30
Using the Zoom.....	31
Step 4 Focus and Shoot	32

Step 5 Play Back Images	34
Changing How Images Are Displayed.....	35
Step 6 Delete Unwanted Images.....	36
Shooting Features	37
📷 (Auto) Mode.....	38
Changing 📷 (Auto) Mode Settings.....	38
Scene Mode (Shooting Suited to Scenes)	39
Changing Scene Mode Settings.....	39
Characteristics of Each Scene	40
Special Effects Mode (Applying Effects When Shooting)	46
Changing Special Effects Mode Settings.....	48
Options Available in the Special Effects Menu.....	48
Low Noise Night Mode (Shooting Low-lit Scenes)	49
Changing Low Noise Night Mode Settings	50
Options Available in the Low Noise Night Mode Menu	50
P, S, A, M Modes (Setting the Exposure for Shooting)	51
Changing P, S, A, M Modes.....	54
Options Available in the Shooting Menu	54
U1, U2 and U3 (User Setting Modes).....	57
Changing U1, U2 or U3 Mode Settings.....	57
Available Specialized Menu for U1, U2 or U3.....	58
Features That Can Be Set Using the Multi Selector.....	60
Available Functions	60
Using the Flash (Flash Modes)	61
Using the Self-timer	64
Smile Timer (Shooting Smiling Faces)	65
Using Focus Mode.....	67
List of the Default Settings.....	69
Features That Can Be Set Using the Exposure Compensation Dial.....	71
Adjusting Brightness (Exposure Compensation).....	71
Features That Can Be Set with the Quick Menu.....	72
Available Quick Menu	73
Changing the Image Quality and Image Size	74
Available Image Quality.....	75
Available Image Size	77
Features That Cannot Be Used Simultaneously	80
Using Face Detection.....	85
Using Skin Softening	86

Playback Features	87
Selecting Pictures for Playback by Date (List by Date Mode).....	88
Features Available in Playback Mode (Playback Menu)	89
Connecting the Camera to a TV, Computer, or Printer	91
Using ViewNX 2.....	92
Installing ViewNX 2	92
Transferring Images to the Computer	94
Viewing Images	95
Retouching Photographs	96
Editing Movies.....	96
Printing Images.....	96
Recording and Playing Back Movies.....	97
Recording Movies	98
Changing Movie Mode Settings	101
Options Available in the Movie Menu	101
Playing Back Movies.....	102
General Camera Setup.....	103
The Setup Menu	104
Reference Section.....	 1
Taking Pictures with Manual Focus	 2
Using Panorama Assist.....	 3
P, S, A, M Modes.....	 5
P (Programmed Auto), S (Shutter-Priority Auto) or	
A (Aperture-Priority Auto).....	 5
M (Manual) Mode	 7
Editing Still Images.....	 9
Editing Features	 9
 Quick Retouch: Enhancing Contrast and Saturation.....	 11
 D-Lighting: Enhancing Brightness and Contrast	 11
 Skin Softening: Softening Skin Tones	 12
 Filter Effects: Applying Digital Filter Effects	 13
 Small Picture: Reducing the Size of an Image.....	 14
 Black Border: Adding a Black Border to Pictures	 15
 Straighten: Compensating for Picture Slanting.....	 16
 NRW (RAW) Processing: Creating JPEG Images from NRW Images	 17
 Crop: Creating a Cropped Copy	 19
Connecting the Camera to a TV (Viewing Images on a TV)	 20

Connecting the Camera to a Printer (Direct Print)	22
Connecting the Camera to a Printer	23
Printing Individual Images	24
Printing Multiple Images	25
Editing Movies	28
Extracting Only the Desired Portions of the Movie	28
Saving a Frame from a Movie as a Still Picture	29
Quick Menu	30
QUAL Image Quality and Image Size	30
ISO Sensitivity (Setting the ISO sensitivity)	30
WB White Balance (Matching Image Colors with Colors as Seen with the Naked Eye)	32
BKT Bracketing (Continuous Shooting While Changing the Shutter Speed, ISO Sensitivity and White Balance)	36
Picture Control (COOLPIX Picture Control) (Changing the Settings for Image Recording)	38
QUAL Movie Options (Changing the Type of Movie to Shoot)	42
Shooting Menu (P, S, A or M Mode)	43
Custom Picture Control (COOLPIX Custom Picture Control)	43
Metering	44
Continuous Shooting	45
AF Area Mode	48
Subject Tracking Mode (Focusing on a Moving Subject)	50
Autofocus Mode	52
Flash Exp. Comp.	52
Noise Reduction Filter	53
Long Exposure NR	53
Distortion Control	54
Wide-angle Converter	54
Flash Control	55
Active D-Lighting	56
Zoom Memory	57
Specialized Menu for U1, U2 or U3	58
Save User Settings	58

The Playback Menu	60
Print Order (Creating a DPOF Print Order)	60
Slide Show	63
Delete	64
The Image Selection Screen	65
Protect	66
Rotate Image	66
Hide Image	66
Voice Memo	67
Copy (Copy Between Internal Memory and Memory Card)	68
The Movie Menu	69
Autofocus Mode	69
Wind Noise Reduction	69
The Setup Menu	70
Welcome Screen	70
Time Zone and Date	71
Monitor Settings	74
Print Date (Imprinting Date and Time on Pictures)	75
Self-timer: After Release	76
Vibration Reduction	76
Motion Detection	77
AF Assist	78
Red-eye Reduction	78
Digital Zoom	79
Zoom Speed	80
Fixed Aperture	80
Sound Settings	81
Record Orientation	81
Rotate Tall	82
Auto Off	82
Format Memory/Format Card	83
Language	83
TV Settings	84
External Mic Sensitivity	84

Built-in ND Filter	 85
Customize Command Dials	 86
Multi Selector Right Press	 86
Delete Button Options	 86
AE/AF Lock Button	 87
Fn1 + Shutter Button	 88
Fn1 + Command Dial	 89
Fn1 Guide Display	 89
Fn2 Button	 90
Customize My Menu	 90
Reset File Numbering	 91
Blink Warning	 92
Eye-Fi Upload	 93
MF Distance Indicator Units	 94
Reverse Indicators	 94
Reset All	 94
Firmware Version	 98
File and Folder Names	 99
Speedlights (External Flash Unit)	 101
How to Attach a Speedlight	 101
Optional Accessories	 103
Shooting with Remote Control	 105
Error Messages	 107
Technical Notes and Index	 1
Caring for the Products	 2
The Camera	 2
The Battery	 3
The Battery Charger	 4
The Memory Cards	 5
Caring for the Camera	 6
Cleaning	 6
Storage	 6
Troubleshooting	 7
Specifications	 13
Supported Standards	 16
Index	 17

Parts of the Camera and Basic Operations

This chapter describes the parts of the camera and also explains the main functions of each part and the basic camera operations.

Parts of the Camera	2
The Camera Body	2
Controls Used in Shooting Mode	4
Controls Used in Playback Mode	6
Changing the Angle of the Monitor	7
Raising and Lowering the Flash	7
Attaching the Camera Strap	7
The Monitor	8
Basic Operations	11
Switching Between Shooting Mode and Playback Mode	11
Using the Rotary Multi Selector	12
Using Menu (the MENU Button)	13
Switching the Monitor Display (the  Button)	15
Using the Viewfinder	16

➔ If you want to start using the camera right away, see “The Basics of Shooting and Playback” ( 17).

Parts of the Camera

The Camera Body

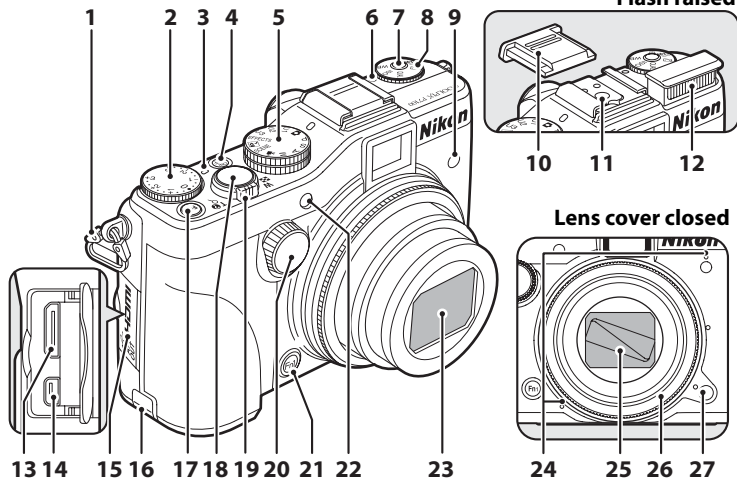

Parts of the Camera and Basic Operations



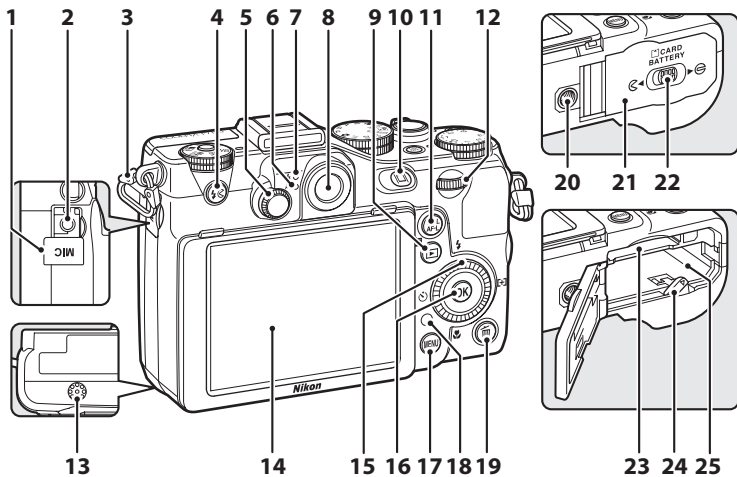







1	Eyelet for camera strap.....7	17	Fn2 (FUNC2) button108
2	Exposure compensation dial.....71	18	Shutter-release button.....4, 32
3	Exposure compensation dial mark...71	19	Zoom control.....31
4	Power switch/power-on lamp.....25		W : Wide31
5	Mode dial.....28		T : Tele31
6	Quick menu dial mark.....72		: Thumbnail playback.....35
7	Quick menu button.....72	: Playback zoom.....35	
8	Quick menu dial.....72	: Help39	
9	Infrared receiver (front).....60, 105	20	Sub-command dial.....51, 53
10	Accessory Shoe Cover BS-1.....101	21	Fn1 (FUNC1) button107
11	Accessory shoe.....101	22	Self-timer lamp.....64
12	Flash.....61		AF-assist illuminator.....105
13	HDMI mini connector (Type C).....91	23	Lens
14	USB/Audio video connector.....91	24	Microphone (stereo).....90, 98
15	Connector cover.....91	25	Lens cover
16	Power connector cover (for connection with an optional AC Adapter)....103	26	Lens ring.....55, 55
		27	Lens ring release button.....55, 55

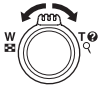





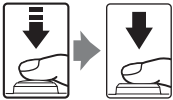

1	Microphone connector cover.....	100
2	External microphone connector.....	100
3	Eyelet for camera strap.....	7
4	⚡ (flash pop-up) button.....	7
5	Diopter adjustment control.....	16
6	Autofocus (AF)/access lamp.....	32
7	Flash lamp.....	61
8	Viewfinder.....	16
9	▶ (playback) button.....	11, 34
10	◻ (monitor) button.....	15, 16
11	AE-L/AF-L (AE-L/AF-L) button.....	5, 107
12	📅 (list by date) button.....	88
13	Speaker.....	90, 102, 106













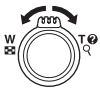



14	Monitor.....	8, 15
15	Rotary multi selector (multi selector).....	12
16	OK (apply selection) button.....	12
17	MENU (menu) button.....	13
18	Infrared receiver (rear).....	60, 105
19	🗑️ (delete) button.....	36, 102
20	Tripod socket	
21	Battery-chamber/ memory card slot cover.....	20, 22
22	Cover latch.....	20, 22
23	Memory card slot.....	22
24	Battery latch.....	20, 21
25	Battery chamber.....	20

Controls Used in Shooting Mode

Control	Name	Main Function	
	Mode dial	Change the shooting mode.	28
	Zoom control	Rotate toward T (Q) (telephoto zoom position) to zoom in, and rotate toward W (wide-angle position) to zoom out.	31
	Rotary multi selector	See "Using the Rotary Multi Selector" for more information.	12
	Main command dial	Adjust shutter speed or aperture value.	51, 53
	Sub-command dial		
	Quick menu dial, Quick menu button	Display or exit the quick menu.	72
	MENU (menu) button	Display and hide the menu.	13
	Shutter-release button	When pressed halfway (i.e., if you stop pressing when you feel resistance slightly): Set focus and exposure. When pressed all the way (i.e., if you press the button all the way down): Release the shutter.	32
	Exposure compensation dial	Adjust the brightness (exposure compensation).	71

Control	Name	Main Function	
	AE-L/AF-L (AE-L/AF-L) button	Lock the exposure or focus.	107
	Fn1 (FUNC1) button	Combined with the zoom control: Change the zoom lens focal length. Combined with the shutter-release button: Shoot with the assigned function setting. Combined with the command dial: Change the assigned function setting.	56 107 108
	Fn2 (FUNC2) button	Change the assigned function setting.	108
	Monitor button	Switch the monitor display.	15
	Playback button	Play back images.	11, 34
	Delete button	Delete the last image that was saved.	36

Controls Used in Playback Mode

Control	Name	Main Function	
	Playback button	<ul style="list-style-type: none"> When the camera is turned off, press and hold this button to turn the camera on in playback mode. Return to shooting mode. 	25 11
	Zoom control	<ul style="list-style-type: none"> Enlarge the image when rotated toward T (); display image thumbnails or the calendar when rotated toward W (). Adjust the volume for voice memo and movie playback. 	35 90 102
	Rotary multi selector	See "Using the Rotary Multi Selector" for more information.	12
	Main command dial	Select pictures and date.	34, 35
	Sub-command dial		
	Apply selection button	<ul style="list-style-type: none"> Play back movies. Switch from image thumbnail or zoomed image display to full-frame playback mode. 	102 12
	MENU (menu) button	Display and hide the menu.	13
	Delete button	Delete images.	36
	 (list by date) button	Display the list by date screen.	88
	 (monitor) button	Switch the monitor display.	15
	Shutter-release button	Return to shooting mode.	–

Changing the Angle of the Monitor

The angle of the monitor can be lowered down to approx. 81° or raised upward to approx. 105°. This is convenient when taking pictures with the camera held at high or low positions.

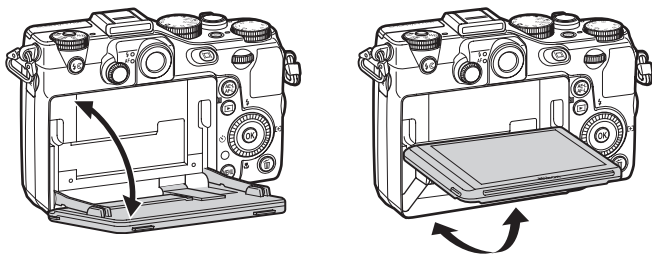

Notes on Monitor

- Do not apply excessive force when changing the angle of the monitor.
- The monitor cannot be moved horizontally.
- Put the monitor back in the original position when using in normal situations.

Raising and Lowering the Flash

Press the  (flash pop-up) button to raise the flash.

- See "Using the Flash (Flash Modes)" (61) for more information on setting the flash.
- When not using the flash, lower it by gently pushing it down until it clicks.

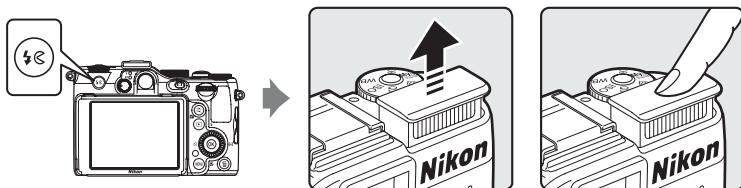

Attaching the Camera Strap

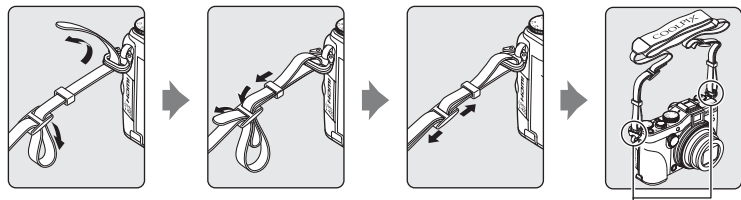





Attach the strap at two places.

The Monitor

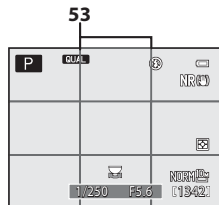
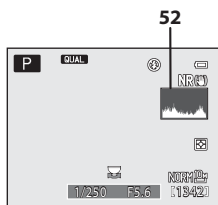
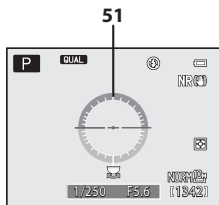
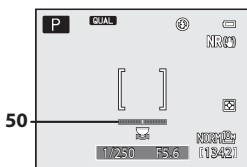
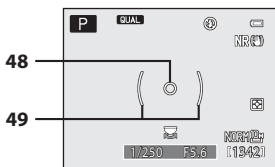
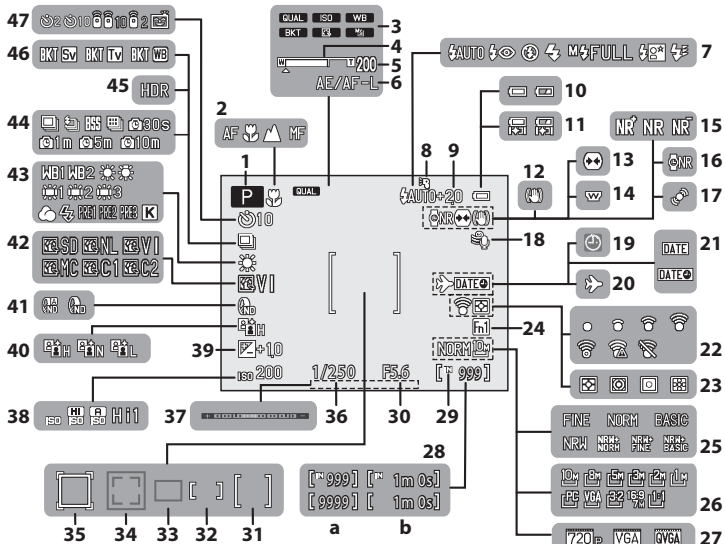
- The information that is displayed on the monitor during shooting and playback changes depending on the camera's settings and state of use. Press the **[INFO]** (monitor) button to hide or show the information on the monitor (15).

Shooting Mode



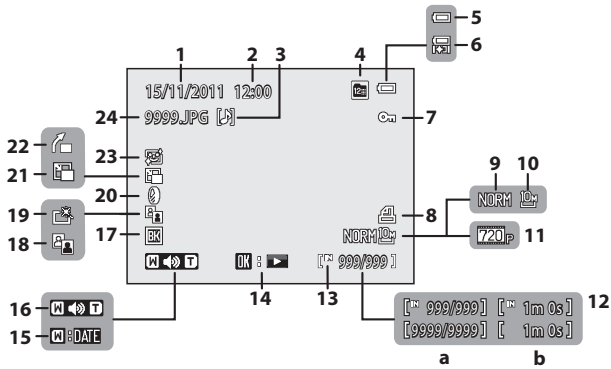

1	Shooting mode.....	28, 29
2	Focus mode.....	68
3	Quick menu dial indicator.....	72
4	Zoom indicator.....	31
5	Zoom memory.....	56
6	AE/AF-L indicator..... 	104
	AE-L/AF-L button setting.....	107
7	Flash mode.....	62
8	Speedlight..... 	101
9	Flash exp. comp.....	50, 55
10	Battery level indicator.....	24
11	Monitor brightness boost indicator.....	16
12	Vibration reduction icon.....	105
13	Distortion control.....	55
14	Wide-angle converter.....	55
15	Noise reduction filter.....	55
16	Long exposure NR.....	55
17	Motion detection icon.....	105
18	Wind noise reduction.....	101
19	"Date not set" indicator.....	27, 104
20	Travel destination indicator.....	104
21	Print date.....	104
22	Eye-Fi communication indicator..... 	108, 93
23	Metering.....	54
24	Fn1 button operation indicator.....	108
25	Image quality.....	74, 75
26	Image size.....	74, 77
27	Movie options.....	73, 100
28	(a) Number of exposures remaining (still pictures).....	24, 78
	(b) Movie length.....	98, 100
29	Internal memory indicator.....	24
30	Aperture value.....	51
31	Focus area (for center).....	32, 55, 60
32	Focus area (for manual).....	42, 43, 55, 60
33	Focus area (for auto).....	55, 60
34	Focus area (for face detection, pet detection).....	45, 55, 60, 65, 85
35	Focus area (for subject tracking).....	55, 60
36	Shutter speed.....	51
37	Exposure indicator.....	53
38	ISO sensitivity.....	30, 73
39	Exposure compensation value.....	71
40	Active D-Lighting.....	55
41	Built-in ND filter.....	107
42	COOLPIX Picture Control.....	73
43	White balance.....	73
44	Continuous shooting mode.....	45, 50, 54
45	Backlighting (HDR).....	44
46	Auto bracketing.....	73
	Self-timer.....	64
47	Remote control.....	60
	Smile timer.....	65
48	Spot metering area.....	50, 54
49	Center-weighted area.....	50, 54
50	Virtual horizon (bars).....	104
51	Virtual horizon (circle).....	104
52	View/hide histograms.....	104
53	View/hide framing grid.....	104

Playback Mode



1	Date of recording.....	26
2	Time of recording.....	26
3	Voice memo indicator.....	90
4	List by date display.....	88
5	Battery level indicator.....	24
6	Monitor brightness boost indicator.....	16
7	Protect icon.....	89
8	Print order icon.....	89
9	Image quality.....	75
10	Image size.....	77
11	Movie options.....	73, 100
12	(a) Current image number/total number of images.....	34
	(b) Movie length.....	102

13	Internal memory indicator.....	34
14	Movie playback guide.....	102
15	List by date guide.....	88
16	Volume indicator.....	90, 102
17	Black border indicator.....	90
18	D-Lighting icon.....	89
19	Quick retouch icon.....	89
20	Filter effects icon.....	89
21	Small picture.....	89,  19
22	Straighten indicator.....	90
23	Skin softening icon.....	89
24	File number and type.....	 99

Basic Operations

Switching Between Shooting Mode and Playback Mode

The camera has two modes of operation: Shooting mode, which is used for taking pictures, and playback mode, which is used for viewing pictures.

Press the  (playback) button to switch between shooting mode and playback mode.

- While using playback mode, you can also switch to shooting mode by pressing the shutter-release button.

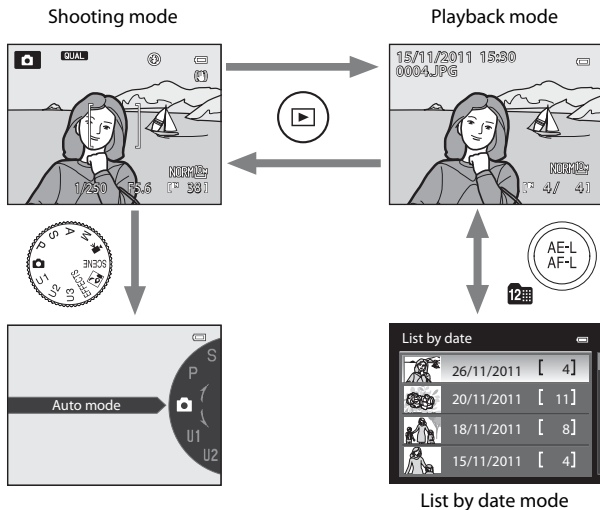

- Rotate the mode dial and align an icon to the mark to select different shooting modes (📖28, 29).
- Press the  (list by date) button in playback mode to select pictures for playback by shooting date (📖88).

Using the Rotary Multi Selector

Operate by rotating the rotary multi selector, pressing up (▲), down (▼), left (◀) or right (▶) on the rotary multi selector, or pressing the **OK** button.

- The “rotary multi selector” is also referred to as the “multi selector” in this manual.

When Using Shooting Mode

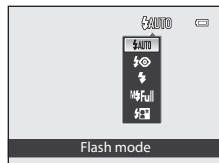
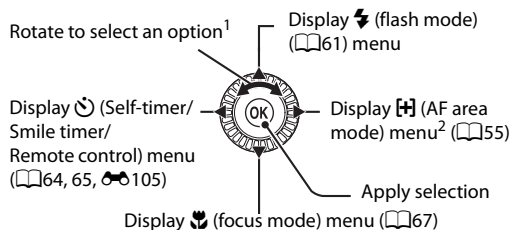

¹ Items can also be chosen by pressing up, down, left or right.

² Displayed for **P**, **S**, **A**, **M**, **U1**, **U2** and **U3** modes, (low noise night) mode, and **EFFECTS** (special effects) mode.

When Using Playback Mode

Select the previous image¹, move the displayed area when the image is magnified (35).

Play back movies (102)²

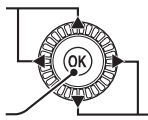

Select the next image¹, move the displayed area when the image is magnified (35).

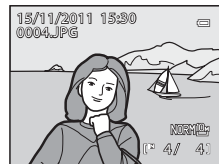

¹ Previous or next images can also be chosen by rotating the rotary multi selector.

² When displaying image thumbnails or when the image is magnified, this button switches the camera to full-frame playback mode.

When Displaying Menus

Select the item above*

Select the item on the left*, return display to the previous screen

Select the item below*



Select the item on the right*, display sub-menu (apply selection)

Apply selection

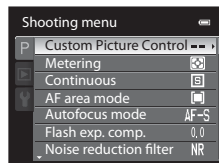

* Items above or below can also be chosen by rotating the rotary multi selector.

Using Menus (the MENU Button)

When the **MENU** button is pressed while the shooting screen or playback screen is displayed, the menu for the current mode is displayed. Once the menu is displayed, various settings can be changed.

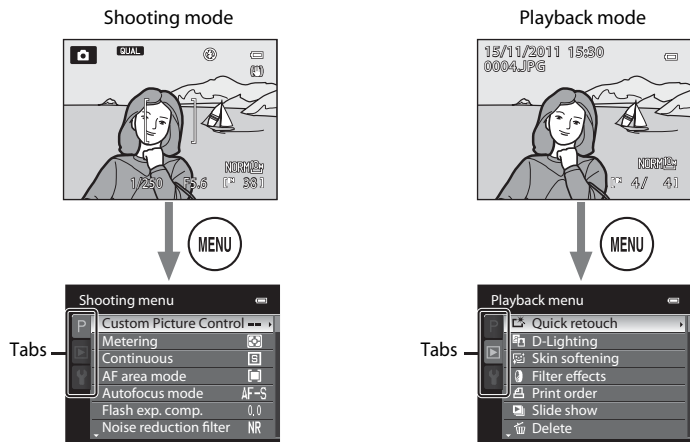

P tab:

Displays the settings that can be changed for the current shooting mode (📖29). Depending on the current shooting mode, the tab icon that is displayed will be different.

- 📷 (auto): Tabs are not displayed.
- 📖 (scene): Scene menu tab (📖39)
- 🎭 (special effects): Special effects menu tab (📖48)
- 🌃 (low noise night): Low noise night menu tab (📖50)
- P, S, A, M: Shooting menu tab (📖54)
- U1, U2, U3: U1, U2, U3 specialized menu tab (📖58), shooting menu tab on the second level
- 🎬 (movie): Movie menu tab (📖101)

▶ tab:

Displays the settings that can be changed for the current playback mode (📖89). Depending on the current playback mode, the tab icon that is displayed will be different.

Y tab:

Displays the setup menu, where you can change a number of general settings.

Switching Between Tabs

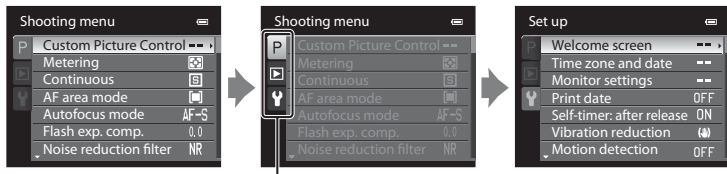

Press the rotary multi selector ◀ to highlight the tab.

Press the rotary multi selector ▲ or ▼ to select a tab, and press the OK button or ▶.

The selected menu is displayed.

Selecting Menu Items

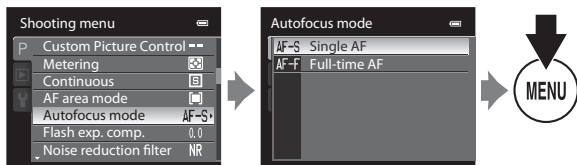

Press the rotary multi selector ▲ or ▼ to select an item, and then press ▶ or the OK button.

Press ▲ or ▼ to select an item and then press the OK button.

When you finished changing settings, press the MENU (menu) button to exit the menu.

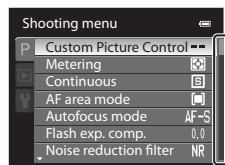
 **Displayed When the Menu Contains Two or More Pages**

The scroll bar is displayed to indicate the current page.

Switching the Monitor Display (the Button)

To switch between the information displayed on the monitor during shooting and playback, press the  (monitor) button.

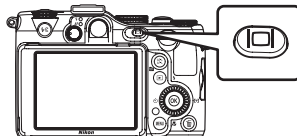

Shooting Mode

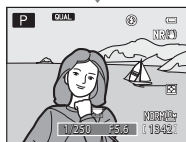

Display information

Display the picture and the shooting information.



Information hidden

Display the picture only.



Monitor off¹

Turn off the monitor.

Playback Mode

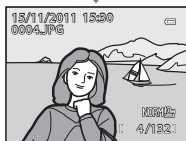

Display photo information

Display the picture and photo information.



Information hidden

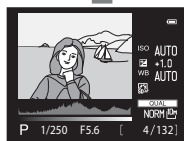

Display the picture only.



Tone level information² (excluding movies)

Display a histogram³, tone level and shooting information⁴.

1 Available when the mode dial is set to **P**, **S**, **A**, **M**, **U1**, **U2** or **U3**. The shutter does not click when the subject is not in focus and the AF/access lamp does not light up.





2 You can check for loss of contrast detail in highlights and shadows from the histogram that is displayed, or the blinking display for each tone level. These provide guidelines when adjusting the picture brightness with functions such as exposure compensation. When the tone level to check is selected by pressing the rotary multi selector  or , the area of the picture that corresponds to the chosen tone level blinks.

3 The histogram is a bar graph that shows the brightness distribution in the picture. The horizontal axis corresponds to pixel brightness, with dark tones to the left and bright tones to the right. The vertical axis shows the number of pixels.



4 The shooting information displayed includes the shooting mode **P**, **S**, **A** or **M**, shutter speed, aperture value, image quality, image size, ISO sensitivity, white balance, exposure compensation, COOLPIX Picture Control, and the current frame number/total number of frames.

P is displayed when the shooting mode , **SCENE EFFECTS**,  or **P** is chosen.

Holding Down the Button and (Monitor Brightness Boost Indicator)

Hold down the  button to set the monitor to the maximum brightness. To return the brightness to its original level, hold down the  button again or turn off the camera. When the brightness is set to the maximum with the  button,  (monitor brightness boost indicator) is displayed on the monitor.

Virtual Horizon, Histogram and Framing Grid Displays for Shooting

- The display options for the monitor can be changed in **Photo info** (74) of **Monitor settings** in the setup menu. A virtual horizon, histogram and framing grid are available as the display options.
- The setting for virtual horizon display can be changed in **Virtual horizon display** of **Monitor settings** in the setup menu (104). The default setting is **Circle**.

Using the Viewfinder

Use the viewfinder to frame pictures when bright light makes it difficult to see the monitor.

When the image in the viewfinder is difficult to see, adjust by rotating the diopter adjustment control while looking through the viewfinder.





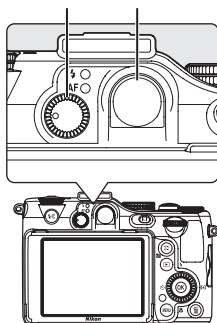

- Take care not to scratch your eye with your fingertips or nails.

Diopter
adjustment
control Viewfinder



Notes on the Viewfinder

As the area visible in the viewfinder may differ from that of the final picture, use the monitor to frame pictures in the following situations:

- When shooting at ranges of about 2 m (6 ft 7 in.) or less at the maximum telephoto zoom position
- When a wide-angle converter lens is used (available separately; 103)
- When the digital zoom is applied (31)
- When shooting at an **Image size** (77) of  **3648×2432**,  **3584×2016** or  **2736×2736**



The Basics of Shooting and Playback

Preparation

Preparation 1 Charge the Battery	18
Preparation 2 Insert the Battery	20
Preparation 3 Insert a Memory Card	22



Shooting

Step 1 Turn the Camera On	24
Setting the Display Language, Date, and Time (First Use Only)	26
Step 2 Select a Shooting Mode	28
Step 3 Frame a Picture	30
Step 4 Focus and Shoot	32



Playback

Step 5 Play Back Images	34
Step 6 Delete Unwanted Images	36

Preparation 1 Charge the Battery

1 Prepare the included Battery Charger MH-24.

If a plug adapter* is included with your camera, attach the plug adapter to the plug on the Battery Charger. Push the plug adapter firmly until it is securely held in place. Once the two are connected, attempting to forcibly remove the plug adapter could damage the product.

* The shape of the plug adapter varies according to the country or region in which the camera was purchased.

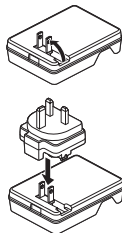

The Battery Charger comes with the plug adapter attached in Argentina, Brazil and Korea.

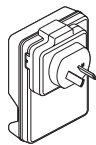

2 While pushing in the battery (①), set it into the Battery Charger (②).

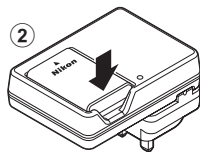
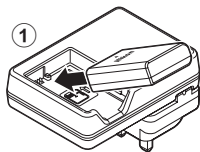

3 Plug the Battery Charger into an electrical outlet.

- CHARGE lamp starts blinking when charging starts.
- A fully-exhausted battery charges in about one hour and 30 minutes.
- When charging is complete, the CHARGE lamp stops blinking.
- See "Understanding CHARGE Lamp" (19).

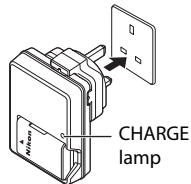

4 When charging is complete, remove the battery and then disconnect the Battery Charger from the electrical outlet.

Understanding CHARGE Lamp

Status	Description
Blinks	Battery charging.
On	Battery fully charged.
Flickers	<ul style="list-style-type: none"> The battery is set incorrectly. Disconnect the Battery Charger from the electrical outlet, remove the battery, and then reset the battery to lie flat in the Battery Charger. Operating temperature range exceeded. Charge the battery indoors while the ambient temperature is 5°C to 35°C (41°F to 95°F). The battery is faulty. Immediately disconnect the Battery Charger from the electrical outlet, and stop charging. Take the battery and Battery Charger to your retailer or Nikon-authorized service representative.

Notes on Battery Charger

- Be sure to read and follow the warnings of “For Your Safety” (📖vi) thoroughly before using the Battery Charger.
- Be sure to read and follow the warnings for “The Battery Charger” (🔋4) thoroughly before using the battery.

Notes on Battery

- Be sure to read and follow the warnings of “For Your Safety” (📖vi) thoroughly before using the battery.
- Be sure to read and follow the warnings for “The Battery” (🔋3) thoroughly before using the battery.

AC Power Supply

- If the AC Adapter EH-5b and the Power Connector EP-5A (available separately) (🔌103) are used, power is supplied to the camera from an electrical outlet, enabling taking and playing back pictures.
- Do not, under any circumstances, use an AC Adapter other than the EH-5b or a Power Connector other than the EP-5A. Failure to observe this precaution could result in overheating or in damage to the camera.

Preparation 2 Insert the Battery

- 1 Open the battery-chamber/memory card slot cover.

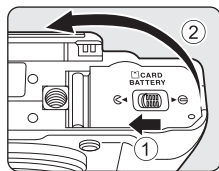

- 2 Insert the battery.

- Use the battery to push the orange battery latch in the direction shown (1), and fully insert the battery (2).
- When the battery is fully inserted, the battery latch locks it in place.

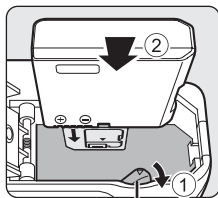

Battery latch

Inserting the Battery Correctly

Inserting the battery upside down or backwards could damage the camera. Be sure to confirm that the battery is in the correct orientation.

- 3 Close the battery-chamber/memory card slot cover.

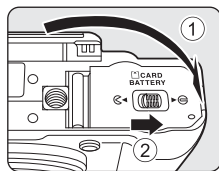

Removing the Battery

Before opening the battery-chamber/memory card slot cover, turn the camera off (📖25) and confirm that the power-on lamp and the monitor are off.

To eject the battery, open the battery-chamber/memory card slot cover and slide the orange battery latch in the direction shown (①). Then, remove the battery straight (②).

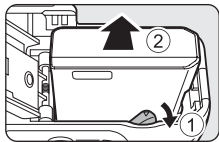

High Temperature Caution

The camera, battery, and memory card may be hot immediately after using the camera. Observe caution when removing the battery or memory card.

Preparation 3 Insert a Memory Card

- 1 Confirm that the power-on lamp and the monitor are turned off and open the battery-chamber/memory card slot cover.
 - Be sure to turn off the camera before opening the cover.

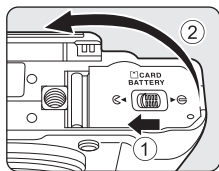

- 2 Insert the memory card.
 - Slide the memory card until it clicks into place.

✓ Inserting the Memory Card Correctly

Inserting the memory card upside down or backwards could damage the camera or the memory card. Be sure to confirm that the memory card is in the correct orientation.

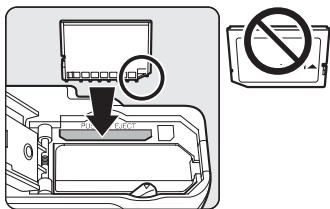

- 3 Close the battery-chamber/memory card slot cover.

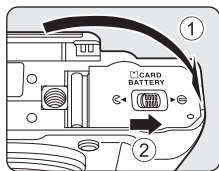

✓ Formatting a Memory Card

- The first time you insert a memory card that has been used in another device into this camera, be sure to format it with this camera.
- **All data stored on a memory card is permanently deleted when the card is formatted.** Be sure to make copies of any data you wish to keep before formatting the memory card.
- To format a memory card, insert the memory card into the camera, press the **MENU** button and select **Format card** from the setup menu (104).

✓ Note on Memory Cards

Refer to the documentation included with the memory card, as well as “The Memory Cards” (5) in “Caring for the Products”.

Removing Memory Cards

Before opening the battery-chamber/memory card slot cover, turn the camera off and confirm that the power-on lamp and the monitor are off.

Press the memory card in lightly with your finger (①) to partially eject it, and then pull it out straight (②).

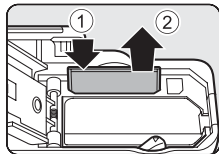

High Temperature Caution

The camera, battery, and memory card may be hot immediately after using the camera. Observe caution when removing the battery or memory card.

Internal Memory and Memory Cards

Camera data, including images and movies, can be saved in either the camera's internal memory (approximately 94 MB) or on a memory card. To use the camera's internal memory for shooting or playback, first remove the memory card.

Approved Memory Cards

The following Secure Digital (SD) memory cards have been tested and approved for use in this camera.

- When recording a movie onto a memory card, a memory card with an SD speed class of Class 6 or higher is recommended. If the transfer speed of the card is slow, the movie recording may end unexpectedly.

	SD memory cards ¹	SDHC memory cards ²	SDXC memory cards ³
SanDisk	2 GB	4 GB, 8 GB, 16 GB, 32 GB	64 GB
TOSHIBA	2 GB	4 GB, 8 GB, 16 GB, 32 GB	64 GB
Panasonic	2 GB	4 GB, 8 GB, 12 GB, 16 GB, 32 GB	48 GB, 64 GB
Lexar	-	4 GB, 8 GB, 16 GB, 32 GB	-

1 Before using a card reader or similar device, check that the device supports 2 GB cards.

2 SDHC-compliant. Before using a card reader or similar device, check that the device supports SDHC.

3 SDXC-compliant. Before using a card reader or similar device, check that the device supports SDXC.



- Contact the manufacturer for details on the above cards.

Step 1 Turn the Camera On

1 Press the power switch to turn on the camera.

- If you are turning the camera on for the first time, see “Setting the Display Language, Date, and Time” (📖26).
- The lens extends, and the monitor is turned on.

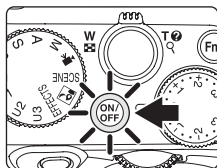

2 Check the battery level and number of exposures remaining.

Battery level indicator

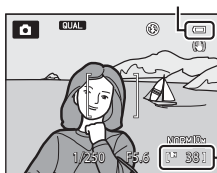

Number of exposures remaining

Battery Level

Display	Description
	Battery level high.
	Battery level low. Prepare to charge or replace the battery.
Battery exhausted.	Cannot take pictures. Charge or replace the battery.

Number of Exposures Remaining

The number of exposures remaining is displayed.

- When a memory card is not inserted, is displayed and pictures are recorded to the internal memory (approx. 94 MB).
- The number of pictures that can be stored depends on the remaining capacity of the internal memory or memory card, the image quality, and the image size (📖78).
- The number of exposures remaining shown in the illustration differs from the actual value.

Turning the Camera On and Off

- When the camera is turned on, the power-on lamp (green) lights and the monitor is turned on (the power-on lamp turns off when the monitor is turned on).
- To turn off the camera, press the power switch. Both the monitor and the power-on lamp are turned off.
- To turn on the camera in playback mode, press and hold the  (playback) button. At this time, the lens does not extend.

Power Saving Function (Auto Off)

If no operations are performed for a while, the monitor will turn off, the camera will enter standby mode, and the power-on lamp will blink. If no operations are performed for another three minutes, the camera will turn off automatically.

To turn on the monitor again in standby mode, perform either one of the following operations.

- Press the power switch, shutter-release button or the  button.
- Rotate the mode dial.

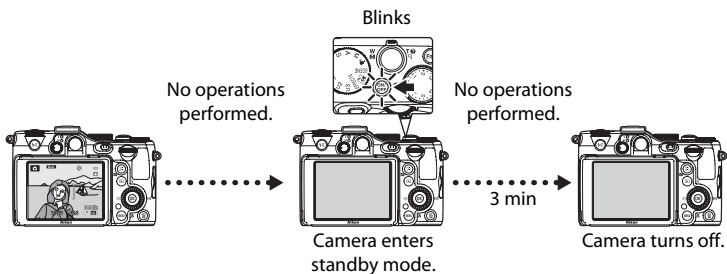

- The time that elapses before the camera enters standby mode can be changed using the **Auto off** setting in the setup menu (📖104).
- By default, the camera enters standby mode in about one minute when you are using shooting mode or playback mode.
- If you are using the optional AC Adapter EH-5b, the camera enters standby mode after 30 minutes. This setting cannot be changed.

Setting the Display Language, Date, and Time

Dialogs for language selection and camera clock setting are displayed the first time the camera is turned on.

- 1 Press the multi selector ▲ or ▼ to choose the desired language and press the **OK** button.

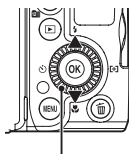

Multi selector

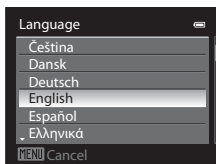

- 2 Press ▲ or ▼ to choose **Yes** and press the **OK** button.

- To cancel setting, select **No**.

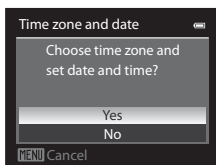

- 3 Press ◀ or ▶ to select your home time zone (Time zone), and press the **OK** button.

- See "Daylight Saving Time" (📖27) for more information.

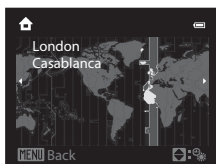
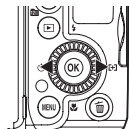

- 4 Press ▲ or ▼ to choose the date display order and press the **OK** button or ▶.

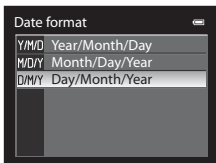

5 Press ▲, ▼, ◀ or ▶ to set date and time, and press the **OK** button.

- To choose an item: Press ▶ or ◀ (selected in the following order: **D** (day) → **M** (month) → **Y** (year) → **hour** → **minute**).
- To set the contents: Press ▲ or ▼. Date and time can also be set by rotating the command dial.
- Finish setting: Choose **minute**, and press the **OK** button or ▶.
- After finishing the setting, the lens extends and the shooting screen is displayed.

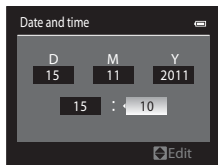

Daylight Saving Time

If daylight saving time is in effect, press the multi selector ▲ to enable the daylight saving time function while setting the region in step 3.

☀ is displayed at the top of the monitor.

Press ▼ to disable the daylight saving time function.

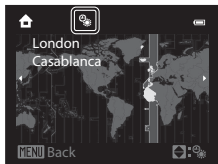

Changing the Language Setting and the Date and Time Setting

- You can change these settings using the **Language** and **Time zone and date** settings in **Y** setup menu (📖104).
- In the **Time zone** setting of **Time zone and date** in **Y** setup menu, when the daylight saving time function is enabled, the camera's clock is set forward by one hour, and when disabled, set back by one hour. When the ➔ travel destination is set, the camera automatically calculates the time difference between the travel destination and the 🏠 home time zone, and saves images using the date and time of the travel destination.
- If you exit without setting the date and time, 🕒 blinks when the shooting screen is displayed. Use the **Time zone and date** setting in the setup menu (📖104) to set the date and time.

The Clock Battery



- The camera's clock is powered by a backup battery that is separate from the camera's main battery.
- The backup battery charges after about ten hours of charging when the main battery is inserted into the camera or when the camera is connected to an optional AC adapter, and can store the set date and time for several days.
- If the camera's backup battery becomes exhausted, the date and time setting screen is displayed when the camera is turned on. Set the date and time again. See step 2 of "Setting the Display Language, Date, and Time" (📖26) for more information.

Imprinting the Shooting Date in Printed Images



- Set the date and time before shooting.
- You can imprint the shooting date in images as they are captured by setting **Print date** in the setup menu (📖104).
- If you want the shooting date to be printed without using the **Print date** setting, print using the included ViewNX 2 software (📖92).

Step 2 Select a Shooting Mode

Rotate the mode dial to select the shooting mode.

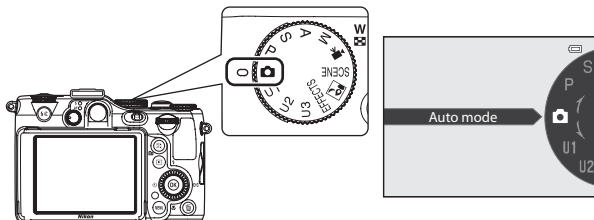
- The following describes how to take pictures in  (auto) mode as an example. Rotate the mode dial to .



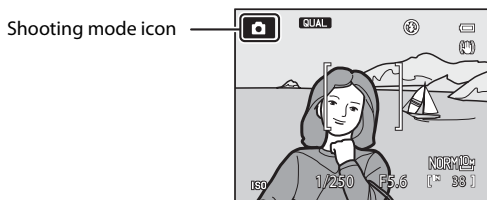

- The camera switches to  (auto) mode and the shooting mode icon changes to .





- See "The Monitor" () 8 for more information.









Available Shooting Modes

 (Auto) mode	38
Shoot with basic camera operations.	
SCENE (Scene) mode	39
When one of the scene modes is selected, pictures are captured using settings that are optimized for the selected scene. In scene auto selector mode, the camera automatically selects the optimum scene mode for simpler shooting.	
EFFECTS Special effects mode	46
Effects can be applied to pictures during shooting. Ten different effects are available.	
 Low noise night mode	49
Shoot with the ISO sensitivity controlled automatically to a high level and without the flash, to capture the atmosphere of a low-lit scene.	
P, S, A, M modes	51
Choose these modes for greater control over shutter speed and aperture value.	
U1, U2, U3 User settings modes	57
Up to three setting combinations that are frequently used for shooting can be saved in U1 , U2 and U3 . The saved settings can be immediately retrieved for shooting simply by rotating the mode dial to U1 , U2 or U3 .	
 (Movie) mode	98
Movies can be recorded with sound.	

Note on the Flash

When the flash is lowered, the flash setting is fixed at off and  is displayed at the top of the monitor. In situations where a flash is needed, such as in dark locations or when the subject is backlit, be sure to raise the flash (.

Features That Are Available in Shooting Mode

- The functions of the multi selector , ,  or  can be set. See “Features That Can Be Set Using the Multi Selector” (60) for more information.
- See “Features That Can Be Set Using the Exposure Compensation Dial” for more information on exposure compensation (.
- See “Features That Can Be Set with the Quick Menu” for more information on available quick menu (.
- Press the **MENU** button to display the menu for the selected shooting mode. See “Shooting Features” (37) for more information about the settings available in the menu for the current shooting mode.

Step 3 Frame a Picture

1 Ready the camera.

- Keep your fingers, hair, strap and other objects away from the lens, flash, AF-assist illuminator and microphone.
- To shoot in the “tall” orientation, hold the camera so that the flash is above the lens.

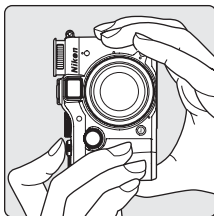

2 Frame the picture.

- Position the main subject near the center of the monitor.
- See “Using the Viewfinder” (📖16) for more information.

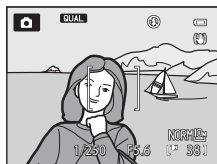

ISO Sensitivity

ISO (ISO sensitivity, 📖8) may be displayed on the shooting screen. When **ISO** is displayed, the ISO sensitivity is automatically raised.

Using a Tripod

- In the following situations, use of a tripod is recommended to avoid the effects of camera shake:
 - When shooting in a dark location or with the flash mode (📖61) set to **☺** (off)
 - When shooting in the telephoto zoom position
- To take a picture with the camera attached to a tripod, set **Vibration reduction** in the setup menu (📖104) to **Off**.

Using the Zoom

Rotate the zoom control to activate the optical zoom.

- To zoom in so that the subject fills a larger area of the frame, rotate toward **T** (telephoto zoom position).
- To zoom out so that the area visible increases in the frame, rotate toward **W** (wide-angle position).
- A zoom indicator is displayed at the top of the monitor when the zoom control is rotated.

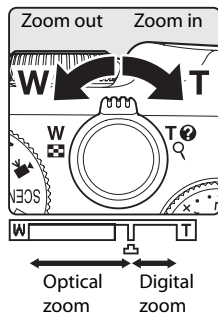

Digital Zoom

When the camera is already at the maximum optical zoom position, rotating the zoom control toward **T** (telephoto zoom position) triggers the digital zoom.

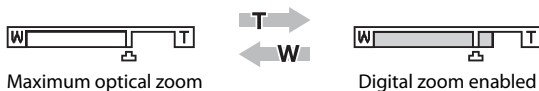

Digital zoom can magnify the subject up to about 4x beyond the maximum magnification of the optical zoom.



- The focus will be at the center of the frame and the focus area will not be displayed when the digital zoom is in effect.

Digital Zoom and Interpolation

Unlike the optical zoom, the digital zoom uses a digital imaging process known as interpolation to magnify images, resulting in slight deterioration of image quality depending on the image size (📖77) and digital zoom magnification.

Interpolation is applied at zoom positions beyond . When the zoom is increased beyond the  position, interpolation is initiated and the zoom indicator also turns yellow.

Additionally,  moves right as the image size becomes smaller, allowing you to confirm the zoom position that can be used to capture still images without image degradation before shooting at the current image size setting.



When the image size is small

- Using **Digital zoom** in the setup menu (📖104), it is possible to restrict the magnification of the digital zoom to a range where images do not deteriorate, or to set the digital zoom so that it does not operate.

More Information

- See “Zoom memory” (📖56) for more Information.
- See “Zoom speed” (📖106) for more Information.

Step 4 Focus and Shoot

- 1 Press the shutter-release button halfway, i.e., press the button slightly until you feel resistance.

- When you press the shutter-release button halfway, the camera sets the focus and exposure (shutter speed and aperture value). Focus and exposure remain locked while the shutter-release button is pressed halfway.
- The camera automatically focuses on the subject in the center focus area. When the subject is in focus, the focus area lights in green, and the AF/access lamp next to the viewfinder lights.
- When the digital zoom is in effect, the camera focuses on the subject at the center of the screen, and the focus area is not displayed. When the subject is in focus, the AF/access lamp lights in green.
- When the shutter-release button is pressed halfway and the focus area blinks red or the AF/access lamp flickers, the camera is unable to focus. Change the composition and press the shutter-release button halfway again.

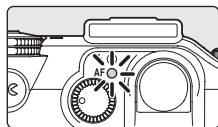
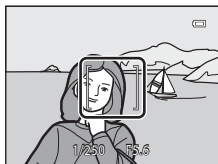

- 2 Press the shutter-release button all the way, i.e., press the button the rest of the way down.

- The shutter is released and the picture is recorded.
- If you press the shutter-release button with too much force, the camera may shake, causing images to be blurred. Press the button gently.



✓ During Recording

- While the AF/access lamp or the indicator showing the number of exposures remaining is blinking, images are being recorded. **Do not open the battery-chamber/memory card slot cover.** Cutting the power or removing the memory card in these circumstances could result in loss of data or in damage to the camera or card.
- Depending on the settings or shooting conditions, the image recording time may take longer than usual (p. 11).

✓ Autofocus

Autofocus may not perform as expected in the following situations. In some rare cases, the subject may not be in focus despite the fact that the active focus area or AF/access lamp lights in green.

- Subject is very dark
- Objects of sharply differing brightness are included in the scene (e.g. the sun behind the subject makes that subject appear very dark)
- No contrast between the subject and surroundings (e.g. a portrait subject, wearing a white shirt, is standing in front of a white wall)
- Several objects are at different distances from the camera (e.g., an animal inside a cage)
- Subjects that repeat the same pattern (e.g., as window blinds or buildings lined with windows of the same shape)
- Subject is moving rapidly

In these situations, try pressing the shutter-release button halfway to refocus several times, or focus on another subject and use focus lock. When using focus lock, be sure that the distance between the camera and the subject with which focus was locked is the same as that for the actual subject.

The camera can also be focused using manual focus (🔍2).

✓ The Subject Is Too Close to the Camera

If the camera does not focus, try shooting with 🌸 (macro close-up) (📖68) in the focus mode, or **Close-up** (📖42) scene mode.

📎 AF-assist Illuminator

In dark places, the AF-assist illuminator (📖105) may light when the shutter-release button is pressed halfway.

📎 To Make Sure You Do Not Miss a Shot

If you are concerned that you might miss a shot, press the shutter-release button all the way without first pressing it halfway.

📎 Focus Lock

Use focus lock to focus on off-center subjects when center is selected for AF area mode.

- Be sure that the distance between the camera and the subject does not change.
- When the shutter-release button is pressed halfway, the exposure is locked.

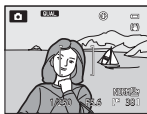

Frame the subject to be focused on using the camera.



Press the shutter-release button halfway.



Confirm that the focus area lights in green.



Continue holding down the shutter-release button halfway and recompose the picture.



Press the shutter-release button all the way to shoot.

Instead of pressing the shutter-release button halfway, you can also press the AE-L/AF-L (AE-L/AF-L) button to shoot with focus lock (📖107) (except for **Scene auto selector** (📖40) in scene mode).



Step 5 Play Back Images

1 Press the (playback) button.

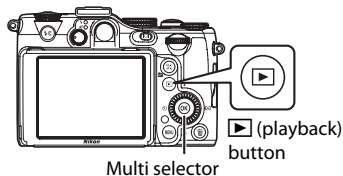
- When you switch from shooting mode to playback mode, the last image saved will be displayed in full-frame playback mode.







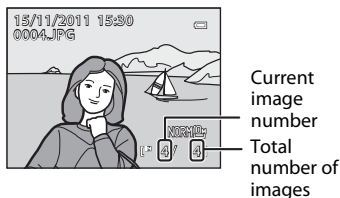

2 Use the multi selector to view previous or next images.



- To view previous images: ▲ or ◀
- To view next images: ▼ or ▶
- Images can also be selected by rotating the multi selector or command dial.
- To return to shooting mode, press the  button again or press the shutter-release button.
- To play back images that are saved in the internal memory, remove the memory card.  is displayed around "Current image number/total number of images" on the playback screen.



Viewing Pictures

- Press the  button to hide or show the shooting information and photo information on the monitor (15).
- When the orientation of the camera is changed during playback, the displayed images are rotated automatically (except when fast forward/rewind is performed).
- Pictures taken in "tall" orientation will be rotated automatically (106). The rotating direction can be changed from the **Rotate image** option in the playback menu (89).
- Pictures taken using face detection (85) or pet detection (45) will be rotated automatically when displayed in full-frame playback mode according to the orientation of the face (except for pictures taken when **Continuous** in the shooting menu or **Auto bracketing** in the quick menu (73) was set).
- Images may be displayed at low resolution immediately after switching to the previous or next image.

More Information

- See "Features Available in Playback Mode (Playback Menu)" (89) for more information.
- See "Selecting Pictures for Playback by Date (List by Date Mode)" (88) for more information.

Changing How Images Are Displayed

When using playback mode, you can change how images are displayed by rotating the zoom control toward **W** (📐)/**T** (🔍).

Playback Zoom

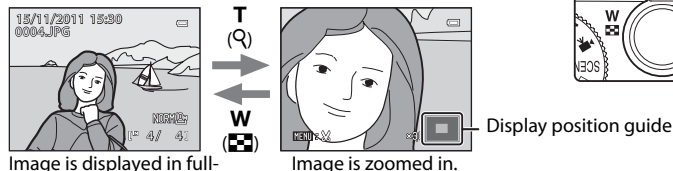
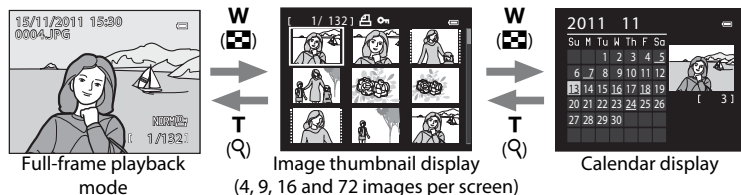

Image is displayed in full-frame playback mode.

Image is zoomed in.

- To adjust the zoom ratio, rotate the zoom control toward **W** (📐)/**T** (🔍). Images can be zoomed up to 10x.
- To view a different area of the image, press the multi selector ▲, ▼, ◀, or ▶.
- Pictures taken using face detection (📖85) or pet detection (📖45) are enlarged at the center of the face that was detected during shooting (except for pictures taken when **Continuous** in the shooting menu (📖54) or **Auto bracketing** in the quick menu (📖73) was set). If the camera detected multiple faces when the image was captured, use ▲, ▼, ◀, and ▶ to display a different face. Change the zoom ratio and press ▲, ▼, ◀, or ▶ to zoom in on an area of the image where there are no faces.
- You can crop the image and save the displayed area of the image as a separate file by pressing the **MENU** button (📖19).
- Press the **OK** button to return to full-frame playback mode.

Thumbnail Playback, Calendar Display



Full-frame playback mode

Image thumbnail display
(4, 9, 16 and 72 images per screen)

Calendar display

- You can view several images on one screen, making it easy to find the image you want.
- You can change the number of images displayed by rotating the zoom control toward **W** (📐)/**T** (🔍).
- Rotate the multi selector or press ▲, ▼, ◀, or ▶ to select an image and then press the **OK** button to display that image in full-frame playback mode.
- When 72 images are displayed, rotate the zoom control toward **W** (📐) to switch to calendar display.
- While using calendar display mode, rotate the multi selector or press ▲, ▼, ◀, or ▶ to select a date and then press the **OK** button to display the first image captured on that day.

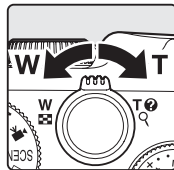



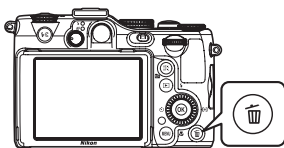

Step 6 Delete Unwanted Images

- 1 Press the  button to delete the image currently displayed on the monitor.





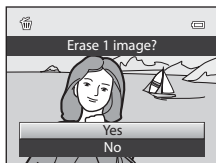

- 2 Press the multi selector  or  to select **Yes** and press the .

- Deleted images cannot be recovered.
- To cancel, press  or  to select **No** and press the  button.

When **Delete button options** in the setup menu (104) is set to **Press twice to delete**, the image can be deleted by pressing the  button again while a confirmation message for deleting an image is displayed.



Notes on Deletion

- Deleted images cannot be recovered. Transfer important images to a computer before deleting them.
- Protected images (89) cannot be deleted.
- When pictures taken with an **Image quality** (75) setting of **NRW (RAW) + Fine**, **NRW (RAW) + Normal** or **NRW (RAW) + Basic** are deleted with the  button, both the NRW (RAW) and JPEG images that were recorded at the same time are deleted. To delete only NRW (RAW) images or JPEG images, select **Erase selected NRW images** or **Erase selected JPEG images** in **Delete** of the playback menu (89).

Deleting the Last Image Captured While in Shooting Mode

When using shooting mode, press the  button to delete the last image that was saved.

Deleting Multiple Images

To delete multiple images, select **Delete** from the playback menu (89).

Selecting Certain Types of Images for Deletion

Switch to list by date mode (88) to delete a picture shot on a specified date.

Shooting Features

This chapter describes each of the camera's shooting modes and the features that are available when using shooting mode.

By referring to this information, you will learn how to select different shooting modes and adjust settings according to the shooting conditions and the kind of images you want to capture.

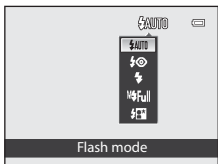
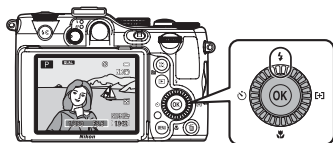
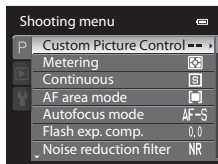
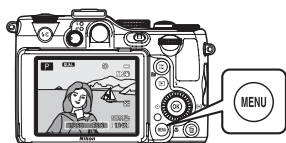
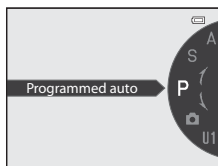
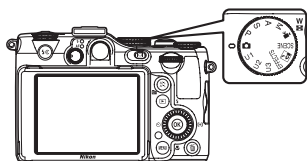

(Auto) Mode

Shooting with basic camera operations is available.

- The camera focuses at the center area of the frame.

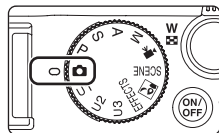

Changing (Auto) Mode Settings

- See “Features That Can Be Set Using the Multi Selector” (📖60) for more information on flash mode (📖61), self-timer (📖64), smile timer (📖65), remote control (📖60) and focus mode (📖67).
- See “Features That Can Be Set Using the Exposure Compensation Dial” for more information on exposure compensation (📖71).
- See “Features That Can Be Set with the Quick Menu” for more information on available quick menu (📖73).

Features That Cannot Be Used Simultaneously

This feature may not be used in combination with certain features (📖80).

Scene Mode (Shooting Suited to Scenes)

Press the **MENU** button and display the scene menu to select one of the following scenes. Pictures are captured using settings that are optimized for the selected scene.

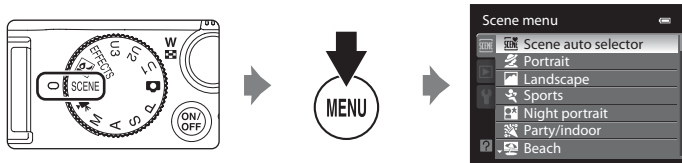

Scene auto selector (📖40)	Night landscape (📖42)
Portrait (📖40)	Close-up (📖42)
Landscape (📖40)	Food (📖43)
Sports (📖41)	Museum (📖43)
Night portrait (📖41)	Fireworks show (📖43)
Party/indoor (📖41)	Black and white copy (📖43)
Beach (📖41)	Backlighting (📖44)
Snow (📖42)	Panorama assist (📖45)
Sunset (📖42)	Pet portrait (📖45)
Dusk/dawn (📖42)	

View a Description (Help Information) of Each Scene

Select the desired scene from the scene menu and rotate the zoom control (📖4) toward **T** (🔍) to view a description of that scene (help). To return to the original screen, rotate the zoom control toward **T** (🔍) again.





Changing Scene Mode Settings

- “Features That Can Be Set Using the Multi Selector” (📖60) vary with scene mode. See “List of the Default Settings” (📖69) for more information.
- See “Features That Can Be Set Using the Exposure Compensation Dial” for more information on exposure compensation (📖71).
- See “Features That Can Be Set with the Quick Menu” for more information on available quick menu (📖73).

Features That Cannot Be Used Simultaneously







This feature may not be used in combination with certain features (📖80).



Characteristics of Each Scene

- Use of a tripod is recommended in scenes with which  is indicated. Set **Vibration reduction** in the setup menu (104) to **Off** when using a tripod to stabilize the camera.
- For scene modes that use the flash, be sure to press the   (flash pop-up) button to raise the flash before shooting (7).

Scene auto selector



When you frame a picture, the camera automatically selects the optimum scene for simpler shooting.

: Portrait, : Landscape, : Night portrait, : Night landscape, : Close-up, : Backlighting, : Other scenes

- When the camera automatically selects a scene mode, the shooting mode icon changes to that for the scene mode currently enabled.
- The camera automatically selects the focus area for autofocus in accordance with the composition. The camera detects and focuses on faces (see “Using Face Detection” (85) for more information).
- Depending upon shooting conditions, the camera may not select the desired scene mode. Should this occur, switch to  (auto) mode (28) or select the optimum scene mode for the subject manually.
- The digital zoom is not available.

Portrait

Use this mode for portraits.

- The camera detects and focuses on a face (see “Using Face Detection” (85) for more information).
- After the skin softening feature makes the subject’s skin appear smoother, the camera records the image (86).
- If no faces are detected, the camera focuses on the subject at the center of the frame.
- The digital zoom is not available.



Landscape

Use this mode for vivid landscapes and cityscapes.

- When the shutter-release button is pressed halfway, the AF/access lamp always lights in green.



Sports

Use this mode when shooting sporting events. The camera captures a series of still images that allow you to clearly see detailed movements in a moving subject.



- The camera focuses at the center area of the frame.
- To capture a series of images, hold down the shutter-release button all the way. Up to 90 pictures are shot at a rate of about 1.2 frames per second (fps) (when image quality is set to **Normal** and image size is set to  **3648x2736**).
- The camera focuses the subject even when the shutter-release button is not pressed halfway. You may hear the sound of the camera focusing.
- Focus, exposure, and hue are fixed at the values determined with the first shot in each series.
- The frame rate with continuous shooting may vary depending upon the current image quality setting, image size setting, the memory card used, or shooting condition.



Night portrait



Use this mode for portraits taken at sunset or at night.

- The camera detects and focuses on a face (see "Using Face Detection" ( 85) for more information).
- After the skin softening feature makes facial skin tones softer, the camera records the image ( 86).
- If no faces are detected, the camera focuses on the subject at the center of the frame.
- Shoot pictures with the flash raised.
- The digital zoom is not available.



Party/indoor

Suitable for taking pictures in parties. Captures the effects of candlelight and other indoor background lighting.

- The camera focuses at the center area of the frame.
- When shooting in a dark location, hold the camera steadily to avoid the effects of camera shake. To take a picture with the camera attached to a tripod, set **Vibration reduction** in the setup menu ( 104) to **Off**.



Beach

Captures the brightness of such subjects as beaches or sunlit expanses of water.

- The camera focuses at the center area of the frame.



Scene Mode (Shooting Suited to Scenes)

Snow

Captures the brightness of sunlit snow.

- The camera focuses at the center area of the frame.



Sunset

Preserves the deep hues seen in sunsets and sunrises.

- The camera focuses at the center area of the frame.



Dusk/dawn

Preserves the colors seen in the weak natural light before sunrise or after sunset.

- When the shutter-release button is pressed halfway, the AF/access lamp always lights in green.



Night landscape









Slow shutter speeds are used to capture the atmosphere of a night landscape.

- When the shutter-release button is pressed halfway, the AF/access lamp always lights in green.



Close-up











Use this mode to photograph flowers, insects, and other small objects at close range.

- The focus mode ( 67) setting is changed to  (macro close-up) and the camera automatically zooms to the closest position to the subject where the camera can shoot.
- You can move the focus area that the camera focuses on. Press the  button and then rotate the multi selector or press , , , or  to move the focus area. To adjust the following settings, press the  button to temporarily cancel focus area selection, and then adjust each setting.
 - Flash mode or self-timer
- The camera focuses the subject even when the shutter-release button is not pressed halfway. You may hear the sound of the camera focusing.



Food

Use this mode when taking pictures of food.

- The focus mode (67) setting is changed to  (macro close-up) and the camera automatically zooms to the closest position to the subject where the camera can shoot.
- You can adjust the hue by pressing the multi selector  or . The hue adjustment setting is saved in the camera's memory even after the camera is turned off.
- You can move the focus area that the camera focuses on. Press the  button and then rotate the multi selector or press , , , or  to move the focus area. To adjust the following settings, press the  button to temporarily cancel focus area selection, and then adjust each setting.
 - Hue or self-timer
- The camera focuses the subject even when the shutter-release button is not pressed halfway. You may hear the sound of the camera focusing.

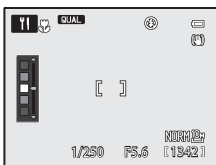

Museum

Use indoors where flash photography is prohibited (for example, in museums and art galleries) or in other settings in which you do not want to use the flash.

- The camera focuses at the center area of the frame.
- The camera captures up to ten images while the shutter-release button is pressed all the way, and the sharpest image in the series is automatically selected and saved (BSS (Best Shot Selector) (54)).



Fireworks show





Slow shutter speeds are used to capture the expanding burst of light from fireworks.

- The camera focuses at infinity.
- When the shutter-release button is pressed halfway, the AF/access lamp always lights in green.



Black and white copy

Provides clear images of text or drawings on a white board or in print.

- The camera focuses at the center area of the frame.
- When shooting nearby object, shoot with  (macro close-up) in the focus mode (67).

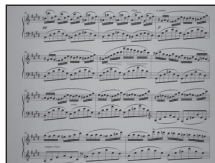



Backlighting

Use when light is coming from behind the subject, throwing features or details into shadow. **On** or **Off** can be selected in HDR (high dynamic range) composition on the screen that is displayed when  **Backlighting** scene mode is selected.

- **Off** (default setting): The flash fires to prevent the backlit subject from being hidden in shadow.
 - Shoot pictures with the flash raised.
 - The camera focuses at the center area of the frame.
 - Press the shutter-release button all the way to shoot a single picture.



- **On**: Use when shooting scenes with high contrast.
 - The **HDR** icon is displayed on the shooting screen. If there are very bright areas and very dark areas in the frame, the **HDR** icon lights in green.
 - The camera focuses at the center area of the frame.
 - When the shutter-release button is pressed all the way, the camera shoots pictures continuously and saves the following two images.
 - An image processed by D-Lighting (89) at the time of shooting
 - HDR composite image (loss of detail is reduced in highlights and shadows)
 - The second image saved is an HDR composite image. If only one image can be saved, an image processed by D-Lighting is the only image saved.
 - Once the shutter-release button is pressed all the way, hold the camera steady without moving it until a still picture is displayed. After taking a picture, do not turn the camera off before the monitor switches to the shooting screen.
 - Use of a tripod is recommended. Set **Vibration reduction** in the setup menu (104) to **Off** when using a tripod to stabilize the camera.
 - Smear (3) that occurs on the monitor after shooting will not be recorded with images.
 - The digital zoom is not available.



Panorama assist





Use this mode when shooting a series of pictures that can later be joined on a computer to form a single panorama.

- Press the multi selector ▲, ▼, ◀ or ▶ to select the direction in which pictures are to be joined and press the **OK** button.
- After shooting the first picture, shoot the necessary number of pictures while confirming the seams. To finish shooting, press the **OK** button.
- Transfer pictures to a computer and use the included **Panorama Maker 5** software (□92, 804) to join them in a single panorama. See “Using Panorama Assist” (803) for more information.

Pet portrait

Use this mode for shooting pictures of dogs or cats.

- Select **Single** or **Continuous** (three pictures are shot continuously).
 - **Single**: One picture is captured at a time.
 - **Continuous** (default setting): When the camera focuses on the detected face in **Pet portrait auto release** (default setting) mode, three pictures are shot continuously (frame rate with continuous shooting: approximately 1.2 frames per second when image quality is set to **Normal** and image size is set to  **3648x2736**). If pet portrait auto release is not used, up to 90 pictures are shot at a rate of about 1.2 frames per second while the shutter-release button is fully held down (when image quality is set to **Normal** and image size is set to  **3648x2736**).
- The camera detects and focuses on the face of a dog or cat. When the subject is in focus, the shutter is released automatically (Pet portrait auto release (default setting)).
- Up to five pet faces are detected simultaneously.
- If a pet's face is not detected, press the shutter-release button halfway to focus on the subject at the center of the frame.
- Press the multi selector ◀ (☺) to change the pet portrait auto release settings.
 - **Pet portrait auto release** (default setting): When the camera focuses on the detected face, the shutter is released automatically. When **Pet portrait auto release** is set, the  icon is displayed on the shooting screen.
 - **OFF**: Press the shutter-release button to release the shutter.
- In the following situations, **Pet portrait auto release** is automatically switched to **OFF**.
 - When pet portrait auto release is repeated five times
 - When remaining capacity of the internal memory or memory card is low
 To continue shooting with pet portrait auto release, press the multi selector ◀ (☺) to set again.
- The digital zoom is not available.
- Under some shooting conditions such as pet-to-camera distance, speed of moving pets, direction in which the pets are facing, and brightness of the faces, the camera may be unable to detect a dog or cat, or a border is displayed around something other than a dog or cat.



Special Effects Mode (Applying Effects When Shooting)

The effect can be applied to pictures during shooting. One of the 10 special effects is selected to shoot.

To select an effect, press the **MENU** button to display the special effects menu.

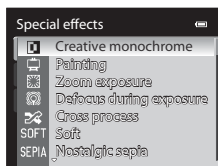
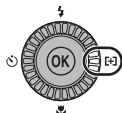
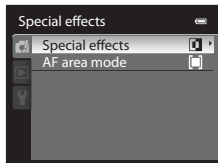
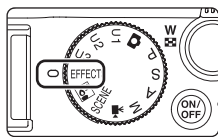

- Special effects can also be selected by rotating the sub-command dial while pressing the **Fn1** button in the shooting screen.
- The focus area for autofocus differs depending on the setting of **AF area mode** that can be selected in the  tab after pressing the **MENU** button.
- When **AF area mode** is set to **Auto** (default setting), the camera has nine focus areas, and automatically selects the focus areas containing the subject closest to the camera. When the subject is in focus, the focus area (active focus area) lights in green (maximum of nine areas).

Characteristics of Each Special Effect

Option	Description
Creative monochrome (default setting)	<p>Create monochrome photographs by adjusting the grainy feel and contrast. Also, the normal color image can be converted into black and white (solarization).</p> <ul style="list-style-type: none"> • Rotate the main command dial to adjust grainy feel. • Rotate the sub-command dial to adjust contrast.
Painting	Create images with the ambience of paintings.

Option	Description
Zoom exposure*	<p>When the shooting mode icon lights in green, create dynamic pictures radiated out from the center by zooming from W (wide-angle position) to T (telephoto zoom position) after the shutter is open and until it is closed.</p> <ul style="list-style-type: none"> • The zoom is fixed at W (wide-angle) end. • The shutter speed is fixed at one second. • Rotate the main command dial to switch zooming magnifications (2× or 3× (default setting)). • The desired shooting effect is not produced when the subject is bright and the shutter speed cannot be slowed.
Defocus during exposure*	<p>When the shooting mode icon lights in green, create pictures by varying focus slightly between the shutter-release button being pressed and the picture being shot.</p> <ul style="list-style-type: none"> • The desired shooting effect is not produced when the subject is bright and the shutter speed cannot be slowed.
Cross process	<p>Create images with an unusual hue by converting a positive color image into negative or negative color image into positive.</p> <ul style="list-style-type: none"> • Rotate the main command dial to select hue. • Rotate the sub-command dial to set peripheral light intensity to on or off.
Soft	Soften the image by adding a slight blur to the overall image.
Nostalgic sepia	Add a sepia tone and reduces the contrast to simulate the qualities of an old photograph.
High key	Give the overall image a bright tone.
Low key	Give the overall image a dark tone.
Selective color	<p>Create a black and white image in which only the specified color remains.</p> <ul style="list-style-type: none"> • Rotate the main command dial to select a color to be retained.

* Use of a tripod is recommended. **Vibration reduction** in the setup menu (📖104) is fixed at **Off**.



Changing Special Effects Mode Settings

- Features that can be set using the main command dial and sub-command dial differ depending on the special effects (📖47).
- Features that can be set using the multi selector (📖60) vary with special effects. See “List of the Default Settings” (📖69) for more information.
- See “Features That Can Be Set Using the Exposure Compensation Dial” for more information on exposure compensation (📖71).
- See “Features That Can Be Set with the Quick Menu” for more information on available quick menu (📖73).
- See “Options Available in the Special Effects Menu” (below) for more information on functions that can be set using the **MENU** button.

Options Available in the Special Effects Menu

In the special effects mode, the following option settings can be changed.

Select special effects mode → **MENU** button →  tab (📖13)

Option	Description	
AF area mode	Choose how the focus area is determined from Face priority, Auto (default setting), Manual, Center (spot), Center (normal) , or Center (wide) . <ul style="list-style-type: none"> • The AF area mode can also be selected by pressing the multi selector ► ([+]). 	 48

Features That Cannot Be Used Simultaneously

This feature may not be used in combination with certain features (📖80).

Changing Low Noise Night Mode Settings

- See “Features That Can Be Set Using the Multi Selector” (📖60) for more information on flash mode (📖61), self-timer (📖64)/smile timer (📖65)/remote control (📖60), focus mode (📖67) and AF area mode.
- See “Features That Can Be Set Using the Exposure Compensation Dial” for more information on exposure compensation (📖71).
- See “Features That Can Be Set with the Quick Menu” for more information on available quick menu (📖73).
- See “Options Available in the Low Noise Night Mode Menu” (below) for more information on functions that can be set using the **MENU** button.

Options Available in the Low Noise Night Mode Menu

In the low noise night mode, the following option settings can be changed.

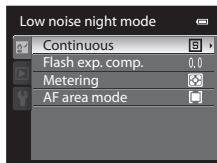

Select low noise night mode → **MENU** button → tab (📖13)

The settings of **Continuous**, **Flash exp. comp.** and **Metering** in low noise night menu are stored in the camera’s memory independently and is not applied to the settings in any other shooting mode. When the camera is turned off or switched to another shooting mode, **AF area mode** is reset to **Auto**.

Option	Description	
Continuous	Continuous shooting can be set. Choose Single or Continuous .	45
Flash exp. comp.	Adjust the flash output.	52
Metering	Choose how the camera meters the brightness of the subject. Determines the exposure (combination of shutter speed and aperture value) according to the measured brightness.	44
AF area mode	Set how the camera selects the AF area mode to Face priority , Auto (default setting), Manual , Center (spot) , Center (normal) , Center (wide) or Subject tracking . <ul style="list-style-type: none"> • The AF area mode can also be selected by pressing the multi selector (⊕). 	48

Features That Cannot Be Used Simultaneously

P, S, A, M Modes (Setting the Exposure for Shooting)

Pictures can be shot with greater control by setting the quick menu (📖73) or shooting menu (📖54) items in addition to setting the shutter speed or aperture value manually according to shooting conditions and requirements.

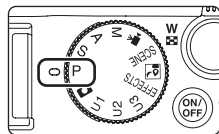

- The focus area for autofocus differs depending on the setting of **AF area mode** that can be selected in the **P, S, A** or **M** tab after pressing the **MENU** button.

When **AF area mode** is set to **Auto** (default setting), the camera has nine focus areas, and automatically selects the focus areas containing the subject closest to the camera. When the subject is in focus, the focus area (active focus area) lights in green (maximum of nine areas).

The procedure for shooting pictures at the desired brightness (exposure) by adjusting the shutter speed or aperture value is called “determine exposure”. The sense of dynamism and amount of background defocus in pictures to be shot vary depending on the combinations of shutter speed and aperture value even if the exposure is the same.

Rotate the command dial to set the shutter speed and aperture value.

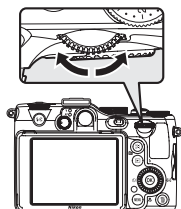

Main command dial

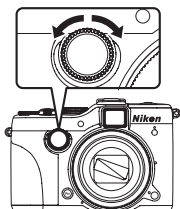

Sub-command dial

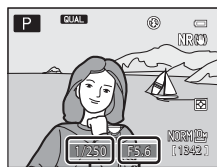

Shutter speed Aperture value

Exposure mode	Shutter speed (📖83)	Aperture value (📖52)
P Programmed auto (📖53)	Automatically adjusted (flexible program is enabled by the main command dial).	
S Shutter-priority auto (📖53)	Adjusted by the main command dial.	Automatically adjusted.
A Aperture-priority auto (📖53)	Automatically adjusted.	Adjusted by the sub-command dial.
M Manual (📖53)	Adjusted by the main command dial.	Adjusted by the sub-command dial.

Adjusting the Shutter Speed



Faster
1/1000 s



Slower
1/30 s

Adjusting the Aperture Value



Larger aperture
(Small f-number)
f/2.8



Smaller aperture
(Large f-number)
f/8

Aperture and zoom

The aperture value (f-number) indicates the lens brightness. Large apertures (expressed by small f-numbers) let more light into the camera, and small apertures (large f-numbers) let less light. The aperture value of this camera zoom lens can be changed depending on the zoom position. When zooming to the wide-angle position and telephoto zoom position, the aperture values are f/2.8 and f/5.6, respectively.

- When **Fixed aperture** (📖106) is set to **On**, zooming can be performed with minimum changes in the aperture value.

Built-in ND Filter

When the subject is too bright, set **Built-in ND filter** in the setup menu (📖104) to reduce the light and shoot.

U1, U2 or U3 (User Setting) Mode

Even when the mode dial is set to **U1**, **U2** or **U3** (user setting) mode, you can shoot in **P** (Programmed auto), **S** (Shutter-priority auto), **A** (Aperture-priority auto) or **M** (Manual). The setting combinations (user settings) that are frequently used for shooting can be saved in **U1**, **U2** and **U3** (📖58).

P (Programmed auto) (🔑5)

Use for automatic control of the exposure by the camera.

- Different combinations of shutter speed and aperture value can be selected without changing the exposure by rotating the main command dial ("flexible program"). While flexible program is in effect, a flexible program mark (**X**) is displayed next to the mode indicator (**P**) in the upper left of the monitor.
- To cancel flexible program, rotate the main command dial until the flexible program mark (**X**) is no longer displayed, or press the AE-L/AF-L button while pressing the **Fn1** button. Selecting another shooting mode, or turning off the camera, also cancels flexible program.

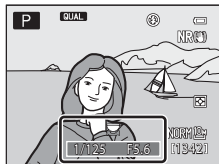

S (Shutter-priority auto) (🔑5)

Use to shoot fast moving subjects with a fast shutter speed, or use to emphasize the movements of a moving subject with a slow shutter speed.

- The shutter speed can be adjusted by rotating the main command dial.

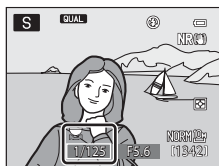

A (Aperture-priority auto) (🔑5)

Use to blur the background or bring both the foreground and background into focus.

- The aperture value can be adjusted by rotating the sub-command dial.

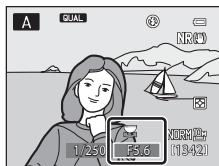

M (Manual) (🔑7)

Use to control the exposure according to shooting requirements.

- When adjusting the aperture value or shutter speed, the degree of deviation from the exposure value measured by the camera is displayed in the exposure indicator. The degree of deviation in the exposure indicator is displayed in EVs (-3 to +3 EV in increments of 1/3 EV).
- When the degree of deviation of the exposure value is below -2 EV or above +2 EV, the exposure indicator is displayed in red.
- The shutter speed can be adjusted by rotating the main command dial and the aperture value can be adjusted by rotating the sub-command dial.

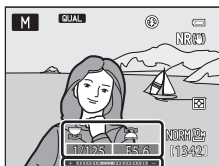

Exposure indicator

Changing P, S, A, M Modes

- See “Features That Can Be Set Using the Multi Selector” (📖60) for more information on flash mode (📖61), self-timer (📖64)/smile timer (📖65)/remote control (📖60) and focus mode (📖67), AF area mode.
- See “Features That Can Be Set Using the Exposure Compensation Dial” for more information on exposure compensation (📖71).
- See “Features That Can Be Set with the Quick Menu” for more information on available quick menu (📖73).
- See “Options Available in the Shooting Menu” (below) for more information on functions that can be set using the **MENU** button.





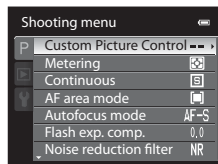



Options Available in the Shooting Menu

In the **P, S, A, M** mode, the following option settings can be changed.





Select **P, S, A, M** mode → **MENU** button → **P, S, A, M** tab (📖13)

Option	Description	📖
Custom Picture Control	Allow you to store the settings customized in COOLPIX Picture Controls, which can set picture editing options for recording images according to the shooting scene or your preferences.	🔑43
Metering	Select the method that the camera uses to measure the brightness of the subject. The camera adjusts the exposure, which is a combination of shutter speed and aperture value, based on the brightness measurement. The default setting is Matrix .	🔑44
Continuous	Select the mode used for taking a series of pictures from Single , Continuous , Continuous flash , BSS (📖43), Multi-shot 16 , and Intvl timer shooting . The default setting is Single (i.e., only one picture is captured at a time). Allow you to shoot up to 90 pictures at a rate of about 1.2 frames per second while Continuous is selected and the shutter-release button is fully held down (when image quality is set to Normal and image size is set to 📷 3648x2736).	🔑45

Option	Description	
AF area mode	Set how the camera selects the AF area mode to Face priority, Auto (default setting), Manual, Center (spot), Center (normal), Center (wide) or Subject tracking . • The AF area mode can also be selected by pressing the multi selector  (+).	 48
Autofocus mode	When Single AF (default setting) is selected, the camera focuses only while the shutter-release button is pressed halfway. When Full-time AF is selected, the camera focuses even when the shutter-release button is not pressed halfway. You may hear the sound of the camera focusing.	 52
Flash exp. comp.	Flash compensation is used to adjust the flash output, changing the brightness of the main subject relative to the background. The default setting is 0.0 .	 52
Noise reduction filter	Set the strength of the noise reduction function that is normally performed when recording the picture. The default setting is Normal .	 53
Long exposure NR	At slow shutter speeds, pictures may be affected by "noise" in the form of randomly-spaced, brightly-colored dots concentrated in dark parts of the image. Reduce noise at slow shutter speeds. The default setting is Auto .	 53
Distortion control	Choose whether to correct the peripheral distortion that occurs due to the intrinsic characteristics of lenses. Enabling distortion control reduces the size of the frame, as compared to when distortion control is not enabled. The default setting is Off .	 54
Wide-angle converter	Set the option to On when using the Wide-angle Converter WC-E75A (available separately). The default setting is None .	 54
Flash control	Set the built-in flash to off even when you are not using a Speedlight (external flash unit) attached to the camera's accessory shoe. The default setting is Auto .	 55
Active D-Lighting	Prevent loss of contrast details in highlights and shadows when shooting images. The default setting is Off .	 56

P, S, A, M Modes (Setting the Exposure for Shooting)

Option	Description	
Zoom memory	<p>When the zoom control is operated while pressing the Fn1 button, the camera changes in steps to the focal length (equivalent to 35mm [135] format of angle of view) of the zoom lens that is set in advance.</p> <ul style="list-style-type: none">• The default setting is on <input checked="" type="checkbox"/> for all the check boxes.	 57



Features That Cannot Be Used Simultaneously

U1, U2 and U3 (User Setting Modes)







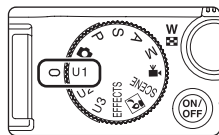



Up to three setting combinations that are frequently used for shooting (user settings) can be saved in **U1**, **U2** and **U3**. Shooting is possible in **P** (Programmed auto), **S** (Shutter-priority auto), **A** (Aperture-priority auto) or **M** (Manual).

Rotate the mode dial to **U1**, **U2** or **U3** to retrieve the settings saved in **Save user settings**.

- Frame the subject and shoot with these settings, or change the settings as required.
- The setting combinations that are retrieved when the mode dial is rotated to **U1**, **U2** or **U3** can be changed as many times as you want in **Save user settings**.
- See  58 for more information on the **Save user settings**.



Changing U1, U2 or U3 Mode Settings





- See “Features That Can Be Set Using the Multi Selector” ( 60) for more information on flash mode ( 61), self-timer ( 64)/smile timer ( 65)/remote control ( 60) and focus mode ( 67), AF area mode
- See “Features That Can Be Set Using the Exposure Compensation Dial” for more information on exposure compensation ( 71).
- See “Features That Can Be Set with the Quick Menu” for more information on available quick menu ( 73).
- See “Available Specialized Menu for **U1**, **U2** or **U3**” ( 58) and “Options Available in the Shooting Menu” ( 54) for more information on functions that can be set using the **MENU** button.

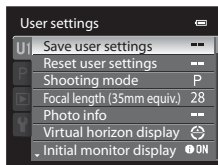

Available Specialized Menu for U1, U2 or U3

Following settings can be changed in U1, U2 or U3 mode.



Set to U1, U2 or U3 mode → MENU button → U1, U2 or U3 tab (📖13)

Option	Description	
Save user settings	The current settings are stored.	 58
Reset user settings	The settings saved to U1, U2 or U3 are reset.	 59
Shooting mode	Choose the standard shooting mode (default setting is P). The current flexible program (when set to P), shutter speed (when set to S or M) or aperture value (when set to A or M) settings are also saved.	29
Focal length (35mm equiv.)	Set the zoom position for when the mode dial is set. Choose 28 mm (default setting), 35 mm , 50 mm , 85 mm , 105 mm , 135 mm , 200 mm or Current zoom position .	-
Photo info	Set the information displayed on the monitor when the mode dial is set. This setting is not applied to the setup menu settings.	 74
Virtual horizon display	Set the virtual horizon display for when the mode dial is set. This setting is not applied to the setup menu settings.	 74
Initial monitor display	Set the information displayed on the monitor when the mode dial is set (default setting is Show info).	15
Flash mode	Set the flash mode for when the mode dial is set.	61
Focus	Set the focus mode for when the mode dial is set. The current focus distance is also saved when the focus mode is MF (manual focus).	67

Option	Description	
AF area mode	Set the AF area mode for when the mode dial is set. The current focus area position is saved when AF area mode is set to Manual .	 48
AF assist	Enable or disable the AF assist mode for when the mode dial is set. This setting is not applied to the setup menu settings.	 78

Features That Can Be Set Using the Multi Selector

Press the multi selector ▲ (⚡), ◀ (⌚), ▼ (👤), or ▶ (⊞) while shooting to operate the following functions.

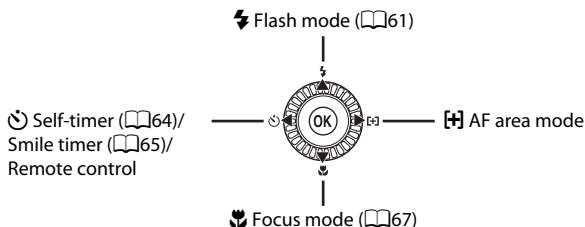

Available Functions

Available functions differ according to the shooting mode as follows.

- See “List of the Default Settings” (📖69) for more information on the default settings in each shooting mode.

Function	📷	SCENE	EFFECTS	📷	P, S, A, M, U1, U2, U3	📷
⚡ Flash mode (📖61)	✓	3	3	✓	✓	-
⌚ Self-timer (📖64)	✓			✓	-	
⌚ Smile timer (📖65)	✓			✓	-	
🔌 Remote control ¹	✓			✓	✓	
👤 Focus mode (📖67)	✓			✓	✓	
⊞ AF area mode ²	-			✓	-	

¹ Use the Remote Control ML-L3 (available separately) to release the shutter (📷105). It is convenient for taking self-portraits of group shots and effectively eliminating blur caused by camera shake that occurs when the shutter-release button is pressed.

² Set the method of how to change the focus area for autofocus (📖54). Set **Multi selector right press** to **Off** in the setup menu (📖104) if you do not want to display the selected focus area when the multi sector ▶ is pressed.

³ The setting varies with scene mode or special effects. See “List of the Default Settings” (📖69) for more information.

Using the Flash (Flash Modes)

You can shoot pictures with a flash by raising the built-in flash. You can set a flash mode that suits the shooting conditions.











1 Press the (flash pop-up) button to raise the flash (7).

- When the flash is lowered, the flash mode is fixed at  (off).

2 Press () on the multi selector.



3 Press the multi selector to select the desired mode and press the button.

- See “Available Flash Modes” (62) for more information.
- When the manual flash is selected, press  before pressing the  button and select the flash output.
- When  (slow sync) or  (rear-curtain sync) is selected for flash mode, the flash mode can be switched by pressing  before pressing the  button.
- If the  button is not pressed within a few seconds, the selection is set and the setting menu disappears.
- When  (auto) is applied,  is only displayed for a few seconds even if monitor indicators (15) are turned on.

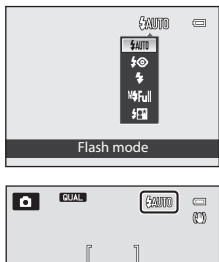

4 Frame the subject and take a picture.

- The flash lamp indicates the status of the flash when the shutter-release button is pressed halfway.
 - On: The flash will fire when you press the shutter-release button all the way.
 - Blinking: The flash is charging. The camera cannot take pictures.
 - Off: The flash will not fire when a picture is taken.
- If the battery is low, the monitor will be turned off while the flash is charging.

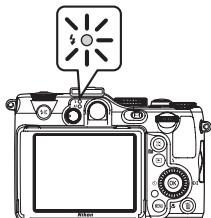

















Lowering the Flash

When not using the flash, gently push to lower the flash until it clicks shut (7).



Effective Range of the Built-in Flash

The built-in flash has a range of about 0.3 to 9.0 m (1 ft to 29 ft) for wide-angle position, and about 0.3 to 4.5 m (1 ft to 14 ft) for telephoto zoom position (when **ISO sensitivity** is set to **Auto**).

Available Flash Modes

-  AUTO Auto**
Flash fires automatically when lighting is dim.
-  Auto with red-eye reduction**
Best choice for portraits. Reduces red-eye effect caused by flash in portraits (📖63).
-  Off**
Flash does not fire.
 - Available when the scene mode is  (scene auto selector) or an optional Speedlight (external flash unit) is attached.
 - Use of a tripod is recommended to avoid the effects of camera shake when shooting in a dark location.
-  Fill flash**
The flash fires when a picture is taken, regardless of how bright the subject is. Use to “fill-in” (illuminate) shadows and backlit subjects.
-  Manual**
Flash is forcibly fired at the flash output that is set for the built-in flash.
 - Choose the flash output from ** Full** (full flash), ** 1/2**, ** 1/4**, ** 1/8**, ** 1/16**, ** 1/32** and ** 1/64**. For example, when ** 1/16** is chosen, the flash is 1/16 of the full flash.
 - Not available when a Speedlight flash unit (available separately) is attached.
-  Slow sync /  Rear-curtain sync**
 - Slow sync:
Fill flash is combined with a slow shutter speed.
Suitable for portraits of human subjects shot at night or under dim light. Flash illuminates main subject; slow shutter speeds are used to capture background.
 - Rear-curtain sync:
Fill flash fires just before the shutter closes, creating the effect of a stream of light behind moving subjects.

Flash Mode Setting

- The setting varies with shooting mode. See “Available Functions” (📖60) and “List of the Default Settings” (📖69) for more information.
- This feature may not be used in combination with certain features. See “Features That Cannot Be Used Simultaneously” (📖80).
- The changed flash mode setting applied in the following situations is saved in the camera’s memory even after the camera is turned off.
 - When shooting mode **P**, **S**, **A** or **M** is used
 - When  (auto with red-eye reduction) is selected in  (Auto) mode

Auto with Red-eye Reduction

This camera uses **advanced red-eye reduction (“In-Camera Red-Eye Fix”)**.

Pre-flashes are fired repeatedly at low intensity before the main flash, reducing the red-eye effect.

If the camera detects “red-eye” when a picture is taken, Nikon’s own In-Camera Red-Eye Fix processes the image before it is recorded.

Note the following when taking pictures:

- Because pre-flashes are fired, there is a slight lag between when the shutter-release button is pressed and when the picture is shot.
- The time required to save the picture increases slightly.
- Advanced red-eye reduction may not produce the desired results in some situations.
- In extremely rare instances, areas not subject to red-eye may be affected by advanced red-eye reduction processing. In these cases, choose another mode and try again.
- The red-eye reduction process when NRW (RAW) images (📖75) are recorded consists only of the pre-flashing before the main flash (including the JPEG image that is recorded at the same time).

When **Red-eye reduction** in the setup menu (📖104) is set to **Pre-flash off**, the shutter is released immediately when the shutter-release button is pressed all the way.

External Flash Unit

You can attach the following Nikon Speedlights on the camera’s accessory shoe (📖2) to take pictures.

- Speedlights SB-400, SB-600, SB-700, SB-800, SB-900
- Wireless Speedlight Commander SU-800

Using the Self-timer

The self-timer is suitable for taking group pictures and reducing the vibration when the shutter-release button is pressed.

When using the self-timer, use of a tripod is recommended. Set **Vibration reduction** in the setup menu (📖104) to **Off** when using a tripod to stabilize the camera.

1 Press ◀ (🕒 self-timer) on the multi selector.

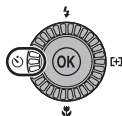

2 Use the multi selector to select 🕒 10s (or 🕒 2s) and press the OK button.

- To change the time for self-timer, press ▶ before pressing the OK button.
- 🕒 10s (ten seconds): suitable for group pictures.
- 🕒 2s (two seconds): suitable for preventing camera shake.
- When the shooting mode is set to **Pet portrait** in scene mode, 📷 (pet portrait auto release) is displayed (📖45). The self-timer 🕒 10s and 🕒 2s are not available.
- The mode selected for the self-timer is displayed.
- If the OK button is not pressed within a few seconds, the selection is set and the setting menu disappears.

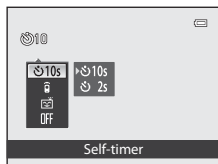

3 Frame the picture and press the shutter-release button halfway.

- Set the focus and exposure.

4 Press the shutter-release button all the way.

- The self-timer starts, and the number of seconds remaining before the shutter is released is displayed. The self-timer lamp blinks while the timer is counting down. About one second before the shutter is released, the lamp stops blinking and remains lit.
- When the shutter is released, the self-timer turns **OFF**.
- To stop the timer before a picture is taken, press the shutter-release button again.

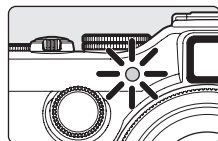
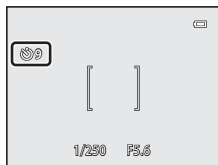

More Information

See "Self-timer: after release" (📖104) for more information.

Smile Timer (Shooting Smiling Faces)

When this mode is selected, the camera detects smiling faces and automatically releases the shutter even if you don't press the shutter-release button.

- This function can be used when the shooting mode is (auto), **P**, **S**, **A**, **M**, **U1**, **U2**, **U3**, (low noise night), scene mode **Portrait** or **Night portrait**.

1 Press (self-timer) on the multi selector.

- Change any flash mode, exposure, or shooting menu settings before pressing the button.

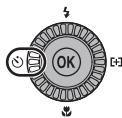

2 Use the multi selector to choose (smile timer), and press the .

- If the button is not pressed within a few seconds, the selection is set and the setting menu disappears.

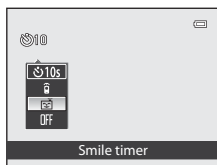

3 Frame the picture and wait for the subject to smile without pressing the shutter-release button.



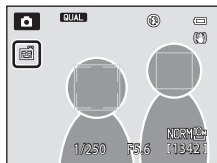



- When the camera detects a face, a yellow double border (focus area) is displayed around that face. When the camera has focused on that face, the double border will turn green for a moment and focus is locked.
- Up to three faces are detected. When more than one face is detected, the face closest to the center of the frame is framed by a double border and the others by single borders.
- If the camera detects that the face framed by the double border is smiling, the shutter is automatically released.
- Each time the shutter is released, automatic shooting using face detection and smile detection is repeated.



4 Shooting ends.

- To cancel smile detection and stop shooting, return to step 1 and select **OFF**.

Notes on Smile Timer

- The digital zoom is not available.
- When the smile timer is selected, the monitor is not turned off even when the  button is pressed (15).
- Under some shooting conditions, faces and smiling faces may not be detected properly.
- See “Viewing Pictures Taken Using Face Detection” (85) for more information.
- The smile timer cannot be used simultaneously with certain shooting modes. See “Available Functions” (60) and “List of the Default Settings” (69) for more information.
- This feature may not be used in combination with certain features. See “Features That Cannot Be Used Simultaneously” (80) for more information.

When the Self-timer Lamp Blinks

When the camera detects a face, the self-timer lamp blinks. The lamp flickers immediately after the shutter is released.

Releasing the Shutter Manually

The shutter can also be released by pressing the shutter-release button. If no faces are detected, the camera focuses on the subject at the center of the frame.

More Information

See “Autofocus” (33) for more information.

Using Focus Mode

Choose a focus mode according to the desired scene.

- 1 Press  focus mode) on the multi selector.

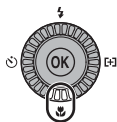

- 2 Use the multi selector to choose the desired focus mode and press the  button.

- See “Available Focus Modes” (📖68) for more information.
- If the  button is not pressed within a few seconds, the selection is set and the setting menu disappears.
- When **AF** (autofocus) is applied, **AF** is only displayed for a few seconds even if monitor indicators (📖15) are turned on.

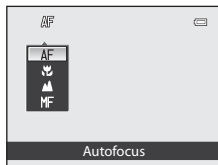

Available Focus Modes



AF Autofocus

The camera automatically adjusts the focus according to the distance to the subject. Use when the distance from the subject to the lens is 50 cm (1 ft 8 in.) or more, or 80 cm (2 ft 8 in.) or more at the maximum telephoto zoom position.

Macro close-up

Use for close-ups of flowers or small objects.

How close you can be to the subject while shooting depends on the zoom ratio.

When the zoom ratio is set to a position where  and the zoom indicator light in green, the camera can focus on subjects as close as 7 cm (2.8 in.) from the lens. At the maximum wide-angle zoom position (the zoom position ) , the camera can focus on subjects as close as 2 cm (0.8 in.) from the lens.

Infinity

Use when shooting distant scenes through window glass or when shooting landscapes. When the shutter-release button is pressed halfway, the AF/access lamp always lights in green. However, the camera may not be able to focus on nearby objects. The flash mode is set to  (off).

MF Manual focus

The focus can be adjusted for any subject that is a distance of 2 cm (0.8 in.) to infinity from the lens (2). The closest distance at which the camera can focus varies depending on the zoom position.

- This function can be used when the shooting mode is **P, S, A, M, U1, U2, U3**,  (low noise night), special effects mode or scene mode **Sports**.

Note on Shooting with the Flash

When shooting with  (macro close-up), the flash may be unable to light the entire subject at distances of less than 30 cm (1 ft).

Focus Mode Setting

- The setting varies with the shooting mode. See “Available Functions” (□□60) and “List of the Default Settings” (□□69) for more information.
- This feature may not be used in combination with certain features. See “Features That Cannot Be Used Simultaneously” (□□80) for more information.
- For shooting modes **P, S, A** and **M**, the changed focus mode setting is saved in the camera’s memory even after the camera is turned off.



Macro Close-up

When using **P, S, A, M, U1, U2** or **U3** mode if **Autofocus mode** in the shooting menu (□□54) is set to **Full-time AF**, or when using  (movie) mode if **Autofocus mode** in the movie menu (□□101) is set to **Full-time AF**, the camera will adjust focus even if the shutter-release button is not pressed halfway.

When using other shooting modes, **Full-time AF** is turned on automatically when macro mode is turned on.

You may hear the sound of the camera focusing.













Infinity



If you set focus mode to infinity while using  (auto) mode, **P, S, A, M, U1, U2** or **U3** mode,  (low noise night) mode or special effects mode, the focus area is not displayed on the screen.

List of the Default Settings

The default settings in each shooting mode are described below.

- Similar information about scene mode can be found on the next page.

Shooting mode	Flash mode ¹ (☰61)	Self-timer (☰64)	Focus mode (☰67)	AF area mode (☰55)
 (auto) (☰38)	 AUTO	OFF	AF ²	–
EFFECTS (special effects) (☰46)	 AUTO ³	OFF ⁴	AF	 ⁵
 (low noise night) (☰49)	 AUTO	OFF	AF	
P, S, A, M (☰51)	 AUTO	OFF	AF	
U1, U2, U3 (user setting) (☰57)	 AUTO	OFF	AF	
 (movie) (☰98)	 ⁶	OFF ⁷	AF ²	–

¹ When the flash is lowered, the flash mode is fixed at  (off). When using the built-in flash,  (off) cannot be selected. When using a flash unit (available separately),  (manual) cannot be selected.

² **AF** (autofocus),  (macro close-up) or  (infinity) can be selected.

³ The flash is fixed at  (off) when in **Painting** or **Zoom exposure**.

When **Defocus during exposure** is selected,  (off) or  (slow sync) can be selected.

⁴ Smile timer cannot be selected.

⁵  (subject tracking) cannot be selected.

The AF area mode is fixed at **Center (normal)**, when **Zoom exposure** is selected.

































































⁶ The setting cannot be changed.

⁷ Quick-response remote can be selected

- The setting applied in shooting modes **P**, **S**, **A** and **M** is saved in the camera's memory even after the camera is turned off (except for self-timer).

Features That Can Be Set Using the Multi Selector

Default settings in scene mode are described below.

	Flash mode ( 61)	Self-timer ( 64)	Focus mode ( 67)	AF area mode ( 55)
 ( 40)	 AUTO ¹	OFF ²	AF ³	–
 ( 40)		OFF	AF ³	–
 ( 40)	 ³	OFF ²	 ³	–
 ( 41)	 ³	OFF ³	AF ⁴	–
 ( 41)	 ⁵	OFF	AF ³	–
 ( 41)	 ⁶	OFF ²	AF ³	–
 ( 41)	AUTO	OFF ²	AF ³	–
 ( 42)	AUTO	OFF ²	AF ³	–
 ( 42)	 ³	OFF ²	AF ³	–
 ( 42)	 ³	OFF ²	 ³	–
 ( 42)	 ³	OFF ²	 ³	–
 ( 42)	AUTO	OFF ²	 ³	–
 ( 43)	 ³	OFF ²	 ³	–
 ( 43)	 ³	OFF ²	AF ⁷	–
 ( 43)	 ³	OFF ⁸	 ³	–
 ( 43)	AUTO	OFF ²	AF ⁷	–
 ( 44)	  ⁹	OFF ²	AF ³	–
 ( 45)	AUTO	OFF ²	AF ¹⁰	–
 ( 45)	 ³	 ¹¹	AF ⁷	–

¹ **AUTO** (auto) and  (off) can be selected. When **AUTO** (auto) is selected, the camera automatically selects the flash mode appropriate for the scene it has selected.

² Self-timer or remote control can be selected.

³ The setting cannot be changed.

⁴ **AF** (autofocus) or **MF** (manual focus) can be selected.

⁵ The setting cannot be changed. The flash mode setting is fixed at fill flash with slow sync and red-eye reduction.



⁶ May switch to slow sync with red-eye reduction flash mode.

⁷ **AF** (autofocus) or  (macro close-up) can be selected.

⁸ Quick-response remote can be selected.

⁹ When **HDR** is set to **Off**, the flash mode is fixed at  (fill flash).

When **HDR** is set to **On**, the flash mode is fixed at  (off).

¹⁰ **AF** (autofocus),  (macro close-up) or  (infinity) can be selected.

¹¹ The self-timer is not available. Pet portrait auto release (45) can be set to on or off.

Features That Cannot Be Used Simultaneously

This feature may not be used in combination with certain features (80).

Features That Can Be Set Using the Exposure Compensation Dial

Adjusting Brightness (Exposure Compensation)

When exposure compensation is set for shooting, the brightness of the overall image can be adjusted to make it brighter or darker.

1 Select the compensation value by rotating the exposure compensation dial.

- To make the subject brighter: adjust the exposure compensation value to the “+” side.
- To make the subject darker: adjust the exposure compensation value to the “-” side.
- When set to a value other than **0.0**, the  mark and compensation value are displayed on the monitor and the exposure compensation dial mark turns on when shooting.

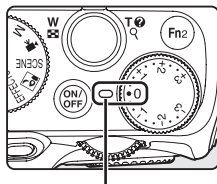

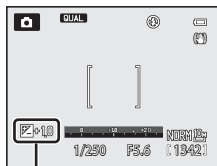

Exposure compensation dial mark



Exposure compensation value

2 Press the shutter-release button to take a picture.

Exposure Compensation Value

- When the shooting mode is the **Fireworks show** scene mode (43) or **M** (manual) mode (7), the exposure compensation cannot be used.
- When recording a movie, the compensation value is not adjusted even when the exposure compensation dial is rotated.

Features That Can Be Set with the Quick Menu

When the quick menu dial is rotated while shooting, the quick menu is displayed for the function that is selected with the mark. When the quick menu is displayed, the quick menu dial mark turns on.

- The quick menu is also displayed by pressing the quick menu button.
- To exit the quick menu, press the quick menu button or the shutter-release button.

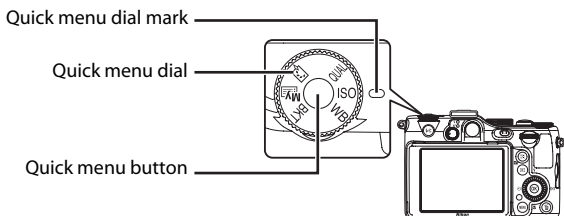













Available functions differ according to the shooting mode.

Dial position	Function		P, S, A, M, U1, U2, U3	SCENE	EFFECTS		
QUAL	Image quality/Image size (73)	✓	✓	✓	✓	✓	-
	Movie options (73)	-	-	-	-	-	✓
ISO	ISO sensitivity (73)	-	✓	-	-	-	-
WB	White balance (73)	-	✓	-	-	✓	✓
BKT	Auto bracketing (73)	-	✓	-	-	-	-
	My Menu (73)	-	✓	-	-	-	-
	Picture Control (73)	-	✓	-	-	-	-

Features That Cannot Be Used Simultaneously

This feature may not be used in combination with certain features (80).

Available Quick Menu

Option	Description	
QUAL Image quality/ Image size	Set the image quality (compression ratio) and image size to be recorded ( 74). The default setting of image quality is Normal , and of image size is  3648x2736 . This setting is also applied to other shooting modes (except for low noise night mode and shooting modes U1 , U2 and U3).	74
QUAL Movie options	Set the desired type of movie. The default setting is  HD 720p (1280x720) .	 42
ISO ISO sensitivity	Higher ISO sensitivity allows you to take pictures of darker subjects. Additionally, even with subjects of similar brightness, pictures can be taken at faster shutter speeds, and blurring caused by camera shake and subject movement can be reduced. When ISO sensitivity is set to Auto (default setting), the camera sets the ISO sensitivity automatically. <ul style="list-style-type: none"> In M (manual) mode, ISO sensitivity is fixed at ISO 100 if Auto, High ISO sensitivity auto, ISO 100-200 or ISO 100-400 is selected. 	 30
WB White balance	Adjust colors in the image closer to the colors as they appear to the eye. Although Auto (normal) (default setting) can be used under most types of lighting, you can apply the white balance setting suited to the sky conditions or light source to achieve better results if the default setting results are unsatisfactory. <ul style="list-style-type: none"> The preset value for preset manual applies commonly to P, S, A, M, U1, U2 and U3 shooting modes, low noise night mode, and movie mode. 	 32
BKT Auto bracketing	Continuous shooting can be performed while changing the exposure (brightness) automatically with the shutter speed (Tv) or ISO sensitivity (Sv), or multiple images can be recorded while varying the white balance (WB). The default setting is OFF .	 36
 My Menu	Display only the menu items that are frequently used for shooting. <ul style="list-style-type: none"> Options that are displayed in My Menu can be changed from Customize My Menu in the setup menu (104). 	 90
 Picture Control	Change the settings for image recording according to the shooting scene or your preferences. The default setting is Standard .	 38

Changing the Image Quality and Image Size

Display the shooting screen → QUAL (Quick menu dial) (📖72) → Image quality/Image size

The image quality (compression ratio) and image size can be selected for recording.

1 Choose the type of image quality (📖75) by pressing the multi selector ◀ or ▶.

- Items can also be chosen by rotating the main command dial.
- To change the image quality only, choose the type of image quality, and then press the quick menu button.
- To continue and change the image size, press the multi selector ▼.

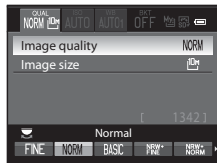

2 Choose the type of image size (📖77).

- **Image size** cannot be selected when **NRW (RAW)** is selected for **Image quality**.
- The number of exposures remaining for the selected image size is displayed.
- Press the multi selector ▲ to return to the image quality setting.

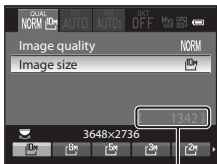

Numbers of exposures remaining

3 After completing the settings, press the quick menu button or the OK button.

- The monitor display reverts to shooting screen.



Available Image Quality

Lower compression ratios result in higher quality pictures, but also larger file sizes, limiting the number of pictures that can be recorded.

Option		Description
FINE	Fine	Fine image quality than Normal , suitable for enlargement or high quality prints. File format: JPEG, compression ratio of about 1:4
NORM	Normal (default setting)	Normal image quality, suitable for most applications. File format: JPEG, compression ratio of about 1:8
BASIC	Basic	Basic image quality is lower than with Normal , suitable for pictures attached to e-mails or used on web pages. File format: JPEG, compression ratio of about 1:16
NRW+ FINE	NRW (RAW) + Fine*	Two images are recorded at the same time: one NRW (RAW) image and one fine-quality JPEG image.
NRW+ NORM	NRW (RAW) + Normal*	Two images are recorded at the same time: one NRW (RAW) image and one normal-quality JPEG image.
NRW+ BASIC	NRW (RAW) + Basic*	Two images are recorded at the same time: one NRW (RAW) image and one basic-quality JPEG image.
NRW	NRW (RAW)*	Raw data from the image sensor are saved. Create JPEG image files after shooting using NRW (RAW) processing in the playback menu (□89). <ul style="list-style-type: none"> When NRW (RAW) is selected, Image size is reset to  3648x2736. File format: NRW (RAW)

* NRW (RAW) images cannot be chosen in scene mode, special effects mode (except for **Zoom exposure** and **Defocus during exposure**) or low noise night mode.

COOLPIX P7100 NRW (RAW) Images

- The extension of the picture taken is “.NRW.”
- NRW (RAW) images cannot be printed. Creating JPEG images with **NRW (RAW) processing** enables the images to be printed using PictBridge compatible printers or in digital photo labs.
- No editing other than NRW (RAW) processing can be performed for images in the NRW (RAW) format. To edit such images, first create JPEG images using **NRW (RAW) processing** (17), and then edit the JPEG images.
- ViewNX 2 needs to be installed on the computer to be able to view NRW (RAW) images on the computer. Capture NX 2 is also compatible with NRW (RAW) images.
- Install ViewNX 2 on a computer using the included ViewNX 2 CD-ROM. (See “Using ViewNX 2” (92).)

For more information on using ViewNX 2, refer to the on-screen instructions and help information contained in ViewNX 2.



Image Quality Setting

- The setting for image quality is shown by an icon displayed on the monitor during shooting and playback (8 to 10).
- The setting is also applied to other shooting modes (except for shooting modes **U1**, **U2** and **U3**).
- NRW (RAW) images cannot be recorded in the following shooting modes.
 - Scene mode
 - Special effect mode (except for **Zoom exposure** and **Defocus during exposure**)
 - Low noise night mode



When the mode is changed to scene mode or special effect mode (except for **Zoom exposure** and **Defocus during exposure**) from other shooting modes, the image quality is changed according to situation as follows.

- When **NRW (RAW)** is set, the image quality is changed to **Normal**.
- When **NRW (RAW) + Fine**, **NRW (RAW) + Normal** or **NRW (RAW) + Basic** is set, the image quality is changed to **Fine**, **Normal** or **Basic**, respectively.
- The digital zoom cannot be used when **Image quality** is set to **NRW (RAW)**, **NRW (RAW) + Fine**, **NRW (RAW) + Normal** or **NRW (RAW) + Basic**.
- This feature may not be used in combination with certain features. See “Features That Cannot Be Used Simultaneously” (80) for more information.

Recording of NRW (RAW) and JPEG Images at the Same Time

- The NRW (RAW) image and the JPEG image that are recorded at the same time have the same file number but their own file extensions, “.NRW” and “.JPG” (99).
- When playing back on the camera, only the JPEG image is displayed.
- Note that when the JPEG image is deleted by pressing the  button, the NRW (RAW) image that was recorded at the same time is also deleted.

More Information

















- See “Number of Exposures Remaining” (78) for more information.
- See “File and Folder Names” (99) for more information.

Available Image Size

You can set the JPEG image size (amount of pixels) for pictures recorded with an image quality of **Fine**, **Normal** or **Basic**.

The larger the image, the larger the size at which it can be printed or displayed without becoming noticeably “grainy,” limiting the number of pictures that can be recorded.





Conversely, small image sizes are suitable for pictures attached to e-mails or used on web pages. However, printing small images in large print sizes results in the image turning “grainy.”

Options*	Description
 3648×2736 (default setting)	Record pictures with finer detail than those shot at  3264×2448 or  2592×1944 .
 3264×2448	Good balance between file size and quality; suitable in most situations.
 2592×1944	
 2048×1536	Smaller than  3648×2736 ,  3264×2448 and  2592×1944 ; for recording more pictures.
 1600×1200	
 1280×960	
 1024×768	Record pictures of a size suitable for display on devices such as a computer monitor.
 640×480	Record pictures suitable for display on a television with a screen aspect ratio of 4:3, or for e-mail attachment.
 3648×2432	Record pictures with the same aspect ratio (3:2) as those shot with 35mm [135] format film cameras.
 3584×2016	Record pictures with the same aspect ratio (16:9) as wide screen TV.
 2736×2736	Record square pictures.

* The total number of pixels captured, and the number of pixels captured horizontally and vertically.











Example:  **3648×2736** = 10 megapixels, 3648×2736 pixels

Image Size Setting

- The setting for the image size is shown by an icon displayed on the monitor during shooting and playback (□8 to 10).
- The setting is also applied to other shooting modes (except for low noise night mode, and shooting modes **U1**, **U2** and **U3**).
- In low noise night mode, the available image size is  **2048×1536** or smaller.
- The size of JPEG images can be chosen when you create JPEG images from NRW (RAW) images using **NRW (RAW) processing** (☉17) (up to a maximum of 3648 × 2736 pixels).
- **Image size** for the JPEG image can be set when **NRW (RAW) + Fine**, **NRW (RAW) + Normal** or **NRW (RAW) + Basic** is selected. However, note that  **3648×2432**,  **3584×2016** and  **2736×2736** cannot be selected.
- This feature may not be used in combination with certain features. See “Features That Cannot Be Used Simultaneously” (□80) for more information.

Number of Exposures Remaining

The following table lists the approximate number of pictures that can be stored in the internal memory and on a 4 GB memory card, at each combination of **Image size** (□□77) and **Image quality** (□□75) settings. Note that the number of exposures that can be stored differs depending on the composition of the image (due to JPEG compression). In addition, this number may differ depending on the make of memory card, even if the capacity of the memory card is the same.

Image size	Image quality	Internal memory (94 MB)	Memory card ¹ (4 GB)	Print size ² (cm/in.)
 3648×2736 (default setting)	Fine	19	770	31 × 23/12 × 9 ³
	Normal	38	1,540	
	Basic	75	3,010	
	NRW (RAW)	5	230	
 3264×2448	Fine	24	970	28 × 21/11 × 8
	Normal	48	1,910	
	Basic	93	3,650	
 2592×1944	Fine	38	1,520	22 × 16/8.5 × 6.5
	Normal	74	2,940	
	Basic	140	5,480	
 2048×1536	Fine	60	2,410	17 × 13/7 × 5
	Normal	116	4,640	
	Basic	216	8,620	
 1600×1200	Fine	96	3,770	14 × 10/5 × 4
	Normal	183	7,100	
	Basic	319	12,000	
 1280×960	Fine	144	5,740	11 × 8/4 × 3
	Normal	263	10,000	
	Basic	433	17,200	
 1024×768	Fine	216	8,620	9 × 7/3.5 × 2.5
	Normal	378	15,000	
	Basic	606	24,100	
 640×480	Fine	433	17,200	5 × 4/2 × 1.5
	Normal	673	24,100	
	Basic	866	30,100	
 3648×2432	Fine	22	870	31 × 21/12 × 8
	Normal	43	1,720	
	Basic	84	3,350	
 3584×2016	Fine	26	1,060	30 × 17/12 × 6.5
	Normal	53	2,110	
	Basic	102	4,020	
 2736×2736	Fine	26	1,030	23 × 23/9 × 9
	Normal	51	2,040	
	Basic	99	3,890	

- 1 If the number of exposures remaining is 10,000 or more, "9999" is displayed.
- 2 The print size at an output resolution of 300 dpi.
Print sizes are calculated by dividing the number of pixels by the printer resolution (dpi) and multiplying by 2.54 cm (1 in.). However, even with the same image size setting, images printed at higher resolutions print smaller than the size indicated, and those printed at lower resolutions print larger than the size indicated.
- 3 The print size of NRW (RAW) images differs according to the image size of the NRW (RAW) processed images (🔧17).

Printing Images of Size 1:1



























Change the printer setting to "Border" when printing images with the size set to 1:1.

The images may not be printed in 1:1 ratio depending on the printer.

See the instruction manual of the printer or check with the authorized print dealer for further details.

















Features That Cannot Be Used Simultaneously

Some shooting settings cannot be used in combination with other functions.

Restricted function	Setting	Description
Flash mode	Focus mode ( 67)	When  (infinity) is selected for shooting, the flash is not available.
	Continuous ( 54)	<ul style="list-style-type: none"> When BSS or Multi-shot 16 is selected for shooting, the flash is not available. When continuous is selected for shooting, the built-in flash is not available (84). The built-in flash is fixed at  (fill flash) when Continuous flash is selected for shooting. The Speedlight (external flash unit) cannot be used (84).
	Auto bracketing ( 73)	The built-in flash is not available.
	Wide-angle converter ( 55)	The flash is not available when On is set for shooting.
	Flash control ( 55)	When Flash control is set to Built-in off ,  (auto with red-eye reduction),  (manual),  (slow sync) and  (rear-curtain sync) flash modes cannot be selected.
Self-timer/Smile timer/Remote control	AF area mode ( 55)	When Subject tracking is selected for shooting, the self-timer/smile timer/remote control are not available.
Focus mode	Smile timer ( 65)	When shooting with the smile timer, the mode is changed to AF (autofocus).
	Continuous ( 54)	 (infinity) cannot be used when Continuous flash is set for shooting.
	AF area mode ( 55)	When Subject tracking is selected for shooting, MF (manual focus) is not available.
Image quality	Continuous ( 54)	When Multi-shot 16 is selected for shooting, Image quality is fixed at Normal .
Image size	Image quality ( 75)	<ul style="list-style-type: none"> Image size is fixed at  3648×2736 when NRW (RAW) is selected for Image quality. Image size for a JPEG image can be set when NRW (RAW) + Fine, NRW (RAW) + Normal or NRW (RAW) + Basic is selected. However,  3648×2432,  3584×2016 and  2736×2736 cannot be selected.
	Continuous ( 54)	Image size is fixed at  (2560×1920 pixels) when Multi-shot 16 is selected for shooting.
ISO sensitivity	Continuous ( 54)	When shooting in Multi-shot 16 , ISO sensitivity is set automatically according to the brightness when shooting mode P , S or A is used. The setting for ISO sensitivity is fixed at 400 for shooting mode M .

Restricted function	Setting	Description
White balance	Picture Control (73)	White balance is fixed at Auto (normal) when Monochrome is selected for shooting.
	Wide-angle converter (55)	When On is selected for shooting, Preset manual is not available.
Picture Control	Active D-Lighting (55)	When using Active D-Lighting for shooting, Contrast in manual adjustment cannot be adjusted.
Metering	AF area mode (55)	<ul style="list-style-type: none"> When AF area mode is set to Auto, Center (spot), Center (normal) or Center (wide) while Metering is set to Spot AF area, the Metering setting automatically changes to Matrix. When AF area mode is set to Subject tracking while Metering is set to Spot or Spot AF area the Metering setting automatically changes to Matrix.
	Active D-Lighting (55)	Metering is reset to Matrix when Active D-Lighting is set to any mode other than Off .
Continuous/ Auto bracketing	Continuous (54)/Auto bracketing (73)	Continuous and auto bracketing are not available simultaneously. Auto bracketing is reset to OFF when Continuous is set to any mode other than Single . The setting for Continuous is reset to Single when Auto bracketing is set to any mode other than OFF .
	Self-timer (64)/Smile timer (65)/Remote control (60)	<ul style="list-style-type: none"> Continuous and the self-timer/remote control are not available simultaneously. Continuous or auto bracketing and smile timer are not available simultaneously.
	Image quality (75)	BSS, Multi-shot 16 or White balance bracketing cannot be used when Image quality is set to NRW (RAW), NRW (RAW) + Fine, NRW (RAW) + Normal or NRW (RAW) + Basic .
	Picture Control (73)	White balance bracketing cannot be used when Monochrome is selected for shooting.
	Long exposure NR (55)	When On is selected for Long exposure NR, Multi-shot 16 is not available.
	Wide-angle converter (55)	Continuous flash cannot be used when On is set for shooting.

Features That Cannot Be Used Simultaneously

Restricted function	Setting	Description
AF area mode	Focus mode ( 67)	<ul style="list-style-type: none"> When a setting other than Subject tracking is selected and  (infinity) is selected as the focus mode for shooting, the camera focuses at infinity regardless of the applied AF area mode option. When set to MF (manual focus), the AF area mode cannot be set.
	Picture Control ( 73)	When Picture Control is set to Monochrome while AF area mode is set to Subject tracking , the AF area mode setting automatically changes to Auto .
Long exposure NR	Continuous ( 54)	When Multi-shot 16 is selected for shooting, the Long exposure NR is not available.
Active D-Lighting	ISO sensitivity ( 73)	When ISO sensitivity is set to High ISO sensitivity auto, 3200 or Hi 1 , Active D-Lighting is not available. When High ISO sensitivity auto, 3200 or Hi 1 is selected, Active D-Lighting is reset to Off .
Print date	Image quality ( 75)	Print date is not available when Image quality is set to NRW (RAW) , NRW (RAW) + Fine , NRW (RAW) + Normal or NRW (RAW) + Basic .
	Continuous ( 54)	When Continuous , Continuous flash or BSS is selected for shooting, print date is not available.
	Auto bracketing ( 73)	Print date is not available.
Photo info	Smile timer ( 65)	The virtual horizon is not displayed when shooting with the smile timer.
	AF area mode ( 55)	<ul style="list-style-type: none"> The virtual horizon is not displayed when shooting with Face priority. The virtual horizon is not displayed when shooting with Subject tracking. After the subject has been registered (during subject tracking), the histogram and framing grid are not displayed.
Motion detection	Smile timer ( 65)	Motion detection is disabled when shooting with the smile timer.
	AF area mode ( 55)	Motion detection is disabled when shooting with Subject tracking .
Sound settings	Continuous ( 54)	Shutter sound is disabled when Continuous , Continuous flash , BSS , or Multi-shot 16 is selected in the shooting menu.
	Auto bracketing ( 73)	Shutter sound is disabled.
Blink warning	Smile timer ( 65)/ Continuous ( 54)/Auto bracketing ( 73)	Blink warning does not take effect when using the smile timer, Continuous is set to a setting other than Single , or auto bracketing is set.

Restricted function	Setting	Description
Digital zoom	Smile timer (65)	The digital zoom cannot be used when shooting with the smile timer.
	Focus mode (67)	The digital zoom cannot be used when MF (manual focus) is selected.
	Image quality (75)	The digital zoom cannot be used when Image quality is set to NRW (RAW) , NRW (RAW) + Fine , NRW (RAW) + Normal or NRW (RAW) + Basic .
	Continuous (54)	The digital zoom cannot be used when Multi-shot 16 is selected for shooting.
	AF area mode (55)	The digital zoom cannot be used when shooting with Subject tracking .
	Wide-angle converter (55)	The digital zoom cannot be used when On is selected for shooting.

The Control Range of the Shutter Speed (P, S, A, M Modes)

The control range of the shutter speed differs depending on the ISO sensitivity setting. Additionally, the control range changes in the following continuous shooting settings.

	Setting	Control range
ISO sensitivity (73) ¹	Auto ² , ISO 100-200 ² , ISO 100-400 ² , ISO 100, 200, 400,	1/2000 to 8 s (P, S mode) 1/4000 ³ to 8 s (A mode) 1/4000 ³ to 60 s (M mode)
	High ISO sensitivity auto ²	1/2000 to 2 s (P mode) 1/2000 to 4 s (S mode) 1/4000 ³ to 4 s (A mode) 1/4000 ³ to 60 s (M mode)
	ISO 800	1/2000 to 8 s (P, S mode) 1/4000 ³ to 8 s (A mode) 1/4000 ³ to 15 s (M mode)
	ISO 1600	1/2000 to 4 s (P, S mode) 1/4000 ³ to 4 s (A, M mode)
	ISO 3200	1/2000 to 1/2 s (P, S mode) 1/4000 ³ to 1/2 s (A, M mode)
	Hi 1	1/2000 to 1/8 s (P, S mode) 1/4000 ³ to 1/8 s (A, M mode)
Continuous (54)	Continuous, BSS, Continuous flash	1/2000 to 1/2 s (P, S mode) 1/4000 ³ to 1/2 s (A, M mode)
	Multi-shot 16	1/2000 to 1/30 s

¹ The ISO sensitivity setting is restricted depending on the continuous shooting setting (80).

² In **M** mode, the ISO sensitivity is fixed at ISO 100.



³ A shutter speed of 1/4000 second is available only when the zoom is at the wide-angle position and the aperture value is set to f/8 (minimum aperture).

Operation of Flash during Continuous Mode

The operation of the built-in flash and the Speedlight flash units (available separately from Nikon) are restricted as shown below, depending on the continuous setting that is applied.

Continuous mode	Built-in flash	Flash units*
Single	Available	Available
Continuous	Off	Available
Continuous flash	Available	Not available
BSS	Off	Not available
Multi-shot 16	Off	Not available
Intvl timer shooting	Available	Available
Auto bracketing	Off	Available

When a flash unit (available separately) is mounted on the camera's accessory shoe, the built-in flash is automatically set to  (off).

* When shooting using continuous or auto bracketing with the flash mode set to  (auto with red-eye reduction) ( 61, 62), only the pre-flash element of red-eye reduction is performed.

Notes on Digital Zoom

- The digital zoom cannot be used with certain shooting modes.
- When the digital zoom is in effect, selectable options for AF area mode or metering mode is restricted ( 79).

Using Face Detection

In the following shooting modes, the camera uses face detection to automatically focus on human faces. If the camera detects more than one face, a double border is displayed around the face that the camera will focus on, and single borders are displayed around the other faces.

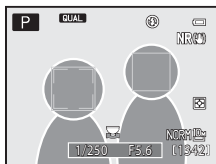

Shooting mode	Number of faces that can be detected	Focus area (double border)
Face priority is selected for AF area mode (📷48)	Up to 12	The face closest to the camera
Scene auto selector, Portrait, Night portrait scene mode (📷39)		
📷 (Smile timer) (📷65)	Up to 3	The face closest to the center of the frame

- When using **Face priority**, if you press the shutter-release button halfway while no faces are detected or while framing a shot with no faces in it, the camera automatically selects one or more of the nine focus areas containing the subject closest to the camera.
- When **Scene auto selector** is selected, the focus area changes depending on which scene the camera selects.
- If no faces are detected when the shutter-release button is pressed halfway in **Portrait** or **Night portrait** scene mode, the camera will focus on the subject at the center of the frame.
- When 📷 (smile timer) is selected, the shutter releases automatically when the camera detects a smiling face.

✓ Notes on Face Detection

- The camera's ability to detect faces depends on a variety of factors, including whether or not the subject is facing the camera. Additionally, the camera may be unable to detect faces in the following situations:
 - When faces are partially hidden by sunglasses or otherwise obstructed
 - When faces take up too much or too little of the frame
- When the frame includes more than one face, the faces detected by the camera and the face on which the camera focuses depend upon a variety of factors, including the direction in which the subject is facing.
- In some rare cases, such as those described in "Autofocus" (📷33), the subject may not be in focus even though the double border turns green. If the camera does not focus, try "Focus Lock" (📷33).

📷 Viewing Pictures Taken Using Face Detection

- During playback, the camera automatically rotates images according to the orientation of the faces that were detected at the time of shooting. Pictures taken when using **Continuous** (📷54) or **Auto bracketing** (📷73) are not rotated.
- When zooming in on an image displayed in full-frame playback mode by rotating the zoom control toward **T** (📷), the image is enlarged at the center of the face that was detected during shooting (📷35). Pictures taken when using **Continuous** (📷54) or **Auto bracketing** (📷73) are not displayed in this way.

Using Skin Softening

In the following shooting modes, the camera detects up to three human faces when the shutter is released, and processes the image to make facial skin tones softer before saving the image.

- **Scene auto selector** (📖40), **Portrait** (📖40) or **Night portrait** (📖41) in scene mode

Skin softening can also be applied to saved images (📖89).

✔ Notes on Skin Softening

- It may take more time to save images.
- Under some shooting conditions, the desired skin softening results may not be achieved, and skin softening may be applied to areas of the image where there are no faces.

Playback Features

This chapter describes how to select certain types of images for playback as well as some of the features available when playing back images.

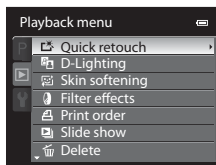
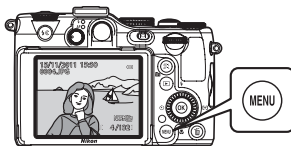
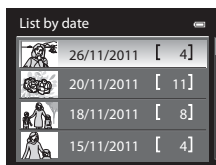
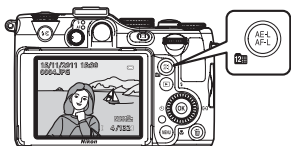



Selecting Pictures for Playback by Date (List by Date Mode)





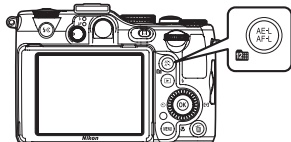

In list by date mode, pictures taken on the same date can be played back.

Press the  (list by date) button during playback to display the list by date screen.

- Press the  (list by date) button again to return to the normal playback mode.



Use the multi selector to select a date and then press the  button to play back images captured on the selected date.

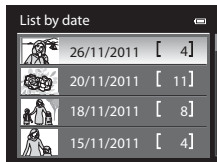

- The first picture taken on the selected date is displayed.
- To select a different date, rotate the zoom control toward **W** .
- The following operations can be performed while the list by date screen is displayed.
 -  (delete) button: Delete all images captured on the selected date.
 - **MENU** button: If you select the  tab (list by date menu) from the shooting date selection screen, you can select one of the following features in the playback menu ( 89) and apply that feature to images captured on the selected date.
 - Print order, slide show, delete, protect, hide image
- When viewing images in full-frame playback mode, if you press the **MENU** button to display the menu and then select the  tab (list by date menu), you can then select a feature from the playback menu ( 89).
- Thumbnail display and calendar display ( 35) cannot be used in list by date mode.











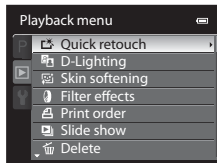















Notes on List by Date Mode

- Up to 29 dates can be selected. If images exist for more than 29 dates, all images saved earlier than most recent 29 dates will be combined under **Others**.
- The 9,000 most recent images can be displayed in list by date mode.
- Pictures taken when the camera's date is not set are treated as images captured on January 1, 2011.











Features Available in Playback Mode (Playback Menu)









When viewing images in full-frame playback mode or thumbnail playback mode, you can configure the following functions by pressing the **MENU** button to display the menu, and then selecting the  tab or  tab (book 13).



Option	Description	
 Quick retouch ¹	Create retouched copies in which contrast and saturation have been enhanced.	 11
 D-Lighting ¹	Create copies with enhanced brightness and contrast, brightening dark portions of an image.	 11
 Skin softening ¹	When this feature is enabled, the camera detects faces in pictures taken and creates a copy with softer facial skin tones.	 12
 Filter effects ¹	Apply a variety of effects using digital filter. The available effects are Soft , Selective color , Cross screen , Fisheye , Miniature effect and Painting .	 13
 Print order ²	When using a printer to print images saved on the memory card, the print order function can be used to select which images are printed, and how many copies of each image are printed.	 60
 Slide show ²	Images saved in the internal memory or on a memory card are played back in an automatic slide show.	 63
 Delete ²	Delete an image. Multiple images can be deleted.	 64
 Protect ²	Protect selected images from accidental deletion.	 66
 Rotate image	Specify the orientation in which saved images are displayed in playback mode.	 66
 Hide image ²	Hide the selected images so that they cannot be played back on the camera monitor.	 66
 Small picture ¹	Create a small copy of the picture taken. This feature is useful for creating copies for display on Web pages or e-mail attachments.	 14

Features Available in Playback Mode (Playback Menu)

Option	Description	
 Voice memo	Use the camera's microphone to record voice memos and attach them to the picture taken. Playback and deletion of voice memos can also be performed.	 67
 Copy ³	Copy images between the internal memory and a memory card.	 68
 Black border ¹	Create a new picture surrounded by a black border.	 15
 Straighten ¹	Compensate for the slanting of pictures taken.	 16
NRW NRW (RAW) processing ¹	Create JPEG-format copies by performing RAW processing within the camera for NRW (RAW) images ( 75) without having to use a computer.	 17

¹ This function is applied to edit the image currently selected and store it as separate file from the original file. Pictures shot with the **Image size** (77) of 2 **3648x2432**, 9 **3584x2016**, or 1 **2736x2736** and pictures extracted from movies recorded with  **720p HD 720p (1280x720)** can only be modified using the black border editing function (9, 10). Edited images may not be retouched again in some cases (10). Movies cannot be edited.

² When using list by date mode, press the **MENU** button from the list by date screen (88) to apply the same function to all images captured on the selected date.

³ This function is not displayed when using list by date mode.

See "Editing Still Images" (9) and "The Playback Menu" (60) in the Reference Section for more information about each function.

Connecting the Camera to a TV, Computer, or Printer

You can enhance your enjoyment of images and movies by connecting the camera to a TV, computer, or printer.

- Before connecting the camera to an external device, make sure the remaining battery level is sufficient and turn the camera off. For information about the connection methods and subsequent operations, refer to the documentation included with the device in addition to this document.

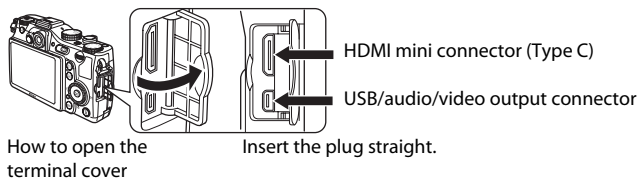

Viewing images on a TV

20



You can view the camera's images and movies on a TV.
Connection method: Connect the video and audio plugs of the included Audio Video Cable EG-CP16 to the TV's input jacks. Alternatively, connect a commercially available HDMI cable (Type C) to the TV's HDMI input jack.

Viewing and organizing images on a computer

92



If you transfer images to a computer, you can perform simple retouching and manage image data in addition to playing back images and movies.

Connection method: Connect the camera to the computer's USB input jack with the included USB Cable UC-E6.

- Before connecting to a computer, install ViewNX 2 on the computer using the included ViewNX 2 CD. See 94 for more information about using the ViewNX 2 CD and transferring images to a computer.

Printing images without using a computer

22



If you connect the camera to a PictBridge-compatible printer, you can print images without using a computer.

Connection method: Connect the camera directly to the printer's USB input jack with the included USB Cable UC-E6.

Using ViewNX 2

ViewNX 2 is an all-in-one software package which enables you to transfer, view, edit and share images.

Install ViewNX 2 using the ViewNX 2 CD.



Installing ViewNX 2

Compatible Operating Systems

Windows

- Windows 7 Home Basic/Home Premium/Professional/Enterprise/Ultimate
- Windows Vista Home Basic/Home Premium/Business/Enterprise/Ultimate (Service Pack 2)
- Windows XP Home Edition/Professional (Service Pack 3)

Macintosh

- Mac OS X (version 10.5.8, 10.6.7)

Refer to the Nikon website for the latest information on operating system compatibility.

1 Start the computer and insert the ViewNX 2 CD into the CD-ROM drive.

- Mac OS: When the **ViewNX 2** window is displayed, double-click the **Welcome** icon.

2 Select a language in the language selection dialog to open the installation window.

- If the desired language is not available, click **Region Selection** to choose a different region and then choose the desired language (the **Region Selection** button is not available in the European release).
- Click **Next** to display the installation window.

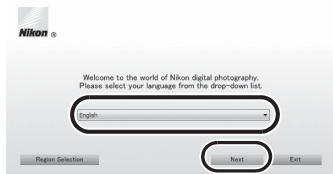

3 Start the installer.

- We recommend clicking **Installation Guide** in the installation window to check the installation help information and system requirements before installing **ViewNX 2**.
- Click **Typical Installation (Recommended)** in the installation window.
- Follow the on-screen instructions to install the software.

4 Exit the installer when the installation completion screen is displayed.

- Windows: Click **Yes**.
- Mac OS: Click **OK**.

The following software is installed:

- ViewNX 2 (consisting of the three modules below)
 - Nikon Transfer 2: For transferring images to the computer
 - ViewNX 2: For viewing, editing, and printing transferred images
 - Nikon Movie Editor: For basic editing of transferred movies
- Panorama Maker 5 (for creating a single panorama photo using a series of images shot in panorama assist scene mode)
- QuickTime (Windows only)

5 Remove the ViewNX 2 CD from the CD-ROM Drive.

Transferring Images to the Computer

1 Choose how images will be copied to the computer.

Choose one of the following methods:

- **Direct USB connection:** Turn the camera off and ensure that the memory card is inserted in the camera. Connect the camera to the computer using the included USB Cable UC-E6 and then turn the camera on.

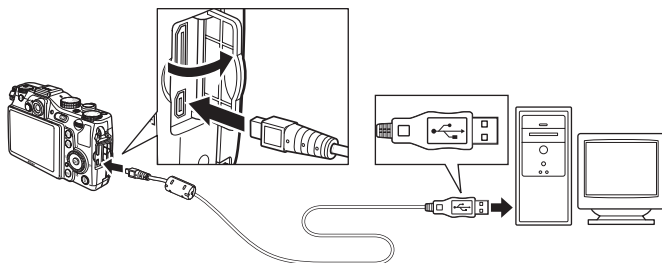

- **SD card slot:** If your computer is equipped with an SD card slot, the card can be inserted directly in the slot.
- **SD card reader:** Connect a card reader (available separately from third-party suppliers) to the computer and insert the memory card.

If a message is displayed prompting you to choose a program, select Nikon Transfer 2.

• When using Windows 7

If the dialog shown at right is displayed, follow the steps below to select Nikon Transfer 2.

- 1 Select Nikon Transfer 2 for **Import pictures and videos**. Under **Import pictures and videos**, click **Change program**. A program selection dialog will be displayed; select **Import File using Nikon Transfer 2** and click **OK**.
- 2 Double-click **Import File**.



If the memory card contains a large number of images, it may take a while for Nikon Transfer 2 to start. Wait until Nikon Transfer 2 starts.

✓ Connecting the USB Cable

The connection may not be recognized if the camera is connected to the computer via a USB hub.

2 Transfer images to the computer.

- Confirm that the name of the connected camera or removable disk is displayed in the “Source” panel in the Nikon Transfer 2 “Options” area (①).
- Click **Start Transfer** (②).

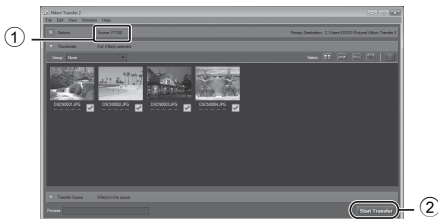

- At default settings, all the images on the memory card will be copied to the computer.

3 Terminate the connection.

- If the camera is connected to the computer, turn the camera off and then disconnect the USB cable.
- If you are using a card reader or card slot, choose the appropriate option in the computer operating system to eject the removable disk corresponding to the memory card and then remove the card from the card reader or card slot.

Viewing Images

Start ViewNX 2.

- Images are displayed in ViewNX 2 when transfer is complete.
- Consult online help for more information on using ViewNX 2.

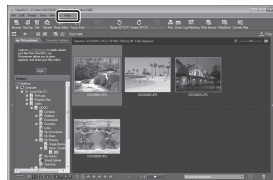

Starting ViewNX 2 Manually

- **Windows:** Double-click the **ViewNX 2** shortcut on the desktop.
- **Mac OS:** Click the **ViewNX 2** icon in the Dock.

Retouching Photographs

Click **Edit** in the ViewNX 2 toolbar.



Image editing functions include tone compensation, sharpness adjustment, and trimming (cropping).

Editing Movies

Click **Movie Editor** in the ViewNX 2 toolbar.

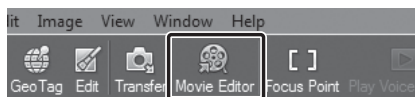

Movie editing functions include the ability to delete unwanted scenes.

Printing Images

Click **Print** in the ViewNX 2 toolbar.



A dialog is displayed and images can be printed using a printer connected to the computer.

Recording and Playing Back Movies

Set the mode dial to  to display the movie recording screen. Press the shutter-release button to record movies.

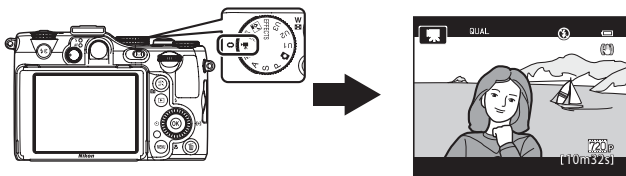

In playback mode, press the  button to play back a movie.

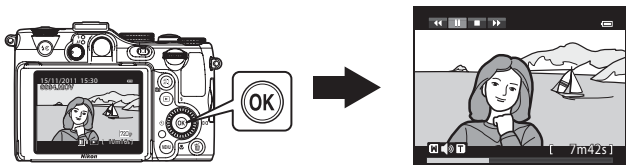

Recording Movies

Movies can be recorded with sound.

1 Rotate the mode dial to **M**.

- The amount of available recording time is displayed on the monitor.
- When **Movie options** is set to **720p HD 720p (1280x720)**, monitor display changes to an aspect ratio of 16:9 (the area indicated on the right is recorded).
- The approximate remaining recording time is displayed on the monitor. **IN** is displayed while saving to the internal memory.

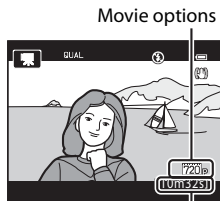

Available movie recording time*

* The maximum recording time shown in the illustration differs from the actual value.

2 Press the shutter-release button all the way to start recording.

- The camera focuses at the center of the frame. The focus area is not displayed when the movie is recorded.
- When the **AE-L/AF-L** button is pressed while recording movies, the exposure and focus are locked (**L**3). Press the **AE-L/AF-L** button again to cancel the exposure and focus lock.
- Recording stops automatically when the maximum movie length has been recorded.



3 Press the shutter-release button all the way to end recording.

✓ Note on Recording Movies

When the AF/access lamp blinks after recording movies, the movie is not fully recorded yet. **Do not open the battery-chamber/memory card slot cover.** Removing the memory card or the battery while a movie is being saved may result in loss of the movie data or damage to the camera or to the memory card.

✓ Notes on Movie Recording

- When recording a movie onto a memory card, a memory card with an SD speed class of Class 6 or higher is recommended (☞123). If the transfer speed of the card is slow, the movie recording may end unexpectedly.
- Using a digital zoom causes image quality to deteriorate. If you start recording the movie without using digital zoom, and you rotate the zoom control toward **T**, the zoom stops at the maximum optical zoom ratio. Release the zoom control once, then rotate it again toward **T** to trigger digital zoom. When recording ends, digital zoom turns off.
- The sound of using the zoom control, zoom, autofocus, vibration reduction or aperture control when the brightness changes may be recorded. To minimize the recording of the zoom sound, set **Zoom speed** in the setup menu to **Auto** (default setting) or **Quiet** (☞104).
- Smear (☞3) visible in the monitor when recording movies will be recorded with the movies. Avoiding bright objects such as the sun, reflections of the sun, and electric lights when recording movies is recommended.
- The flash does not fire.

✓ Notes on Autofocus

- When **Autofocus mode** in the movie menu (☞101) is set to **AF-S Single AF** (default setting), the focus is locked when the shutter-release button is pressed halfway.
- Autofocus may not perform as expected (☞33). Should this occur, try the following:
 1. Before recording, set **Autofocus mode** in the movie menu to **AF-S Single AF** (default setting).
 2. Position a different subject at the same distance in the middle of the screen. Press the shutter-release button to start the movie recording, and change the composition.

✓ Notes on the Camera Temperature

- The camera may become warm when recording movies for an extended period of time or when the camera is used in a hot area.
- When the temperature inside the camera becomes extremely high while recording a movie, recording automatically stop after 30 seconds.



The remaining amount of recording time (☞30s) is displayed on the monitor.

The camera turns off in 5 seconds after movie recording automatically stops.

Leave the camera off until the inside of the camera has cooled and then use it.



Maximum Movie Length

Movie options (📖73)	Internal memory (94 MB)	Memory card (4 GB)*
 HD 720p (1280×720)	1 min 28 s	55 min
 VGA (640×480)	4 min 24 s	2 h 55 min
 QVGA (320×240)	20 min 28 s	13 h 35 min

All figures are approximate. The maximum movie length varies with the make of the memory card and the bitrate of the recorded movie.

* The maximum recording time for a single movie is 29 minutes. The maximum movie length displayed during recording is 29 minutes, even when there is enough free space on the memory card for a longer movie.

External Microphones

- Instead of the built-in microphone, a Stereo Microphone ME-1 (available separately; 🎧103) can be connected to the external microphone connector (📖3) to record sound during movie recording or voice memos for still pictures (📖90).
- When the external microphone is connected, **Wind noise reduction** in the movie menu (📖101) cannot be used.
- The external microphones sensitivity can be set in **External mic sensitivity** in the setup menu (📖104).

More Information

See "File and Folder Names" (🎧99) for more information.

Changing Movie Mode Settings

Use the following operation controls to change the setting.

- See “Features That Can Be Set Using the Multi Selector” (📖60) for more information on remote control (📖60), focus mode (📖67).
- See “Features Set Using the Exposure Compensation Dial” for more information on exposure compensation (📖71).
- See “Features That Can Be Set with the Quick Menu” for more information on available quick menu (📖73).
- See “Options Available in the Movie Menu” (below) for more information on functions that can be set using the **MENU** button.

Options Available in the Movie Menu

In the movie mode, the following option settings can be changed.

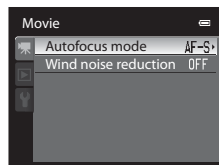

Display the shooting screen in the movie mode → MENU button → 📷 tab (📖13)

Option	Description	📖
Autofocus mode	Single AF (default setting) where the camera focuses on the same position as one at the start of movie recording, or Full-time AF where the camera focuses continuously during movie recording can be selected. When Full-time AF is selected, the sound of the camera focusing may be heard in recorded movies. If you want to prevent the sound of the camera focusing from being recorded, select Single AF .	📖69
Wind noise reduction	Set whether or not to reduce wind noise during movie recording. During playback, not only wind noise, but other sounds may also become difficult to hear. The default setting is Off .	📖69

Playing Back Movies

1 Press the  (playback) button to select playback mode.

- Press the multi selector to select a movie.
- Movies can be recognized by the movie options icon (100).

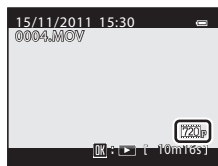



2 Press the  button to play back a movie.

Adjusting the volume

Press the zoom control **T/W** (2) during playback.















Operations available during movie playback

Playback controls appear at the top of the monitor.





Press the multi selector  or  to select an icon of playback control, then press the  button to perform the following operations.



During playback Volume indicator

To	Use	Description
Rewind		Rewind the movie while the  button is pressed down.
Advance		Advance the movie while the  button is pressed down.
Pause		The following operations can be performed with the playback controls at the top of the monitor while playback is paused.
		 Rewind the movie by one frame. Hold down the  button to rewind continuously.*
		 Advance the movie by one frame. Hold down the  button to advance continuously.*
		 Extract and save only the required parts of the movie ( 28).
		 Save the extracted frame from a movie as a still picture ( 29).
		Resume playback.
End		Return to full-frame playback mode.

* The movie can also be advanced or rewound by one frame by rotating the multi selector or command dial.

To delete a movie, use full-frame playback mode (34) or thumbnail playback mode (35) to select a movie and press the  button (36).

Note on Movie Playback

Movies recorded with cameras other than COOLPIX P7100 cannot be played back.

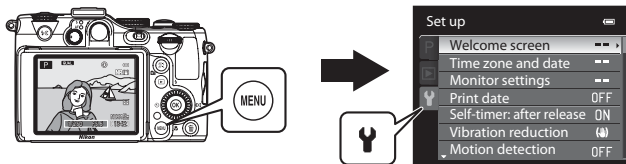

General Camera Setup

This chapter describes the various settings that can be adjusted in the  setup menu.









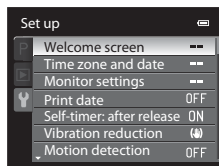

- See “Using Menus (the **MENU** Button)” (📖13) for more information about using the camera’s menus.
- For further details about each setting, refer to “The Setup Menu” in the Reference Section (🔑70).















The Setup Menu

Press the MENU button →  (setup) tab  13











From the menu screen, select the  tab to display the setup menu, and then you can change the following settings.

















Option	Description	
Welcome screen	Select the image displayed as the welcome screen when the camera is turned on. Select COOLPIX to display the COOLPIX logo. Select Select an image to use a picture taken with the camera as the welcome screen. The default setting is None .	 70
Time zone and date	Set settings related to the camera's date and time. The Time zone setting allows you to specify the time zone where the camera is mainly used and whether or not daylight saving time is in effect. When the  travel destination is set, the camera automatically calculates the time difference between the travel destination and the  home time zone, and saves images using the date and time of the travel destination.	 71
Monitor settings	Set the image display after shooting and the screen brightness. When using Photo info , set whether or not to display virtual horizon, histograms, and framing grid on the monitor. When using Virtual horizon display , set the virtual horizon indicator to either Circle (default setting) or Bars .	 74
Print date	Imprint the shooting date and time on pictures at the time of shooting. The default setting is Off . <ul style="list-style-type: none"> Dates cannot be imprinted when the scene mode is set to Sports, Museum, Backlighting with HDR set to On, Panorama assist, or Pet portrait with Continuous or during movie recording. 	 75
Self-timer: after release	Set whether or not to cancel the setting after shooting pictures with the self-timer. The default setting is Exit self-timer mode .	 76















Option	Description	
Vibration reduction	<p>Reduce blurring caused by camera shake when shooting. The default setting is On.</p> <ul style="list-style-type: none"> When using a tripod to stabilize the camera, set this feature to Off to prevent this feature from malfunctioning. 	 76
Motion detection	<p>When the camera detects camera shake or subject movement at the time of shooting, it automatically increases ISO sensitivity and shutter speed to reduce blurring. The default setting is Off.</p> <p>The  indicator lights in green when the camera detects camera shake and increases shutter speed.</p> <ul style="list-style-type: none"> When using certain shooting modes or settings, motion is not detected. In this case the  indicator is not displayed. 	 77
AF assist	<p>When set to Auto (default setting), the AF-assist illuminator (33) lights when shooting in dark surroundings to help the camera focus.</p> <ul style="list-style-type: none"> The illuminator has a range of about 8.0 m (26 ft) at the maximum wide-angle position and about 7.0 m (22 ft) at the maximum telephoto position. Even if Auto is selected, the AF-assist illuminator may not light depending on the position of the focus area or the scene mode that is selected. 	 78
Red-eye reduction	<p>When the flash mode (61) is set to  (auto with red-eye reduction) and this feature is set to Pre-flash on (default setting), the flash repeatedly fires pre-flashes at low intensity before the main flash to reduce the red-eye effect, and it then performs the red-eye reduction process using picture compensation.</p>	 78
Digital zoom	<p>When set to On (default setting), when the optical zoom is at the maximum telephoto zoom position, rotating and holding the zoom control toward T () triggers the digital zoom (31).</p> <p>When set to Crop, the digital zoom is limited to the range (to the zoom position ) at which image quality of the shot still picture does not deteriorate (except when recording a movie).</p> <ul style="list-style-type: none"> The digital zoom cannot be used simultaneously in certain settings such as the shooting mode. 	 79

The Setup Menu

Option	Description	
Zoom speed	<p>Set the zoom operation speed.</p> <p>When set to Auto (default setting), the zoom is operated at Normal speed during still picture shooting. The zoom is operated at Quiet speed during movie recording.</p> <p>When set to Normal, the zoom is operated at normal speed during both still picture shooting and movie recording.</p> <p>When set to Quiet, the zoom is operated at a slower speed than Normal to minimize recording of the zoom operating noise during both still picture shooting and movie recording.</p>	 80
Fixed aperture	<p>When set to On in A or M shooting mode, the zoom is operated with minimum changes in the aperture value. Note, however, that the range of aperture values may be exceeded in some zoom operations. The default setting is Off.</p>	 80
Sound settings	<p>Turn various camera sounds on and off. In the default setting, beep sounds are on.</p> <ul style="list-style-type: none"> • The operation sound is disabled in certain settings such as shooting mode. 	 81
Record orientation	<p>When set to Auto (default setting), the orientation data is recorded with the picture taken.</p> <ul style="list-style-type: none"> • Pictures taken using face detection (85) or pet detection (45) will be rotated automatically in accordance with the orientation of the face when they are displayed, regardless of the settings. 	 81
Rotate tall	<p>When set to On (default setting), the images are rotated automatically in accordance with camera orientation when they are played back.</p>	 82
Auto off	<p>Set the amount of time that passes before the monitor is turned off to save power. The default setting is 1 min.</p>	 82
Format memory/ Format card	<p>Format the internal memory (only when a memory card is not inserted) or the memory card (when a memory card is inserted).</p> <ul style="list-style-type: none"> • All data stored in the internal memory or on the memory card is deleted during formatting and cannot be restored. Be sure to transfer important images to a computer and save them before formatting. 	 83
Language	<p>Change the camera's display language.</p>	 83

Option	Description	
TV settings	Select this option if no image is displayed on a TV even when the audio/video cable or HDMI cable is connected to the TV. HDMI device control is used for setting whether or not the camera receives signals from a TV when the TV that conforms to the HDMI-CEC standard is connected with an HDMI cable.	 84
External mic sensitivity	Set the sensitivity of the external microphone. The default setting is Auto . <ul style="list-style-type: none"> When the sensitivity of the microphone is low, set the option to High. 	 84
Built-in ND filter	When the camera's built-in ND filter is used, the amount of light that enters the camera can be reduced while shooting. Use this feature in situations such as when overexposure results from the subject being too bright. The default setting is Off . <ul style="list-style-type: none"> In shooting modes other than P, S, A, M, U1, U2, U3 and  (low noise night) modes, the built-in ND filter is controlled automatically according to the shooting mode and shooting conditions, regardless of the setting. 	 85
Customize command dials	Switch the functions that can be operated using the main command dial and sub-command dial for shooting pictures. <ul style="list-style-type: none"> The default setting is No swap. 	 86
Multi selector right press	When set to AF area mode (default setting), when the multi selector  ([+]) is pressed during shooting, the AF area mode setting ( 50) is displayed. In order not to display the AF area mode setting even if  ([+]) is pressed, set to Off .	 86
Delete button options	When set to Press twice to delete , the image can be deleted by pressing the  button again while the delete confirmation message is displayed. The default setting is Disable second press .	 86
AE/AF lock button	Select the function to be performed when the  (AE-L/AF-L) button is pressed during shooting. When set to AE/AF lock button (default setting), both focus and exposure are locked if the  (AE-L/AF-L) button is pressed while shooting. <ul style="list-style-type: none"> Not available when the scene mode is Scene auto selector (40). 	 87
Fn1 + shutter button	Set the function to be performed when the shutter-release button is pressed while pressing the Fn1 (FUNC1) button during shooting. The default setting is Off .	 88

The Setup Menu

Option	Description	
Fn1 + command dial	Set the function to be performed when the command dial is rotated while pressing the Fn1 (FUNC1) button during shooting. The default setting is Off .	 89
Fn1 guide display	Set whether or not to display a guide when the Fn1 (FUNC1) button is pressed during shooting. The default setting is On .	 89
Fn2 button	Set the operation to be performed when the Fn2 (FUNC2) button is pressed during shooting. The default setting is Off .	 90
Customize My Menu	Register frequently used menu items in My Menu ( 73) (maximum of five).	 90
Reset file numbering	When Yes is selected, the sequential numbering of file numbers is reset. After resetting, a new folder is created and the file number for the next image taken starts from "0001."	 91
Blink warning	When the camera detects that a human subject may have closed the eyes immediately after recognizing the face while shooting with modes other than the smile timer ( 85), the Did someone blink? screen is displayed on the monitor to check the picture taken. The default setting is Off .	 92
Eye-Fi upload	Set whether or not to enable the function for sending images to a computer using a commercially available Eye-Fi card. The default setting is Disable .	 93
MF distance indicator units	Set the unit of distance for displaying at screen gauge, to either m (meter) (default setting) or ft (feet) when using manual focus.	 94
Reverse indicators	Set the exposure indicator to be displayed when shooting mode is M and +/- display direction of indicator for setting the bracketing.	 94
Reset all	Reset the camera's settings to their default values. <ul style="list-style-type: none"> Some of the settings such as Time zone and date and Language and user settings that were saved for mode dial U1, U2 and U3 are not reset. 	 94
Firmware version	Display the current camera firmware version.	 98



Reference Section

The Reference Section provides detailed information and hints for using the camera.

Shooting

Taking Pictures with Manual Focus	2
Using Panorama Assist	3
P, S, A, M Modes	5

Playback

Editing Still Images	9
Connecting the Camera to a TV (Viewing Images on a TV)	20
Connecting the Camera to a Printer (Direct Print)	22
Editing Movies	28

Menu

Quick Menu	30
Shooting Menu (P, S, A or M Mode)	43
Specialized Menu for U1, U2 or U3	58
The Playback Menu	60
The Movie Menu	69
The Setup Menu	70

Additional Information

File and Folder Names	99
Speedlights (External Flash Unit)	101
Optional Accessories	103
Error Messages	107

Taking Pictures with Manual Focus

Available when the shooting mode is **P**, **S**, **A**, **M**, **U1**, **U2**, **U3**,  (low noise night), **EFFECTS** (special effects) or the **Sports** scene mode.

1 Press the multi selector ▼ (👇 focus mode).

- Use the multi selector to choose **MF** (manual focus) and press the **OK** button.
- **MF** is displayed on the top of the monitor, and the image area and the enlarged center of the picture are displayed at the same time.

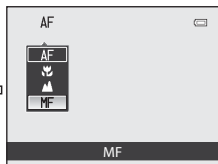
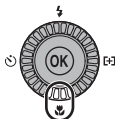

2 Adjust the focus.

- Use the multi selector to adjust the focus while viewing the image on the monitor.
- Press ▲ to focus on far subjects.
- Press ▼ to focus on near subjects.
- When ► is pressed, first the camera is focused with autofocus, and then the manual focus can be operated. Choose **Yes** and press the **OK** button to focus on the subject in the center of the screen with autofocus.
- Press the shutter-release button halfway to check the composition. Press the shutter-release button all the way to take the picture.

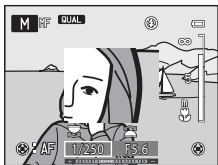

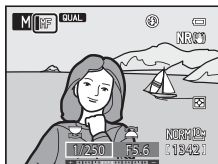

3 Press the **OK** button.

- The set focus is locked. You can continue shooting with the locked focus.
- To readjust the focus, press the **OK** button again to display the screen in step 2.
- To change back to autofocus, return to step 1 and choose any setting other than **MF**.



MF (Manual Focus)

- The digits displayed for the gauge on the right of the monitor in step 2 serve as a guideline for the distance to a subject that is in focus when the gauge indicates the center. To change the unit of this gauge, use **MF distance indicator units** ()94) in the setup menu.
- Press the shutter-release button halfway to preview an approximate depth of field (the area in focus behind and in front of the subject).
- The digital zoom is not available.
- Focus mode changes to **AF** (autofocus) when the monitor is turned off.
- When **Fn1 + command dial** ()89) in the setup menu is set to **Manual focus**, the screen shown in step 2 can be displayed or the focus can be adjusted by rotating the command dial while pressing the **Fn1** button.

Using Panorama Assist

Using a tripod makes the composition easier. When using a tripod to stabilize the camera, set **Vibration reduction** (🔧76) to **Off** in the setup menu.

1 Rotate the mode dial to SCENE.

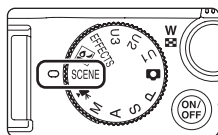





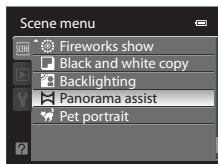

2 Press the MENU button to display the scene menu screen, choose **Panorama assist** with the multi selector and press the OK button.

- The  icon is displayed to show the direction in which pictures are joined.



3 Use the multi selector to choose the direction and press the OK button.

- Select the direction in which pictures are joined in the completed panorama: right () , left () , up () or down () .
- The yellow icon () moves to the direction pressed, so press the OK button to choose the direction. A white icon () is displayed in the chosen direction.
- Apply flash mode (📖61), self-timer (📖64)/remote control (🔧105), focus mode (📖67) and exposure compensation (📖71) settings with this step, if necessary.
- Press the OK button again to reselect the direction.

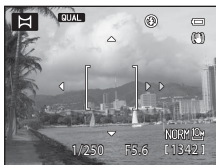

4 Frame the first portion of the panorama scene and take the first picture.

- The camera focuses on the subject at the center of the frame.
- 1/3 of the image will be displayed as translucent.

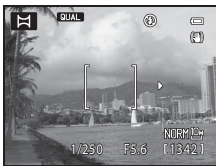

5 Shoot the next picture.

- Match the outline of the next picture so that 1/3 of the frame overlaps the previous picture, and press the shutter-release button.
- Repeat until you have taken the necessary number of pictures to complete the image.



6 Press the **OK** button when shooting is completed.

- The camera returns to step 3.

Notes on Panorama Assist

- Set the flash mode, self-timer/remote control, focus mode and exposure compensation before releasing the shutter for the first picture. The settings cannot be changed after shooting the first picture. Pictures cannot be deleted, nor can zoom, **Image quality** (📖75), or **Image size** (📖77) be adjusted after shooting the first picture.
- The panorama series is terminated if the auto off function (🔌82) triggers the standby mode during shooting. To prevent this, setting a longer time for the auto off function is recommended.

AE/AF-L (exposure lock) Indicator

When using panorama assist mode, all pictures in the panorama have the same exposure, white balance, and focus as the first picture of the panorama.

When the first picture is shot, **AE/AF-L** is displayed on the monitor to indicate that exposure, white balance, and focus are locked.



Panorama Creation

Transfer pictures taken to a computer (📖94) and use Panorama Maker 5 to join them in a single panorama.

Install Panorama Maker 5 on a computer using the included ViewNX 2 CD.

More Information

See "File and Folder Names" (🔌99) for more information.

P, S, A, M Modes

P (Programmed Auto), S (Shutter-Priority Auto) or A (Aperture-Priority Auto)

- 1 Rotate the mode dial to **P**, **S** or **A**.

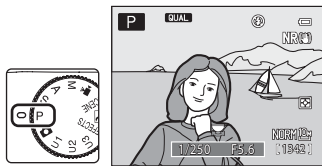

- 2 Rotate the command dial to set the exposure.



- In **P** mode, the flexible program (📖53) can be set.
- In **S** mode, the shutter speed can be set in a range from a maximum speed of 1/2000 to 8 seconds.
- In **A** mode, the aperture value can be set in a range of f/2.8 to 8 (wide-angle position) and f/5.6 to 8 (telephoto zoom position).

- 3 Frame the subject and shoot.

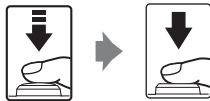
- In the default setting, the camera has nine focus areas, and automatically selects the focus areas containing the subject closest to the camera. When the subject is in focus, the focus area (active focus area) lights in green (maximum of nine areas) (📷48).



Notes on Shooting

- When zooming is performed after the exposure is set, exposure combinations or aperture value may be changed.
- When the subject is too dark or too bright, it may not be possible to obtain the appropriate exposure. In such cases, the shutter speed indicator or aperture value indicator blinks when the shutter-release button is pressed halfway. Change the shutter speed setting or aperture value. When settings such as **Built-in ND filter** (85) or **ISO sensitivity** (30) are changed, the appropriate exposure may be obtained.
- At shutter speeds of 1/4 second or slower, noise may appear in the image. In such situations, the shutter speed indicator lights in red. Setting **Long exposure NR** (53) to **On** is recommended.

Shutter Speed

- The control range of the shutter speed differs depending on the ISO sensitivity setting. Additionally, the range is restricted during continuous shooting (83).
- When the zoom is on the wide-angle position and the aperture value is set to f/8 (minimum aperture), the shutter speed can be set to up to 1/4000 seconds.

More Information

See “Customize Command Dials” (86) for more information.

M (Manual) Mode

The user controls both the shutter speed and aperture value.

- The shutter speed can be set in a range from a maximum speed of 1/4000 to 60 seconds.

1 Rotate the mode dial to M.

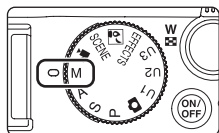

2 Rotate the main command dial to choose a shutter speed value.

- At shutter speeds of 1/4 second or slower, the shutter speed indicator lights in red (👁️5).
- See 📖53 for more information on exposure indicator.

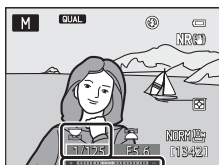

Exposure indicator

3 Rotate the sub-command dial to choose an aperture value.

- Repeat steps 2 to 3 to modify shutter speed and aperture value settings until the desired exposure is achieved.

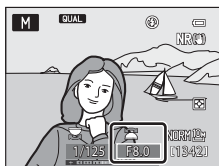

4 Focus and shoot.

- In the default setting, the camera has nine focus areas, and automatically selects the focus areas containing the subject closest to the camera. When the subject is in focus, the focus area (active focus area) lights in green (maximum of nine areas) (👁️48).



Note on Shooting

When zooming is performed after the exposure is set, aperture value may be changed.

Note on ISO Sensitivity

When **ISO sensitivity** () is set to **Auto** (default setting), **High ISO sensitivity auto, ISO 100-200** or **ISO 100-400**, ISO sensitivity is fixed at ISO 100.

Shutter Speed

- A shutter speed of 1/4000 second is available only when the zoom is at the wide-angle position and the aperture value is set to f/8 (minimum aperture).
- The control range of the shutter speed differs depending on the ISO sensitivity setting. Additionally, the range is restricted during continuous shooting (83).

Editing Still Images

Editing Features

Images can be easily edited with this camera using the functions below. Edited images are stored as separate files (📷99).

Editing function	Application
Quick retouch (📷11)	Easily create a copy with enhanced contrast and richer colors.
D-Lighting (📷11)	Create a copy of the current picture with enhanced brightness and contrast, brightening dark portions of the picture.
Skin softening (📷12)	Make the facial skin tones softer.
Filter effects (📷13)	Apply a variety of effects using digital filter. The available effects are Soft , Selective color , Cross screen , Fisheye , Miniature effect and Painting .
Small picture (📷14)	Create a small copy of pictures suitable for uses such as e-mail attachments.
Black border (📷15)	Add a black frame around the picture. Use when you want to add a black border to a picture.
Straighten (📷16)	Compensate for the slanting.
NRW (RAW) processing (📷17)	Create JPEG-format copies by performing RAW processing within the camera for NRW (RAW) images (📷75) without having to use a computer.
Crop (📷19)	Crop a portion of the picture. Use to zoom in on a subject or arrange a composition.

✓ Notes on Image Editing

- Pictures shot with an **Image size** (📷77) of **3648×2432**, **3584×2016**, or **2736×2736** can only be modified using the black border editing function.
Still pictures extracted from movies recorded with **720p HD 720p (1280×720)** can also only be modified using the black border editing function.
- When no faces are detected in the picture, skin softening cannot be applied (📷12).
- Editing other than NRW (RAW) processing cannot be performed on NRW (RAW) images. Edit a JPEG image created with NRW (RAW) processing.
- The COOLPIX P7100's editing functions are not available for pictures taken with cameras other than COOLPIX P7100.
- If a copy created using the COOLPIX P7100 is viewed on a different digital camera, it may not be possible to display the picture properly or transfer it to a computer.
- Editing functions are not available when there is not enough free space in the internal memory or on the memory card.

Restrictions on Image Editing

The following restrictions apply when editing pictures that were created by editing.



Editing functions used	Editing functions to add
Quick retouch D-Lighting	Skin softening, Small picture, Black border or Crop can be used. Quick retouch and D-Lighting cannot be used in combination with each other.
Skin softening NRW (RAW) processing	Additional editing functions can be used.
Filter effects	Skin softening, Small picture or Straighten can be used.
Small picture	No additional editing functions can be used.
Black border	Small picture can be used.
Straighten	Small picture or Black border can be used.
Crop	Black border or Straighten can be used. When the image size is 320 × 240 or smaller, straighten cannot be performed.

- Copies created by editing cannot be edited again using the same editing function.
- To use an editing function together with small picture, use the other editing function first, and use small picture as the last editing function performed on that picture.
- Pictures that were taken using skin softening can be edited using skin softening.



Original Pictures and Edited Copies

- Copies created with editing functions are not deleted if the original pictures are deleted. The original pictures are not deleted if copies created with editing functions are deleted.
- Edited copies are stored with the same shooting date and time as the original.
- Even if the pictures that are marked for **Print order** (🔗60) or **Protect** (🔗66) are used for editing, these settings are not reflected on the edited copies.

Quick Retouch: Enhancing Contrast and Saturation

Select a picture (📖34) → MENU button →  tab (📖13) →  Quick retouch

Press the multi selector ▲ or ▼ to choose the setting level, and press the  button.

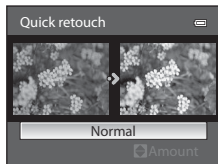

- The original version is displayed on the left and the edited version is displayed on the right.
- To cancel, press .
- Quick retouched copies can be recognized by the  icon displayed in playback mode.



D-Lighting: Enhancing Brightness and Contrast

Select a picture (📖34) → MENU button →  tab (📖13) →  D-Lighting

Press the multi selector ▲ or ▼ to choose the setting level, and press the  button.



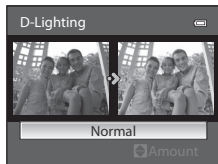

- The original version is displayed on the left and the edited version is displayed on the right.
- To cancel, press .
- D-Lighting copies can be recognized by the  icon displayed in playback mode.



More Information

See "File and Folder Names" (📖99) for more information.

Skin Softening: Softening Skin Tones



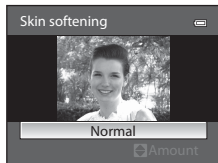

Select a picture (34) → MENU button →  tab (13) →  Skin softening

1 Press the multi selector ▲ or ▼ to choose the setting level, and press the button.

- A confirmation screen is displayed, and the image is displayed zoomed in on the face edited by skin softening.
- To cancel, press .



2 Confirm the results.

- Up to 12 faces, in order of proximity to the center of the frame, can be enhanced.
- When multiple faces are edited using skin softening, use the multi selector  or  to switch the face that is displayed.
- To adjust the extent of skin softening, press the **MENU** button and return to step 1.
- To create a copy edited with skin softening, press the  button.
- Copies created by editing with skin softening can be recognized by the  icon displayed in playback mode.

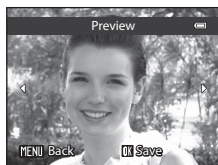

Notes on Skin Softening

- Depending on conditions such as the direction the subject is facing or the brightness of the face, the face may not be detected properly, or the desired effect may not be achieved.
- If no faces are detected in the image, a warning is displayed and the screen returns to the playback menu.

More Information

See "File and Folder Names" (99) for more information.

Filter Effects: Applying Digital Filter Effects

Select a picture (📖34) → MENU button → 🖼️ tab (📖13) → 🎨 Filter effects

Option	Description
Soft	Gently soften the focus of the image from the center to the edge. In pictures taken with face detection (📖85) or pet detection (📖45) selected, areas around faces will be blurred.
Selective color	Keep only selected image colors and makes other colors black-and-white.
Cross screen	Produce star-like rays of light that radiate outward from bright objects such as sunlight reflections and city lights. Suitable for night scenes.
Fisheye	Create images that look like they were shot with a fisheye lens. Suitable for pictures shot in macro mode.
Miniature effect	Create images that look like close-up photos of a diorama. Suitable for pictures shot while looking down from a high location, with the main subject near the center of the frame.
Painting	Create images with the ambience of paintings.

1 Press the multi selector ▲ or ▼ to choose the filter effect type and press the Ⓞ button.

- When **Cross screen**, **Fisheye**, **Miniature effect** or **Painting** is selected, proceed to step 3.

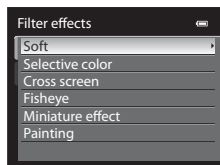

2 Adjust the effect and press the Ⓞ button.

- **Soft:** Press ▲ or ▼ to choose the extent of the effect.
- **Selective color:** Press ▲ or ▼ to select the color to keep.

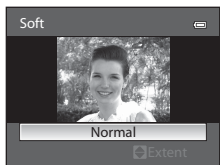



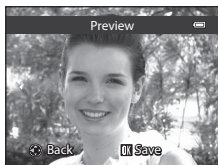

Soft

3 Check the effect and press the **OK** button.

- A new, edited copy is created.
 - To cancel, press **◀**.
-
- Copies created by editing with filter effect can be recognized by the  icon displayed in playback mode.



Small Picture: Reducing the Size of an Image

Select a picture (34) → MENU button →  tab (13) →  Small picture

1 Press the multi selector **▲** or **▼** to choose the desired copy size and press the **OK** button.

- The available size is **640×480**, **320×240** or **160×120**.

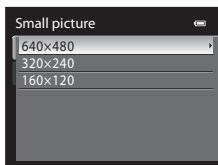

2 Choose **Yes** and press the **OK** button.

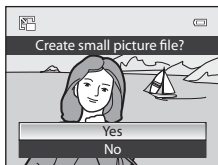

- A new, smaller copy is created.
- Image quality is saved as **Basic** (compression ratio of about 1:16).
- To cancel, choose **No** and press the **OK** button.
- The copy is displayed with a black frame.



More Information

See "File and Folder Names" (99) for more information.

Black Border: Adding a Black Border to Pictures

Select a picture (📖34) → MENU button →  tab (📖13) →  Black border

- 1** Press the multi selector ▲ or ▼ to choose the desired frame thickness and press the  button.

- Choose from **Thin**, **Medium**, or **Broad** lines.

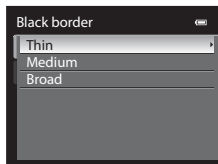

- 2** Choose **Yes** and press the  button.

- A new copy with a black border is created.
- To cancel, choose **No** and press the  button.

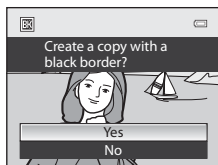

- Copies created by editing with black borders can be recognized by the  icon displayed in playback mode.

Notes on Black Border

- A part of the picture equivalent to the thickness of the black border is cut off because the black border overlaps the picture.
- When a picture with a black border is printed using a printer's borderless print function, the black border may not be printed.





More Information

See "File and Folder Names" (📖99) for more information.

Straighten: Compensating for Picture Slanting

Select a picture (34) → MENU button →  tab (13) →  Straighten

Use the multi selector to compensate for slanting.

- Press  to rotate counterclockwise by 1 degree.
- Press  to rotate clockwise by 1 degree.
- To cancel, press the MENU button.
- To create a copy edited with straighten, press the  button.
- Copies created by editing with straighten can be recognized by the  icon displayed in playback mode.



Notes on Straighten

- When straighten is performed, the picture edges are cut. The larger the slant for which compensation is performed, the larger the area around the picture that is cut.
- Straighten can be performed up to 15 degrees.

More Information

See "File and Folder Names" (99) for more information.

NRW NRW (RAW) Processing: Creating JPEG Images from NRW Images

Press the MENU button → tab (📖13) → **NRW** NRW (RAW) processing

- 1 Use the multi selector to choose the picture to be RAW processed and press the button.

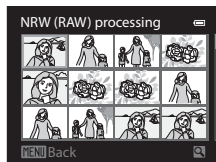

- 2 Set the NRW (RAW) processing parameters.

- Apply the settings below while checking the image and rotating the zoom control toward **T** (). Rotate toward **T** () again to return to the setting screen.
 - **White balance:** Choose a white balance setting other than **Auto (warm lighting)** (32).
 - **Exp. +/-:** Adjust the brightness.
 - **Picture Control:** Change the settings for finish of the image (38).
 - **Image quality:** Choose the image quality from **Fine**, **Normal**, or **Basic** (📖75).
 - **Image size:** Choose an image size (📖77). The image is cropped if **3648x2432**, **3584x2016** or **2736x2736** is selected.
 - **Distortion control:** Set the distortion control (54).
 - **D-Lighting:** Enhance brightness and contrast in dark portions of pictures (11).
- Press the button to change back to the default settings.
- Choose **EXE** when all settings have been adjusted.

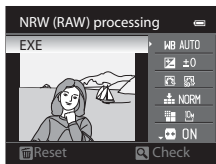

- 3 Choose **Yes** and press the button.

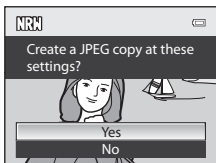

- An NRW (RAW) processed JPEG image is created.
- To cancel the creation, choose **No**.





Notes on NRW (RAW) Processing

- The COOLPIX P7100 can only create JPEG-format copies of NRW (RAW) images taken with the COOLPIX P7100.
- NRW (RAW) processing > **White balance** > **Preset manual** cannot be selected for photographs taken at a **White balance** setting other than **Preset manual**.

More Information







- See "Printing Images of Size 1:1" (79) for more information.
- See "File and Folder Names" (99) for more information.

Crop: Creating a Cropped Copy

Create a copy containing only the portion visible on the monitor when **MENU**  is displayed with playback zoom (35) enabled. Cropped copies are stored as separate files.

1 Enlarge the picture for cropping (35).

2 Refine copy composition.

- Rotate the zoom control toward **T** ( ) or **W** () to adjust the zoom ratio.
- Press the multi selector , , , or  to scroll the picture until only the portion you want to copy is visible on the monitor.



3 Press the **MENU** button.

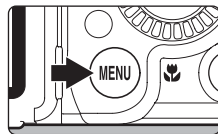

4 Use the multi selector to choose **Yes** and press the  button.

- A new picture, containing only the portion visible on the monitor, is created.
- To cancel, choose **No** and press the  button.

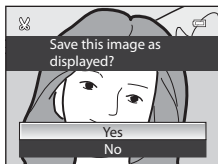





Image Size

The narrower the cropping range, the smaller the size (amount of pixels) of the cropped picture copy. When the image size setting for a cropped copy is 320x240 or 160x120, a black frame appears around the picture during playback, and the  small picture icon is displayed on the left side of the monitor.

Cropping the Picture in its Current “Tall” Orientation

Use the **Rotate image** option (66) to rotate the picture so that it is displayed in landscape orientation. After cropping the picture, rotate the cropped picture back to “tall” orientation. The picture displayed in “tall” orientation can be cropped by zooming in on the picture until the black bars displayed on the both sides of the monitor disappear. The cropped picture is displayed in landscape orientation.

More Information

See “File and Folder Names” (99) for more information.

Connecting the Camera to a TV (Viewing Images on a TV)

Connect the camera to a television to play back pictures on the television. If your television is equipped with an HDMI connector, you can connect it to the camera with a commercially available HDMI cable to play back pictures.

- 1 Turn off the camera.

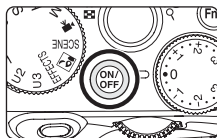

- 2 Connect the camera to the TV.

When connecting using the included audio/video cable

- Connect the yellow plug to the video-in jack on the TV, and the red and white plugs to the audio-in jacks.

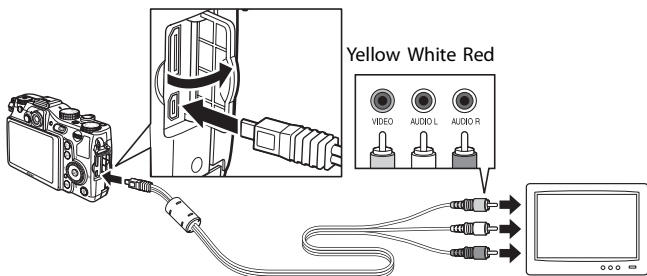

When connecting using a commercially available HDMI cable

- Connect the plug to the HDMI jack on the TV.

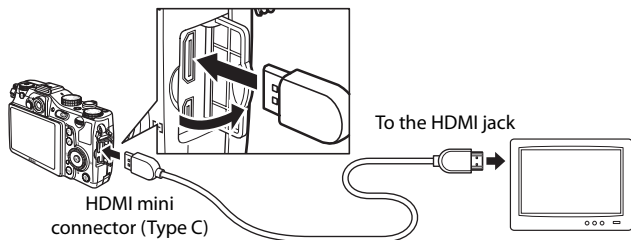





3 Tune the television to the video channel.

- See the instruction manual provided with your television for details.

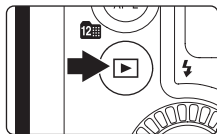
4 Hold down the  button to turn on the camera.

- The camera enters playback mode, and the recorded pictures are displayed on the television.
- While the camera is connected to the TV, the monitor remains off.

**✓** Notes on Connecting an HDMI Cable

- An HDMI cable is not included. Use a commercially available HDMI cable to connect the camera to a TV. The output terminal on this camera is a HDMI Mini Connector (Type C). When purchasing an HDMI cable, be sure that the device end of the cable is a HDMI Mini Connector.
- We recommend shooting still pictures with **Image size** () set to  **2048x1536** or higher, and recording movies with **Movie options** () set to  **HD 720p (1280x720)**.

✓ Notes on Connecting the Audio/Video Cable

- When connecting the cable, be sure that the plug is oriented correctly. Do not force the plug into the camera. When disconnecting the cable, do not pull the plug at an angle.
- Do not connect cables to the HDMI mini connector and USB/audio video connector simultaneously.

✓ When Nothing Appears on the TV

Make sure that **TV settings** () in the setup menu is appropriate for your television.

 Using the TV's Remote Control (HDMI Device Control)

The remote control of a TV that conforms to the HDMI-CEC standard can be used to operate the camera during playback.

Instead of the multi selector or zoom control, the remote control can be used for picture selection, and switching between movies, full-frame playback and four thumbnails display.

- Set **HDMI device control** () of **TV settings** to **On** (default setting) in the setup menu, and connect the camera to the TV with an HDMI cable.
- Point the remote control at the TV to operate.
- See your TV's instruction manual or other related documentation to check whether your TV supports the HDMI-CEC standard.

Connecting the Camera to a Printer (Direct Print)

Users of PictBridge-compatible (🔦16) printers can connect the camera directly to the printer and print pictures without using a computer. The steps for printing are as follows.

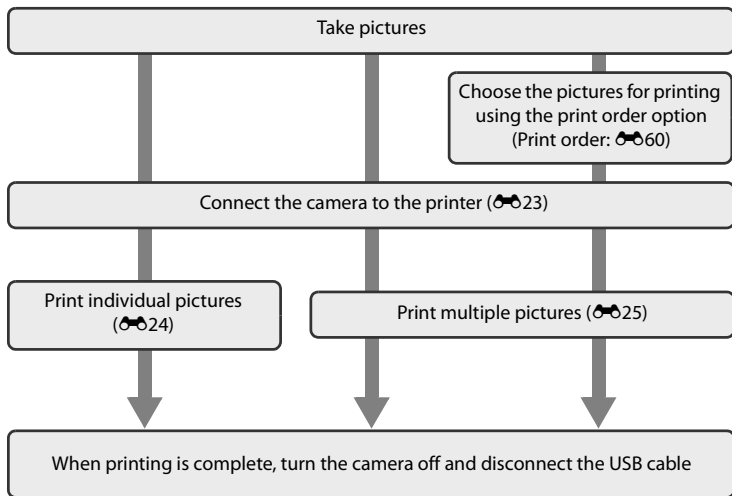

✔ Notes on Power Source

- When connecting the camera to a printer, use a fully charged battery to prevent the camera from turning off unexpectedly.
- If the AC Adapter EH-5b and the Power Connector EP-5A (available separately) (🔦103) are used, COOLPIX P7100 can be powered from an electrical outlet. Do not, under any circumstances, use an AC Adapter other than the EH-5b or a Power Connector other than the EP-5A. Failure to observe this precaution could result in overheating or damage to the camera.

📎 Printing Pictures

In addition to printing pictures transferred to a computer and printing pictures with a direct camera-to-printer connection, the following options are also available for printing pictures recorded on the memory card:

- Insert a memory card into a DPOF-compatible printer's card slot.
- Take a memory card to a digital photo lab.

For printing using these methods, specify the pictures and the number of prints each using the **Print order** (🔦60) option in the playback menu.

Connecting the Camera to a Printer

- 1 Turn off the camera.

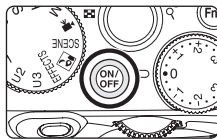

- 2 Turn on the printer.

- Check the printer settings.

- 3 Connect the camera to the printer using the included USB cable.

- Be sure that the plug is oriented correctly. When disconnecting the cable, do not pull the plug at an angle.

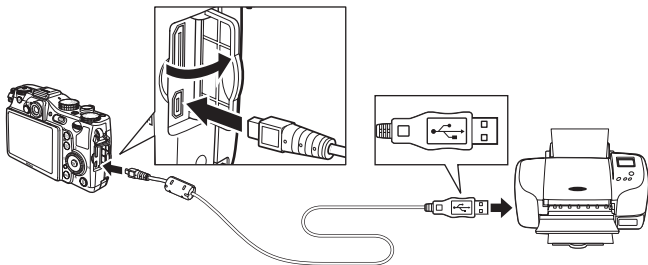

- 4 Turn on the camera.

- When connected correctly, the **PictBridge** startup screen (1) is displayed on the camera monitor. Then the **Print selection** screen (2) is displayed.

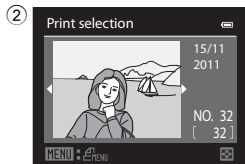
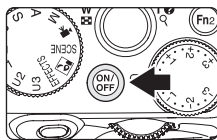

Printing Individual Images

After connecting the camera to the printer correctly (📷23), print pictures by following the procedure below.

1 Use the multi selector to choose the picture to be printed and press the **OK** button.

- Pictures can also be chosen by rotating the main command dial.
- Rotate the zoom control toward **W** (📷) to display 12 thumbnails, or toward **T** (📷) to switch back to full-frame playback mode.

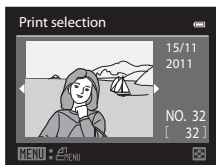

2 Choose **Copies** and press the **OK** button.

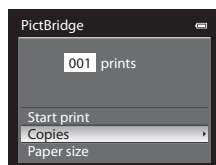

3 Choose the number of copies (up to nine) and press the **OK** button.



4 Choose **Paper size** and press the **OK** button.

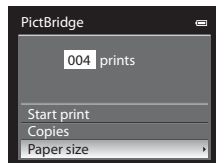

 **More Information**

See "Printing Images of Size 1:1" (📖79) for more information.

5 Choose the desired paper size and press the **OK** button.

- To specify the paper size using the printer settings, choose **Default** in the paper size menu.

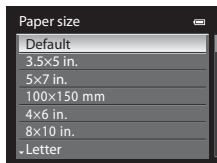

6 Choose **Start print** and press the **OK** button.

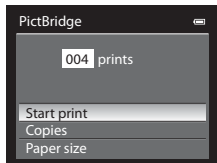

7 Printing starts.

- The monitor display returns to that shown in step 1 when printing is complete.
- To cancel before all copies have been printed, press the **OK** button.

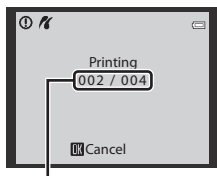

Current print/total number of prints

Printing Multiple Images

After connecting the camera to the printer correctly (🔗23), print pictures by following the procedure below.

1 When the **Print selection** screen is displayed, press the **MENU** button.

- The **Print menu** is displayed.

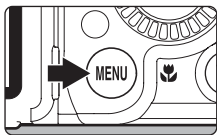

2 Use the multi selector to choose **Paper size** and press the **OK** button.

- To exit the print menu, press the **MENU** button.

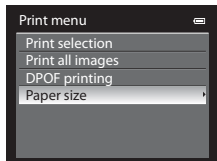

3 Choose the desired paper size and press the **OK** button.

- To specify the paper size using the printer settings, choose **Default** in the paper size menu.

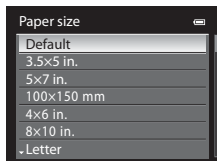

4 Choose **Print selection**, **Print all images** or **DPOF printing** and press the **OK** button.

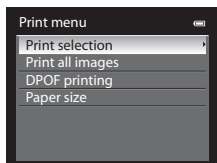

Print selection

Choose the pictures (up to a maximum of 99) and number of copies (up to nine per picture).

- Press the multi selector **◀** or **▶** to choose the pictures, and press **▲** or **▼** to set the number of copies for each.
- Pictures can also be chosen by rotating the main command dial.
- Pictures selected for printing can be recognized by the check mark icon and the numeral indicating the number of copies to be printed. A check mark is not displayed with pictures for which no copies have been specified and these pictures are not printed.
- Rotate the zoom control toward **T** (Q) to switch to full-frame playback mode, or **W** (R) to switch to 12 thumbnails display.
- Press the **OK** button when setting is complete.
- When the menu on the right is displayed, choose **Start print** and press the **OK** button to start printing.
- Choose **Cancel** and press the **OK** button to return to the print menu.

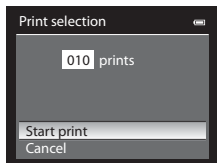

Print all images

All pictures stored in the internal memory or on the memory card are printed one per each.

- When the menu shown on the right is displayed, choose **Start print** and press the **OK** button to start printing.
- Choose **Cancel** and press the **OK** button to return to the print menu.

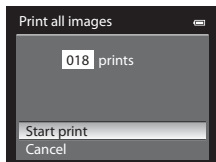

DPOF printing

Pictures for which a print order was created in **Print order** option (0-60) can be printed.

- When the menu shown on the right is displayed, choose **Start print** and press the **OK** button to start printing.
- Choose **Cancel** and press the **OK** button to return to the print menu.
- To view the current print order, choose **View images** and press the **OK** button. To print pictures, press the **OK** button again.

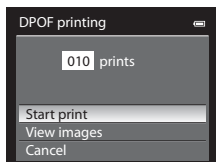

5 Printing starts.

- The monitor display returns to that shown in step 2 when printing is complete.
- To cancel before all copies have been printed, press the **OK** button.

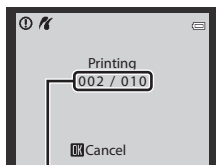

Current print/total number of prints

Paper Size

The camera supports the following paper sizes: **Default** (the default paper size for the current printer), **3.5×5 in.**, **5×7 in.**, **100×150 mm**, **4×6 in.**, **8×10 in.**, **Letter**, **A3**, and **A4**. Only sizes supported by the current printer are displayed.

Editing Movies

Extracting Only the Desired Portions of the Movie

The desired portions of a recorded movie can be saved as a separate file.

1 Play back the movie to be edited and pause at the start point of the portion that is to be extracted (102).

2 Use the multi selector ◀ or ▶ to choose ✂ on the playback control and press the OK button.

- The movie editing screen is displayed.

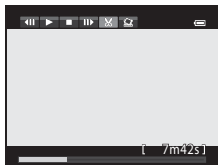

3 Press ▲ or ▼ to choose ⏮ (Choose start point) on the editing playback control.

- Rotate the multi selector or press ◀ or ▶ to adjust the start position.
- To cancel, press ▲ or ▼ to choose ⏪ (Back) and press the OK button.

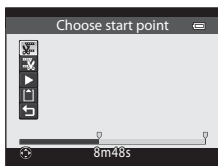

4 Press ▲ or ▼ to choose ⏭ (Choose end point).

- Rotate the multi selector or press ◀ or ▶ to move the end point at the right end to the end position of the required section.
- To check the playback of the movie in the specified range before saving it, choose ▶ (Preview) and press the OK button. During preview playback, the volume can be adjusted with the zoom control T/W. Use the multi selector to fast forward or rewind. To stop the preview playback, press the OK button.

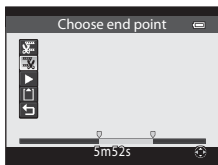

5 After finishing the settings, press ▲ or ▼ to choose ☑ (Save) and press the OK button.

6 Choose **Yes** and press the OK button.

- The edited movie is saved.
- To cancel the saving, choose **No**.

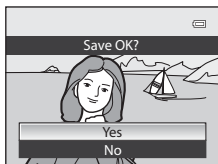

✓ Notes on Editing Movies



- Once a movie is created through editing, it cannot be used again for extracting a movie. To extract another range, select and edit the original movie.
- Because the edited movies are extracted in 1-second units, they may vary slightly from the set start point and end point. Sections shorter than two seconds cannot be extracted.
- Editing functions are not available when there is not enough free space in the internal memory or on the memory card.

✎ More Information





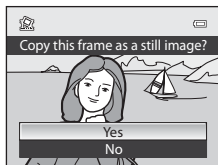
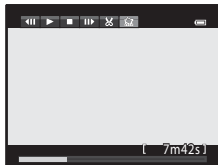

See "File and Folder Names" (📖99) for more information.

Saving a Frame from a Movie as a Still Picture

A screen from a recorded movie can be extracted and saved as a still picture.

- Pause a movie and display the screen to be extracted (📖102).
- Choose  on the playback control with the multi-selector ◀ or ▶ and press the  button.
- When the confirmation dialog is displayed, choose **Yes** and press the  button to save. To cancel the saving, choose **No**.
- The still picture is saved with **Normal** as the image quality. The image size is determined by the type (image size) (📖42) of the original movie.



Movie type	Size of still picture
 HD 720p (1280×720)	 (1280×720)
 VGA (640×480)	 (640×480)
 QVGA (320×240)	 (320×240)

✎ Note on Saving a Still Picture

A black frame is displayed around the picture saved with  (320×240) during playback.

Quick Menu

QUAL Image Quality and Image Size

To set the image quality and image size, see “Changing the Image Quality and Image Size” (📖74).

ISO Sensitivity (Setting the ISO sensitivity)

Rotate the mode dial to **P, S, A or M** → ISO (Quick menu dial) (📖72) → ISO sensitivity

The higher the ISO sensitivity, the less light needed for taking pictures.

The higher the ISO sensitivity, the darker the subject that can be shot. Additionally, even with subjects of similar brightness, pictures can be taken at faster shutter speeds, and blurring caused by camera shake and subject movement can be reduced.

- Setting the ISO sensitivity to a high level is effective when shooting dark subjects, not using the flash, shooting at the telephoto zoom position and similar situations, but the pictures taken may be slightly grainy.

1 Press the multi selector ◀ or ▶ to choose the ISO sensitivity setting.

- Items can also be chosen by rotating the main command dial.
- Press the multi selector ▼ when the ISO sensitivity is set to **Auto, High ISO sensitivity auto, ISO 100-200** or **ISO 100-400** to proceed to step 2.
- If the ISO sensitivity is fixed, proceed to step 3.



2 Choose the minimum shutter speed.

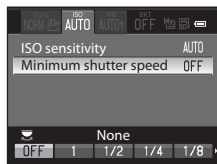

- Press the multi selector ▲ to return to the ISO sensitivity setting.





3 After completing the settings, press the quick menu button or the OK button.

- The monitor display reverts to shooting screen.

Types of ISO Sensitivity

Option	Description
ISO sensitivity	<ul style="list-style-type: none"> • AUTO Auto (default setting): The sensitivity is ISO 100 in bright places; in dark places the camera automatically raises the sensitivity to a maximum of ISO 800. •  High ISO sensitivity auto: The ISO sensitivity is set automatically within the range of ISO 100 to 1600 according to the brightness of the subject. •  ISO 100-200,  ISO 100-400 (fixed range auto): Choose the range in which the camera automatically adjusts ISO sensitivity. The camera does not raise sensitivity beyond the maximum value in the selected range. Set the maximum value for ISO sensitivity to control "grain" that appears in images. • 100, 200, 400, 800, 1600, 3200, Hi 1 (equivalent to ISO 6400): ISO sensitivity is locked at the specified value.
Minimum shutter speed	<p>When the shooting mode is P or A and ISO sensitivity is set to Auto, High ISO sensitivity auto, ISO 100-200 or ISO 100-400, the shutter speed at which the ISO sensitivity automatic control starts to function (1/125 to one second) is set. The default setting is None. If the exposure is insufficient with the shutter speed that is set here, the ISO sensitivity is increased automatically to obtain the correct exposure. If the exposure is still insufficient even after the ISO sensitivity is increased, the shutter speed slows down.</p>



The icon for the current setting is displayed on the monitor (□8).

- When **Auto** is selected, the  icon is not displayed at ISO 100, but is displayed if the ISO sensitivity automatically increases to more than 100 (□30).
- When **High ISO sensitivity auto** is selected, the  icon is displayed. When **ISO 100-200** or **ISO 100-400** is selected, the  icon and the maximum ISO sensitivity value are displayed.

Notes on ISO Sensitivity

- In **M** (manual) mode, ISO sensitivity is fixed at ISO 100 if **Auto**, **High ISO sensitivity auto**, **ISO 100-200** or **ISO 100-400** is selected.
- This feature may not be used in combination with certain features. See "Features That Cannot Be Used Simultaneously" (□80) for more information.



WB White Balance (Matching Image Colors with Colors as Seen with the Naked Eye)

Rotate the mode dial to P, S, A, M,  or  → WB (Quick menu dial) (📄72) → White balance

The color of light reflected from an object varies with the color of the light source. The human brain is able to adapt to changes in the color of the light source, with the result that white objects appear white whether seen in the shade, direct sunlight, or under incandescent lighting. Digital cameras can mimic this adjustment of the human eye by processing images according to the color of the light source. This is known as “white balance.” For natural coloration, choose a white balance setting that matches the light source before shooting.

Although the default setting, **Auto (normal)**, can be used under most types of lighting, you can apply the white balance setting suited to a particular light source to achieve more accurate results.

1 Press the multi selector ◀ or ▶ to choose the type of white balance.

- Items can also be chosen by rotating the main command dial.
- When  is chosen, set the color temperature (🔌34) using **Choose color temp.**
- To perform fine adjustment of the white balance setting, choose **Fine-tune** and press the  button.

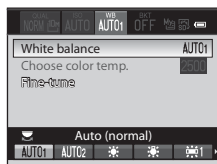

2 After completing the settings, press the quick menu button or the button.

- The monitor display reverts to shooting screen.

Fine Adjustment of White Balance

Press the multi selector ▲, ▼, ◀ or ▶ to set fine adjustment value.







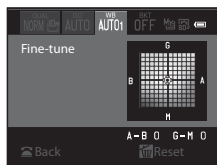

- The four directions are A (amber), B (blue), G (green) and M (magenta), and fine adjustment can be performed in six levels in all directions.
- When the  button is pressed, the fine adjustment value is reset to the center (coordinate 0, 0).
- Rotate the sub-command dial to return to the screen in step 1.

The color displayed in the fine-tune screen for white balance represents the approximate color in the color temperature direction.

When a color is set in the fine-tune screen, it may not be reproduced exactly in the image. For example, when the white balance is set to **Incandescent**, the image will not have a strong blue color even if fine adjustment is performed in the B (blue) direction.





Types of White Balance

Option	Description
AUTO1 Auto (normal) (default setting)	The white balance is automatically adjusted to suit the lighting conditions. Default setting is suitable for most situations. When set to Auto (warm lighting) , the images are preserved with warm colors if they are shot under an incandescent light source. When using the flash, according to the brightness of the flash, the images are adjusted to suitable white balance.
AUTO2 Auto (warm lighting)	
 Daylight	The white balance is adjusted for direct sunlight.
 Incandescent	Use under incandescent lighting.
 Fluorescent (FL1 to FL3)	Use under most types of fluorescent lighting. Choose one of FL1 (white fluorescent), FL2 (daylight white/neutral fluorescent) and FL3 (daylight fluorescent).
 Cloudy	Use when shooting under overcast skies.
 Flash	Use with the flash.
 Choose color temp.	Use to directly specify the color temperature ( 34).
PRE Preset manual (1 to 3)	Useful when shooting under unusual lighting. See "Using Preset Manual" ( 35) for more information.

The icon for the current setting other than **Auto (normal)** is displayed on the monitor (8).

Notes on White Balance

- At white balance settings other than **Auto (normal)**, **Auto (warm lighting)** or **Flash**, set the flash mode to  (off) (61).
- This feature may not be used in combination with certain features. See "Features That Cannot Be Used Simultaneously" (80) for more information.

Color Temperature

The perceived color of a light source varies with the viewer and other conditions. Color temperature is an objective measure of the color of a light source, defined with reference to the temperature to which an object would have to be heated to radiate light in the same wavelengths. While light sources with a color temperature in the neighborhood of 5000–5500K appear white, light sources with a lower color temperature, such as incandescent light bulbs, appear slightly yellow or red. Light sources with a higher color temperature appear tinged with blue. The camera white balance options are adapted to the following color temperatures.

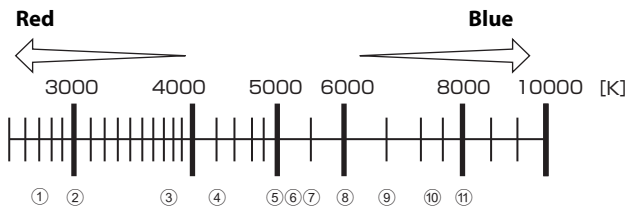

- | | |
|--|-----------------------------------|
| ① Sodium-vapor lamps: 2700K | ⑦ Flash: 5400K |
| ② Incandescent/
Warm-white fluorescent: 3000K | ⑧ Cloudy: 6000K |
| ③ White fluorescent: 3700K | ⑨ Daylight fluorescent: 6500K |
| ④ Cool-white fluorescent: 4200K | ⑩ High temp. mercury-vapor: 7200K |
| ⑤ Day white fluorescent: 5000K | ⑪ Shade: 8000K |
| ⑥ Direct sunlight: 5200K | |

Using Preset Manual

Use when you want to make pictures taken under unusual lighting conditions (such as lamps with reddish light) look as though they were shot in normal light. Use the procedure below to shoot after measuring the white balance value under the shooting light.

- Up to three preset values can be saved: PRE1, PRE2 and PRE3.

1 Place a white or gray reference object under the lighting that will be used during shooting.

2 Display the white balance quick menu (🔍32) and press the multi selector ◀ or ▶ to choose PRE1, PRE2 or PRE3.

- Items can also be chosen by rotating the main command dial.

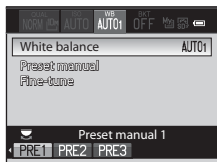

3 Press ▼ to choose **Preset manual** and press ◀ or ▶ to choose **PRE**.

- The lens extends to the zoom position for measurement.

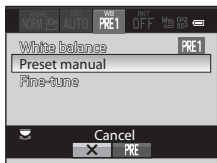

4 Frame a white or gray reference object in the reference object frame and press the OK button.

- The shutter is released and the new white balance preset value is set (no picture is recorded).

✓ Notes on Preset Manual

- The camera cannot measure a white balance value for when the flash fires. When shooting with the flash, set **White balance** to **Auto (normal)**, **Auto (warm lighting)** or **Flash**.
- When a wide-angle converter is mounted, preset manual cannot be used. Further, the preset value cannot be measured.

📎 Using the Previously Measured White Balance Value

Choose X in step 3. The most recently measured value is set for white balance, without performing measurement again.

📎 Performing Fine Adjustment for the Measured White Balance Value

After selecting preset PRE1, PRE2 or PRE3, select **Fine-tune** and press the OK button to perform fine adjustment for white balance (🔍32).

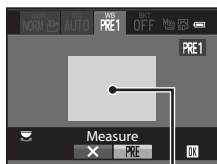

Reference object frame

BKT Bracketing (Continuous Shooting While Changing the Shutter Speed, ISO Sensitivity and White Balance)

Rotate the mode dial to **P**, **S**, **A** or **M** → **BKT** (Quick menu dial) (L72) → **Auto bracketing**

Continuous shooting can be performed while changing the exposure (brightness) automatically with the shutter speed (Tv) or ISO sensitivity (Sv), or multiple pictures can be recorded while varying the white balance (WB). This is effective when adjusting the brightness of an image is difficult, or when multiple light sources are mixed together and it is difficult to decide the white balance.

1 Press the multi selector ◀ or ▶ to choose the type of bracketing, and press ▼.

- Items can also be chosen by rotating the main command dial.

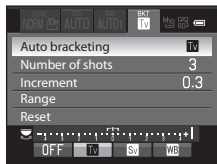

2 Choose the number of pictures to shoot and press ▼.

- 3 or 5 pictures can be chosen.

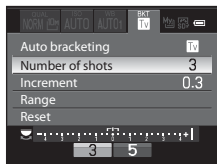

3 Choose the range of increment correction and press ▼.

- For **Tv** (exposure bracketing (Tv)) or **Sv** (exposure bracketing (Sv)), choose **0.3**, **0.7** or **1**.
- For **WB** (white balance bracketing), choose **1**, **2** or **3**.

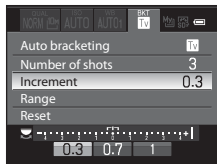

4 Choose the bracketing range and press the quick menu button or the OK button.

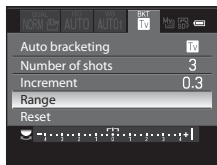

- The monitor display reverts to shooting screen.
- To change the values to the default setting, select **Reset** and press the OK button.



More Information

See "Reverse Indicators" (94) for more information.

Types of Auto Bracketing

	Option	Description
	OFF (default setting)	Bracketing is not performed.
	Exposure bracketing (Tv)	Set the number of pictures to shoot continuously, the range of exposure increments, and the bracketing range. When the shutter-release button is pressed all the way, pictures are shot continuously while the shutter speed is adjusted automatically. <ul style="list-style-type: none"> • "Tv" means "Time value."
	Exposure bracketing (Sv)	Set the number of pictures to shoot continuously, the range of ISO sensitivity increments, and the bracketing range. When the shutter-release button is pressed all the way, pictures are shot continuously while changing the ISO sensitivity, with the shutter speed and aperture value fixed. <ul style="list-style-type: none"> • "Sv" means "Sensitivity value."
	White balance bracketing	Set the number of pictures to record, the range of color temperature compensation increments, and the bracketing range. When the shutter-release button is pressed all the way, one picture is shot, and the set number of pictures is recorded with the color temperature changed for each one.

The icon for the current setting other than **OFF** is displayed on the monitor (📖8).

Notes on Auto Bracketing







- **Exposure bracketing (Tv)** and **Exposure bracketing (Sv)** are not available in **M** (manual) mode.
- **Exposure bracketing (Tv)** is not available in **S** (Shutter-priority auto) mode.
- When exposure compensation (📖71) and **Exposure bracketing (Tv)** are set simultaneously, the combined exposure compensation is applied.
- In **White balance bracketing**, only compensation for the color temperature (horizontal direction from A (amber) to B (blue)) is performed. Compensation in the vertical direction from G (green) to M (magenta) is not performed.
- This feature may not be used in combination with certain features. See "Features That Cannot Be Used Simultaneously" (📖80) for more information.

Picture Control (COOLPIX Picture Control) (Changing the Settings for Image Recording)

Rotate the mode dial to **P**, **S**, **A** or **M** →  (Quick menu dial) (📖72)

Change the settings for image recording according to the shooting scene or your preferences. Sharpness, contrast and saturation can be adjusted in detail.

Types of COOLPIX Picture Control

Option	Description
 Standard (default setting)	Standard processing for balanced results. Recommended for most situations.
 Neutral	Minimal processing for natural results. Choose for pictures that will later be extensively processed or retouched.
 Vivid	Pictures are enhanced for a vivid, photoprint effect. Choose for pictures that emphasize primary colors, such as blue, red, and green.
 Monochrome	Take monochrome photographs such as in black-and-white or sepia.
 Custom 1*	Change to the setting for Custom 1 in COOLPIX Custom Picture Control.
 Custom 2*	Change to the setting for Custom 2 in COOLPIX Custom Picture Control.

* Only displayed when the setting customized in **Custom Picture Control** (🔗43) has been registered.

The icon for the current setting other than **Standard** is displayed on the monitor (📖8).

COOLPIX Picture Control

- The COOLPIX Picture Control feature of the COOLPIX P7100 cannot be used with other makes of cameras, Capture NX, Capture NX 2 and ViewNX 2 Picture Control feature.
- This feature may not be used in combination with certain features. See "Features That Cannot Be Used Simultaneously" (📖80) for more information.

Customizing Existing COOLPIX Picture Controls: Quick Adjust and Manual Adjust

COOLPIX Picture Control can be customized using Quick adjust, which allows for balanced adjustment of sharpness, contrast, saturation and other image editing components, or manual adjust, which allows for detailed adjusting of the components individually.

1 Use the multi selector to choose the type of COOLPIX Picture Control and press the **OK** button.

- Items can also be chosen by rotating the main command dial.

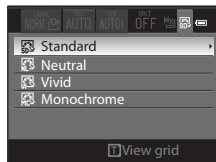

2 Press **▲** or **▼** to highlight the desired setting (e.g. 40) and press **◀** or **▶** to choose a value.

- Press the **OK** button to set the value.
- When COOLPIX Picture Controls are modified from the default settings, an asterisk (*) is displayed after the options in the Picture Control Setting menu.
- To change the values to the default setting, select **Reset** and press the **OK** button.

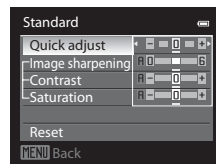

View Grid of COOLPIX Picture Control

When the zoom control is rotated toward **T** (Q) while the screen in step 1 of the above procedure is displayed, the contrast and saturation are displayed using a grid. The vertical axis indicates the contrast level, and the horizontal axis indicates the saturation. Rotate the zoom control toward **T** (Q) again to return to the previous screen.

The COOLPIX Picture Control grid displays the current and default settings in relation to the other COOLPIX Picture Controls.

- Rotate the multi selector to change to other COOLPIX Picture Controls.
- Press the **OK** button to display the COOLPIX Picture Control Setting screen (step 2 above).
- For **Monochrome**, the grid is displayed for contrast only.
- The grid is also displayed when adjusting **Contrast** or **Saturation** with manual adjustment.

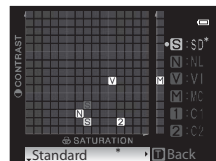

Types of Quick Adjust and Manual Adjust

Option	Description
Quick adjust ¹	Adjust the sharpness, contrast and saturation levels automatically. Five levels of adjustment are available from -2 to +2 . Choose from options between -2 and +2 to reduce or emphasize the effect of the selected COOLPIX Picture Control. The default setting is 0 .
Image sharpening	Control how much outlines are sharpened during shooting. Choose A (auto) to adjust sharpening automatically, or choose from seven levels of adjustment between 0 (no sharpening) and 6 . The higher the number, the sharper the image, and the lower the number, the softer the image. The default setting is 3 for Standard or Monochrome , 2 for Neutral and 4 for Vivid .
Contrast	Control the contrast. Choose A (auto) to adjust the contrast automatically according to the type of scene, or choose from seven levels of adjustment between -3 and +3 . – makes it into an image with a softer appearance, and + gives it a harder appearance. Choose lower values to prevent highlights in portrait subjects from being “washed out” in direct sunlight, higher values to preserve detail in misty landscapes and other low-contrast subjects. The default setting is 0 .
Saturation ²	Control the vividness of colors. Choose A (auto) to adjust saturation automatically according to the type of scene, or seven levels of adjustment can be done by choosing from values between -3 and +3 . Setting to the – side reduces the vividness, and setting to the + side increases the vividness. The default setting is 0 .
Filter effects ³	Simulate the effect of color filters on monochrome photographs. Choose from Off (the default setting), Y (yellow), O (orange), R (red), and G (green). Y, O, R: Enhance contrast. Can be used to tone down the brightness of the sky in landscape photographs. The contrast is strengthened in the order Y → O → R . G: Soften skin tones. Suitable for portraits.

Option	Description
Toning ³	Control the tint used in monochrome photographs from B&W (black-and-white, the default setting), Sepia , and Cyanotype (blue-tinted monochrome). Pressing the rotary multi selector ▼ when Sepia or Cyanotype is selected enables you to choose from seven levels of saturation. Press ◀ or ▶ to adjust the saturation.

- 1 Quick adjust is not available in **Neutral**, **Monochrome**, **Custom 1** and **Custom 2**. The values set manually are disabled if quick adjust is used after manual setting.
- 2 Not displayed for **Monochrome**.
- 3 Only displayed for **Monochrome**.

✔ Note on Image sharpening

The effects of **Image sharpening** cannot be previewed on the monitor during shooting. Check the results in playback mode.

✔ Note on Contrast

When **Active D-Lighting** (656) is set to settings other than **Off**, the  mark is displayed for **Contrast** and Contrast cannot be adjusted.

✔ Contrast, Saturation and A (Auto)

- Results for contrast and saturation vary with the exposure, and the position and size of the subject in the frame.
- The setting for the COOLPIX Picture Control which has **A** (auto) selected for either **Contrast** or **Saturation** is displayed in green in the COOLPIX Picture Control grid.

Options that Can Be Adjusted in Custom 1 and Custom 2

The option of the original COOLPIX Picture Control can be adjusted if **Custom 1** or **Custom 2** is selected.

QUAL Movie Options (Changing the Type of Movie to Shoot)

Rotate the mode dial to  → QUAL (Quick menu dial) (📖72) → Movie options

You can choose the type of movie to shoot. The higher the image size and bit rate, the higher the image quality, but the file size also becomes larger.

1 Press the multi selector ◀ or ▶ to choose the movie type.

- The maximum movie length for the selected movie type is displayed.
- Items can also be chosen by rotating the main command dial.

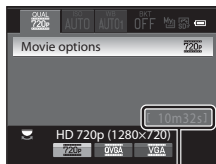



Maximum movie length

2 After completing the settings, press the quick menu button or the button.

- The monitor display reverts to shooting screen.

Image Size

Option	Description
 HD 720p (1280×720) (default setting)	Movies with an aspect ratio of 16:9 are recorded. <ul style="list-style-type: none"> • Movie bitrate: 9 Mbps
 VGA (640×480)	Movies with an aspect ratio of 4:3 are recorded. <ul style="list-style-type: none"> • Movie bitrate: 3 Mbps
 QVGA (320×240)	Movies with an aspect ratio of 4:3 are recorded. <ul style="list-style-type: none"> • Movie bitrate: 640 kbps

- The movie bitrate is the volume of movie data recorded per second. As a variable bitrate (VBR) system has been adopted, the movie recording rate varies automatically according to the subject so that more data is recorded per second for movies containing frequently moving subjects, thus increasing movie file size.
- The frame rates are approximately 24 frames per second (fps) for **HD 720p (1280×720)** and 30 frames per second (fps) for **VGA (640×480)** or **QVGA (320×240)**.

More Information

See "Maximum Movie Length" (📖100) for more information.

Shooting Menu (P, S, A or M Mode)

Custom Picture Control (COOLPIX Custom Picture Control)

Rotate the mode dial to P, S, A or M → MENU button → P, S, A or M tab (📖13) → Custom Picture Control

The picture editing options created by customizing COOLPIX Custom Picture Controls can be registered up to two options. The registered options can be displayed as **Custom 1** and **Custom 2** in COOLPIX Custom Picture Control.

Creating COOLPIX Custom Picture Controls

- 1 Use the multi selector to choose **Edit and save** and press the **OK** button.

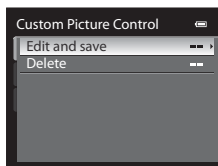

- 2 Choose the original COOLPIX Picture Control (📷39) to be edited, and press the **OK** button.

- 3 Press **▲** or **▼** to highlight the desired setting and press **◀** or **▶** to choose a value (📷39).

- The options are the same as those for adjusting the COOLPIX Picture Control.
- Press the **OK** button to display the save as screen.
- To change the values to the default setting, select **Reset** and press the **OK** button.

- 4 Choose the registration destination and press the **OK** button.

- The COOLPIX Custom Picture Control is registered.
- **Custom 1** or **Custom 2** can be selected from the **Picture Control** and **Custom Picture Control** selection screen after registration.

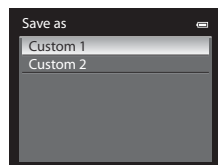

Deleting COOLPIX Custom Picture Controls

Select **Delete** in step 1 of “Creating COOLPIX Custom Picture Controls” to delete a registered Custom Picture Control.

Metering

Rotate the mode dial to P, S, A, M or → MENU button → P, S, A, M or tab (📖13)
→ Metering

The process of measuring the brightness of the subject to determine the exposure is known as “metering.”

Use this option to choose how the camera meters exposure.

Option	Description
Matrix (default setting)	Use a wide area of the screen for metering. This metering mode provides the appropriate exposure for a variety of shooting conditions. Recommended for typical shooting.
Center-weighted	The camera meters the entire frame but assigns greatest weight to the subject at the center of the frame. The classic metering for portraits; it preserves background details while letting lighting conditions at the center of the frame determine exposure. Can be used with focus lock (📖33) to meter off-center subjects.
Spot	The camera meters the area shown by the circle in the center of the frame. This can be used when the subject metering target is lighter or darker than the background. Ensure that the subject is within the area shown by the circle when shooting. Can be used with focus lock (📖33) to meter off-center subjects.
Spot AF area	The camera meters the selected focus area to determine the exposure. Available only when Face priority or Manual is selected for AF area mode (📖48).

✔ Notes on Metering

- When the digital zoom is in effect, at magnifications of 1.2x to 1.8x, **Metering** is set to **Center-weighted**, and at magnifications of 2.0x to 4.0x, it is set to **Spot**. Note that when the digital zoom is in effect, the metered area is not displayed on the monitor.
- This feature may not be used in combination with certain features. See “Features That Cannot Be Used Simultaneously” (📖80) for more information.

Metering in Low Noise Night Mode

Metering can be set even in low noise night mode (📖50). This setting is stored in the camera's memory independently and is not applied to **Metering** in shooting modes P, S, A and M.









Metering Area

The active metering area is displayed when **Center-weighted** or **Spot** is selected for **Metering** (📖8).

Continuous Shooting

Rotate the mode dial to P, S, A, M or  → MENU button → P, S, A, M or  tab (📖13)
→ Continuous

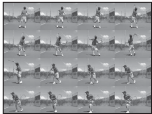
Change the settings for continuous shooting and BSS (Best Shot Selector).

Option	Description
 Single (default setting)	One picture is shot each time the shutter-release button is pressed.
 Continuous	Keep pressing the shutter-release button all the way, and up to 90 pictures are shot at a rate of about 1.2 frames per second (fps) when image quality is set to Normal and image size is set to  3648x2736 .
 Continuous flash	Keep pressing the shutter-release button all the way, and continuous shooting is performed using the built-in flash (approximately three frames continuously at a rate of about 1.0 frame per second when image quality is set to Normal and image size is set to  3648x2736). The camera charges the built-in flash once continuous shooting ends. No shooting can be performed until the charging ends. Because the ISO sensitivity is raised during shooting, pictures may be slightly grainy.
BSS BSS (Best Shot Selector)	BSS is recommended for shooting under low lighting without the flash, with the camera zoomed in, or in other situations in which camera shake is likely to blur pictures. Keep pressing the shutter-release button all the way, and up to ten pictures are shot and the camera automatically selects and saves only the sharpest picture in the series.
 Multi-shot 16	Each time the shutter-release button is pressed all the way, the camera shoots 16 pictures at a rate of about 30 frames per second and arranges them in a single picture. <ul style="list-style-type: none"> The image quality is fixed at Normal and the image size is fixed at  (2560 × 1920 pixels). The digital zoom is not available. 
 Intvl timer shooting	The camera shoots still pictures automatically at the specified interval ( 46).

The icon for the current setting other than **Single** is displayed on the monitor (📖8).

Shooting Menu (P, S, A or M Mode)

✔ Notes on Continuous Shooting

- Focus, exposure and white balance are fixed at the values determined with the first shot in each series.
- The frame rate may become slower depending on the image quality, image size, memory card type or shooting conditions.
- When **ISO sensitivity** (🔍30) is set to **3200** or **Hi 1**, the frame rate becomes slower.
- This feature may not be used in combination with certain features. See “Features That Cannot Be Used Simultaneously” (📖80) for more information.
- For details about using the built-in flash and the Speedlight (external flash unit) (available separately), see “Features That Cannot Be Used Simultaneously” (📖80).
- Do not raise or lower the built-in flash during continuous shooting. Shooting stops if the built-in flash is raised or lowered.

✔ Note on Continuous Flash

The continuous flash cannot be used when the built-in flash is lowered. Raise the built-in flash when using the continuous flash to shoot.

✔ Note on Best Shot Selector

BSS is suited for shooting stationary subjects. BSS may not produce the desired results if the subject moves or the composition changes.

✔ Note on Multi-shot 16

Smear (🔍3) visible in the monitor when shooting with Multi-shot 16 enabled will be recorded with images. Avoiding bright objects such as the sun, reflections of the sun, and electric lights when shooting with Multi-shot 16 enabled is recommended.

📌 Continuous Shooting in Low Noise Night Mode

Continuous can be set to **Single** or **Continuous** even in low noise night mode (📖50). This setting is stored in the camera's memory independently and is not applied to **Continuous** in shooting modes **P, S, A** and **M**.

Interval Timer Shooting

Rotate the mode dial to **P, S, A** or **M** → **MENU** button → **P, S, A** or **M** tab (📖13) → **Continuous**

Choose from **30 s**, **1 min**, **5 min**, or **10 min**.

- 1 Use the multi selector to select **Intvl timer shooting** for the **Continuous** setting, and then press the **OK** button.

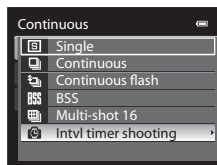

2 Choose the interval between each shot and press the **OK** button.

- The maximum amount of frames that can be taken during interval timer shooting differs according to the interval taken between each shot.
 - 30 s:** 600 images
 - 1 min:** 300 images
 - 5 min:** 60 images
 - 10 min:** 30 images

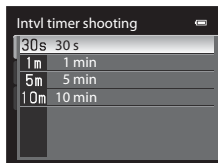

3 Press the **MENU** button.

- The camera returns to shooting screen.

4 Press the shutter-release button all the way to shoot the first picture and start interval timer shooting.

- The monitor is turned off and the power-on lamp blinks between shots.
- The monitor reactivates automatically immediately before the next picture is shot.

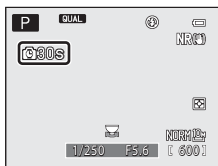

5 Press the shutter-release button all the way again to finish shooting.

- Shooting finishes automatically if the internal memory or memory card becomes full, or when the number of shot frames reaches the upper limit.



✓ Notes on Interval Timer Shooting

- To prevent the camera from turning off unexpectedly during shooting, use a fully charged battery.
- To power the camera continuously for extended periods, use the AC Adapter EH-5b and the Power Connector EP-5A (available separately) (●●103). Do not, under any circumstances, use an AC Adapter other than the EH-5b or a Power Connector other than the EP-5A. Failure to observe this precaution could result in overheating or damage to the camera.
- Do not rotate the mode dial to a different setting while performing interval timer shooting.

📎 More Information



See "File and Folder Names" (●●99) for more information.







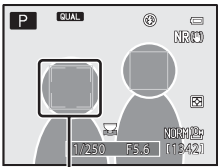

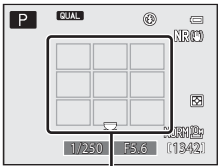

AF Area Mode

Rotate the mode dial to **P, S, A, M, EFFECTS** or  → **MENU** button → **P, S, A, M, ** or  tab (📖13) → **AF area mode**



You can set how the camera selects the focus area for autofocus.

- The AF area mode can also be selected by pressing the multi selector ► (⊕) (📖60, 📷86).

Option	Description	
 Face priority	<p>The camera automatically detects and focuses on a face (see “Using Face Detection” (📖85) for more information).</p> <p>If the camera detects multiple faces, the camera focuses on the face closest to the camera.</p> <p>When non-human subjects are photographed, or a subject with which no face can be detected is framed, AF area mode is set to Auto. The camera automatically selects one or more of the nine focus areas containing the subject closest to the camera.</p> <ul style="list-style-type: none"> • When the monitor is turned off, the focus area is fixed at the Center (normal). 	 <p style="text-align: center;">Focus area</p>
 Auto (default setting)	<p>The camera automatically selects one or more of the nine focus areas containing the subject closest to the camera.</p> <p>Press the shutter-release button halfway to activate the focus area. When the shutter-release button is pressed halfway, the focus area selected by the camera is displayed on the monitor (up to nine areas).</p> <ul style="list-style-type: none"> • When the monitor is turned off, the focus area is fixed at the Center (normal). 	 <p style="text-align: center;">Focus areas</p>

Option	Description
<p> Manual</p>	<p>Choose manually the focus position from 99 areas in the screen. This option is suited to situations in which the intended subject is relatively still and not positioned at the center of the frame. Rotate the multi selector or press ▲, ▼, ◀ or ▶ to select one of 99 focus areas displayed on the monitor's focus-area selection screen, and shoot.</p> <ul style="list-style-type: none"> To adjust the following settings, press the  button to temporarily cancel focus area selection, and then adjust each setting. <ul style="list-style-type: none"> Flash mode, focus mode or self-timer To return to the focus area selection screen, press the  button again. At an Image size setting () of  2736×2736, 81 focus areas are available.
<p> Center (spot),  Center (normal),  Center (wide)</p>	<p>The camera focuses on the subject at the center of the frame. The focus area is always displayed at the center of the frame. Three sizes are available for the focus area.</p>
<p> Subject tracking</p>	<p>Subject tracking begins once you select a subject to be focused on, and the focus area will move and follow the subject. See “Subject Tracking Mode (Focusing on a Moving Subject)” (50).</p>

Notes on AF Area Mode

- When the digital zoom is in effect, the camera focuses on the subject at the center of the frame regardless of the applied **AF area mode** option.
- In some rare cases of shooting subjects for which autofocus does not perform as expected ()33), the subject may not be in focus.
- This feature may not be used in combination with certain features. See “Features That Cannot Be Used Simultaneously” ()80) for more information.

Subject Tracking Mode (Focusing on a Moving Subject)

Rotate the mode dial to P, S, A, M or  → MENU button → P, S, A, M or  tab (📖13)
→ AF area mode

Choose this mode to shoot moving subjects. Subject tracking begins once you select a subject to be focused on, and the focus area will move and follow the subject.

- This function can be used when the shooting mode is P, S, A, M, U1, U2, U3 or  (low noise night).

1 Rotate the multi selector to select Subject tracking and press the button.

- The camera enters subject tracking mode, and a white border is displayed at the center of the frame.

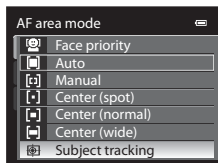

2 Frame the subject at the center of the border, and press the button.

- The subject is registered.
- When the camera is unable to focus on the subject, the border lights in red. Change the composition and try again.
- Once the subject is registered, it is framed by a yellow focus area display, and subject tracking begins.
- Press the  button to cancel the registration of the subject.
- If the camera loses sight of the subject, the focus area display disappears; register the subject again.

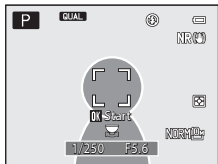



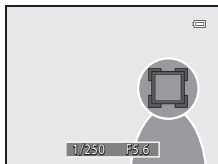

3 Press the shutter-release button all the way to take the picture.

- If the camera focuses on the subject when the shutter-release button is pressed halfway, the focus area display lights in green and the focus is locked.
- If the shutter-release button is pressed halfway while the focus area is not displayed, the camera focuses the subject at the center of the frame.



Notes on Subject Tracking

- The digital zoom is not available.
- Set the zoom position, flash mode, focus mode, or menu settings before registering a subject. If any of these are changed after a subject is registered, the subject will be canceled.
- During certain conditions, such as when the subject is moving quickly, when there is a large amount of camera shake, or when there are multiple subjects that look alike, the camera may not be able to register or track a subject, or the camera may track a different subject. Additionally, the subject may not be tracked properly depending on factors such as the subject's size and brightness.
- In some rare cases of shooting subjects for which autofocus does not perform as expected (33), the subject may not be in focus despite the fact that the focus area lights in green. If you cannot focus, change the AF area mode setting to **Manual**, **Center (spot)**, **Center (normal)** or **Center (wide)**, or try shooting with focus lock (33) by switching the shooting mode to a mode such as auto mode and refocusing on another subject at the same distance.
- In subject tracking, the monitor is not turned off even when the  button is pressed (15).
- This feature may not be used in combination with certain features. See "Features That Cannot Be Used Simultaneously" (80) for more information.

Autofocus Mode

Rotate the mode dial to P, S, A or M → MENU button → P, S, A or M tab (📖13) → Autofocus mode

Choose how the camera focuses.

Option	Description
AF-S Single AF (default setting)	The camera focuses only when the shutter-release button is pressed halfway.
AF-F Full-time AF	The camera focuses continuously until the shutter-release button is pressed down halfway. Use with moving subjects. A sound will be heard while the camera focuses.

Autofocus Mode for Movie Recording

Autofocus mode for movie recording can be set with **Autofocus mode** (🔍69) in the movie menu.

Flash Exp. Comp.

Rotate the mode dial to P, S, A, M or  → MENU button → P, S, A, M or  tab (📖13) → Flash exp. comp.

Flash compensation is used to adjust the flash output, changing the brightness of the subject relative to the background.

Option	Description
-0.3 to -2.0	The flash output is reduced from -0.3 to -2.0 EV, in increments of 1/3 EV, to prevent unwanted highlights or reflections.
0.0 (default setting)	The flash output is not adjusted.
+0.3 to +2.0	The flash output is increased from +0.3 to +2.0 EV, in increments of 1/3 EV, to make the main subject of the frame appear brighter.

The icon for the current setting other than **0.0** is displayed on the monitor (📖8).

Flash Exp. Comp. in Low Noise Night Mode

Flash exp. comp. can be set even in low noise night mode (📖50). This setting is stored in the camera's memory independently and is not applied to **Flash exp. comp.** in shooting modes P, S, A and M.

Noise Reduction Filter

Rotate the mode dial to **P, S, A or M** → MENU button → **P, S, A or M** tab (📖13) → Noise reduction filter

Set the strength of the noise reduction function that is normally performed when recording the picture.

- For noise at slow shutter speeds, set with **Long exposure NR** (🔍53).

Option	Description
NR⁺ High	Perform noise reduction at a level higher than the standard strength.
NR Normal (default setting)	Perform noise reduction at the standard strength.
NR⁻ Low	Perform noise reduction at a level lower than the standard strength.

The icon for the current setting other than **Normal** is displayed on the monitor (📖8).

Long Exposure NR

Rotate the mode dial to **P, S, A or M** → MENU button → **P, S, A or M** tab (📖13) → Long exposure NR

At slow shutter speeds, pictures may be affected by “noise” in the form of randomly-spaced, brightly-colored dots concentrated in dark parts of the image. Reduce noise at slow shutter speeds. Enabling long exposure NR increases the time needed to record pictures after they are shot.

Option	Description
AUTO Auto (default setting)	Noise reduction is performed at slow shutter speeds that are likely to result in pictures affected by noise.
ENR On	Noise reduction is applied to pictures shot at shutter speeds of 1/4 second or slower. Switching this to On is recommended when shooting at slow shutter speeds.

When long exposure NR is performed, the **ENR** icon is displayed on the monitor (📖8).

✔ Note on Long Exposure NR

This feature may not be used in combination with certain features. See “Features That Cannot Be Used Simultaneously” (📖80) for more information.

Distortion Control

Rotate the mode dial to **P, S, A or M** → **MENU** button → **P, S, A or M** tab (📖13) → Distortion control

Choose whether to correct the peripheral distortion that occurs due to the intrinsic characteristics of lenses. Enabling distortion control reduces the size of the frame, as compared to when distortion control is not enabled.

When **On** is selected, distortion is corrected.

- The default setting is **Off**.

When **On** is selected, an icon for this setting is displayed on the monitor (📖8).

Note on Distortion Control

This feature may not be used in combination with certain features. See “Features That Cannot Be Used Simultaneously” (📖80) for more information.

Wide-angle Converter



Rotate the mode dial to **P, S, A or M** → **MENU** button → **P, S, A or M** tab (📖13) → Wide-angle converter

Set when the Wide-angle Converter WC-E75A (0.75×) (available separately) is mounted. The Adapter Ring UR-E22 (available separately) is also required for mounting.

Option	Description
 On	Set when using the Wide-angle Converter WC-E75A. The angle of view when the WC-E75A is mounted is equivalent to about 21 mm in 35mm [135] format (when Distortion control is set to Off). The zoom lens is fixed at the wide-angle end. The digital zoom is not available.
OFF None (default setting)	Use when no converter lens is attached (be sure to remove the lens adapter ring and attach the lens ring).

When **On** is selected, an icon for this setting is displayed on the monitor (📖8).

Notes on the Wide-angle Converter for Shooting

- Set **Wide-angle converter** to **On** before shooting. Set **Wide-angle converter** to **None** when no converter lens is attached.
- The built-in flash is set to  (off) when **Wide-angle converter** is set to **On**. Use flash units (101) (available separately) to shoot with the flash.
- Using the flash units (available separately) may darken the peripheral area of the picture. Check the picture on the monitor after shooting. A wide-flash adapter is recommended when shooting with the Speedlight SB-600, SB-700, SB-800 or SB-900.
- AF-assist illuminator cannot be used when **Wide-angle converter** is set to **On**.
- This feature may not be used in combination with certain features. See “Features That Cannot Be Used Simultaneously” (80) for more information.

Installing and Removing the Lens Ring

- Before attaching the wide-angle converter, remove the lens ring. Before installing or removing the lens ring, be sure to turn off the camera. While pressing the lens ring release button, rotate the lens ring clockwise and remove it.
- To attach the lens ring to the camera, align the lens ring mounting index (white dot) with the lens ring release button, and then rotate the lens ring counterclockwise.
- When not using the wide-angle converter, be sure to attach the lens ring onto the camera.
- For more information on attaching the wide-angle converter, see the instruction manual provided with the wide-angle converter.

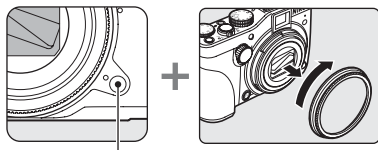

Lens ring release button

Flash Control

Rotate the mode dial to **P, S, A or M** → **MENU** button → **P, S, A or M** tab (13) → **Flash control**

You can set the built-in flash to off even when you are not using a Speedlight (external flash unit) (101) attached to the camera's accessory shoe.

Option	Description
AUTO Auto (default setting)	When a flash unit is mounted, the flash unit fires. When a flash unit is not used, the built-in flash fires.
OFF Built-in off	The built-in flash is disabled.

Note on Flash Control

This feature may not be used in combination with certain features. See “Features That Cannot Be Used Simultaneously” (80) for more information.

Active D-Lighting

Rotate the mode dial to **P, S, A or M** → **MENU** button → **P, S, A or M** tab (📖13) → Active D-Lighting

“Active D-Lighting” preserves details in highlights and shadows, creating photographs with natural contrast. The image taken reproduces the contrast effect that is seen with the naked eye. This is particularly effective for shooting scenes with high contrast, such as brightly lit outdoor scenery from a dark room or shaded subjects at a sunny seaside.

Option	Description
 High Normal Low	Set the level of the Active D-Lighting effect that is applied during shooting.
OFF Off (default setting)	Active D-Lighting is not applied.

The icon for the current setting other than **Off** is displayed on the monitor (📖8).

✓ Active D-Lighting

- Additional time is required to record images when shooting using Active D-Lighting.
- The exposure is reduced in comparison to shooting with Active D-Lighting set to **Off**. To ensure that the gradation is appropriate, adjustments of the highlighted areas, shadow areas and mid-tones are made before recording.
- This feature may not be used in combination with certain features. See “Features That Cannot Be Used Simultaneously” (📖80) for more information.

✓ Active D-Lighting Versus D-Lighting

The **Active D-Lighting** option in the shooting menu reduces exposure before shooting to optimize the dynamic range. The **D-Lighting** (📖11) option in the playback menu optimizes dynamic range in pictures taken.

Zoom Memory

Rotate the mode dial to P, S, A or M → MENU button → P, S, A or M tab (📖13) → Zoom memory

When the zoom control is operated while pressing the **Fn1** button, the camera changes in steps to the focal length (equivalent to 35mm [135] format of angle of view) of the zoom lens that is set in advance in **Zoom memory**. The following settings are available: **28 mm, 35 mm, 50 mm, 85 mm, 105 mm, 135 mm** and **200 mm**.

- Choose the focal length with the multi selector, and then press the **OK** button to set the check box to on or off.
- Multiple focal lengths can be chosen.
- The default setting is on for all the check boxes.
- To finish the setting, press the multi selector **◀**.

Notes on Zoom Operation

- Operate the zoom control while pressing the **Fn1** button to change the zoom position to focal length for which the zoom memory is set to on.
The changed focal length is the closest to that before the operation. To change the zoom position to the next focal length level, release the zoom control and then operate it again.
- Release your finger from the **Fn1** button when using the digital zoom.

✔ Clock battery

If the internal clock battery (🔋27) is exhausted, the settings saved in U1, U2 or U3 will be reset. Writing down any important setting is recommended.

📝 Confirmation Screen of User Settings

Rotate the zoom control toward **T** (🔍) to display the settings on the screen in step 4 (🔍58).

- 1 Shooting mode
- 2 Shutter speed
- 3 Aperture value
- 4 Flash mode
- 5 Flash exp. comp.
- 6 Flash control
- 7 AF area mode, autofocus mode, AF assist
- 8 Metering, continuous shooting mode, active D-Lighting
- 9 Noise reduction filter, long exposure NR
- 10 Zoom memory
- 11 Focus mode, focal length (35mm equiv.), distortion control, wide-angle converter
- 12 Photo info, virtual horizon display
- 13 Initial monitor display
- 14 Image quality, image size
- 15 ISO sensitivity
- 16 White balance
- 17 Auto bracketing
- 18 Picture Control

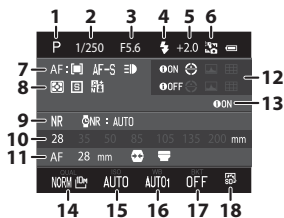

📝 Resetting for U1, U2 and U3

If **Reset user settings** is selected in specialized menu for U1, U2 or U3, the settings that are saved in the user settings are reset as follows:

- Specialized menus for U1, U2 and U3: **Shooting mode: P** Programmed auto, **Focal length (35mm equiv.): 28 mm**, **Photo info:** information hidden, **Virtual horizon display: Circle**, **Initial monitor display: Show info**, **Flash mode: 🔴** AUTO Auto, **Focus: AF** Autofocus, **AF area mode: 🔍** Auto, **AF assist: Auto**
- Shooting menu, quick menu: Same as the default setting for each item

The Playback Menu

For more information about image editing function; **Quick retouch**, **D-Lighting**, **Skin softening**, **Filter effects**, **Small picture**, **Black border**, **Straighten** and **NRW (RAW) processing**, see “Editing Still Images” (📖9).

🖨️ Print Order (Creating a DPOF Print Order)

Press the **MENU** button → 📷 tab (📖13) → 🖨️ Print order

If you choose to use one of the following methods to print pictures that are stored on a memory card, the pictures to print and the number of copies can be set in advance on the memory card.

- Printing with a DPOF-compatible (🔧16) printer that is equipped with a card slot.
- Ordering the prints from a digital photo lab that has a DPOF service.
- Printing by connecting the camera to a PictBridge-compatible (🔧16) printer (📖22). (When the memory card is removed from the camera, the print order can also be performed for the pictures stored on the internal memory.)

1 Use the multi selector to choose **Select images** and press the **OK** button.

- When list by date mode (📖88) is selected, the menu shown on the right is not displayed. Proceed to the step 2.

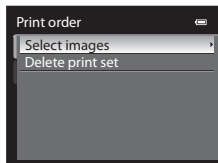

2 Choose the pictures (up to a maximum of 99) and number of copies (up to nine per picture).

- Rotate the multi selector or press ◀ or ▶ to choose the pictures, and press ▲ or ▼ to set the number of copies for each.
- Pictures can also be chosen by rotating the main command dial.
- Pictures selected for printing can be recognized by the check mark icon and the numeral indicating the number of copies to be printed. If no copies have been specified for images, the selection is canceled.
- Rotate the zoom control toward **T** (🔍) to switch to full frame playback mode, or **W** (🖼️) to switch to 12 thumbnails display.
- Press the **OK** button when setting is complete.



3 Choose whether or not to also print shooting date and shooting information.

- Choose **Date** and press the **OK** button to print the shooting date on all pictures in the print order.
- Choose **Info** and press the **OK** button to print shooting information (shutter speed and aperture value) on all pictures in the print order.
- Choose **Done** and press the **OK** button to complete the print order.

Pictures selected for printing are recognized by the  icon displayed in playback mode.

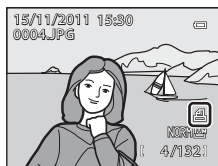
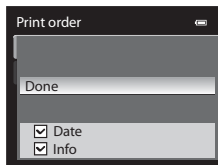

Notes on Printing Shooting Date and Shooting Information

When the **Date** and **Info** options are enabled in the print order menu, shooting date and shooting information are printed on pictures when a DPOF-compatible () printer which supports printing of shooting date and shooting information is used.

- Shooting information cannot be printed when the camera is connected directly to a printer, via the included USB cable, for DPOF printing (.
- **Date** and **Info** are reset each time the **Print order** menu is displayed.
- The date and time printed on the picture is the date and time recorded on the camera when the picture was taken. The date and time printed using this option are not affected if the camera's **Time zone and date** setting is changed from the setup menu after the pictures are taken.



✓ Notes on Print Order

- When setting a print order in list by date mode and pictures other than those on the chosen date are already set for printing, the screen shown on the right is displayed.
 - Select **Yes** to add the print order setting to the existing print order.
 - Select **No** to remove the existing print order and retain the print order setting.

Additionally, if there are more than 99 pictures as a result of adding the current print order settings, the screen shown on the right will be displayed.

- Select **Yes** to remove the existing print order and retain the print order setting.
- Select **Cancel** to retain the existing print order and remove the print order setting.

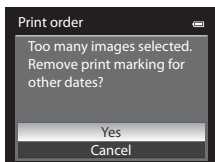
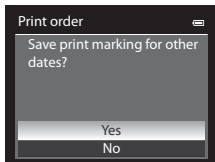

- NRW (RAW) pictures cannot be set for printing. Create a JPEG picture using **NRW (RAW) processing** (6017), and then set the JPEG picture for printing.

✂ Deleting All Print Orders

In step 1 of the print order procedure (6060), choose **Delete print order** and press the (OK) button to delete the print orders for all pictures.

✂ Print Date

The shooting date and time can be imprinted in pictures at the time of shooting by using **Print date** (6075) in the setup menu. This information can be printed even from printers that do not support printing of the date and time. Only the date and time of print date on the pictures are printed, even if **Print order** is enabled with the date selected in the print order screen.

✂ More Information



See "Printing Images of Size 1:1" (6079) for more information.

Slide Show

Press the **MENU** button →  tab (📖13) →  Slide show



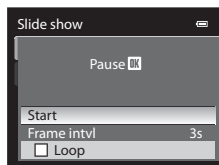

View pictures stored in the internal memory or on a memory card in an automatic slide show.

1 Use the multi selector to choose **Start** and press the button.

- To change the interval between pictures, choose **Frame intvl**, select the desired interval time, and press the  button before choosing **Start**.
- To repeat the slide show automatically, enable **Loop** and press the  button before choosing **Start**. The check mark () is added to the loop option when enabled.





2 The slide show begins.

- Press the multi selector  to display the next picture, or  to display the previous picture. Press and hold  to fast forward, or  to rewind.
- To exit partway or pause, press the  button.



3 Choose End or Restart.

- When exiting or pausing the slide show, the screen shown on the right is displayed. Choose  and press the  button to return to the playback menu. Choose  to play the slide show again.





Notes on Slide Shows

- Only the first frame of movies (📖102) included in slide shows is displayed.
- Slide shows play for a maximum of 30 minutes, even when **Loop** is selected (🎧82).



Delete

Press the MENU button →  tab ( 13) →  Delete

Delete a picture. Multiple pictures can also be deleted.

Option	Description
Erase selected images	In the image selection screen, choose the pictures for deletion. See “The Image Selection Screen” ( 65) for more information. <ul style="list-style-type: none"> When images saved with an Image quality ( 75) setting of NRW (RAW) + Fine, NRW (RAW) + Normal or NRW (RAW) + Basic are chosen, the NRW (RAW) and JPEG images are deleted at the same time.
Erase all images	Delete all pictures.
Erase selected NRW images	Only NRW (RAW) images are displayed in the picture selection screen. Select and delete images. <ul style="list-style-type: none"> For pictures where NRW (RAW) and JPEG images are recorded at the same time, only the NRW (RAW) image is deleted.
Erase selected JPEG images	Only JPEG images are displayed in the image selection screen. Select and delete pictures. <ul style="list-style-type: none"> For pictures where NRW (RAW) and JPEG images are recorded at the same time, only the JPEG image is deleted.

Notes on Deletion

- Once deleted, pictures cannot be recovered. Transfer important images to a computer before deletion.
- Pictures marked with the  icon are protected and cannot be deleted ( 66).
-  is displayed in the image selection screen for pictures where NRW (RAW) and JPEG images are recorded at the same time.

The Image Selection Screen

The image selection screen is displayed in the following menus.

Only one image can be selected for some menu items, while for other menu items, multiple images can be selected.

Functions for which only one image can be selected	Functions for which multiple images can be selected
<ul style="list-style-type: none"> • Playback menu: <ul style="list-style-type: none"> Quick retouch* (🔍11), D-Lighting* (🔍11), Skin softening* (🔍12), Filter effects* (🔍13), Rotate image* (🔍66), Small picture* (🔍14), Voice memo* (🔍67), Black border* (🔍15), Straighten* (🔍16), NRW (RAW) processing (🔍17) • Setup menu: <ul style="list-style-type: none"> Select an image in Welcome screen (🔍70) 	<ul style="list-style-type: none"> • Playback menu: <ul style="list-style-type: none"> Select images in Print order (🔍60), Erase selected images in Delete (🔍64), Protect (🔍66), Hide image (🔍66), Selected images in Copy (🔍68)

* These menus are displayed if menu items are selected when the playback menu has been displayed from a mode other than playback mode (📖13).

Follow the procedure described below to select images.

1 Rotate the multi selector, or press ◀ or ▶ to choose the desired image.

- Images can also be chosen by rotating the main command dial.
- Rotate the zoom control toward **T** (🔍) to switch to full-frame playback mode, or **W** (📐) to switch to 12 thumbnails display.
- For functions for which only one image is selected, proceed to step 3.



2 Press ▲ or ▼ to select or deselect (or the number of copies).

- When an image is selected, a check mark (☑) is displayed with the image. Repeat steps 1 and 2 to select additional images.



3 Press the (OK) button to apply the image selection.

- With selections such as Erase selected images, the confirmation dialog is displayed. Follow the instructions on the screen.

Protect

Press the MENU button →  tab (📖13) →  Protect



Protect selected pictures from accidental deletion.

In the picture selection screen, choose a picture and set or cancel protection. See “The Image Selection Screen” (🔍65) for more information.

Note, however, that formatting the camera’s internal memory or the memory card permanently erases the protected files (🔍83).

Protected pictures are recognized by the  icon in playback mode (📖10).

Rotate Image

Press the MENU button →  tab (📖13) →  Rotate image

Change the orientation of pictures played back in the camera’s monitor after shooting. Still pictures can be rotated 90° clockwise or counterclockwise.

Pictures that were recorded in the “tall” orientation can be rotated up to 180° in either direction.

Select a picture in the picture selection screen (🔍65) to display the rotate image screen. Rotate the multi selector, or press ◀ or ▶ to rotate the picture 90°.

Press the  button to set the orientation displayed and save the orientation data with the picture.

Hide Image

Press the MENU button →  tab (📖13) →  Hide image

Hide pictures so that they cannot be played back on the camera monitor.

In the picture selection screen, choose the pictures and set or cancel the hide setting. See “The Image Selection Screen” (🔍65) for more information.

Hidden pictures cannot be deleted using the **Delete** option. Note, however, that formatting the internal memory or memory card (🔍83) permanently erases the hidden pictures.

Voice Memo

Press the **MENU** button →  tab (📖13) →  Voice memo

Use the camera's microphone to record voice memos for pictures.

- The recording screen is displayed for a picture without voice memo, while the voice memo playback screen is displayed for a picture with voice memo (a picture marked with  in full-frame playback mode).

Recording Voice Memos

- Recording ends after about 20 seconds or when the **OK** button is released.
- Do not touch the microphone during recording.
- During recording, **REC** and  blink on the monitor.
- When recording ends, the voice memo playback screen is displayed.

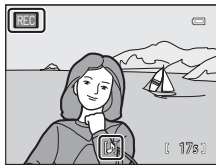



Playing Voice Memos

Pictures for which voice memos have been recorded are indicated by  in full-frame playback mode.

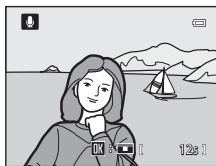
- Press the **OK** button to play back a voice memo. To end playback, press the **OK** button again.
- Rotate the zoom control toward **T** or **W** during playback to adjust playback volume.
- Press the multi selector  before or after playing a voice memo to return to the playback menu. Press the **MENU** button to exit the playback menu.



Deleting Voice Memos

Press the  button on the voice memo playback screen. Press the multi selector  or  to select **Yes** and press the **OK** button to delete only the voice memo.



Notes on Voice Memos

- When a picture with a voice memo attached is deleted, both the picture and its voice memo are deleted.
- Voice memos cannot be recorded for a picture that already has a voice memo attached on it. The current voice memo must be deleted before a new voice memo can be recorded.
- COOLPIX P7100 is not able to record a voice memo for a picture taken with cameras other than COOLPIX P7100.
- A voice memo of the image with the **Protect** setting () cannot be deleted.

More Information

See "File and Folder Names" () for more information.

☰ Copy (Copy Between Internal Memory and Memory Card)

Press the MENU button → tab (📖13) → ☰ Copy

Copy pictures between the internal memory and a memory card.

1 Use the multi selector to select an option from the copy screen and press the **OK** button.

- → : Copy pictures from the internal memory to the memory card.
- → : Copy pictures from the memory card to the internal memory.

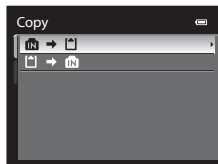

2 Select a copy option and press the **OK** button.

- **Selected images:** In the picture selection screen (🔍65), choose the pictures for copying.
- **All images:** Copy all pictures.

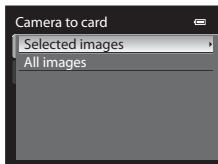

☑ Notes on Copying Pictures

- JPEG-, NRW-, MOV-, and WAV-format files can be copied. Files recorded in any other format cannot be copied.
- Voice memo (🔍67) attached to pictures and **Protect** setting (🔍66) are also copied with the pictures.
- When images saved with an **Image quality** (📖75) setting of **NRW (RAW) + Fine**, **NRW (RAW) + Normal** or **NRW (RAW) + Basic** are chosen, the NRW (RAW) and JPEG images are copied at the same time.
- Pictures recorded with another make or model of camera or that have been modified on a computer cannot be copied.
- The **Print order** (🔍60) settings are not copied.
- Pictures with **Hide image** (🔍66) settings cannot be copied.

📄 Message: "Memory contains no images."

If there are no pictures stored on the memory card when playback mode is selected, the message, **Memory contains no images.**, is displayed. Press the MENU button to display the copy option screen, and copy the pictures stored in the camera's internal memory to the memory card.

📄 More Information

See "File and Folder Names" (🔍99) for more information.

The Movie Menu



Autofocus Mode

Rotate the mode dial to  → MENU button →  (Movie) tab (📖13) → Autofocus mode

Choose how the camera focuses when recording movies.

Option	Description
AF-S Single AF (default setting)	Lock on the focus when the shutter-release button is pressed halfway. Select this option when the distance between the camera and the subject remains fairly consistent.
AF-F Full-time AF	The camera focuses continuously during movie recording. Suitable for shooting when the distance between the camera and subject changes. The operation sound when the camera focuses may be recorded. Setting to Single AF is recommended if the sound is noticeable.

Wind Noise Reduction

Rotate the mode dial to  → MENU button →  (Movie) tab (📖13) → Wind noise reduction

Option	Description
 On	The noise of wind blowing on the camera's built-in microphone is minimized during recording. This setting is suitable for recording in strong winds. During playback, not only wind noise, but other sounds may also become difficult to hear.
OFF Off (default setting)	Wind noise is not reduced.

When **On** is selected, an icon for this setting is displayed on the monitor (📖8).

Note on Wind Noise Reduction

When the external microphone () is used for shooting, wind noise reduction is not available.

The Setup Menu

Welcome Screen

Press the MENU button → Y tab (13) → Welcome screen

Choose whether or not to display the welcome screen on the monitor when the camera is turned on.

Option	Description
None (default setting)	Display the shooting or playback screen without displaying the welcome screen.
COOLPIX	Display the welcome screen before displaying the shooting or playback screen.
Select an image	<p>Select a picture taken to display as the welcome screen. Display the image selection screen, choose an image (65), and press the OK button to register it.</p> <ul style="list-style-type: none">• Because the selected image is stored in the camera, the image appears in the welcome screen even if the original image is deleted.• NRW (RAW) images (75), pictures shot with an Image size (77) of 3648×2432, 3584×2016, or 2736×2736, or pictures reduced to 320×240 or smaller using small picture editing (14) or crop (19) cannot be selected.

Time Zone and Date

Press the MENU button → Y tab (📖13) → Time zone and date

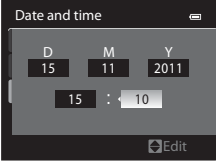
Option	Description
Date and time	<p>Set the camera clock to the current date and time. Use the multi selector to set the date and time.</p> <ul style="list-style-type: none"> Choose an item: Press ► or ◀ (selected in the following order: D (day) → M (month) → Y (year) → hour → minute). Set the contents: Press ▲ or ▼. Date and time can also be set by rotating the main command dial. Finish setting: Choose minute and press the OK button or ►. 
Date format	<p>Choose the order in which the day, month, and year are displayed (Year/Month/Day, Month/Day/Year or Day/Month/Year).</p>
Time zone	<p>🏠 Home time zone can be specified and daylight saving can be enabled or disabled.</p> <p>When ➡ travel destination is registered, the time difference (🕒73) from the 🏠 home time zone is automatically calculated and the local date and time are recorded. Useful when traveling.</p>

Setting the Travel Destination Time Zone

1 Use the multi selector to choose **Time zone** and press the **OK** button.

- The **Time zone** screen is displayed.

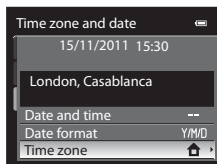

2 Choose **Travel destination** and press the **OK** button.

- The date and time displayed on the monitor change according to the region currently selected.

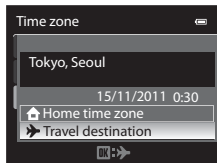

3 Press **▶**.

- The time zone selection screen is displayed.

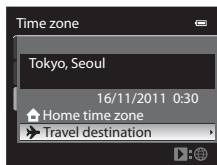

4 Press **◀** or **▶** to choose the travel destination (Time zone).

- The time difference between home and the travel destination is displayed.
- When using the camera in an area where daylight saving time is in effect, turn on the daylight saving setting with **▲**. When set to on, the **⌚** icon is displayed on the top of the monitor and the clock advances by one hour. To turn off, press **▼**.
- Press the **OK** button to register the travel destination time zone.
- While the travel destination time zone is selected, the **▶** icon is displayed on the monitor when the camera is in shooting mode.

Time difference

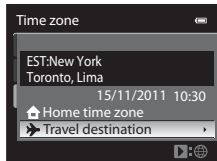
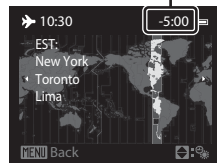

Home Time Zone

- To switch to the home time zone, choose **Home time zone** in step 2 and press the **OK** button.
- To change the home time zone, choose **Home time zone** in step 2 and perform the same procedure as for **Travel destination** to set the home time zone.



 **Time Zones**











The camera supports the time zones listed below.

For time differences not listed below, set the camera clock using **Time zone and date**.

UTC +/-	Location	UTC +/-	Location
-11	Midway, Samoa	+1	Madrid, Paris, Berlin
-10	Hawaii, Tahiti	+2	Athens, Helsinki, Ankara
-9	Alaska, Anchorage	+3	Moscow, Nairobi, Riyadh, Kuwait, Manama
-8	PST (PDT): Los Angeles, Seattle, Vancouver	+4	Abu Dhabi, Dubai
-7	MST (MDT): Denver, Phoenix	+5	Islamabad, Karachi
-6	CST (CDT): Chicago, Houston, Mexico City	+5.5	New Delhi
-5	EST (EDT): New York, Toronto, Lima	+6	Colombo, Dhaka
-4.5	Caracas	+7	Bangkok, Jakarta
-4	Manaus	+8	Beijing, Hong Kong, Singapore
-3	Buenos Aires, Sao Paulo	+9	Tokyo, Seoul
-2	Fernando de Noronha	+10	Sydney, Guam
-1	Azores	+11	New Caledonia
±0	London, Casablanca	+12	Auckland, Fiji

Monitor Settings

Press the MENU button →  tab (13) → Monitor settings

Option	Description
Image review	<p>On (default setting): Picture is displayed on the monitor immediately after shooting and the monitor display returns to shooting screen.</p> <p>Off: Picture is not displayed after shooting.</p> <p>Zoom in on active focus point: Picture is displayed on the monitor immediately after shooting and the monitor display returns to the shooting screen. An enlarged image of the focused section is displayed in the area where focusing is performed.</p> <p>Tone level information: Tone level information (15) is displayed on the monitor immediately after shooting.</p>
Brightness	Choose from five settings to select the monitor brightness. The default setting is 3 .
Photo info	<p>Choose the display options that are displayed on the monitor during shooting. Separate display options (15) can be selected for when the monitor display (8) is set to Show info and when it is set to Hide info. In the default setting, all options are hidden.</p> <p> Virtual horizon: Display the virtual horizon for checking whether the camera is horizontal. When the camera is horizontal or vertical, the mark on the virtual horizon display turns green.</p> <p> View/hide histograms: Display a graph that shows the brightness distribution in the picture (8).</p> <p> View/hide framing grid: Display a boxed guide for framing.</p> <ul style="list-style-type: none"> • To select show or hide, choose an option with the multi selector, and then press the  button to turn the check box on  or off. • After finishing the setting, choose Confirm and press the  button.
Virtual horizon display	Set the virtual horizon indicator to either Circle (default setting) or Bars ( 8).

Notes on Monitor Display Settings

- Only the framing grid is displayed in movie mode.
- In shooting modes **U1**, **U2** and **U3**, **Photo info** in the setup menu settings cannot be set. Select the **U1**, **U2** or **U3** tab and set **Photo info** in the specialized menus for **U1**, **U2** and **U3** (13, 58).

Print Date (Imprinting Date and Time on Pictures)

Press the **MENU** button → **Y** tab (📖13) → **Print date**

The shooting date and time can be imprinted on pictures at the time of shooting. This information can be printed even from printers that do not support printing of the date and time (🔍61).



Option	Description
DATE Date	The date is imprinted on pictures.
DATE Date and time	The date and time are imprinted on pictures.
OFF Off (default setting)	The date and time are not imprinted on pictures.

The icon for the current setting other than **Off** is displayed on the monitor (📖8).

✓ Notes on Print Date

- Imprinted dates cannot be deleted from the image, nor can dates be imprinted after the picture has been taken.
- Dates cannot be imprinted in the following situations.
 - When the scene mode is set to **Sports, Museum, Backlighting** with **HDR** set to **On**, **Panorama assist**, or **Pet portrait** with **Continuous**
 - During movie recording
- This feature may not be used in combination with certain features. See "Features That Cannot Be Used Simultaneously" (📖80) for more information.
- Dates imprinted with an **Image size** (📖77) setting of **VGA 640×480** may be difficult to read. Set the image size to **PC 1024×768** or higher.
- The date is recorded using the format selected in the setup menu's **Time zone and date** option (📖26, 🔍71).

📝 Print date and Print order

When printing from DPOF-compatible printers which support printing of shooting date and shooting information, the date and information can be printed on pictures without the date and time being imprinted on them with **Print date**, using options in the **Print order** menu (🔍60).

Self-timer: After Release

Press the MENU button → Y tab (📖13) → Self-timer: after release

Set whether or not to cancel the self-timer mode (📖64), or ten seconds or two seconds remote mode (📖105), after shooting pictures.

Option	Description
Exit self-timer mode (default setting)	Cancel the self-timer mode after shooting pictures. <ul style="list-style-type: none"> The setting is not canceled in the quick-response remote or smile timer mode (📖65).
Stay in self-timer mode	Enable shooting continuously without canceling the setting, after shooting pictures. <ul style="list-style-type: none"> The setting applied in shooting modes A (auto), P, S, A, M, N (low noise night) or EFFECTS (special effects) is not cancelled even after the camera is turned off.

Vibration Reduction

Press the MENU button → Y tab (📖13) → Vibration reduction

Option	Description
 On (default setting)	Correct camera shake that commonly occurs when shooting still pictures or movies at the telephoto zoom position or slow shutter speed. The camera automatically detects the panning direction and only corrects for vibration caused by camera shake. When the camera is panned horizontally, for example, vibration reduction only reduces vertical shake. If the camera is panned vertically, vibration reduction only compensates for horizontal shake.
OFF Off	Vibration Reduction is not enabled.

- When using a tripod to stabilize the camera, set vibration reduction to **Off**. When **On** is selected, an icon for this setting is displayed on the monitor (📖8).

✔ Notes on Vibration Reduction

- After the power is turned on or the camera enters shooting mode from playback mode, wait until the display stabilizes before shooting.
- Due to the characteristics of the vibration reduction function, images displayed on the monitor immediately after shooting may appear blurry.
- Vibration reduction may be unable to completely eliminate the effects of camera shake in some situations.

Motion Detection

Press the **MENU** button → **Y** tab (📖13) → Motion detection

Enable motion detection to reduce the effects of camera shake and subject movement when shooting still pictures.

Option	Description
 Auto	<p>If the camera detects the movement of the subject or camera shake, the ISO sensitivity is raised and the shutter speed is increased to reduce their effects. However, motion detection does not function in the following situations.</p> <ul style="list-style-type: none"> When the fill flash fires In the following scene modes: Sports, Night portrait, Dusk/dawn, Night landscape, Museum, Fireworks show, Backlighting and Pet portrait When shooting mode is P, S, A, M, U1, U2, U3, 4 (low noise night) or EFFECTS (special effects)
OFF Off (default setting)	Motion detection is not enabled.

When **Auto** is selected, an icon for this setting is displayed on the monitor (📖8). The motion detection icon lights in green when the camera detects any vibration and increases the shutter speed.

Notes on Motion Detection

- Motion detection may be unable to completely reduce effects of camera shake and subject movement in some situations.
- Motion detection may not function if the subject exhibits significant movement or is too dark.
- The pictures taken may become grainy.
- This feature may not be used in combination with certain features. See “Features That Cannot Be Used Simultaneously” (📖80) for more information.

AF Assist

Press the **MENU** button → **Y** tab (📖13) → **AF assist**

Enable or disable the AF-assist illuminator that assists the autofocus when the lighting is dim.

Option	Description
Auto (default setting)	<p>AF-assist illuminator lights automatically if the lighting is dim. The illuminator has a range of about 8.0 m (26 ft) at the maximum wide-angle position and about 7.0 m (22 ft) at the maximum telephoto position.</p> <ul style="list-style-type: none"> For some focus areas and scene modes such as Museum (📖43), Pet portrait (📖45), AF-assist illuminator does not turn on even if Auto is set.
Off	AF-assist illuminator does not light. The camera may be unable to focus if lighting is dim.

✔ Note on the AF-assist Illuminator

In shooting modes **U1**, **U2** and **U3**, **AF assist** in the setup menu settings cannot be set. Select the **U1**, **U2** or **U3** tab and set **AF assist** in the specialized menus for **U1**, **U2** and **U3** (📖13, 58).

Red-eye Reduction

Press the **MENU** button → **Y** tab (📖13) → **Red-eye reduction**

Choose the red-eye reduction method when the flash mode (📖61) is  (auto with red-eye reduction).

Option	Description
Pre-flash on (default setting)	The flash repeatedly fires pre-flashes at low intensity before the main flash to reduce the red-eye effect, and it then performs the red-eye reduction process using picture compensation. Note that there is a slight lag between the shutter-release button being pressed and the picture being shot.
Pre-flash off	Pre-flashes do not fire. The shutter is released immediately when the shutter-release button is pressed all the way, and the red-eye reduction process is performed using picture compensation.

Digital Zoom

Press the MENU button → Y tab (13) → Digital zoom

Enable or disable the digital zoom.

Option	Description
On (default setting)	When the camera is zoomed in to the maximum optical zoom position, rotating and holding the zoom control toward T (Q) triggers the digital zoom (31).
Crop	Limit zoom magnification up to the position of 1.5x during still picture shooting. Also limit the digital zoom to the range at which image quality of the shot still picture does not deteriorate (31). <ul style="list-style-type: none"> The digital zoom is not available when the image size is 10M 3648×2736, 8M 3264×2448, 6.2M 3648×2432, 16.9M 3584×2016 or 11M 2736×2736. During movie recording, digital zoom works as described in On.
Off	The digital zoom is not activated.

Notes on Digital Zoom

- When the digital zoom is in effect, AF area mode is set to **Center (spot)** (48).
- The digital zoom cannot be used when **Scene auto selector**, **Portrait**, **Night portrait**, **Backlighting** with **HDR** set to **On** or **Pet portrait** is selected in scene mode.
- This feature may not be used in combination with certain features. See “Features That Cannot Be Used Simultaneously” (80) for more information.
- At magnifications of 1.2x to 1.8x, **Metering** is set to **Center-weighted**, and at magnifications of 2.0x to 4.0x, it is set to **Spot**.
- The digital zoom is not available for **Zoom exposure** (47).

Zoom Speed

Press the **MENU** button → **Y** tab (📖13) → **Zoom speed**

Set the zoom operation speed. Slow down the zoom speed to minimize the recording of the zoom operating noise during movie recording.

Option	Description
Auto (default setting)	During still picture shooting, operate the zoom at the Normal speed. During movie recording, operate the zoom at a lower speed than Normal to minimize the recording of the zoom operating noise. During still picture shooting, rotating the zoom control all the way in either direction adjusts the zoom quickly, while rotating the control partially adjusts the zoom slowly.
Normal	During both still picture shooting and movie recording, operate the zoom at the standard speed. During both still picture shooting and movie recording, rotating the zoom control all the way in either direction adjusts the zoom quickly, while rotating the control partially adjusts the zoom slowly.
Quiet	During both still picture shooting and movie recording, operate the zoom at a lower speed than Normal .

The icon for the current setting other than **Auto** is displayed on the monitor (📖8).

Fixed Aperture

Press the **MENU** button → **Y** tab (📖13) → **Fixed aperture**

Option	Description
On	In A or M shooting mode, zooming can be performed with minimum changes in the aperture value. <ul style="list-style-type: none"> When f-number exceeds exposure range at new zoom position, the aperture value is not fixed.
Off (default setting)	The aperture value is not fixed.

Sound Settings

Press the MENU button → Y tab (📖13) → Sound settings

Adjust the following sound settings.

Option	Description
Button sound	Set the following all sound settings to On (default setting) or Off . <ul style="list-style-type: none"> • Setting beep (beep sounds once when the settings are completed) • Focus beep (beep sounds twice when the camera focuses on the subject) • Error beep (beep sounds three times when an error is detected) • Start-up sounds
Shutter sound	Choose whether to set the shutter sound to On (default setting) or Off .

✓ Notes on Sound Settings

- In **Pet portrait** scene mode, even when **On** is set, the button sound and shutter sound are disabled.
- Even when **On** is set, the shutter sound is disabled when scene mode is **Backlighting** with **HDR** set to **On** or during movie recording.
- This feature may not be used in combination with certain features. See “Features That Cannot Be Used Simultaneously” (📖80) for more information.

Record Orientation

Press the MENU button → Y tab (📖13) → Record orientation

Option	Description
Auto (default setting)	The orientation data is recorded with the taken picture. When played back while Rotate tall (📷82) is set to On , the picture is automatically rotated for display.
Off	The orientation data is not recorded and pictures are always displayed in the horizontal position.

- The orientation data can be changed after shooting using **Rotate image** in the playback menu (📷66).

✓ Notes on Recording the Orientation Data

- In **Continuous** or **Auto bracketing** mode, all pictures are recorded with the same orientation data as the first picture.
- Correct orientation data may not be obtained for pictures recorded with the camera facing up or down.

Rotate Tall

Press the **MENU** button → **Y** tab (📖13) → Rotate tall

When **On** (default setting) is selected, pictures taken with orientation data in “tall” or with face detection are automatically rotated in accordance with the recorded orientation data for display.

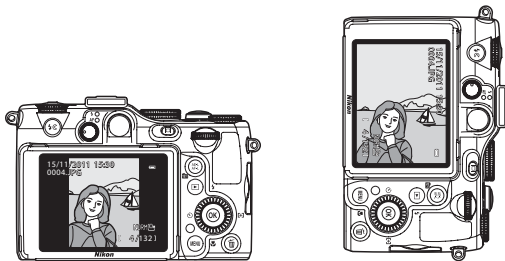

Auto Off

Press the **MENU** button → **Y** tab (📖13) → Auto off

If no operations are performed for a certain period while the camera is on, the monitor is turned off to save power and the camera enters standby mode (📖25). In this menu, set the time before the camera enters standby mode. Choose from **30 s**, **1 min** (default setting), **5 min** and **30 min**.

Auto Off Setting

- In the following situations, the time taken for the camera to enter standby mode is fixed.
 - When menus are displayed: three minutes
 - When tone level information is displayed (shooting mode): three minutes
 - During slideshow playback: maximum of 30 minutes
 - When the AC Adapter EH-5b is connected: 30 minutes
- The camera does not enter standby mode when transferring images using the Eye-Fi card.

Format Memory/Format Card

Press the MENU button → Y tab (📖13) → Format memory/Format card

Format the internal memory or a memory card.

Formatting permanently deletes all data in the internal memory or memory card. The deleted data cannot be recovered. Be sure to transfer important pictures to a computer before formatting.

Formatting the Internal Memory

To format the internal memory, remove the memory card from the camera. The

Format memory option is displayed on the setup menu.

Formatting Memory Cards

When a memory card is inserted in the camera, the memory card can be formatted.

The **Format card** option is displayed on the setup menu.

Formatting Internal Memory and Memory card

- Do not turn off the camera or open the battery-chamber/memory card slot cover during formatting.
- The first time you insert a memory card that has been used in another device into this camera, be sure to format it with this camera.

Language

Press the MENU button → Y tab (📖13) → Language

Choose one of 29 languages for displaying the camera menus and messages.

Čeština	Czech	Nederlands	Dutch	Türkçe	Turkish
Dansk	Danish	Norsk	Norwegian	Українська	Ukrainian
Deutsch	German	Polski	Polish	عربي	Arabic
English	(default setting)	Português (BR)	Brazilian Portuguese	简体中文	Simplified Chinese
Español	Spanish	Português (PT)	Portuguese	繁體中文	Traditional Chinese
Ελληνικά	Greek	Русский	Russian	日本語	Japanese
Français	French	Română	Romanian	한글	Korean
Indonesia	Indonesian	Suomi	Finnish	ภาษาไทย	Thai
Italiano	Italian	Svenska	Swedish	हिन्दी	Hindi
Magyar	Hungarian	Tiếng Việt	Vietnamese		

TV Settings

Press the **MENU** button → **Y** tab (📖13) → TV settings

Adjust the settings for connecting to a TV.

Option	Description
Video mode	Select the analog video output system from NTSC or PAL in accordance with your TV.
HDMI	Select a picture resolution for HDMI output from Auto (default setting), 480p , 720p , or 1080i . When Auto is set, the output resolution that is best suited to the connected TV is selected automatically from 480p , 720p or 1080i .
HDMI device control	Select whether or not the camera receives signals from a TV when a TV that conforms to the HDMI-CEC standard is connected with an HDMI cable. When set to On (default setting), the television remote control can be used to operate the camera during playback. See "Using the TV's Remote Control (HDMI Device Control)" (🔍21) for more information.

HDMI and HDMI-CEC

"HDMI" is an abbreviation of High-Definition Multimedia Interface, which is one type of multimedia interface.

"HDMI-CEC" is an abbreviation of HDMI-Consumer Electronics Control, which enables operations to be linked between compatible devices.

External Mic Sensitivity

Press the **MENU** button → **Y** tab (📖13) → External mic sensitivity

Select **High** if the sensitivity of the external microphone is low during movie recording.

- The default setting is **Auto**.

Built-in ND Filter

Press the **MENU** button → **Y** tab (📖13) → Built-in ND filter

When the camera's built-in ND filter is used, the amount of light that enters the camera while shooting can be reduced in three steps. Use in situations such as when overexposure results from the subject being too bright. Set whether or not to use the built-in ND filter to reduce the light in the following shooting modes.

-  (low noise night) mode
 - **P**, **S**, **A** and **M** modes (including **U1**, **U2** and **U3** modes)
- In shooting modes other than the above, the on/off setting of the built-in ND filter is controlled automatically according to the shooting mode and shooting conditions, regardless of **Built-in ND filter** setting.

Option	Description
On	Use the ND filter to reduce the light.
Auto	In mode  (low noise night) or P (Programmed auto), when the subject is too bright and the exposure range is exceeded, reduce the light automatically with the ND filter. <ul style="list-style-type: none"> • In shooting modes S, A and M, the ND filter is Off.
Off (default setting)	The ND filter is not used.

The icon for the current setting other than **Off** is displayed on the monitor (📖8). No icon is displayed when the setting is  (auto), scene or movie mode.

Effects of the Built-in ND Filter

Using the filter may enable the shooting of subjects that are too bright without overexposing the image. It can also be used in situations such as when you want to slow down the shutter speed at a low aperture value.

For example, at a shutter speed of 1/2000 second with the correct exposure, if the ND filter is used to reduce the light in three steps, the speed can be changed to 1/250 second without changing the aperture value.

Customize Command Dials

Press the MENU button → Y tab (📖13) → Customize command dials

Option	Description
No swap (default setting)	The respective functions operated using the main command dial and sub-command dial are not swapped.
Swap main and sub	Swap the functions that can be operated using the main command dial and sub-command dial when shooting pictures. <ul style="list-style-type: none"> The functions are not swapped for the playback or menu screen.

Multi Selector Right Press

Press the MENU button → Y tab (📖13) → Multi selector right press

Set to **Off** if you do not want to display the AF area mode (🔍48) setting when the multi selector ▶ is pressed.

- The default setting is **AF area mode**.

Delete Button Options

Press the MENU button → Y tab (📖13) → Delete button options

Option	Description
Press twice to delete	Press the 🗑️ button once more to delete an image while the deletion confirmation message is displayed (📖36).
Disable second press (default setting)	Even if the 🗑️ button is pressed again while the deletion confirmation message is displayed, the image is not deleted.

AE/AF Lock Button

Press the **MENU** button → **Y** tab (📖13) → AE/AF lock button

Select the function to be performed when the AE-L/AF-L (AE-L/AF-L) button (📖5) is pressed while shooting.

Option	Description
AE/AF lock (default setting)	Lock both the focus and exposure when the AE-L/AF-L (AE-L/AF-L) button is pressed.
AE lock only	Lock only the exposure when the AE-L/AF-L (AE-L/AF-L) button is pressed.
AF lock only	Lock only the focus when the AE-L/AF-L (AE-L/AF-L) button is pressed.

The AE-L/AF-L (AE-L/AF-L) button setting is displayed on the monitor during shooting (📖8).

- During still picture shooting, lock only when the AE/AF-L button is pressed.
- During movie recording, lock when the AE/AF-L button is pressed, and release when the button is pressed again.

✓ Notes on AE/AF Lock Button Setting

- The AE-L/AF-L (AE-L/AF-L) button cannot be used when **Scene auto selector** is selected in scene mode.
- AE-L (exposure locking) cannot be used when the shooting mode is set to **M**.
- AF-L (focus locking) cannot be used when focus mode (📖67) is set to **MF** (manual focus).

📎 More Information

See "Focus Lock" (📖33) for more information.

Fn1 + Shutter Button

Press the MENU button → Y tab (📖13) → Fn1 + shutter button

Set the function to be performed when the shutter-release button is pressed while pressing the **Fn1** (FUNC1) button (📖2) during shooting.

- This can be used when **P, S, A, M, U1, U2** or **U3** is chosen for shooting mode.

Option	Description
Off (default setting)	Shoot without changing the setting.
NRW (RAW)/Normal (Image quality) (📖75)	<p>When Fine, Normal or Basic is set, shoot with the NRW (RAW) setting. When NRW (RAW) is set, shoot with the Normal setting.</p> <ul style="list-style-type: none"> • The image size is  3648×2736. • When NRW (RAW) + Fine, NRW (RAW) + Normal or NRW (RAW) + Basic is set, shoot without changing the setting.
ISO sensitivity (📷30)	Shoot with ISO sensitivity set to Auto .
White balance (📷32)	<p>Shoot with White balance set to Auto (normal).</p> <ul style="list-style-type: none"> • Cannot be used when Picture Control is set to Monochrome.
Picture Control (📷38)	Shoot with Picture Control set to Standard .

Fn1 + Command Dial

Press the MENU button → Y tab (📖13) → Fn1 + command dial

Set the function to be performed when the command dial is rotated while pressing the **Fn1** (FUNC1) button during shooting.

- Rotating either the main command dial or sub-command dial enables the operation.

Option	Description
Off (default setting)	Shoot without the function. Operation will be disabled.
Manual focus (🔍2)	When the focus mode is set to manual focus, the focus can be adjusted.
Metering (🔍44)	Change the setting for metering.
Continuous (🔍45)	Change the settings for continuous shooting.
Flash exp. comp. (🔍52)	Change the setting for Flash exp. comp.
Active D-Lighting (🔍56)	Change the setting for Active D-Lighting.
Manual flash level (📖62)	Change the flash output set for the built-in flash when the flash mode is set to manual.

✔ Note on Fn1 + Command Dial

Operation is disabled when AE or AF is locked (except when recording a movie).

Fn1 Guide Display

Press the MENU button → Y tab (📖13) → Fn1 guide display

Option	Description
On (default setting)	The Fn1 button operation indicator (📖8) and the functions assigned to the Fn1 + shutter button (🔍88) and Fn1 + command dial (🔍89) are displayed while the Fn1 (FUNC1) button is pressed.
Off	Even if the Fn1 button is pressed, guide is not displayed.

Fn2 Button

Press the **MENU** button → **Y** tab (📖13) → **Fn2** button

Choose the function to be performed when the **Fn2** button (📖2) is pressed while shooting.

Option	Description
Off (default setting)	Shoot without the function. Operation will be disabled.
Virtual horizon, View/show histograms, View/show framing grid	Select whether to view or hide the virtual horizon, histogram or framing grid displays (📷74) on the monitor during shooting.
Built-in ND filter	Change the built-in ND filter (📷85) setting.

Customize My Menu

Press the **MENU** button → **Y** tab (📖13) → **Customize My Menu**

Register frequently used menu items in My Menu (maximum of five). The registered My Menu can be displayed when the quick menu dial is set to **My** and the quick menu button is pressed, allowing settings to be quickly checked or changed (only when shooting mode is set to **P, S, A, M, U1, U2** or **U3**).

The following items can be registered.

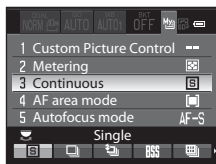

Custom Picture Control (📷43)	Noise reduction filter (📷53)	Vibration reduction (📷76)
Metering (📷44)	Long exposure NR (📷53)	Digital zoom (📷79)
Continuous (📷45)	Distortion control (📷54)	Format memory/Format card (📷83)
AF area mode (📷48)	Wide-angle converter (📷54)	Built-in ND filter (📷85)
Autofocus mode (📷52)	Flash control (📷55)	Eye-Fi upload (📷93)
Flash exp. comp. (📷52)	Active D-Lighting (📷56)	- (no setting) (delete)*

* Choose to remove an item from My Menu.

Registering into My Menu

1 Use the multi selector to choose the menu item and press the **OK** button.

- The menu item selection screen is displayed.

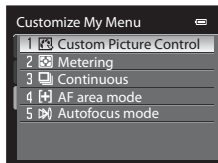

2 Choose the menu item to be registered and press the **OK** button.

- The chosen menu item is switched.
- To finish the setting, press the multi selector **◀**.

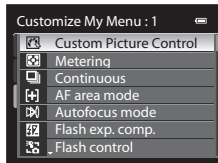

Reset File Numbering

Press the **MENU** button → **Y** tab (13) → Reset file numbering

When **Yes** is selected, the sequential numbering of file numbers is reset (99). After resetting, a new folder is created and the file number for the next picture taken starts from "0001."

✓ Notes on Reset file numbering

- Reset file numbering** cannot be used when scene mode is set to **Panorama assist**, or if **Intvl timer shooting** is chosen for **Continuous** when **P, S, A, M, U1, U2** or **U3** shooting modes are used. For **Panorama assist** or **Intvl timer shooting**, a new folder is created, and file numbers are assigned automatically starting with "0001" (99, 100).
- Reset file numbering** cannot be applied when the folder number reaches 999 and there are images in the folder. Insert a new memory card, or format the internal memory/memory card (83).

Blink Warning

Press the **MENU** button → **Y** tab (📖13) → **Blink warning**

Choose whether or not blinking eyes are detected when using face detection (📖85) in the following shooting modes.

- In the following scene modes: **Scene auto selector** (📖40), **Portrait** (📖40) or **Night portrait** (📖41)
- Shooting modes **P, S, A, M, U1, U2, U3**, 📷 (low noise night) and **EFFECTS** (special effects) (when **Face priority** (📷48) is selected for **AF area mode**)

Option	Description
On	The Did someone blink? screen is displayed on the monitor if the camera detects that a human subject may have closed the eyes immediately after recognizing the face. The face of the human subject that may have closed his/her eyes is framed by a yellow border. You can check the picture taken and determine if you need to take the picture again.
Off (default setting)	The camera does not detect blinks.

The Did someone blink? Screen

If no operations are performed for a few seconds, the screen automatically returns to the shooting screen.

- To zoom in the face for which blinking was detected, rotate the zoom control toward **T** (🔍). To return to full-frame playback mode, rotate the zoom control toward **W** (📷).
- When the camera detects that one or more human subjects have closed their eyes, press **▲**, **▼**, **◀** or **▶** during playback zoom to display other faces. Other faces can also be displayed by rotating the main command dial.
- Press the **🗑️** button to delete the picture taken.
- Press the **OK** button to return to shooting screen.



✔ Note on Blink Warning

This feature may not be used in combination with certain features. See “Features That Cannot Be Used Simultaneously” (📖80) for more information.

Eye-Fi Upload

Press the MENU button → Y tab (📖13) → Eye-Fi upload

Option	Description
Enable	Upload images created by the camera to a preselected destination.
Disable (default setting)	Images will not be uploaded.

✔ Notes on Eye-Fi Cards

- Note that images will not be uploaded if signal strength is insufficient even if **Enable** is selected.
- Select **Disable** where wireless devices are prohibited.
- Refer to the instruction manual of your Eye-Fi card for more information. In the event of malfunction, contact the card manufacturer.
- The camera can be used to turn Eye-Fi cards on and off, but may not support other Eye-Fi functions.
- If the Eye-Fi card where Eye-Fi upload cannot be set to off is inserted, Eye-Fi upload cannot be set.
- The camera is not compatible with the endless memory function. When it is set on a computer, disable the function. If the endless memory function is enabled, the number of pictures taken may not be displayed correctly.
- Eye-Fi cards are for use only in the country of purchase. Observe all local laws concerning wireless devices.
- Leaving the setting as **Enable** will result in the battery being depleted in a shorter period of time.

🔪 Eye-Fi communication indicator

The communication status of the Eye-Fi card in the camera can be confirmed on the monitor (📖8).

- 🚫: **Eye-Fi upload** is set to **Disable**.
- 📶 (lights): Eye-Fi upload enabled; waiting to begin upload.
- 📶 (blinks): Eye-Fi upload enabled; uploading data.
- 📶: Eye-Fi upload enabled but no images available for upload.
- 🚫: An error occurred. The camera cannot control the Eye-Fi card.

🔪 Supported Eye-Fi Cards

As of August 2011, the following Eye-Fi cards can be used. Be sure that Eye-Fi card firmware has been updated to the latest version.

- Eye-Fi Connect X2 SDHC 4GB
- Eye-Fi Mobile X2 SDHC 8GB
- Eye-Fi Pro X2 SDHC 8GB

MF Distance Indicator Units

Press the **MENU** button → **Y** tab (📖13) → MF distance indicator units

Set either **m** (meter) (default setting) or **ft** (feet) for the unit of gauge displayed when the focus mode is set to manual focus (🔍2).

Reverse Indicators

Press the **MENU** button → **Y** tab (📖13) → Reverse indicators

Change the +/- display direction of the exposure indicator (📖53) displayed when shooting mode is **M** and the indicator displayed for setting bracketing (🔍36). The + side of the indicators is set to the left and - side is set to the right in the default setting.

Reset All

Press the **MENU** button → **Y** tab (📖13) → Reset all

When **Reset** is selected, the camera settings are restored to the default values.

Pop-up Menu

Option	Default value
Flash mode (📖61)	Auto
Self-timer (📖64)/Smile timer (📖65)/ Remote control (🔍105)	OFF
Focus mode (📖67)	Autofocus

Shooting in the Scene Mode

Option	Default value
Scene menu (📖39)	Scene auto selector
Hue adjustment in Food mode (📖43)	Center
HDR in Backlighting (📖44)	Off
Pet portrait (📖45)	Pet portrait auto release: On Continuous: Continuous

Special Effects Menu

Option	Default value
Special effects (📖48)	Creative monochrome

Low Noise Night Mode Menu

Option	Default value
Continuous (📖50)	Single
Flash exp. comp. (📖50)	0.0
Metering (📖50)	Matrix

Movie Menu

Option	Default value
Autofocus mode (🔍69)	Single AF
Wind noise reduction (🔍69)	Off

Quick Menu

Option	Default value
Image quality (📖75)	Normal
Image size (📖77)	📷 3648x2736
Movie options (🔍42)	HD 720p (1280x720)
ISO sensitivity (🔍31)	Auto
Minimum shutter speed (🔍31)	None
White balance (🔍32)	Auto (normal)
Auto bracketing (🔍36)	Off
Picture Control (🔍38)	Standard

Shooting Menu

Option	Default value
Metering (🔍🔍44)	Matrix
Continuous (🔍🔍45)	Single
Intvl timer shooting (🔍🔍46)	30 s
AF area mode (🔍🔍48)	Auto
Autofocus mode (🔍🔍52)	Single AF
Flash exp. comp. (🔍🔍52)	0.0
Noise reduction filter (🔍🔍53)	Normal
Long exposure NR (🔍🔍53)	Auto
Distortion control (🔍🔍54)	Off
Wide-angle converter (🔍🔍54)	None
Flash control (🔍🔍55)	Auto
Active D-Lighting (🔍🔍56)	Off
Zoom memory (🔍🔍57)	All values are chosen

Setup Menu

Option	Default value
Welcome screen (🔍🔍70)	None
Image review (🔍🔍74)	On
Brightness (🔍🔍74)	3
Photo info (🔍🔍74)	Hide all items
Virtual horizon display (🔍🔍74)	Circle
Print date (🔍🔍75)	Off
Self-timer: after release (🔍🔍76)	Exit self-timer mode
Vibration reduction (🔍🔍76)	On
Motion detection (🔍🔍77)	Off
AF assist (🔍🔍78)	Auto
Red-eye reduction (🔍🔍78)	Pre-flash on
Digital zoom (🔍🔍79)	On
Zoom speed (🔍🔍80)	Auto
Fixed aperture (🔍🔍80)	Off
Button sound (🔍🔍81)	On
Shutter sound (🔍🔍81)	On
Record orientation (🔍🔍81)	Auto
Rotate tall (🔍🔍82)	On

Option	Default value
Auto off (Fn82)	1 min
HDMI (Fn84)	Auto
HDMI device control (Fn84)	On
External mic sensitivity (Fn84)	Auto
Built-in ND filter (Fn85)	Off
Customize command dials (Fn86)	No swap
Multi selector right press (Fn86)	AF area mode
Delete button options (Fn86)	Disable second press
AE/AF lock button (Fn87)	AE/AF lock
Fn1 + shutter button (Fn88)	Off
Fn1 + command dial (Fn89)	Off
Fn1 guide display (Fn89)	On
Fn2 button (Fn90)	Off
Customize My Menu (Fn90)	1: Custom Picture Control 2: Metering 3: Continuous 4: AF area mode 5: Autofocus mode
Blink warning (Fn92)	Off
Eye-Fi upload (Fn93)	Disable
MF distance indicator units (Fn94)	m
Reverse indicators (Fn94)	+0-

Others

Option	Default value
Paper size (Fn24, 25)	Default
Frame intvl for Slide show (Fn63)	3 s

The Setup Menu

- Choosing **Reset all** also clears the current file number (🔑99) in the memory. After resetting, numbering continues from the lowest number available in the internal memory or the memory card. If **Reset all** is performed after all pictures are deleted from the internal memory or memory card (🔑64), the file numbers for the next pictures taken start from "0001."
- The following settings remain unaffected even if **Reset all** is performed.
Quick menu: Preset manual data for **White balance** (🔑35)
Shooting menu: **Custom Picture Control** registration (🔑43)
Setup menu: **Time zone and date** (🔑71), **Language** (🔑83) and **Video mode** (🔑84) in **TV settings**
- User settings that were saved for mode dial **U1**, **U2** and **U3** are not reset to the default settings when **Reset all** is performed. To change these settings back to the default settings, use **Reset user settings** (🔑58).

Firmware Version

Press the MENU button → Y tab (🔑13) → Firmware version

Displays the current camera firmware version.

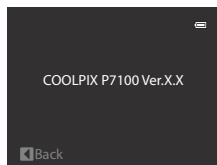

File and Folder Names

Pictures, movies and voice memos are assigned file names as follows.

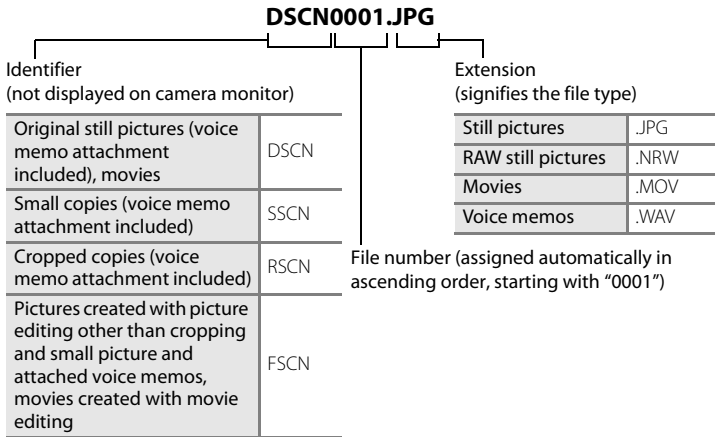

- A folder for storing files is automatically created using the following naming convention: "Folder number + NIKON" (e.g., "100NIKON"). If there are 200 files in a folder, a new folder is created. (For example, the folder name following "100NIKON" becomes "101NIKON.") A new folder is also created when the file numbers in a folder reach 9999 or **Reset file numbering** (🔧91) is performed. The next file number is set automatically to "0001." If a folder contains no files, a new folder is not created even if **Reset file numbering** is performed.
- When images are shot with an **Image quality** (📖75) setting of **NRW (RAW) + Fine**, **NRW (RAW) + Normal** or **NRW (RAW) + Basic**, the NRW (RAW) and JPEG images that are recorded at the same time are assigned the same file name. The NRW (RAW) and JPEG images that are recorded at the same time are saved in the same folder. If there are 199 files in a folder, a new folder is created and the images are saved in the new folder.
- Voice memo file names have the same identifier and file number as the picture to which the voice memo is attached.



File and Folder Names

- In Panorama assist (📖45), a folder is created for each shooting session using the following naming convention: "Folder number + P_XXX" (e.g., "101P_001"). Pictures are saved in sequence in file numbers starting from 0001.
- Each time a picture is taken in Interval timer shooting (🕒46), a folder named with the convention: 'Folder number + INTVL' (e.g., 101INTVL) is created. Pictures are saved in sequence in file numbers starting from 0001.
- When image files or voice files are copied to or from the internal memory or memory card (📁68), the file naming conventions are as follows:
 - Files copied using selected images are copied to the current folder (or to the folder used for subsequent pictures), where they are assigned file numbers in ascending order following the largest file number in memory.
 - Files copied using all images, along with their folder, are copied together. Folder numbers are assigned in ascending order, following the largest folder number on the destination medium.
File names are not changed.
- When the current folder is numbered 999, if there are 200 files in the folder or if a file is numbered 9999, no further pictures can be shot until the internal memory or memory card is formatted (🗑83), or a new memory card is inserted.

Speedlights (External Flash Unit)

The camera is equipped with an accessory shoe, allowing the following Speedlights or Wireless Speedlight Commander to be attached to the camera. Use the Speedlights when the built-in flash cannot provide sufficient lighting.

- Speedlights SB-400, SB-600, SB-700, SB-800, SB-900
- Wireless Speedlight Commander SU-800

The built-in flash is set to  (off) automatically when using Speedlights. While  is displayed on the monitor, the Speedlight flash mode is also displayed on the monitor, and it can be set with the same procedure as the built-in flash ( 61).

How to Attach a Speedlight

- Remove the accessory shoe cover before attaching a Speedlight as shown on the right.
- When the built-in flash is raised, gently push to lower the flash until it clicks shut.
- Refer to the instruction manual of your Speedlight for more information on how to attach Speedlight and details on how to use it.
- Replace the accessory shoe cover when the Speedlight is not in use.

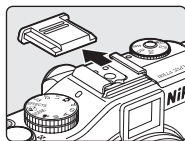

Note on External Flash

Attempting to attach external flashes that do not support this camera may damage the camera and the external flash.

Use Only Nikon Flash Accessories

Use only Nikon Speedlights. Negative voltages or voltages over 250 V applied to the accessory shoe could not only prevent normal operation, but damage the sync circuitry of the camera or flash.

Speedlights SB-400, SB-600, SB-700, SB-800 and SB-900

- Before using Speedlights SB-600, SB-700, SB-800 or SB-900, set the Speedlight flash control mode to TTL. This enables the Standard i-TTL flash control to use monitor pre-flashes to adjust flash output automatically in response to lighting conditions. Refer to the instruction manual of your Speedlight for more information on i-TTL flash control.
- Wireless multiple flash-unit photography can be performed by setting the SB-700, SB-800, SB-900 or Wireless Speedlight Commander SU-800 to “commander,” and setting the SB-600, SB-700, SB-800 and SB-900 to “remote flash unit.” However, the flash is not usable even if the monitor pre-flashes are fired when the SB-900 is set to “commander.”
The Wireless multiple flash group setting is only applicable to group A. Change the setting for both the commander and the remote flash unit to group A. Refer to the instruction manual of your Speedlight for more information.
- When wireless multiple flash-unit photography is performed, if ISO sensitivity is set to **Auto, High ISO sensitivity auto, ISO 100-200** or **ISO 100-400**, it is fixed at ISO 100.
- The camera does not support Flash Color Information Communication, Auto FP High-Speed Sync, FV lock, or AF-assist for multi-area AF when using Speedlights SB-600, SB-700, SB-800 or SB-900.
- Power zoom function can be used with Speedlights SB-600, SB-700, SB-800 or SB-900, setting zoom head position automatically depending upon focal length.
- When using Speedlights SB-600, SB-700, SB-800 or SB-900, the edges of pictures shot at ranges under 2 m (6 ft 7 in.) on the zoom wide-angle position may appear dark. In such cases, use the wide-flash adapter.
- When set to STBY (standby), the Speedlight turns on and off at the same time as the camera. Confirm on the Speedlight that the Ready-light is on.

Optional Accessories

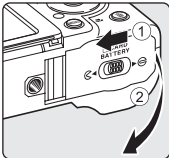
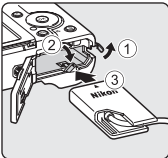
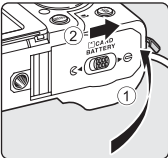
Rechargeable battery	Rechargeable Li-ion Battery EN-EL14 ¹
Battery charger	Battery Charger MH-24 ^{1,2}
AC adapter/ Power connector	<p>AC Adapter EH-5b (connect as shown) and Power Connector EP-5A (connect as shown)</p> <p>When the Power Connector is inserted into the camera and the AC Adapter is connected, the camera can be powered from an electrical outlet.</p> <p>The AC Adapter and the Power Connector are available separately.</p> <div style="display: flex; justify-content: space-around; align-items: flex-start;"> <div style="text-align: center;"> <p>1</p>  </div> <div style="text-align: center;"> <p>2</p>  </div> <div style="text-align: center;"> <p>3</p>  </div> </div> <p>Before closing the battery-chamber/memory card slot cover, fully insert the cord of the power connector into the slot in the battery chamber. If part of the cord runs out of the slot, the cover or cord may be damaged when the cover is closed.</p> <p>Insert the DC plug of the AC Adapter EH-5b into the DC plug connector of the Power Connector EP-5A.</p>
USB cable	USB Cable UC-E6 ¹
Audio/Video cable	Audio Video Cable EG-CP16 ¹
Converter lens	Wide-angle Converter WC-E75A (0.75×) (requires Adapter Ring UR-E22)
Lens adapter ring	Adapter Ring UR-E22
Speedlight (external flash unit)	Speedlight SB-400, SB-600, SB-700, SB-900 Wireless Speedlight Commander SU-800
External microphone	Stereo Microphone ME-1

Remote control

Remote Control ML-L3
How to replace the battery (3 V CR2025 lithium battery) in the remote control.

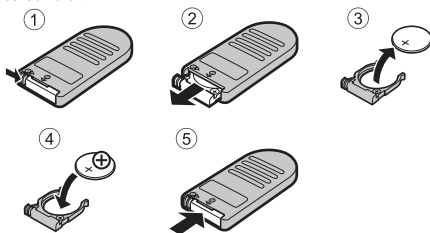

- When changing the remote control battery, be sure that the battery's positive (+) and negative (-) terminals are oriented correctly.
- Be sure to read and follow the warnings for the battery on page vii and the section, "The Battery" (P.3).

¹ Included with the camera at the time of purchase (see "Confirming the Package Contents" (P.ii) for more information).

² When using in other countries, use a commercially available plug adapter as necessary. For more information about plug adapters, consult your travel agency.

See our websites or product catalogs for up-to-date information on accessories for the COOLPIX P7100.

✓ Notes on Converter and Adapter Ring

- Be sure to set **Wide-angle converter** (P.54) to **On**.
- Do not attach lens hoods or filters to the converter lens or adapter ring, as they may cause shading around the edges of images.

Shooting with Remote Control

Use the Remote Control ML-L3 (available separately) (🔗104) to release the shutter. It is convenient for taking self-portraits and effectively eliminates blur caused by camera shake that occurs when the shutter-release button is pressed.

Use of a tripod is recommended during shooting with the remote control. Set **Vibration reduction** (🔗76) in the setup menu to **Off** when using a tripod to stabilize the camera.

- 1 Press ◀ (🕒 self-timer) on the rotary multi selector.

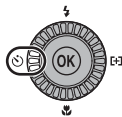

- 2 Select remote control mode using the multi selector and press ▶ to display the setting.

- Select the remote control setting and press the OK button.
- 🕒 (quick-response remote): Press the transmission button on the remote control to shoot instantly.
- 🕒 10s (ten seconds remote): Press the transmission button on the remote control to shoot with ten-second delay.
- 🕒 2s (two seconds remote): Press the transmission button on the remote control to shoot with two-second delay.
- The icon for the selected remote control mode is displayed.
- If the OK button is not pressed within a few seconds, the selection is set and the setting menu disappears.

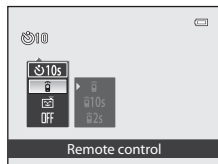

- 3 Frame the picture.

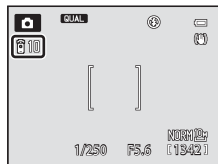

4 Aim the transmitter at the infrared receiver on the front or rear of the camera (📖2, 3) and press the transmission button.

- Press the transmission button from a distance of 5 m (16 ft) or less.
- In the quick-response remote mode, once the subject is in focus, the shutter is released.
- In ten seconds or two seconds remote mode, the self-timer lamp blinks when the subject is in focus, and then about one second before the shutter is released, the lamp stops blinking and remains lit. To stop the timer before a picture is taken, press the transmission button again.
- When the shutter is released in ten seconds or two seconds remote mode, the remote control mode turns to **Off**.

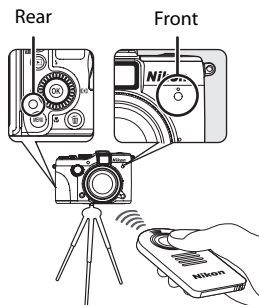









✔ Note on the Remote Control



















This feature may not be used in combination with certain features. See “Features That Cannot Be Used Simultaneously” (📖80) for more information.

Error Messages

The following table lists the error messages and other warnings displayed on the monitor, as well as the solutions for dealing with them.















Display	Description	Solution	
 (blinks)	Clock not set.	Set date and time.	 71
 Battery exhausted.	Battery exhausted.	Charge or replace the battery.	18, 20
 Battery temperature high	Battery temperature is high.	Turn off camera, and allow battery to cool down before resuming use. Five seconds after this message appears, the monitor is turned off, and the power-on lamp, the AF/access lamp and the flash lamp flicker. After the lamps blink for three minutes, the camera turns off automatically, but you can also press the power switch to turn it off manually.	25
 The camera will turn off to prevent overheating.	Inside of the camera has become hot. The camera turns off automatically.	Leave the camera off until the inside of the camera has cooled and then turn it on again.	–
 Please wait for the camera to finish recording.	Camera cannot perform other operations until recording is complete.	Wait until message clears from display automatically when recording is complete.	–
 Memory card is write protected.	Write-protect switch of the memory card is in “lock” position.	Slide the write-protect switch to “write” position.	–
 Not available if Eye-Fi card is locked.	Write-protect switch of Eye-Fi card is in “lock” position.	Slide the write-protect switch to “write” position.	–
	Error accessing Eye-Fi card.	<ul style="list-style-type: none"> • Use an approved card. • Check that connectors are clean. • Confirm that memory card is correctly inserted. 	23 22 22















Error Messages

Display	Description	Solution	
 This card cannot be used.	Error accessing memory card.	<ul style="list-style-type: none"> Use an approved card. Check that connectors are clean. Confirm that memory card is correctly inserted. 	23
 This card cannot be read.			22
 Card is not formatted. Format card? Yes No	Memory card has not been formatted for use in this camera.	All data stored on the memory card is deleted when formatted. If there is any data on the card that you want to keep, select No , and backup the data to a computer before formatting the memory card. To format the memory card, select Yes and press the  button.	22
 Out of memory.	Memory card is full.	<ul style="list-style-type: none"> Choose lower image quality or smaller image size. Delete pictures and movies. Replace memory card. Remove memory card and use internal memory. 	75, 77 36, 102,  64 22 23
 Image cannot be saved.	Error occurred while recording picture.	Format the internal memory or memory card.	 83
	Camera has run out of file numbers.	Replace the memory card, or format the internal memory/memory card.	22,  83
	Picture cannot be used for welcome screen.	The following pictures cannot be used. <ul style="list-style-type: none"> NRW (RAW) images Pictures taken with Image size of  3648x2432,  3584x2016 or  2736x2736 Pictures created with small picture or crop function that are 320 x 240 or smaller 	75 77  14,  19
	There is insufficient space to save a copy.	Delete pictures from destination.	 64
 Sound file cannot be saved.	A voice memo cannot be attached to this file.	<ul style="list-style-type: none"> Voice memos cannot be attached to movies. Select a picture taken with this camera. 	–  67

Display	Description	Solution	
 Image cannot be modified.	Cannot edit selected picture.	<ul style="list-style-type: none"> Confirm the conditions that are required for editing. RAW processing cannot be performed for NRW (RAW) pictures that were taken with cameras other than COOLPIX P7100. These options cannot be used with movies. 	 9 – –
 Cannot record movie.	Time out error while recording movie.	Choose memory card with faster write speed.	23
 Cannot reset file numbering.	No more folders can be created.	Insert a new memory card, or format the internal memory/memory card.	22,  83
 Memory contains no images.	No pictures in the internal memory or memory card.	<ul style="list-style-type: none"> Pictures stored in the internal memory can only be viewed if no memory card is inserted. To copy files from internal memory to memory card, press the MENU button to display the copy screen, then copy the files from internal memory to memory card. 	22  68
 File contains no image data.	File not created with COOLPIX P7100.	File cannot be viewed on this camera. View file using the computer or any other devices which was used to create or edit this file.	–
 All images are hidden.	The picture cannot be played back in a slide show.	–	 63
	All images in the internal memory/memory card are hidden.	Disable the Hide image setting to view images.	 66
 This image cannot be deleted.	Picture is protected.	Disable protection.	 66
 Travel destination is in the current time zone.	Destination in same time zone as home.	–	 73
 Mode dial is not in the proper position.	Mode dial is between two modes.	Rotate the mode dial to select the desired mode.	28

Error Messages

Display	Description	Solution	
 My Menu can not be changed at current settings.	All registered menu items cannot be changed at the current setting.	<ul style="list-style-type: none"> Check the settings of functions that are not registered in My Menu. Change the menu item to be registered in My Menu. 	 90  90
 Raise the flash.	The flash is lowered when the scene mode is Night portrait or Backlighting with HDR set to Off or the Continuous mode is Continuous flash .	Press the  (flash pop-up) button to raise the flash.	41, 44, 61,  45
	The flash is not raised during the scene auto selector.	Press the  (flash pop-up) button to raise the flash. The camera can still shoot normally with the flash lowered if you do not wish to use it.	40, 61
 Speedlight setting error	Group A has not been selected for group setting when shooting using wireless multiple flash-unit photography.	Set the group setting of the master commander and remote flash unit to Group A.	 102
Lens error 	Lens is not operating properly.	Turn camera off and then on again. If error persists, contact retailer or Nikon-authorized service representative.	25
 Communications error	Error occurred during communication with printer.	Turn off camera and reconnect cable.	 23
System error 	Error has occurred in camera's internal circuitry.	Turn off camera, remove and reinsert battery, and turn on camera. If the error persists, contact retailer or Nikon-authorized service representative.	25
 Initializing lens. Cannot focus.	The camera cannot focus.	Wait until the camera recovers automatically.	–

Display	Description	Solution	
 Printer error: check printer status.	Printer error	Check printer. After solving the problem, select Resume and press the  button to resume printing.*	–
 Printer error: check paper	Specified size of paper is not loaded.	Load the specified size of paper, select Resume and press the  button to resume printing.*	–
 Printer error: paper jam	Paper has jammed in the printer.	Remove the jammed paper, select Resume and press the  button to resume printing.*	–
 Printer error: out of paper	No paper is loaded in the printer.	Load the specified size of paper, select Resume and press the  button to resume printing.*	–
 Printer error: check ink	Ink error	Check ink, select Resume and press the  button to resume printing.*	–
 Printer error: out of ink	Ink cartridge is empty.	Replace ink cartridge, select Resume and press the  button to resume printing.*	–
 Printer error: file corrupt	An error caused by the image file has occurred.	Select Cancel and press the  button to cancel printing.	–

* See the instruction manual provided with your printer for further guidance and information.



A series of horizontal dashed lines spanning the width of the page, intended for handwriting practice.



Technical Notes and Index

Caring for the Products	2
The Camera.....	2
The Battery.....	3
The Battery Charger.....	4
The Memory Cards.....	5
Caring for the Camera	6
Cleaning.....	6
Storage.....	6
Troubleshooting	7
Specifications.....	13
Supported Standards.....	16
Index.....	17

Caring for the Products

The Camera

To ensure continued enjoyment of this Nikon product, observe the following precautions when using or storing the device.

Be sure to read and follow the warnings of “For your Safety” (📖vi to 📖viii) thoroughly before using the products.

✔ **Keep Dry**

The device will be damaged if immersed in water or subjected to high humidity.

✔ **Do Not Drop**

The product may malfunction if subjected to strong shock or vibration.

✔ **Handle the Lens and All Moving Parts with Care**

Do not apply force to the lens, lens cover, monitor, memory card slot, or battery chamber. These parts are easily damaged. Applying force to the lens cover could result in camera malfunction or damage to the lens. Should the monitor break, care should be taken to avoid injury caused by broken glass and to prevent the liquid crystal from the display touching the skin or entering the eyes or mouth.

✔ **Do Not Point the Lens at Strong Light Sources for Extended Periods**

Avoid pointing the lens at the sun or other strong light sources for extended periods when using or storing the camera. Intense light may cause deterioration of the CCD image sensor, producing a white blur effect in photographs.

✔ **Keep away from Strong Magnetic Fields**

Do not use or store this device in the vicinity of equipment that generates strong electromagnetic radiation or magnetic fields. Strong static charge or the magnetic fields produced by equipment such as radio transmitters could interfere with the monitor, damage data saved on the memory card, or affect the product's internal circuitry.

✔ **Avoid Sudden Changes in Temperature**

Sudden changes in temperature, such as when entering or leaving a heated building on a cold day, can cause condensation to form inside the device. To prevent condensation, place the device in a carrying case or a plastic bag before exposing it to sudden changes in temperature.



✔ **Turn the Product off Before Removing or Disconnecting the Power Source or the Memory Card**

Do not remove the battery while the product is on, or while images are being saved or deleted. Forcibly cutting power in these circumstances could result in loss of data or in damage to product memory or internal circuitry.

The Monitor

- The monitor may contain a few pixels that are always lit or that do not light. This is a characteristic common to all TFT LCD displays, and does not indicate a malfunction. Images saved using the product will not be affected.
- White or colored streaks of light may be visible on the monitor with framing of bright subjects. This phenomenon, known as “smear,” occurs when extremely bright light strikes the image sensor. This is due to characteristics of the image sensor and does not indicate a malfunction. Smear may also cause partial discoloration on monitor display with shooting. Smear does not affect recorded images except when shooting with Continuous set to Multi-shot 16 and when recording movies. When shooting in these modes, avoiding bright objects such as the sun, reflections of the sun, and electric lights is recommended.
- Images on the monitor may be difficult to see under bright lighting.
- The monitor is lit by an LED backlight. Should the monitor begin to dim or flicker, contact your Nikon-authorized service representative.

The Battery

- Be sure to read and follow the warnings of “For Your Safety” (vi to viii) thoroughly before using the battery.
- Check the battery level before using the camera and replace or charge the battery if necessary. Do not continue charging once the battery is fully charged as this will result in reduced battery performance. Whenever possible, carry a fully charged spare battery when taking pictures on important occasions.
- Do not use the battery at ambient temperatures below 0°C (32°F) or above 40°C (104°F).
- Charge the battery indoors with an ambient temperature of 5°C to 35°C (41°F to 95°F) before use.
- When the battery temperature is between 0°C and 10°C (32°F to 50°F) or 45°C to 60°C (113°F to 140°F), the chargeable capacity may decrease.
- The battery is not charged at ambient temperatures below 0°C (32°F) or above 60°C (140°F).
- Note that the battery may become hot during use; wait for the battery to cool before charging. Failure to observe these precautions could damage the battery, impair its performance, or prevent it from charging normally.
- On cold days, the capacity of batteries tends to decrease. Be sure that the battery is fully charged before heading outside to take pictures in cold weather. Keep spare batteries in a warm place and exchange as necessary. Once warmed, a cold battery may recover some of its charge.
- Dirt on the battery terminals can prevent the camera from functioning. Should the battery terminals become dirty, wipe them off with a clean, dry cloth before use.

Caring for the Products

- If the battery will not be used for some time, insert it in the camera and run it flat before removing it for storage. The battery should be stored in a cool location with an ambient temperature of 15°C to 25°C (59°F to 77°F). Do not store the battery in hot or extremely cold locations.
- Always remove the battery from the camera or battery charger when it is not being used. When inserted, minute amounts of current are drawn from the battery even when not in use. This may result in excessive draining of the battery and complete loss of function. Turning the camera on or off while the battery is exhausted can result in reduced battery life. When the battery level is low, be sure to charge the battery before using it.
- Recharge the battery at least once every six months and completely exhaust it before returning it to storage.
- After removing the battery from the camera or battery charger, attach the included terminal cover to the battery and store it in a cool place.
- A marked drop in the time a fully-charged battery retains its charge, when used at room temperature, indicates that the battery needs to be replaced. Purchase a new EN-EL14 battery.
- Replace the battery when it no longer holds a charge. Used batteries are a valuable resource. Please recycle used batteries in accordance with local regulations.

The Battery Charger

- Be sure to read and follow the warnings of "For Your Safety" (📖vi to 📖viii) thoroughly before using the battery charger.
- The included Battery Charger is for use only with a Rechargeable Li-ion Battery EN-EL14.
- The MH-24 is compatible with AC 100-240 V, 50/60 Hz electrical outlets. When using in other countries, use a commercially available plug adapter as necessary. For more information about plug adapters, consult your travel agency.

The Memory Cards

- Use only Secure Digital memory cards. See “Approved Memory Cards” (📖23).
- Be sure to observe the precautions in the memory card documentation when you use the memory card.
- Do not affix labels or stickers to the memory card.
- Do not format the memory card using a computer.
- When a memory card is used for the first time, it is recommended to format it with this camera. In particular, the first time you insert a memory card that has been used in another device into this camera, be sure to format it with this camera.
- Formatting permanently deletes all data in the memory card. Be sure to transfer important pictures to a computer before formatting.
- If the error message “Card is not formatted. Format card?” is displayed when you insert a memory card into this camera, the memory card must be formatted. If the memory card contains images you wish to keep, select **No** and save those images on your computer before formatting the memory card. To format the card, select **Yes** and press the **OK** button.
- Do not perform the following during formatting, while data is being written to or deleted from the memory card, or during data transfer to a computer. Failure to observe this precaution could result in loss of data or damage to the memory card:
 - Open the battery-chamber/memory card slot cover to remove the battery or memory card.
 - Turn off the camera
 - Disconnect the AC adapter

Caring for the Camera

Cleaning

Lens/ viewfinder	Avoid touching glass parts with your fingers. Remove dust or lint with a blower (typically a small device with a rubber bulb attached to one end that is pumped to produce a stream of air out the other end). To remove fingerprints, oily substances, or other stains that cannot be removed with a blower, carefully wipe the lens with a dry soft cloth or eyewear cleaning cloth, using a spiral motion that starts at the center of the lens and working toward the edges. Do not wipe the lens forcibly or with a hard material. Failure to observe this precaution could result in damage or trouble. If this fails, clean the lens using a cloth lightly dampened with commercial lens cleaner.
Monitor	Remove dust or lint with a blower. To remove fingerprints, oily substances or other stains, carefully wipe the monitor with a dry soft cloth or eyewear cleaning cloth. Do not wipe the monitor forcibly or with a hard material. Failure to observe this precaution could result in damage or trouble.
Body	Use a blower to remove dust, dirt, or sand, then wipe gently with a soft, dry cloth. After using the camera at the beach or other sandy or dusty environment, wipe off any sand, dust, or salt with a dry cloth lightly dampened with fresh water and dry thoroughly. Note that foreign matter inside the camera could cause damage not covered by the warranty.

Do not use volatile organic solvents such as alcohol or thinner, chemical detergents, anticorrosive agents, or anti-fogging agents.

Storage

Remove the battery if the camera will not be used for an extended period. Do not store the camera with naphtha or camphor moth balls, or in any of the following locations:

- Next to equipment that produces strong electromagnetic fields, such as televisions or radios
- Exposed to temperatures below -10°C (14°F) or above 50°C (122°F)
- Places that are poorly ventilated or subject to humidity of over 60%

To prevent mold or mildew, take the camera out of storage at least once a month. Turn the camera on and release the shutter a few times before putting the camera away again.





Be sure to read and follow the warnings given in "The Battery" (🔋:3) of "Caring for the Products" to store the battery.



Troubleshooting

If the camera fails to function as expected, check the list of common problems below before consulting your retailer or Nikon-authorized service representative. Refer to the page numbers in the right-most column for more information.

- See “Error Messages” (🔍 107) for more information.

Power, Display, Settings Issues







Problem	Cause/Solution	
Camera turns off without warning.	<ul style="list-style-type: none"> • Battery is exhausted. • If no operations are performed for a while, camera has turned off automatically by auto off to save power. • Inside of the camera has become hot. Leave the camera off until the inside of the camera has cooled. • At low temperatures, the camera and the battery may not function normally. 	24 25 – 🔍:3
Monitor is blank.	<ul style="list-style-type: none"> • Camera is off. • Battery is exhausted. • Standby mode for saving power: Press the power switch, shutter-release button or the  button, or rotate the mode dial. • Monitor is turned off. Press the  button to turn it on. • Camera and computer are connected via USB cable. • Camera and TV are connected via A/V cable or HDMI cable. • Interval timer shooting in progress. 	25 24 25 15 91 91 54
Monitor is hard to see.	<ul style="list-style-type: none"> • Ambient lighting too bright: Use viewfinder or move to darker location. • Adjust monitor brightness. • Monitor is dirty. Clean monitor. • Use monitor brightness boost. 	16 16, 104 🔍:6 16
The viewfinder is hard to read.	Adjust diopter adjustment control.	16
Date and time of recording are not correct.	<ul style="list-style-type: none"> • If the camera clock has not been set (“Date not set” indicator blinks during shooting), recording date and time is recorded as “01/01/11 00:00.” Set the correct date and time using Time zone and date in the setup menu. • The camera clock is not as accurate as a normal clock, such as watches. Check camera clock regularly against more accurate timepieces and reset as required. 	26, 104 104
No information displayed in monitor.	Shooting information and photo information may be hidden. Press the  button until shooting information or photo information is displayed.	15

Problem	Cause/Solution	
Print date not available.	Time zone and date has not been set.	26, 104
Date not appearing on pictures even when Print date is enabled.	<ul style="list-style-type: none"> A shooting mode that does not support print date is selected. Another function that is set now is restricting the print date. The date cannot be imprinted onto a movie. 	104 80 –
Camera settings reset.	Clock battery is exhausted; all settings were restored to their default values.	27
Reset file numbering cannot be done.	<ul style="list-style-type: none"> Reset file numbering cannot be applied when the folder number reaches 999 and there are images in the folder. Change the memory card, or format the internal memory/memory card. Reset file numbering cannot be set when the scene mode is set to Panorama assist, or when the shooting mode is P, S, A, M, U1, U2 or U3 and Intvl timer shooting is chosen for Continuous in the shooting menu. 	104,  83 45
Monitor is turned off, and the power-on lamp flickers.	Battery temperature is high. Turn off camera, and allow battery to cool down before resuming use. After the lamp blinks for three minutes, the camera turns off automatically, but you can also press the power switch to turn it off manually.	25
Camera temperature rises.	When functions such as movie recording or sending images using an Eye-Fi card are used for a long time, or when the camera is used in a location with a high ambient temperature, the camera temperature may rise. This is not a malfunction.	99







● Electronically Controlled Cameras







In extremely rare instances, unusual characters may appear on the monitor and the camera may stop functioning. In most cases, this phenomenon is caused by a strong external static charge. Turn the camera off, remove and replace the battery, then turn the camera on again. Note that disconnecting the power source as described above may result in the loss of any data not recorded on the internal memory or memory card at the time the problem occurred. Data already recorded is not affected. In the event of continued malfunction, contact your retailer or Nikon-authorized service representative.

Shooting Issues





Problem	Cause/Solution	
Cannot set to shooting mode.	Disconnect the HDMI cable or USB cable.	91
No picture taken when shutter-release button is pressed.	<ul style="list-style-type: none"> • When camera is in playback mode, press the  or shutter-release button. • When menus are displayed, press the MENU button. • Battery is exhausted. • When the scene mode is Night portrait or Backlighting with HDR set to Off or Continuous in the shooting menu is set to Continuous flash, raise the flash. • When flash lamp blinks, flash is charging. • Group A has not been selected for group setting when shooting using wireless multiple flash-unit photography. Set the group setting of the master commander and remote flash unit to Group A. 	<p>34</p> <p>13 24 41, 44, 54, 61</p> <p>61 102</p>
Camera cannot focus.	<ul style="list-style-type: none"> • Subject is too close to the camera. Try shooting with  (macro close-up) in the focus mode, or Scene auto selector or Close-up scene mode. • The intended subject is one with which autofocus does not perform well. • Set AF assist in the setup menu to Auto. • Subject not in focus area when shutter-release button pressed halfway. • The focus mode is set to MF (manual focus). • Turn camera off and then on again. 	<p>40, 42, 67</p> <p>33</p> <p>104 32, 54</p> <p>67 25</p>
Pictures are blurred.	<ul style="list-style-type: none"> • Use flash. • Use vibration reduction and motion detection. • Use BSS (Best Shot Selector). • Use a tripod to stabilize the camera (use with the self-timer for better results). 	<p>61</p> <p>54</p> <p>54</p> <p>64</p>
Streaks of light or partial discoloration are visible on the monitor.	Smear occurs when extremely bright light strikes the image sensor. When shooting with Continuous set to Multi-shot 16 and when recording movies, avoiding bright objects, such as the sun, reflections of the sun, and electric lights is recommended.	 :2
Bright specks appear in pictures shot using flash.	Flash is reflecting off particles in air. Set the flash to  (off).	62

Troubleshooting

Problem	Cause/Solution	
Flash does not fire.	<ul style="list-style-type: none"> Flash is set to  (off). A scene mode that cannot turn on flash is selected. The movie mode is selected. Another function that is set now is restricting the flash. Built-in flash does not fire when a Speedlight (external flash unit) (available separately) is used. 	62 61 98 80  101
Zoom does not operate.	<ul style="list-style-type: none"> On is selected for Wide-angle converter in the shooting menu. When the lens ring is removed while the camera is on, the zoom is fixed in a wide-angle end. Turn the camera off, attach the lens ring, and then turn the camera on again. Remove the wide-angle converter, and attach the lens ring. 	54,  54  54  54
The digital zoom is not available.	<ul style="list-style-type: none"> Off is selected for Digital zoom in the setup menu. When Scene auto selector, Portrait, Night portrait, Backlighting with HDR set to On or Pet portrait is selected in scene mode, the digital zoom cannot be used. Other functions that restrict the use of digital zoom is set. 	104 40, 41, 44, 45 80
Image size not available.	Another function that is set now is restricting Image size .	80
No sound when shutter is released.	<ul style="list-style-type: none"> Off is selected for Shutter sound under Sound settings in the setup menu. Sports, Museum, Backlighting with HDR set to On or Pet portrait is selected in scene mode. The movie mode is selected. Other functions that restrict the use of the shutter sound are set. Do not block the speaker. 	104 41, 43, 44, 45 98 80 3
AF-assist illuminator does not light.	Off is selected for AF assist in the setup menu. Even when Auto is set, AF-assist illuminator may not light depending on the focus area position or scene mode.	104
Pictures appear smeared.	Lens is dirty. Clean lens.	 6
Colors are unnatural.	White balance does not match light source.	72
Ring-shaped or rainbow-colored bands are seen on the screen or the shot image.	When the subject is backlit or when shooting with an extremely bright light source in the display, such as in sunlight, ring-shaped or rainbow-colored bands may appear on the image. Change the position of the light source or remove it from the display, and try shooting again.	–

Problem	Cause/Solution	
Randomly spaced bright pixels ("noise") appear in image.	As the subject is dark, shutter speed is too slow or ISO sensitivity is too high. <ul style="list-style-type: none"> • Use flash. • Specify a lower ISO sensitivity setting. • Apply Long exposure NR in the shooting menu to suit situations. 	61 72 54
Pictures are too dark (underexposed).	<ul style="list-style-type: none"> • Flash is set to  (off). • Flash window is blocked. • Subject is beyond flash range. • Adjust exposure compensation. • Raise the ISO sensitivity. • Subject is backlit. Raise the flash, and set the scene mode to Backlighting with HDR set to Off or set the flash mode to  (fill flash). • On is selected for Built-in ND filter in the setup menu. 	62 30 61 71 72 44, 61  85
Pictures are too bright (overexposed).	<ul style="list-style-type: none"> • Adjust exposure compensation. • Use Built-in ND filter setting in the setup menu. 	71 104
Areas not affected by red-eye are also corrected.	When  (auto with red-eye reduction) or "fill flash with red-eye reduction" of the Night portrait scene mode is applied during shooting, In-Camera Red-Eye Fix may, in very rare cases, be applied to areas not affected by red-eye. Set a flash mode other than  (auto with red-eye reduction), select a scene mode other than Night portrait , and resume shooting.	41, 61
Skin softening results are not as expected.	<ul style="list-style-type: none"> • Skin softening may not produce the desired results depending on shooting conditions. • For pictures with four or more faces, try using Skin softening in the playback menu. 	86 89
Saving images takes time.	It may take more time to save images in the following situations. <ul style="list-style-type: none"> • When the noise reduction function is in operation • When flash is set to  (auto with red-eye reduction) • When using Portrait or Night portrait scene mode while shooting • When using smile timer while shooting • When using Active D-Lighting while shooting • When Image quality is set to NRW (RAW), NRW (RAW) + Fine, NRW (RAW) + Normal or NRW (RAW) + Basic 	54 62 40, 41 65 54 75
Cannot set or use Continuous or Auto bracketing .	Another function that is set now is restricting the Continuous setting or Auto bracketing .	80
Cannot set COOLPIX Picture Control.	Another function that is set now is restricting COOLPIX Picture Control.	80

Playback Issues

Problem	Cause/Solution	
File cannot be played back.	<ul style="list-style-type: none"> File was overwritten or renamed by computer or another make or model of camera. File cannot be played back during interval timer shooting. NRW (RAW) images or movies recorded with cameras other than COOLPIX P7100 cannot be played back. 	– 54 75, 98
Cannot zoom in on picture.	<ul style="list-style-type: none"> Playback zoom cannot be used with movies, small pictures, or cropped copies of size 320 × 240 pixels or smaller. Playback zoom may not be available for pictures taken with cameras other than COOLPIX P7100. 	– –
Cannot record or play back voice memo.	<ul style="list-style-type: none"> Voice memos cannot be attached to movies. Voice memos cannot be attached to pictures taken with cameras other than COOLPIX P7100, and voice memos recorded by other cameras cannot be played back. 	102 89
Pictures and movies cannot be edited.	<ul style="list-style-type: none"> Confirm the conditions that are required for editing pictures or movies. Pictures and movies taken with cameras other than COOLPIX P7100 cannot be edited. 	70,  10 –
Pictures not displayed on television.	<ul style="list-style-type: none"> Video mode or HDMI is not correctly set in the TV settings setup menu. Cables are connected to both the HDMI mini connector and USB/audio video connector. Memory card contains no pictures. Replace memory card. Remove memory card to play back pictures from internal memory. 	104 91 22
Nikon Transfer 2 does not start when camera is connected to a computer.	<ul style="list-style-type: none"> Camera is off. Battery is exhausted. USB cable is not correctly connected. Camera is not recognized by the computer. Confirm that the operating system used is compatible with the camera. Computer is not set to launch Nikon Transfer 2 automatically. For more information on Nikon Transfer 2, refer to help information contained in ViewNX 2. 	25 24 91 – 92 95
Pictures to be printed are not displayed.	<ul style="list-style-type: none"> Memory card contains no pictures. Replace memory card. Remove memory card to print pictures from internal memory. 	22 23
Cannot select paper size with camera.	Paper size cannot be selected from the camera in the following situations, even for PictBridge compatible printers. Use the printer to select paper size. <ul style="list-style-type: none"> The paper size selected using the camera is not compatible with the printer. A printer that automatically sets the paper size is being used. 	 24,  25 –

Specifications

Nikon COOLPIX P7100 Digital Camera

Type	Compact digital camera
Effective pixels	10.1 million
Image sensor	1/1.7-in. type CCD; approx. 10.39 million total pixels
Lens	7.1× optical zoom, NIKKOR lens
Focal length	6.0-42.6mm (angle of view equivalent to that of 28-200 mm lens in 35mm [135] format)
f/-number	f/2.8-5.6
Construction	11 elements in 9 groups (including 2 ED lens elements)
Digital zoom	Up to 4× (angle of view equivalent to that of approx. 800 mm lens in 35mm [135] format)
Vibration reduction	Lens shift
Autofocus (AF)	Contrast-detect AF
Focus range (from lens)	<ul style="list-style-type: none">• Approx. 50 cm (1 ft 8 in.) to ∞ (W), approx. 80 cm (2 ft 8 in.) to ∞ (T)• Macro close-up mode: Approx. 2 cm (0.8 in.) (at a wide-angle position) to ∞
Focus-area selection	Face priority, auto (9-area automatic selection), center (wide, normal, spot), manual with 99 focus areas, subject tracking
Viewfinder	Real-image optical viewfinder, with diopter adjustment function (-3 to +1 m ⁻¹)
Frame coverage	Approx. 80% horizontal and 80% vertical (compared to actual picture)
Monitor	7.5 cm (3-in.), approx. 921k-dot, wide viewing angle TFT LCD monitor with anti-reflection coating and 5-level brightness adjustment, tiltable approx. 81° downward, approx. 105° upward
Frame coverage (shooting mode)	Approx. 96% horizontal and 96% vertical (compared to actual picture)
Frame coverage (playback mode)	Approx. 100% horizontal and 100% vertical (compared to actual picture)
Storage	
Media	Internal memory (approx. 94 MB) SD/SDHC/SDXC memory card
File system	DCF, Exif 2.3, and DPOF compliant
File formats	Still pictures: JPEG, NRW (RAW) <ul style="list-style-type: none">• RAW and JPEG can be recorded simultaneously Sound files (voice memo): WAV Movies: MOV (Video: H.264/MPEG-4 AVC, Audio: AAC stereo)

Specifications

Image size (pixels)	<ul style="list-style-type: none"> • 10 M 3648×2736 • 5 M 2592×1944 • 2 M 1600×1200 • PC 1024×768 • 3:2 3648×2432 • 1:1 2736×2736 • 8 M 3264×2448 • 3 M 2048×1536 • 1 M 1280×960 • VGA 640×480 • 16:9 3584×2016
ISO sensitivity (Standard output sensitivity)	<ul style="list-style-type: none"> • ISO 100, 200, 400, 800, 1600, 3200, Hi 1 (equivalent to 6400) • Auto (auto gain from ISO 100 to 800) • High ISO sensitivity auto (ISO 100 to 1600) • Fixed range auto (ISO 100 to 200, 100 to 400) • Low noise night mode (ISO 400 to 12800)
Exposure	
Metering	256-segment matrix, center-weighted, spot, spot AF area (with support for 99 focus areas)
Exposure control	Programmed auto exposure with flexible program, shutter priority auto, aperture-priority auto, manual, exposure bracketing (Tv), exposure bracketing (Sv), motion detection, exposure compensation (–3.0 to +3.0 EV in steps of 1/3 EV)
Shutter	Mechanical and charge-coupled electronic shutter
Speed	<ul style="list-style-type: none"> • 1/2000 - 8 s (P, S mode) • 1/4000 - 8 s (A mode) • 1/4000 - 60 s (M mode) • 4 s (Fireworks show scene mode) • 1/2000 - 2 s (in shooting modes other than the above)
Aperture	Electronically-controlled 6-blade iris diaphragm
Range	10 steps of 1/3 EV (W) (A , M mode)
Self-timer	Durations of 2 or 10 seconds can be selected
Built-in flash	
Range (approx.) (ISO sensitivity: Auto)	[W]: 0.3 to 9.0 m (1 ft to 29 ft) [T]: 0.3 to 4.5 m (1 ft to 14 ft)
Flash control	TTL auto flash with monitor preflashes
Accessory shoe	ISO 518 hot-shoe contact with sync and data contacts and safety lock
Interface	Hi-Speed USB
Data transfer protocol	MTP, PTP
Video output	Can be selected from NTSC and PAL
HDMI output	Can be selected from Auto, 480p, 720p, and 1080i

I/O terminal	Audio/video output; digital I/O (USB); HDMI Mini Connector (Type C) (HDMI output), external microphone connector (stereo mini-pin jack (3.5 mm diameter), plug-in power type)
Supported languages	Arabic, Brazilian Portuguese, Chinese (Simplified and Traditional), Czech, Danish, Dutch, English, Finnish, French, German, Greek, Hindi, Hungarian, Indonesian, Italian, Japanese, Korean, Norwegian, Polish, Portuguese, Romanian, Russian, Spanish, Swedish, Thai, Turkish, Ukrainian, Vietnamese
Power sources	<ul style="list-style-type: none"> One Rechargeable Li-ion Battery EN-EL14 (included) AC Adapter EH-5b (used in combination with the Power Connector EP-5A) (available separately)
Battery life (EN-EL14)	Still pictures ¹ : Approx. 350 shots Movies ² : Approx. 2 h 55 min (HD 720p (1280x720))
Tripod socket	1/4 (ISO 1222)
Dimensions (W × H × D)	Approx. 116.3 × 76.9 × 48.0 mm (4.6 × 3.1 × 1.9 in.) (excluding projections)
Weight	Approx. 395 g (14 oz) (including battery and SD memory card)
Operating environment	
Temperature	0°C to 40°C (32°F to 104°F)
Humidity	85% and below (no condensation)

- Unless otherwise stated, all figures are for a camera with a fully-charged Rechargeable Li-ion Battery EN-EL14 operated at an ambient temperature of 25°C (77°F).

¹ Based on Camera and Imaging Products Association (CIPA) standards for measuring the life of camera batteries. Measured at 23 (±2)°C (73 (±4)°F); zoom adjusted with each shot, flash fired with every other shot, image quality set to **Normal**, image size set to  **3648x2736**. Battery life may vary depending on shooting interval and length of time menus and images are displayed.

² When recording a single movie, the maximum recording time is 29 minutes even when there is enough free space on the memory card.

Rechargeable Li-ion Battery EN-EL14

Type	Rechargeable lithium-ion battery
Rated capacity	DC 7.4 V, 1030 mAh
Operating temperature	0°C to 40°C (32°F to 104°F)
Dimensions (W × H × D)	Approx. 38 × 53 × 14 mm (1.5 × 2.1 × 0.6 in.) (excluding projections)
Weight	Approx. 48 g (1.7 oz) (excluding terminal cover)

Battery Charger MH-24

Rated input	AC 100 to 240 V, 50/60 Hz, 0.2 A max.
Rated output	DC 8.4 V, 0.9 A
Supported rechargeable battery	Rechargeable Li-ion Battery EN-EL14
Charging time	Approx. 1 hour and 30 minutes when no charge remains
Operating temperature	0°C to 40°C (32°F to 104°F)
Dimensions (W × H × D)	Approx. 70 × 26 × 97 mm (2.8 × 1.0 × 3.8 in.) For Argentina: Approx. 70 × 68 × 104 mm (2.8 × 2.7 × 4.1 in.)
Weight	Approx. 89 g (3.1 oz), excluding plug adapter For Argentina: Approx. 125 g (4.5 oz)

Specifications

- Nikon will not be held liable for any errors this manual may contain.
- The appearance of this product and its specifications are subject to change without notice.

Supported Standards

- **DCF:** Design Rule for Camera File System is a standard widely used in the digital camera industry to ensure compatibility among different makes of camera.
- **DPOF:** Digital Print Order Format is an industry-wide standard that allows pictures to be printed at a digital photo lab or with a household printer from print orders stored on the memory card.
- **Exif version 2.3:** This camera supports Exif (Exchangeable Image File Format for Digital Still Cameras) version 2.3, a standard that allows information stored with photographs to be used for optimal color reproduction when images are output from Exif-compliant printers.
See the instruction manual of the printer for further details.
- **PictBridge:** A standard developed cooperatively by the digital camera and printer industries, allowing photographs to be output directly to a printer without connecting the camera to a computer.

Index

Symbols

AE/AF-L 4

AE-L/AF-L button 5

AF AF area mode 12, 48, 50, 55, 48

A Aperture-priority auto mode 51, 5

OK Apply selection button 6, 12

BKT Auto bracketing 72, 73, 36



Auto mode 28

Delete button 5, 6, 36, 102, 67

Flash mode 61

Flash pop-up button 61

Focus mode 67

Fn1 FUNC1 button 5, 57, 88, 89

Fn2 FUNC2 button 5, 90



QUAL Image quality/Image size/Movie options 72, 73, 74, 42

Image thumbnail display 35

ISO ISO sensitivity 72, 73, 30

List by date button 6, 88

Low noise night mode 49

M Manual mode 51, 7

MENU Menu button 4, 6, 13

Monitor button 15

Movie mode 98

My Menu 72, 73, 90

Picture Control 73, 38

Playback button 5, 6, 34

Playback zoom 35

P Programmed auto mode 51, 5

SCENE Scene mode 39

Self-timer/Remote control/Smile timer 64, 65, 105

S Shutter-priority auto mode 51, 5

EFFECTS Special effects mode 46

T Tele 31

U1, U2 or U3 User settings mode 57

WB White balance 72, 73, 32

W Wide 31

.JPG 99

.MOV 99

.NRW 99

.WAV 99

A

AC adapter 19, 103

Accessory shoe 101

Accessory Shoe Cover 101



Active D-Lighting 55, 56

Adapter Ring 103

AE/AF lock button 107, 87

AF area mode 48, 50, 55, 48

AF assist 105, 78

AF mode 55, 101, 52, 69

AF/access lamp 32

Aperture value 51

Aperture-priority auto mode 51, 5

Audio/video cable 91, 20



Audio/video-in jack 20

Auto 62

Auto bracketing 73, 36

Auto off 106, 82

Auto with red-eye reduction 62

Autofocus mode 55, 68, 101, 52, 69

AV cable 91, 20, 103

B

Backlighting 44

Battery 18, 20, 103

Battery charger 18, 103

Battery level indicator 24

Battery-chamber/memory card slot cover 20, 22

Beach 41

Best shot selector 54, 45

Black border 90, 15















Blink warning 108, 92

BSS 54, 45











Built-in ND filter 107, 85

Button sound 106, 81





C

- Calendar display 35
- Charger 18,  103
- Close-up  42
- Color temperature  34
- Computer 91
- Continuous 50, 54,  45
- Continuous flash 54,  45
- Contrast  40
- Converter lens  103
- COOLPIX Custom Picture Control 54,  43
- COOLPIX Picture Control 54,  38
- Copy  43
- Crop  19,  28
- Custom Picture Control 54,  43
- Customize command dials 107,  86
- Customize My Menu 108,  90

























D

- Date and time 26,  71
- Daylight saving time 27
- Delete 36, 89, 102,  64,  67
- Delete button options 107,  86
- Digital zoom 31, 105,  79
- Diopter adjustment control 16
- Direct Print  22
- Distortion control 55,  54
- D-Lighting 89,  11
- DPOF printing  27
- DSCN  99
- Dusk/dawn  42

E

- Editing movies  28
- Editing Pictures  9
- Exposure compensation 71
- Exposure compensation dial 71
- Exposure mode 51
- Extension  99
- External mic sensitivity 107,  84
- Extracting still pictures 102
- Eye-Fi upload 108,  93
- Eyelet for camera strap 7







E

- Face detection 85
- Face priority 55,  48
- Features that cannot be used simultaneously 80
- File name  99
- Fill flash 62
- Filter effects 89,  13,  40
- Fireworks show  43
- Firmware version 108,  98
- Fixed aperture 106,  80
- Flash 61
- Flash control 55,  55
- Flash exp. comp. 50, 55,  52
- Flash mode 61
- Fn1 + command dial 108,  89
- Fn1 + shutter button 107,  88
- Fn1 guide display 108,  89
- Fn2 button 108,  90
- Focal length  57,  13
- Focus 32,  48,  52
- Focus area 32,  48
- Focus lock 33
- Focus mode 67
- Folder name  99
- Food  43
- Format 22, 106,  83
- Format the internal memory 106,  83
- Format the memory card 22,  83
- FSCN  99
- Full-frame playback 34









H

- HDMI 107,  20,  84
- HDMI device control 107,  84
- HDMI mini connector 91,  20
- HDR 44
- Hide image 89,  66
- Histogram 15, 104,  74











I





- Identifier  99
- Image copy 90,  68
- Image quality 74, 75
- Image sharpening  40
- Image size 74, 77
- Infinity 68
- Internal memory indicator 24
- Interval Timer Shooting 54,  45,  46
- ISO sensitivity 73,  30

L





- Landscape  40
- Language 106,  83
- Lens  6,  13
- Lens ring 2,  54
- Lens ring release button 2,  54
- Li-ion rechargeable battery 18,  103
- List by date mode 88
- Lithium-ion type battery 18,  103
- Long exposure NR 55,  53
- Low noise night mode 49
- Low noise night mode menu 50

M

- Macro close-up 68
- Main command dial 4, 6
- Manual 62
- Manual focus 68,  2
- Manual mode 51,  7
- Memory capacity 24
- Memory card 22, 23
- Memory card slot 22
- Metering 50, 54,  44
- MF distance indicator units 108,  94
- Microphone 98,  67
- Minimum shutter speed 73,  31
- Monitor 7, 8, 10,  6
- Monitor brightness 104,  74
- Monitor brightness boost indicator 16
- Monitor settings 104,  74
- Motion detection 105,  77
- Movie length 100
- Movie menu 101

- Movie mode 98
- Movie options 73,  42
- Movie playback 102
- Movie recording 98
- Multi selector 4, 6, 12, 60
- Multi selector right press 107,  86
- Multi-shot 16 54,  45
- Museum  43





















N

- Night landscape  42
- Night portrait  41
- Noise reduction filter 55,  53
- NRW (RAW) Images 76,  17
- NRW (RAW) processing 90,  17
- Number of exposures remaining 24, 78

O

- Off 62
- Optical zoom 31
- Optional accessories  103

P

- Panorama assist  45,  3
- Paper size  24,  25
- Party/indoor  41
- Pet portrait  45
- Photo info 104,  74
- PictBridge  22,  16
- Picture Control 72, 73,  38
- Playback 34, 102,  67
- Playback menu 89
- Playback mode 34
- Playback zoom 35
- Portrait  40
- Power 24, 25, 26
- Power connector 19,  103
- Power switch/power-on lamp 25
- Preset manual  35
- Pressing halfway 4, 32
- Print  22,  24,  25
- Print date 104,  75
- Print order 89,  60
- Print order date option  61
- Printer 91,  22

Index

Programmed auto mode 51, 5

Protect 89, 66

Q

Quick adjust 40

Quick menu 72

Quick menu dial 72

Quick retouch 89, 11

R

Rear-curtain sync 62

Rechargeable battery 18, 103

Record orientation 106, 81

Red-eye reduction 105, 78

Remote control 12, 105

Reset all 108, 94

Reset file numbering 108, 91

Reverse indicators 108, 94

Rotary multi selector 4, 6, 12, 60

Rotate image 89, 66

Rotate tall 106, 82

RSCN 99

S

Saturation 40

Save user setting 58

Scene auto selector 40

Scene mode 39, 40

Selecting pictures 65

Self-timer 64

Self-timer lamp 64

Self-timer: after release 104, 76

Setup menu 104

Shooting 28

Shooting date information 15

Shooting menu 54

Shutter sound 106, 81

Shutter speed 51

Shutter-priority auto mode 51, 5

Shutter-release button 4, 6, 32

Single 54, 45

Skin softening 65, 86, 89, 12

Slide show 89, 63

Slow sync 62

Small picture 89, 14



Smile timer 65

Snow 42

Sound settings 106, 81

Special effects menu 48

Special effects mode 46



Speedlight 84, 101, 103

Sports 41

SSCN 99

Straighten 90, 16

Sub-command dial 4, 6

Subject tracking 55, 49, 50

Sunset 42

T

Tele 31

Thumbnail playback 35

Time difference 73

Time zone 26, 73

Time zone and date 26, 104, 71



Toning 41

TV settings 107, 84

U

USB cable 91, 23, 103

USB/audio/video output connector 91,

20, 23

User setting modes 57

V

Vibration reduction 105, 76

Video mode 107, 84

View grid 39

View/hide framing grid 104, 74

View/hide histograms 104, 74

Viewfinder 16, 6

ViewNX 2 92

Virtual horizon 104, 74

Virtual horizon display 104, 74

Voice memo 90, 67

Volume 102

W

Welcome screen 104, 70

White balance 73, 32

Wide 31

Wide-angle converter 55, 54, 103

Wind noise reduction 101, 69

Z

Zoom 31

Zoom control 4, 6, 31

Zoom memory 56, 57

Zoom speed 106, 80

Nikon

No reproduction in any form of this manual, in whole or in part (except for brief quotation in critical articles or reviews), may be made without written authorization from NIKON CORPORATION.



NIKON CORPORATION

© 2011 Nikon Corporation

FX1102(11)
6MM09811-02