

Nikon

DIGITAL CAMERA

COOLPIX P500

User's Manual

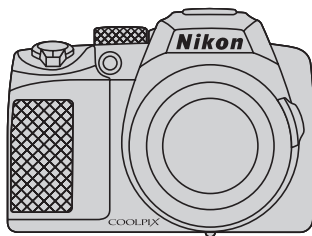

En

Trademark Information

- Microsoft, Windows and Windows Vista are either registered trademarks or trademarks of Microsoft Corporation in the United States and/or other countries.
- Macintosh, Mac OS, and QuickTime are trademarks of Apple Inc., registered in the U.S. and other countries. The iFrame logo and the iFrame symbol are trademarks of Apple Inc.
- Adobe and Acrobat are registered trademarks of Adobe Systems Inc.
- SDXC, SDHC and SD Logos are trademarks of SD-3C, LLC.
- PictBridge is a trademark.
- HDMI, **HDMI** logo and High-Definition Multimedia Interface are trademarks or registered trademarks of HDMI Licensing LLC.
- All other trade names mentioned in this manual or the other documentation provided with your Nikon product are trademarks or registered trademarks of their respective holders.

AVC Patent Portfolio License

This product is licensed under the AVC Patent Portfolio License for the personal and non-commercial use of a consumer to (i) encode video in compliance with the AVC standard ("AVC video") and/or (ii) decode AVC video that was encoded by a consumer engaged in a personal and non-commercial activity and/or was obtained from a video provider licensed to provide AVC video. No license is granted or shall be implied for any other use. Additional information may be obtained from MPEG LA, L.L.C.

See <http://www.mpegla.com>.

Introduction

First Steps

Basic Photography and Playback: 📷 (Auto) Mode

More on Shooting

More on Playback

Editing Pictures

Movie Recording and Playback

Connecting to Televisions, Computers and Printers

Basic Camera Setup

Caring for the Camera

Technical Notes and Index

For Your Safety

To prevent damage to your Nikon product or injury to yourself or to others, read the following safety precautions in their entirety before using this equipment. Keep these safety instructions where all those who use the product will read them.



This icon marks warnings, information that should be read before using this Nikon product, to prevent possible injury.

WARNINGS

Turn off in the event of malfunction

Should you notice smoke or an unusual smell coming from the camera or Charging AC Adapter, unplug the Charging AC Adapter and remove the battery immediately, taking care to avoid burns. Continued operation could result in injury. After removing or disconnecting the power source, take the equipment to a Nikon-authorized service representative for inspection.

Do not disassemble

Touching the internal parts of the camera or Charging AC Adapter could result in injury. Repairs should be performed only by qualified technicians. Should the camera or Charging AC Adapter break open as the result of a fall or other accident, take the product to a Nikon-authorized service representative for inspection, after unplugging the product and/or removing the battery.

Do not use the camera or Charging AC Adapter in the presence of flammable gas

Do not use electronic equipment in the presence of flammable gas, as this could result in explosion or fire.

Do not look at the sun through the viewfinder

Viewing the sun or other strong light source through the viewfinder could cause permanent visual impairment.

Handle the camera strap with care

Never place the strap around the neck of an infant or child.

Keep out of reach of children

Particular care should be taken to prevent infants from putting the battery or other small parts into their mouths.

 Observe caution when handling the battery

The battery may leak or explode if improperly handled. Observe the following precautions when handling the battery for use in this product:

- Before replacing the battery, turn the product off. If you are using the Charging AC Adapter/AC adapter, be sure it is unplugged.
 - Use only a Rechargeable Li-ion Battery EN-EL5 (supplied). Charge the battery by inserting it into the camera and connecting the Charging AC Adapter EH-69P (supplied).
 - When inserting the battery, do not attempt to insert it upside down or backwards.
 - Do not short or disassemble the battery or attempt to remove or break the battery insulation or casing.
 - Do not expose the battery to flame or to excessive heat.
 - Do not immerse in or expose to water.
 - Replace the terminal cover when transporting the battery. Do not transport or store with metal objects such as necklaces or hairpins.
 - The battery is prone to leakage when fully discharged. To avoid damage to the product, be sure to remove the battery when no charge remains.
 - Discontinue use immediately should you notice any change in the battery, such as discoloration or deformation.
- If liquid from the damaged battery comes in contact with clothing or skin, rinse immediately with plenty of water.

 Observe the following precautions when handling the Charging AC Adapter

- Keep dry. Failure to observe this precaution could result in fire or electric shock.
- Dust on or near the metal parts of the plug should be removed with a dry cloth. Continued use could result in fire.
- Do not handle the plug or go near the Charging AC Adapter during lightning storms. Failure to observe this precaution could result in electric shock.
- Do not damage, modify, forcibly tug or bend the USB cable, place it under heavy objects, or expose it to heat or flames. Should the insulation be damaged and the wires become exposed, take it to a Nikon-authorized service representative for inspection. Failure to observe these precautions could result in fire or electric shock.
- Do not handle the plug or Charging AC Adapter with wet hands. Failure to observe this precaution could result in electric shock.
- Do not use with travel converters or adapters designed to convert from one voltage to another or with DC-to-AC inverters. Failure to observe this precaution could damage the product or cause overheating or fire.

 **Use appropriate cables**

When connecting cables to the input and output jacks, use only the cables provided or sold by Nikon for the purpose, to maintain compliance with product regulations.

 **Handle moving parts with care**

Be careful that your fingers or other objects are not pinched by the lens cover or other moving parts.

 **CD-ROMs**

The CD-ROMs supplied with this device should not be played back on audio CD equipment. Playing CD-ROMs on an audio CD player could cause hearing loss or damage the equipment.

 **Observe caution when using the flash**

Using the flash close to your subject's eyes could cause temporary visual impairment. Particular care should be observed if photographing infants, when the flash should be no less than 1 m (3 ft. 4 in.) from the subject.

 **Do not operate the flash with the flash window touching a person or object**

Failure to observe this precaution could result in burns or fire.

 **Avoid contact with liquid crystal**

Should the monitor break, care should be taken to avoid injury caused by broken glass and to prevent liquid crystal from the monitor touching the skin or entering the eyes or mouth.

 **Turn the power off when using inside an airplane or the hospital**

Turn the power off while inside the airplane during take off or landing. Follow the instructions of the hospital when using while in a hospital. The electromagnetic waves given out by this camera may disrupt the electronic systems of the airplane or the instruments of the hospital.

Notices

Notices for Customers in the U.S.A.

IMPORTANT SAFETY INSTRUCTIONS- SAVE THESE INSTRUCTIONS.

DANGER – TO REDUCE THE RISK OF FIRE OR ELECTRIC SHOCK, CAREFULLY FOLLOW THESE INSTRUCTIONS

For connection to a supply not in the U.S.A., use an attachment plug adapter of the proper configuration for the power outlet if needed.

The power supply unit is intended to be correctly orientated in a vertical or floor mount position.

Federal Communications Commission (FCC) Radio Frequency Interference Statement

This equipment has been tested and found to comply with the limits for a Class B digital device, pursuant to Part 15 of the FCC rules. These limits are designed to provide reasonable protection against harmful interference in a residential installation. This equipment generates, uses, and can radiate radio frequency energy and, if not installed and used in accordance with the instructions, may cause harmful interference to radio communications. However, there is no guarantee that interference will not occur in a particular installation. If this equipment does cause harmful

interference to radio or television reception, which can be determined by turning the equipment off and on, the user is encouraged to try to correct the interference by one or more of the following measures:

- Reorient or relocate the receiving antenna.
- Increase the separation between the equipment and receiver.
- Connect the equipment into an outlet on a circuit different from that to which the receiver is connected.
- Consult the dealer or an experienced radio/television technician for help.



Nikon

COOLPIX P500

CAUTIONS

Modifications

The FCC requires the user to be notified that any changes or modifications made to this device that are not expressly approved by Nikon Corporation may void the user's authority to operate the equipment.

Interface Cables

Use the interface cables sold or provided by Nikon for your equipment. Using other interface cables may exceed the limits of Class B Part 15 of the FCC rules.

Notice for Customers in the State of California

WARNING

Handling the cord on this product will expose you to lead, a chemical known to the State of California to cause birth defects or other reproductive harm.

Wash hands after handling.

Nikon Inc.,
1300 Walt Whitman Road,
Melville, New York 11747-3064
USA
Tel: 631-547-4200

Notice for Customers in Canada

CAUTION

This Class B digital apparatus complies with Canadian ICES-003.

ATTENTION

Cet appareil numérique de la classe B est conforme à la norme NMB-003 du Canada.

Notices for Customers in Europe

CAUTION

RISK OF EXPLOSION IF BATTERY IS REPLACED BY AN INCORRECT TYPE. DISPOSE OF USED BATTERIES ACCORDING TO THE INSTRUCTIONS.

This symbol indicates that this product is to be collected separately.

The following apply only to users in European countries:



- This product is designated for separate collection at an appropriate collection point. Do not dispose of as household waste.
- For more information, contact the retailer or the local authorities in charge of waste management.

This symbol on the battery indicates that the battery is to be collected separately.



The following apply only to users in European countries:

- All batteries, whether marked with this symbol or not, are designated for separate collection at an appropriate collection point. Do not dispose of as household waste.
- For more information, contact the retailer or the local authorities in charge of waste management.

Table of Contents

For Your Safety	ii
WARNINGS	ii
Notices	v
<hr/>	
Introduction	1
About This Manual	1
Information and Precautions	2
Parts of the Camera	4
Camera Body	4
Changing the Angle of the Monitor	6
Raising and Lowering the Flash	7
Attaching the Camera Strap and Lens Cap	7
Monitor	8
Basic Operations	11
Command Dial	11
Multi Selector	12
MENU (Menu) Button	13
Switching Between Tabs in the Menu Screen	13
Using Camera Menus	14
Pressing the Shutter-Release Button Halfway/All the Way	15
\square (Monitor) Button	16
DISP (Display) Button	17
<hr/>	
First Steps	18
Inserting the Battery	18
Removing the Battery	19
Charging the Battery	20
Turning On and Off the Camera	23
Setting the Display Language, Date and Time	24
Inserting the Memory Card	26
Removing the Memory Card	26

Table of Contents

Basic Photography and Playback: A (Auto) Mode.....	28
Step 1 Turn the Camera On and Select A (Auto) Mode.....	28
Indicators Displayed in A (Auto) Mode.....	29
Step 2 Frame a Picture.....	30
Using the Viewfinder.....	30
Using the Zoom.....	31
Step 3 Focus and Shoot.....	32
Step 4 Viewing and Deleting Pictures.....	34
Viewing Pictures (Playback Mode).....	34
Deleting Unnecessary Images.....	35
Using the Flash.....	36
Setting the Flash Mode.....	37
Taking Pictures with the Self-Timer.....	39
Using Focus Mode.....	40
Setting the Focus Mode.....	41
Using Manual Focus.....	42
Adjusting Brightness (Exposure Compensation).....	43
More on Shooting.....	44
Selecting Scenes for Shooting (Mode Dial).....	44
Shooting Suited to Scenes (Scene Mode).....	45
Shooting in the Scene Selected by the Camera (Scene Auto Selector).....	46
Selecting a Scene Mode to Take Pictures (Features).....	48
Taking Pictures with Easy Panorama.....	60
Viewing Pictures Recorded with Easy Panorama.....	62
Taking Pictures with Panorama Assist.....	63
Taking Pictures of Smiling Faces (Smart Portrait Mode).....	65
Smart Portrait Menu.....	67
Setting the Exposure for Shooting (P, S, A, M Modes).....	69
P, S, A, M Modes.....	69
P (Programmed Auto) Mode.....	71
S (Shutter-Priority Auto) Mode.....	72
A (Aperture-Priority Auto) Mode.....	73
M (Manual) Mode.....	74
Continuous Shooting (P, S, A, M Mode).....	76
Shooting Options: Shooting Menu (P, S, A, M Modes).....	81
Image Quality.....	83
Image Size.....	84
Optimize Image.....	87
White Balance.....	90
ISO Sensitivity.....	92
Metering.....	93
Exposure Bracketing.....	94
AF Area Mode.....	95

















Focusing on Moving Subjects for Shooting (Subject Tracking)	99
Autofocus Mode	101
Flash Exp. Comp.	101
Long Exposure NR	102
Active D-Lighting	103
Functions that Cannot be Applied Simultaneously	104
Using U (User Setting Mode)	108
Save the Settings in U	109
Shooting in U (User Setting) Mode	109
Resetting Saved Settings	110
More on Playback	111
Operations in Full-Frame Playback	111
Playing Images Captured Using Continuous Shooting Mode (Sequence)	113
Deleting Images in a Sequence	114
Viewing Multiple Pictures: Thumbnail Playback	115
Calendar Display	117
Taking a Closer Look: Playback Zoom	118
Playing Back Images by Category	120
Sorting Favorite Images (Favorite Pictures Mode)	122
Adding Images to an Album	122
Viewing Images in an Album	124
Removing Images From an Album	125
Using Favorite Pictures Mode	126
Changing the Album Icons	127
Finding Images in Auto Sort Mode	129
Viewing Images in Auto Sort Mode	129
Operations in Auto Sort Mode	131
Viewing Images by Date (List by Date)	132
Viewing Images in List by Date Mode	132
Operations in List by Date Mode	133
Playback Options: Playback Menu	134
 Print Order: Setting the Pictures and Number of Copies to Print	135
 Slide Show	138
 Protect	139
Selecting Pictures	140
 Rotate Image	141
 Hide Image	141
 Voice Memo	142
 Copy: Copying Between Internal Memory and Memory Card	144
 Sequence Display Options	145
 Choose Key Picture	145

Table of Contents

Editing Pictures	146
Picture Editing Functions	146
Editing Pictures	148
 Quick Retouch: Enhancing Contrast and Saturation	148
 D-Lighting: Enhancing Brightness and Contrast	149
 Skin Softening: Making Skin Appear Smoother	150
 Filter Effects: Digital Filter	152
 Small Picture: Decreasing Image Size	154
 Black Border: Adding a Black Border to Pictures	155
 Crop: Creating a Cropped Copy	156
Movie Recording and Playback	157
Recording Movies	157
Recording Movies in Slow Motion and Fast Motion (HS Movie)	160
Capturing Still Pictures While Recording Movies	162
Using the Movie Menu	163
Movie Options	164
HS Movie Options	165
Open with HS Footage	165
Autofocus Mode	166
Electronic VR	167
Wind Noise Reduction	167
Movie Playback	168
Editing Movies	169
Saving a Frame from a Movie as a Still Picture	170
Deleting Unnecessary Movies	170
Connecting to Televisions, Computers and Printers	171
Connecting to a TV	171
Connecting to a Computer	173
Before Connecting the Camera	173
Transferring Images from a Camera to a Computer	174
Charging While Connecting to a Computer	178
Connecting to a Printer	179
Connecting the Camera and Printer	180
Printing Pictures One at a Time	181
Printing Multiple Pictures	182

Basic Camera Setup	185
Setup Menu	185
Welcome Screen	187
Time Zone and Date	188
Monitor Settings	191
Print Date	192
Vibration Reduction	193
Motion Detection	195
AF Assist	196
Red-eye Reduction	196
Digital Zoom	197
Assign Side Zoom Control	198
Sound Settings	199
Auto Off	199
Format Memory/Format Card	200
Language	201
TV Settings	201
Charge by Computer	202
Reset File Numbering	202
Blink Warning	203
Reset All	205
Firmware Version	208

Caring for the Camera	209
Caring for the Camera	209
Cleaning	211
Storage	212

Table of Contents

Technical Notes and Index	213
Optional Accessories	213
Approved Memory Cards	214
File and Folder Names	215
Error Messages	217
Troubleshooting	222
Specifications	229
Supported Standards	233
Index	234

About This Manual

Thank you for your purchase of Nikon COOLPIX P500 digital camera. This manual is written to help you enjoy taking pictures with your Nikon digital camera. Read this manual thoroughly before use, and keep it where all those who use the product will read it.

Symbols and Conventions

To make it easier to find the information you need, the following symbols and conventions are used:



This icon marks cautions, information that should be read before use, to prevent damage to the camera.



This icon marks tips, additional information that may be helpful when using the camera.



This icon marks notes, information that should be read before using the camera.



This icon indicates that more information is available elsewhere in this manual.

Notations

- Secure Digital (SD) memory card, SDHC memory card, and SDXC memory card are referred to as “memory card.”
- The setting at the time of purchase is referred to as the “default setting.”
- The names of menu items displayed in the camera monitor, and the names of buttons or messages displayed on a computer monitor appear in bold.

Screen Samples

In this manual, images are sometimes omitted from monitor and viewfinder display samples so that monitor indicators can be more clearly shown.

Illustrations and Screen Display

Illustrations and text displays shown in this manual may differ from actual display.

Internal Memory and Memory Cards

Pictures taken with this camera can be stored in the camera’s internal memory or on removable memory cards. If a memory card is inserted, all new pictures will be stored on the memory card and delete, playback, and format operations will apply only to the pictures on the memory card. The memory card must be removed before the internal memory can be formatted or accessed for picture storage, deletion, or viewing.

Information and Precautions

Life-Long Learning

As part of Nikon's "Life-Long Learning" commitment to ongoing product support and education, continually updated information is available online at the following sites:

- For users in the U.S.A.: <http://www.nikonusa.com/>
- For users in Europe and Africa: <http://www.europe-nikon.com/support/>
- For users in Asia, Oceania, and the Middle East: <http://www.nikon-asia.com/>

Visit these sites to keep up-to-date with the latest product information, tips, answers to frequently asked questions (FAQs), and general advice on digital imaging and photography. Additional information may be available from the Nikon representative in your area. Visit the site below for contact information:

<http://imaging.nikon.com/>

Use Only Nikon Brand Electronic Accessories

Nikon COOLPIX cameras are designed to the highest standards and include complex electronic circuitry. Only Nikon brand electronic accessories (including battery chargers, batteries, Charging AC Adapter and AC adapters) certified by Nikon specifically for use with this Nikon digital camera are engineered and proven to operate within the operational and safety requirements of this electronic circuitry.

THE USE OF NON-NIKON ELECTRONIC ACCESSORIES COULD DAMAGE THE CAMERA AND MAY VOID YOUR NIKON WARRANTY.

The use of third-party rechargeable Li-ion batteries not bearing the Nikon holographic seal could interfere with normal operation of the camera or result in the batteries overheating, igniting, rupturing, or leaking.

For more information about Nikon brand accessories, contact a local authorized Nikon dealer.

Holographic seal: Identifies this device as an authentic Nikon product.



Before Taking Important Pictures

Before taking pictures on important occasions (such as at weddings or before taking the camera on a trip), take a test shot to ensure that the camera is functioning normally. Nikon will not be held liable for damages or lost profits that may result from product malfunction.

About the Manuals

- No part of the manuals included with this product may be reproduced, transmitted, transcribed, stored in a retrieval system, or translated into any language in any form, by any means, without Nikon's prior written permission.
- Nikon reserves the right to change the specifications of the hardware and software described in these manuals at any time and without prior notice.
- Nikon will not be held liable for any damages resulting from the use of this product.
- While every effort was made to ensure that the information in these manuals is accurate and complete, we would appreciate it were you to bring any errors or omissions to the attention of the Nikon representative in your area (address provided separately).

Notice Concerning Prohibition of Copying or Reproduction

Note that simply being in possession of material that was digitally copied or reproduced by means of a scanner, digital camera or other device may be punishable by law.

- **Items prohibited by law from being copied or reproduced**

Do not copy or reproduce paper money, coins, securities, government bonds or local government bonds, even if such copies or reproductions are stamped "Sample". The copying or reproduction of paper money, coins, or securities which are circulated in a foreign country is prohibited. Unless the prior permission of the government was obtained, the copying or reproduction of unused postage stamps or post cards issued by the government is prohibited.

The copying or reproduction of stamps issued by the government and of certified documents stipulated by law is prohibited.

- **Cautions on certain copies and reproductions**

The government has issued cautions on copies or reproductions of securities issued by private companies (shares, bills, checks, gift certificates, etc.), commuter passes or coupon tickets, except when a minimum of necessary copies are to be provided for business use by a company. Also, do not copy or reproduce passports issued by the government, licenses issued by public agencies and private groups, ID cards and tickets, such as passes and meal coupons.

- **Comply with copyright notices**

The copying or reproduction of copyrighted creative works such as books, music, paintings, woodcut prints, maps, drawings, movies and photographs is governed by national and international copyright laws. Do not use this product for the purpose of making illegal copies or to infringe copyright laws.

Disposing of Data Storage Devices

Please note that deleting images or formatting data storage devices such as memory cards or built-in camera memory does not completely erase the original image data. Deleted files can sometimes be recovered from discarded storage devices using commercially available software, potentially resulting in the malicious use of personal image data. Ensuring the privacy of such data is the user's responsibility.

Before discarding a data storage device or transferring ownership to another person, erase all data using commercial deletion software, or format the device and then completely refill it with images containing no private information (for example, pictures of empty sky). Be sure to also replace any pictures selected for the **Select an image** option in the **Welcome screen** setting (📖187). Care should be taken to avoid injury or damage to property when physically destroying data storage devices.

Parts of the Camera

Camera Body

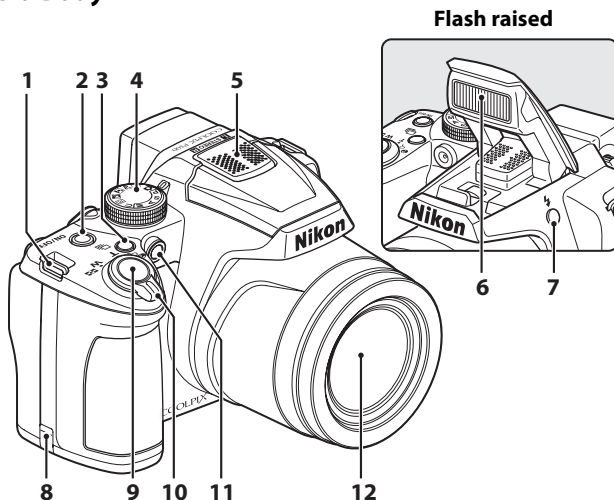

1	Eyelet for camera strap.....	7
2	Power switch/power-on lamp... 23, 199	
3	(continuous shooting mode) button.....	59, 77
4	Mode dial.....	44
5	Microphone (stereo).....	142, 157
6	Flash.....	36
7	(flash pop-up) button.....	7, 36
8	Power connector cover (for connection with an optional AC Adapter).....	213

9	Shutter-release button.....	15, 32
10	Zoom control.....	31
	W : Wide.....	31
	T : Tele.....	31
	: Thumbnail playback.....	115
	: Playback zoom.....	118
	: Help.....	45
11	Self-timer lamp.....	39
	AF-assist illuminator.....	196
12	Lens.....	211, 229

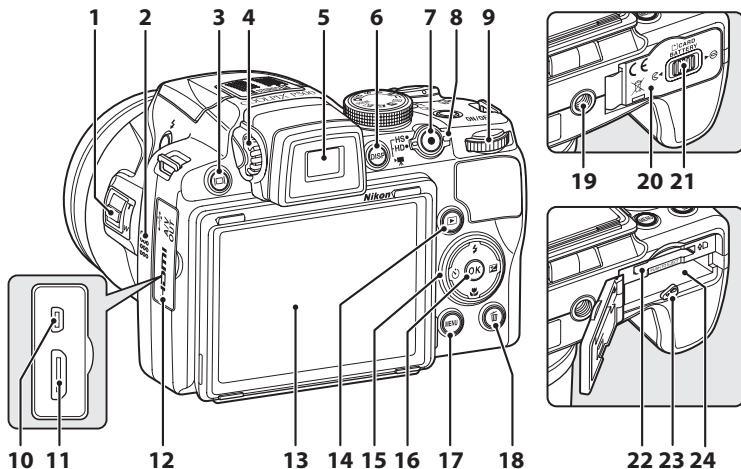

Bottom of camera

1	Side zoom control.....	31	13	Monitor	8, 17, 29
2	Speaker	143, 168	14	▶ (playback) button.....	34
3	 ◻ (monitor) button	16	15	Multi selector.....	12
4	Diopter adjustment control.....	30	16	OK (apply selection) button	12
5	Electronic viewfinder	16, 30	17	MENU button.....	13, 45, 82, 135, 163, 186
6	DISP (display) button	17	18	🗑 (delete) button.....	35, 143, 170
7	● (▶ 🎥 movie-record) button.....	157	19	Tripod socket	
8	Movie mode switch	157	20	Battery-chamber/ memory card slot cover	18, 26
9	Command dial	11	21	Cover latch.....	18, 26
10	USB/Audio video connector	171, 174, 180	22	Memory card slot	26
11	HDMI Mini Connector	171	23	Battery latch.....	18, 19
12	Connector cover	171, 174, 180	24	Battery chamber.....	18

Changing the Angle of the Monitor

The angle of the monitor can be lowered down to 82° or raised upward to 90°. This is convenient when taking pictures with the camera held at high or low positions.

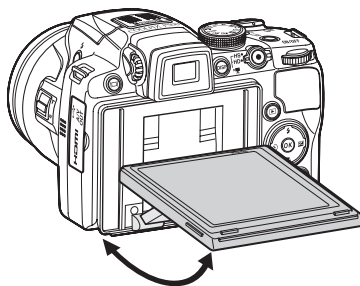
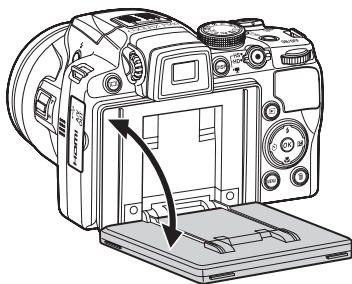

Notes on Monitor

- Do not apply excessive force when changing the angle of the monitor.
- The monitor cannot be moved horizontally.
- Put the monitor back in the original position when using in normal situations.

Raising and Lowering the Flash

Press the  (flash pop-up) button to raise the flash.

- See “Using the Flash” (📖36) for more information on setting the flash.
- When not using the flash, lower it by gently pushing it down until it clicks.

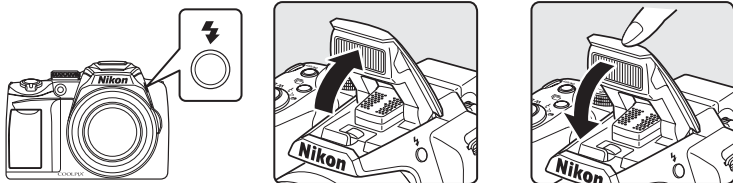

Attaching the Camera Strap and Lens Cap

Attach the lens cap to the strap, and then attach the strap to the camera (at two places).

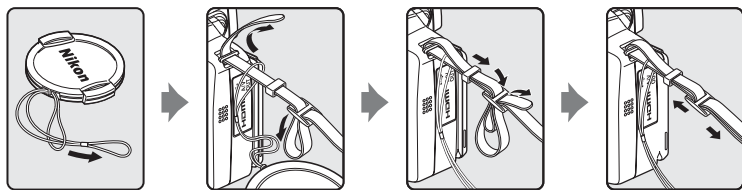

Lens Cap

- Remove the lens cap before you shoot a picture.
- At times when you are not shooting pictures such as when the power is off, or while you are carrying the camera, attach the lens cap to the camera to protect the lens.

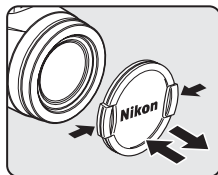

Monitor

The following indicators may appear in the monitor during shooting and playback (actual display varies with current camera settings). See page 17 for how to switch the monitor display.

Shooting

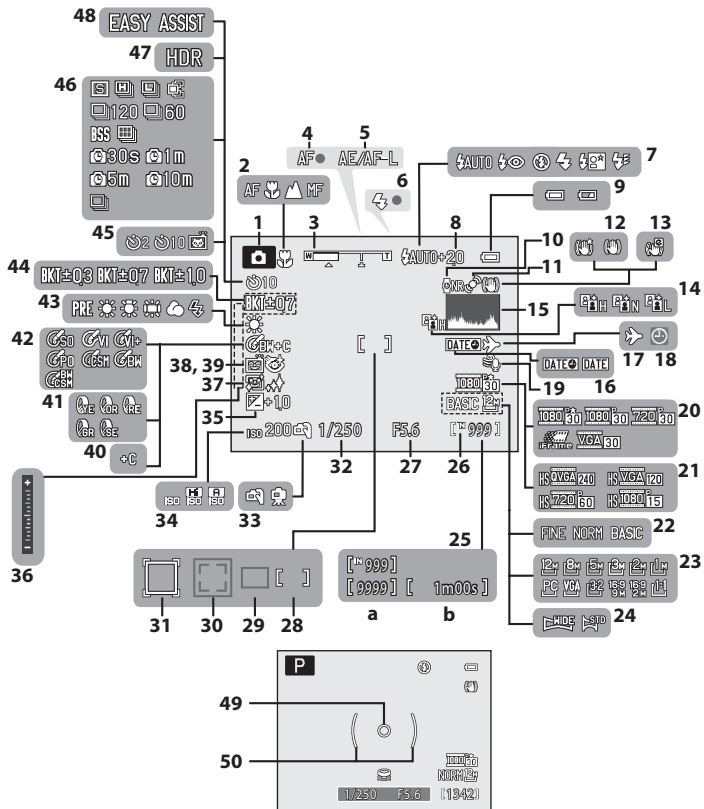

1	Shooting mode*	28, 44, 45, 65, 69, 108
2	Focus mode.....	40
3	Zoom indicator	31
4	Focus indicator	32
5	AE/AF-L indicator.....	64
6	Flash indicator.....	38
7	Flash mode	36
8	Flash exposure compensation	101
9	Battery level indicator	28
10	Long exposure noise reduction.....	102
11	Motion detection icon	195
12	Vibration reduction icon (still pictures).....	193
13	Electronic VR icon (movies)	167
14	Active D-Lighting.....	103
15	View/hide histograms	191
16	Print date.....	192
17	Travel destination indicator	188
18	"Date not set" indicator.....	217
19	Wind noise reduction.....	167
20	Movie options.....	164
21	HS movie type	165
22	Image quality	83
23	Image size.....	84
24	Easy panorama	60
25	(a) Number of exposures remaining (still pictures)	28
	(b) Movie length.....	157
26	Internal memory indicator	29
27	Aperture value	70
28	Focus area (for manual, center)....	32, 95
29	Focus area (for auto).....	95
30	Focus area (for face detection, pet detection)	59, 65, 95
31	Focus area (for subject tracking)	99
32	Shutter speed.....	70
33	Hand-held/tripod.....	48, 49
34	ISO sensitivity	38, 92
35	Exposure compensation value.....	43
36	Exposure indicator	74
37	Skin softening	67
38	Smile timer	67
39	Blink proof	68
40	B&W + color.....	89
41	Monochrome filter	89
42	Image optimization.....	87
43	White balance	90
44	Exposure bracketing	94
45	Self-timer indicator	39, 59
46	Continuous shooting mode.....	59, 76
47	Backlighting (HDR)	50
48	Panorama shooting	58
49	Spot metering area.....	93
50	Center-weighted area	93

* The icons vary with the shooting mode.

Playback

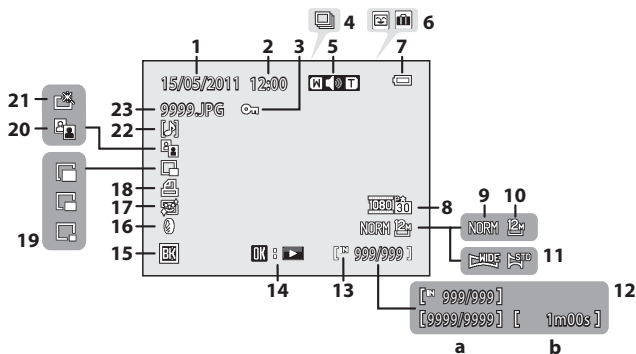

1	Date of recording.....	24	13	Internal memory indicator.....	34
2	Time of recording.....	24	14	Easy panorama playback guide.....	62
3	Protect icon.....	139	15	Sequence playback guide.....	113
4	Sequence display.....	113, 145	16	Movie playback guide.....	168
5	Volume indicator.....	142, 168	17	Black border.....	155
6	Album icon in favorite pictures mode ¹	124	18	Filter effects icon.....	152
7	Battery level indicator.....	28	19	Skin softening icon.....	150
8	Movie options ²	164	20	Print order icon.....	135
9	Image quality ²	83	21	Small picture.....	154, 156
10	Image size ²	84	22	D-Lighting icon.....	149
11	Easy panorama indicator.....	62	23	Quick retouch icon.....	148
12	(a) Current frame number/total number of frames.....	34		Voice memo indicator.....	142
	(b) Movie length.....	168		File number and type.....	215

¹ The icon for the selected album or the selected category in auto sort mode in playback mode is displayed.

² The icon displayed varies with the setting that was set at the time of shooting.



Basic Operations

Command Dial

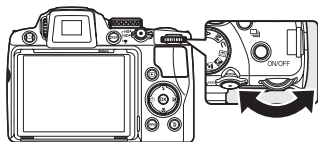
You can rotate the command dial to select items from a menu screen or to set any of the following functions.



For Shooting

Mode	Description	
Mode dial set to P	Adjust the flexible program	71
Mode dial set to S	Adjust shutter speed	72
Mode dial set to A	Adjust aperture value	73
Mode dial set to M	Adjust shutter speed or aperture value (Press the multi selector  to switch between settings.)	74

For Playback

Mode	Description	
Full-frame playback or thumbnail playback	Choose a picture	34, 111, 115
Calendar display	Choose a date	117
Playback zoom	Change the zoom ratio	118
Movie playback	Advanced or rewind	168
During movie pause or editing	Advanced or rewind by one frame	168

Multi Selector

Operate by pressing the up (▲), down (▼), left (◀), right (▶) section, or the **OK** (apply selection) button.

For Shooting

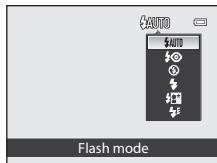
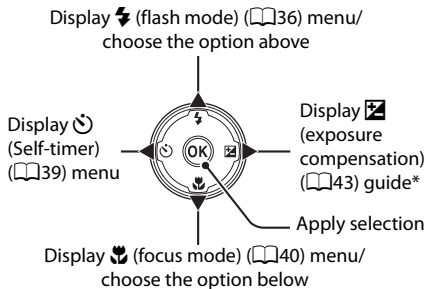

* In shooting mode **M** (manual), select whether to set the shutter speed or the aperture value when the command dial is rotated (☞74).

For Playback

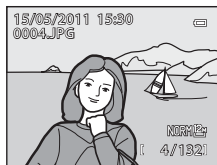
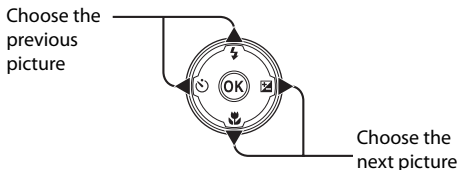

For the Menu Screen

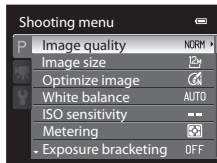
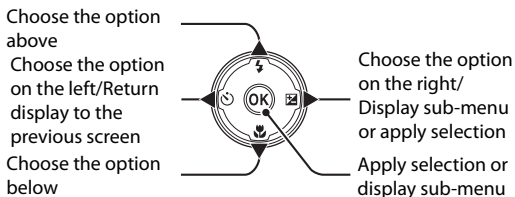

MENU (Menu) Button

Press the **MENU** button to display the menu for the selected mode and to select options for the menu items.

- Use the multi selector to navigate the menus (📖12).

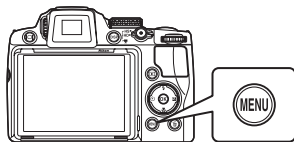

☰ is displayed when there are previous menu options

Displayed when the menu contains two or more pages

Tab for the menus available in the current shooting mode*/tab for playback mode menu

Tab for movie menu (during shooting mode)/playback menu (during playback mode)

Tab for displaying the setup menu

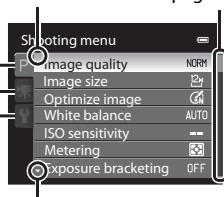

Displayed when there are following menu options

* The displayed tabs differ according to the chosen shooting mode.

- 📷 (auto) mode: Auto menu tab
- SCENE (scene): Scene menu tab (📖45)
- 🌃 (Night landscape): Night landscape menu tab (📖48)
- 🌃 (Night portrait): Night portrait menu tab (📖49)
- 🌃 (Backlighting): Backlighting menu tab (📖50)
- 📷 (Smart portrait): Smart portrait menu tab (📖67)
- **P, S, A, M, U**: Shooting menu tab (📖81)

Switching Between Tabs in the Menu Screen

In the menu screen that is displayed when the **MENU** button is pressed, choose the left end tab to switch to the menu of the chosen tab.

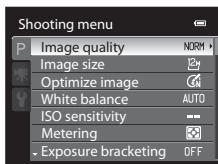

Press the multi selector ◀ to highlight the tab.



Press the multi selector ▲ or ▼ to choose another tab, and press either the Ⓞ button or ▶.

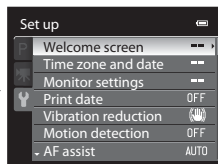

The corresponding menu is displayed.

Using Camera Menus

1 Press the **MENU** button.

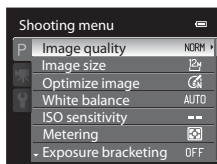

2 Press the multi selector **▲** or **▼** to choose an item, and then press **▶** or the **OK** button.

- Items can also be chosen by rotating the command dial (11).
- To change tabs, press **◀** (13).

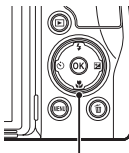

Multi selector

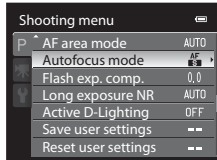

3 Press **▲** or **▼** to choose an item and press the **OK** button.

- The setting is applied.

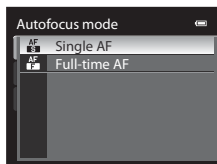

4 When setting is finished, press the **MENU** button.

- The camera exits the menu display.

Pressing the Shutter-Release Button Halfway/All the Way

- The camera features a two-stage shutter-release button. To set focus and exposure, press the shutter-release button halfway, stopping when you feel resistance. When the shutter-release button is pressed halfway, focus and exposure (shutter speed and aperture value) are set. Focus and exposure remain locked while the shutter-release button is pressed halfway.
- While the shutter-release button is held in this position, release the shutter and take a picture by pressing the shutter-release button the rest of the way down. Do not use force when pressing the shutter-release button, as this may result in camera shake and blurred images.



Press halfway to lock the focus and exposure.



Press the rest of the way down to shoot.

☐ (Monitor) Button

Press the ☐ (monitor) button to switch between the monitor and viewfinder. Switch to the one that suits the shooting conditions. For example, use the viewfinder in bright locations when it is difficult to see the monitor.

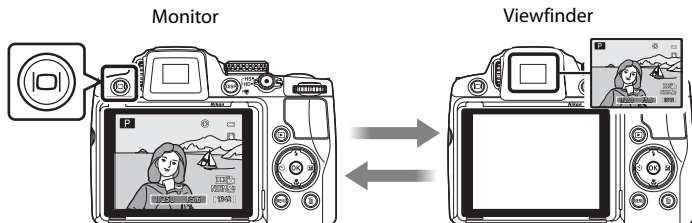

☑ Diopter Adjustment of Viewfinder

When the diopter for the viewfinder is out of focus and the display is difficult to see, adjust the diopter with the diopter adjustment control. While looking into the viewfinder, rotate the diopter adjustment control until the display is clearly visible.

- Take care not to scratch your eye with your fingertips or nails.

Diopter adjustment control

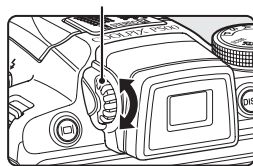

DISP (Display) Button

To switch between the information displayed on the monitor during shooting and playback, press the **DISP** (display) button.

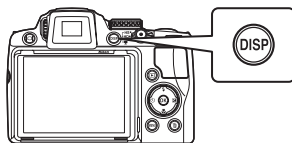

For Shooting

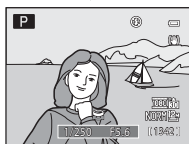

Display information

Display the picture and the shooting information.

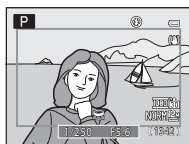

Movie frame

Display the range of a movie in a frame.



Information hidden

Display the picture only.

For Playback

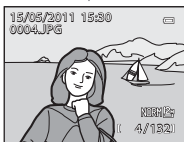

Display photo information

Display the picture taken and the photo information.

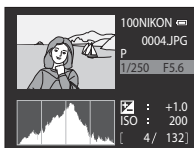

Display shooting information

(except for movies)

Display highlight¹, histogram² and shooting information³.



Information hidden

Display only the taken picture.

- 1 The brightest portions of the image (portions that are highlighted) blink. Use highlights as a guide when setting exposure.
- 2 The histogram is a bar graph that shows the brightness distribution in the picture. The horizontal axis corresponds to pixel brightness, with dark tones to the left and bright tones to the right. The vertical axis shows the number of pixels.
- 3 The shooting information displayed includes the folder name, file name, shooting mode used (**P**, **S**, **A** or **M**), shutter speed, aperture value, exposure compensation, ISO sensitivity, and the current file number/total number of exposures.

P is displayed when the shooting mode **SCENE**, **P**, **S**, **A**, **M**, **B**, **L**, **A** or **P** is chosen.

Inserting the Battery

Insert a Rechargeable Li-ion Battery EN-EL5 (supplied) into the camera.

- Charge the battery before first use or when the battery is running low (📖20).

- 1 Slide the cover latch to the ◀ side (①), and open the battery-chamber/memory card slot cover (②).

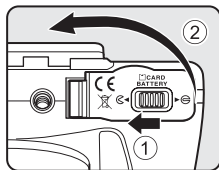

- 2 Insert the battery.

- Use the battery to push the orange battery latch down in the direction shown (①), and fully insert the battery (②).
- When the battery is fully inserted, the battery latch locks it in place.

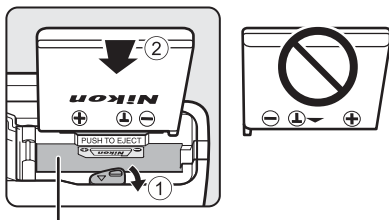

Battery chamber

✔ Inserting the Battery Correctly

Inserting the battery upside down or backwards could damage the camera. Be sure to confirm that the battery is in the correct orientation.

- 3 Close the battery-chamber/memory card slot cover (①), and slide the cover latch to the ▶ side (②).

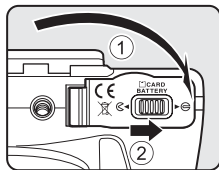

Removing the Battery

Before opening the battery-chamber/memory card slot cover, turn the camera off (📖23) and confirm that the power-on lamp and the monitor are off.

To eject the battery, open the battery-chamber/memory card slot cover and slide the orange battery latch in the direction indicated by the arrow (①), then remove the battery while being careful not to remove the battery at an angle (②).

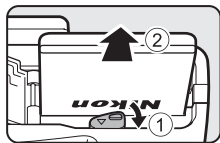

- The camera, battery or memory card may be hot immediately after using the camera. Observe caution when removing the battery or memory card.

✓ Notes on Battery

- Be sure to read and follow the warnings of "For Your Safety" (📖ii) thoroughly before using the battery.
- Be sure to read and follow the warnings for "The Battery" (📖210) thoroughly before using the battery.
- If the battery will not be used for an extended period, recharge it at least once every six months and run it flat before returning it to storage.

Charging the Battery

Charge the supplied Rechargeable Li-ion Battery EN-EL5 inserted into the camera, by connecting the supplied Charging AC Adapter EH-69P to the camera via the supplied USB Cable UC-E6, and then plugging the Charging AC Adapter into an electrical outlet.

1 Prepare the Charging AC Adapter EH-69P.

If a plug adapter* is included, attach the plug adapter to the plug on the Charging AC Adapter. Push the plug adapter firmly until it is securely held in place. Once the two are connected, attempting to forcibly remove the plug adapter could damage the product.

- * The shape of the plug adapter varies according to the country or region in which the camera was purchased. The Charging AC Adapter comes with the plug adapter attached in Argentina and Korea.

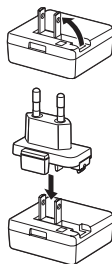

2 Insert the battery into the camera (18).

Do not turn the camera on.

3 Use the supplied USB cable to connect the Charging AC Adapter to the camera.

- Be sure that connectors are properly oriented. Do not attempt to insert connectors at an angle, and do not use force when connecting or disconnecting the USB cable.

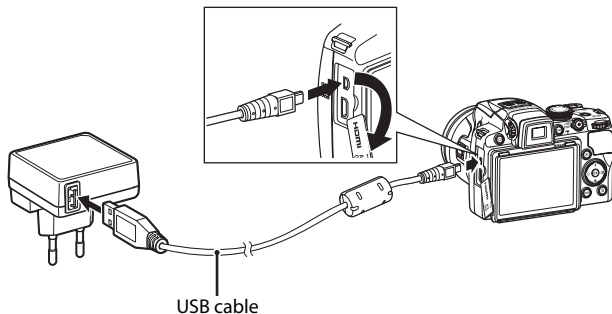

4 Plug the Charging AC Adapter into an electrical outlet.

The power-on lamp slowly blinks orange to indicate that the battery is charging.

About four hours and 50 minutes are required to charge a fully exhausted battery.

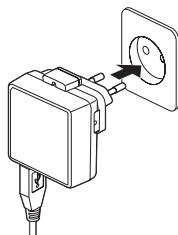

The following chart explains power-on lamp status when the camera is plugged into the electrical outlet.

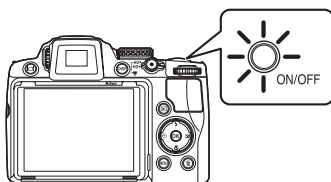

Power-on lamp	Description
Blinks slowly (orange)	Battery charging.
Off	Battery not charging. When charging is complete, the power-on lamp stops blinking orange and turns off.
Flickers (orange)	<ul style="list-style-type: none"> The ambient temperature is not suited to charging. Charge the battery indoors with an ambient temperature of 5 °C to 35 °C (41 °F to 95 °F). The USB cable or Charging AC Adapter is not properly connected, or there is a problem with the battery. Disconnect the USB cable or unplug the Charging AC Adapter and correctly connect it again, or change the battery.

5 Disconnect the Charging AC Adapter from the electrical outlet and then disconnect the USB cable.

Charging the Battery

Notes on Charging AC Adapter

- The Charging AC Adapter EH-69P is for use only with compatible devices. Do not use with another make or model of device.
- Be sure to read and follow the warnings for the Charging AC Adapter on page iii and the section, “The Battery” (☞210), before use.
- The EH-69P is compatible with AC 100-240 V, 50/60 Hz electrical outlets. When using in other countries, use a plug adapter (commercially available) as necessary. For more information about plug adapters, consult your travel agency.
- The Charging AC Adapter EH-69P is for charging the battery inserted into the camera. When the camera is connected to an electrical outlet with the Charging AC Adapter, the camera cannot be turned on.
- Do not, under any circumstances, use another make or model of USB-AC adapter other than Charging AC Adapter EH-69P. Failure to observe this precaution could result in overheating or in damage to the camera.

AC Power Source

- If the AC Adapter EH-62A (available separately; ☞213) is used, power is supplied to the camera from an electrical outlet, enabling taking and playing back pictures.
- Do not, under any circumstances, use another make or model of AC adapter other than EH-62A. Failure to observe this precaution could result in overheating or in damage to the camera.

Charging Using Computer or Battery Charger

- Connecting the COOLPIX P500 to a computer also charges the Rechargeable Li-ion Battery EN-EL5 (☞178, 202).
- The EN-EL5 can be charged without using the camera by using the Battery Charger MH-61 (available separately; ☞213).



Turning On and Off the Camera

Remove the lens cap before turning on the camera.

Press the power switch to turn on the camera.

The power-on lamp (green) lights, and then the monitor is turned on (the power-on lamp is turned off when the monitor is turned on).

Press the power switch again to turn off the camera. When the power is turned off, the monitor and power-on lamp are turned off.

- When the camera is off, holding down the  button turns on the camera in playback mode (34).

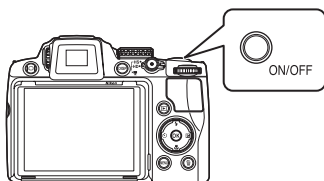





Message

If **Turn the camera off, remove the lens cap, and turn the camera on.** is displayed, confirm that the lens cap is removed and press the power switch to turn the camera on again.

Standby Mode (Auto Off)

If no operations are performed, the monitor is turned off automatically, the camera enters standby mode and the power-on lamp blinks. The camera turns off when the standby mode continues for about three minutes.

- When the power-on lamp blinks, turn on the monitor again with one of the following operations.
 - Press the power switch, the shutter-release button, the  button or the  button.
 - Rotate the mode dial.
- In shooting or playback mode, the camera enters standby mode in about one minute (default setting).
- The time that elapses before the camera enters standby mode can be changed from the **Auto off** (199) in the setup menu (185).

Setting the Display Language, Date and Time

Dialogs for language selection and camera clock setting are displayed the first time the camera is turned on.

1 Press the power switch to turn on the camera.

- The power-on lamp lights, and then the monitor is turned on (the power-on lamp is turned off when the monitor is turned on).

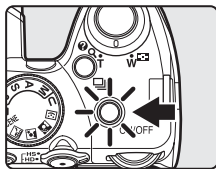

2 Press the multi selector ▲ or ▼ to choose the desired language and press the OK button.

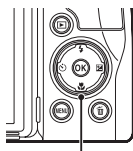

Multi selector

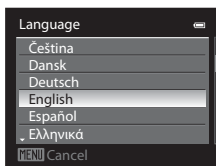

3 Press ▲ or ▼ to choose Yes and press the OK button.

- To cancel setting the time zone and date, select **No**.

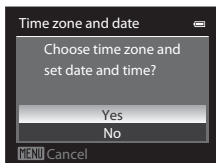

4 Press ◀ or ▶ to select your home time zone (Time zone) (📖190), and press the OK button.

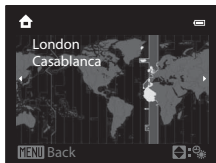

Daylight Saving Time

To set the date and time in a time zone where daylight saving is in effect, turn on the daylight saving setting with ▲ in the time zone selection screen shown in step 4.

- When turned on, the  icon is displayed on the top of the screen.
- To turn off, press ▼.

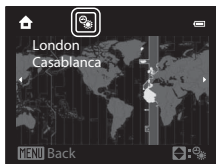

- 5 Press ▲ or ▼ to choose the date display order and press the **OK** button or ►.

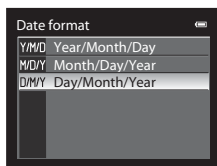

- 6 Press ▲, ◀, ▼ or ► to set date and time, and press the **OK** button.

- To choose an item: Press ► or ◀ (selected in the following order: **D** (day) → **M** (month) → **Y** (year) → **hour** → **minute**).
- To set the contents: Press ▲ or ▼. Date and time can also be set by rotating the command dial (📖111).
- Finish setting: Choose **minute**, check that the lens cap has been removed, and then press the **OK** button or ►.
- After finishing the setting, the lens extends slightly and the shooting screen is displayed.

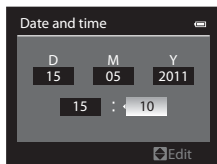

Imprinting the Date and Changing the Date and Time

- To imprint the date on pictures when shooting, first set the date and time, and then set **Print date** (📖192) in the setup menu (📖185).
- To change the date and time of the camera clock, set in **Time zone and date** (📖188) in the setup menu (📖185).

Inserting the Memory Card

The recorded data is stored in the camera's internal memory (approx. 102 MB) or on commercially available Secure Digital (SD) memory cards (📖214).

If a memory card is inserted in the camera, data is automatically stored on the memory card, and data recorded to the memory card can be played back, deleted, or transferred. To use the internal memory, remove the memory card.

- A memory card is required for movie recording.

1 Confirm that the power-on lamp and the monitor are turned off and open the battery-chamber/memory card slot cover.

- Be sure to turn off the camera before opening the cover.

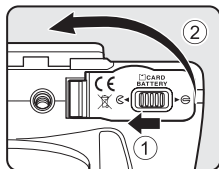

2 Insert the memory card.

- Slide the memory card, until it clicks into place.

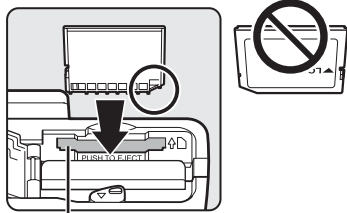

Memory card slot

✓ Inserting the Memory Card Correctly

Inserting the memory card upside down or backwards could damage the camera or the memory card. Be sure to confirm that the memory card is in the correct orientation.

3 Close the battery-chamber/memory card slot cover.

Removing the Memory Card

Before opening the battery-chamber/memory card slot cover, turn the camera off and confirm that the power-on lamp and the monitor are off.

Press the memory card in lightly with your finger (①) to partially eject it, and then pull it out straight (②).

- The camera, battery or memory card may be hot immediately after using the camera. Observe caution when removing the battery or memory card.

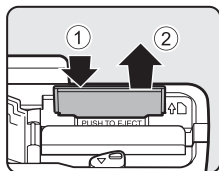

✓ Formatting a Memory Card

If the message on the right is displayed when the camera is turned on, the memory card must be formatted before use. **Note that formatting (📖200) permanently deletes all pictures and other data on the memory card.** Be sure to make copies of any data you wish to keep before formatting the memory card. To format, use the multi selector to choose **Yes** and press the **OK** button. When the confirmation dialog is displayed, choose **Format** and press the **OK** button to start formatting.

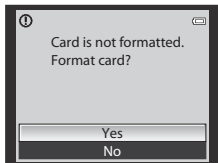

- Do not turn the camera off, or open the battery-chamber/memory card slot cover until formatting is complete.
- The first time you insert a memory card that has been used in another device into this camera, be sure to format it (📖200) with this camera.

✓ The Write Protect Switch

When the memory card switch is in the "Lock" position, data cannot be written to, or deleted from, the memory card. If you want to record data, delete data or format the memory card, and the switch is in the "Lock" position, slide the switch to its original position to unlock it.

Write protect switch

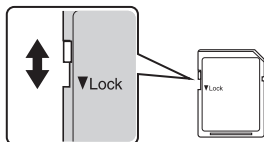

✓ Memory Cards

- Use only Secure Digital memory cards.
- Do not perform the following operations during formatting, while data is being written to or deleted from the memory card, or during data transfer to a computer. Failure to observe this precaution could result in the loss of data or in damage to the memory card:
 - Eject the memory card
 - Remove the battery
 - Turn off the camera
 - Disconnect the AC adapter
- Do not use a computer to format the memory card.
- Do not disassemble or modify.
- Do not drop, bend, or expose to water or strong physical shocks.
- Do not touch the metal terminals with your fingers or metal objects.
- Do not affix labels or stickers to the memory card.
- Do not leave in direct sunlight, closed vehicles or areas exposed to high temperatures.
- Do not expose to humidity, dust, or corrosive gases.

Step 1 Turn the Camera On and Select  (Auto) Mode

This section describes how to take pictures in  (auto) mode, an automatic, “point-and-shoot” mode recommended for first-time users of digital cameras.

1 Remove the lens cap and press the power switch to turn on the camera.

- The lens extends slightly, and the monitor is turned on.

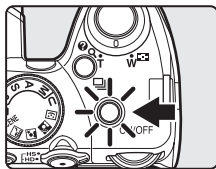

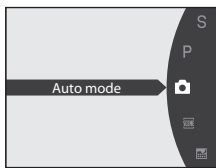
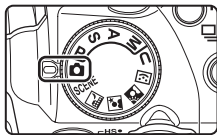

2 Rotate the mode dial to .



3 Check the battery level and number of exposures remaining.

Battery Level

Display	Description
	Battery level high.
	Battery level low. Prepare to charge or replace the battery.
 Battery exhausted.	Cannot take pictures. Charge or replace the battery.

Battery level indicator



Number of exposures remaining

Number of Exposures Remaining



The number of exposures remaining is displayed.

The number of pictures that can be stored depends on the remaining capacity of the internal memory or memory card, the image quality, and the image size ( 85).

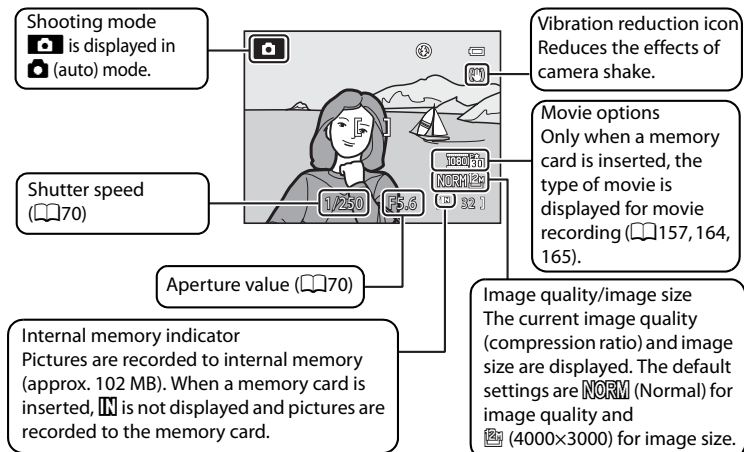
Indicators Displayed in (Auto) Mode



When the monitor has been turned off in standby mode to save power (the power-on lamp is blinking) (199), turn on the monitor again with one of the following operations.

- Press the power switch, the shutter-release button, the  button or the  (movie-record) button.
- Rotate the mode dial.

Note on the Flash

When the flash is lowered, the flash setting is fixed at off and  appears at the top of the monitor. In situations where a flash is needed, such as in dark locations or when the subject is backlit, be sure to raise the flash (137).

Functions Available in (Auto) Mode

- The flash mode (36) can be adjusted, self-timer (39), focus mode (40) and exposure compensation (43) can be applied.
- Press the **MENU** button to specify settings for the shooting menu options **Image quality** (83) and **Image size** (84).

Vibration Reduction

- See **Vibration reduction** (193) in the setup menu (185) for more information.
- Set **Vibration reduction** to **Off** when using a tripod to stabilize the camera during shooting.

Step 2 Frame a Picture

1 Ready the camera.

- Hold the camera steadily in both hands.
- Keep your fingers, hair, strap and other objects away from the lens, flash, AF-assist illuminator and microphone.

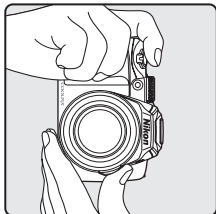
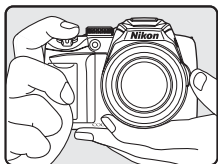

2 Frame a picture.

- Position the main subject near the center of the monitor.

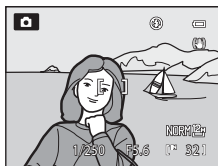

Using the Viewfinder

Use the viewfinder to frame pictures when bright light makes it difficult to see the display on the monitor. Press the  button to switch to the viewfinder (📖16). When the diopter for the viewfinder is out of focus, rotate the diopter adjustment control to a position where the display is clearly visible (📖16).

- Take care not to scratch your eye with your fingertips or nails.

Diopter adjustment control

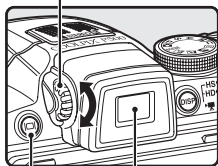

 button Viewfinder

Using the Zoom

Rotate the zoom control to activate the optical zoom. Rotate the zoom control toward **T** to zoom in, increasing the size of the subject. Rotate the zoom control toward **W** to zoom out, increasing the area visible in the frame.

- When the camera is turned on, the zoom is at the maximum wide-angle position.
- Rotating the zoom control all the way in either direction adjusts the zoom quickly, while rotating the control partially adjusts the zoom slowly.
- A zoom indicator is displayed at the top of the monitor when the zoom control is rotated.
- The zoom can also be operated by rotating the side zoom control (📖5) toward **T** or **W**.

The function of the side zoom control can be set in the **Assign side zoom control** (📖198) in the setup menu (📖185).

Digital Zoom

When the camera is zoomed in to the maximum optical zoom position, rotating and holding the zoom control at **T** triggers digital zoom.

Digital zoom can magnify the subject up to about 4x beyond the maximum magnification of the optical zoom.

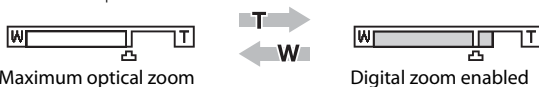

- The camera focuses at the center of the frame and the focus area is not displayed when digital zoom is in effect.

Digital Zoom and Interpolation

Unlike the optical zoom, the digital zoom uses a digital imaging process known as interpolation to magnify images, resulting in slight deterioration of picture quality depending on the image size (📖84) and digital zoom magnification.

Interpolation is applied at zoom positions beyond 📏 when taking still images.

When zoom is increased beyond the 📏 position, interpolation is initiated and the zoom indicator turns yellow to indicate that interpolation is being applied.

The position of 📏 moves to the right as image size decreases, allowing for confirmation of the zoom positions at which shooting without interpolation is possible at the current image mode setting.

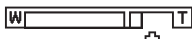

When the image size is small

- Using **Digital zoom** (📖197) in the setup menu (📖185), it is possible to restrict the magnification of the digital zoom to a range where images do not deteriorate, or to set the digital zoom so that it does not operate.

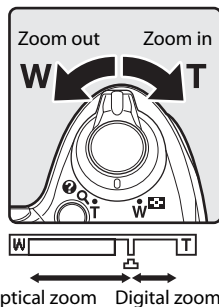

Step 3 Focus and Shoot

1 Press the shutter-release button halfway.

- When the shutter-release button is pressed halfway (📖15), the camera sets focus and exposure (shutter speed and aperture value). The focus and exposure remain locked while the shutter-release button is pressed halfway.
- The camera automatically focuses on the subject in the center focus area. When the subject is in focus, the focus area lights in green.

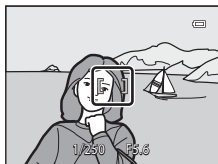

- When the digital zoom is in effect, the camera focuses on the subject at the center of the screen, and the focus area is not displayed. When the subject is in focus, the focus indicator (📖8) lights in green.
- When the shutter-release button is pressed halfway and the focus area or the focus indicator blinks red, the camera is unable to focus. Change the composition and press the shutter-release button halfway again.

2 Press the shutter-release button the rest of the way down.

- The shutter is released and the picture is recorded to the memory card or internal memory.



✔ When the Subject Is Close to the Camera

If the camera cannot focus, try shooting with 🌸 (macro close-up) in the focus mode (📖40) or the **Close-up** scene mode (📖55).

✓ During Recording

While the indicator showing the number of exposures remaining is blinking, images are being recorded. **Do not open the battery-chamber/memory card slot cover.** Cutting the power or removing the memory card in these circumstances could result in loss of data or in damage to the camera or card.

✓ Autofocus

Autofocus may not perform as expected in the following situations. In some rare cases, the subject may not be in focus despite the fact that the active focus area or focus indicator lights in green:

- Subject is very dark
- Objects of sharply differing brightness are included in the scene (e.g. the sun behind the subject makes that subject appear very dark)
- No contrast between the subject and surroundings (e.g. a portrait subject, wearing a white shirt, is standing in front of a white wall)
- Several objects are at different distances from the camera (e.g., an animal inside a cage)
- Subjects that repeat the same pattern (e.g., window blinds, buildings with multiple rows of similarly shaped windows)
- Subject is moving rapidly

In the situations noted above, try pressing the shutter-release button halfway to refocus several times, or focus on another subject and use focus lock. When using focus lock, be sure that the distance between the camera and the subject with which focus was locked is the same as that for the actual subject.

The camera can also be focused using manual focus (📖42).

🔒 Focus Lock

Use focus lock to focus on off-center subjects when Center is selected for AF area mode.

- Be sure that the distance between the camera and the subject does not change.
- When the shutter-release button is pressed halfway, the exposure is locked.



Position the subject at the center of the frame.



Press the shutter-release button halfway.



Confirm that the focus area lights in green.



Continue holding down the shutter-release button halfway and recompose the picture.



Press the shutter-release button the rest of the way down to shoot.













🔦 AF-assist illuminator

When lighting is dim, the AF-assist illuminator (📖196) may light when the shutter-release button is pressed halfway.

Step 4 Viewing and Deleting Pictures

Viewing Pictures (Playback Mode)

Press the  (Playback) button.

- The last picture shot is displayed in full-frame playback mode.
- Press the multi selector  or  to view the previous image. Press  or  to view the next image. Continue holding down , , , or  to scroll quickly through pictures. Pictures can also be chosen by rotating the command dial.
- Pictures may be briefly displayed at low resolution immediately after switching to the previous or next picture.
- To return to shooting mode, press the  button again or press the shutter-release button or  (movie-record) button.
-  is displayed when pictures stored in the internal memory are displayed. When a memory card is inserted,  is not displayed and pictures stored on the memory card are displayed.

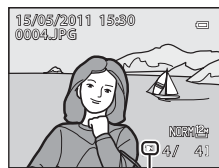
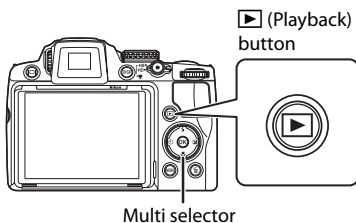

Internal memory indicator

When the Monitor Is Turned Off to Save Power

When the power-on lamp blinks, press the  button to turn on the monitor again (📖199).

Options Available in Playback Mode

For details, see “More on Playback” (📖111) or “Editing Pictures” (📖146).

Pressing the Button to Turn on the Camera

When the camera is off, holding down the  button turns on the camera in playback mode. The lens does not extend.

Viewing Pictures



- Press the  button to switch between using the monitor and viewfinder display (📖16).
- Press the **DISP** button to switch between showing and hiding the photo information or shooting information that is displayed on the monitor (📖17).
- Pictures that were shot using face priority (📖97) or pet detection (📖59) will be rotated automatically when displayed in full-frame playback mode according to the orientation of the face (except for pictures shot when continuous (📖76) or **Exposure bracketing** (📖94) was set).
- When images captured with the continuous shooting feature are displayed, each series of images is treated as a group, and only the group’s “key picture” is displayed (see “Playing Images Captured Using Continuous Shooting Mode (Sequence)” (📖113) for more information).

Deleting Unnecessary Images

- 1 Press the  button to delete the image currently displayed on the monitor.

- To exit without deleting, press the **MENU** button.



- 2 Press the multi selector  or  to choose the desired deletion method and press the **OK** button.

- **Current image:** Only the current image or voice memo (143) is deleted.
- **Erase selected images:** Multiple images can be selected and deleted.
See “Operating the Erase Selected Images Screen” for more information.
- **All images:** All images are deleted.

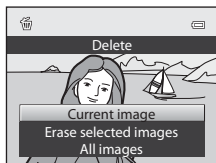









- 3 Press  or  to select **Yes** and press the **OK** button.

- Deleted images cannot be recovered.
- To cancel, select **No** and press the **OK** button.



Operating the Erase Selected Images Screen

- 1 Press the multi selector  or  to choose an image to be deleted and press  to add  to the image.



- To undo the selection, press  to remove .
- Rotate the zoom control (4) toward **T** () to switch back to full-frame playback or **W** () to display thumbnails.



- 2 Add  to all desired images and then press the **OK** button to confirm the selection.

- A confirmation dialog is displayed. Follow the instructions displayed on the monitor.

Notes on Deletion

- Deleted images cannot be restored. Transfer important images to a computer before deleting them.
- Protected images cannot be deleted (139).
- Deleting images captured with the continuous shooting feature → “Deleting Images in a Sequence” (114)

Deleting the Last Image Captured While in Shooting Mode

In shooting mode, press the  button to delete the last image captured.

Using the Flash

In dark locations or when the subject is backlit, you can shoot pictures with a flash by raising the flash. You can set a flash mode that suits the shooting conditions.

- The flash has a range of about 0.5 to 8.0 m (1 ft. 8 in. to 26 ft.) at the wide-angle zoom position, and about 2.2 to 4.5 m (7 ft. 3 in. to 14 ft.) at the telephoto zoom position (when **ISO sensitivity** is set to **Auto**).

Auto

Flash fires automatically when lighting is dim.

Auto with red-eye reduction

Reduces “red-eye” in portraits.

Off

Flash does not fire.

Fill flash

The flash fires when a picture is taken, regardless of how bright the subject is. Use to “fill-in” (illuminate) shadows and backlit subjects.















Slow sync

Fill flash is combined with slow shutter speed. Suited to evening and night portraits that include background scenery. Flash illuminates main subject; slow shutter speeds are used to capture background at night or under dim lighting.

Rear-curtain sync

Fill flash fires just before the shutter closes, creating the effect of a stream of light behind moving subjects.

Flash Mode Setting

- The default flash mode setting varies with the shooting mode (□44).
 -  (auto) mode:  **Auto**
 - **SCENE** (Scene): Options vary depending on the scenes (□46 to 59).
 -  (Night landscape): fixed at  (Off)
 -  (Night portrait): fixed at  (auto with red-eye reduction)
 -  (Backlighting): fixed at  (fill flash) (when **HDR** is Off), fixed at  (Off) (when **HDR** is On) (□50)
 -  (Smart portrait):  (auto flash) (when blink proof is Off), fixed at  (Off) (when blink proof is On) (□68).
 - **P, S, A, M, U**:  **Auto**
- This feature cannot be used simultaneously with certain features. See “Functions that Cannot be Applied Simultaneously” (□104) for more information.
- In the following situations, the setting for flash mode is stored in the camera’s memory even after the camera is turned off.
 - When shooting mode **P, S, A** or **M** is used
 - When shooting with  (Auto with red-eye reduction) in  (auto) mode

Setting the Flash Mode

1 Press the (flash pop-up) button.

- Flash is raised.
- When the flash is lowered, the flash mode is fixed at  (Off).

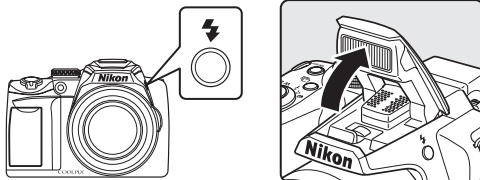





2 Press (flash mode) on the multi selector.

- The flash mode menu is displayed.



3 Press the multi selector or to choose the desired mode and press the button.

- The mode selected for the flash is displayed.
- When  (Auto) is applied,  is only displayed for a few seconds even if monitor indicators ( 17) are turned on.
- If a setting is not applied by pressing the  button within a few seconds, the selection will be canceled.

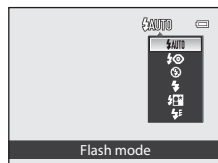

Lowering the Flash

When not using the flash, lower it by gently pushing it down.

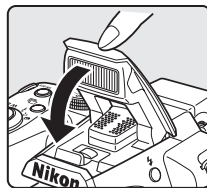

✓ Shooting When Lighting is Dim or When the Flash is Set to ⓧ (Off)

- Use of a tripod is recommended to stabilize the camera during shooting and avoid the effects of camera shake. When the camera is stabilized with a tripod, set **Vibration reduction** (📖183) to **Off** in the setup menu (📖185).
- **ISO** may be displayed in the shooting screen. When **ISO** is displayed, the ISO sensitivity has increased automatically.
- The noise reduction function may operate with some shooting conditions such as dim lighting. When the noise reduction function operates, it may take more time to save images.

✓ Note on Using the Flash

Reflections from dust particles in the air may appear as bright spots in pictures. To reduce these reflections, set the flash to ⓧ (Off), or shoot pictures with the flash lowered.

📎 Flash Indicator

The flash indicator shows the flash status when the shutter-release button is pressed halfway down.

- On: Flash fires when picture is shot.
- Blinks: Flash is charging. Wait a few seconds and try again.
- Off: Flash does not fire when picture is shot.

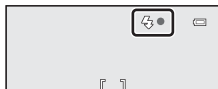

📎 Red-eye Reduction

This camera uses advanced red-eye reduction (“In-Camera Red-Eye Fix”).

Pre-flashes are fired repeatedly at low intensity before the main flash, reducing the red-eye effect. Additionally, if the camera detects red eye while saving an image, the affected area will be processed to reduce red-eye before the image is saved.

Note the following when taking pictures:

- Due to pre-flashes, there is a slight lag between when the shutter-release button is pressed and when the picture is shot.
- The time required to save the picture increases slightly.
- Red-eye reduction may not produce the desired results in some situations.
- In extremely rare instances, areas not subject to red-eye may be affected by advanced red-eye reduction processing. In these cases, choose another mode and try again.

When **Red-eye reduction** (📖196) in the setup menu is set to **Pre-flash off**, the shutter is released immediately when the shutter-release button is pressed all the way.

Taking Pictures with the Self-Timer

The self-timer is suitable for taking group pictures and reducing the vibration when the shutter-release button is pressed.

When using the self-timer, use of a tripod is recommended. Set **Vibration reduction** (📖193) in the setup menu (📖185) to **Off** when using a tripod to stabilize the camera.

1 Press (self-timer) on the multi selector.

- The self-timer menu is displayed.



2 Press the multi selector or to choose **10s** or **2s** and press the button.

- **10s** (ten seconds): suitable for group pictures
- **2s** (two seconds): suitable for preventing camera shake
- The mode selected for the self-timer is displayed.
- If the  button is not pressed within a few seconds, the selection will be canceled.

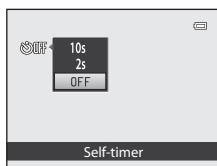

3 Frame the picture and press the shutter-release button halfway.

- The focus and exposure are set.

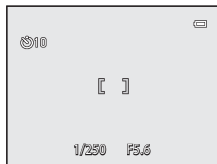

4 Press the shutter-release button the rest of the way down.

- The self-timer starts, and the number of seconds remaining before the shutter is released is displayed. The self-timer lamp blinks while the timer is counting down. About one second before the shutter is released, the lamp stops blinking and remains lit.
- When the shutter is released, the self-timer turns **OFF**.
- To stop the timer before a picture is taken, press the shutter-release button again.

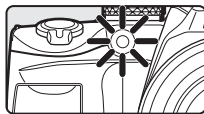

Using Focus Mode



Choose a focus mode according to the desired scene.

AF Autofocus

Camera automatically adjusts focus according to distance to subject. Use when the distance from subject to lens is 50 cm (1 ft. 8 in.) or more, or 2.2 m (7 ft. 3 in.) or more when camera is zoomed in to the maximum telephoto position.



Macro close-up

Use for close-ups of flowers or small objects.

The closest shooting distance will vary according to the magnification of the zoom. In the zoom position where the  icon and zoom indicator light in green (wide-angle position from the  icon), the camera can focus on subjects as close as about 10 cm (4 in.) from the lens. At the zoom position that is three increments from the maximum wide-angle position to the telephoto position, the camera can focus on subjects as close as about 1 cm (0.4 in.) from the lens.

Infinity







Use when shooting distant scenes through window glass or when shooting landscapes.

When the shutter-release button is pressed halfway, the focus area or focus indicator () always lights in green. However, the camera may not be able to focus on nearby objects. The flash mode is set to  (off).

MF Manual focus

The focus can be adjusted for any subject that is a distance of 1 cm (0.4 in.) to infinity from the lens (42).

Focus Modes Available in Each Shooting Mode

		P. S. A. M. U	SCENE				
AF (Autofocus)	✓ ¹	✓ ¹	2	-	✓	✓	✓
 (Macro close-up)	✓	✓		-	-	-	-
 (Infinity)	✓	✓		✓	-	-	-
MF (Manual focus)	-	✓		-	-	-	-

1 Default setting for each shooting mode.

2 Available focus modes and default setting vary between different scene modes (46 to 59).

The Focus Mode Setting



- For shooting modes **P**, **S**, **A** and **M**, the changed focus mode setting will be stored in the camera's memory even after the camera is turned off.
- This feature cannot be used simultaneously with certain features. See "Functions that Cannot be Applied Simultaneously" (104) for more information.

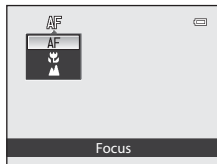

Setting the Focus Mode

- 1 Press  (focus mode) on the multi selector.

- The focus mode menu is displayed.



- 2 Press  or  on the multi selector to choose the desired focus mode and press the  button.

- The mode selected for focus mode is displayed.
- When **AF** (autofocus) is applied, **AF** is only displayed for a few seconds even if monitor indicators ( 17) are turned on.
- If a setting is not applied by pressing the  button within a few seconds, the selection will be cancelled.



Macro Close-up

When using shooting mode **P**, **S**, **A**, **M** or **U**, if the shooting menu **Autofocus mode** ( 101) is set to **Full-time AF**, the camera will continually focus until you press the shutter-release button halfway and the focus locks. A sound will be heard while the camera focuses.

In other shooting modes, **Full-time AF** is turned on automatically when macro mode is turned on (except **Pet portrait** scene mode).

Infinity

If you set focus mode to infinity while using  (auto) mode or the **P**, **S**, **A**, **M** and **U** modes, the focus area will not be displayed on the screen.

Using Manual Focus



Available when the shooting mode is **P**, **S**, **A**, **M**, **U** or the **Sports** scene mode. Select a shooting mode with the mode dial (📖44).

- 1** Press  (focus mode) on the multi selector to display the setup menu for focus mode.

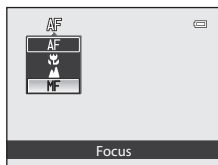
- Use the multi selector to choose **MF** (manual focus) and press the **OK** button.
- **MF** is displayed on the top of the monitor, and the image area and the enlarged center of the picture are displayed at the same time.



- 2** Adjust the focus.

- Use the multi selector to adjust the focus while viewing the image on the monitor.
- Press  to focus on far subjects.
- Press  to focus on near subjects.
- Press the shutter-release button halfway to check the composition. Press the shutter-release button the rest of the way down to take the picture.



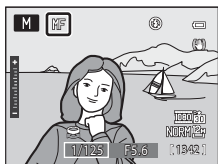

- 3** Press the **OK** button.

- The set focus is locked. You can continue shooting with the locked focus.
- To readjust the focus, press the **OK** button again to display the screen in step 2.
- To change back to autofocus, return to step 1 and choose any setting other than **MF**.



MF (Manual Focus)

- In step 2, the figure displayed with the gauge at the right of the monitor indicates an approximate distance (m) at which the subject can be in focus when the gauge is near the center. Depending on the zoom position, 1 (wide-angle position), 3 or 5 (telephoto position) is displayed. To see whether the subject is in focus, check the subject on the monitor.
- Press the shutter-release button halfway to preview an approximate depth of field (the area in focus behind and in front of the subject).
- Set **Assign side zoom control** (📖198) in the setup menu (📖185) to **Manual focus** to focus by using the side zoom control instead of  or  in step 2.
- The digital zoom is not available.

Adjusting Brightness (Exposure Compensation)

By adjusting exposure compensation when taking pictures, overall image brightness can be adjusted to make images brighter or darker.

1 Press (exposure compensation) on the multi selector.

- The exposure compensation guide and histogram are displayed.



2 Press the multi selector or to select a compensation value.

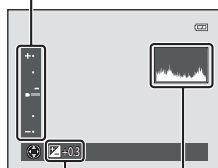

- To make the image brighter, apply positive (+) exposure compensation.
- To make the image darker, apply negative (-) exposure compensation.

Exposure compensation guide



Histogram
Exposure compensation value

3 Press the button to set the compensation value.



- If the  button is not pressed within a few seconds, the selection is set and the setting menu disappears.
- When an exposure compensation value other than **0.0** is applied, the value is displayed with the  indicator on the monitor.



4 Press the shutter-release button to take a picture.

- To cancel the exposure compensation setting, return to step 1 and change the value to **0.0**.

Exposure Compensation Value

- The exposure compensation value applied in **P**, **S** or **A** mode is saved in the camera's memory even after the camera is turned off.
- When the shooting mode is **M** (manual) mode (74) or the scene mode is **Fireworks show** (57), the exposure compensation cannot be used.

Using the Histogram

A histogram is a graph showing the distribution of tones in the image. Use as a guide when using exposure compensation and shooting without the flash.

- The horizontal axis corresponds to pixel brightness, with dark tones to the left and bright tones to the right. The vertical axis shows the number of pixels.
- Increasing exposure compensation shifts tone distribution to the right, and decreasing it shifts tone distribution to the left.

Selecting Scenes for Shooting (Mode Dial)

Rotate the mode dial and align an icon to the mark to select one of the following shooting modes.

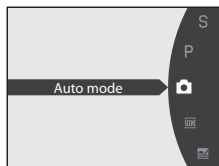

P, S, A, M mode (📖69)

Choose these modes for greater control over shutter speed and aperture value.

U User setting mode (📖108)

Setting combinations that are frequently used for shooting can be saved. The saved settings can be immediately retrieved for shooting simply by rotating the mode dial to **U**.

📷 Auto mode (📖28)

An automatic, “point-and-shoot” mode recommended for first-time users of digital cameras.

👤 Smart portrait mode (📖65)

The camera detects smiling faces using face priority and releases the shutter automatically. The Skin softening function makes a human subject’s skin appear smoother.

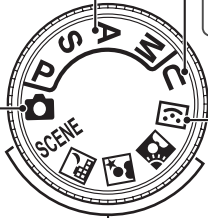

SCENE mode (📖45)

Shoot with settings suitable for the scene by choosing one of the scene modes.

SCENE (Scene): Choose the desired scene from 15 different scene types, and the camera’s settings are automatically optimized for the selected scene.

In Scene auto selector mode, the camera automatically selects the optimum scene mode for simpler shooting.

🌃 (Night landscape): Produces night landscape shots with reduced blurring and noise, or capture the atmosphere of a night landscape with a slow shutter speed.

🌃 (Night portrait): The flash fires to light the portrait subject while preserving the atmosphere of the evening or night view.

🌃 (Backlighting): The flash fires to prevent the backlit subject from being hidden in shadow, or the HDR function can be used to shoot scenes with high contrast.

Shooting Suited to Scenes (Scene Mode)

When one of the following scenes is selected using the mode dial or the scene menu, images are captured using settings that are optimized for the selected scene.



- Night landscape (📖48)
- Night portrait (📖49)
- Backlighting (📖50)

Rotate the mode dial to , , or and take pictures.

SCENE (Scene)

Press the **MENU** button to display the scene menu and choose one of the following shooting scenes.

Scene auto selector (default setting) (📖46)	Dusk/dawn (📖54)
Portrait (📖51)	Close-up (📖55)
Landscape (📖51)	Food (📖56)
Sports (📖52)	Museum (📖57)
Party/indoor (📖52)	Fireworks show (📖57)
Beach (📖53)	Black and white copy (📖57)
Snow (📖53)	Panorama (📖58)
Sunset (📖53)	Pet portrait (📖59)

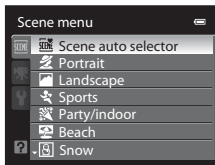
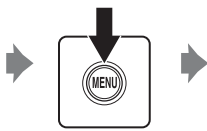
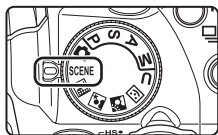







- For scene modes that use the flash, be sure to press the (flash pop-up) button to raise the flash before shooting.
- Choose a scene type from the scene menu and rotate the zoom control (📖4) toward **T** (?) to view a description (help) of that scene. To return to the original screen, rotate the zoom control toward **T** (?) again.

Image Quality and Image Size

If you press the **MENU** button in scene mode, you can set **Image quality** (📖83) and **Image size** (📖84). Changes made to the image quality and image size settings apply to all shooting modes (except for shooting mode **U**).

Shooting in the Scene Selected by the Camera (Scene Auto Selector)

By simply framing a picture, the camera automatically selects the optimum scene mode from the following for simpler shooting.

- : Auto mode (general shooting)
- : Portrait
- : Landscape
- : Night portrait
- : Night landscape
- : Close-up
- : Backlighting

1 Rotate the mode dial to SCENE.

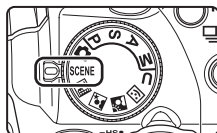

2 Press the MENU button to display the scene menu, choose Scene auto selector with the multi-selector and press the button.

- Scene auto selector is enabled.
- When the flash is not raised, the message **The flash is lowered.** is displayed.
- Press the  (flash pop-up) button to raise the flash.

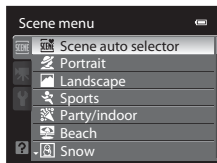
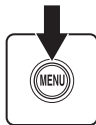

3 Frame the subject and take the picture.

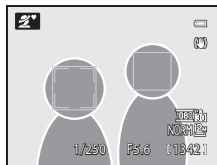

- The shooting mode icon changes.
- Press the shutter-release button halfway to set the focus and exposure. When the subject is in focus, the focus area (active focus area) lights in green.
- Press the shutter-release button the rest of the way down to take the picture.





✓ Notes on Scene Auto Selector

- The digital zoom is not available.
- Depending upon shooting conditions, the camera may not select the desired scene mode. Should this occur, switch to  (Auto) mode (📖28) or choose the desired scene mode manually (📖48).





📎 Focusing in Scene Auto Selector

- In Scene auto selector, the camera detects and focuses on a face (see “Shooting with Face Priority” (📖97) for more information).
- When the shooting mode icon is  or  (Close-up), in the same way as when the **AF area mode** (📖95) is set to **Auto**, the camera automatically selects one or more of the nine focus areas containing the subject closest to the camera.

📎 Shooting with Night landscape and Night portrait When Using Scene Auto Selector

- If the camera switches to  (Night landscape) when using Scene auto selector, pictures are shot continuously, and the camera combines these pictures to save a single picture.
- If the camera switches to  (Night portrait) when using Scene auto selector, flash mode is fixed at slow sync with red-eye reduction for shooting human subjects (the camera does not shoot continuously).
- In dark surroundings, the use of a tripod is recommended. Set **Vibration reduction** (📖193) to **Off** when using a tripod to stabilize the camera.

📎 Flash

-  **AUTO** (Auto) (default setting) or  (Off) flash mode settings (📖36) can be applied.
 - When  **AUTO** (Auto) is applied, the camera automatically chooses the optimum flash mode setting for the scene mode it has selected.
 - When  (Off) is set, the flash does not fire even when the flash is raised.
- If you do not want to use the flash, you can shoot while the flash is lowered.

📎 Functions Available in Scene Auto Selector

- Self-timer (📖39) and exposure compensation (📖43) settings can be adjusted.
- The  (focus mode) button (📖12, 40) on the multi selector is not available.

Selecting a Scene Mode to Take Pictures (Features)

- The mode dial can be used to select scenes when shooting (📖44).
- See “Shooting in the Scene Selected by the Camera (Scene Auto Selector)” (📖46) for more information on Scene auto selector scene mode.
- The 📷 shown for each scene is the setting for the flash mode when the flash is raised (📖36). ⌚ is the setting for the Self-timer (📖39), 🌸 is the setting for focus mode (📖40) and 📐 is the setting for exposure compensation (📖43).

Night landscape

NR

Use this mode to capture the ambience of night landscapes. Press the MENU button to select **Hand-held** or **Tripod** in **Night landscape**.



- **Hand-held** (default setting): This enables you to shoot with the minimum of camera shake and noise even when holding the camera by hand.
 - The 📷 icon is displayed on the shooting screen.
 - When the 📷 icon at the top left of the monitor lights in green, press the shutter-release button all the way to shoot a series of pictures, which will be combined into a single image and saved.
 - Once the shutter-release button is pressed all the way, hold the camera steady without moving it until a still picture is displayed. After taking a picture, do not turn the camera off before the monitor switches to the shooting screen.
 - The angle of view (image area) seen in the saved image will be narrower than that seen on the monitor at the time of shooting.
- **Tripod**: Select this mode when the camera is stabilized, such as with a tripod.
 - The 📷 icon is displayed on the shooting screen.
 - **Vibration reduction** (📖193) is automatically set to **Off** regardless of the applied option in the setup menu (📖185).
 - Press the shutter-release button all the way to shoot a single picture at slow shutter speeds.
- Camera focuses at infinity. When the shutter-release button is pressed halfway, the focus area always lights in green. However, because the camera focuses at infinity, it may not be able to focus on nearby objects.
- The digital zoom is not available.
- AF-assist illuminator (📖196) does not light.

			Off*				0.0*
---	---	---	------	---	---	---	------

* Other settings can be selected.

NR: Noise reduction is performed for pictures shot in scene modes with **NR**, so they may take longer to record.







Night portrait

NR

Use this mode for portraits taken at sunset or at night. Flash is used to illuminate the subject while maintaining the mood of the background.

Press the **MENU** button to select **Hand-held** or **Tripod** in **Night portrait**.



- **Hand-held:** This enables you to shoot with the minimum of camera shake and noise even when holding the camera by hand.
 - The  icon is displayed on the shooting screen.
 - When the  icon at the top left of the monitor lights in green, press the shutter-release button all the way to shoot a series of pictures, which will be combined into a single image and saved.
 - Once the shutter-release button is pressed all the way, hold the camera steady without moving it until a still picture is displayed. After taking a picture, do not turn the camera off before the monitor switches to the shooting screen.
 - The angle of view (image area) seen in the saved image will be narrower than that seen on the monitor at the time of shooting.
 - If the subject moves while the camera is shooting continuously, the image may be distorted, overlapped, or blurred.
- **Tripod** (default setting): Select this mode when the camera is stabilized, such as with a tripod.
 - The  icon is displayed on the shooting screen.
 - **Vibration reduction** (193) is automatically set to **Off** regardless of the applied option in the setup menu (185).
 - Press the shutter-release button all the way to shoot a single picture at slow shutter speeds.
- Shoot pictures with the flash raised.
- The digital zoom is not available.
- The camera automatically detects and focuses on a face (see "Shooting with Face Priority" (97) for more information).
 - If the camera detects multiple faces, the camera focuses on the face closest to the camera.
 - After the Skin softening feature makes the subject's skin appear smoother (up to three people), the camera records the image (66).
 - If no faces are recognized, the camera focuses on the subject at the center of the frame.

	 1		Off ²		AF		0.0 ²
---	---	---	------------------	---	----	---	------------------

1 Fill flash is used with red-eye reduction.

2 Other settings can be selected.

NR: Noise reduction is performed for pictures shot in scene modes with **NR**, so they may take longer to record.

Shooting Suited to Scenes (Scene Mode)

Backlighting

Use when light is coming from behind the subject, throwing features or details into shadow. Press the **MENU** button to adjust HDR (high dynamic range) composite settings in **HDR** for the shooting scene.



- When **HDR** is set to **Off** (default setting): The flash fires to prevent the subject from being hidden in shadow.
 - Shoot pictures with the flash raised.
 - Press the shutter-release button all the way to shoot a single picture.



- When **HDR** is set to **On**: Use when taking pictures with very bright and dark areas in the same frame.
 - The **HDR** icon is displayed on the shooting screen. If there are very bright areas and very dark areas in the frame, the  icon lights in green.
 - The digital zoom is not available.
 - When the shutter-release button is pressed all the way, the camera shoots pictures continuously with a high shutter speed, and saves the following two images.
 - An image processed by D-Lighting (📖149) at the time of shooting
 - HDR composite image (the effects of over-exposure and under-exposure are reduced)
 - The second image saved is an HDR composite image. If only one image can be saved, an image processed by D-Lighting is the only image saved.
 - Once the shutter-release button is pressed all the way, hold the camera steady without moving it until a still picture is displayed. After taking a picture, it takes some time to save the image. Do not turn the camera off before the monitor switches to the shooting screen.
 - The angle of view (image area) seen in the saved image will be narrower than that seen on the monitor at the time of shooting.
- The camera focuses on the subject at the center of the frame.



			Off ²		AF		0.0 ²
---	---	---	------------------	---	----	---	------------------

- 1 When **HDR** is set to **Off**, the flash mode is fixed at  (fill flash).
When **HDR** is set to **On**, the flash mode is fixed at  (off).
- 2 Other settings can be selected.

SCENE →  Portrait

Use this mode for portraits.

- The camera automatically detects and focuses on a face (see “Shooting with Face Priority” (📖97) for more information).
- If the camera detects multiple faces, the camera focuses on the face closest to the camera.
- After the Skin softening feature makes the subject’s skin appear smoother (up to three people), the camera records the image (📖66).
- If no faces are detected, the camera focuses on the subject at the center of the frame.
- The digital zoom is not available.



Off*



AF



0.0*

* Other settings can be selected.

SCENE →  Landscape

Use this mode for vivid landscapes and cityscapes.

- The camera focuses at infinity. When the shutter-release button is pressed halfway, the focus area or focus indicator (📖8) always lights in green. However, because the camera focuses at infinity, it may not be able to focus on nearby objects.
- AF-assist illuminator (📖196) does not light.



Off*



0.0*

* Other settings can be selected.

Shooting Suited to Scenes (Scene Mode)

SCENE → Sports

Use this mode for dynamic action shots that freeze the action in a single shot and record motion in a series of pictures. With continuous shooting, instantaneous movements of moving subjects can be captured clearly.

- The camera focuses on the subject at the center of the frame. The camera continuously adjusts the focus until the shutter-release button is pressed halfway to lock the focus.
- While the shutter-release button is pressed all the way, up to five pictures are shot at a rate of about eight frames per second (fps) when Image quality is set to **Normal** and Image size is set to **4000x3000**.
- Focus, exposure and white balance are fixed at values determined with the first shot in each series.
- The frame rate with continuous shooting may vary, depending upon the current image quality setting, image size setting, and the memory card used.
- AF-assist illuminator (📖196) does not light.



More on Shooting



1 MF (manual focus) can be selected.

2 Other settings can be selected.

SCENE → Party/indoor

Suitable for taking pictures in parties. Captures the effects of candlelight and other indoor background lighting.

- The camera focuses on the subject at the center of the frame.
- Hold the camera steadily as pictures are easily affected by camera shake. When shooting under low lighting, use of a tripod is recommended. Set **Vibration reduction** (📖193) to **Off** when using a tripod to stabilize the camera during shooting.



1 Slow sync with red-eye reduction flash mode may be used. Other settings can be selected.

2 Other settings can be selected.

SCENE →  Beach

Captures the brightness of such subjects as beaches, or sunlit expanses of water.

- The camera focuses on the subject at the center of the frame.



* Other settings can be selected.

SCENE →  Snow

Captures the brightness of such subjects as sunlit snowfields.

- The camera focuses on the subject at the center of the frame.



* Other settings can be selected.



SCENE →  Sunset

Preserves the deep hues seen in sunsets and sunrises.

- The camera focuses on the subject at the center of the frame.



* Other settings can be selected.

: Use of a tripod is recommended in scenes with which  is indicated. Set **Vibration reduction** (p.193) to **Off** when using a tripod to stabilize the camera.

Shooting Suited to Scenes (Scene Mode)

SCENE → 🏠 Dusk/dawn



Preserves the colors seen in the weak natural light before sunrise or after sunset.

- The camera focuses at infinity. When the shutter-release button is pressed halfway, the focus area or focus indicator (📖8) always lights in green. However, because the camera focuses at infinity, it may not be able to focus on nearby objects.
- AF-assist illuminator (📖196) does not light.



Off*



0.0*

* Other settings can be selected.













📐: Use of a tripod is recommended in scenes with which 📐 is indicated. Set **Vibration reduction** (📖193) to **Off** when using a tripod to stabilize the camera.

NR: Noise reduction is performed for pictures shot in scene modes with NR, so they may take longer to record.

SCENE →  Close-up

Photograph flowers, insects and other small objects at close range.



- The focus mode () setting is changed to  (macro close-up) and the camera automatically zooms to the closest position to the subject where the camera can shoot.
- The closest distance at which the camera can focus varies depending on the zoom position. In the zoom position where the  icon and zoom indicator light in green (wide-angle position from the  icon), the camera can focus on subjects as close as about 10 cm (4 in.) from the lens. At the zoom position that is three increments from the maximum wide-angle position to the telephoto position, the camera can focus on subjects as close as about 1 cm (0.4 in.) from the lens.
- **AF area mode** is set to **Manual** to enable the focus area to be chosen (95). Press the  button, and then press the multi selector , ,  or  to move the focus area. To adjust the following settings, press the  button to temporarily cancel focus area selection, and then adjust each setting.
 - Flash mode or self-timer
 - Exposure compensation
- The camera continuously focuses using autofocus until you press the shutter-release button halfway to lock the focus.
- As pictures are easily affected by camera shake, be sure that **Vibration reduction** (193) is enabled and hold the camera steadily.



- 1 Other settings can be selected. Note that when shooting with the flash, the flash may be unable to light the entire subject at distances of less than 50 cm (1 ft. 8 in.).
- 2 Other settings can be selected.

Shooting Suited to Scenes (Scene Mode)

SCENE → **Tl** Food

Use this mode when taking pictures of food.

- The focus mode (📖40) setting is changed to 🌸 (macro close-up) and the camera automatically zooms to the closest position to the subject where the camera can shoot.



- The closest distance at which the camera can focus varies depending on the zoom position. In the zoom position where the 🌸 icon and zoom indicator light in green (wide-angle position from the △ icon), the camera can focus on subjects as close as about 10 cm (4 in.) from the lens. At the zoom position that is three increments from the maximum wide-angle position to the telephoto position, the camera can focus on subjects as close as about 1 cm (0.4 in.) from the lens.

- You can adjust hue within a slider display at the left of the monitor. Press the multi selector ▲ to increase the red hue, and ▼ to increase the blue hue. The hue adjustments are stored in the camera's memory even after the camera is turned off.

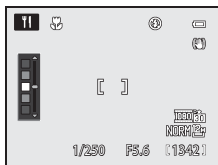



- **AF area mode** is set to **Manual** to enable the focus area to be chosen (📖95). Press the **OK** button, and then press the multi selector ▲, ▼, ◀ or ▶ to move the focus area. To adjust the following settings, press the **OK** button to temporarily cancel focus area selection, and then adjust each setting.
 - Hue
 - Self-timer
 - Exposure compensation
- The camera focuses continuously until focus is locked by pressing the shutter-release button halfway.
- As pictures are easily affected by camera shake, be sure that **Vibration reduction** (📖193) is enabled and hold the camera steadily.

			Off*				0.0*
--	--	--	------	--	--	--	------

* Other settings can be selected.

SCENE →  Museum

Use indoors where flash photography is prohibited (for example, in museums and art galleries) or in other situations in which you do not want to use the flash.

- The camera focuses on the subject at the center of the frame.
- BSS (Best Shot Selector) ()76) can be used for shooting.
- As pictures are easily affected by camera shake, be sure that **Vibration reduction** ()193) is enabled and hold the camera steadily.
- AF-assist illuminator ()196) does not light.





1 Other settings can be selected.

2  (macro close-up) can be selected.



SCENE →  Fireworks show

Slow shutter speeds are used to capture the expanding burst of light from fireworks.

- The camera focuses at infinity. When the shutter-release button is pressed halfway, the focus indicator ()8) always lights in green. However, because the camera focuses at infinity, it may not be able to focus on nearby objects.
- AF-assist illuminator ()196) does not light.

SCENE →  Black and white copy



Provides clear pictures of text or drawings on a white board or in print.

- The camera focuses on the subject at the center of the frame.
- Use  (macro close-up) mode at focus mode ()40) with this mode to shoot pictures at close distances.
- Colored text and drawings may not show up well.



1 Other settings can be selected.

2  (macro close-up) can be selected.

: Use of a tripod is recommended in scenes with which  is indicated. Set **Vibration reduction** ()193) to **Off** when using a tripod to stabilize the camera.

SCENE → Panorama





Use this mode for shooting panorama pictures.

Select **Easy panorama** or **Panorama assist** on the screen that is displayed when **Panorama** scene mode is selected.

- **Easy panorama** (default setting): Shoots panorama pictures that can be played back on the camera by moving the camera in the direction you want to create a panorama picture.
 - See “Taking Pictures with Easy Panorama” (📖60).
 - See “Viewing Pictures Recorded with Easy Panorama” (📖62).
- **Panorama assist**: Shoots multiple pictures while confirming the seams. Transfer pictures to a computer and use the supplied **Panorama Maker 5** software (📖177) to join them in a single panorama.
 - See “Taking Pictures with Panorama Assist” (📖63).



- 1 When shooting in **Panorama assist**, other settings can be selected.
- 2 When shooting in **Panorama assist**, the self-timer is available.
- 3 When shooting in **Easy panorama**,  (infinity) can be selected.
When shooting in **Panorama assist**,  (macro close-up) or  (infinity) can be selected.
- 4 Other settings can be selected.

Note on Printing Panorama Pictures

When printing panorama pictures, a full view may not be printed depending on the printer settings. Additionally, printing may not be available depending on the printer.

For more information, see your printer's manual or contact a digital photo lab.

SCENE → 🐾 Pet portrait

Use this mode for shooting pictures of dogs or cats. The camera detects and focuses on the face of a dog or cat. When the subject is in focus, the shutter is released automatically (Pet portrait auto release (default setting)) and the camera shoots three pictures.



- Detected faces are displayed in a double frame indicating the focus area, and when a face is in focus, this double frame lights in green.
 - Up to five pet faces can be detected simultaneously. If the camera detects multiple faces, the double-frame focus area is displayed around the largest face on the monitor, and single-frame borders are displayed around the other faces.
- Even if a pet's face is not detected, press the shutter-release button to release the shutter.
 - If a pet's face is not detected, the camera focuses on the subject at the center of the frame.
- Press the (continuous shooting mode) button (4) to change the continuous settings.
 - **Single**: One picture is shot each time the shutter-release button is pressed. When **Single** is selected, is displayed for a few seconds on the shooting screen.
 - **Continuous** (default setting): In **Pet portrait auto release** (default setting), the camera shoots three pictures when it focuses on the detected face (Frame rate: up to about 1.8 fps when the image quality is **Normal** and the image size is **4000x3000**). When pet portrait auto release is not used, the camera shoots about 24 pictures at a rate of up to about 1.8 frames per second while the shutter-release button is pressed all the way (when the image quality is **Normal** and the image size is **4000x3000**). When **Continuous** is selected, is displayed on the shooting screen.
- Press the multi selector (🔄) to change the pet portrait auto release settings.
 - **Pet portrait auto release** (default setting): When the camera focuses on the detected face, the shutter is released automatically. When **Pet portrait auto release** is selected, is displayed on the shooting screen.
 - **Off**: Press the shutter-release button to release the shutter.
- **Pet portrait auto release** is automatically set to **Off** in the following situations.
 - When continuous shooting using pet portrait auto release is repeated five times
 - When the camera resumes from standby mode for saving power (23)
 - When the internal memory or memory card becomes full

To continue shooting using **Pet portrait auto release**, press the multi selector (🔄) and reset.
- The digital zoom is not available.
- AF-assist illuminator (196) does not light. Button and shutter sounds (199) are disabled.
- In some cases, dogs or cats may not be detected or other animals may be detected, depending on the distance between the camera and the pet, where the pet is facing, how fast it is moving, the brightness, and other shooting conditions.

			1	AF ²			0.0 ³

1 Off can be selected. The self-timer **10s** or **2s** cannot be used.

2 (macro close-up) can be selected.

3 Other settings can be selected.

Taking Pictures with Easy Panorama

- 1 Rotate the mode dial to **SCENE**.

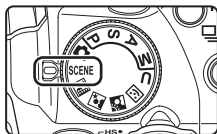

- 2 Press the **MENU** button to display the scene menu screen, choose **Panorama** with the multi-selector and press the **OK** button.

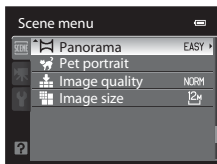

- 3 Choose **EASY Easy panorama** and press the **OK** button.

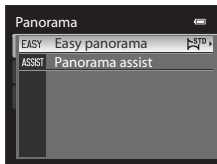

- 4 Select the shooting range from **STD Normal (180°)** or **WIDE Wide (360°)**, and press the **OK** button.

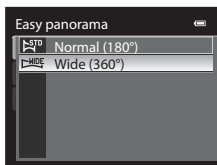

- The image size (W × H) when the camera is held in landscape orientation is as follows.
 - STD Normal (180°)**: 3200 × 560 when the camera is moved horizontally, 1024 × 3200 when the camera is moved vertically
 - WIDE Wide (360°)**: 6400 × 560 when the camera is moved horizontally, 1024 × 6400 when the camera is moved vertically
- For the image size when the camera is held in "tall" orientation, the combinations of the moving direction and W × H are the opposites of the above.

5 Frame the first portion of the panorama scene, and press the shutter-release button halfway to adjust the focus.

- The zoom is fixed at the wide-angle position.
- The framing guide is displayed on the screen.
- The camera focuses on the subject at the center of the frame.
- Exposure compensation (📖43) can be adjusted.
- If the focus or exposure cannot be set for the main subject, try the focus lock (📖33).

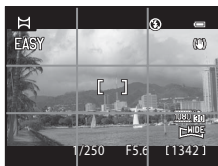

6 Press the shutter-release button all the way, and release it.

- The ▶ icon showing the current panorama direction is displayed.



7 Move the camera straight and slowly in one of the four directions to start shooting.

- When the camera detects the panorama direction, the shooting starts.
- The guide showing the current shooting point is displayed.
- When the guide showing the shooting point reaches the end, the shooting ends.



Guide

Example of moving the camera

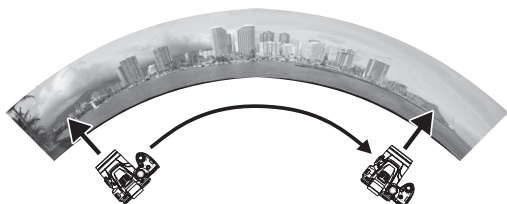

- Hold the camera steadily and move it horizontally or vertically, as in drawing an arc.
- Move the camera from end to end within about 15 seconds when the panorama range is 180°, and within about 30 seconds when it is 360°.

✓ Notes on Easy Panorama Shooting

- The image area seen in the saved image will be narrower than that seen on the monitor at the time of shooting.
- When the camera movement speed is too fast or there is a large amount of camera shake, the shooting ends in an error.
- Panorama pictures are not saved when the shooting stops before reaching half of the panorama range.
- When the shooting reaches more than half of the panorama range but finishes before the end point, the range that is not shot will be recorded as a gray area.

Viewing Pictures Recorded with Easy Panorama

Switch to playback mode (📖34, 111), display the picture recorded with easy panorama in full-frame playback mode and press the **OK** button. The camera displays the short side of the picture filling the entire screen and scrolls the picture automatically.

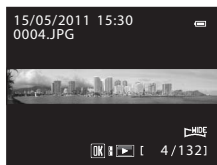

- The picture is scrolled in the direction of the panorama shooting.
- Press the multi selector to fast forward or rewind. Playback controls are displayed at the top of the monitor during playback. When you choose a playback control with the multi selector **◀** or **▶** and press the **OK** button, the following operations can be performed.



To	Use	Description
Rewind	◀◀	Scroll quickly back while the OK button is pressed.
Advance	▶▶	Scroll quickly forward while the OK button is pressed.
Pause	⏸	The following operations can be performed with the playback controls at the top of the monitor while playback is paused.
		◀◀ Rewind while the OK button is pressed.*
		▶▶ Scroll while the OK button is pressed.*
	▶	Restart the automatic scroll.
End	■	Return to full-frame playback mode.

* The pictures can also be scrolled by rotating the command dial.

✓ Note on Viewing Pictures Recorded with Easy Panorama

Panorama pictures recorded with functions other than easy panorama of the COOLPIX P500 may not be scrolled or zoomed on this camera.

Taking Pictures with Panorama Assist

The camera focuses on the subject at the center of the frame. Using a tripod makes the composition easier. When the camera is stabilized with a tripod, set **Vibration reduction** (📖193) to **Off** in the setup menu (📖185).

1 Rotate the mode dial to **SCENE**.



2 Press the **MENU** button to display the scene menu screen, choose **Panorama** with the multi selector and press the **OK** button.

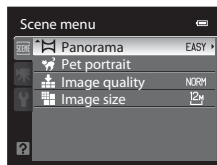
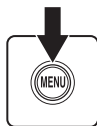

3 Choose **ASSIST Panorama assist** and press the **OK** button.

- The icon is displayed to show the direction in which pictures are joined.

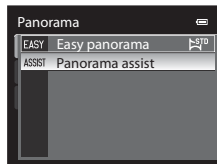

4 Use the multi selector to choose the direction and press the **OK** button.

- Select the direction in which pictures are joined in the completed panorama: right () , left () , up () or down () .
- The yellow icon () moves to the direction pressed, so press the **OK** button to choose the direction. A white icon () is displayed in the chosen direction.
- Apply flash mode (📖36), self-timer (📖39), focus mode (📖40) and exposure compensation (📖43) settings with this step, if necessary.
- Press the **OK** button again to reselect the direction.

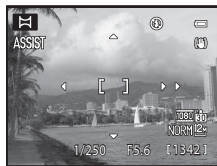

5 Frame the first portion of the panorama scene and take the first picture.

- 1/3 of the image will be displayed as translucent.

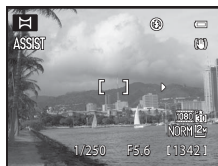

6 Shoot the next picture.

- Match the outline of the next picture so that 1/3 of the frame overlaps the previous picture, and press the shutter-release button.
- Repeat until you have taken the necessary number of pictures to complete the image.



7 Press the **OK** button when shooting is completed.

- The camera returns to step 4.

✓ Notes on Panorama Assist

- Set the flash mode, self-timer, focus mode and exposure compensation before releasing the shutter for the first picture. The settings cannot be changed after shooting the first picture. Pictures cannot be deleted, nor can zoom, **Image quality** (183), or **Image size** (184) be adjusted after shooting the first picture.
- The panorama series is terminated if the auto off function (199) triggers the standby mode during shooting. To prevent this, setting a longer time for the auto off function is recommended.

🔍 AE/AF-L (exposure lock) Indicator

When using panorama assist mode, all pictures in the panorama have the same exposure, white balance, and focus as the first picture of the panorama.

When the first picture is shot, **AE/AF-L** is displayed to indicate that exposure, white balance, and focus are locked.



🔍 Panorama Creation

Transfer pictures to a computer (174) and use Panorama Maker 5 (177) to join them in a single panorama.

Install Panorama Maker 5 on a computer using the supplied ViewNX 2 CD-ROM.

🔍 More Information

See "File and Folder Names" (215) for more information.

Taking Pictures of Smiling Faces (Smart Portrait Mode)



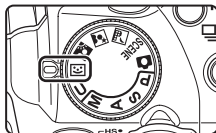

In the default setting, the camera detects smiling faces using face priority and releases the shutter automatically (smile timer function). The Skin softening function makes a human subject's skin appear smoother.

1 Rotate the mode dial to (Smart portrait).

- The camera enters smart portrait mode.



2 Frame the picture.

- Point the camera at the subject.
- When the camera detects a face, the focus area containing the face is displayed with a double border.
- Up to three faces can be detected. When more than one face is detected, the face closest to the center of the frame is framed by a double border and the others by single borders.
- When more than one face is detected, press the  button to choose on which face to focus. Press  or  on the multi selector to choose the face on which to focus and press the  button.

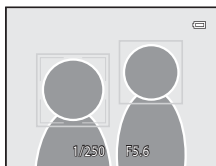

3 The shutter is automatically released.

- If the camera detects that the face framed by the double border is smiling, the **Smile timer** function (67) automatically releases the shutter.
- Each time the shutter is released, automatic shooting using face detection and smiling face detection is repeated.

4 Finish shooting.

- To finish automatic shooting of smiling faces, either turn the camera off, set **Smile timer** to **Off**, or rotate the mode dial to select another shooting mode.

Taking Pictures of Smiling Faces (Smart Portrait Mode)

✔ Notes on Smart Portrait Mode

- The digital zoom is not available.
- Under some shooting conditions, faces and smiling faces may not be detected properly.
- See “Notes on Face Priority” (📖98) for more information.

✔ Notes on Skin Softening

- When taking pictures with skin softening, the time required to save the pictures increases slightly.
- Depending on shooting conditions, even if the camera detects a face on the monitor at the time of shooting, effects of the skin softening function may not be visible, or areas other than the face may be processed. If the desired effect is not achieved, set **Skin softening** to **Off** and shoot again.
- The extent of skin softening effect that is applied cannot be set while using the 🌃 (Night portrait) or **Portrait** scene modes.
- Skin softening can also be applied to pictures after they have been taken (📖150).

✍ Auto Power Off When Using Smile Timer

When **Smile timer** is set to **On**, the auto off function (📖199) will turn the camera off in the following situations if no operations are performed.

- The camera is unable to detect any face.
- The camera has detected one or more faces, but is unable to detect a smiling face.

✍ When the Self-timer Lamp Blinks

When using the Smile timer, the self-timer lamp blinks when the camera detects a face and flickers immediately after the shutter is released.

✍ Releasing the Shutter Manually

The shutter can also be released by pressing the shutter-release button. If no faces are detected, the camera focuses on the subject at the center of the frame.

✍ Functions Available in Smart Portrait Mode

- Flash mode is disabled when **Blink proof** is set to **On**. Flash mode (📖36) will be changed to **⚡AUTO** (auto) when **Blink proof** is set to **Off** (other settings can be selected).
- If **Smile timer** is set to **Off**, self-timer (📖39) can be set.
- The focus mode is fixed at **AF** (autofocus).
- Exposure compensation (📖43) can be adjusted.
- If you press the **MENU** button to display the 🗨 (Smart portrait) menu, you can change the settings for **Image quality**, **Image size**, **Skin softening**, **Smile timer**, or **Blink proof**.

🔍 More Information

See “Autofocus” (📖33) for more information.

Smart Portrait Menu

In the smart portrait mode, the following functions can be set when the **MENU** button (📖13) is pressed to display the 😊 smart portrait menu.

- **Smile timer** and **Blink proof** cannot be used simultaneously.

Image quality

Image quality (📖83) settings can be changed. Changes made to the image quality setting apply to all shooting modes (except for shooting mode **U**).

Image size

Image size (📖84) settings can be changed. Changes made to the image size setting apply to all shooting modes (except for shooting mode **U**).

Skin softening

Set skin softening. When the shutter is released, the camera detects up to three faces and processes the image to make the faces appear smoother, then records the image.

The effect of this feature can be set to **High**, **Normal** (default setting) or **Low**. When **Off** is selected, Skin softening is turned off.

- When Skin softening is enabled, the icon for the current setting is displayed on the monitor during shooting (📖8). When **Off** is selected, an icon for the current setting is not displayed. Additionally, the effects of the current skin softening setting cannot be previewed on the monitor while shooting. To confirm, view the pictures after shooting.

Smile timer

- **On** (default setting): Among the detected faces, if a smile is detected on the face that is framed by a double border, the camera automatically releases the shutter. When the flash does not fire, the shutter is released five times each time a picture is taken, and the picture in which the most people have smiles is saved.
- **Off**: The camera does not release the shutter automatically using smile timer; the shutter is only released when the shutter-release button is pressed.
- When smile timer is enabled, the current setting is displayed during shooting (📖8). When **Off** is selected, an icon for the current setting is not displayed.

Blink proof

When set to **On**, the shutter is released five times as the shutter-release button is pressed all the way once; the camera chooses one picture in which the subjects' eyes are open, and saves it.

- The message on the right will be displayed for a few seconds when the camera records a picture in which someone may have been blinking.
- When **Blink proof** is turned **On**, **Smile timer** is turned **Off**. Press the shutter-release button to release the shutter.
- When set to **On**, the flash cannot be used.
- The default setting is **Off**.
- When blink proof is enabled, the current setting is displayed during shooting (📖8). When **Off** is selected, an icon for the current setting is not displayed.



Displaying the Smart Portrait Menu

Rotate the mode dial to  (Smart portrait) mode.

Press the **MENU** button (📖13) to display the smart portrait menu.

- Use the multi selector to select and set menu options (📖12).
- To exit the smart portrait menu, press the **MENU** button.

Setting the Exposure for Shooting (P, S, A, M Modes)

P, S, A, M Modes

By rotating the mode dial, you can shoot pictures in the following four exposure modes: **P** (Programmed auto), **S** (Shutter-priority auto), **A** (Aperture-priority auto), and **M** (Manual).

Not only can you set the shutter speed and aperture value, you can also select a variety of advanced settings, such as changing the ISO sensitivity and white balance in the shooting menu (📖81).

Mode	Description	Usage
P Programmed auto (📖71)	The camera sets the shutter speed and aperture value automatically for optimal exposure. Flexible program, which changes the combination of shutter speed and aperture value with the same exposure, can be used (📖71).	Recommended for most situations.
S Shutter-priority auto (📖72)	The user chooses the shutter speed; the camera selects the aperture value automatically.	Use to shoot fast moving subjects with a fast shutter speed, or use to emphasize the movements of a moving subject with a slow shutter speed.
A Aperture-priority auto (📖73)	The user chooses the aperture value; the camera selects the shutter speed automatically.	Use to blur the background or bring both the foreground and background into focus.
M Manual (📖74)	The user controls both the shutter speed and aperture value.	Use to control the exposure according to shooting requirements.

Even when the mode dial is set to **U** (user setting mode), you can shoot in **P** (Programmed auto), **S** (Shutter-priority auto), **A** (Aperture-priority auto) or **M** (Manual). The setting combinations (user settings) that are frequently used for shooting can be saved in **U** (📖108).

Functions Available in P, S, A and M Modes

- The flash mode (📖36) can be changed, and the self-timer (📖39), focus mode (📖40) and exposure compensation (📖43) settings can be adjusted.
- Press the **MENU** button to adjust the shooting menu (📖81) settings.

Shutter Speed and Aperture Value

The same exposure can be achieved with different combinations of shutter speed and aperture value, allowing you to freeze or blur motion and control depth of field. The following figures show how shutter speed and aperture value affect exposure. When the ISO sensitivity setting (📖92) is changed, the range of shutter speeds and aperture values at which the correct exposure can be obtained also changes.

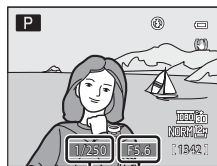

Shutter speed

Aperture value

Shutter Speed



Fast shutter speed
1/1000 s



Slow shutter speed
1/30 s

Aperture Value



Large aperture
(Small f-number)
f/3.4



Small aperture
(Large f-number)
f/8

P (Programmed Auto) Mode

The camera sets the shutter speed and aperture value automatically for optimal exposure.

1 Rotate the mode dial to P.

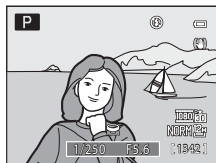

2 Frame the subject and shoot.

- In the default setting, the camera automatically selects one or more of the nine focus areas containing the subject closest to the camera. When the subject is in focus, the focus area (active focus area) lights in green (maximum of nine areas) (📖95).



Flexible Program

In mode **P** (Programmed auto), different combinations of shutter speed and aperture value can be selected without changing the exposure by rotating the command dial ("flexible program"). While flexible program is in effect, a flexible program mark (**X**) appears next to the mode indicator (**P**) in the upper left of the monitor.

- Rotate the command dial to the right for large apertures (small f-numbers) when you want to blur background details, or for fast shutter speeds to capture fast-moving subjects.
- Rotate the command dial to the left for small apertures (large f-numbers) when you want to increase depth of field, or for slow shutter speeds to emphasize the motion of a subject.
- To cancel flexible program, rotate the command dial until the flexible program mark (**X**) is no longer displayed. Selecting another shooting mode, or turning off the camera, also cancels flexible program.

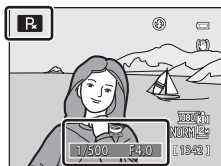
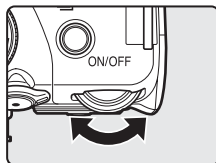

✔ Note on P (Programmed Auto) Shooting

When the subject is too dark or too bright, it may not be possible to obtain the appropriate exposure. In such cases, the shutter speed indicator and aperture value indicator blink when the shutter-release button is pressed halfway. It may be possible to obtain the appropriate exposure by changing settings such as the ISO sensitivity (📖92).

🔑 Shutter Speed

The control range of the shutter speed differs depending on the ISO sensitivity setting. Additionally, the range is restricted during continuous shooting (📖107).

S (Shutter-Priority Auto) Mode

The user chooses the shutter speed; the camera selects the aperture value automatically.

- The shutter speed can be set in a range from a maximum speed of 1/1500 to two seconds.

1 Rotate the mode dial to **S**.

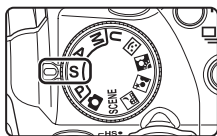

2 Rotate the command dial to choose a shutter speed value.

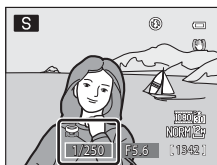

3 Focus and shoot.

- In the default setting, the camera automatically selects one or more of the nine focus areas containing the subject closest to the camera. When the subject is in focus, the focus area (active focus area) lights in green (maximum of nine areas) (📖95).

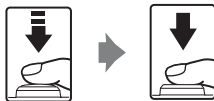

👍 Notes on S (Shutter-Priority Auto) Shooting

- When the subject is too dark or too bright, it may not be possible to obtain the appropriate exposure with the set shutter speed. In such cases, the shutter speed indicator blinks when the shutter-release button is pressed halfway. Choose another shutter speed and try again.
- At shutter speeds of 1/4 second or slower, noise may appear in the image. In such situations, the shutter speed indicator lights in red. Setting **Long exposure NR** (📖102) to **On** is recommended.

📎 Shutter Speed

The control range of the shutter speed differs depending on the ISO sensitivity setting. Additionally, the range is restricted during continuous shooting (📖107).

A (Aperture-Priority Auto) Mode

The user chooses the aperture value; the camera selects the shutter speed automatically.

1 Rotate the mode dial to **A**.

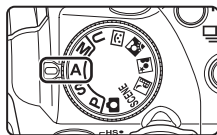

2 Rotate the command dial to choose the aperture value (f-number).

- The aperture value can be set in a range of f/3.4 to 8 (wide-angle position) and f/5.7 to 8 (telephoto position).

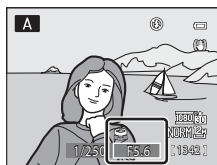

3 Focus and shoot.

- In the default setting, the camera automatically selects one or more of the nine focus areas containing the subject closest to the camera. When the subject is in focus, the focus area (active focus area) lights in green (maximum of nine areas) (1095).



✔ Note on A (Aperture-Priority Auto) Shooting

When the subject is too dark or too bright, it may not be possible to obtain the appropriate exposure with the set aperture value. In such cases, the aperture value indicator blinks when the shutter-release button is pressed halfway. Choose another aperture value and try again.

🔧 Shutter Speed

The control range of the shutter speed differs depending on the ISO sensitivity setting. Additionally, the range is restricted during continuous shooting (107).

🔍 Aperture and Zoom

The aperture value (f-number) indicates the lens brightness. Large apertures (expressed by small f-numbers) let more light into the camera, and small apertures (large f-numbers) let less light. When the camera is zoomed in, the lens aperture can be changed within a range of f/3.4 to 5.7. The aperture value increases (becomes darker) when zooming to the telephoto position, and decreases (becomes brighter) when zooming to the wide-angle position.

M (Manual) Mode

The user controls both the shutter speed and aperture value.

- The shutter speed can be set in a range from a maximum speed of 1/1500 to eight seconds.

1 Rotate the mode dial to **M**.

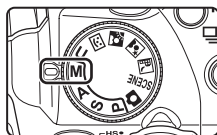

2 Press the multi selector **▶** to activate the shutter speed setting.

- The active setting switches between shutter speed and aperture each time the multi selector **▶** is pressed.
- At shutter speeds of 1/4 second or slower, the shutter speed indicator lights in red (☞72).

3 Rotate the command dial to choose a shutter speed value.

- When adjusting the aperture value or shutter speed, the degree of deviation from the exposure value measured by the camera is displayed in the exposure indicator.
- The degree of deviation in the exposure indicator is shown in EVs (-2 to +2 EV in increments of 1/3 EV).
The display on the right shows that the picture will be overexposed by 1 EV (+1).

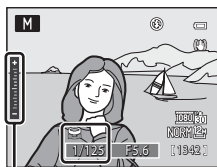

Exposure indicator

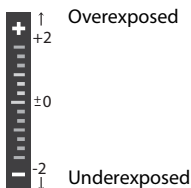

4 Press the multi selector **▶** to activate the aperture value setting.

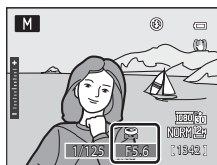

5 Rotate the command dial to choose an aperture value.

- If necessary, repeat steps 2 to 5 to modify shutter speed and aperture value settings until the desired exposure is achieved.

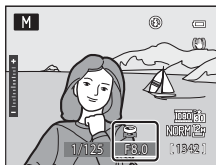

6 Focus and shoot.

- In the default setting, the camera automatically selects one or more of the nine focus areas containing the subject closest to the camera. When the subject is in focus, the focus area (active focus area) lights in green (maximum of nine areas) (📖95).



✔ Note on ISO Sensitivity

When **ISO sensitivity** (📖92) is set to **Auto** (default setting), **High ISO sensitivity auto** or **Fixed range auto**, ISO sensitivity is fixed at ISO 160.

📌 Shutter Speed

The control range of the shutter speed differs depending on the ISO sensitivity setting. Additionally, the range is restricted during continuous shooting (📖107).

Continuous Shooting (P, S, A, M Mode)

Use this mode to capture the details of a moving subject by shooting a continuous series of images.

- This function can be used when the shooting mode is **P, S, A, M** or **U**.



Single (default setting)

One picture is shot each time the shutter-release button is pressed.



Continuous H

While the shutter-release button is pressed all the way, images are captured continuously at a rate of about eight fps (when the Image Quality is **Normal** and the image size is **4000×3000**). Shooting ends when the shutter-release button is released, or five pictures have been taken.



Continuous L

While the shutter-release button is pressed all the way, about 24 pictures are captured continuously at a rate of up to about 1.8 fps. (when the Image Quality is **Normal** and the image size is **4000×3000**).



Pre-shooting cache

Pre-shooting cache makes it easy to capture perfect moments, by saving images from before the shutter-release button was pressed all the way. Pre-shooting cache shooting begins when the shutter-release button is pressed halfway, and continues when the shutter-release button is pressed all the way (79).

- Frame rate: up to 15 fps
- Number of frames: Up to 25 frames (including up to five frames captured in the pre-shooting cache)
- Image size for recording is fixed at (1600 × 1200 pixels).
- Shooting ends when the shutter-release button is released or when the maximum number of frames has been taken.



Continuous H: 120 fps

Each time the shutter-release button is pressed all the way, 50 pictures are captured continuously at a speed of about 1/125 s or faster.

- Image size for recording is fixed at (1280 × 960 pixels).



Continuous H: 60 fps

Each time the shutter-release button is pressed all the way, 25 pictures are captured continuously at a speed of about 1/60 s or faster.

- Image size for recording is fixed at (1600 × 1200 pixels).



BSS (Best Shot Selector)

BSS is recommended for shooting when the lighting is dim without the flash, with the camera zoomed in, or in other situations in which camera shake is likely to blur pictures.

The camera continuously takes up to ten pictures while the shutter-release button is pressed all the way. The sharpest picture (image with the most details) in the series is automatically selected and saved.

**Multi-shot 16**

Each time the shutter-release button is pressed all the way, the camera shoots 16 pictures at a rate of about 30 frames per second and arranges them in a single picture.

- The image quality for recording is fixed at **Normal** and the image size is fixed at (2560 × 1920 pixels).
- The digital zoom is not available.

**Intvl timer shooting**

The camera shoots still pictures automatically at the specified interval (79).

Setting the Continuous Menu

- 1 Press the (continuous shooting mode) button.

- The continuous menu is displayed.

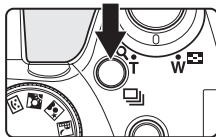

- 2 Use the multi selector to set the continuous menu and press the button.

- The selected continuous shooting mode is displayed.
- When (single) is selected, disappears within a few seconds even if monitor indicators (17) are turned on.

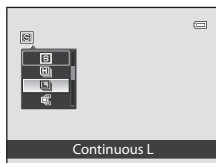

✓ Notes on Continuous

- Flash cannot be used during continuous shooting (except for interval timer shooting). The focus, exposure, and white balance settings are fixed at the values for the first picture in each series.
- It may take some time to save the images after shooting. The amount of time it takes to finish saving the captured images depends on the number of images, image quality, image size, the write speed of the memory card, etc.
- When ISO sensitivity increases, noise may appear in captured images.
- The speed of continuous shooting may decrease depending on the image quality, image size, type of memory card used, and shooting conditions.
- When continuous is set to **Pre-shooting cache, Continuous H: 120 fps, Continuous H: 60 fps** or **Multi-shot 16**, banding or variance in brightness or hue may occur in images that were captured under lighting that flickers at high speeds, such as fluorescent, mercury-vapor, or sodium-vapor lighting.
- When continuous is set to **Pre-shooting cache, Continuous H: 120 fps** or **Continuous H: 60 fps**, accurate exposure may not be achieved (images may be overexposed) in images captured on bright sunny days.
- This feature cannot be used simultaneously with certain functions. See “Functions that Cannot be Applied Simultaneously” (📖104) for more information.

✓ Note on Best Shot Selector

BSS is suited for shooting stationary subjects. **BSS** may not produce the desired results if the subject moves or the composition changes.

📎 Images Captured in Continuous

Each time images are captured using **Continuous H, Continuous L, Pre-shooting cache, Continuous H: 120 fps** or **Continuous H: 60 fps**, the captured images are saved as a “sequence” (📖113).

Pre-shooting Cache

When **Pre-shooting cache** is selected, shooting begins when the shutter-release button is pressed halfway for 0.5 seconds or longer, and images captured before it is pressed all the way are saved along with images captured after it is pressed all the way. Up to five images can be saved in the pre-shooting cache.

The pre-shooting cache setting can be confirmed on the monitor when shooting (8). When the pre-shooting cache is not set, no icon is displayed. The pre-shooting cache icon lights in green while the shutter-release button is pressed halfway.

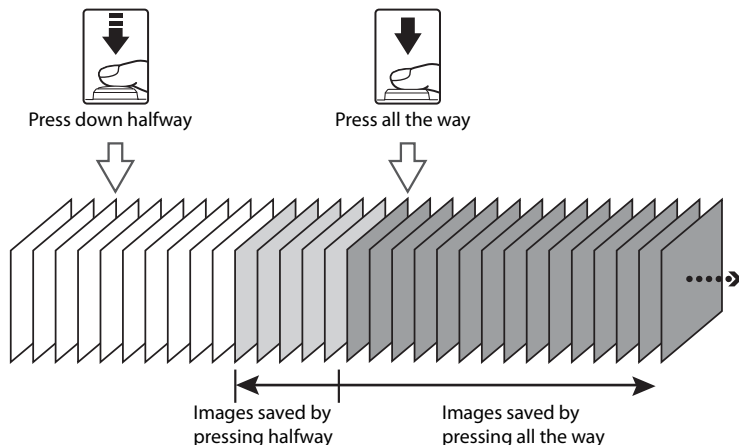



- If the number of exposures remaining is less than five, shooting with the pre-shooting cache is not possible. Before shooting, check that there are five or more exposures remaining.

Interval Timer Shooting

Pictures are shot automatically at the specified intervals.

Choose from **30 s**, **1 min**, **5 min**, or **10 min**.

- 1 Press the  (continuous shooting mode) button to display the continuous menu (76), use the multi selector to select  **Intvl timer shooting**, and then press the **OK** button.

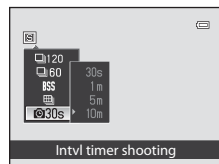

2 Choose the interval between each shot and press the **OK** button.

- The camera returns to shooting screen.
- The maximum amount of frames that can be taken during interval timer shooting differs according to the interval taken between each shot.
 - **30 s**: 600 images
 - **1 min**: 300 images
 - **5 min**: 60 images
 - **10 min**: 30 images

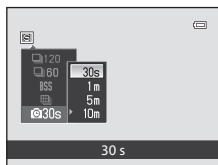

3 Press the shutter-release button all the way to shoot the first picture.

- The monitor is turned off and the power-on lamp blinks between shots.
- The monitor reactivates automatically immediately before the next picture is shot.



4 Press the shutter-release button all the way again to finish shooting.

- Shooting finishes automatically if the internal memory or memory card becomes full, or when the number of shot frames reaches the upper limit.

✓ Notes on Interval Timer Shooting

- To prevent the camera from turning off unexpectedly during shooting, use a fully charged battery.
- To power the camera continuously for extended periods, use the AC Adapter EH-62A (available separately). Do not, under any circumstances, use an AC Adapter other than the EH-62A. Failure to observe this precaution could result in overheating or damage to the camera.
- Do not rotate the mode dial to a different setting while performing interval timer shooting.

🔍 More Information

See "File and Folder Names" (📄215) for more information.

Shooting Options: Shooting Menu (P, S, A, M Modes)

While shooting in **P, S, A, M** and **U** (📖108), the shooting menu contains the following options.

Image quality

📖83

Choose the image quality (compression ratio) of recorded pictures. This can also be set in the menus of another shooting mode.

Image size

📖84

Choose the image size of recorded pictures. This can also be set in the menus of another shooting mode.

Optimize image

📖87

Change the settings for optimizing images according to the shooting scene or your preferences.

White balance

📖90

Match white balance to the light source to produce images with natural-looking colors.

ISO sensitivity

📖92

Set the ISO sensitivity to suit the brightness of the subject.

Metering

📖93

Choose how the camera meters the brightness of the subject.

Exposure bracketing

📖94

Vary exposure slightly over a burst of pictures.

AF area mode

📖95

Choose how the focus area is determined.

Autofocus mode

📖101

Choose how the camera focuses.

Flash exp. comp.

📖101

Adjust the flash level.

Long exposure NR

📖102

Reduce noise in pictures shot at slow shutter speeds.

Active D-Lighting

📖103

Prevent loss of detail in highlights and shadows when shooting images.

Save user settings

📖109

Save the current edited settings into the mode dial **U**.

Reset user settings

📖110

Reset the saved settings in **U** back to the default settings.

Displaying the Shooting Menu

Choose **P** (Programmed auto), **S** (Shutter-priority auto), **A** (Aperture-priority auto), **M** (Manual) or **U** (User settings) by rotating the mode dial.

Press the **MENU** button to display the shooting menu.

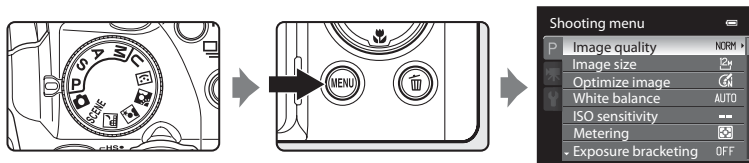

- Press the multi selector to select items and set functions on menus (📖12).
- Press the **MENU** button to exit the shooting menu.

✓ Functions that Cannot be Applied Simultaneously

Some functions cannot be enabled in conjunction with others (📖104).

🔗 Navigating the Camera Menu

The command dial can also be used in place of pressing ▲ or ▼ on the multi selector.

Image Quality

Set to **P, S, A** or **M** → MENU (Shooting menu) → Image quality

Choose the amount of compression applied to pictures.

Higher image quality results in pictures with more detailed depiction, but also larger file sizes, limiting the number of pictures that can be recorded.

FINE Fine

Fine image quality (compression ratio of 1:4), suitable for enlargement or high quality prints.

NORM Normal (default setting)

Normal image quality (compression ratio of 1:8), suitable for most applications.

BASIC Basic

Basic image quality (compression ratio of 1:16), suitable for pictures that will be distributed by e-mail or used in web pages.

The icon for the current setting is displayed on the monitor in shooting and playback modes (📖8 to 10).



Image Quality Setting

- Image quality can also be set in shooting modes other than **P, S, A** or **M** by pressing the **MENU** button.
- The setting is also applied to other shooting modes (except for shooting mode **U**).
- This feature cannot be used simultaneously with certain functions. See "Functions that Cannot be Applied Simultaneously" (📖104) for more information.



More Information

See "Number of Exposures Remaining" (📖85) for more information.

















Image Size

Set to **P**, **S**, **A** or **M** → MENU (Shooting menu) → Image size

Choose the size of pictures in pixels for recording.



The larger the image, the larger the size at which it can be printed or displayed without becoming noticeably “grainy,” limiting the number of pictures that can be recorded.

Conversely, pictures shot at smaller sizes require less memory, making them suited to distribution by e-mail or the web.

Image size	Description
 4000×3000 (default setting)	Record pictures exhibiting greater detail than those shot at  3264×2448 or  2592×1944 .
 3264×2448	Good balance between file size and quality makes this the best choice in most situations.
 2592×1944	
 2048×1536	Smaller than  4000×3000 ,  3264×2448 and  2592×1944 for recording more pictures.
 1600×1200	
 1280×960	
 1024×768	
 640×480	Record pictures suitable for display on a television with a screen aspect ratio of 4:3, or for e-mail attachment.
 3984×2656	Record pictures with the same aspect ratio (3:2) as those shot with 35 mm film cameras.
 3968×2232	Record pictures with the same aspect ratio (16:9) as wide-screen televisions.
 1920×1080	
 2992×2992	Record perfectly square pictures.













The icon for the current setting is displayed on the monitor in shooting and playback modes (□8 to 10).

Image Size Setting

- Image size can also be set in shooting modes other than **P**, **S**, **A** or **M** by pressing the **MENU** button.
- The setting is also applied to other shooting modes (except for shooting mode **U**).
- Image size is fixed at  **1600×1200** for **Pre-shooting cache** or **Continuous H: 60 fps**,  **1280×960** for **Continuous H: 120 fps** (□76).
- This feature cannot be used simultaneously with certain features. See “Functions that Cannot be Applied Simultaneously” (□104) for more information.

Number of Exposures Remaining

The following table lists the approximate number of pictures that can be stored in internal memory and on a 4 GB memory card, at each combination of **Image size** (📐84) and **Image quality** (📐83) settings. Note that the number of exposures that can be stored will differ depending on the composition of the image (due to JPEG compression). In addition, this number may differ depending on the make of memory card, even if the capacity for the memory card is the same.

Image size	Image quality	Internal memory (102 MB)	Memory card ¹ (4 GB)	Print size ² (cm/in.)
 4000×3000 (default setting)	Fine	17	650	34 × 25/13 × 10
	Normal	35	1,280	
	Basic	68	2,510	
 3264×2448	Fine	26	970	28 × 21/11 × 8
	Normal	52	1,910	
	Basic	101	3,650	
 2592×1944	Fine	41	1,520	22 × 16/8.5 × 6.5
	Normal	81	2,940	
	Basic	153	5,480	
 2048×1536	Fine	65	2,410	17 × 13/7 × 5
	Normal	126	4,640	
	Basic	235	8,620	
 1600×1200	Fine	104	3,770	14 × 10/5 × 4
	Normal	199	7,100	
	Basic	346	12,000	
 1280×960	Fine	156	5,740	11 × 8/4 × 3
	Normal	286	10,000	
	Basic	470	17,200	
 1024×768	Fine	235	8,620	9 × 7/3.5 × 2.5
	Normal	411	15,000	
	Basic	658	24,100	
 640×480	Fine	470	17,200	5 × 4/2 × 1.5
	Normal	731	24,100	
	Basic	940	30,100	
 3984×2656	Fine	20	730	34 × 22/13 × 8.5
	Normal	39	1,450	
	Basic	77	2,800	
 3968×2232	Fine	24	880	34 × 19/13 × 7.5
	Normal	47	1,720	
	Basic	91	3,350	
 1920×1080	Fine	98	3,550	16 × 9/6.5 × 3.5
	Normal	182	6,700	
	Basic	329	12,000	
 2992×2992	Fine	23	860	25 × 25/10 × 10
	Normal	46	1,700	
	Basic	91	3,350	

Shooting Options: Shooting Menu (**P**, **S**, **A**, **M** Modes)

- 1 If the number of exposures remaining is 10,000 or more, the number of exposures remaining display shows "9999."
- 2 Print size at an output resolution of 300 dpi.
Print sizes are calculated by dividing the number of pixels by printer resolution (dpi) and multiplying by 2.54 cm (1 in.). However, even with the same image size setting, images printed at higher resolutions will print smaller than the size indicated, and those printed at lower resolutions will print larger than the size indicated.



Note on Printing Images of Size 1:1

Change the printer setting to "Border" when printing images of size set to 1:1.







The images may not be printed in 1:1 ratio depending on the printer.

See the instruction manual of the printer or check with the authorized print dealer for further details.

Optimize Image

Set to **P, S, A** or **M** → MENU (Shooting menu) → Optimize image

Change the settings for optimizing images according to the shooting scene or your preferences. Contrast, saturation, sharpening, and other settings can be adjusted in detail.

	Normal (default setting)
	Standard image optimization; recommended in most situations.
	Softer
	Softens outlines, producing natural results suitable for portraits or retouching on a computer.
	Vivid
	Enhances saturation and produces vibrant reds and greens. Images will become sharp and slightly high in contrast.
	More vivid
	Maximizes saturation, contrast, and sharpness to produce crisp images with sharp outlines.
	Portrait
	Lowers contrast while lending natural texture and rounded feel to skin of portrait subjects.
	Custom
	Customize image optimization settings (📖88).
	Black-and-white
	Shoot photos in black and white or sepia (📖89).

When optimize image is enabled, the current setting is displayed during shooting (📖8). When **Normal** is selected, an icon for the current setting is not displayed.

Notes on Optimize Image

- If the optimize image setting is set to **Normal, Softer, Vivid, More vivid, Portrait** or **Standard** or **Black-and-white**, results will vary with exposure and the position of the subject in the frame even if shooting conditions remain the same. For consistent results over a series of photographs, select **Custom** and choose a setting other than **Auto** for contrast, sharpening, and saturation.
- This feature cannot be used simultaneously with certain features. See “Functions that Cannot be Applied Simultaneously” (📖104) for more information.

Custom in Optimize Image

Select **Custom** to make separate adjustments to the following options.

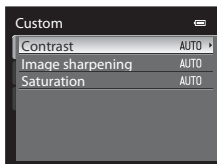

Contrast

Control contrast.

Lower settings prevent loss of detail in highlights under harsh lighting or in direct sunlight. Higher settings preserve detail in misty landscapes and other low-contrast subjects.

The default setting is **Auto**.

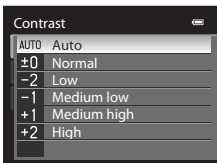
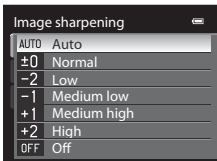

Image sharpening

Choose how much outlines are sharpened during shooting.

Choose high settings for sharp outlines, low settings for softer outlines.

The default setting is **Auto**.



Saturation

Control the vividness of colors.

Choose moderate for less saturated colors, enhanced for more vivid colors.

The default setting is **Auto**.

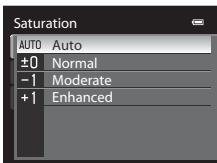

✔ Note on Image Sharpening

The effects of image sharpening cannot be previewed on the monitor during shooting. Check results in playback mode.

Black-and-White in Optimize Image

When **Black-and-white** is selected, the options described below are available.

- Choose **Standard** to shoot in basic black-and-white.
- Choose **Custom** to manually adjust **Contrast**, **Image sharpening**, and **Monochrome filter** effects.
- When the **B&W + color** option is enabled (✓), one black-and-white picture and the same picture in full color are recorded simultaneously.

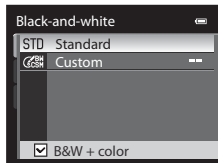

The following options can be adjusted in **Custom**.

Contrast

Same as **Optimize image** → **Custom** → **Contrast** (📖88).

Image sharpening

Same as **Optimize image** → **Custom** → **Image sharpening** (📖88).

Monochrome filter

This effect simulates black-and-white photography with a color filter.

- **Yellow, Orange, Red:**
Enhance contrast. Can be used to tone down the brightness of the sky in landscape photographs. Orange filter results in greater contrast than yellow filter, and red filter greater contrast than orange filter.
- **Green:**
Softens skin tones. Suitable for portraits.
- **Sepia:**
Adds a sepia color tone to make it look like an old picture.

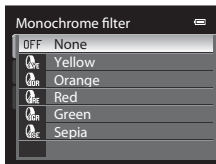

B&W + Color

Color pictures recorded when B&W + color is enabled are the same as those shot at an optimize image setting of **Normal**.

White Balance

Set to **P**, **S**, **A** or **M** → MENU (Shooting menu) → White balance

The color of light reflected from an object varies with the color of the light source. The human brain is able to adapt to changes in the color of the light source, with the result that white objects appear white whether seen in the shade, direct sunlight, or under incandescent lighting. Digital cameras can mimic this adjustment of the human eye by processing images according to the color of the light source. This is known as “white balance.” For natural coloration, choose a white balance setting that matches the light source before shooting.

Although the default setting, **Auto**, can be used under most types of lighting, you can apply the white balance setting suited to a particular light source to achieve more accurate results.

AUTO Auto (default setting)

The white balance is automatically adjusted to suit the lighting conditions. The best choice in most situations.

PRE Preset manual

Use when shooting under unusual lighting. See “Preset Manual” (📖91) for more information.

Daylight*

The white balance is adjusted for direct sunlight.

Incandescent*

Use under incandescent lighting.

Fluorescent (FL1 to FL3)

Use under most types of fluorescent lighting. Choose from **FL1** (white fluorescent), **FL2** (daylight white/neutral fluorescent) and **FL3** (daylight fluorescent).

Cloudy*

Use when shooting under overcast skies.

Flash*

Use with the flash.

* Seven settings for fine-tuning become available. The “+” direction increases the blue hue and the “-” direction increases the red hue.

When white balance is enabled, the current setting is displayed during shooting (📖8). When **Auto** is selected, an icon for the current setting is not displayed.

Notes on White Balance

- At white balance settings other than **Auto** or **Flash**, set the flash to  (Off) (📖36).
- This feature cannot be used simultaneously with certain features. See “Functions that Cannot be Applied Simultaneously” (📖104) for more information.

Preset Manual

Use when you want to make pictures shot under unusual lighting conditions (such as lamps with reddish light) look as though they were shot in normal light.

Use the procedure below to measure the white balance value under the lighting used during shooting.

1 Place a white or gray reference object under the lighting that will be used during shooting.

2 Display the shooting menu (81), use the multi selector to set **White balance to PRE Preset manual**, then press the **OK** button.

- The lens extends to the zoom position for measurement.

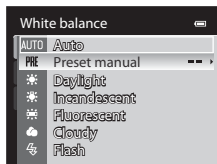

3 Choose **Measure**.

- To apply the most recently measured white balance value, choose **Cancel** and press the **OK** button. The most recently measured white balance value will be set.

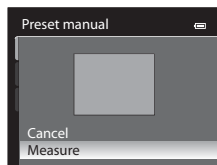

4 Frame a white or gray reference object in the reference object frame.

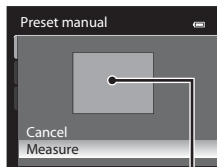

Reference object frame

5 Press the **OK** button to measure the white balance value.

- The shutter is released and the new white balance preset value is set (no picture is recorded).

✓ Note on Preset Manual

The camera cannot measure a white balance value for when the flash fires. When shooting with the flash, set **White balance to Auto or Flash**.

ISO Sensitivity

Set to **P**, **S**, **A** or **M** → MENU (Shooting menu) → ISO sensitivity

When ISO sensitivity is increased, less light is needed when taking pictures. Higher ISO sensitivity allows darker subjects to be captured. Additionally, even with subjects of similar brightness, pictures can be taken at faster shutter speeds, and blurring caused by camera shake and subject movement can be reduced.

- Although higher ISO sensitivity is effective when shooting darker subjects, shooting without the flash, shooting with the camera zoomed in, etc., images may contain noise.



ISO sensitivity

- **Auto** (default setting): Sensitivity is ISO 160 when there is sufficient lighting; the camera compensates by raising sensitivity to a maximum of ISO 800 when lighting is dim.
- **High ISO sensitivity auto**: The ISO sensitivity is set automatically within the range of ISO 160 to 1600 according to the brightness of the subject.
- **Fixed range auto**: Choose the range in which the camera automatically adjusts ISO sensitivity, from **ISO 160-200** (default setting) or **ISO 160-400**. The camera will not raise sensitivity beyond the maximum value in the selected range. Set the maximum value for ISO sensitivity for effective control over the amount of “grain” that appears in images.
- **160, 200, 400, 800, 1600, 3200**: ISO sensitivity will be locked at the specified value.

Minimum shutter speed

When the shooting mode is **P** or **A** and **ISO sensitivity** is set to **Auto**, **High ISO sensitivity auto**, or **Fixed range auto**, the shutter speed at which the ISO sensitivity automatic control starts to function (1/125 to one second) is set. The default setting is **None**. If the exposure is insufficient with the shutter speed that is set here, the ISO sensitivity is increased automatically to obtain the correct exposure. If the exposure is still insufficient even after the ISO sensitivity is increased, the shutter speed slows down.

When ISO sensitivity is enabled, the current setting is displayed during shooting (☐8).

- When **Auto** is selected, the  icon is not displayed at ISO 160, but is displayed if the ISO sensitivity automatically increases to more than 160 (☐38).
-  is displayed when **High ISO sensitivity auto** is selected, and  and the maximum ISO sensitivity value are displayed when **Fixed range auto** is selected.

Notes on ISO Sensitivity

- In **M** (manual) mode, ISO sensitivity will be fixed at ISO 160 if **Auto**, **High ISO sensitivity auto** or **Fixed range auto** is selected.
- This feature cannot be used simultaneously with certain features. See “Functions that Cannot be Applied Simultaneously” (☐104) for more information.

Metering

Set to **P, S, A** or **M** → MENU (Shooting menu) → Metering

The process of measuring the brightness of the subject to determine the exposure is known as “metering.”

Use this option to choose how the camera meters exposure.



Matrix (default setting)

Uses a wide area of the screen for metering. This metering mode provides the appropriate exposure for a variety of shooting conditions. Recommended for typical shooting.



Center-weighted

The camera meters the entire frame but assigns greatest weight to the subject at the center of the frame. This mode is suitable for portraits or other scenes to determine the exposure by lighting conditions at the center of the frame. Can be used with focus lock (📖33) to meter off-center subjects.



Spot

The camera meters the area shown by the circle at the center of the frame. This mode is recommended when the metering target is much brighter or darker than the background. Ensure that the subject is within the area shown by the circle when shooting. Can be used with focus lock (📖33) to meter off-center subjects.



Spot AF area

The camera meters the selected focus area to determine the exposure. Available only when **Manual** or **Auto** is selected for **AF area mode** (📖95).

✓ Notes on Metering

- When the digital zoom is in effect, at magnifications of 1.2x to 1.8x, **Metering** is set to **Center-weighted**, and at magnifications of 2.0x to 4.0x, it is set to **Spot**. Note that when the digital zoom is in effect, the metered area is not displayed on the monitor.
- This feature cannot be used simultaneously with certain features. See “Functions that Cannot be Applied Simultaneously” (📖104) for more information.



Metering Area

The active metering area is displayed when **Center-weighted** or **Spot** is selected for **Metering** (📖8).

Exposure Bracketing

Set to **P**, **S** or **A** → MENU (Shooting menu) → Exposure bracketing

Continuous shooting can be performed while changing the exposure (brightness) automatically. This is effective when adjusting the brightness of an image is difficult.

±0.3

Camera varies exposure by 0 EV, -0.3 EV, and +0.3 EV over next three shots. The three shots are taken in sequence when the shutter-release button is pressed all the way.

±0.7

Camera varies exposure by 0 EV, -0.7 EV, and +0.7 EV over next three shots. The three shots are taken in sequence when the shutter-release button is pressed all the way.

±1.0

Camera varies exposure by 0 EV, -1.0 EV, and +1.0 EV over next three shots. The three shots are taken in sequence when the shutter-release button is pressed all the way.

Off (default setting)

Exposure Bracketing is not performed.

When exposure bracketing is enabled, the current setting is displayed during shooting (📖8). When **Off** is selected, an icon for the current setting is not displayed.

✔ Notes on Exposure Bracketing

- **Exposure bracketing** is not available in **M** (manual) mode.
- When exposure compensation (📖43) and **±0.3**, **±0.7** or **±1.0** in **Exposure bracketing** are set simultaneously, the combined exposure compensation values are applied.
- This feature cannot be used simultaneously with certain features. See “Functions that Cannot be Applied Simultaneously” (📖104) for more information.

📖 More Information

See “Playing Images Captured Using Continuous Shooting Mode (Sequence)” (📖113) for more information.

AF Area Mode

Set to **P, S, A** or **M** → MENU (Shooting menu) → AF area mode

You can set how the camera selects the focus area for autofocus.

Face priority

The camera automatically detects and focuses on a face (see "Shooting with Face Priority" (197) for more information).

If the camera detects multiple faces, the camera focuses on the face closest to the camera.

When non-human subjects are photographed, or a subject with which no face can be detected is framed, AF area mode is set to **Auto**. The camera automatically selects one or more of the nine focus areas containing the subject closest to the camera.

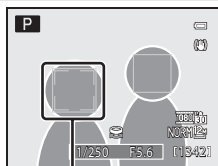

Focus area

AUTO Auto (default setting)

The camera automatically selects one or more of the nine focus areas containing the subject closest to the camera.

Press the shutter-release button halfway to activate the focus area.

When the shutter-release button is pressed halfway, the focus area selected by the camera is displayed on the monitor (up to nine areas).

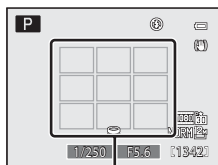

Focus areas

Manual

Choose manually the focus position from 99 areas in the screen. This option is suited to situations in which the intended subject is relatively still and not positioned at the center of the frame.

Press the multi selector ▲, ▼, ◀ or ▶ to move the focus area to where the subject is, and take a picture.

- To adjust the following settings, press the  button to temporarily cancel focus area selection, and then adjust each setting.
 - Flash mode, focus mode or self-timer
 - Exposure compensation

To return to the focus-area selection screen, press the  button again.

- At an **Image size** setting (184) of  **2992x2992**, 81 focus areas are available.

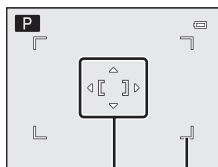

Focus area
Selectable areas

Center

The camera focuses on the subject at the center of the frame. The focus area is always displayed at the center of the frame.

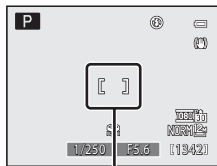

Focus area

Subject tracking

Subject tracking begins once you select a subject to be focused on, and the focus area will move and follow the subject. See "Focusing on Moving Subjects for Shooting (Subject Tracking)" (199).

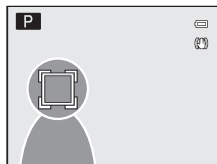

Notes on AF Area Mode

- When the digital zoom is in effect, the camera focuses on the subject in the center focus area regardless of the applied **AF area mode** option.
- In some rare cases of shooting subjects for which autofocus does not perform as expected (133), the subject may not be in focus.
- This feature cannot be used simultaneously with certain features. See "Functions that Cannot be Applied Simultaneously" (104) for more information.

Shooting with Face Priority

The camera automatically detects and focuses on a human face.

The face detection function operates in the following situations.

- When **Face priority** is selected for **AF area mode** (📖95)
- When 📷 (Night portrait) (📖49), **Scene auto selector** (📖46) or **Portrait** (📖51) is selected in scene mode
- When smart portrait mode is selected (📖65)

1 Frame the picture.

- When the camera detects a face, the focus area containing the face is displayed with a double yellow border.
- When the camera detects more than one face, depending upon the shooting mode, the operation varies as follows.

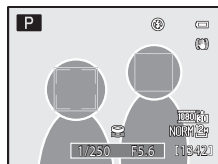

Shooting mode	Faces framed by a double border	Number of faces to be recognized
P, S, A, M, U modes (Face priority)	The face closest to the camera * The other faces are framed by a single border.	Up to 12
📷 (Night portrait), Scene auto selector or Portrait scene modes		
Smart portrait mode	The face closest to the center of the frame * The other faces are framed by a single border.	Up to 3

2 Press the shutter-release button halfway.

- The camera focuses on the face framed by the double border. The double border lights in green and the focus is locked.
- When the camera is unable to focus on a face, the double border blinks. Press the shutter-release button halfway again and focus.
- Press the shutter-release button all the way to shoot.
- When using **Smile timer** in smart portrait mode, even if the shutter-release button is not pressed, the shutter is released automatically if the camera detects that the face framed by the double border is smiling (📖67).

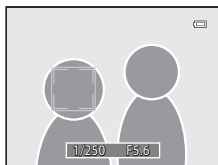
**✓** Notes on Face Priority

- When **Face priority** is selected for **AF area mode**, the setting automatically switches to **Auto** if no faces are detected when the shutter-release button is pressed halfway.
- If no faces are detected when the shutter-release button is pressed halfway in the 🌃 (Night portrait) or **Portrait** scene mode, or smart portrait mode, the camera focuses on the subject in the center focus area.
- The camera may not detect faces in the following situations:
 - When faces are partially hidden by sunglasses or other obstructions
 - When faces take up too much or too little of the frame
- If the camera detects more than one face, the face that it focuses on depends on the shooting conditions, such as whether or not the subject is facing the camera.
- In some rare cases of shooting subjects for which autofocus does not perform as expected (📖33), the subject may not be in focus despite the fact that the double border lights in green. If you cannot focus, change the AF area mode setting to **Manual** or **Center**, or try shooting with focus lock (📖33) by switching the shooting mode to a mode such as auto mode and refocusing on another subject at the same distance.
- Pictures that were shot using face priority will be rotated automatically when displayed in full-frame or thumbnail playback mode according to the orientation of the face (except for pictures shot while continuous (📖76) or **Exposure bracketing** (📖94) was set).

Focusing on Moving Subjects for Shooting (Subject Tracking)

Subject tracking begins once you select a subject to be focused on, and the focus area will move and follow the subject.

- 1 Display the shooting menu (82), use the multi selector to choose **AF area mode**, and press the **OK** button.

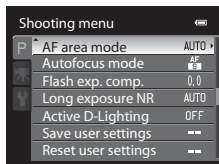

- 2 Choose **Subject tracking** and press the **OK** button.

- The camera enters subject tracking, and a white border is displayed at the center of the frame.

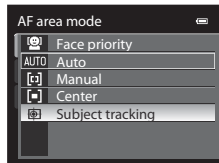

- 3 Select a subject.

- Framing the subject in the center of the border, and press the **OK** button.
 - The subject is registered.
 - When the camera is unable to focus on the subject, the border lights in red. Change the composition and try again.
- Once the subject is registered, it is framed by a yellow focus area display, and subject tracking begins.
- To change subjects, press the **OK** button to cancel the currently selected subject, then select a new subject.
- If the camera loses sight of the subject, the focus area display disappears; register the subject again.

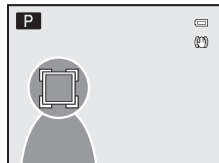
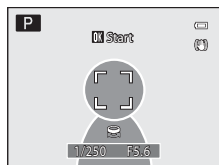

4 Press the shutter-release button to take the picture.

- If the camera focuses on the focus area when the shutter-release button is pressed halfway, the focus area display lights in green and the focus is locked.
- If the camera is unable to focus, the focus area display will blink. Press the shutter-release button halfway again to focus.
- If the shutter-release button is pressed halfway while the focus area is not displayed, the camera focuses at the center of the frame.
- Press the shutter-release button the rest of the way down to take the picture.

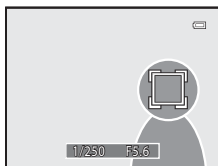

✓ Notes on Subject Tracking

- The digital zoom is not available.
- Set the zoom position, flash mode, focus mode, or menu before registering a subject. If any of these are changed after a subject is registered, the subject will be canceled.
- During certain conditions, such as when the subject is moving quickly, when there is a large amount of camera shake, or when there are multiple subjects that look alike, the camera may not be able to register or track a subject, or the camera may track a different subject. Additionally, the subject may not be tracked properly depending on factors such as the subject's size and brightness.
- In some rare cases of shooting subjects for which autofocus does not perform as expected (📖33), the subject may not be in focus despite the fact that the focus area lights in green. If you cannot focus, change the AF area mode setting to **Manual** or **Center**, or try shooting with focus lock (📖33) by switching the shooting mode to a mode such as auto mode and refocusing on another subject at the same distance.
- This feature cannot be used simultaneously with certain features. See "Functions that Cannot be Applied Simultaneously" (📖104) for more information.

Autofocus Mode

Set to **P, S, A** or **M** → MENU (Shooting menu) → Autofocus mode

Choose how the camera focuses.

 Single AF (default setting)

The camera focuses only when the shutter-release button is pressed halfway.

 Full-time AF

The camera focuses continuously until the shutter-release button is pressed down halfway. Use with moving subjects. A sound will be heard while the camera focuses.

Note on Autofocus Mode

This feature cannot be used simultaneously with certain features. See “Functions that Cannot be Applied Simultaneously” (📖104) for more information.

Autofocus Mode for Movie Recording

Autofocus mode for movie recording can be set with **Autofocus mode** (📖166) in the movie menu (📖163).

Flash Exp. Comp.

Set to **P, S, A** or **M** → MENU (Shooting menu) → Flash exp. comp.

Flash compensation is used to adjust the flash output by ± 2.0 EV in increments of $1/3$ EV, changing the brightness of the main subject relative to the background.

-0.3 to -2.0

The flash output is reduced from -0.3 to -2.0 EV, in increments of $1/3$ EV, to prevent unnecessary highlights or reflections.

0.0 (default setting)

The flash output is not adjusted.

+0.3 to +2.0

The flash output is increased from $+0.3$ to $+2.0$ EV, in increments of $1/3$ EV, to make the main subject of the frame appear brighter.

When flash compensation is enabled, the current setting is displayed during shooting (📖8). When **0.0** is selected, an icon for the current setting is not displayed.

Long Exposure NR

Set to **P**, **S**, **A** or **M** → MENU (Shooting menu) → Long exposure NR

When shooting in dark locations at slow shutter speeds, pictures may be affected by noise. Set to reduce this noise. Enabling long exposure NR increases the time needed to record pictures after they are shot.

AUTO Auto (default setting)

Noise reduction is performed at slow shutter speeds that are likely to result in pictures affected by noise.

On

Noise reduction is applied to pictures shot at shutter speeds of 1/4 second or slower. Switching this to **On** is recommended when shooting at slow shutter speeds.

When long exposure NR is performed, the  icon is displayed on the monitor during shooting (📖8).



Note on Long Exposure NR

This feature cannot be used simultaneously with certain features. See “Functions that Cannot be Applied Simultaneously” (📖104) for more information.

Active D-Lighting

Set to **P**, **S**, **A** or **M** → MENU (Shooting menu) → Active D-Lighting

Set “Active D-Lighting” before shooting to preserve details in highlights and shadows. The image taken reproduces the contrast effect that is seen with the naked eye. This is particularly effective for shooting scenes with high contrast, such as brightly lit outdoor scenery from a dark room or shaded subjects at a sunny seaside.

 High,  Normal,  Low

Set the level of the Active D-Lighting effect that is applied during shooting.

OFF Off (default setting)

Active D-Lighting is not applied.

When Active D-Lighting is enabled, the current setting is displayed during shooting (8). When **Off** is selected, an icon for the current setting is not displayed.

Notes on Active D-Lighting

- Additional time is required to record pictures when shooting using Active D-Lighting.
- The exposure is reduced in comparison to shooting with Active D-Lighting set to **Off**. To ensure that the gradation is appropriate, adjustments of the highlighted areas, shadow areas and mid-tones are made before recording.
- This feature cannot be used simultaneously with certain features. See “Functions that Cannot be Applied Simultaneously” (104) for more information.

Active D-Lighting Versus D-Lighting

The **Active D-Lighting** option in the shooting menu reduces exposure before shooting to optimize the dynamic range. The **D-Lighting** (149) option in the playback menu optimizes dynamic range in pictures after shooting.







Functions that Cannot be Applied Simultaneously

Some settings in the flash mode, the focus mode, the self-timer and the shooting menu cannot be used with other functions.

Restricted function	Setting	Description
Flash mode	Focus mode (40)	When (infinity) is selected for shooting, the flash is not available.
	Continuous (76)	When Continuous H, Continuous L, Pre-shooting cache, Continuous H: 120 fps, Continuous H: 60 fps, BSS or Multi-shot 16 is selected for shooting, the flash is not available.
	Exposure bracketing (94)	The flash is not available.
Self-timer	AF area mode (95)	When Subject tracking is selected for shooting, the Self-timer is not available.
Focus mode	AF area mode (95)	When Subject tracking is selected for shooting, MF (manual focus) is not available.
Image quality	Continuous (76)	When Multi-shot 16 is selected for shooting, Image quality is fixed at Normal .
Image size	Continuous (76)	<ul style="list-style-type: none"> Image size is fixed at (2560×1920 pixels) when Multi-shot 16 is selected for shooting. Image size is fixed at (1600×1200 pixels) when Pre-shooting cache or Continuous H: 60 fps is selected for shooting. Image size is fixed at (1280×960 pixels) when Continuous H: 120 fps is selected for shooting.
Optimize image	Active D-Lighting (103)	When Active D-Lighting is used for shooting, the Contrast setting for Custom or for Custom in Black-and-white will be fixed at Auto under the Optimize image options.
White balance	Optimize image (87)	When Black-and-white is selected for Optimize image , White balance will be fixed at Auto .
ISO sensitivity	Continuous (76)	<ul style="list-style-type: none"> When shooting in Pre-shooting cache, Continuous H: 120 fps, Continuous H: 60 fps or Multi-shot 16, ISO sensitivity is set automatically according to the brightness when shooting mode P, S or A is used. The setting for ISO sensitivity is fixed at 160 for shooting mode M. When shooting with Continuous L, 3200 cannot be selected. If Continuous L is selected when ISO sensitivity is set to 3200, sensitivity changes to 1600.

Restricted function	Setting	Description
Metering	AF area mode (📖95)	When AF area mode is set to Center , while Metering is set to Spot AF area , the Metering setting automatically changes to Matrix .
	Active D-Lighting (📖103)	Metering is reset to Matrix when Active D-Lighting is set to any mode other than Off .
Continuous/ Exposure bracketing	Continuous (📖76)/Exposure bracketing (📖94)	Continuous and Exposure bracketing are not available simultaneously. Exposure bracketing is reset to Off when continuous is set to any mode other than Single . The setting for continuous is reset to Single when Exposure bracketing is set to any mode other than Off .
	Self-timer (📖39)	Continuous and the Self-timer are not available simultaneously.
	Optimize image (📖87)	When Black-and-white is selected and B&W + color is enabled in Optimize image , then Continuous H , Continuous L , Pre-shooting cache , Continuous H: 120 fps , Continuous H: 60 fps , BSS , Multi-shot 16 and Exposure bracketing are not available. When the B&W + color check box is selected, the setting for continuous is reset to Single and Exposure bracketing is reset to Off . To perform simultaneous recording of black-and-white and color with Intvl timer shooting , first select B&W + color , and then select the Intvl timer shooting setting.
	Long exposure NR (📖102)	When On is selected for Long exposure NR , Continuous H , Pre-shooting cache , Continuous H: 120 fps , Continuous H: 60 fps and Multi-shot 16 are not available.
AF area mode	Focus mode (📖40)	<ul style="list-style-type: none"> When a setting other than Subject tracking is selected and ▲ (infinity) is selected as the focus mode for shooting, the camera focuses at infinity regardless of the applied AF area mode option. When set to MF (manual focus), AF area mode cannot be set.
	Metering (📖93)	When Metering is set to Spot AF area or Spot , Subject tracking is not available.
Autofocus mode	Focus mode (📖40)	When the focus mode is set to MF (manual focus), Autofocus mode cannot be set.
Long exposure NR	Continuous (📖76)	When Multi-shot 16 is selected for shooting, the Long exposure NR is not available.
Active D-Lighting	ISO sensitivity (📖92)	When ISO sensitivity is set to High ISO sensitivity auto or 3200 , Active D-Lighting is not available. When High ISO sensitivity auto or 3200 is selected, Active D-Lighting is reset to Off .

Shooting Options: Shooting Menu (**P**, **S**, **A**, **M** Modes)

Restricted function	Setting	Description
Print date	Continuous ( 76)	When Continuous H , Continuous L , Pre-shooting cache , Continuous H: 120 fps , Continuous H: 60 fps or BSS is selected for shooting, print date is not available.
	Exposure bracketing ( 94)	Print date is not available.
Blink warning	Continuous ( 76)/Exposure bracketing ( 94)	Blink warning does not take effect when the continuous is set to a setting other than Single , or Exposure bracketing is set.
Digital zoom	Focus mode ( 40)	The digital zoom cannot be used when MF (manual focus) is selected.
	AF area mode ( 95)	The digital zoom cannot be used when shooting with Subject tracking .
	Continuous ( 76)	The digital zoom cannot be used when Multi-shot 16 is selected for shooting.



More Information

See "Notes on Digital Zoom" (197) for more information.

Shutter Speed

The control range of the shutter speed differs depending on the ISO sensitivity setting. Additionally, the control range changes in the following continuous shooting settings.

Setting	Control range	
ISO sensitivity (📖92) ¹	Auto ² , ISO 160-400 ² in Fixed range auto	1/1500 to 2 s (P, S mode) 1/1500 to 4 s (A mode) 1/1500 to 8 s (M mode)
	High ISO sensitivity auto ²	1/1500 to 2 s (P, S, A mode) 1/1500 to 8 s (M mode)
	ISO 160-200 ² in Fixed range auto ISO 160, 200	1/1500 to 2 s (P, S mode) 1/1500 to 8 s (A, M mode)
	ISO 400, 800	1/1500 to 2 s (P, S mode) 1/1500 to 4 s (A, M mode)
	ISO 1600	1/1500 to 2 s
	ISO 3200	1/1500 to 1/2 s
Continuous (📖76)	Pre-shooting cache	1/4000 to 1/60 s
	Continuous H: 120 fps	1/4000 to 1/125 s
	Continuous H: 60 fps	1/4000 to 1/60 s
	Multi-shot 16	1/4000 to 1/30 s

1 The ISO sensitivity setting is restricted depending on the continuous shooting setting (📖104).

2 In **M** mode, the ISO sensitivity is fixed at 160.

Using U (User Setting Mode)

Setting combinations frequently used in shooting (user setting) can be saved in **U**. The saved settings can be immediately retrieved for shooting simply by rotating the mode dial to **U**. This is convenient when you want to shoot with these settings or you only want to change the settings slightly. Shooting is possible in **P** (Programmed auto), **S** (Shutter-priority auto), **A** (Aperture-priority auto), and **M** (Manual). The following settings can be saved in **U**.

Basic Settings

Shooting modes P, S, A, M (☞69) ¹	Monitor display (☞16, 17) ²	Zoom position (☞31) ²
Flash mode (☞36)	Focus mode (☞40) ³	Exposure compensation (☞43)
Continuous (☞76)		

Shooting Menu

Image quality (☞83)	Image size (☞84)	Optimize image (☞87)
White balance (☞90) ⁴	ISO sensitivity (☞92)	Metering (☞93)
Exposure bracketing (☞94)	AF area mode (☞95) ⁵	Autofocus mode (☞101)
Flash exp. comp. (☞101)	Long exposure NR (☞102)	Active D-Lighting (☞103)

- 1 Choose the standard shooting mode. The current flexible program (when set to **P**), shutter speed (when set to **S** and **M**) or aperture (when set to **A** and **M**) settings will also be saved.
- 2 The current monitor display setting and zoom position will also be saved.
- 3 The current focus distance will also be saved when set to **MF** (manual focus).
- 4 The preset value for preset manual applies to the **P, S, A, M** and **U** shooting modes.
- 5 The current focus area position is saved when **AF area mode** is set to **Manual**.

Note on Clock Battery

If the internal clock battery (☞189) is exhausted, the settings saved in **U** will be reset. Writing down any important setting is recommended.

Save the Settings in **U**

The frequently used settings for shooting can be changed and saved in **U**.

1 Rotate the mode dial to the desired exposure mode.

- Rotate to **P**, **S**, **A** or **M**.
- Settings can be saved even if rotated to **U** (the default settings of shooting mode **P** are saved when the camera is first purchased).



2 Change to a frequently used setting.

3 Press the MENU button.

- The shooting menu is displayed.
- Press the multi selector to select items and set functions on the menu (📖12).

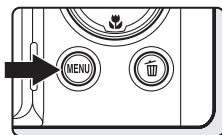

4 Use the multi selector to choose **Save user settings** and press the **OK** button.

- **Done** screen is displayed, and the current settings are saved.

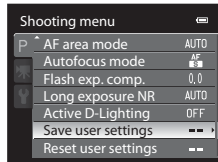

Shooting in **U** (User Setting) Mode

Rotate the mode dial to **U** to retrieve the settings saved in **Save user settings**.

- Frame the subject and shoot with these settings, or change the settings as required.
- The setting combinations that are retrieved when the mode dial is rotated to **U** can be changed as many times as you want in **Save user settings**.

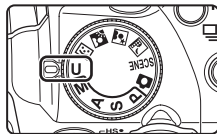

Resetting Saved Settings

The settings that are saved for **U** can be reset.

- 1 In the shooting menu, choose **Reset user settings** and press the **OK** button.

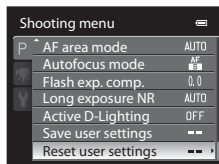

- 2 Choose **Yes** and press the **OK** button.

- The saved settings are reset.

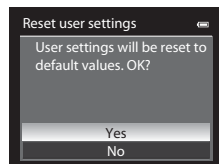



Resetting for U









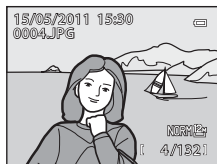







The settings that are saved in the user settings are reset as follows:











- Shooting mode: **P** (programmed auto)
- Monitor display: Display information
- Zoom position: maximum wide-angle position
- Flash mode: **AUTO** (Auto)
- Focus mode: **AF** (Autofocus)
- Exposure compensation: 0.0
- Continuous: Single
- Shooting menu: Same as the default setting for each item



Operations in Full-Frame Playback

In shooting mode, press the  (playback) button to enter playback mode and play back the pictures that have been shot ( 34). The following operations can be performed in full-frame playback mode.



Function	Use	Description	
Choose pictures		Press  ,  ,  or  to choose a picture to display. Press and hold  ,  ,  or  to scroll quickly through pictures. Pictures can also be chosen by rotating the command dial.	11, 12
Thumbnail display/ Calendar display	W 	Display pictures by 4, 9, 16 or 72 picture thumbnails. Rotate the zoom control toward W () in the 72-picture thumbnail display to change to the calendar display (except for list by date mode).	115, 117
Playback zoom	T 	Enlarge the view of the picture currently displayed on the monitor, up to about 10x. Press the  button to return to the full-frame playback mode.	118
Hide or show shooting information	DISP	Hide or show the shooting information and photo information on the monitor.	17
Switch between displays		Switch between the monitor and viewfinder display.	16
Display individual pictures of a sequence		If pressed when displaying a sequence that is displayed by its key picture only, all pictures in the sequence are displayed as individual pictures. To return to key picture only display, press the multi selector  .	113
Scroll a picture recorded with easy panorama		Display the short side of the current picture filling the entire screen and scroll the picture automatically.	62
Play back movies		Play back the displayed movies.	168

Function	Use	Description	
Delete pictures		Select the deletion method and delete the picture(s). When using favorite pictures mode ( 122), auto sort mode ( 129), or list by date mode ( 132), pictures in the same album, category, or shooting date can be deleted.	35, 114
Display menus	MENU	Display the menu for the selected mode.	13
Switch to another playback mode		Display the menu and select the MODE (playback mode) tab to switch to favorite pictures mode, auto sort mode, or list by date mode.	120
Switch to shooting screen		Press the  button or the shutter-release button. You can also switch to shooting by pressing the  (movie-record) button.	34, 157
			
			

 **Changing the Orientation (Vertical and Horizontal Positioning) of Pictures**
Change the orientation using **Rotate image** (141) in the playback menu (135) after shooting.

Playing Images Captured Using Continuous Shooting Mode (Sequence)

The images shot in the following continuous shooting mode are saved as a group (called a “sequence”) each time you shoot.

- **Continuous H, Continuous L, Pre-shooting cache, Continuous H: 120 fps** or **Continuous H: 60 fps** in the continuous shooting menu (📖76)
- **Exposure bracketing** (📖94) in the shooting menu (📖81)
- **Continuous** in the **Sports** (📖52) or **Pet portrait** (📖59) scene mode

In full-frame playback mode or thumbnail playback mode (📖115), the first image of a sequence is used as the “key picture”, i.e., it is displayed to represent the images in the sequence.

- 📖 is displayed on the playback screen for images captured in a sequence.

While the key picture of a sequence is displayed in full-frame playback mode, press the **OK** button to display each image in the sequence individually. To return to key picture only display, press the multi selector **▲**.

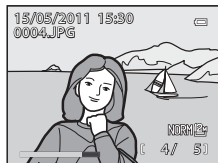

The following operations are available when each image in a sequence is displayed individually.

- Choose an image: Press the multi selector **◀** or **▶**. Images can also be chosen by rotating the command dial.
- Zoom in: Rotate the zoom control toward **T** (📖) (📖118).

Sequence Display Options

Select **Sequence display options** (📖145) in the playback menu to set all sequences to be displayed using their key pictures or to display them as individual images.

Changing Key Picture in Sequence

A sequence’s key picture can be changed using **Choose key picture** (📖145) in the playback menu.

Deleting Images in a Sequence

When **Sequence display options** (📖145) is set to **Key picture only** in the playback menu, if the 🗑️ button is pressed and the deletion method is selected, the following images are deleted.

- When a sequence is displayed by its key picture only:
 - **Current image:** When the sequence is selected, all images in the sequence are deleted.
 - **Erase selected images:** When the key picture is selected in the erase selected images screen (📖35), all images in the sequence are deleted.
 - **All images:** All images including the sequence that is displayed are deleted.
- When the pictures in a sequence are displayed individually by pressing the OK button while the key picture is displayed before pressing the 🗑️ button:

The deletion methods change to the following.

 - **Erase current picture:** Delete the image that is displayed.
 - **Erase selected images:** Select multiple images in the sequence to delete in the erase selected images screen (📖35).
 - **Erase entire sequence:** All images in the sequence, including the image that is displayed, are deleted.

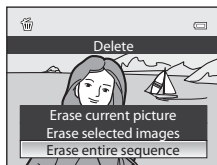

✔ Note on Sequence

Images captured continuously with cameras other than COOLPIX P500 cannot be displayed as a sequence.

📌 Playback Menu Options Available When Using Sequence

When the MENU button is pressed during key picture playback, the following menu operations are available for the images in that sequence.

- | | | | |
|-------------------------------|--------|----------------------------------|--------|
| • Quick retouch ¹ | → 📖148 | • D-Lighting ¹ | → 📖149 |
| • Skin softening ¹ | → 📖150 | • Filter effects ¹ | → 📖152 |
| • Print order ² | → 📖135 | • Slide show | → 📖138 |
| • Protect ² | → 📖139 | • Rotate image ¹ | → 📖141 |
| • Hide image ² | → 📖141 | • Small picture ¹ | → 📖154 |
| • Voice memo ¹ | → 📖142 | • Copy ² | → 📖144 |
| • Black border ¹ | → 📖155 | • Sequence display options | → 📖145 |
| • Choose key picture | → 📖145 | • Favorite pictures ² | → 📖122 |

¹ Press the MENU button after displaying individual images. Settings can be applied to individual images.

² When the MENU button is pressed during key picture playback, the same settings can be applied to all images in that sequence. Press the MENU button after displaying individual images to apply settings to individual images.







Viewing Multiple Pictures: Thumbnail Playback

Rotate the zoom control toward **W** (📐) in full-frame playback mode (📖34, 111) to display pictures as thumbnail images in thumbnail playback mode.







The following operations can be performed in thumbnail playback mode.

To	Use	Description	
Choose pictures		Press the multi selector ▲, ▼, ◀ or ▶. Pictures can also be chosen by rotating the command dial.	11, 12
Increase the number of thumbnails displayed/Calendar display	W (📐)	Rotate the zoom control toward W (📐) direction to increase the number of thumbnails from 4 → 9 → 16 → 72. Rotate the zoom control toward W (📐) in the 72-picture thumbnail display to change to the calendar display (except for list by date mode). In calendar display, the pictures can be selected according to date by moving the cursor (📖117). Rotate toward T (🕒) direction to return to thumbnail display.	
Decrease the number of picture thumbnails displayed	T (🕒)	Rotate the zoom control toward T (🕒) direction to decrease the number of thumbnails from 72 → 16 → 9 → 4. Rotate toward T (🕒) again during 4 thumbnails display to return to full-frame playback.	
Return to full-frame playback	OK	Press the OK button.	34, 111
Delete pictures		Select the deletion method and delete the picture(s). When using favorite pictures mode (📖122), auto sort mode (📖129) or list by date mode (📖132), pictures in the same album or category can be deleted.	35



To	Use	Description	
Switch to the shooting screen		Press the  button or the shutter-release button. You can also switch to shooting by pressing the  (movie-record) button.	34, 157
			
			

Icons on the Thumbnails

When pictures with **Print order** () 135) and **Protect** () 139) settings are selected, the icons shown on the right are displayed.

The icon shown on the right is displayed when a picture in a sequence () 113) is selected. The icon shown on the right is displayed when a picture in a sequence () 113) is selected. Movies are displayed as film frames (In the 72-picture thumbnail display,  is displayed at the top of the monitor when a movie is selected).

Thumbnail Display in Favorite Pictures Mode and Auto Sort Mode

- In favorite pictures mode () 122), the icon of the album being played back is displayed at the top right of the monitor.
- In auto sort mode () 129), the current picture's category icon is displayed at the top right of the monitor.

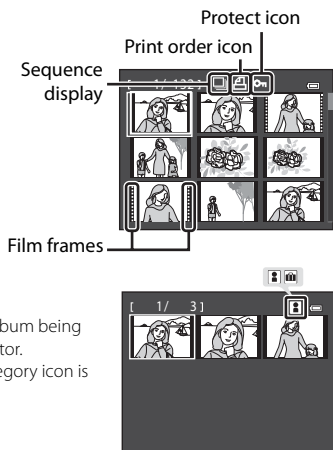



Calendar Display

Rotate the zoom control toward **W** (📷) during playback mode when 72 thumbnails are displayed (📖115) to change to calendar display (except for list by date mode).

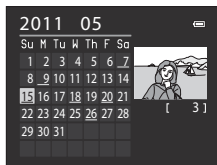
Move the cursor and choose pictures by selecting a date. Dates for which pictures exist are underlined in yellow.



The following operations can be performed in calendar display mode.

To	Use	Description	📖
Select date		Press the multi selector ▲, ▼, ◀ or ▶. A date can also be selected by rotating the command dial.	11, 12
Return to full-frame playback		Change to full-frame playback for displaying the first picture for that date.	34, 111
Return to picture list display	T (📷)	Rotate the zoom control toward T (📷).	-

👍 Notes on Calendar display

- Pictures taken without the date set are treated as pictures taken on “January 1, 2011.”
- **MENU** and 🗑️ buttons are disabled while the Calendar is displayed.

👁️ List by Date Mode

Only the pictures taken on the same date can be played back in list by date mode (📖132). The list by date options (📖133) are also available only for the pictures taken on the selected dates.

Taking a Closer Look: Playback Zoom

Rotate the zoom control toward **T** (Q) in full-frame playback mode (📖34) to zoom in on the current picture, enlarging and displaying the center of the picture.

- The guide at lower right shows which portion is enlarged.

The following operations can be performed while pictures are zoomed in.



To	Use	Description	📖
Zoom in	T (Q)	Rotate the zoom control toward T (Q). The zoom increases up to about 10x. Zoom also increases by rotating the command dial to the right.	11, 31
Zoom out	W (📐)	Rotate the zoom control toward W (📐). When the magnification ratio reaches 1x, the display returns to full-frame playback mode. Zoom also decreases by rotating the command dial to the left.	11, 31
Move the display area		Press the multi selector ▲, ▼, ◀ or ▶ to move the display area to other areas of the picture.	12
Return to full-frame playback		Press the button.	34, 111
Delete pictures		Select the deletion method and delete the picture(s). When using favorite pictures mode (📖122), auto sort mode (📖129) or list by date mode (📖132), pictures in the same album or category can be deleted.	35
Crop picture	MENU	Press to save the visible portion only as a separate file.	156
Switch to the shooting screen		Press the button or the shutter-release button. You can also switch to shooting by pressing the (▶🎬 movie-record) button.	34, 157

Pictures Taken Using the Face Priority or Pet Detection





When the zoom control is rotated toward **T** (📷) during full-frame playback mode for pictures taken in Face Priority (📖97) or Pet Detection (📖59), the picture is enlarged at the center of the face that was detected during shooting (excluding pictures that were shot using continuous (📖76) or **Exposure bracketing** (📖94)).



- If more than one face was detected, the picture is enlarged with the face that was focused on at the center of the monitor. Press the multi selector ▲, ▼, ◀ or ▶ to display other faces that were detected.
- When the zoom control is further rotated toward **T** (📷) or **W** (📐), the zoom ratio changes and becomes a normal playback zoom display.

Playing Back Images by Category

The following playback modes can be selected.

	Play 📖 111
Play back all images.	
	Favorite pictures 📖 122
Play back images added to an album.	
	Auto sort 📖 129
Play back images and movies automatically sorted to the selected category with shooting.	
	List by date 📖 132
Play back images captured on the selected date.	

1 Press the **MENU** button in playback mode.

- The playback menu is displayed.

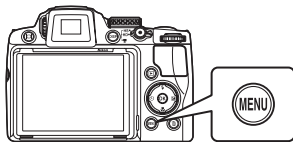

2 Press the multi selector ◀.

- Tab selection is activated.

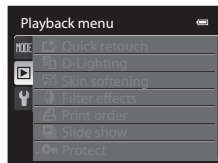

3 Press ▲ or ▼ to choose the **MODE** tab.

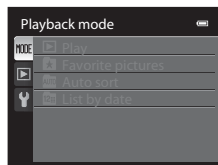

4 Press ▶ or the **OK** button.

- The playback-mode selection menu is displayed.

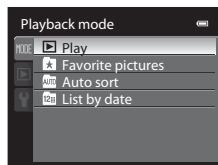

5 Use the multi selector to choose a playback mode.

- To return to the current playback mode without switching playback modes, press the **MENU** button.

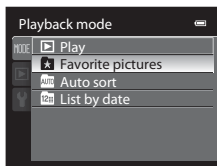

6 Press the **OK** button.

- The camera enters the selected playback mode.

Sorting Favorite Images (Favorite Pictures Mode)

Captured images can be added to an album and sorted.

After images are added, they can be easily played back using “★ favorite pictures mode.”

- By adding images to an album, images can be easily found.
- Images can be sorted by each event such as vacations or weddings.
- The same image can be added to multiple albums.

Adding Images to an Album

Captured images can be added to an album and sorted.

- 1 Choose an image in playback mode (📖34), auto sort mode (📖129), or list by date mode (📖132) and press the **MENU** button.

- The playback menu is displayed.

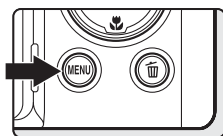

- 2 Use the multi selector to choose **★ Favorite pictures** and press the **OK** button.

- The favorite pictures screen is displayed.

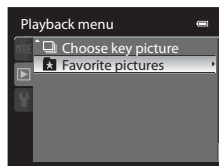

- 3 Press the multi selector **◀** or **▶**, and then choose an image and press **▲** to display **✔**.

- To add more images to the same album, repeat this step as necessary.
- To cancel the selection, press **▼** to remove **✔**.
- Rotate the zoom control (📖4) toward **T** (📷) to switch back to full-frame playback or **W** (📺) to display thumbnails.
- Press the **OK** button to display the album selection screen.

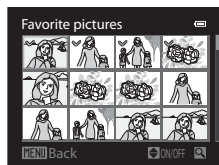

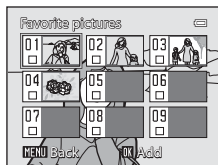

4 Use the multi selector to choose the album to which the images will be added and press the **OK** button.

- The selected images are added and the camera switches to the playback menu.
- To add the same image to multiple albums, repeat from step 2.



Notes on Favorite Pictures

- Up to 200 images can be added to each album.
- Movies cannot be added to an album.
- If the selected image has been already added to an album,  is displayed in the album's checkbox.
- When images are added to an album, they are not moved from the folder to which they were saved (215) or copied to the album (128).

More Information

See "Removing Images From an Album" (125) for more information.

Viewing Images in an Album

When using “Favorite pictures mode,” images added to an album can be displayed by selecting the album.

- In full-frame playback mode, images in the same album can be played back (📖111) and edited (📖146).
- When the **MENU** button is pressed in full-frame playback mode or thumbnail display mode, the favorite pictures menu (📖126) is displayed, and all images added to an album can be selected for viewing in a slide show, or applying print order or protection settings.

- 1 Press the **MENU** button during playback, select the **MODE** (playback mode) tab, and then press **▶** or the **OK** button (📖120).

- To display a list of albums, press **▲** or **▼** to choose **Favorite pictures** and press the **OK** button.

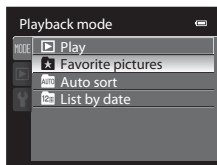

- 2 Use the multi selector to choose an album.

- See “Using Favorite Pictures Mode” (📖126) for more information about operating the list of albums screen.

- When the **OK** button is pressed, an image in the selected album is displayed in full-frame playback mode.
- The icon of the album currently being played back is displayed at the top right of the monitor.
- To choose an album again, repeat steps 1 and 2.

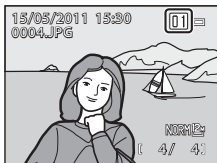
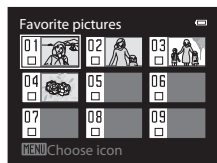

Removing Images From an Album

Remove images from an album without deleting the images.

- 1 Select the album from which images will be removed, play back images in that album (124), and then press the **MENU** button.

- The playback menu is displayed.

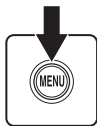
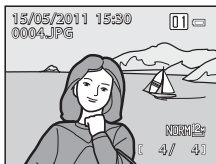

- 2 Use the multi selector to choose **Remove from favorites** and press the **OK** button.

- The remove from favorites screen is displayed.

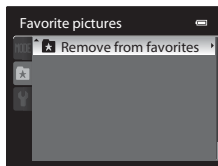

- 3 Press the multi selector **◀** or **▶**, and then choose an image and press **▲** to display .

- To remove more images from the same album, repeat this step as necessary.
- To cancel the selection, press **▼** to remove .
- Rotate the zoom control (124) toward **T** (9) to switch back to full-frame playback or **W** (125) to display thumbnails.
- Press the **OK** button when selection is complete.

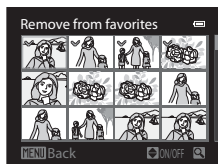

- 4 Choose **Yes** and press the **OK** button.

- The image is removed from the album.
- To cancel removal, select **No**.

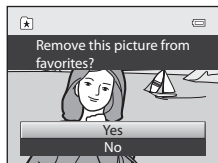







Note on Deletion

If an image is deleted while using favorite pictures mode, the image will be removed from the album and it will be permanently deleted from the internal memory or the memory card (128).

Using Favorite Pictures Mode

The following operations are available from the list of albums screen (📖124 step 2).

Function	Use	Description	📖
Choose an album		Press the multi selector ▲, ▼, ◀ or ▶. An album can also be chosen by rotating the command dial.	11, 12
Switch to full-frame playback mode		Images in the selected album are displayed in full-frame playback mode.	111
Delete images		All images added to the selected album are deleted. Choose Yes when the confirmation dialog is displayed.	35
Change the album icon	MENU	Change the album icon.	127
Switch to shooting mode		Press the  button or the shutter-release button. You can also switch to shooting by pressing the ● (▶📹 movie-record) button.	34, 157
			
			

More on Playback

Playback Menu Options Available in Favorite Pictures Mode

Press the **MENU** button in full-frame playback mode or thumbnail playback mode in favorite pictures mode to apply the following menu operations.

- Quick retouch → 📖148
- Skin softening → 📖150
- Print order → 📖135
- Protect → 📖139
- Hide image → 📖141
- Voice memo → 📖142
- Sequence display options → 📖145
- Remove from favorites → 📖125
- D-Lighting → 📖149
- Filter effects → 📖152
- Slide show → 📖138
- Rotate image → 📖141
- Small picture → 📖154
- Black border → 📖155
- Choose key picture → 📖145

Changing the Album Icons

The design of the album icons can be changed. By changing the icons, it will be easier to identify what kind of images are added to each album.

- 1 Press the **MENU** button during playback, choose the **MODE** (playback mode) tab, and then press **▶** or the **OK** button (120).

- To display a list of albums, press **▲** or **▼** to choose **Favorite pictures** and press the **OK** button.

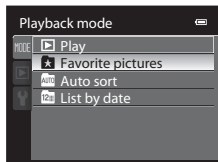

- 2 Use the multi selector to choose an album and press the **MENU** button.

- The choose icon screen is displayed.

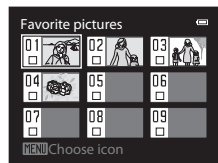

- 3 Press **◀** or **▶** to choose an icon color and press the **OK** button.

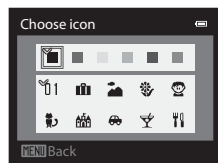

- 4 Press **▲**, **▼**, **◀** or **▶** to choose an icon and press the **OK** button.

- The icon changes and the monitor display returns to the list of albums screen.

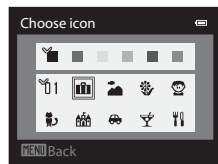

✓ Notes on Album Icons

Set the album icons separately for the internal memory and for the memory card.

- To change the album icons for the internal memory, first remove the memory card from the camera.
- The default setting for the icon is the number icon (black).

Sorting Favorite Images (Favorite Pictures Mode)

Adding/Playing Favorite Pictures

When images are added to an album, they are not moved from the folder to which they were saved (📖215) or copied to the album. Only the file names of the images are added to the album. When using favorite pictures mode, images are played back by retrieving the images that correspond to the file names added to the albums.

Note that if an image is deleted while using favorite pictures mode (📖35, 126), the image will be removed from the album and it will be permanently deleted from the internal memory or the memory card.

Adding Images to Albums

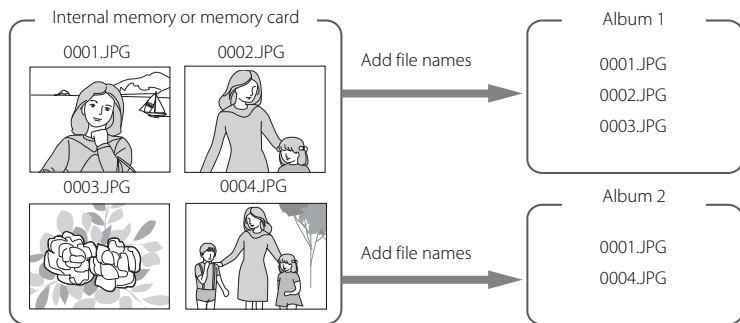





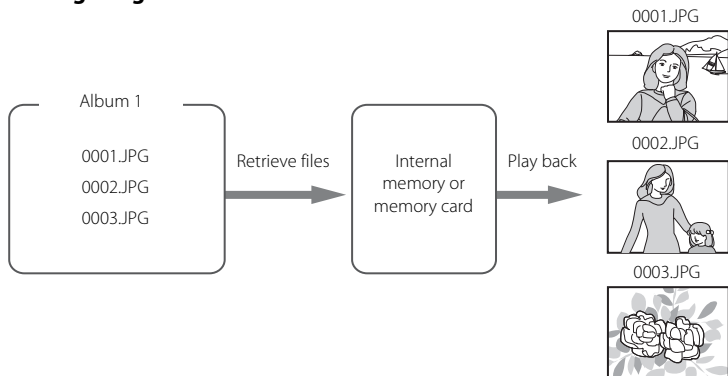





More on Playback

Viewing Images in Albums



Finding Images in Auto Sort Mode

Images and movies are automatically sorted to any of the following categories with shooting. When “**AUTO** auto sort mode” is selected, images and movies can be viewed by selecting the category to which they were sorted.

 Smile	 Portraits	 Food
 Landscape	 Dusk to dawn	 Close-ups
 Pet portrait	 Movie	 Retouched copies
 Other scenes		

- In full-frame playback mode, images in the same category can be played back (📖111) and edited (📖146). Images can be also sorted into albums.
- When the **MENU** button is pressed, the auto sort menu (📖131) is displayed, and all images in the same category can be selected for viewing in a slide show, or applying print order or protection settings.

Viewing Images in Auto Sort Mode

1 Press the **MENU** button during playback, choose the **MODE** (playback mode) tab, and then press **▶** or the **OK** button (📖120).

- To display a list of categories, press **▲** or **▼** to choose **AUTO Auto sort** and press the **OK** button.

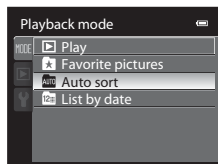
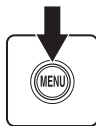





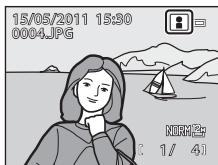
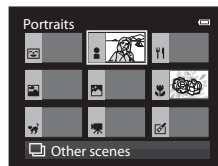







2 Use the multi selector to choose a desired category.

- For information about categories, see “Auto Sort Mode Categories” (📖130).
- See “Operations in Auto Sort Mode” (📖131) for more information about operating the auto sort mode screen.
- Press the **OK** button to display an image in the selected category in full-frame playback mode.
- The icon of the category currently played back will be displayed at the top right of the monitor.
- To choose a desired category again, repeat steps 1 and 2.



Auto Sort Mode Categories

Category	Description
 Smile	Images captured in smart portrait mode (📖65) with smile timer set to On are displayed.
 Portraits	Images captured in P, S, A, M or U mode using face detection (📖97). Images captured in the following scene modes. <ul style="list-style-type: none"> •  (Night portrait)* (📖49) •  (Backlighting)* (📖50) • Portrait* (📖51), Party/indoor (📖52)
 Food	Images captured in the Food (📖56) scene mode.
 Landscape	Images captured in the Landscape* (📖51) scene mode.
 Dusk to dawn	Images captured in the following scene modes. <ul style="list-style-type: none"> •  (Night landscape)* (📖48) • Sunset (📖53), Dusk/dawn (📖54), Fireworks show (📖57)
 Close-ups	Images captured in the macro close-up focus mode (📖40). Images captured in the Close-up* (📖55) scene mode.
 Pet portrait	Images captured in the Pet portrait (📖59) scene mode.
 Movie	Movies (📖157).
 Retouched copies	Copies created using editing function (📖146).
 Other scenes	All other images that cannot be defined by the categories described above.







* Images captured in Scene auto selector (📖46) are also sorted to the appropriate categories.

Notes on Auto Sort Mode

- Up to 999 images and movie files can be sorted to each category in auto sort mode. If 999 images or movies have already been sorted to a specific category, new images and movies cannot be sorted to that category nor can they be displayed in auto sort mode. Display images and movies that could not be sorted to a category in normal playback mode (📖34) or list by date mode (📖132).
- Images or movies copied from the internal memory to a memory card, or vice versa (📖144), cannot be displayed in auto sort mode.
- Images or movies saved by cameras other than COOLPIX P500 cannot be displayed in auto sort mode.

Operations in Auto Sort Mode

The following operations are available in the category list screen (📖 129 step 2).

Function	Use	Description	📖
Select a category		Press the multi selector ▲, ▼, ◀ or ▶. A category can also be chosen by rotating the command dial.	11, 12
Switch to full-frame playback mode		Display images in the selected category in full-frame playback mode.	111
Delete images		Delete all images in the selected category. Choose Yes when the confirmation dialog is displayed.	35
Switch to shooting mode		Press the  button or the shutter-release button. You can also switch to shooting by pressing the ● (▶📹 movie-record) button.	34, 157
			
			

More on Playback

Playback Menu Options Available in Auto Sort Mode

Press the **MENU** button in full-frame playback mode or thumbnail playback mode in auto sort mode to operate the following menus.



- Quick retouch → 📖 148
- Skin softening → 📖 150
- Print order → 📖 135
- Protect → 📖 139
- Hide image → 📖 141
- Voice memo → 📖 142
- Sequence display options → 📖 145
- Favorite pictures → 📖 122
- D-Lighting → 📖 149
- Filter effects → 📖 152
- Slide show → 📖 138
- Rotate image → 📖 141
- Small picture → 📖 154
- Black border → 📖 155
- Choose key picture → 📖 145



Viewing Images by Date (List by Date)

In “ list by date mode,” only images captured on the same date can be played back.

- In full-frame playback mode, just as with normal playback mode, shooting information can be displayed, image display can be enlarged, images can be edited, and movies can be played back. Images can be also sorted into albums.
- When the **MENU** button is pressed, the list by date menu ( 133) is displayed, and all images captured on the same date can be selected for viewing in a slide show, or applying print order or protection settings.

Viewing Images in List by Date Mode

- 1 Press the **MENU** button during playback, choose the **MODE** (playback mode) tab, and then press  or the **OK** button ( 120).

- To display the list by date screen, press  or  to choose  **List by date** and press the **OK** button.

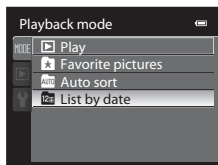

- 2 Use the multi selector to choose a date.

- The camera lists up to 29 dates. If images exist for more than 29 dates, all images saved earlier than most recent 29 dates will be combined under **Others**.
- See “Operations in List by Date Mode” ( 133) for information about operating the list by date screen.
- When the **OK** button is pressed, the first image captured on the selected date will be displayed in full-frame playback mode.
- To choose a date again, repeat steps 1 and 2.

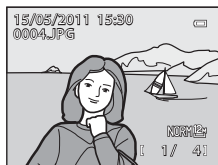
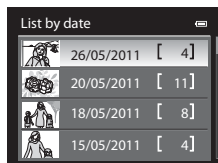









Notes on List by Date Mode

- The 9,000 most recent images can be displayed in list by date mode. If more than 9,000 images are saved, “**” is displayed for the date containing the 9,001st image.
- Images captured when the camera’s date is not set are treated as images captured on January 1, 2011.

Operations in List by Date Mode

The following operations are available in the list by date screen (📖 132 step 2).

Function	Use	Description	📖
Select date		Press the multi selector ▲ or ▼. A date can also be chosen by rotating the command dial.	11, 12
Switch to full-frame playback mode		Display images captured on the selected date in full-frame playback mode.	111
Delete images		Delete all images captured on the selected date. Choose Yes when the confirmation dialog is displayed.	35
View list by date menu	MENU	Display the list by date menu.	–
Switch to shooting mode		Press the  button or the shutter-release button. You can also switch to shooting by pressing the  (●) (▶) movie-record button.	34, 157
			
			

More on Playback

Playback Menu Options Available in List by Date Mode

Press the **MENU** button in list by date mode to apply one of the following menu operations to images captured on the selected date.



































- Quick retouch¹ → 📖 148
- Skin softening¹ → 📖 150
- Print order² → 📖 135
- Protect² → 📖 139
- Hide image² → 📖 141
- Voice memo¹ → 📖 142
- Sequence display options → 📖 145
- Favorite pictures¹ → 📖 122
- D-Lighting¹ → 📖 149
- Filter effects¹ → 📖 152
- Slide show → 📖 138
- Rotate image¹ → 📖 141
- Small picture¹ → 📖 154
- Black border¹ → 📖 155
- Choose key picture → 📖 145

¹ After displaying the image in full-frame playback mode, press the **MENU** button.

² When the **MENU** button is pressed in the list by date screen (📖 132 step 2), options can be applied to all images captured on the selected date. When the **MENU** button is pressed in full-frame playback mode, options can be applied to individual images.

Playback Options: Playback Menu

The following options are available in playback menu.

	Quick retouch  148
Easily create retouched images in which contrast and saturation have been enhanced.	
	D-Lighting  149
Enhance brightness and contrast in dark portions of pictures.	
	Skin softening  150
Make the subject's skin appear smoother.	
	Filter effects  152
Apply a variety of effects using digital filter.	
	Print order  135
Select pictures to print and the number of copies for each.	
	Slide show  138
View pictures stored in the internal memory or on a memory card in an automatic slide show.	
	Protect  139
Protect selected pictures from accidental deletion.	
	Rotate image  141
Change the orientation of the picture taken.	
	Hide image  141
Hide selected pictures during playback.	
	Small picture  154
Create a small copy of the picture taken.	
	Voice memo  142
Add a voice memo to the picture taken.	
	Copy  144
Copy files between the memory card and internal memory.	
	Black border  155
Create a new picture surrounded by a black border.	
	Sequence display options  145
Display a sequence of images shot continuously as individual images, or display only the key picture of a sequence.	
	Choose key picture  145
Change the key picture for the series of pictures that were shot continuously (Pictures in a sequence  113).	
	Favorite pictures  122
Select and add pictures as favorites.	
	Remove from favorites  125
Remove a picture from an album.	

Displaying the Playback Menu

Press the **▶** button to enter playback mode (📖34).

Press the **MENU** button to display the playback menu.

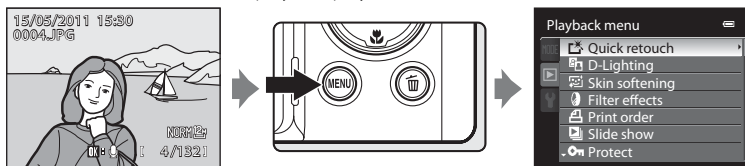

- Use the multi selector to select items and set functions on menus (📖12).
- To exit the playback menu, press the **MENU** button.

🖨️ Print Order: Setting the Pictures and Number of Copies to Print

Press the **▶** button (Playback mode) → **MENU** (Playback menu) → 🖨️ Print order

If you choose to use one of the following methods to print pictures that are recorded on a memory card, the pictures to print and the number of copies can be set in advance on the memory card.

- Printing with a DPOF-compatible (📖233) printer that is equipped with a card slot.
- Ordering the prints from a digital photo lab that has a DPOF service.
- Printing by connecting the camera to a PictBridge-compatible (📖233) printer (📖179). (When the memory card is removed from the camera, the print order settings can also be applied to the pictures recorded on the internal memory.)

- 1 Use the multi selector to choose **Select images** and press the **OK** button.

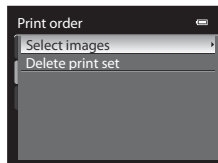

2 Choose the pictures (up to a maximum of 99) and number of copies (up to nine per picture).

- Press the multi selector ◀ or ▶ to choose the pictures, and press ▲ or ▼ to set the number of copies for each.
- Pictures can also be chosen by rotating the command dial.
- Pictures selected for printing can be recognized by the check mark icon and the numeral indicating the number of copies to be printed. A check mark is not displayed with pictures for which no copies have been specified and these pictures are not printed.
- Rotate the zoom control toward **T** (Q) to switch to full-frame playback, or **W** (R) to switch to 12 thumbnails display.
- Press the **OK** button when setting is complete.



3 Choose whether or not to also print shooting date and photo information.

- Choose **Date** and press the **OK** button to print the shooting date on all pictures in the print order.
- Choose **Info** and press the **OK** button to print shooting information (shutter speed and aperture value) on all pictures in the print order.
- Choose **Done** and press the **OK** button to complete the print order.

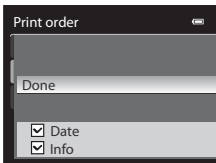

Pictures selected for printing are recognized by the  icon displayed in playback mode.

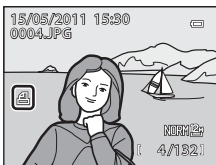

Notes on Printing Shooting Date and Photo Information

When the **Date** and **Info** options are enabled in the **Print order** menu, shooting date and photo information are printed on pictures when a DPOF-compatible (1233) printer which supports printing of shooting date and photo information is used.

- Photo information cannot be printed when the camera is connected directly to a printer, via the supplied USB cable, for DPOF printing (184).
- **Date** and **Info** are reset each time the **Print order** menu is displayed.
- The date printed is that saved when the picture was captured.

Changing the camera's date using the **Time zone and date** setting in the setup menu after a picture has been captured has no effect on the date printed on the picture.



✓ Notes on Print order

When a print order is created in favorite pictures mode, auto sort mode, or list by date mode, the screen shown below is displayed if pictures other than those in the selected album, category, or shooting date have been marked for printing.

- If **Yes** is selected, the current print order settings are added to the print order settings of other pictures.
- If **No** is selected, all print order settings of other pictures are removed and only the current print order settings remain.

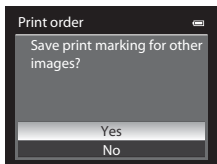

Favorite pictures mode or
auto sort mode

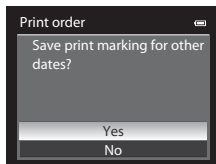

List by date mode

Additionally, if there are more than 99 pictures as a result of adding the current print order settings, the screen shown below will be displayed.

- If **Yes** is selected, all print order settings of other pictures are removed and only the current print order settings remain.
- If **Cancel** is selected, the print order settings of other pictures remain and the current print order settings are removed.

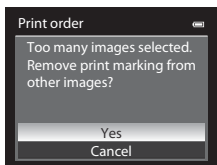

Favorite pictures mode or
auto sort mode

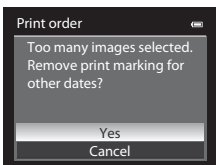

List by date mode

✂ Deleting All Print Orders

In step 1 of the print order procedure (📖135), choose **Delete print set** and press the **OK** button to delete the print orders for all pictures.

🕒 Print date

The shooting date and time can be imprinted in pictures at the time of shooting by using **Print date** (📖192) in the setup menu. This information can be printed even from printers that do not support printing of the date and time. Only the date and time of Print date on the pictures are printed, even if **Print order** is enabled with the date selected in the print order screen.

🕒 More Information



See "Note on Printing Images of Size 1:1" (📖86) for more information.

Slide Show

Press the  button (Playback mode) → MENU (Playback menu) →  Slide show



View pictures stored in the internal memory or on a memory card in an automatic slide show.

1 Use the multi selector to choose **Start** and press the button.

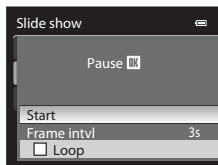
- To change the interval between pictures, choose **Frame intvl**, select the desired interval time, and press the  button before choosing **Start**.
- To repeat the slide show automatically, enable **Loop** and press the  button before choosing **Start**. The check mark () is added to the loop option when enabled.



2 The slide show begins.

- Press the multi selector  to display the next picture, or  to display the previous picture. Press and hold the button to fast forward or rewind.
- To exit partway or pause, press the  button.





3 Choose End or Restart.

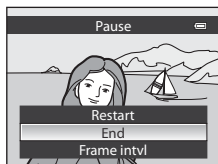

- When exiting or pausing the slide show, the screen shown on the right is displayed. Choose **End** and press the  button to return to the playback menu. Choose **Restart** to play the slide show again.



Notes on Slide Shows

- Only the first frame of movies ( 168) included in slide shows is displayed.
- For sequences ( 113) whose sequence display options are set to **Key picture only**, only the key picture is displayed.
- Pictures recorded with easy panorama cannot be played back in a slide show.
- Slide shows play for a maximum of about 30 minutes, even when **Loop** is selected ( 199).

Protect

Press the  button (Playback mode) → MENU (Playback menu) →  Protect

Protect selected pictures from accidental deletion.

In the picture selection screen, choose a picture and set or cancel protection. See “Selecting Pictures” ( 140) for more information.

Note, however, that formatting the camera’s internal memory or the memory card permanently erases the protected files ( 200).

Protected pictures are recognized by the  icon in playback mode ( 10, 116).

Selecting Pictures

The picture selection screen, as shown on the right, is displayed in the following menus.

Only one picture can be selected for some menu items, while for other menu items, multiple pictures can be selected.



Functions for which only one picture can be selected	Functions for which multiple pictures can be selected
<ul style="list-style-type: none"> • Playback menu: Rotate image (📖141), Choose key picture (📖145) • Setup menu: Select an image in Welcome screen (📖187) 	<ul style="list-style-type: none"> • Playback menu: Select images in Print order (📖135), Protect (📖139), Hide image (📖141), Selected images in Copy (📖144) Favorite pictures (📖122), Remove from favorites (📖125) • Erase selected images in Deleting unnecessary images (📖35)

More on Playback

Follow the procedure described below to select pictures.

1 Press the multi selector ◀ or ▶ to choose the desired picture.

- Pictures can also be chosen by rotating the command dial.
- Rotate the zoom control toward **T** (🔍) to switch to full-frame playback, or **W** (📖) to switch to 12 thumbnails display.
- For functions for which only one picture is selected, proceed to step 3.



2 Press ▲ or ▼ to select or deselect (or to specify the number of copies).

- When a picture is selected, a check mark (☑) is displayed with the picture. Repeat steps 1 and 2 to select additional pictures.



3 Press the (OK) button to apply the picture selection.



- With selections such as **Selected images**, the confirmation dialog is displayed. Follow the instructions on the screen.

Rotate Image

Press the  button (Playback mode) → MENU (Playback menu) →  Rotate image

Change the orientation of pictures played back in the camera's monitor after shooting. Still pictures can be rotated 90° clockwise or counterclockwise.

Pictures that were recorded in the "tall" orientation can be rotated up to 180° in either direction.

Select a picture in the picture selection screen ( 140) to display the Rotate image screen. Press the multi selector  or  to rotate the picture 90°.

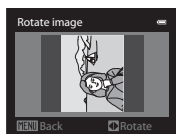

Rotate 90°
counterclockwise

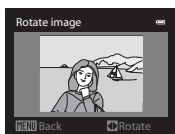

Rotate 90°
clockwise



Press the  button to set the orientation displayed and save the orientation data with the picture.

Rotating Images in a Sequence



While the key picture of a sequence is displayed, images cannot be rotated. Apply the setting after displaying individual images ( 113, 145).

Hide Image

Press the  button (Playback mode) → MENU (Playback menu) →  Hide image

Hide pictures so that they cannot be played back on the camera monitor.

In the picture selection screen, choose the pictures and set or cancel the hide setting. See "Selecting Pictures" ( 140) for more information.



Hidden pictures cannot be deleted using the  button. Note, however, that formatting the internal memory or memory card ( 200) permanently erases the hidden pictures.

Voice Memo

Press the  button (Playback mode) → MENU (Playback menu) →  Voice memo

Use the camera's microphone to record voice memos for pictures.

Recording Voice Memos

- 1 Choose a picture in full-frame playback mode (34) or thumbnail playback mode (115) and press the **MENU** button.

- The playback menu is displayed.

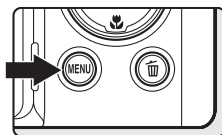

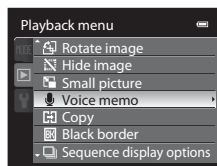

- 2 Use the multi selector to choose  **Voice memo** and press the **OK** button.

- The screen for recording voice memos is displayed.



- 3 Press and hold the **OK** button to record a voice memo.

- Recording ends after about 20 seconds or when the **OK** button is released.
- Do not touch the microphone during recording.
- During recording, **REC** and  blink on the monitor.
- When recording ends, the voice memo playback screen is displayed. Follow the procedure in step 3 of "Playing Voice Memos" (143) to play the voice memo.
- Press the multi selector  before or after recording a voice memo to return to the playback menu. Press the **MENU** button to exit the playback menu.

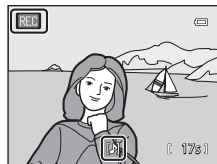
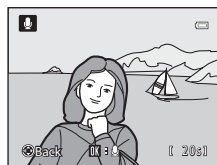



More Information

See "File and Folder Names" (215) for more information.

Playing Voice Memos

Pictures for which voice memos have been recorded are indicated by  in full-frame playback mode.

- 1 Choose a picture with a voice memo in full-frame playback mode (34) or thumbnail playback mode (115) and press the **MENU** button.

- The playback menu is displayed.

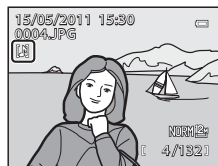

- 2 Use the multi selector to choose  **Voice memo** and press the **OK** button.

- The voice memo playback screen is displayed.

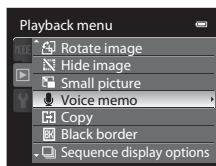







- 3 Press the **OK** button to play the voice memo.

- Press the **OK** button again to stop playback.
- Rotate the zoom control toward **T** or **W** during playback to adjust playback volume.
- Press the multi selector  before or after playing a voice memo to return to the playback menu. Press the **MENU** button to exit the playback menu.



Deleting Voice Memos



Select a picture with a voice memo and press the  button. Press the multi selector  or  to choose **Current image**, and press the **OK** button (35). When the confirmation dialog is displayed, press the multi selector  or  to choose  and press the **OK** button. Only the voice memo will be deleted.



Notes on Voice Memos



- When a picture with a voice memo attached is deleted, both the picture and its voice memo are deleted.
- Voice memos cannot be recorded for a picture that already has a voice memo attached on it. The current voice memo must be deleted before a new voice memo can be recorded.
- COOLPIX P500 is not able to record a voice memo for a picture captured with another make or model of digital camera.

Copy: Copying Between Internal Memory and Memory Card

Press the  button (Playback mode) → MENU (Playback menu) →  Copy

Copy pictures between the internal memory and a memory card.

1 Use the multi selector to choose a destination option to which pictures are copied and press the .

- : Copy pictures from the internal memory to the memory card.
- : Copy pictures from the memory card to the internal memory.

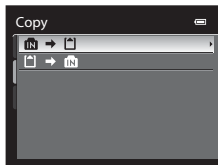

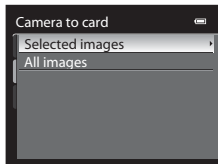

2 Select a copy option and press the .

- **Selected images:** Copy pictures selected from the image selection screen (140). If a sequence for which only a key picture is displayed is selected (113), all pictures in the displayed sequence are copied.
- **All images:** Copy all pictures. If a picture in a sequence is selected, this option is not displayed.
- **Current sequence:** This option is displayed when a picture in a sequence has been selected before displaying the playback menu. All pictures in the current sequence are copied.



Notes on Copying Pictures

- JPEG-, MOV-, and WAV-format files can be copied. Files saved in any other format cannot be copied.
- **Voice memo** (142) attached to pictures and **Protect** setting (139) are also copied with the pictures.
- Operation is not guaranteed with pictures captured with another make of camera or that have been modified on a computer.
- **Print order** settings (135) and the contents of the album (122) are not copied with the pictures.
- Pictures with **Hide image** (141) settings cannot be copied.
- Pictures or movies copied from the internal memory or a memory card cannot be displayed in auto sort mode (129).
- If **Sequence display options** (145) is set to **Key picture only** and a picture in the sequence is selected and the  button is pressed to display individual pictures (113), only  (memory card to internal memory) image copy is available.



Message: “Memory contains no images.”

If there are no pictures saved on a memory card inserted in the camera when playback mode is applied, the message **Memory contains no images.** will be displayed. Press the **MENU** button to display the copy option screen, and copy the pictures saved in the camera's internal memory to the memory card.

More Information

See “File and Folder Names” (📖215) for more information.

Sequence Display Options

Press the  button (Playback mode) → **MENU** (Playback menu) →  Sequence display options

Choose the method used to display a series of pictures shot continuously (sequence, 📖113) when viewing them in full-frame playback mode (📖34) or in thumbnail playback mode (📖115).

Settings are applied to all sequences, and the setting is saved in the camera's memory even if the camera is turned off.

Individual pictures

Each picture in a sequence is displayed.

Key picture only (default setting)

Return a sequence in which pictures are displayed individually to the key picture only display.

Choose Key Picture

Press the  button (Playback mode) → **MENU** (Playback menu) →  Choose key picture

When **Sequence display options** is set to **Key picture only**, the key picture displayed in full-frame playback mode (📖34) or thumbnail playback mode (📖115) can be set for each sequence of pictures.

- When changing this setting, before pressing **MENU**, first select the desired sequence using full-frame playback mode or thumbnail playback mode.
- When the key picture selection screen is displayed, select a picture. See “Selecting Pictures” (📖140) for more information.

Picture Editing Functions

Pictures can be easily edited with this camera using the functions below. Edited pictures are stored as separate files (📖215).

Editing function	Application
Quick retouch (📖148)	Easily create a copy with enhanced contrast and richer colors.
D-Lighting (📖149)	Create a copy of the current picture with enhanced brightness and contrast, brightening dark portions of the picture.
Skin softening (📖150)	Make facial skin tones softer.
Filter effects (📖152)	Apply a variety of effects using digital filter. The available effects are Soft , Selective color , Cross screen , Fisheye and Miniature effect .
Small picture (📖154)	Create a small copy of pictures suitable for uses such as e-mail attachments.
Black border (📖155)	Add a black frame around the picture. Use when you want to add a black border to a picture.
Crop (📖156)	Crop a portion of the picture. Use to zoom in on a subject or arrange a composition.

✓ Notes on Picture Editing

- Pictures shot with an **Image size** (📖84) of **3984×2656**, **3968×2232**, **1920×1080** and **2992×2992** can only be modified using the Black border editing function. Also, editing functions other than Black border are not available for still images captured while recording high-definition or full high-definition movies (📖155).
- Pictures recorded with easy panorama cannot be edited.
- When no faces are detected in the picture, skin softening cannot be applied (📖150).
- COOLPIX P500's editing functions are not available for pictures shot with digital cameras other than COOLPIX P500.
- If a copy created using the COOLPIX P500 is viewed on a different digital camera, it may not be possible to display the picture properly or transfer it to a computer.
- Editing functions are not available when there is not enough free space in the internal memory or on the memory card.
- For sequences for which only a key picture is displayed (📖113), perform one of the following operations before editing.
 - Press the **OK** button to display individual images, and then select an image in the sequence
 - Set **Sequence display options** (📖145) to **Individual pictures** so that each image is displayed individually, and then select an image

Restrictions on Picture Editing

The following restrictions apply when editing pictures that were created by editing.

Editing function used	Editing function to add
Quick retouch D-Lighting Filter effects	Skin softening, Small picture, Black border or crop can be used. Quick retouch, D-Lighting or Filter effects cannot be used together.
Skin softening	Quick retouch, D-Lighting, Filter effects, Small picture, Black border or crop can be used.
Small picture	No additional editing functions can be used.
Black border	Small picture can be used.
Crop	Black border can be used.

- Copies created by editing cannot be edited again using the same edit function.
- To use an editing function together with small picture, use the other edit function first, and use small picture as the last edit function performed on that picture.
- Pictures that were taken using skin softening can be edited using skin softening.

Original Pictures and Edited Copies

- Copies created with editing functions are not deleted if the original pictures are deleted. The original pictures are not deleted if copies created with editing functions are deleted.
- Edited copies are stored with the same shooting date and time as the original.
- Even if the pictures that are marked for **Print order** (📖135) or **Protect** (📖139) are used for editing, these settings are not reflected on the edited copies.

Editing Pictures

Quick Retouch: Enhancing Contrast and Saturation

Easily create retouched pictures in which contrast and saturation have been enhanced. Retouched copies are stored as separate files.

- 1 Choose the desired picture from full-frame (34) or thumbnail (115) playback mode and press the **MENU** button.

- The playback menu is displayed.

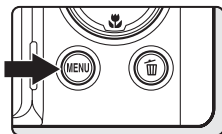

- 2 Use the multi selector to choose  **Quick retouch** and press the **OK** button.

- The original version is displayed on the left and the edited version is displayed on the right.



- 3 Press **▲** or **▼** to choose the setting level, and press the **OK** button.

- A retouched copy is created.
- To cancel, press the **MENU** button.

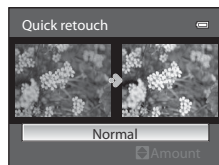

- Quick retouched copies can be recognized by the  icon displayed in playback mode.



More Information

See "File and Folder Names" (215) for more information.

D-Lighting: Enhancing Brightness and Contrast

Create copies with enhanced brightness and contrast, brightening dark portions of a picture. Enhanced copies are stored as separate files.

- 1 Choose the desired picture from full-frame () or thumbnail () playback mode and press the **MENU** button.

- The playback menu is displayed.

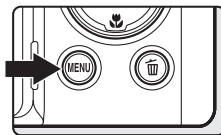

- 2 Use the multi selector to choose  **D-Lighting** and press the **OK** button.

- The original version is displayed on the left and the edited version is displayed on the right.



- 3 Press **▲** or **▼** to choose the setting level, and press the **OK** button.

- A new, edited copy is created.
- To cancel, press the **MENU** button.

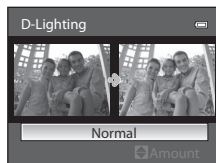

- D-Lighting copies can be recognized by the  icon displayed in playback mode.



More Information

See "File and Folder Names" () 215) for more information.

Skin Softening: Making Skin Appear Smoother

Skin softening can be applied to faces that are detected in pictures already taken, to make skin appear smoother. Pictures edited with this function are stored as separate files.

- 1 Choose the desired picture from full-frame ()34) or thumbnail ()115) playback mode and press the **MENU** button.

- The playback menu is displayed.

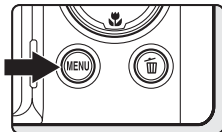

- 2 Use the multi selector to choose  **Skin softening** and press the **OK** button.

- The screen that allows you to set the amount of skin softening is displayed.
- If no faces are detected in the image, a warning is displayed and the screen returns to the playback menu.



- 3 Press **▲** or **▼** to choose the setting level, and press the **OK** button.

- A confirmation screen is displayed, and the image is displayed zoomed in on the face edited by skin softening.
- To cancel, press the **MENU** button.

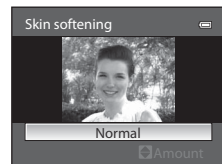

4 Confirm the results.

- Skin tones in up to 12 faces, in the order of that closest to the center of the frame, are softened.
- When multiple faces are edited using skin softening, use the multi selector ◀ and ▶ to switch the face that is displayed.
- To adjust the extent of skin softening, press the **MENU** button and return to step 3.
- To create a copy edited with skin softening, press the **OK** button.
- Copies created by editing with skin softening can be recognized by the  icon displayed in playback mode.

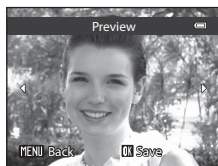

Note on Skin Softening

Depending on conditions such as the direction the subject is facing or the brightness of the face, the face may not be detected properly, or the desired effect may not be achieved.

More Information

See "File and Folder Names" (📖215) for more information.

Filter Effects: Digital Filter

Apply a variety of effects using digital filter. The following effect options are available. The image created with the filter effect is saved separately from the original picture file.

Option	Description
Soft	Gently softens the focus of the image from the center to the edge. In pictures taken with face priority (📖97) or pet detection (📖59) selected, areas around faces will be blurred.
Selective color	Keeps only selected image colors and makes other colors black-and-white.
Cross screen	Produce star-like rays of light that radiate outward from bright objects such as sunlight reflections and city lights. Suitable for night scenes.
Fisheye	Creates images that look like they were shot with a fisheye lens. Suitable for pictures shot in macro mode.
Miniature effect	Creates images that look like close-up photos of a diorama. Suitable for pictures shot while looking down from a high location, with the main subject near the center of the frame.

- 1 Choose the desired picture from full-frame (📖34) or thumbnail (📖115) playback mode and press the **MENU** button.

- The playback menu is displayed.

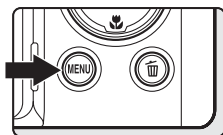

- 2 Use the multi selector to choose **Filter effects** and press the **OK** button.



- 3 Choose the filter effect type and press the **OK** button.

- A confirmation screen is displayed.
- When **Cross screen**, **Fisheye** or **Miniature effect** is selected, proceed to step 5.

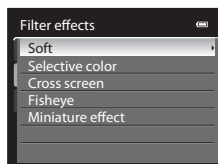

4 Adjust the effect.

- **Soft:** Press ▲ or ▼ to choose the extent of the effect and press the **OK** button.

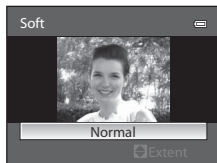

- **Selective color:** Press ▲ or ▼ to move the slider, select the color to keep, and press the **OK** button.

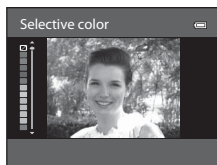

5 Check the effect, choose **Save** and press the **OK** button.

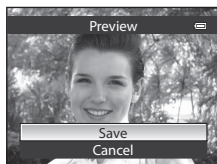

- A new, edited copy is created.
- To cancel, choose **Cancel** and press the **OK** button.
- Copies created by editing with filter effect can be recognized by the  icon displayed in playback mode.



More Information

See "File and Folder Names" (📖215) for more information.

Small Picture: Decreasing Image Size

Create a small copy of the picture taken. Suitable for displaying on web pages or sending as e-mail attachments. The available size is  **640×480**,  **320×240** or  **160×120**. Small copies are stored as separate files with a compression ratio of 1:16.

- 1 Choose the desired picture from full-frame ( 34) or thumbnail ( 115) playback mode and press the **MENU** button.

- The playback menu is displayed.

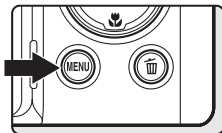

- 2 Use the multi selector to choose  **Small picture** and press the **OK** button.

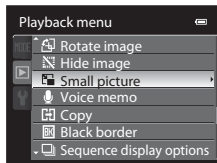

- 3 Choose the desired copy size and press the **OK** button.

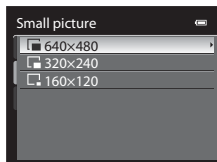

- 4 Choose **Yes** and press the **OK** button.

- A new, smaller copy is created.
- To cancel, choose **No** and press the **OK** button.
- The copy is displayed with a black frame.

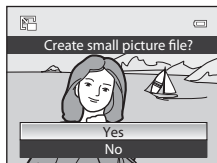

More Information

See "File and Folder Names" ( 215) for more information.

BK Black Border: Adding a Black Border to Pictures

This function creates black borders along the border of a picture. Choose from **Thin**, **Medium** or **Broad** lines. The created pictures are stored as separate files.

- 1 Choose the desired picture from full-frame (📖34) or thumbnail (📖115) playback mode and press the **MENU** button.

- The playback menu is displayed.

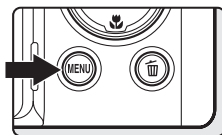

- 2 Use the multi selector to choose **BK** Black border and press the **OK** button.

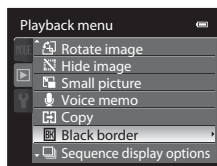

- 3 Choose the desired frame thickness and press the **OK** button.

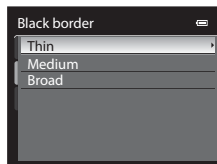

- 4 Choose **Yes** and press the **OK** button.

- A new copy with a black border is created.
- To cancel, choose **No** and press the **OK** button.
- Copies created by editing with black borders can be recognized by the **BK** icon displayed in playback mode.



✓ Notes on Black Border



- A part of the picture equivalent to the thickness of the black border is cut off because the black border overlaps the picture.
- When a picture with a black border is printed using a printer's borderless print function, the black border may not be printed.

📖 More Information

See "File and Folder Names" (📖215) for more information.

✂ Crop: Creating a Cropped Copy





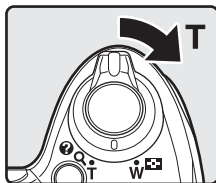

Create a copy containing only the portion visible on the monitor when **MENU**  is displayed with playback zoom ( 118) enabled. Cropped copies are stored as separate files.

- 1 Rotate the zoom control toward **T** () in full-frame playback mode ( 34) to zoom in on the picture.

- To crop a picture displayed in “tall” orientation, zoom in on the picture until the black bars displayed on the both sides of the monitor disappear. The cropped picture is displayed in landscape orientation. To crop the picture in its current “tall” orientation, first, use the **Rotate image** option ( 141) to rotate the picture so that it is displayed in landscape orientation. Next, enlarge the picture for cropping, crop the picture, and then rotate the cropped picture back to “tall” orientation.



- 2 Refine crop composition.

- Rotate the zoom control toward **T** () or **W** () to adjust the zoom ratio.
- Press the multi selector , , , or  to scroll the picture so that only the portion to be copied is visible on the monitor.



- 3 Press the **MENU** button.

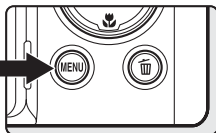

- 4 Use the multi selector to choose **Yes** and press the **OK** button.

- A cropped copy is created.
- To cancel, choose **No** and press the **OK** button.

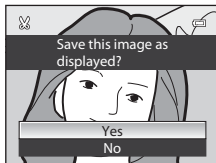





Image Size

As the area to be saved is reduced, the image size (pixels) of the cropped copy is also reduced. When the image size setting for a cropped copy is 320x240 or 160x120, a black frame appears around the picture during playback, and the  or  small picture icon appears on the left side of the monitor.

More Information

See “File and Folder Names” ( 215) for more information.

Recording Movies

High-definition movies with sound can be recorded.

- A memory card is required when recording movies. Insert the memory card into the camera (166).
- The maximum movie length for a single movie is 4 GB or 29 minutes, even when there is sufficient free space on the memory card (166).

1 Turn on the camera and display the shooting screen.

- Movies can be recorded in any shooting mode (144).
- The movie options show the type of movie that will be recorded. The default setting is **1080p HD 1080p★ (1920×1080)** (164). The movie options are not displayed when no memory card is inserted.
- When recording movies, the angle of view (i.e., the area visible in the frame) is narrower than that of still pictures. Press the **DISP** (display) button and display the movie frame (17) to check the range of a movie in a frame before recording.

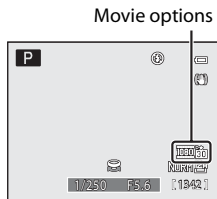

2 Rotate the movie mode switch to HD.

- Lower the flash. If the flash is raised, it may disturb the recording.

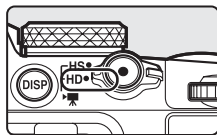

3 Press the **●** (movie-record) button to start movie recording.

- The LCD monitor is turned off for a moment, and then the movie recording starts.
- The camera focuses at the center of the frame. Focus areas are not displayed during recording.
- When recording movies in high-definition or full high-definition, monitor display changes to an aspect ratio of 16:9 with movie recording (the area indicated on the right is recorded).
- The approximate remaining movie length is displayed during recording.
- Recording stops automatically when the maximum movie length has been recorded.

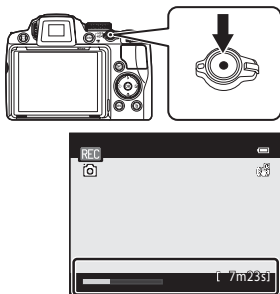

4 Press the **●** (movie-record) button to end recording.

✓ Notes on Movie Recording

- A memory card with an SD speed class of Class 6 or higher is recommended (📖214). If the transfer speed of the card is slow, the movie recording may end unexpectedly.
- Using a digital zoom causes image quality to deteriorate. If you start recording the movie without using digital zoom, and you rotate the zoom control toward **T**, the zoom stops at the maximum optical zoom ratio. Release the zoom control and rotate it again toward **T** to trigger digital zoom. When recording ends, digital zoom turns off.
- The sound of using the zoom control, zoom, autofocus or aperture control when the brightness changes may be recorded.
- The following phenomena may be seen on the monitor while recording movies. These phenomena are saved in the recorded movies.
 - Banding may occur in images under fluorescent, mercury-vapor, or sodium-vapor lighting
 - Subjects that move quickly from one side of the frame to the other, such as a moving train or car, may appear skewed
 - The entire movie image may be skewed when the camera is panned.
 - Lighting or other bright areas may leave residual images when the camera is moved

✓ Notes on Autofocus

- If **Autofocus mode** in the movie menu is set to **AF Single AF** (default setting), the focus is locked when the **● (📷 movie-record)** button is pressed to start movie recording (📖166).
- Autofocus may not perform as expected (📖33). Should this occur, try the following:
 1. Before recording, set **Autofocus mode** in the movie menu to **AF Single AF** (default setting).
 2. Position a different subject at the same distance in the middle of the screen. Press the **● (📷 movie-record)** button to start the movie recording, and change the composition.Before recording, you can set the focus mode to **MF** (manual focus) and adjust the focus using manual focus (📖42).

✓ Note on the Camera Temperature

The camera may become warm when recording movies for an extended period of time or when the camera is used in a hot area. This is not a malfunction.

✓ Note on Saving Movies

After a movie has been recorded, it is not fully saved to the internal memory or memory card until monitor display returns to the shooting display. **Do not open the battery-chamber/memory card slot cover while pictures are being recorded.** Turning the camera off or removing the memory card while movies are being recorded could result in loss of data or in damage to the camera or card.

Functions Available in Movie Recording

- The focus mode, exposure compensation, and **Optimize image** and **White balance** settings in shooting menu are also applied when recording movies. Confirm settings before starting movie recording.
- When the shooting mode is **P**, **S**, **A**, **M** or **U**, the **Metering** (📖93) setting is also applied to the movie recording (except for **Spot AF area**).
- The self-timer (📖39) can be used. If the self-timer is set and the ● (🎬 movie-record) button is pressed, the camera focuses at the center of the frame and starts movie recording after ten or two seconds.
- The flash does not fire.
- Press the **MENU** button before starting to record the movie to display the 🎬 (movie) tab and select movie menu settings (📖163).
- To reduce the effects of camera shake when recording movies, set **Electronic VR** (📖167) in the movie menu.

Recording Movies in Slow Motion and Fast Motion (HS Movie)

HS (high speed) movies can be recorded. The portions of the movie recorded using HS movie can be played back in slow motion at 1/8-1/2 of normal playback speed, or played back in fast motion at a speed two times faster than normal speed. While recording movies, the camera can be switched from normal speed movie recording to slow motion or fast motion movie recording.

1 Turn on the camera and rotate the movie mode switch to HS.

- The HS movie options show the type of HS movie that will be recorded (165). The HS movie options are not displayed when no memory card is inserted.
- Lower the flash. If the flash is raised, it may disturb the recording.

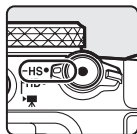

HS movie options

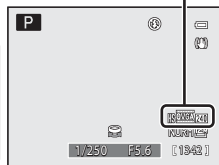

2 Press the **●** (movie-record) button to start the movie recording.

- The LCD monitor is turned off for a moment, and then the HS movie recording starts.
- The camera focuses at the center of the frame. The focus area is not displayed while the movie is recorded.
- When the **Open with HS footage** (165) is set to **Off**, normal speed movies are recorded when recording begins. Press the **OK** button to switch to HS movie recording at the point where the camera should record for slow motion or fast motion playback.
- The camera switches between normal speed movie recording and HS movie recording each time the **OK** button is pressed.
- If recording time for HS movies (165) runs out, the camera switches to normal speed movie recording.
- When recording HS movies, the maximum movie length display changes and displays the amount of recording time available for HS movie recording.
- The HS movie options that are displayed change depending on the type of movie being recorded.



When recording normal speed movies



When recording HS movies





3 Press the **●** (movie-record) button to end recording.

✓ Notes on HS Movie

- Footage recorded for slow motion or fast motion playback is not recorded with sound.
- Vibration reduction cannot be used for movies that are recorded while the movie mode switch is rotated to HS. Zoom position, focus, exposure and white balance are locked when the  (movie-record) button is pressed to start recording.

🔍 HS Movie

Recorded movies are played back at about 30 frames per second, including portions recorded using HS movie.

When **HS movie options** (📖 165) is set to  **240 fps**,  **120 fps** or  **60 fps**, movies that can be played back in slow motion can be recorded. When set to  **15 fps**, movies that can be played back in fast motion at a speed two times faster than normal speed can be recorded.

Portions recorded at **240 fps:**

A movie of up to ten seconds in length is recorded when recording for the purpose of high-speed capturing. Playback is eight times slower.

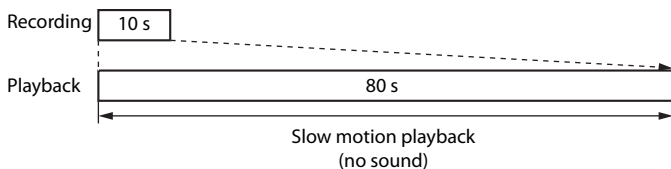

Portions recorded at **15 fps:**



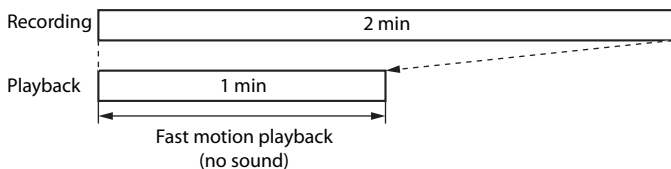

A movie of up to two minutes in length is recorded when recording for the purpose of high-speed playback. Playback is two times faster.



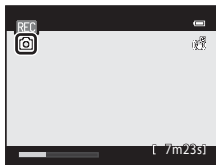





Capturing Still Pictures While Recording Movies

If the shutter-release button is pressed all the way while recording a movie, one frame is saved as a still picture. Movie recording continues while the still picture is being saved.



- A still picture can be saved when  is displayed at the top left of the monitor.
-  is not displayed while saving still pictures. Another still picture cannot be saved until  is displayed again.
- The still picture is saved with **Normal** as the image quality. The image size is determined by the type (resolution) (164) of the original movie.

Movie type (resolution)	Size of still picture
 HD 1080p★ (1920×1080)/  HD 1080p (1920×1080)	 (1920 × 1080)
 HD 720p (1280×720)	 (1280 × 720)
 VGA (640×480)	 (640 × 480)

Notes on Saving Still Pictures During Movie Recording

- When the remaining movie recording time is less than 30 seconds, still pictures cannot be saved.
- When recording an HS movie ()160), still pictures cannot be saved.
- When the movie option is set to **iFrame 540 (960×540)**, still pictures cannot be saved.
- The shutter sound made when saving a still picture may be heard in the recorded movie.
- If the camera moves when the shutter-release button is pressed, the picture may be blurred.

File Names of Saved Still Pictures

The file numbers assigned to captured still pictures ascend in order, starting with the file number of the movie being recorded +1.

More Information

See “File and Folder Names” ()215) for more information.

Using the Movie Menu

The options below can be set in the movie menu.

Movie options

164

Options can be selected for the movie that is recorded when the movie mode switch is rotated to HD.

HS movie options

165

Options can be selected for the movie that is recorded when the movie mode switch is rotated to HS.

Open with HS footage

165

Select whether or not to record slow motion or fast motion movies from the start of the movie recording when the movie mode switch is rotated to HS.

Autofocus mode

166

Choose how the camera focuses when recording movies with the movie mode switch rotated to HD.

Electronic VR

167

Set electronic VR when recording movies with the movie mode switch rotated to HD.

Wind noise reduction

167

Set whether or not to reduce wind noise during movie recording.

Displaying the Movie Menu

Press the **MENU** button in the shooting mode to display the menu, use the multi selector to change to the  tab and display the movie menu (163).

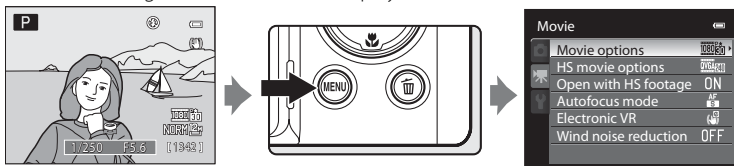





- Use the multi selector to select items and set functions on the menu (162).
- Press the **MENU** button to exit the movie menu.

Movie Options

Display the shooting screen → MENU →  (Movie menu) (📖163) → Movie options

Options can be selected for the movie that is recorded when the movie mode switch is rotated to HD. The higher the resolution and bitrate, the higher the picture quality; but the file size also becomes larger.

Option	Description
 HD 1080p★ (1920×1080) (default setting)	Movies with an aspect ratio of 16:9 are recorded in full high-definition. This option is suited to playback on a wide screen TV that is compatible with full high-definition. <ul style="list-style-type: none"> • Image size: 1920 × 1080 pixels • Movie bitrate: 14 Mbps
 HD 1080p (1920×1080)	Movies with an aspect ratio of 16:9 are recorded in full high-definition. This option is suited to playback on a wide screen TV that is compatible with full high-definition. <ul style="list-style-type: none"> • Image size: 1920 × 1080 pixels • Movie bitrate: 12 Mbps
 HD 720p (1280×720)	Movies with an aspect ratio of 16:9 are recorded in high-definition. This option is suited to playback on a wide screen TV. <ul style="list-style-type: none"> • Image size: 1280 × 720 pixels • Movie bitrate: 9 Mbps
 iFrame 540 (960×540)	Movies with an aspect ratio of 16:9 are recorded. It is one of the formats supported by Apple Inc. <ul style="list-style-type: none"> • Image size: 960 × 540 pixels • Movie bitrate: 24 Mbps
 VGA (640×480)	Movies with an aspect ratio of 4:3 are recorded. <ul style="list-style-type: none"> • Image size: 640 × 480 pixels • Movie bitrate: 3 Mbps

- The movie bitrate is the volume of movie data recorded per second. As a variable bitrate (VBR) system has been adopted, the movie recording rate varies automatically according to the subject so that more data is recorded per second for movies containing frequently moving subjects, thus increasing movie file size.
- The frame rate is approximately 30 frames per second (fps) in all options.

Note on iFrame 540 (960×540)

Saving still pictures during movie recording, saving a frame from a movie as a still picture, or editing movies cannot be used.





More Information

See “Maximum Movie Length” (📖166) for more information.

HS Movie Options

Display the shooting screen → MENU →  (Movie menu) (📖163) → HS movie options

Options can be selected for the movie that is shot when the movie mode switch is rotated to HS (high speed).

Option	Description
 240 fps (default setting)	1/8-speed slow motion movies with an aspect ratio of 4:3 are recorded. <ul style="list-style-type: none"> • Maximum recording time*: 10 seconds (playback time: 1 minute 20 seconds) • Image size: 320 × 240 pixels • Movie bitrate: 640 kbps
 120 fps	1/4-speed slow motion movies with an aspect ratio of 4:3 are recorded. <ul style="list-style-type: none"> • Maximum recording time*: 15 seconds (playback time: 1 minute) • Image size: 640 × 480 pixels • Movie bitrate: 3 Mbps
 60 fps	1/2-speed slow motion movies with an aspect ratio of 16:9 are recorded. <ul style="list-style-type: none"> • Maximum recording time*: 30 seconds (playback time: 1 minute) • Image size: 1280 × 720 pixels • Movie bitrate: 9 Mbps
 15 fps	2× speed fast motion movies with an aspect ratio of 16:9 are recorded. <ul style="list-style-type: none"> • Maximum recording time*: 2 minutes (playback time: 1 minute) • Image size: 1920 × 1080 pixels • Movie bitrate: 12 Mbps

* The maximum recording time refers only to the section shot for slow motion or speeded up playback.





Open with HS Footage

Display the shooting screen → MENU →  (Movie menu) (📖163) → Open with HS footage

Select whether or not to record slow motion or fast motion movies from the start of the movie recording when the movie mode switch is rotated to HS.

- **On** (default setting): HS movies are recorded when recording begins.
- **Off**: Normal speed movies are recorded when recording begins. Press the  button to switch to HS movie recording at the point where the camera should record for slow motion or fast motion playback.

Maximum Movie Length

Option	Memory card (4GB)*
 HD 1080p★(1920×1080) (default setting)	35 min
 HD 1080p (1920×1080)	40 min
 HD 720p (1280×720)	55 min
 iFrame 540 (960×540)	15 min
 VGA (640×480)	2 h 30 min

All figures are approximate. The maximum recording time may vary by make of memory card and the bitrates at which the movie was recorded.

* The maximum movie length for a single movie is 4 GB or 29 minutes, even when there is sufficient free space on the memory card. The maximum movie length for a single movie is displayed during recording.



More Information

See “File and Folder Names” (📖215) for more information.

Autofocus Mode

Display the shooting screen → MENU →  (Movie menu) (📖163) → Autofocus mode

Choose how the camera focuses when recording movies with the movie mode switch rotated to HD.

Option	Description
 Single AF (default setting)	Focus is locked when the  (movie-record) button is pressed to start recording. Select this option when the distance between the camera and the subject will remain fairly consistent.
 Full-time AF	The camera focuses continuously during movie recording. Select this option when the distance between the camera and subject will change significantly during recording. Use of Single AF is recommended to prevent the sound of the camera focusing from interfering with recording.

Autofocus Mode during Movie Shooting

- When the scene mode is **Fireworks show**, the focus is fixed at infinity.
- Set the focus mode to **MF** (manual focus) and adjust the focus using manual focus (📖42).

Electronic VR

Display the shooting screen → MENU →  (Movie menu) (📖163) → Electronic VR

Set electronic VR when recording movies with the movie mode switch rotated to HD.

Option	Description
 On (default setting)	Reduces the effects of camera shake in movie modes.
OFF Off	Electronic VR is not enabled.

When the electronic VR is set to **On**,  is displayed on the monitor when movie recording starts (📖8).

Note on Electronic VR

Electronic VR is not available when recording HS movies.

Wind Noise Reduction

Display the shooting screen → MENU →  (Movie menu) (📖163) → Wind noise reduction

Set whether or not to reduce wind noise during movie recording.

Option	Description
 On	Records while minimizing the noise of wind blowing on the microphone. Suitable for recording in strong winds. During playback, not only wind noise, but other sounds may also become difficult to hear.
OFF Off (default setting)	Wind noise is not reduced.

When the wind noise reduction setting is enabled, the current setting is displayed during shooting (📖8). When **Off** is selected, an icon for the current setting is not displayed.

Movie Playback

In full-frame playback mode (134), movies can be recognized by a movie options icon (164). To play a movie, press the **OK** button.

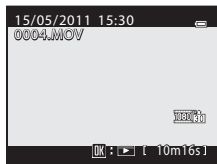

Use the zoom control **T** or **W** during playback to adjust the volume.

Rotate the command dial to advance or rewind the movie. Playback controls appear at the top of the monitor. Press the multi selector **◀** or **▶** to choose a playback control, then press the **OK** button to perform the selected operation. The following operations are available.

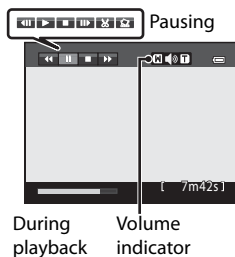

To	Use	Description
Rewind		Rewind the movie while the OK button is pressed down.
Advance		Advance the movie while the OK button is pressed down.
Pause		The following operations can be performed with the playback controls at the top of the monitor while playback is paused.
		Rewind the movie by one frame. Hold down the OK button to rewind continuously.*
		Advance the movie by one frame. Hold down the OK button to advance continuously.*
		Extract and save only the required parts of the movie (169).
		Save the extracted frame from a movie as a still picture (170).
		Resume playback.
End		Return to full-frame playback mode.

* The movie can also be advanced or rewound by one frame by rotating the command dial.





Note on Movie Playback

Movies recorded with cameras other than COOLPIX P500 cannot be played back.

Editing Movies



The desired portions of a recorded movie can be saved as a separate file (except for movies recorded with  **iFrame 540 (960x540)**).





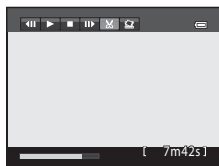

1 Play back the movie to be edited and pause at the start point of the portion that is to be extracted (168).

2 Use the multi selector  or  to choose  on the playback control and press the  button.



- The movie editing screen is displayed.





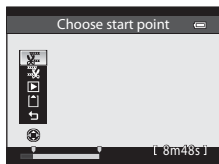

3 Press  or  to choose  (Choose start point) on the editing playback control.





- Press the multi selector  or  to adjust the start position.
- To cancel, press  or  to choose  (Back) and press the  button.

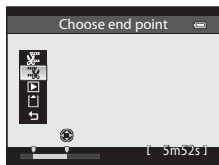

4 Press  or  to choose  (Choose end point).

- Press the multi selector  or  to move the end point at the right end to the end position of the required section.
- To check the playback of the movie in the specified range before saving it, choose  (Preview) and press the  button. During preview playback, the volume can be adjusted with the zoom control **T/W**. Rotate the command dial to fast forward or rewind. To stop the preview playback, press the  button.



5 After finishing the settings, press  or  to choose  (Save) and press the  button.

6 Choose **Yes** and press the  button.

- The edited movie is saved.
- To cancel the saving, choose **No**.

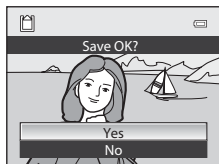

✓ Notes on Editing Movies



- Once a movie is created through editing, it cannot be used again for extracting a movie. To extract another range, select and edit the original movie.
- Because the edited movies are extracted in 1-second units, they may vary slightly from the set start point and end point. Sections shorter than two seconds cannot be extracted.
- Editing functions are not available when there is not enough free space in the internal memory or on the memory card.

📄 More Information

See "File and Folder Names" (📖215) for more information.

Saving a Frame from a Movie as a Still Picture

A frame from a recorded movie can be extracted and saved as a still picture (except for movies recorded with  **iFrame 540 (960×540)**).

- Pause a movie and display the screen to be extracted (📖168).
- Choose  on the playback control with the multi-selector ◀ or ▶ and press the  button.
- When the confirmation dialog is displayed, choose **Yes** and press the  button to save. To cancel the saving, choose **No**.
- The still picture is saved with **Normal** as the image quality. The image size is determined by the type (resolution) (📖162, 164, 165) of the original movie.

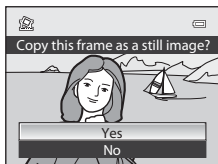
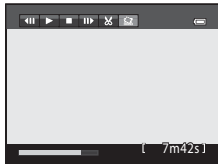

✓ Note on Saving a Still Picture

A black frame appears around the picture saved with  (320×240) during playback.

Deleting Unnecessary Movies

Press the  button when a movie is selected in full-frame playback mode (📖34) or thumbnail playback mode (📖115) to display the confirmation dialog for deletion. See "Deleting Unnecessary Images" (📖35) for more information.

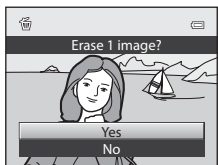

Connecting to a TV

Connect the camera to a television to play back pictures on the television. If your television is equipped with an HDMI connector, you can connect it to the camera with a commercially available HDMI cable to enjoy recorded movies in the high-definition quality.

- 1 Turn off the camera.

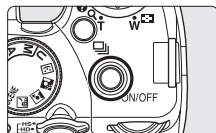

- 2 Connect the camera to the TV.

When connecting using the supplied audio/video cable

- Connect the yellow plug to the video-in jack on the TV, and the red and white plugs to the audio-in jacks.

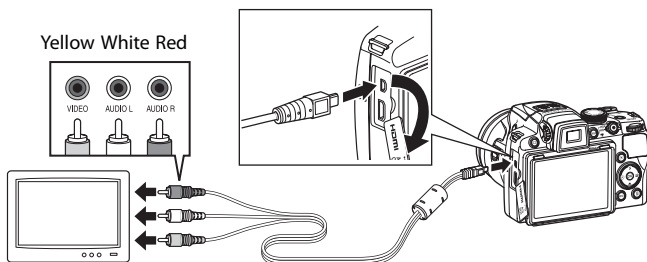

When connecting using a commercially available HDMI cable

- Connect the plug to the HDMI jack on the TV.

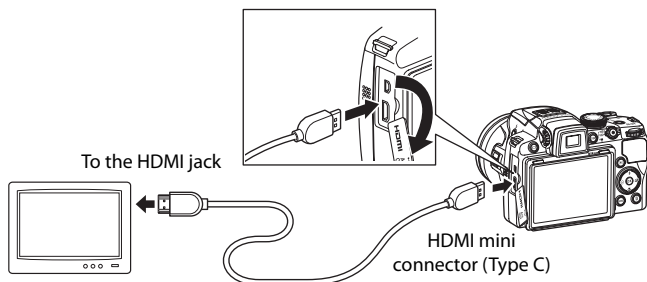

3 Tune the television to the video channel.



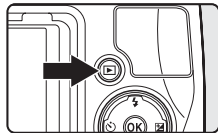

- See the documentation provided with your television for details.

4 Hold down the button to turn on the camera.

- The camera enters playback mode, and the recorded pictures are displayed on the television.
- While the camera is connected to the TV, the camera monitor remains off.



Notes on Connecting an HDMI Cable

- An HDMI cable is not supplied. Use a commercially available HDMI cable to connect the camera to a TV. The output terminal on this camera is a HDMI Mini Connector (Type C). When purchasing an HDMI cable, be sure that the device end of the cable is a HDMI Mini Connector.
- To enjoy playback in high-definition quality when the camera is connected to a television that has an HDMI connector, we recommend shooting still pictures with **Image size** (84) set to  **2048x1536** or higher, and recording movies with **Movie options** (164) set to  **HD 720p (1280x720)** or higher.

Notes on Connecting the Audio/Video Cable

- When connecting the cable, be sure that the connector is oriented correctly. Do not force the connector into the camera. When disconnecting the cable, do not pull the connector at an angle.
- Do not connect cables to the HDMI mini connector and USB/audio video connector simultaneously.

When Nothing Appears on the TV

Make sure that **TV settings** (201) in the setup menu (185) is appropriate for your television.

Using the TV's Remote Control (HDMI Device Control)

The remote control of a TV that conforms to the HDMI-CEC standard can be used to operate the camera during playback.

Instead of the multi selector or zoom control, the remote control can be used for picture selection, playback/pause of movies or easy panorama pictures, and switching between full-frame playback and 4-picture thumbnail display.

- Set **HDMI device control** (201) of **TV settings** to **On** (default setting) in the setup menu, and connect the camera to the TV with an HDMI cable.
- Point the remote control at the TV to operate.
- See your TV's manual or other related documentation to check whether your TV supports the HDMI-CEC standard.

Connecting to a Computer

Use the supplied USB cable to connect the camera to a computer and copy (transfer) images to the computer.

Before Connecting the Camera

Install the Software

Use the supplied ViewNX 2 CD and install the following software on the computer. For more information on installing the software, refer to the *Quick Start Guide*.

- ViewNX 2: Use the image transfer feature “Nikon Transfer 2” to save images that were captured with the camera on the computer. Saved images can be viewed and printed. Image and movie editing features are also supported.
- Panorama Maker 5: This software can join a series of images to create a single panorama image.

Compatible Operating Systems

Windows

Windows 7 Home Basic/Home Premium/Professional/Enterprise/Ultimate, Windows Vista Home Basic/Home Premium/Business/Enterprise/Ultimate (Service Pack 2), or Windows XP Home Edition/Professional (Service Pack 3)

Macintosh

Mac OS X (version 10.4.11, 10.5.8, 10.6.5)

For information on the requirements for playing back high-definition movies, refer to “System Requirements” in the ViewNX 2 help information (📖177).

Refer to the Nikon website for the latest information on operating system compatibility.

Note on Computer Connection

Disconnect other USB devices such as commercial USB chargers from the computer. Simultaneous connection of the camera and other USB devices to the computer could result in operation malfunction or excessive supply of power to the camera, causing damage to the camera or memory card. Refer to the documentation supplied with other USB devices for more information.

Connecting to a Computer

✔ Notes on Power Source

- When connecting the camera to a computer, use a battery with a sufficient amount of charge remaining to prevent the camera from turning off unexpectedly.
- When the camera is connected to a computer via the supplied USB cable with **Auto** (default setting) selected for the **Charge by computer** option in the setup menu, the battery inserted into the camera is automatically charged using power supplied by the computer (178, 202).
- If the AC Adapter EH-62A (213) (available separately) is used, COOLPIX P500 can be powered from an electrical outlet. Do not use another make or model of AC adapter other than EH-62A. Failure to observe this precaution could result in overheating or in damage to the camera.

Transferring Images from a Camera to a Computer

- 1 Start the computer to which ViewNX 2 was installed.
- 2 Be sure that the camera is off.
- 3 Connect the camera to the computer using the supplied USB cable.

Be sure that connectors are properly oriented. Do not attempt to insert connectors at an angle, and do not use force when connecting or disconnecting the USB cable.

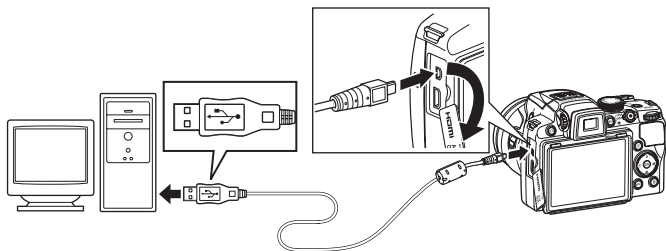

The camera is automatically turned on and the power-on lamp will light or blink. The camera monitor will remain off.

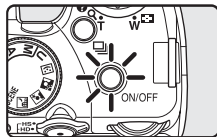

✔ Connecting the USB Cable

The connection may not be recognized if the camera is connected to the computer via a USB hub.

4 Start the ViewNX 2 image transfer feature “Nikon Transfer 2” installed on the computer.

- **Windows 7**

When the **Devices and Printers ► P500** screen is displayed, click **Change program** under **Import pictures and videos**. Select **Import File using Nikon Transfer 2** in the **Change program** dialog and click **OK**.

Double-click **Import File** on the **Devices and Printers ► P500** screen.

- **Windows Vista**

When the **AutoPlay** dialog is displayed, click **Import File using Nikon Transfer 2**.

- **Windows XP**

When the action selection dialog is displayed, select **Nikon Transfer 2 Import File**, and click **OK**.

- **Mac OS X**

Nikon Transfer 2 will start automatically when the camera is connected to the computer if **Yes** was selected in the **Auto-Launch setting** dialog when ViewNX 2 was first installed.

- See “Starting Nikon Transfer 2 Manually” (📖 177) for more information.

- If charge for the battery inserted into the camera is low, the computer may not recognize the camera. If the camera is not recognized, images will not be transferred. When battery charging starts automatically using power supplied by the computer, wait until battery charge has reached a sufficient level to begin transfer.

- If there are a large number of images on the memory card, it may take some time for Nikon Transfer 2 to start.

5 Confirm that the source device is displayed in the transfer options **Source** panel and click **Start Transfer**.

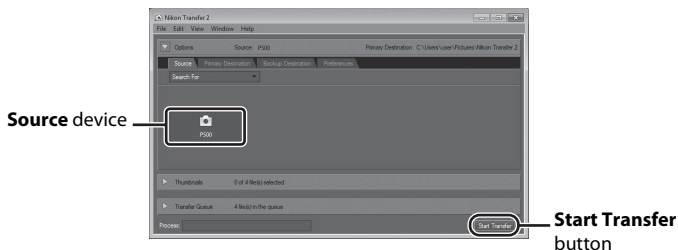

Any images that have not been transferred to the computer will be transferred (default setting of ViewNX 2).

Connecting to a Computer

When transfer is complete, the ViewNX 2 screen is displayed (ViewNX 2 default setting) and transferred images are displayed.

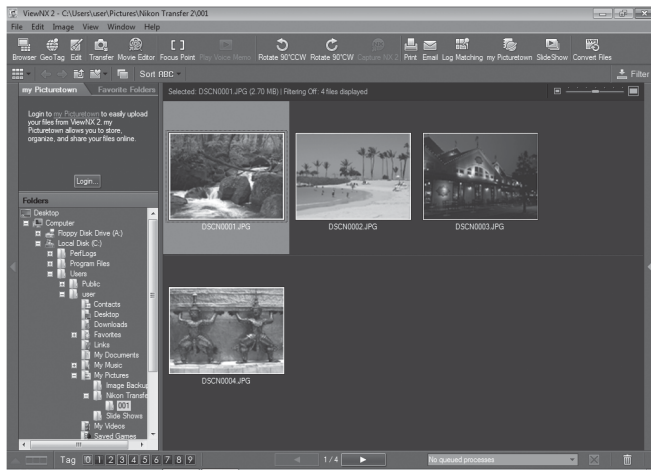

For more information on using ViewNX 2, refer to the ViewNX 2 help information (177).

Disconnecting the Camera

Do not turn off the camera or disconnect the camera from the computer during transfer.

When transfer is complete, turn off the camera and disconnect the USB cable.

The camera turns off automatically if there is no communication with the computer for 30 minutes while the camera is connected via the USB cable.

Charging the Battery

The power-on lamp slowly blinks orange while the battery inserted into the camera is charging (178).

Transferring Images Using a Computer's Card Slot or a Commercially-available Card Reader

When the memory card is inserted into a computer's card slot or into a commercially-available card reader, the images can be transferred using "Nikon Transfer 2", the image transfer feature of ViewNX 2.

- Make sure that the memory card being used is supported by the card reader or other card reading device.
- To transfer images, insert the memory card into the card reader or card slot and follow the procedure from step 4 (📖175).
- To transfer images saved in the camera's internal memory, the images must first be copied to a memory card using the camera (📖144).

Starting ViewNX 2 Manually

Windows

Choose **Start** menu > **All Programs** > **ViewNX 2** > **ViewNX 2**.

Double-clicking the **ViewNX 2** shortcut icon on the desktop will also start ViewNX 2.

Mac OS X

Open the **Applications** folder, open the **Nikon Software** > **ViewNX 2** folders in that order, and then double-click the **ViewNX 2** icon. Clicking the **ViewNX 2** icon on the Dock will also start ViewNX 2.

Starting Nikon Transfer 2 Manually

To start Nikon Transfer 2, first start ViewNX 2, and then click the **Transfer** icon at the top of the screen or select **Launch Transfer** from the **File** menu.

For More Information on Using ViewNX 2 and Nikon Transfer 2

For more information on ViewNX 2 or Nikon Transfer 2, start ViewNX 2 or Nikon Transfer 2 and select **ViewNX 2 Help** from the **Help** menu.

Panorama Creation with Panorama Maker 5

- Use a series of images captured with **Panorama assist** in the **Panorama** scene mode (📖58) to create a single panorama photo with Panorama Maker 5.
- Panorama Maker 5 can be installed on a computer using the supplied ViewNX 2 CD.
- After installation is complete, follow the procedure described below to start Panorama Maker 5.

Windows

Choose **Start** menu>**All Programs**>**ArcSoft Panorama Maker 5**>**Panorama Maker 5**.

Mac OS X

Open **Applications** and double-click the **Panorama Maker 5** icon.

- For more information on using Panorama Maker 5, refer to the on-screen instructions and help information contained in Panorama Maker 5.

Image File Names and Folder Names

See "File and Folder Names" (📖215) for more information.

Charging While Connecting to a Computer

When the **Charge by computer** option (📖202) in the camera's setup menu is set to **Auto** (default setting), if the camera is connected to a computer using the USB cable, the battery inserted into the camera can be automatically charged depending on the ability of the computer to supply power.

See "Before Connecting the Camera" (📖173) and "Transferring Images from a Camera to a Computer" (📖174) for more information on connecting the camera to a computer.

Power-on Lamp

The following chart explains power-on lamp status when the camera is connected to a computer.

Power-on lamp	Description
Blinks slowly (orange)	Battery charging.
Lights (green)	Battery not charging. Charging is complete when the power-on lamp stops slow-blinking (orange) and starts lighting (green).
Flickers (orange)	<ul style="list-style-type: none"> The ambient temperature is not suited to charging. Charge the battery indoors with an ambient temperature of 5 °C to 35 °C (41 °F to 95 °F). A USB cable is not correctly connected or the battery is faulty. Reconnect the USB cable correctly or replace the battery. Computer is in sleep mode and does not supply power. Reboot the computer. The battery cannot be charged as computer's specifications or settings does not support power supply to the camera.

✓ Notes on Charging with Connection to a Computer

- The battery cannot be charged, nor can data be transferred, when the camera is connected to a computer before the camera's display language and date and time have been set (📖24). If the camera's clock battery (📖189) has been exhausted, the date and time must be reset before the battery can be charged or images can be transferred with connection to a computer. In this case, use the Charging AC Adapter EH-69P (📖20) to charge the battery and then set the camera's date and time.
- If the camera is turned off, charging will also stop.
- If a computer enters sleep mode while charging, charging will stop and the camera may be turned off.
- When disconnecting the camera from a computer, turn the camera off and then disconnect the USB cable.
- About five hours and 30 minutes are required to charge a fully exhausted battery. Charging time increases when images are transferred while the battery is charging.
- When the camera is connected to a computer, an application installed on the computer, such as Nikon Transfer 2, may start. If the camera was connected to the computer for the sole purpose of charging the battery, exit the application.
- The camera turns off automatically if there is no communication with the computer for 30 minutes after the battery has finished charging.
- Depending upon computer specifications, settings, and power supply and allocation, it may be impossible to charge the battery inserted into the camera via computer connection.

Connecting to a Printer

Users of PictBridge-compatible (📖233) printers can connect the camera directly to the printer and print pictures without using a computer. Follow the procedures below to print pictures.

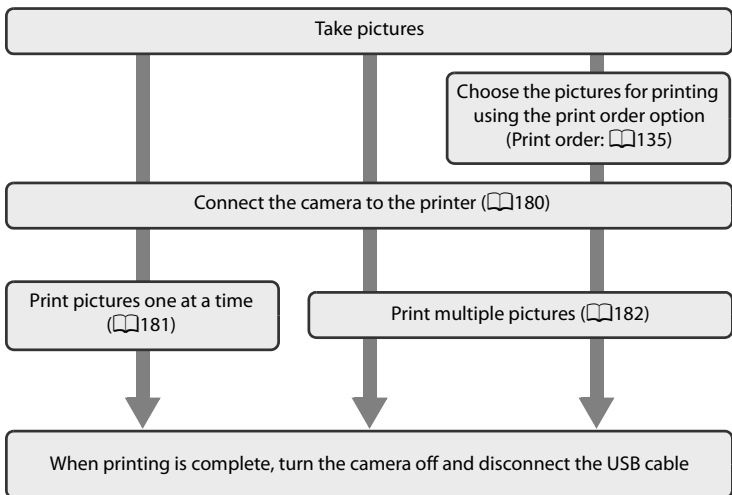

✓ Notes on Power Source

- When connecting the camera to a printer, use a fully charged battery to prevent the camera from turning off unexpectedly.
- If the AC Adapter EH-62A (available separately) (📖213) is used, COOLPIX P500 can be powered from an electrical outlet. Do not use any other make or model of AC adapters as they may cause the camera to heat up or malfunction.

🔍 Printing Pictures

In addition to printing pictures transferred to a computer and printing pictures with a direct camera-to-printer connection, the following options are also available for printing pictures recorded on the memory card:

- Insert a memory card into a DPOF-compatible printer's card slot.
- Take a memory card to a digital photo lab.

For printing using these methods, you can specify the pictures and the number of prints each using the **Print order** (📖135) option in the playback menu.

Connecting the Camera and Printer

1 Turn off the camera.

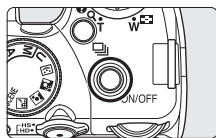

2 Turn on the printer.

- Check the printer settings.

3 Connect the camera to the printer using the supplied USB cable.

- Be sure that connectors are properly oriented. Do not attempt to insert connectors at an angle, and do not use force when connecting or disconnecting the USB cable.

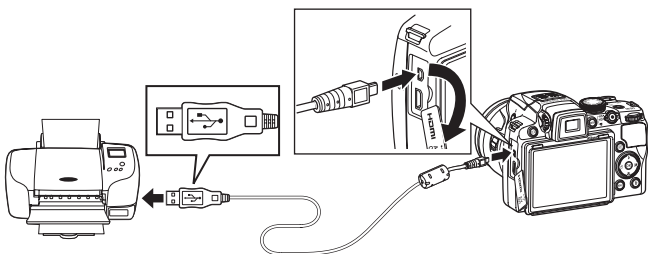

4 The camera is automatically turned on.

- When connected correctly, the **PictBridge** startup screen (①) is displayed in the camera monitor. Then the **Print selection** screen (②) is displayed.

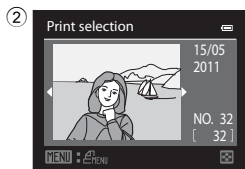
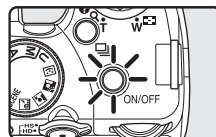

✔ If the PictBridge Startup Screen Is Not Displayed

Turn the camera off and disconnect the USB cable. Set the **Charge by computer** option (📖202) in the camera's setup menu to **Off** and reconnect the cable.

Printing Pictures One at a Time

After connecting the camera to the printer correctly (📖180), print pictures by following the procedure below.

1 Use the multi selector to choose the picture to be printed and press the **OK** button.

- Pictures can also be chosen by rotating the command dial.
- Rotate the zoom control toward **W** (📐) to display 12 thumbnails, or toward **T** (📺) to switch back to full-frame playback.

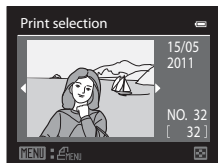

2 Choose **Copies** and press the **OK** button.

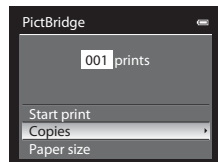

3 Choose the number of copies (up to nine) and press the **OK** button.



4 Choose **Paper size** and press the **OK** button.

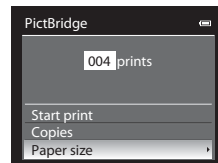

More Information

See "Note on Printing Images of Size 1:1" (📖86) for more information.

5 Choose the desired paper size and press the **OK** button.

- To specify the paper size using the printer settings, choose **Default** in the paper size menu.

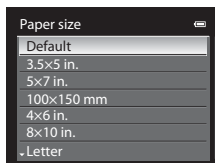

6 Choose **Start print** and press the **OK** button.

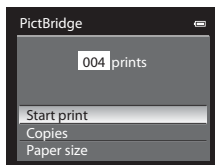

7 Printing starts.

- The monitor display returns to that shown in step 1 when printing is complete.
- To cancel before all copies have been printed, press the **OK** button.

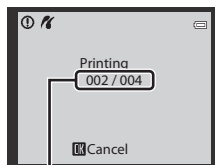

Current print/total number of prints

Printing Multiple Pictures

After connecting the camera to the printer correctly (180), print pictures by following the procedure below.

1 When the **Print selection** screen is displayed, press the **MENU** button.

- The **Print menu** is displayed.

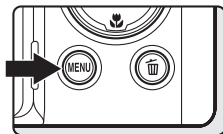

2 Use the multi selector to choose **Paper size** and press the **OK** button.

- To exit the print menu, press the **MENU** button.

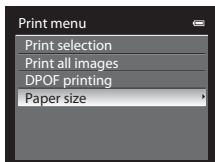

3 Choose the desired paper size and press the **OK** button.

- To specify the paper size using the printer settings, choose **Default** in the paper size menu.

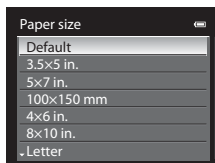

4 Choose **Print selection**, **Print all images** or **DPOF printing** and press the **OK** button.

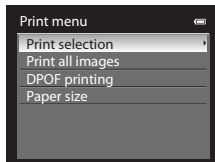

Print selection

Choose the pictures (up to a maximum of 99) and number of copies (up to nine per picture).

- Press the multi selector **◀** or **▶** to choose the pictures, and press **▲** or **▼** to set the number of copies for each.
- Pictures can also be chosen by rotating the command dial.
- Pictures selected for printing can be recognized by the check mark icon and the numeral indicating the number of copies to be printed. A check mark is not displayed with pictures for which no copies have been specified and these pictures are not printed.
- Rotate the zoom control toward **T** (Q) to switch to full-frame playback, or **W** (E) to switch to 12 thumbnails display.
- Press the **OK** button when setting is complete.
- When the menu shown on the right is displayed, choose **Start print** and press the **OK** button to start printing.
- Choose **Cancel** and press the **OK** button to return to the print menu.

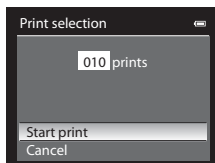
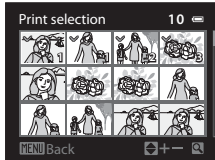

Print all images

All pictures stored in the internal memory or on the memory card are printed one per each.

- When the menu shown on the right is displayed, choose **Start print** and press the **OK** button to start printing.
- Choose **Cancel** and press the **OK** button to return to the print menu.

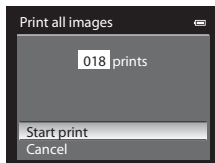

DPOF printing

Pictures for which a print order was created in the **Print order** option (📄 135) can be printed.

- When the menu shown on the right is displayed, choose **Start print** and press the **OK** button to start printing.
- Choose **Cancel** and press the **OK** button to return to the print menu.
- To view the current print order, choose **View images** and press the **OK** button. To print pictures, press the **OK** button again.

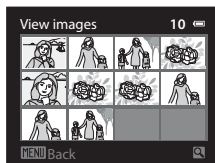
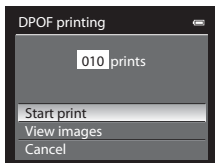

5 Printing starts.

- The monitor display returns to that shown in step 2 when printing is complete.
- To cancel before all copies have been printed, press the **OK** button.

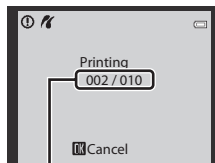

Current print/total number of prints

Paper Size

The camera supports the following paper sizes: **Default** (the default paper size for the current printer), **3.5×5 in.**, **5×7 in.**, **100×150 mm**, **4×6 in.**, **8×10 in.**, **Letter**, **A3**, and **A4**. Only sizes supported by the current printer are displayed.

Setup Menu

The setup menu contains the following options.

Welcome screen	187
Choose whether or not to display the Welcome screen on the monitor when the camera is turned on.	
Time zone and date	188
Set camera clock and choose home and destination time zones.	
Monitor settings	191
Set the image review, the monitor brightness, and the framing grid and histogram display during shooting.	
Print date	192
Imprint date and time of recording on pictures.	
Vibration reduction	193
Set the vibration reduction for taking still pictures.	
Motion detection	195
Enable motion detection to reduce the effects of camera shake and subject movement when shooting still pictures.	
AF assist	196
Enable or disable AF-assist illuminator.	
Red-eye reduction	196
Choose the red-eye reduction method when the flash mode is auto with red-eye reduction.	
Digital zoom	197
Enable or disable the digital zoom.	
Assign side zoom control	198
Choose the function to be performed during shooting when the side zoom control is rotated.	
Sound settings	199
Adjust sound settings.	
Auto off	199
Set the time before the camera enters standby mode to save power.	
Format memory/Format card	200
Format the internal memory or memory card.	
Language	201
Choose the language used for the camera monitor display.	
TV settings	201
Adjust the settings for connecting to a TV.	
Charge by computer	202
Choose whether or not to charge the camera battery when connecting to a computer via the USB cable.	

Setup Menu

Reset file numbering

📖 202

Reset the file numbering.

Blink warning

📖 203

Choose whether or not to detect blinking eyes when shooting pictures using face priority.

Reset all

📖 205

Restore camera settings to default values.

Firmware version

📖 208

Display the camera firmware version.

Displaying the Setup Menu

Choose the  (Setup) tab in the menu screen.

- 1 Press the **MENU** button to display the menu screen.

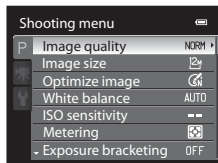
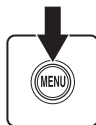

- 2 Press  on the multi selector.

- The tabs can now be selected.
- See “Multi Selector” (📖12).

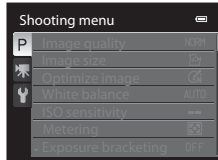

- 3 Press  or  to select the  tab.

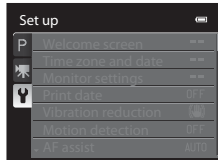

4 Press **▶** or the **OK** button.

- The setup menu items can now be selected.
- Use the multi selector to select items and set functions on menus (📖112).
- To exit the setup menu, press the **MENU** button or press **◀** and switch to another tab.

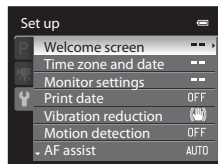

Welcome Screen

Press the **MENU** button → **Y** (Setup menu) (📖186) → Welcome screen

Choose whether or not to display the Welcome screen on the monitor when the camera is turned on.

None (default setting)

Displays the shooting or playback screen without displaying the Welcome screen.

COOLPIX

Displays the Welcome screen before displaying the shooting or playback screen.

Select an image

Select a picture that you have shot to display as the Welcome screen. Display the picture selection screen, choose a picture (📖140), and press the **OK** button to register it.

- Because the selected picture is stored in the camera, the picture appears in the Welcome screen even if the original picture is deleted.
- Pictures shot with **Image size** (📖84) of **3984×2656**, **3968×2232**, **1920×1080** and **2992×2992** cannot be selected.
- Pictures recorded with easy panorama cannot be selected.
- Pictures reduced to 160×120 or smaller using Small picture editing (📖154) or cropping (📖156) cannot be selected.

Time Zone and Date

Press the **MENU** button → **Y** (Setup menu) (📖186) → Time zone and date

Set the camera's internal clock.

Date and time

Set the camera clock to the current date and time.
Use the multi selector to set the date and time.

- Choose an item: Press **▶** or **◀** (selected in the following order: **D** (day) → **M** (month) → **Y** (year) → **hour** → **minute**).
- Set the contents: Press **▲** or **▼**. Date and time can also be set by rotating the command dial (📖11).
- Finish setting: Choose **minute** and press the **OK** button or **▶**.

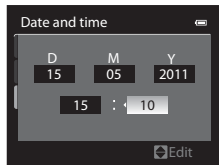

Date format

Choose the order in which the day, month, and year are displayed (**Year/Month/Day**, **Month/Day/Year** or **Day/Month/Year**).

Time zone

- 🏠 Home time zone can be specified and daylight saving can be enabled or disabled. When **▶** travel destination is registered, the time difference (📖190) from the
- 🏠 home time zone is automatically calculated and the local date and time are recorded. Useful when traveling.

Setting the Travel Destination Time Zone

1 Use the multi selector to choose **Time zone** and press the **OK** button.

- The **Time zone** screen is displayed.

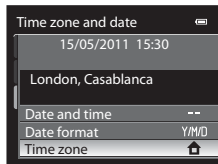

2 Choose **▶** **Travel destination** and press the **OK** button.

- The date and time displayed on the monitor change according to the region currently selected.

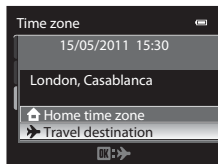

3 Press ►.

- The time zone selection screen is displayed.

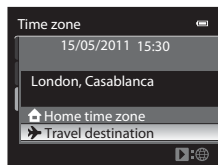

4 Press ◀ or ▶ to choose the travel destination (Time zone).

- The time difference between home and the travel destination is displayed.
- When using the camera in an area where daylight saving time is in effect, turn on the daylight saving setting with ▲. When set to on, the ☀ icon is displayed and the clock advances by one hour. To turn off, press ▼.
- Press the OK button to register the travel destination time zone.
- While the travel destination time zone is selected, the 📍 icon is displayed on the monitor when the camera is in shooting mode.

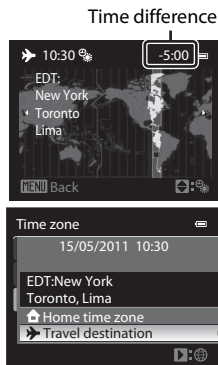

✓ The Clock Battery

The camera's internal clock uses a different battery from the camera's battery. The clock battery charges when the main battery is installed or the AC adapter is connected, and provides several days of clock battery power after about ten hours of charging.

📌 Home time zone

- To switch to the home time zone, choose 🏠 **Home time zone** in step 2 and press the OK button.
- To change the home time zone, choose 🏠 **Home time zone** in step 2 and perform the same procedure as for ➡ **Travel destination** to set the home time zone.

📌 Daylight Saving Time

When daylight saving time starts or ends, turn on or off the daylight saving time option from the time zone selection screen displayed in step 4.

📌 Imprinting the Date on Pictures while Shooting

After setting the date and time, set the **Print date** setting in the setup menu (📖192). Once **Print date** is set, the shooting date and time can be imprinted on the pictures.



**Time Zones**

The camera supports the time zones listed below.

For time differences not listed below, set the camera clock using **Date and time**.

UTC +/-	Location	UTC +/-	Location
-11	Midway, Samoa	+1	Madrid, Paris, Berlin
-10	Hawaii, Tahiti	+2	Athens, Helsinki, Ankara
-9	Alaska, Anchorage	+3	Moscow, Nairobi, Riyadh, Kuwait, Manama
-8	PST (PDT): Los Angeles, Seattle, Vancouver	+4	Abu Dhabi, Dubai
-7	MST (MDT): Denver, Phoenix	+5	Islamabad, Karachi
-6	CST (CDT): Chicago, Houston, Mexico City	+5.5	New Delhi
-5	EST (EDT): New York, Toronto, Lima	+6	Colombo, Dhaka
-4.5	Caracas	+7	Bangkok, Jakarta
-4	Manaus	+8	Beijing, Hong Kong, Singapore
-3	Buenos Aires, Sao Paulo	+9	Tokyo, Seoul
-2	Fernando de Noronha	+10	Sydney, Guam
-1	Azores	+11	New Caledonia
±0	London, Casablanca	+12	Auckland, Fiji

Monitor Settings

Press the **MENU** button →  (Setup menu) (186) → Monitor settings

Change the settings for the options below.

Image review

On (default setting): Picture is automatically displayed on the monitor immediately after it is taken and the monitor display returns to shooting mode.

Off: Picture is not displayed after it is taken.

Brightness

Choose from five settings for monitor brightness. The default setting is **3**.

View/hide framing grid

On: A framing grid is displayed to help frame pictures.

Off (default setting): Framing grid is not displayed.

View/hide histograms

On: Histograms are displayed in the shooting mode even when the exposure compensation is not being set (43).

Off (default setting): Histograms are not displayed.

Note on View/hide Framing Grid

Framing grid is not displayed in the following situations.

- When tracking a subject (after a subject is registered)
- When recording a movie
- When the enlarged center of the picture is displayed in **MF** (manual focus)

Note on View/hide Histograms

Histograms are not displayed in the following situations.

- When recording a movie
- When the enlarged center of the picture is displayed in **MF** (manual focus)
- When the flash mode, self-timer or focus mode menu is displayed
- When the continuous menu is displayed
- When the face detection function is selected
- When the subject tracking is selected in **AF area mode**

Print Date

Press the **MENU** button →  (Setup menu) (📖186) → Print date

The shooting date and time can be imprinted on pictures at the time of shooting. This information can be printed even from printers that do not support printing of the date and time (📖136).



Date

The date is imprinted on pictures.

Date and time



The date and time are imprinted on pictures.

OFF Off (default setting)

The date and time are not imprinted on pictures.

When Print date is enabled, the current setting is displayed during shooting (📖8). When **Off** is selected, an icon for the current setting is not displayed.

Notes on Print Date

- Imprinted dates cannot be deleted from the image, nor can dates be imprinted after the picture has been taken.
- Dates cannot be imprinted in the following situations.
 - When the scene mode (📖45) is set to  (Night landscape) or  (Night portrait) with **Hand-held**,  (Backlighting) with **HDR** set to **On**, **Sports**, **Museum**, **Panorama**, or **Pet portrait** with **Continuous**
 - When continuous (📖76) is set to **Continuous H**, **Continuous L**, **Pre-shooting cache**, **Continuous H: 120 fps**, **Continuous H: 60 fps**, or **BSS**
 - When **Exposure bracketing** (📖94) is used
 - When **Smile timer** (📖67) or **Blink proof** (📖68) is set to **On** in smart portrait mode
 - During movie recording
- Dates imprinted with an **Image size** (📖84) setting of **VGA 640×480** may be difficult to read. Set the Image size to **PC 1024×768** or higher.
- The date is recorded using the format selected in the setup menu's **Time zone and date** option (📖24, 188).

Print date and Print order

When printing from DPOF-compatible printers that support the printing of shooting date and photo information, the date and information can be printed without imprinting this information on them using settings in the **Print order** option (📖135).

Vibration Reduction

Press the **MENU** button →  (Setup menu) (📖186) → Vibration reduction

Specify the vibration reduction setting for taking still pictures. Correct blur, caused by slight hand movement known as camera shake, that commonly occurs when shooting with zoom applied or at slow shutter speeds.

When the camera is stabilized for shooting with a tripod, set vibration reduction to **Off**.



On (hybrid)

Records with optical compensation for camera shake during still picture shooting using the image sensor shift method, and under the following conditions, also performs electronic VR using image enhancement.

- When the flash does not fire
- When the shutter speed is slower than 1/30 second (wide-angle position) and 1/250 second (telephoto position).
- When the self-timer is off
- When **Single** is selected for the continuous setting
- When **Off** is selected for the **Exposure bracketing** setting
- When the ISO sensitivity is 200 or less



On (default setting)

Compensates for camera shake during still picture shooting using the image sensor shift method. The camera automatically detects the panning direction and only corrects for vibration caused by camera shake.

When the camera is panned horizontally, for example, vibration reduction only reduces vertical shake. If the camera is panned vertically, vibration reduction only compensates for horizontal shake.



Off

Vibration reduction is not enabled.

When vibration reduction is enabled, the current setting is displayed during shooting (📖8, 29). When **Off** is selected, an icon for the current setting is not displayed.



Compensating Movies with Electronic VR

To reduce the effects of camera shake when recording movies, enable **Electronic VR** (📖167) from the movie menu (📖163).

Notes on Vibration Reduction

- It may take a few seconds to activate vibration reduction after the power is turned on or the camera enters shooting mode from playback mode. Wait until the display stabilizes before shooting.
- Due to characteristics of the vibration reduction function, images displayed in the camera's monitor immediately after shooting may appear blurry.
- Vibration reduction may be unable to completely eliminate the effects of camera shake in some situations.
- When the camera shake is extremely high or low, picture compensation with electronic VR may not be possible even when **On (hybrid)** is set.
- When the shutter speed is fast or extremely slow, electronic VR may not operate even when **On (hybrid)** is set.
- When electronic VR in **On (hybrid)** operates, saving the picture takes longer than normal, because when the picture is shot, the shutter is released twice automatically to perform picture compensation. **Shutter sound** (🔊199) is heard only once. One frame is recorded.

Motion Detection



Press the **MENU** button →  (Setup menu) (📖186) → Motion detection

Enable motion detection to reduce the effects of subject movement and camera shake when shooting still pictures.



Auto

When the camera detects the movement of the subject or camera shake, the ISO sensitivity is raised and the shutter speed is increased to reduce their effects. However, motion detection does not function in the following situations.

- When the fill flash fires
- In the following scene modes:  (Night landscape),  (Night portrait),  (Backlighting), **Sports**, **Dusk/dawn**, **Museum**, **Fireworks show** and **Pet portrait**
- When shooting mode is **P**, **S**, **A**, **M** or **U**

OFF

Off (default setting)

Motion detection is not applied.

When motion detection is enabled, the current setting is displayed during shooting (📖8).

The motion detection icon lights in green when the camera detects any vibration and increases the shutter speed. When **Off** is selected, an icon for the current setting is not displayed.



Notes on Motion Detection

- Motion detection may be unable to completely reduce effects of camera shake and subject movement in some situations.
- Motion detection may not function if the subject exhibits significant movement or is too dark.
- The pictures taken may become grainy.

AF Assist

Press the **MENU** button → **Y** (Setup menu) (📖186) → AF assist

Enable or disable the AF-assist illuminator that assists the autofocus when the lighting is dim.

Auto (default setting)

AF-assist illuminator turns on automatically when the subject is dimly lit. The illuminator has a range of about 6.0 m (19 ft.) at the maximum wide-angle position and about 5.0 m (16 ft.) at the maximum telephoto position. However, for some focus areas and scene modes, AF-assist illuminator does not turn on even if **Auto** is set.

Off

Disable the function. The camera may be unable to focus if lighting is dim.

Red-eye Reduction

Press the **MENU** button → **Y** (Setup menu) (📖186) → Red-eye reduction

Choose the red-eye reduction method when the flash mode (📖36) is  (Auto with red-eye reduction).

Pre-flash on (default setting)

The flash repeatedly fires pre-flashes at low intensity before the main flash to reduce the red-eye effect, and the red-eye reduction process is performed using picture compensation.

Note that there is a slight lag between the shutter-release button being pressed and the picture being shot.

Pre-flash off

Pre-flashes do not fire. The shutter is released immediately when the shutter-release button is pressed all the way, and the red-eye reduction process is performed using picture compensation.

Digital Zoom

Press the **MENU** button → **Y** (Setup menu) (📖186) → Digital zoom





Enable or disable the digital zoom.

On (default setting)

When the camera is zoomed in to the maximum optical zoom position, rotating and holding the zoom control at **T** (📖) triggers the digital zoom (📖31).

Crop



Limit zoom magnification up to the position of  during still picture shooting. Also limit the digital zoom to the range at which image quality of the shot still picture does not deteriorate.

- The digital zoom is not available when Image size is  **4000×3000**,  **3984×2656**,  **3968×2232**,  **1920×1080** or  **2992×2992**.
- During movie recording, digital zoom works as described in **On**.

Off

The digital zoom is not activated.

✓ Notes on Digital Zoom

- When the digital zoom is in effect, AF area mode (📖95) is set to **Center**.
- Digital zoom cannot be used in the following situations.
 - When the focus mode (📖40) is set to **MF** (manual focus)
 - When the scene mode (📖45) is set to  (Night landscape),  (Night portrait), **Scene auto selector**, **Portrait**, or **Pet portrait**
 - When smart portrait mode is selected
 - When **Multi-shot 16** is selected for the continuous (📖76) setting
 - When **Subject tracking** is selected for **AF area mode** (📖95)
- At magnifications of 1.2x to 1.8x, **Metering** is set to **Center-weighted**, and at magnifications of 2.0x to 4.0x, it is set to **Spot**.

Assign Side Zoom Control

Press the **MENU** button → **Y** (Setup menu) (📖186) → Assign side zoom control

Choose the function to be performed during shooting when the side zoom control is used.

Zoom (default setting)

When shooting, use the side zoom control (📖31) to adjust the zoom.

Manual focus

When the focus mode is set to **MF** (manual focus), use the side zoom control to focus (📖42).

- Use the side zoom control in the direction of **T** to focus on distant subjects.
- Use the side zoom control in the direction of **W** to focus on near subjects.

Snap-back zoom

This is convenient when shooting at the telephoto position, when it is more difficult to keep subjects in focus.

Use the side zoom control in the direction of **W** to zoom a specific increment from the current zoom position toward the **W** side. Use it in the direction of **W** again to move the zoom position further toward **W** side. Use it in the direction of **T** to return to the original zoom position, before the side zoom control was used.

- When using the digital zoom, use the side zoom control in the direction of **W** to move to the telephoto end of the optical zoom.
- If you perform any operation other than the side zoom control, the zoom is not returned to the zoom position before the operation.
- **Snap-back zoom** is not available during movie recording.

Sound Settings

Press the **MENU** button → **Y** (Setup menu) (📖186) → **Sound settings**

Adjust the following sound settings.

Button sound

Turn the beep and start-up sounds **On** (default setting) or **Off**. The beep sounds once when the settings are completed successfully, twice when the camera focuses on the subject, and three times when an error is detected.

Shutter sound

Choose whether to set the shutter sound to **On** (default setting) or **Off**.

✔ Notes on Sound Settings

- In **Pet portrait** scene mode, even when **On** is set, the button sound and shutter sound are disabled.
- Even when **On** is set, the shutter sound is disabled during continuous shooting or movie recording.

Auto Off

Press the **MENU** button → **Y** (Setup menu) (📖186) → **Auto off**

If no operations are performed for a certain period while the camera is on, the monitor is turned off to save power and the camera enters standby mode (📖23). In this menu, set the time before the camera enters standby mode.

Choose from **30 s**, **1 min** (default setting), **5 min** and **30 min**.

🔧 When the Monitor Is Turned Off to Save Power



- The power-on lamp blinks in standby mode.
- The camera turns off when the standby mode continues for about three minutes.
- When the power-on lamp blinks, turn on the monitor again with one of the following operations.
 - Press the power switch, the shutter-release button, the **▶** button or the **●** (🎬 movie-record) button.
 - Rotate the mode dial.

✔ Auto Off Setting

In the following situations, the time taken for the camera to enter standby mode is fixed.

- When menus are displayed: three minutes
- During slideshow playback: maximum of 30 minutes
- When the AC adapter EH-62A is connected: 30 minutes

Format Memory/Format Card

Press the MENU button →  (Setup menu) ( 186) → Format memory/Format card

Format the internal memory or a memory card.

Formatting permanently deletes all data in the internal memory or memory card. The deleted data cannot be recovered. Be sure to transfer important pictures to a computer before formatting.

Formatting Internal Memory

To format the internal memory, remove the memory card from the camera. The **Format memory** option is displayed in the setup menu.

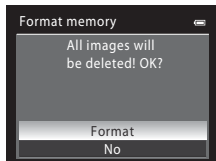

Formatting Memory Card

To format the memory card, insert it in the camera. The **Format card** option is displayed in the setup menu.

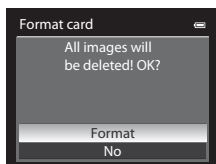

Formatting Internal Memory and Memory card

- Album icon settings ( 127) are reset to their default settings (number icons) when the internal memory or memory card is formatted.
- Do not turn off the camera or open the battery-chamber/memory card slot cover during formatting.
- The first time you insert a memory card that has been used in another device into this camera, be sure to format it with this camera.

Language

Press the **MENU** button → **Y** (Setup menu) (📖186) → Language

Choose one of 26 languages for displaying the camera menus and messages.

Čeština	Czech	Magyar	Hungarian	Türkçe	Turkish
Dansk	Danish	Nederlands	Dutch	Українська	Ukrainian
Deutsch	German	Norsk	Norwegian	عربي	Arabic
English	(default setting)	Polski	Polish	简体中文	Simplified Chinese
Español	Spanish	Português	Portuguese	繁體中文	Traditional Chinese
Ελληνικά	Greek	Русский	Russian	日本語	Japanese
Français	French	Română	Romanian	한글	Korean
Indonesia	Indonesian	Suomi	Finnish	ภาษาไทย	Thai
Italiano	Italian	Svenska	Swedish		

TV Settings

Press the **MENU** button → **Y** (Setup menu) (📖186) → TV settings

Adjust the settings for connecting to a TV.

Video mode

Choose from **NTSC** and **PAL**.

HDMI

Choose a picture resolution for HDMI output from **Auto** (default setting), **480p**, **720p**, or **1080i**. When **Auto** is set, the output resolution that is best suited to the connected high-definition TV is selected automatically from **480p**, **720p** or **1080i**.

HDMI device control

Choose whether or not the camera receives signals from a TV when a TV that conforms to the HDMI-CEC standard is connected with an HDMI cable. When set to **On** (default setting), the television remote control can be used to operate the camera during playback.

See "Using the TV's Remote Control (HDMI Device Control)" (📖172) for more information.

HDMI and HDMI-CEC

"HDMI" is an abbreviation of High-Definition Multimedia Interface, which is one type of multimedia interface. "HDMI-CEC" is an abbreviation of HDMI-Consumer Electronics Control, which enables operations to be linked between compatible devices.

Charge by Computer

Press the MENU button → **Y** (Setup menu) (📖186) → Charge by computer

Choose whether or not the battery inserted into the camera is charged when the camera is connected to a computer via the USB cable (📖178).

Auto (default setting)

When the camera is connected to a computer that is running, the battery inserted into the camera is automatically charged using power supplied by the computer.

Off

The battery inserted into the camera is not charged when the camera is connected to a computer.

✔ Notes on Connecting the Camera to a Printer

- The battery cannot be charged with connection to a printer, even if the printer complies with the PictBridge standard.
- When **Auto** is selected for **Charge by computer**, it may be impossible to print images with direct connection of the camera to some printers. If the PictBridge startup screen is not displayed on the monitor after the camera is connected to a printer and turned on, turn the camera off and disconnect the USB cable. Set **Charge by computer** to **Off** and reconnect the camera to the printer.

Reset File Numbering

Press the MENU button → **Y** (Setup menu) (📖186) → Reset file numbering

When **Yes** is selected, the sequential numbering of file numbers is reset (📖215). After resetting, a new folder is created and the file number for the next image taken starts from "0001."

✔ Notes on Reset file numbering

- **Reset file numbering** cannot be applied when scene mode is set to **Panorama**, or when **Intvl timer shooting** is chosen for continuous in shooting mode **P**, **S**, **A**, **M** or **U**. For **Panorama assist** or **Intvl timer shooting**, a new folder is created, and file numbers are assigned automatically starting with "0001" (📖215, 216).
- **Reset file numbering** cannot be applied when the folder number reaches 999 and there are images in the folder. Insert a new memory card, or format the internal memory/memory card (📖200).

Blink Warning

Press the **MENU** button → **Y** (Setup menu) (📖186) → **Blink warning**

Choose whether or not blinking eyes are detected when using face priority (📖97) in the following shooting modes.

- In the following scene modes: **Night portrait** (📖49), **Scene auto selector** (📖46) and **Portrait** (📖51)
- Shooting modes **P**, **S**, **A**, **M** and **U** (when **Face priority** (📖95) is selected for **AF area mode**)

On

When the camera detects that a human subject may have closed the eyes immediately after recognizing the face and shooting the subject, the **Did someone blink?** screen appears on the monitor.

The face of the human subject that may have closed his/her eyes is framed by a yellow border. You can check the picture taken and determine if you need to take the picture again.

See "Operating the Did someone blink? Screen" (📖204) for more information.

Off (default setting)

Blink warning does not take effect.

✔ Note on Blink Warning







When a setting other than **Single** is set for continuous (📖76), when **Exposure bracketing** (📖94) is set, blink warning does not take effect.

Operating the Did someone blink? Screen

The following operations can be performed when the **Did someone blink?** screen is displayed.

If no operations are performed for a few seconds, the screen automatically returns to the shooting screen.



To	Use	Description
Zoom in to the face for which blinking was detected	T (Q)	Rotate the zoom control toward T (Q).
Return to full-frame playback	W (W)	Rotate the zoom control toward W (W).
Select the face to be displayed		When the camera detects one or more human subjects with closed eyes, press ▲, ▼, ◀ or ▶ during playback zoom to display other faces. The command dial can also be used to change the display.
Delete the picture taken		Press the  button.
Return to shooting screen		Press the  button or the shutter-release button.
		

Reset All

Press the **MENU** button → **Y** (Setup menu) (📖186) → Reset all

When **Reset** is selected, the camera settings are restored to the default values.

Pop-up Menu

Option	Default value
Flash mode (📖36)	Auto
Self-timer (📖39)	OFF
Focus mode (📖40)	Autofocus
Exposure compensation (📖43)	0.0

Shooting in the Scene Mode

Option	Default value
Scene menu (📖45)	Scene auto selector
Hue adjustment in Food mode (📖56)	Center
Panorama (📖58)	Normal (180°) in Easy panorama
Pet portrait (📖59)	Self-timer: Pet portrait auto release Continuous: Continuous

Night Landscape Menu

Option	Default value
Night landscape (📖48)	Hand-held

Night Portrait Menu

Option	Default value
Night portrait (📖49)	Tripod

Backlighting Menu

Option	Default value
HDR (📖50)	Off

Smart Portrait Menu

Option	Default value
Skin softening (📖67)	Normal
Smile timer (📖67)	On
Blink proof (📖68)	Off

Shooting Menu

Option	Default value
Image quality (📖83)	Normal
Image size (📖84)	📷 (4000×3000)
Optimize image (📖87)	Normal
Custom in Optimize image (📖88)	Contrast: Auto Image sharpening: Auto Saturation: Auto
Custom of Black-and-white in Optimize image (📖89)	Contrast: Auto Image sharpening: Auto Monochrome filter: None B&W + color: Off
White balance (📖90)	Auto
ISO sensitivity (📖92)	Auto
Fixed range auto (📖92)	ISO 160-200
Minimum shutter speed (📖92)	None
Metering (📖93)	Matrix
Exposure bracketing (📖94)	Off
AF area mode (📖95)	Auto
Autofocus mode (📖101)	Single AF
Flash exp. comp. (📖101)	0.0
Long exposure NR (📖102)	Auto
Active D-Lighting (📖103)	Off

Continuous Shooting Menu

Option	Default value
Continuous (📖76)	Single
Intvl timer shooting (📖79)	30 s

Movie Menu

Option	Default value
Movie options (📖164)	HD 1080p★ (1920×1080)
HS movie options (📖165)	240 fps
Open with HS footage (📖165)	On
Autofocus mode (📖166)	Single AF
Electronic VR (📖167)	On
Wind noise reduction (📖167)	Off

Setup Menu

Option	Default value
Welcome screen (📖187)	None
Image review (📖191)	On
Brightness (📖191)	3
View/hide framing grid (📖191)	Off
View/hide histograms (📖191)	Off
Print date (📖192)	Off
Vibration reduction (📖193)	On
Motion detection (📖195)	Off
AF assist (📖196)	Auto
Red-eye reduction (📖196)	Pre-flash on
Digital zoom (📖197)	On
Assign side zoom control (📖198)	Zoom
Button sound (📖199)	On
Shutter sound (📖199)	On
Auto off (📖199)	1 min
HDMI (📖201)	Auto
HDMI device control (📖201)	On
Charge by computer (📖202)	Auto
Blink warning (📖203)	Off

Others

Option	Default value
Paper size (📖181, 182)	Default
Frame intvl for Slide show (📖138)	3 s
Album icons and color (📖127)	Number icon (black)

- Choosing **Reset all** also clears the current file number (📖215) in the memory. After resetting, numbering continues from the lowest number available in the internal memory or the memory card. If **Reset all** is performed after all pictures are deleted from the internal memory or memory card (📖35), the file numbers for the next shot pictures start from "0001."
- The following settings remain unaffected even if **Reset all** is performed.
Shooting menu: Preset manual data for **White balance** (📖91)
Playback menu: **Sequence display options** (📖145) and **Choose key picture** (📖145)
Setup menu: **Time zone and date** (📖188), **Language** (📖201) and **Video mode** (📖201) in **TV settings**
- User settings that were saved for mode dial **U** are not reset to the default settings when **Reset all** is performed. To change these settings back to the default settings, use **Reset user settings** (📖110).

Firmware Version

Press the **MENU** button → **Y** (Setup menu) (📖186) → Firmware version

Displays the current camera firmware version.

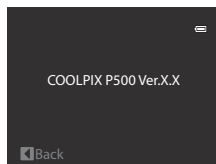

Caring for the Camera

To ensure continued enjoyment of this Nikon product, observe the following precautions when using or storing the device.

✔ Keep dry

The device will be damaged if immersed in water or subjected to high humidity.

✔ Do not drop

The product may malfunction if subjected to strong shock or vibration.

✔ Handle the lens and all moving parts with care

Do not apply force to the lens, lens cover, monitor, memory card slot or battery chamber. These parts are easily damaged. Applying force to the lens cover could result in camera malfunction or damage to the lens. Should the monitor break, care should be taken to avoid injury caused by broken glass and to prevent the liquid crystal from the display touching the skin or entering the eyes or mouth.

✔ Do not point the lens at strong light sources for extended periods

Avoid pointing the lens at the sun or other strong light sources for extended periods when using or storing the camera. Intense light may cause deterioration of the image sensor, producing a white blur effect in photographs.

✔ Keep away from strong magnetic fields

Do not use or store this device in the vicinity of equipment that generates strong electromagnetic radiation or magnetic fields. Strong static charges or the magnetic fields produced by equipment such as radio transmitters could interfere with the monitor, damage data stored on the memory card, or affect the product's internal circuitry.

✔ Avoid sudden changes in temperature

Sudden changes in temperature, such as when entering or leaving a heated building on a cold day, can cause condensation to form inside the device. To prevent condensation, place the device in a carrying case or a plastic bag before exposing it to sudden changes in temperature.

✔ Turn the product off before removing or disconnecting the power source

Do not remove the battery while the product is on, or while images are being recorded or deleted. Forcibly cutting power in these circumstances could result in loss of data or in damage to product memory or internal circuitry.

The Battery

- Check the battery level when taking the camera out, and charge the battery if necessary. Do not continue charging once the battery is fully charged, as this will result in reduced battery performance. If possible, carry a fully-charged spare battery when taking pictures on important occasions.
- Do not use the battery at ambient temperatures below 0 °C (32 °F) or above 40 °C (104 °F). Failure to observe this precaution could damage the battery or impair its performance.
- Charge the battery in an indoor environment that is between 5 and 35 °C (41 to 95 °F).
- When charging the battery by connecting the COOLPIX P500 to the Charging AC Adapter EH-69P or to a computer, the chargeable capacity may decrease when the battery temperature is between 45 to 60 °C (113 to 140 °F). The battery will not charge if its temperature is below 0 °C (32 °F) or above 60 °C (140 °F).
- If an exhausted battery is used at a low temperature, the camera may not turn on. Be sure that the battery is fully charged and spare batteries are prepared before heading outside to take pictures in cold weather. Keep spare batteries in a warm place and exchange as necessary. Once warmed, a cold battery that could not be used temporarily due to lowered performance may recover some of its charge.
- Should the battery terminals become dirty, the camera may not turn on due to poor contact. Wipe the terminals off with a clean, dry cloth before use.
- Recharge it at least once every six months and run it flat before returning it to storage. Attach the included terminal cover to the battery and store it in a cool location with an ambient temperature of 15 to 25 °C (59 to 77 °F). Do not store the battery in hot or extremely cold locations.
- While the battery is in storage, charge it at least once every six months and then use the camera to run it flat again before storing it in a cool location.
- Always remove the battery from the camera or battery charger when it is not being used. Left installed, minute amounts of current flow even when unused, and the battery may become excessively drained and no longer function.
- A marked drop in the time a fully-charged battery retains its charge, when used at room temperature, indicates that the battery needs to be replaced. Purchase a new battery.
- Replace the battery when it no longer holds a charge. Used batteries are a valuable resource. Please recycle used batteries in accordance with local regulations.

Cleaning

Lens/ viewfinder	Avoid touching glass parts with your fingers. Remove dust or lint with a blower (typically a small device with a rubber bulb attached to one end that is pumped to produce a stream of air out the other end). To remove fingerprints or other stains that cannot be removed with a blower, wipe the lens with a soft cloth, using a spiral motion that starts at the center of the lens and working toward the edges. If this fails, clean the lens using a cloth lightly dampened with commercial lens cleaner.
Monitor	Remove dust or lint with a blower. To remove fingerprints and other stains, clean the monitor with a soft, dry cloth, being careful not to apply pressure.
Body	Use a blower to remove dust, dirt or sand, then wipe gently with a soft, dry cloth. After using the camera at the beach or seaside, wipe off any sand or salt with a dry cloth lightly dampened with fresh water, then dry thoroughly. Note that foreign matter inside the camera could cause damage not covered by the warranty.

Do not use alcohol, thinner, or other volatile chemicals.

Storage

Turn the camera off when not in use. Check that the power-on lamp is off before putting the camera away. Remove the battery if the camera will not be used for an extended period. Do not store the camera with naphtha or camphor moth balls, or in any of the following locations:

- Next to equipment that produces strong electromagnetic fields, such as televisions or radios
- Exposed to temperatures below -10 °C (14 °F) or above 50 °C (122 °F)
- Poorly ventilated or subject to humidities of over 60%

To prevent mold or mildew, take the camera out of storage at least once a month. Turn the camera on and release the shutter a few times before putting the camera away again.



Notes on the Monitor

- The monitor may contain a few pixels that are always lit or that do not light. This is a characteristic common to all TFT LCD displays, and does not indicate a malfunction. Images recorded using the product will not be affected.
- Images on the monitor may be difficult to see under bright lighting.
- The monitor is lit by an LED backlight. Should the monitor begin to dim or flicker, contact your Nikon-authorized service representative.

Optional Accessories

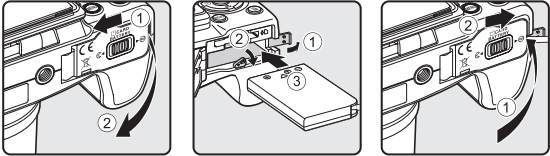
Rechargeable battery	Rechargeable Li-ion Battery EN-EL5 ¹
Charging AC adapter	Charging AC Adapter EH-69P ^{1, 2}
Battery charger	Battery Charger MH-61 ²
AC adapter	<p>AC Adapter EH-62A (connect as shown)</p>  <p>Before closing the battery-chamber/memory card slot cover, fully insert the power connector cord into the slot in the battery chamber. If part of the cord runs out of the groove, the cover or cord may be damaged when the cover is closed.</p>
USB cable	USB Cable UC-E6 ¹
Audio/video cable	Audio Video Cable EG-CP16 ¹
Lens cap	Lens cap LC-CP23 ¹

- 1 Supplied with the camera at the time of purchase (→ page 3 of the *Quick Start Guide*).
- 2 When using in other countries, use a commercially available plug adapter as necessary. For more information about plug adapters, consult your travel agency.

Approved Memory Cards

The following Secure Digital (SD) memory cards have been tested and approved for use in this camera.

- When recording a movie onto a memory card, a memory card with an SD speed class of Class 6 or higher is recommended. If the transfer speed of the card is slow, the movie recording may end unexpectedly.

	SD memory cards	SDHC memory cards ²	SDXC memory cards ³
SanDisk	2 GB ¹	4 GB, 8 GB, 16 GB, 32 GB	64 GB
TOSHIBA	2 GB ¹	4 GB, 8 GB, 16 GB, 32 GB	64 GB
Panasonic	2 GB ¹	4 GB, 8 GB, 12 GB, 16 GB, 24 GB, 32 GB	48 GB, 64 GB
Lexar	2 GB ¹	4 GB, 8 GB, 16 GB, 32 GB	-

- Before using a card reader or similar device, check that the device supports 2 GB cards.
- SDHC-compliant. Before using a card reader or similar device, check that the device supports SDHC.
- SDXC-compliant. Before using a card reader or similar device, check that the device supports SDXC.



- Contact the manufacturer for details on the above cards.

File and Folder Names

Pictures, movies and voice memos are assigned file names as follows.

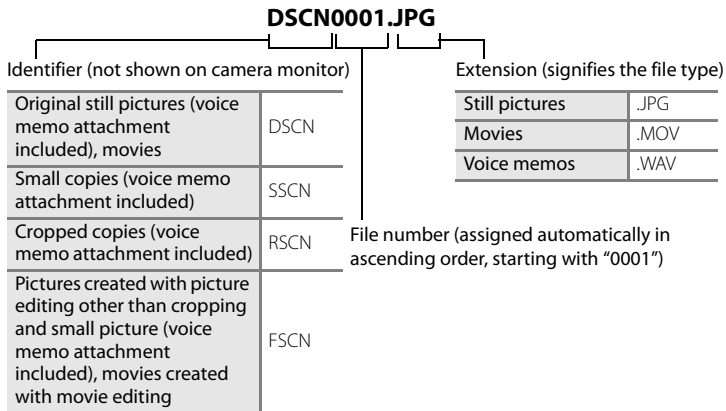











- A folder for storing files is automatically created using the following naming convention: "Folder number + NIKON" (e.g., "100NIKON"). If there are 200 files in a folder, a new folder is created. (For example, the folder name following "100NIKON" becomes "101NIKON.") A new folder is also created when the file numbers in a folder reach 9999 or **Reset file numbering** (📖202) is performed. The next file number is set automatically to "0001." If a folder contains no files, a new folder is not created even if **Reset file numbering** is performed.
- Voice memo file names have the same identifier and file number as the picture to which the voice memo is attached.
- In Panorama assist (📖58), a folder is created for each shooting session using the following naming convention: "Folder number + P_XXX" (e.g., "101P_001"). Pictures are saved in sequence in file numbers starting from 0001.
- Each time a picture is taken in Interval timer shooting (📖77), a folder named with the convention: 'Folder number + INTVL' (e.g., 101INTVL) is created. Pictures are saved in sequence in file numbers starting from 0001.

File and Folder Names











- When image files or voice files are copied between the internal memory and a memory card (📖144), the file naming conventions are as follows:
 - Files copied using **Selected images** are copied to the current folder (or to the folder used for subsequent pictures), where they are assigned file numbers in ascending order following the largest file number in memory.
 - Files copied using **All images**, along with their folder, are copied together. Folder numbers are assigned in ascending order, following the largest folder number on the destination medium. File names are not changed.
- If the current folder is numbered 999 and contains 200 files, or a file is numbered 9999, no further pictures can be captured until the internal memory or memory card is formatted (📖200), or a new memory card is inserted.

Error Messages

The following table lists the error messages and other warnings displayed on the monitor, as well as the solutions for dealing with them.

Display	Description	Solution	
 Turn the camera off, remove the lens cap, and turn the camera on.	Lens cap is attached or lens error occurred.	Make sure that the lens cap has been removed, then turn the camera on again. If the error persists even after the camera is turned off and then on again, contact retailer or Nikon-authorized service representative.	23
 (blinks)	Clock not set.	Set date and time.	188
 Battery exhausted.	Battery exhausted.	Charge or replace the battery.	18, 20
 Battery temperature high	Battery temperature is high.	Turn off camera, and allow battery to cool down before resuming use. Five seconds after this message appears, the monitor is turned off, and the power-on lamp flickers. After the lamp blinks for three minutes, the camera turns off automatically, but you can also press the power switch to turn it off manually.	23
 The camera will turn off to prevent overheating.	Inside of the camera has become hot. The camera turns off automatically.	Leave the camera off until the inside of the camera has cooled and then turn it on again.	–
 (blinks red)	Camera cannot focus.	<ul style="list-style-type: none"> • Refocus. • Use focus lock. 	32, 33 33
 Please wait for the camera to finish recording.	Camera cannot perform other operations until recording is complete.	Wait until message clears from display automatically when recording is complete.	–
 Memory card is write protected.	Write-protect switch is in “lock” position.	Slide the write-protect switch to “write” position.	27
 No card present.	No memory card is inserted when trying to record a movie.	Insert a memory card before starting movie recording.	157



















Error Messages

Display	Description	Solution	
 This card cannot be used.	Error accessing memory card.	<ul style="list-style-type: none"> Use an approved card. Check that connectors are clean. Confirm that memory card is correctly inserted. 	214
 This card cannot be read.			27 26
 Card is not formatted. Format card? Yes No	Memory card has not been formatted for use in this camera.	All data stored on the memory card is deleted when formatted. If there is any data on the card that you want to keep, select No , and backup the data to a computer before formatting the memory card. To format the memory card, select Yes and press the  button.	27
 Out of memory.	Memory card is full.	<ul style="list-style-type: none"> Choose lower image quality or smaller image size. Delete pictures and movies. Replace memory card. Remove memory card and use internal memory. 	83, 84 35, 170 26 26
 Image cannot be saved.	Error occurred while recording picture.	Format the internal memory or memory card.	200
	Camera has run out of file numbers.	Replace the memory card, or format the internal memory/memory card.	26, 200, 216
	Picture cannot be used for Welcome screen.	The following pictures cannot be used. <ul style="list-style-type: none"> Pictures recorded with easy panorama Pictures shot with Image size of  3984x2656,  3968x2232,  1920x1080 or  2992x2992 Pictures created with small picture or crop function that are 160x120 or smaller 	60
			84 154, 156
	There is insufficient space to save a copy.	Delete pictures from destination.	35

Display	Description	Solution	
i Unable to create panorama.	Cannot perform easy panorama shooting.	Easy panorama shooting may not be available in the following situations. <ul style="list-style-type: none"> • When shooting has not finished after a certain period of time • When the camera movement speed is too fast • When the camera is not straight relative to the panorama direction 	60
i Unable to create panorama. Pan the camera in one direction only.			
i Unable to create panorama. Pan the camera more slowly.			
! Sound file cannot be saved.	A voice memo cannot be attached to this file.	<ul style="list-style-type: none"> • Voice memos cannot be attached to movies. • Select an image captured with this camera. 	– 142
i A blink was detected in the picture just taken.	Someone may have had their eyes closed when the picture was taken.	Check results in playback mode.	68
i Image cannot be modified.	Cannot edit selected picture.	<ul style="list-style-type: none"> • Confirm the conditions that are required for editing. • Movies cannot be edited. 	146 –
i Cannot record movie.	Time out error while recording movie.	Choose memory card with faster write speed.	214
i Cannot reset file numbering.	No more folders can be created.	Insert a new memory card, or format the internal memory/memory card.	26, 200, 202
i Memory contains no images.	No pictures in the internal memory or memory card.	<ul style="list-style-type: none"> • Remove the memory card from the camera to play back images saved in the camera's internal memory. • To copy files from internal memory to memory card, press the MENU button to display the copy screen, then copy the files from internal memory to memory card. 	26 144

Error Messages

Display	Description	Solution	
i File contains no image data.	File not created with COOLPIX P500.	File cannot be viewed on this camera. View file using the computer or any other device which was used to create or edit this file.	-
i This file cannot be played back.			
i All images are hidden.	The picture cannot be played back in a slide show.	-	138
i All images are hidden.	All images in the internal memory/ memory card are hidden.	Disable the Hide image setting to view images.	141
i This image cannot be deleted.	Picture is protected.	Disable protection.	139
i Travel destination is in the current time zone.	Destination in same time zone as home.	-	190
i Mode dial is not in the proper position.	Mode dial is between two modes.	Rotate the mode dial to select the desired mode.	44
i Raise the flash.	The flash is lowered when the scene mode is  (Night portrait) or HDR in  (Backlighting) is Off .	Press the  (flash pop-up) button to raise the flash.	37, 49, 50
	The  (flash mode) button on the multi selector is pressed when the flash is lowered.	Press the  (flash pop-up) button to raise the flash.	37
i The flash is lowered.	The flash is not raised during the Scene auto selector mode.	Press the  (flash pop-up) button to raise the flash. The camera can still shoot normally with the flash lowered if you do not wish to use it.	37, 46



Display	Description	Solution	
 Lower the flash.	The flash is raised when recording a movie.	Lower the flash gently and record a movie. Note that sound of lowering the flash may be recorded.	37, 157
 Communications error	Error occurred during communication with printer.	Turn off camera and reconnect USB cable.	180
System error 	Error has occurred in camera's internal circuitry.	Turn off camera, remove and reinsert battery, and turn on camera. If the error persists, contact retailer or Nikon-authorized service representative.	23
 Printer error: check printer status.	Printer error	Check printer. After solving the problem, select Resume and press the  button to resume printing.*	–
 Printer error: check paper	Specified size of paper is not loaded.	Load the specified paper, select Resume and press the  button to resume printing.*	–
 Printer error: paper jam	Paper has jammed in the printer.	Remove the jammed paper, select Resume and press the  button to resume printing.*	–
 Printer error: out of paper	No paper is loaded in the printer.	Load the specified paper, select Resume and press the  button to resume printing.*	–
 Printer error: check ink	Ink error	Check ink, select Resume and press the  button to resume printing.*	–
 Printer error: out of ink	Ink cartridge is empty.	Replace ink cartridge, select Resume and press the  button to resume printing.*	–
 Printer error: file corrupt	An error caused by the image file has occurred.	Select Cancel and press the  button to cancel printing.	–



* See the documentation provided with your printer for further guidance and information.

Troubleshooting

If the camera fails to function as expected, check the list of common problems below before consulting your retailer or Nikon-authorized service representative. Refer to the page numbers in the right-most column for more information.

Display, Settings and Power Supply

Problem	Cause/Solution	
The battery inserted in the camera cannot be charged.	Confirm all connections.	20
The battery cannot be charged by connecting the camera to a computer.	<ul style="list-style-type: none"> • Off is selected for Charge by computer in the setup menu. • When charging by connecting the camera to a computer, battery charging stops when the camera is turned off. • When charging by connecting the camera to a computer, battery charging stops when the computer is suspended (sleeping), and the camera may turn off. • Depending upon computer specifications, settings, and status, charging the battery inserted in the camera may not be possible via computer connection. 	202 178 178 –
Camera cannot be turned on.	<ul style="list-style-type: none"> • Battery is exhausted. • The camera cannot be turned on while connected to an electrical outlet via the Charging AC Adapter. 	28 20
Camera turns off without warning.	<ul style="list-style-type: none"> • Battery is exhausted. • Camera has turned off automatically to save power. • The camera turns off if the Charging AC Adapter is connected while the camera is on. • The camera turns off if the USB cable connecting it to a computer or printer is disconnected. Reconnect the USB cable. • Inside of the camera has become hot. Leave the camera off until the inside of the camera has cooled, and then try turning it on again. • The camera and battery may not perform properly if they are cold. 	28 199 20 174, 176, 180 – 210
Monitor and viewfinder are blank.	<ul style="list-style-type: none"> • Camera is off. • Battery is exhausted. • Standby mode for saving power: Press the power switch, shutter-release button or the  button, or rotate the mode dial. • Monitor and viewfinder cannot be used simultaneously. Press the  button to alternate between displays. • Camera and computer are connected via USB cable. • Camera and TV are connected via A/V cable or HDMI cable. • Interval timer shooting in progress. 	23 28 23, 34 16 173 171 79





Problem	Cause/Solution	
Monitor is hard to read.	<ul style="list-style-type: none"> Ambient lighting too bright: use viewfinder or move to darker location. Adjust monitor brightness. Monitor is dirty. Clean monitor. 	30 191 209
The viewfinder is hard to read.	Adjust diopter adjustment control.	16, 30
Display does not switch to monitor (or viewfinder) when the  button is pressed.	<ul style="list-style-type: none"> You cannot switch the display in the following situations: <ul style="list-style-type: none"> While recording or playing back movies While recording or playing back voice memos During interval timer shooting While connected to a printer While displaying image deletion screens You cannot switch the display while displaying a certain error message. 	157, 168 142 79 179 35 217
Date and time of recording are not correct.	<ul style="list-style-type: none"> If the camera clock has not been set ("Date not set" indicator blinks during shooting), still pictures have a time stamp of "00/00/0000 00:00"; and movies are dated "01/01/2011 00:00." Set the correct date and time using Time zone and date in the setup menu. The camera clock is not as accurate as a normal clock, such as watches. Check camera clock regularly against more accurate timepieces and reset as required. 	24, 188 188
No information displayed in monitor.	Shooting data and photo information may be hidden. Press the DISP button until shooting data or photo information is displayed.	17
Print date not available.	Time zone and date has not been set.	24, 188
Date not appearing on pictures even when Print date is enabled.	<ul style="list-style-type: none"> A shooting mode that does not support Print date is selected. The date cannot be imprinted onto a movie. The date cannot be imprinted on still images saved during movie recording. 	192 – –
Camera settings reset.	Clock battery is exhausted; all settings were restored to their default values.	189
Reset file numbering cannot be done.	<ul style="list-style-type: none"> Reset file numbering cannot be applied when the folder number reaches 999 and there are images in the folder. Change the memory card, or format the internal memory/memory card. Reset file numbering cannot be set when the scene mode is set to Panorama, or when the shooting mode is P, S, A, M or U and Intvl timer shooting is chosen for the continuous shooting. 	202, 215 58, 76, 202, 215





Problem	Cause/Solution	
Monitor is turned off, and the power-on lamp flickers.	Battery temperature is high. Turn off camera, and allow battery to cool down before resuming use. After the lamp blinks for three minutes, the camera turns off automatically, but you can also press the power switch to turn it off manually.	23
Camera temperature rises.	When functions such as movie recording are used for a long time, or when the camera is used in a location with a high ambient temperature, the camera temperature may rise. This is not a malfunction.	158

Electronically Controlled Cameras













In extremely rare instances, unusual characters may appear on the monitor and the camera may stop functioning. In most cases, this phenomenon is caused by a strong external static charge. Turn the camera off, remove and replace the battery, then turn the camera on again. Note that disconnecting the power source as described above may result in the loss of any data not recorded on the internal memory or memory card at the time the problem occurred. Data already recorded is not affected. In the event of continued malfunction, contact your retailer or Nikon-authorized service representative.

Shooting

Problem	Cause/Solution	
Cannot set to shooting mode	Disconnect the HDMI cable or USB cable.	171, 174, 180
No picture taken when shutter-release button is pressed.	<ul style="list-style-type: none"> When camera is in playback mode, press the  or shutter-release button. 	34
	<ul style="list-style-type: none"> When menus are displayed, press the MENU button. Battery is exhausted. When the scene mode is  (Night portrait) or HDR in  (Backlighting) is Off, raise the flash. When flash indicator blinks, flash is charging. 	13 28 37, 49, 50 38
Camera cannot focus.	<ul style="list-style-type: none"> Subject is too close to the camera. Try shooting with  (macro close-up) in the focus mode, or Scene auto selector or Close-up scene mode. 	40, 46, 55
	<ul style="list-style-type: none"> The intended subject is one with which autofocus does not perform well. Set AF assist in the setup menu to Auto. Subject not in focus area when shutter-release button pressed halfway. The focus mode is set to MF (manual focus). Turn camera off and then on again. 	33 196 32, 95 40 23





Problem	Cause/Solution	
Pictures are blurred.	<ul style="list-style-type: none"> • Use flash. • Use vibration reduction or motion detection. • Use BSS (Best Shot Selector). • Use a tripod to stabilize the camera (use with the self-timer for better results). 	36 193, 195 76 39
Bright specks appear in pictures shot using flash.	Flash is reflecting off particles in air. Set the flash to  (Off).	36
Flash does not fire.	<ul style="list-style-type: none"> • Flash is set to  (Off). • A scene mode that cannot turn on the flash is selected. • Blink proof is set to On in the smart portrait mode. • Another function that is set now is restricting the flash. 	36 45 68 104
Digital zoom is not available.	<ul style="list-style-type: none"> • Off is selected for Digital zoom in the setup menu. • The digital zoom cannot be used in the following situations. <ul style="list-style-type: none"> - When the focus mode is set to MF (manual focus) - When the scene mode is set to  (Night landscape),  (Night portrait), Scene auto selector, Portrait, or Pet portrait - When smart portrait is selected - When Multi-shot 16 is set for continuous - When Subject tracking is selected for AF area mode 	197 42 46, 48, 49, 51, 59 65 77 96
Image size not available.	Another function that is set now is restricting Image size .	104
No sound when shutter is released.	<ul style="list-style-type: none"> • Off is selected for Shutter sound under Sound settings in the setup menu. • Continuous shooting is selected. • Exposure bracketing is selected in the shooting menu. • Sports, Museum, Easy panorama in Panorama, or Pet portrait is selected for the scene mode. • On is selected for Smile timer or Blink proof in smart portrait mode. • When the camera is recording a movie. • Do not block the speaker. 	199 76 94 52, 57, 58, 59 67, 68 157 5
AF-assist illuminator does not light.	Off is selected for AF assist in the setup menu. Even when Auto is set, AF-assist illuminator may not light depending on the focus area position or scene mode.	196
Pictures appear smeared.	Lens is dirty. Clean lens.	209
Colors are unnatural.	White balance or hue does not match light source.	90

Troubleshooting

Problem	Cause/Solution	
Ring-shaped or rainbow-colored bands are seen on the screen or the shot image.	When the subject is backlit or when shooting with an extremely bright light source in the display, such as in sunlight, ring-shaped or rainbow-colored bands may appear on the image. Change the position of the light source or remove it from the display, and try shooting again.	—
Randomly spaced bright pixels (“noise”) appear in image.	As the subject is dark, shutter speed is too slow or ISO sensitivity is too high. <ul style="list-style-type: none"> Use flash. Specify a lower ISO sensitivity setting. Apply Long exposure NR in the shooting menu to suit situations. 	36 92 102
Pictures are too dark (underexposed).	<ul style="list-style-type: none"> Flash is set to  (Off). Flash window is blocked. Subject is beyond flash range. Adjust exposure compensation. Raise the ISO sensitivity. Subject is backlit. Raise the flash, and set the scene mode to  (Backlighting) or set the flash mode to  (fill flash). 	36 30 36 43 92 36, 50
Pictures are too bright (overexposed).	Adjust exposure compensation.	43
Unexpected results occurred when flash is set to auto with red-eye reduction.	In very rare cases, when  (Auto with red-eye reduction) or the red-eye reduction fill flash in the  (Night portrait) scene mode is used for flash photography, areas other than red eyes may be corrected. Set a flash mode other than  (Auto with red-eye reduction), select a scene mode other than  (Night portrait) and resume shooting.	36, 49
Skin softening results are not as expected.	<ul style="list-style-type: none"> Skin softening may not produce the desired results depending on shooting conditions. For pictures with four or more faces, try using skin softening in the playback menu. 	65 150
Saving images takes time.	It may take more time to save images in the following situations. <ul style="list-style-type: none"> When the noise reduction function is in operation When flash is set to  (Auto with red-eye reduction) When taking pictures in the following scene modes <ul style="list-style-type: none"> Hand-held in  (Night landscape) Hand-held in  (Night portrait) HDR set to On in  (Backlighting) Easy panorama in Panorama When using skin softening function while shooting When using Active D-Lighting while shooting When Continuous H: 120 fps or Continuous H: 60 fps is selected for continuous 	— 36 48 49 50 58 65 103 76

Problem	Cause/Solution	
Cannot set or use Continuous or Exposure bracketing.	Another function that is set now is restricting the continuous setting or Exposure bracketing.	104
Cannot set Optimize image.	Another function that is set now is restricting Optimize image.	104

Playback



Problem	Cause/Solution	
File cannot be played back.	• File was overwritten or renamed by computer or another make or model of camera.	–
	• Interval timer shooting in progress.	79
	• Movies recorded with cameras other than COOLPIX P500 cannot be played back.	157
Cannot play a sequence.	<ul style="list-style-type: none"> • Pictures shot continuously with cameras other than COOLPIX P500 cannot be played as a sequence. • Check the Sequence display options setting. 	– 145
Cannot zoom in on picture.	• Playback zoom cannot be used with movies, small pictures, or cropped copies of size 320 × 240 pixels or smaller.	–
	• Playback zoom may not be available for pictures taken with cameras other than COOLPIX P500.	–
Cannot record or play back voice memo.	• Voice memos cannot be attached to movies.	168
	• Voice memos cannot be attached to pictures shot by cameras other than COOLPIX P500, and voice memos recorded by other cameras cannot be played back on this camera.	142
Pictures and movies cannot be edited.	• Editing other than Black border cannot be performed on pictures shot with Image size of  3984×2656 ,  3968×2232 ,  1920×1080 or  2992×2992 .	84
	• Pictures recorded with easy panorama cannot be edited.	–
	• Confirm the conditions that are required for editing.	146
Pictures not displayed on television.	• Pictures and movies taken with cameras other than COOLPIX P500 cannot be edited.	–
	• Video mode or HDMI is not correctly set in the TV settings setup menu.	201
	• Cables are connected to both the HDMI mini connector and USB/audio video connector.	171
	• Memory card contains no pictures. Replace memory card. Remove memory card to play back pictures from internal memory.	26

Troubleshooting

Problem	Cause/Solution	
Album icons are reset to their default icons, or images added to albums cannot be displayed in favorite pictures mode.	Data saved in the internal memory or on the memory card may not be played back if overwritten by a computer.	–
The saved images are not displayed in auto sort mode.	<ul style="list-style-type: none"> • The desired image was sorted to a category other than the category currently displayed. • Images saved by cameras other than COOLPIX P500 and images copied using the Copy option cannot be displayed in auto sort mode. • Images saved in the internal memory or on the memory card may not be played back correctly if overwritten by a computer. • Up to 999 images and movies in total can be added to each category. If the desired category already contains 999 images or movies in total, new images or movies cannot be added. 	<p>129</p> <p>130</p> <p>–</p> <p>130</p>
Nikon Transfer 2 does not start when camera is connected to a computer.	<ul style="list-style-type: none"> • Camera is off. • Battery is exhausted. • USB cable is not correctly connected. • Camera is not recognized by the computer. • Confirm that the operating system used is compatible with the camera. • Computer is not set to launch Nikon Transfer 2 automatically. For more information on Nikon Transfer 2, refer to help information contained in ViewNX 2. 	<p>23</p> <p>28</p> <p>174</p> <p>–</p> <p>173</p> <p>177</p>
The PictBridge startup screen is not displayed when the camera is connected to a printer.	With some PictBridge-compatible printers, the PictBridge startup screen may not be displayed and it may be impossible to print images when Auto is selected for Charge by computer . Set Charge by computer to Off and reconnect the camera to the printer.	202
Pictures to be printed are not displayed.	<ul style="list-style-type: none"> • Memory card contains no pictures. Replace memory card. • Remove memory card to print pictures from internal memory. 	<p>26</p> <p>26</p>
Cannot select paper size with camera.	<p>Paper size cannot be selected from the camera in the following situations, even for PictBridge compatible printers. Use the printer to select paper size.</p> <ul style="list-style-type: none"> • The paper size selected using the camera is not compatible with the printer. • A printer that automatically sets the paper size is being used. 	<p>181, 182</p> <p>–</p>

Specifications

Nikon COOLPIX P500 Digital Camera

Type	Compact digital camera
Effective pixels	12.1 million
Image sensor	1/2.3-in. type CMOS; approx. 12.75 million total pixels
Lens	36x optical zoom, NIKKOR lens
Focal length	4.0-144mm (angle of view equivalent to that of 22.5-810 mm lens in 35mm [135] format)
f/-number	f/3.4-5.7
Construction	14 elements in 9 groups
Digital zoom	Up to 4x (angle of view equivalent to that of approx. 3240 mm lens in 35mm [135] format)
Vibration reduction	Both image sensor shift and electronic (still pictures) Electronic (movies)
Autofocus (AF)	Contrast-detect AF
Focus range (from lens)	<ul style="list-style-type: none">• Approx. 50 cm (1 ft. 8 in.) to ∞ (wide-angle position), approx. 2.2 m (7 ft. 3 in.) to ∞ (telephoto position)• Macro close-up mode: Approx. 10 cm (4 in.) to ∞ (when  lights in green and the zoom indicator is on the wide-angle position of ) and from approx. 1 cm (0.4 in.) to ∞ (at three increments from the maximum wide-angle position to the telephoto position)
Focus-area selection	Face priority, auto (9-area automatic selection), center, manual with 99 focus areas, subject tracking
Electronic viewfinder	Color LCD viewfinder, 0.6 cm (0.24-in.) TFT LCD, approx. 230k-dot, with diopter adjustment function
Frame coverage (shooting mode)	Approx. 97% horizontal and 97% vertical (compared to actual picture)
Frame coverage (playback mode)	Approx. 100% horizontal and 100% vertical (compared to actual picture)
Monitor	7.5 cm (3-in.), approx. 921k-dot, wide viewing angle TFT LCD monitor with anti-reflection coating and 5-level brightness adjustment, tiltable 82° downward, 90° upward
Frame coverage (shooting mode)	Approx. 97% horizontal and 97% vertical (compared to actual picture)
Frame coverage (playback mode)	Approx. 100% horizontal and 100% vertical (compared to actual picture)
Storage	
Media	<ul style="list-style-type: none">• Internal memory (approx. 102 MB)• SD/SDHC/SDXC memory card
File system	DCF, Exif 2.3, and DPOF compliant
File formats	Still pictures: JPEG Sound file (voice memo): WAV Movies: MOV (Video: H.264/MPEG-4 AVC, Audio: AAC stereo)

Specifications

Image size (pixels)	<ul style="list-style-type: none">• 12 M 4000×3000• 8 M 3264×2448• 5 M 2592×1944• 3 M 2048×1536• 2 M 1600×1200• 1 M 1280×960• PC 1024×768• VGA 640×480• 3:2 3984×2656• 16:9 (9M) 3968×2232• 16:9 (2M) 1920×1080• 1:1 2992×2992
ISO sensitivity (Standard output sensitivity)	<ul style="list-style-type: none">• ISO 160, 200, 400, 800, 1600, 3200• Auto (auto gain from ISO 160 to 800)• High ISO sensitivity auto (ISO 160 to 1600)• Fixed range auto (ISO 160 to 200, 160 to 400)
Exposure	
Metering	256-segment matrix, center-weighted, spot, spot AF area (with support for 99 focus areas)
Exposure control	Programmed auto exposure with flexible program, shutter priority auto, aperture-priority auto, manual, exposure bracketing, motion detection, exposure compensation (-2.0 to +2.0 EV in steps of 1/3 EV)

Shutter	Mechanical and CMOS electronic shutter
Speed	Auto mode, scene mode <ul style="list-style-type: none"> • 1/1500 to 2 s • 4 s (Fireworks show scene mode) P or S mode <ul style="list-style-type: none"> • 1/1500 to 2 s • 1/1500 to 1/2 s (when ISO sensitivity is fixed at 3200) A or M mode <ul style="list-style-type: none"> • 1/1500 to 8 s (when ISO sensitivity is fixed at 160 or 200, when set to ISO 160-200 in Fixed range auto in A mode, and when set to Auto, High ISO sensitivity auto or Fixed range auto in M mode) • 1/1500 to 4 s (when ISO sensitivity is fixed at 400 or 800, and when set to Auto or ISO 160-400 in Fixed range auto in A mode) • 1/1500 to 2 s (when ISO sensitivity is fixed at 1600, and when set to High ISO sensitivity auto in A mode) • 1/1500 to 1/2 s (when ISO sensitivity is fixed at 3200)
	Continuous H <ul style="list-style-type: none"> • 1/4000 to 1/125 s (Continuous H: 120 fps) • 1/4000 to 1/60 s (Continuous H: 60 fps)
Aperture	Electronically-controlled 6-blade iris diaphragm
Range	9 steps of 1/3 EV
Self-timer	Durations of 2 or 10 seconds can be selected
Built-in flash	
Range (approx.) (ISO sensitivity: Auto)	[W]: 0.5 to 8.0 m (1 ft. 8 in. to 26 ft.) [T]: 2.2 to 4.5 m (7 ft. 3 in. to 14 ft.)
Flash control	TTL auto flash with monitor preflashes
Interface	Hi-Speed USB
Data transfer protocol	MTP, PTP
Video output	Can be selected from NTSC and PAL
HDMI output	Can be selected from Auto, 480p, 720p, and 1080i
I/O terminal	Audio/video output; digital I/O (USB); HDMI mini connector (HDMI output)
Supported languages	Arabic, Chinese (Simplified and Traditional), Czech, Danish, Dutch, English, Finnish, French, German, Greek, Hungarian, Indonesian, Italian, Japanese, Korean, Norwegian, Polish, Portuguese, Romanian, Russian, Spanish, Swedish, Thai, Turkish, Ukrainian
Power sources	<ul style="list-style-type: none"> • One Rechargeable Li-ion Battery EN-EL5 (supplied) • AC Adapter EH-62A (available separately)
Charging time	Approx. 4 hours and 50 minutes (when using Charging AC Adapter EH-69P and when no charge remains)

Specifications

Battery life (EN-EL5)	Still pictures*: Approx. 220 shots Movies: Approx. 1 h 20 min (HD 1080p★ (1920×1080))
Tripod socket	1/4 (ISO 1222)
Dimensions (W × H × D)	Approx. 115.5 × 83.7 × 102.5 mm (4.6 × 3.3 × 4.1 in.) (excluding projections)
Weight	Approx. 494 g (1 lb 1.5 oz) (including battery and SD memory card)
Operating environment	
Temperature	0 °C to 40 °C (32 °F to 104 °F)
Humidity	85% and below (no condensation)

- Unless otherwise stated, all figures are for a camera with a fully-charged Rechargeable Li-ion Battery EN-EL5 operated at an ambient temperature of 25 °C (77 °F).

* Based on Camera and Imaging Products Association (CIPA) standards for measuring the life of camera batteries. Measured at 23 (±2) °C (73 (±4) °F); zoom adjusted with each shot, flash fired with every other shot, Image quality set to **Normal**, Image size set to  **4000×3000**. Battery life may vary depending on shooting interval and length of time menus and images are displayed.

Rechargeable Li-ion Battery EN-EL5

Type	Rechargeable lithium-ion battery
Rated capacity	DC 3.7 V, 1100 mAh
Operating temperature	0 °C to 40 °C (32 °F to 104 °F)
Dimensions (W × H × D)	Approx. 36 × 54 × 8 mm (1.4 × 2.1 × 0.3 in.) (excluding projections)
Weight	Approx. 30 g (1.1 oz) (excluding terminal cover)

Charging AC Adapter EH-69P

Rated input	AC 100 to 240 V, 50/60 Hz, 0.068 to 0.042 A
Rated output	DC 5.0 V, 550 mA
Operating temperature	0 °C to 40 °C (32 °F to 104 °F)
Dimensions (W × H × D)	Approx. 55 × 22 × 54 mm (2.2 × 0.9 × 2.2 in.) (excluding plug adapter) For Argentina: Approx. 55 × 59 × 63 mm (2.2 × 2.4 × 2.5 in.)
Weight	Approx. 55 g (2.0 oz), excluding plug adapter For Argentina: Approx. 80 g (2.9 oz)

Specifications

- Nikon will not be held liable for any errors this manual may contain.
- The appearance of this product and its specifications are subject to change without notice.

Supported Standards

- **DCF:** Design Rule for Camera File System is a standard widely used in the digital camera industry to ensure compatibility among different makes of camera.
- **DPOF:** Digital Print Order Format is an industry-wide standard that allows pictures to be printed at a digital photo lab or with a household printer from print orders stored on the memory card.
- **Exif version 2.3:** This camera supports Exif (Exchangeable Image File Format for Digital Still Cameras) version 2.3, a standard that allows information stored with photographs to be used for optimal color reproduction when images are output from Exif-compliant printers.
- **PictBridge:** A standard developed cooperatively by the digital camera and printer industries, allowing photographs to be output directly to a printer without connecting the camera to a computer.

Index

Symbols

64

A Aperture-priority auto mode 69, 73

(apply selection) button 12

Auto mode 28

Backlighting 50

Continuous shooting mode button 59, 77

Delete button 35, 143, 170

DISP (display) button 17

Exposure compensation 43

Flash mode 36

Flash pop-up button 37

Focus mode 41

M Manual mode 69, 74

MENU Menu button 13

Monitor button 16

(movie-record) button 157

Night landscape 48

Night portrait 49

Playback button 34

Playback mode 34

Playback zoom 118

P Programmed auto mode 69, 71

SCENE Scene mode 45

Self-timer 39

S Shutter-priority auto mode 69, 72

Smart portrait mode 65, 67

T Tele 31

Thumbnail display 115

U User setting mode 108

WB White balance 90

W Wide 31

.JPG 215

.MOV 215

.WAV 215

A

AC adapter 213

Active D-Lighting 103

AF area mode 95

AF assist 4, 196

Album 127

Aperture value 70

Aperture-priority auto mode 73

Assign side zoom control 198

Audio/video cable 171

Audio/video-in jack 171

Auto 36

Auto mode 28

Auto off 199

Auto sort menu 131

Auto sort mode 129

Autofocus 41, 101, 166

Autofocus mode 101, 166

AV cable 171, 213

B

Backlighting 50

Battery 18, 20, 213

Battery charger 22, 213

Battery level indicator 28

Battery-chamber/memory card slot cover 18, 26

Beach 53

Best shot selector 76

Black and white copy 57

Black border 155

Blink proof 68

Blink warning 203

BSS 76

Button sound 199

C

Calendar display 117

Charge by computer 202

Charger 213

Charging AC Adapter 20, 213

Choose key picture 145

Close-up 55

Command dial 11

Computer 173

Continuous 76

Continuous H: 120 fps 76

Continuous H: 60 fps 76

Contrast 88

Copying images 144

Crop 156, 169

Custom 88

D



Date and time 24, 188

Daylight saving time 24, 189
 Delete 35, 143, 170
 Digital zoom 31, 197
 Diopter adjustment control 30
 D-Lighting 149
 DPOF printing 184
 DSCN 215
 Dusk/dawn  54

E

Easy panorama 58, 60
 Editing movies 169
 Electronic VR 167
 Exposure 70
 Exposure compensation 43
 Exposure mode 69
 Extension 215
 Extracting still pictures 168
 Eyelet for camera strap 7

E

Face priority 95
 Favorite pictures 122
 Favorite pictures menu 126
 Favorite pictures mode 122
 File name 215
 Fill flash 36
 Filter effects 152
 Fireworks show  57
 Firmware version 208
 Flash exposure compensation 101
 Flash indicator 38
 Flash mode 36
 Focus 15, 32, 95, 101
 Focus area 32, 95
 Focus lock 33
 Focus mode 40
 Folder name 215
 Food  56
 Format 27, 200
 Format the internal memory 200
 Format the memory card 27, 200
 FSCN 215
 Full-frame playback 34, 111
 Functions that cannot be applied simultaneously 104

H

HDMI 171, 201
 HDMI device control 201
 HDMI mini connector 171
 Hide image 141
 HS movie 160, 161, 165
 HS movie options 165

I

Identifier 215
 Image copy 144
 Image quality 83
 Image sharpening 88
 Image size 84
 Infinity 40
 Internal memory 26
 Internal memory indicator 29
 Interval Timer Shooting 77, 79
 ISO sensitivity 92



L

Landscape  51
 Language 201
 Lens 211, 229
 Lens cap 7
 List by date mode 132
 Lithium-ion type battery 18, 20, 213
 Long exposure NR 102

M

Macro close-up 40
 Manual focus 40, 42
 Manual mode 74
 Memory capacity 28
 Memory card 26, 214
 Memory card slot 26
 Metering 93
 Microphone 142, 157
 Minimum shutter speed 92
 Mode dial 44
 Monitor 6, 8, 211
 Monitor brightness 191
 Monitor settings 191
 Motion detection 195
 Movie length 166
 Movie menu 163
 Movie options 164





Movie playback 168
 Movie recording 157
 Multi selector 12
 Multi-shot 16 77
 Museum  57

N
 Night landscape  48
 Night portrait  49
 Nikon Transfer 2 173
 Number of exposures remaining 28, 85

O

Off 36
 Open with HS footage 165
 Optical zoom 31
 Optimize Image 87
 Optional accessories 213

P

Panorama assist 58, 63
 Panorama  58
 Paper size 181, 182
 Party/indoor  52
 Pet portrait  59
 PictBridge 179
 Picture editing 146
 Playback 34, 111, 115, 117, 118, 143, 168
 Playback menu 134
 Playback mode menu 120
 Playback zoom 118
 Portrait  51
 Power 23, 24, 28
 Power switch/power-on lamp 23, 178
 Preset manual 91
 Pre-shooting cache 76
 Press half way 15
 Print 179, 181, 182
 Print date 136, 192
 Print order 135
 Printer 179
 Programmed auto mode 71
 Protect 139





Q

Quick retouch 148

R

Rear-curtain sync 36
 Rechargeable battery 213
 Rechargeable Li-ion battery 18, 213
 Recording slow motion movies 160
 Red-eye reduction 36, 196
 Remove from favorites 125
 Reset all 205
 Reset file numbering 202
 Resetting saved settings 110
 Rotate image 141
 RSCN 215

S

Saturation 88
 Save to user setting 109
 Scene auto selector  46
 Scene mode 45
 Selecting pictures 140
 Self-timer 39
 Self-timer lamp 39
 Sequence 113
 Sequence display options 145
 Setup menu 185
 Shooting 28, 44, 157
 Shooting information 17
 Shooting menu 81
 Shooting with Face Priority 97
 Shutter sound 199
 Shutter speed 70
 Shutter-priority auto mode 72
 Shutter-release button 32
 Single 76
 Skin softening 67, 150
 Slide show 138
 Slow sync 36
 Small picture 154
 Smart portrait mode 65, 67
 Smile timer 67
 Snow  53
 Sound settings 199
 Sports  52
 SSCN 215
 Subject tracking 96, 99
 Sunset  53

Switching between tabs 13

I

Tele 31

Television 171

Thumbnail playback 115

Time difference 190

Time zone 190

Time zone and date 24, 188

TV settings 201

U

USB cable 174, 180, 213

USB/audio/video output connector 171,
174, 180

User setting mode 108

V

Vibration reduction 193

Video output 201

View/hide framing grid 191

View/hide histograms 17, 191

Viewfinder 16, 30, 211

ViewNX 2 173, 177

Voice memo 142

Volume 168

W

Welcome screen 187

White balance 90

Wide 31

Wind noise reduction 167

Z

Zoom 31

Zoom control 31

Nikon

No reproduction in any form of this manual, in whole or in part (except for brief quotation in critical articles or reviews), may be made without written authorization from NIKON CORPORATION.



NIKON CORPORATION

© 2011 Nikon Corporation

FX1B03(11)
6MM00111-03