

Nikon

DIGITAL CAMERA

COOLPIX P310

Reference Manual

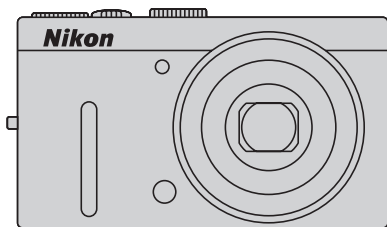

En

Trademark Information

- Microsoft, Windows and Windows Vista are either registered trademarks or trademarks of Microsoft Corporation in the United States and/or other countries.
- Macintosh, Mac OS, and QuickTime are trademarks of Apple Inc., registered in the U.S. and other countries. The iFrame logo and the iFrame symbol are trademarks of Apple Inc.
- Adobe and Acrobat are registered trademarks of Adobe Systems Inc.
- SDXC, SDHC and SD Logos are trademarks of SD-3C, LLC.
- PictBridge is a trademark.
- HDMI, **HDMI** logo and High-Definition Multimedia Interface are trademarks or registered trademarks of HDMI Licensing LLC.
- All other trade names mentioned in this manual or the other documentation provided with your Nikon product are trademarks or registered trademarks of their respective holders.

AVC Patent Portfolio License

This product is licensed under the AVC Patent Portfolio License for the personal and non-commercial use of a consumer to (i) encode video in compliance with the AVC standard ("AVC video") and/or (ii) decode AVC video that was encoded by a consumer engaged in a personal and non-commercial activity and/or was obtained from a video provider licensed to provide AVC video. No license is granted or shall be implied for any other use. Additional information may be obtained from MPEG LA, L.L.C.

See <http://www.mpegla.com>.

Introduction

Parts of the Camera and Basic Operations

The Basics of Shooting and Playback

Shooting Features

Playback Features

Recording and Playing Back Movies

General Camera Setup

Reference Section

Technical Notes and Index

Read This First

Thank you for purchasing the Nikon COOLPIX P310 digital camera. Before using the camera, please read the information in "For Your Safety" (vi) and familiarize yourself with the information provided in this manual. After reading, please keep this manual handy and refer to it to enhance your enjoyment of your new camera.

Confirming the Package Contents

In the event that any items are missing, please contact the store where you purchased the camera.



COOLPIX P310
Digital Camera



Camera Strap

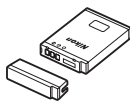

Rechargeable Li-ion
Battery EN-EL12
(with terminal cover)

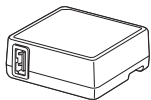

Charging AC Adapter
EH-69P*

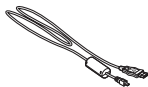

USB Cable UC-E6

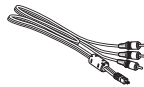

Audio Video Cable EG-CP16



ViewNX 2 Installer CD



Reference Manual CD

- Warranty

* A plug adapter is included if the camera was purchased in a country or region that requires a plug adapter. The shape of the plug adapter varies with the country or region of purchase.

NOTE: A memory card is not included with the camera.

About This Manual







If you want to start using the camera right away, see “The Basics of Shooting and Playback” (📖13).

To learn about the parts of the camera and basic operations, see “Parts of the Camera and Basic Operations” (📖1).

Other Information

- Symbols and Conventions

To make it easier to find the information you need, the following symbols and conventions are used in this manual:

Icon	Description
	This icon indicates cautions and information that should be read before using the camera.
	This icon marks notes, information that should be read before using the camera.
  	These icons indicate other pages containing relevant information;  : “Reference Section”,  : “Technical Notes and Index.”

- SD, SDHC and SDXC memory cards are referred to as “memory cards” in this manual.
- The setting at the time of purchase is referred to as the “default setting.”
- The names of menu items displayed in the camera monitor, and the names of buttons or messages displayed on a computer monitor appear in bold.
- In this manual, images are sometimes omitted from monitor and viewfinder display samples so that monitor indicators can be more clearly shown.
- Illustrations and monitor content shown in this manual may differ from the actual product.

Information and Precautions

Life-Long Learning

As part of Nikon's "Life-Long Learning" commitment to ongoing product support and education, continually updated information is available online at the following sites:

- For users in the U.S.A.: <http://www.nikonusa.com/>
- For users in Europe and Africa: <http://www.europe-nikon.com/support/>
- For users in Asia, Oceania, and the Middle East: <http://www.nikon-asia.com/>

Visit these sites to keep up-to-date with the latest product information, tips, answers to frequently asked questions (FAQs), and general advice on digital imaging and photography. Additional information may be available from the Nikon representative in your area. Visit the site below for contact information:

<http://imaging.nikon.com/>

Use Only Nikon Brand Electronic Accessories

Nikon COOLPIX cameras are designed to the highest standards and include complex electronic circuitry. Only Nikon brand electronic accessories (including battery chargers, batteries, Charging AC Adapter and AC adapters) certified by Nikon specifically for use with this Nikon digital camera are engineered and proven to operate within the operational and safety requirements of this electronic circuitry.

THE USE OF NON-NIKON ELECTRONIC ACCESSORIES COULD DAMAGE THE CAMERA AND MAY VOID YOUR NIKON WARRANTY.

The use of third-party rechargeable Li-ion batteries not bearing the Nikon holographic seal could interfere with normal operation of the camera or result in the batteries overheating, igniting, rupturing, or leaking.

For more information about Nikon brand accessories, contact a local authorized Nikon dealer.

Holographic seal: Identifies this device as an authentic Nikon product.



Before Taking Important Pictures

Before taking pictures on important occasions (such as at weddings or before taking the camera on a trip), take a test shot to ensure that the camera is functioning normally. Nikon will not be held liable for damages or lost profits that may result from product malfunction.

About the User's Manual

- No part of the documentation included with this product may be reproduced, transmitted, transcribed, stored in a retrieval system, or translated into any language in any form, by any means, without Nikon's prior written permission.
- Nikon will not be held liable for any damages resulting from the use of this product.
- Nikon reserves the right to change the specifications of the hardware and software described in the documentation at any time and without prior notice.
- While every effort was made to ensure that the information in the documentation is accurate and complete, we would appreciate it were you to bring any errors or omissions to the attention of the Nikon representative in your area (address provided separately).

Notice Concerning Prohibition of Copying or Reproduction

Note that simply being in possession of material that was digitally copied or reproduced by means of a scanner, digital camera or other device may be punishable by law.

• Items prohibited by law from being copied or reproduced

Do not copy or reproduce paper money, coins, securities, government bonds or local government bonds, even if such copies or reproductions are stamped "Sample." The copying or reproduction of paper money, coins, or securities which are circulated in a foreign country is prohibited. Unless the prior permission of the government was obtained, the copying or reproduction of unused postage stamps or post cards issued by the government is prohibited.

The copying or reproduction of stamps issued by the government and of certified documents stipulated by law is prohibited.

• Cautions on certain copies and reproductions

The government has issued cautions on copies or reproductions of securities issued by private companies (shares, bills, checks, gift certificates, etc.), commuter passes, or coupon tickets, except when a minimum of necessary copies are to be provided for business use by a company. Also, do not copy or reproduce passports issued by the government, licenses issued by public agencies and private groups, ID cards and tickets, such as passes and meal coupons.

• Comply with copyright notices

The copying or reproduction of copyrighted creative works such as books, music, paintings, woodcut prints, maps, drawings, movies, and photographs is governed by national and international copyright laws. Do not use this product for the purpose of making illegal copies or to infringe copyright laws.

Disposing of Data Storage Devices

Please note that deleting images or formatting data storage devices such as memory cards or built-in camera memory does not completely erase the original image data. Deleted files can sometimes be recovered from discarded storage devices using commercially available software, potentially resulting in the malicious use of personal image data. Ensuring the privacy of such data is the user's responsibility.

Before discarding a data storage device or transferring ownership to another person, erase all data using commercial deletion software, or format the device and then completely refill it with images containing no private information (for example, pictures of empty sky). Be sure to also replace any pictures selected for the **Select an image** option in the **Welcome screen** setting (📖98). Care should be taken to avoid injury or damage to property when physically destroying data storage devices.

For Your Safety

To prevent damage to your Nikon product or injury to yourself or to others, read the following safety precautions in their entirety before using this equipment. Keep these safety instructions where all those who use the product will read them.



This icon marks warnings, information that should be read before using this Nikon product, to prevent possible injury.

WARNINGS

Turn off in the event of malfunction

Should you notice smoke or an unusual smell coming from the camera or Charging AC Adapter, unplug the Charging AC Adapter and remove the battery immediately, taking care to avoid burns. Continued operation could result in injury. After removing or disconnecting the power source, take the equipment to a Nikon-authorized service representative for inspection.

Do not disassemble

Touching the internal parts of the camera or Charging AC Adapter could result in injury. Repairs should be performed only by qualified technicians. Should the camera or Charging AC Adapter break open as the result of a fall or other accident, take the product to a Nikon-authorized service representative for inspection, after unplugging the product and/or removing the battery.

Do not use the camera or Charging AC Adapter in the presence of flammable gas

Using the camera in the presence of flammable gases such as propane and gasoline, as well as flammable sprays or dust could result in explosion or fire.

Handle the camera strap with care

Never place the strap around the neck of an infant or child.

Keep out of reach of children

Do not keep the products within reach of children. Doing so may cause injury. Particular care should be taken to prevent infants from putting the battery or other small parts into their mouths.

Do not remain in contact with the camera, Charging AC Adapter, or AC adapter for extended periods while the devices are on or in use.

Parts of the devices become hot. Leaving the devices in direct contact with the skin for extended periods may result in low-temperature burns.

 Observe caution when handling the battery

The battery may leak, overheat, or explode if improperly handled. Observe the following precautions when handling the battery for use in this product:

- Before replacing the battery, turn the product off. If you are using the Charging AC Adapter/AC adapter, be sure it is unplugged.
- Use only a Rechargeable Li-ion Battery EN-EL12 (included). Charge the battery by inserting it into the camera and connecting the Charging AC Adapter. EH-69P (included).
- When inserting the battery, do not attempt to insert it upside down or backwards.
- Do not short or disassemble the battery or attempt to remove or break the battery insulation or casing.
- Do not expose the battery to flame or to excessive heat.
- Do not immerse in or expose to water.
- Replace the terminal cover when transporting the battery. Do not transport or store with metal objects such as necklaces or hairpins.
- The battery is prone to leakage when fully discharged. To avoid damage to the product, be sure to remove the battery when no charge remains.

- Discontinue use immediately should you notice any change in the battery, such as discoloration or deformation.
- If liquid from the damaged battery comes in contact with clothing or skin, rinse immediately with plenty of water.
- If leaked battery fluid gets into your eyes, rinse them out immediately with clean running water and get medical treatment.
- Do not attempt to charge batteries that are not rechargeable.

 Observe the following precautions when handling the Charging AC Adapter

- Keep dry. Failure to observe this precaution could result in fire or electric shock.
- Dust on or near the metal parts of the plug should be removed with a dry cloth. Continued use could result in fire.
- Do not handle the plug or go near the Charging AC Adapter during lightning storms. Failure to observe this precaution could result in electric shock.
- Do not damage, modify, forcibly tug or bend the USB cable, place it under heavy objects, or expose it to heat or flames. Should the insulation be damaged and the wires become exposed, take it to a Nikon-authorized service representative for inspection. Failure to observe these precautions could result in fire or electric shock.

- Do not handle the plug or Charging AC Adapter with wet hands. Failure to observe this precaution could result in electric shock.
- Do not use with travel converters or adapters designed to convert from one voltage to another or with DC-to-AC inverters. Failure to observe this precaution could damage the product or cause overheating or fire.

⚠ Use appropriate cables

When connecting cables to the input and output jacks, use only the cables provided or sold by Nikon for the purpose, to maintain compliance with product regulations.

⚠ Handle moving parts with care

Be careful that your fingers or other objects are not pinched by the lens cover or other moving parts.

⚠ CD-ROMs

The CD-ROMs included with this device should not be played back on audio CD equipment. Playing CD-ROMs on an audio CD player could cause hearing loss or damage the equipment.

⚠ Observe caution when using the flash

Using the flash close to your subject's eyes could cause temporary visual impairment. Particular care should be observed if photographing infants, when the flash should be no less than 1 m (3 ft 4 in.) from the subject.

⚠ Do not operate the flash with the flash window touching a person or object

Failure to observe this precaution could result in burns or fire.

⚠ Avoid contact with liquid crystal

Should the monitor break, care should be taken to avoid injury caused by broken glass and to prevent liquid crystal from the monitor touching the skin or entering the eyes or mouth.

⚠ Turn the power off when using inside an airplane or the hospital

Turn the power off while inside the airplane during take off or landing. Follow the instructions of the hospital when using while in a hospital. The electromagnetic waves given out by this camera may disrupt the electronic systems of the airplane or the instruments of the hospital.

⚠ 3D Images

Do not continuously view 3D images recorded with this device for extended periods, whether on a television, monitor, or other display. In the case of children whose visual systems are still maturing, consult a pediatrician or ophthalmologist prior to use and follow their instructions. Prolonged viewing of 3D images may cause eye strain, nausea, or discomfort. Cease use should any of these symptoms occur and consult a physician if necessary.

Notices

Notices for Customers in the U.S.A.

IMPORTANT SAFETY INSTRUCTIONS -

SAVE THESE INSTRUCTIONS.

DANGER - TO REDUCE THE RISK OF FIRE OR ELECTRIC SHOCK, CAREFULLY FOLLOW THESE INSTRUCTIONS

For connection to a supply not in the U.S.A., use an attachment plug adapter of the proper configuration for the power outlet if needed.

The power supply unit is intended to be correctly orientated in a vertical or floor mount position.

Federal Communications Commission (FCC) Radio Frequency Interference Statement

This equipment has been tested and found to comply with the limits for a Class B digital device, pursuant to Part 15 of the FCC rules. These limits are designed to provide reasonable protection against harmful interference in a residential installation. This equipment generates, uses, and can radiate radio frequency energy and, if not installed and used in accordance with the instructions, may cause harmful interference to radio communications. However, there is no guarantee that interference will not occur in a particular installation. If this equipment does cause harmful interference to radio or television reception, which can be determined by turning the equipment off and on, the user is encouraged to try to correct the interference by one or more of the following measures:

- Reorient or relocate the receiving antenna.
- Increase the separation between the equipment and receiver.
- Connect the equipment into an outlet on a circuit different from that to which the receiver is connected.
- Consult the dealer or an experienced radio/television technician for help.



Nikon

COOLPIX P310

CAUTIONS**Modifications**

The FCC requires the user to be notified that any changes or modifications made to this device that are not expressly approved by Nikon Corporation may void the user's authority to operate the equipment.

Interface Cables

Use the interface cables sold or provided by Nikon for your equipment. Using other interface cables may exceed the limits of Class B Part 15 of the FCC rules.

Notice for Customers in the State of California**WARNING**

Handling the cord on this product will expose you to lead, a chemical known to the State of California to cause birth defects or other reproductive harm.

Wash hands after handling.

Nikon Inc.,
1300 Walt Whitman Road,
Melville, New York 11747-3064
USA
Tel: 631-547-4200

Notice for Customers in Canada**CAUTION**

This Class B digital apparatus complies with Canadian ICES-003.

ATTENTION

Cet appareil numérique de la classe B est conforme à la norme NMB-003 du Canada.

Notices for Customers in Europe**CAUTIONS****RISK OF EXPLOSION IF BATTERY IS REPLACED BY AN INCORRECT TYPE.****DISPOSE OF USED BATTERIES ACCORDING TO THE INSTRUCTIONS.**

This symbol indicates that this product is to be collected separately.



The following apply only to users in European countries:

- This product is designated for separate collection at an appropriate collection point. Do not dispose of as household waste.
- For more information, contact the retailer or the local authorities in charge of waste management.

This symbol on the battery indicates that the battery is to be collected separately.







































The following apply only to users in European countries:

- All batteries, whether marked with this symbol or not, are designated for separate collection at an appropriate collection point. Do not dispose of as household waste.
- For more information, contact the retailer or the local authorities in charge of waste management.































Table of Contents

Introduction	ii
Read This First	ii
Confirming the Package Contents.....	ii
About This Manual.....	iii
Information and Precautions.....	iv
For Your Safety.....	vi
WARNINGS	vi
Notices	ix
Parts of the Camera and Basic Operations	1
Parts of the Camera	2
The Camera Body.....	2
Controls Used in Shooting Mode.....	4
Controls Used in Playback Mode	5
The Monitor.....	6
Basic Operations.....	9
Switching Between Shooting Mode and Playback Mode	9
Using the Rotary Multi Selector.....	10
Using Menus (the MENU Button).....	11
Attaching the Camera Strap	12
The Basics of Shooting and Playback.....	13
Preparation 1 Insert the Battery.....	14
Preparation 2 Charge the Battery.....	16
Preparation 3 Insert a Memory Card	18
Internal Memory and Memory Cards.....	19
Approved Memory Cards	19
Step 1 Turn the Camera On	20
Turning the Camera On and Off.....	21
Setting the Display Language, Date, and Time.....	22
Step 2 Select a Shooting Mode.....	24
Available Shooting Modes	25
Step 3 Frame a Picture.....	26
Using the Zoom.....	27
Step 4 Focus and Shoot	28
Step 5 Play Back Images	30
Changing How Images Are Displayed.....	31
Step 6 Delete Unwanted Images.....	32

Shooting Features	35
☑ (Auto) Mode	36
Changing ☑ (Auto) Mode Settings	36
Scene Mode (Shooting Suited to Scenes)	37
Changing Scene Mode Settings.....	38
Characteristics of Each Scene	38
Using Skin Softening	50
P, S, A, M Modes (Setting the Exposure for Shooting)	51
Changing P, S, A, M Modes	54
Options Available in the Shooting Menu	54
U (User Setting Modes)	57
Saving Settings in U Mode	58
Features That Can Be Set Using the Multi Selector	59
Available Functions	59
Using the Flash (Flash Modes).....	60
Using the Self-timer	63
Smile Timer (Shooting Smiling Faces)	64
Using Focus Mode	66
Adjusting Brightness (Exposure Compensation)	68
List of the Default Settings.....	69
Changing the Image Quality and Image Size	72
Available Image Quality.....	72
Available Image Size.....	73
Features That Cannot Be Used Simultaneously	75
The Control Range of the Shutter Speed (P, S, A, M Modes).....	78
Focusing on Subject	79
Using the Target Finding AF	79
Using Face Detection	80
Focus Lock.....	81
<hr/>	
Playback Features	83
Features Available in Playback Mode (Playback Menu)	84
Connecting the Camera to a TV, Computer, or Printer	86
Using ViewNX 2	87
Installing ViewNX 2	87
Transferring Images to the Computer	89
Viewing Images	90

Recording and Playing Back Movies.....	91
Recording Movies	92
Changing Movie Recording Settings (Movie Menu)	95
Playing Back Movies.....	96
General Camera Setup.....	97
The Setup Menu	98
Reference Section.....	 1
Taking Pictures with Manual Focus	 2
Using Easy Panorama (Shooting and Playing back)	 3
Taking Pictures with Easy Panorama.....	 3
Viewing Easy Panorama (Scroll)	 5
Using Panorama Assist.....	 6
Using 3D Photography.....	 8
P, S, A, M Modes.....	 10
P (Programmed auto), S (Shutter-priority auto) or	
A (Aperture-priority auto).....	 10
M (Manual) Mode	 12
Playing and Deleting Images Captured Using Continuous Shooting Mode (Sequence).....	 14
Playing Images in a Sequence.....	 14
Deleting Images in a Sequence.....	 15
Editing Still Images.....	 16
Editing Features	 16
 Quick Retouch: Enhancing Contrast and Saturation.....	 18
 D-Lighting: Enhancing Brightness and Contrast	 18
 Skin Softening: Softening Skin Tones	 19
 Filter Effects: Applying Digital Filter Effects.....	 20
 Small Picture: Reducing the Size of an Image.....	 21
 Black Border: Adding a Black Border to Pictures	 22
 Crop: Creating a Cropped Copy	 23
Connecting the Camera to a TV (Viewing Images on a TV)	 24
Connecting the Camera to a Printer (Direct Print)	 26
Connecting the Camera to a Printer.....	 27
Printing Individual Images.....	 28
Printing Multiple Images.....	 29
Editing Movies.....	 32
Extracting Only the Desired Portions of the Movie.....	 32
Saving a Frame from a Movie as a Still Picture	 33

Shooting Menu (P, S, A or M Mode)	34
Image Quality and Image Size.....	34
Picture Control (COOLPIX Picture Control).....	34
Custom Picture Control (COOLPIX Custom Picture Control).....	38
White Balance (Adjusting Hue).....	39
Metering.....	41
Continuous Shooting.....	42
ISO Sensitivity.....	46
Exposure Bracketing.....	47
AF Area Mode.....	48
Autofocus Mode.....	52
Flash Exp. Comp.....	53
Noise Reduction Filter.....	53
Active D-Lighting.....	54
Save User Settings/Reset User Settings.....	54
Zoom Memory.....	55
Startup Zoom Position.....	55
The Playback Menu	56
Print Order (Creating a DPOF Print Order).....	56
Slide Show.....	58
Protect.....	59
The Image Selection Screen.....	60
Rotate Image.....	61
Voice Memo.....	62
Copy (Copy Between Internal Memory and Memory Card).....	63
Sequence Display Options.....	64
Choose Key Picture.....	64
The Movie Menu	65
Movie Options.....	65
Recording Movies in Slow Motion and Fast Motion (HS Movie).....	67
Autofocus Mode.....	69
The Setup Menu	70
Welcome Screen.....	70
Time Zone and Date.....	71
Monitor Settings.....	74
Print Date (Imprinting Date and Time on Pictures).....	76
Vibration Reduction.....	77
Motion Detection.....	78
AF Assist.....	79
Digital Zoom.....	79
Sound Settings.....	80

Auto Off	 80
Format Memory/Format Card.....	 81
Language.....	 81
TV Settings.....	 82
Fn Button	 83
Charge by Computer.....	 84
Toggle Av/Tv Selection.....	 86
Reset File Numbering.....	 86
Blink Warning	 87
Filmstrip.....	 88
Eye-Fi Upload	 89
Reverse Indicators	 90
Reset All	 90
Firmware Version.....	 93
File and Folder Names.....	94
Optional Accessories	96
Error Messages.....	97
<hr/>	
Technical Notes and Index	1
Caring for the Products.....	2
The Camera	 2
The Battery.....	 3
Charging AC Adapter	 4
The Memory Cards.....	 5
Caring for the Camera	6
Cleaning	 6
Storage.....	 6
Troubleshooting.....	7
Specifications	14
Supported Standards	 17
Index.....	18



A series of horizontal dashed lines spanning the width of the page, intended for handwriting practice. There are 15 lines in total, starting from the top right and extending to the bottom left.



Parts of the Camera and Basic Operations

This chapter describes the parts of the camera and also explains the main functions of each part and the basic camera operations.

Parts of the Camera	2
The Camera Body	2
Controls Used in Shooting Mode	4
Controls Used in Playback Mode	5
The Monitor	6
Basic Operations	9
Switching Between Shooting Mode and Playback Mode	9
Using the Rotary Multi Selector.....	10
Using Menus (the MENU Button)	11
Attaching the Camera Strap	12

➔ If you want to start using the camera right away, see “The Basics of Shooting and Playback” (📖 13).

Parts of the Camera

The Camera Body

Parts of the Camera and Basic Operations

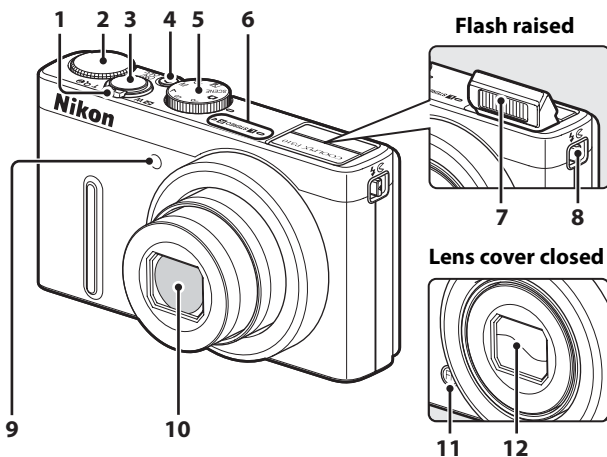

1	Zoom control..... 27
	W : Wide..... 27
	T : Tele..... 27
	: Thumbnail playback..... 31
	: Playback zoom..... 31
	: Help..... 37
2	Command dial 51, 53
3	Shutter-release button..... 4, 28
4	Power switch/power-on lamp..... 21
5	Mode dial..... 24
6	Microphone (stereo)..... 84, 92



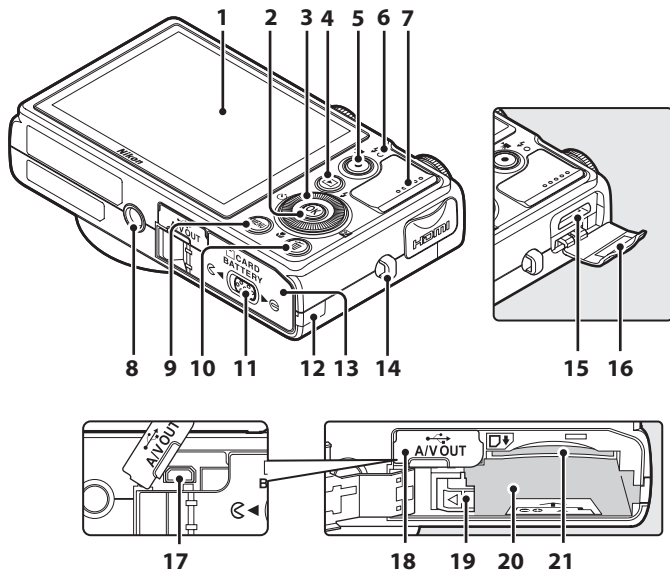







7	Flash..... 60
8	(flash pop-up) control..... 60
9	Self-timer lamp..... 63
10	AF-assist illuminator..... 99
11	Fn (FUNC) button..... 100
12	Lens cover





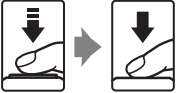
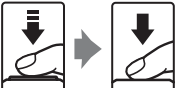











1	Monitor	6, 24
2	OK (apply selection) button	10
3	Rotary multi selector (multi selector)	10
4	▶ (playback) button.....	9, 30
5	● (movie-record) button	9, 30, 92
6	Charge lamp.....	17, 85
6	Flash lamp.....	60
7	Speaker	84, 96, 99
8	Tripod socket	
9	MENU (menu) button.....	11
10	⌫ (delete) button.....	32, 96
11	Cover latch.....	14, 18

12	Power connector cover (for connection with an optional AC Adapter)	96
13	Battery-chamber/ memory card slot cover	14, 18
14	Eyelet for camera strap.....	12
15	HDMI mini connector (Type C).....	86
16	HDMI connector cover.....	86
17	USB/Audio video connector.....	16, 86
18	Connector cover	16, 86
19	Battery latch.....	14, 15
20	Battery chamber.....	14
21	Memory card slot	18

Controls Used in Shooting Mode

Control	Name	Main Function	
	Mode dial	Change the shooting mode.	24
	Zoom control	Rotate toward T (Q) (telephoto zoom position) to zoom in, and rotate toward W (checkered) (wide-angle position) to zoom out.	27
	Rotary multi selector	See “Using the Rotary Multi Selector” for more information.	10
	Command dial	Set the flexible program (during shooting mode P) or shutter speed (during shooting modes S or M).	51, 53, 100
	MENU (menu) button	Display and hide the menu.	11
	Shutter-release button	When pressed halfway (i.e., if you stop pressing when you feel resistance slightly): Set focus and exposure. When pressed all the way (i.e., if you press the button all the way down): Release the shutter.	28
	Fn (FUNC) button	Display the setting menu of pre-assigned function.	100
	Playback button	Play back images.	9, 30
	Delete button	Delete the last image that was saved.	32
	 movie-record button	Start and stop movie recording.	92

Controls Used in Playback Mode



Control	Name	Main Function	
	Playback button	<ul style="list-style-type: none"> When the camera is turned off, press and hold this button to turn the camera on in playback mode. Return to shooting mode. 	21 9
	Zoom control	<ul style="list-style-type: none"> Enlarge the image when rotated toward T (); display image thumbnail or the calendar when rotated toward W (). Adjust the volume for voice memo and movie playback. 	31 84, 96
	Rotary multi selector	See "Using the Rotary Multi Selector" for more information.	10
	Command dial	Switch the magnification of an enlarged image.	31
	Apply selection button	<ul style="list-style-type: none"> Display the histogram and shooting information or return to full-frame playback mode. Display individual images of a sequence in full-frame. Scroll an image recorded with easy panorama. Play back movies. Switch from image thumbnail or zoomed image display to full-frame playback mode. 	30  14  5 96 10
	MENU (menu) button	Display and hide the menu.	11
	Delete button	Delete images.	32
	Shutter-release button	Return to shooting mode.	-
	 movie-record) button		

The Monitor

- The information that is displayed on the monitor during shooting and playback changes depending on the camera's settings and state of use. In the default setting, information is displayed when the camera is turned on and when you operate the camera, and turns off after a few seconds (when **Photo info** in **Monitor settings** (📖98) is set to **Auto info**).

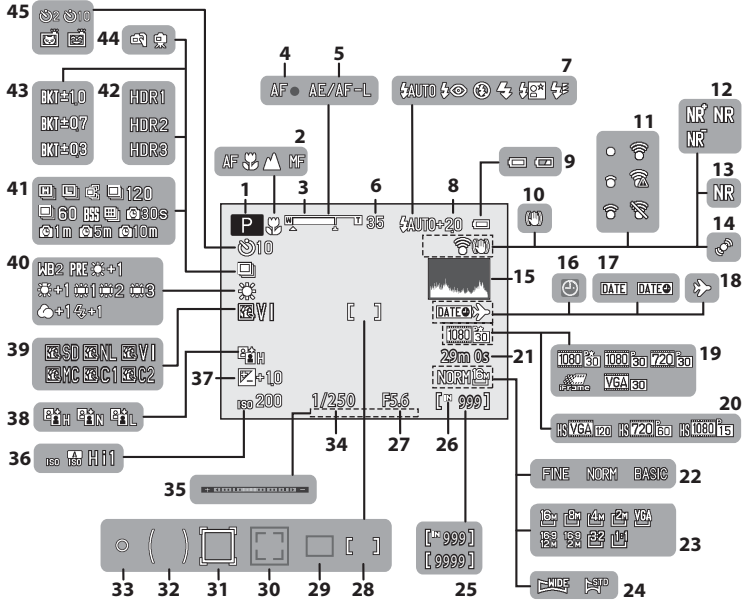
Shooting Mode



1	Shooting mode.....	24, 25	27	Aperture value	51
2	Focus mode.....	67	28	Focus area (for manual, for center)	28, 43, 44, 55
3	Zoom indicator	27	29	Focus area (for auto, target finding AF).....	55
4	Focus indicator	28	30	Focus area (for face detection, pet detection)	47, 55, 64, 80
5	AE/AF-L indicator.....	 67	31	Focus area (for subject tracking).....	55
6	Zoom memory	56	32	Center-weighted area.....	55
7	Flash mode	61	33	Spot metering area	55
8	Flash exp. comp.....	56	34	Shutter speed	51
9	Battery level indicator	20	35	Exposure indicator	53
10	Vibration reduction icon	99	36	ISO sensitivity	26, 55
11	Eye-Fi communication indicator.....	101,  89	37	Exposure compensation value.....	68
12	Noise reduction filter	56	38	Active D-Lighting.....	56
13	Noise reduction burst	40	39	COOLPIX Picture Control.....	54
14	Motion detection icon	99	40	White balance.....	55
15	View/hide histograms	68, 98	41	Continuous shooting mode.....	47, 55
16	"Date not set" indicator.....	23, 98	42	Backlighting (HDR)	45
17	Print date.....	98	43	Exposure bracketing	55
18	Travel destination indicator	98	44	Hand-held/tripod	38, 41
19	Movie options (normal speed movies).....	95	45	Self-timer	63
20	Movie options (HS movies).....	95		Smile timer	64
21	Movie length	92, 94		Pet portrait auto release	47
22	Image quality	72			
23	Image size.....	73			
24	Easy panorama.....	46			
25	Number of exposures remaining (still pictures).....	20, 74			
26	Internal memory indicator	20			

Playback Mode

Full-frame display (📖30)

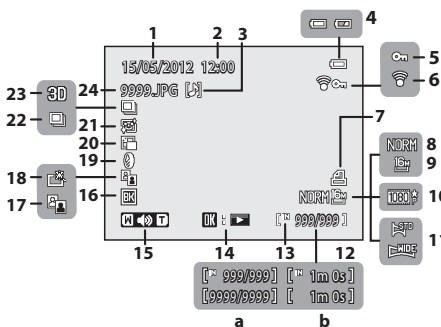

Shooting information (📖30)

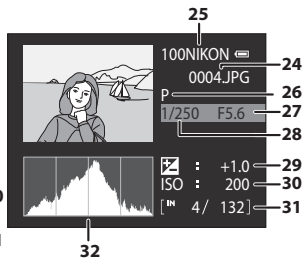

1	Date of recording.....	22
2	Time of recording.....	22
3	Voice memo indicator.....	84
4	Battery level indicator.....	20
5	Protect icon.....	84
6	Eye-Fi communication indicator.....	101, 📷89
7	Print order icon.....	84
8	Image quality.....	72
9	Image size.....	73
10	Movie options.....	92, 95
11	Easy panorama indicator.....	46
12	(a) Current image number/total number of images.....	30
	(b) Movie length.....	96
13	Internal memory indicator.....	30
	Easy panorama playback guide.....	📷5
14	Sequence playback guide.....	📷14
	Movie playback guide.....	96
15	Volume indicator.....	84, 96

16	Black border indicator.....	84
17	D-Lighting icon.....	84
18	Quick retouch icon.....	84
19	Filter effects icon.....	84
20	Small picture.....	84, 📷23
21	Skin softening icon.....	84
22	Sequence display.....	📷14
23	3D picture indicator.....	49
24	File number and type.....	📷94
25	Folder name.....	📷94
26	Shooting mode ¹	25
27	Aperture value.....	28
28	Shutter speed.....	28
29	Exposure compensation value.....	68
30	ISO sensitivity.....	55
31	Current image number/ total number of images.....	30
32	Histogram ²	

¹ P is displayed when the shooting mode 📷 SCENE, 📷 or P is selected.

² A histogram is a graph showing the distribution of tones in the image. The horizontal axis corresponds to pixel brightness, with dark tones to the left and bright tones to the right. The vertical axis shows the number of pixels.

Basic Operations

Switching Between Shooting Mode and Playback Mode

The camera has two modes of operation: Shooting mode, which is used for taking pictures, and playback mode, which is used for viewing pictures.

Press the  (playback) button to switch between shooting mode and playback mode.

- While using playback mode, you can also switch to shooting mode by pressing the shutter-release button or the  (movie-record) button.

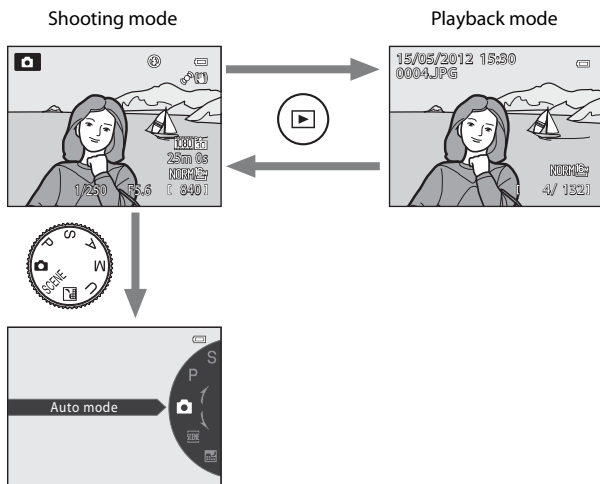

- Rotate the mode dial and align an icon to the mark to select different shooting modes ( 24, 25).

Using the Rotary Multi Selector

Operate by rotating the rotary multi selector, pressing up (▲), down (▼), left (◀) or right (▶) on the rotary multi selector, or pressing the **OK** button.

- The “rotary multi selector” is also referred to as the “multi selector” in this manual.

When Using Shooting Mode

Rotate to set the aperture value*/Select an item Display  (flash mode) (📖60) menu

Display  (Self-timer/ Smile timer) menu (📖63, 64)



Display the  (exposure compensation) guide (📖68)

Apply selection

Display  (focus mode) menu (📖66)

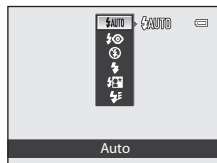

- * The aperture value can be set in shooting mode **A** or **M** (📖53). Items can be chosen while a menu is displayed.

When Using Playback Mode

Select the previous image¹/Move the displayed area when the image is magnified (📖31).



Display histogram and shooting information (📖30)/Play back movies (📖96)²

Select the next image¹/Move the displayed area when the image is magnified (📖31).

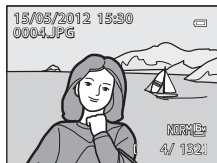

¹ Previous or next images can also be chosen by rotating the rotary multi selector.

² When displaying image thumbnail or when the image is magnified, this button switches the camera to full-frame playback mode.

When Displaying Menus

Select the item above*

Select the item on the left/Return display to the previous screen

Select the item below*



Select the item on the right/Display sub-menu (apply selection)

Apply selection

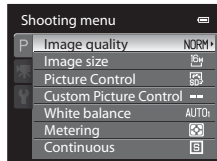

- * Items above or below can also be chosen by rotating the rotary multi selector.

Using Menus (the MENU Button)

When the **MENU** button is pressed while the shooting screen or playback screen is displayed, the menu for the current mode is displayed. Once the menu is displayed, various settings can be changed.

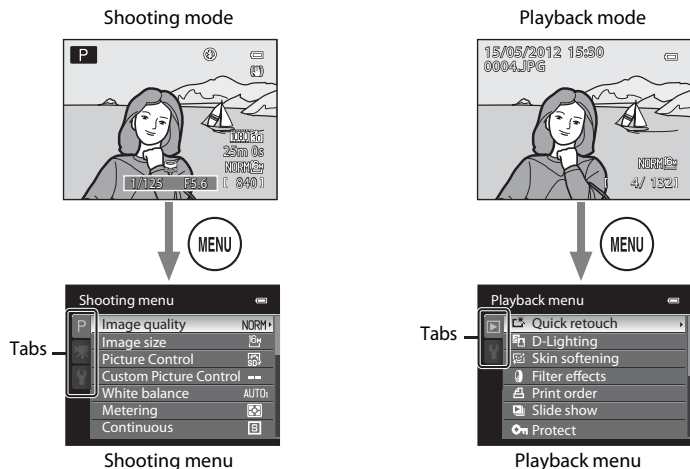

P tab:
Displays the settings that can be changed for the current shooting mode (24). Depending on the current shooting mode, the tab icon that is displayed will be different.

M tab:
Displays movie recording settings.

Y tab:
Displays the setup menu, where you can change general settings.

▶ tab:
Displays the settings available for the playback mode.

Y tab:
Displays the setup menu, where you can change general settings.

When the Menu Contains Two or More Pages

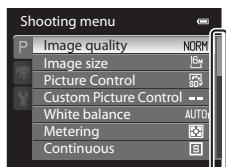

The scroll bar is displayed to indicate the current page.

Switching Between Tabs

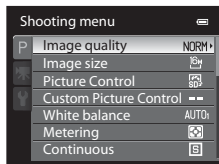

Press the rotary multi selector ◀ to highlight the tab.



Press the rotary multi selector ▲ or ▼ to select a tab, and press the OK button or ▶.

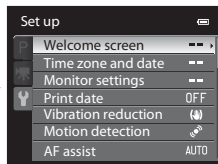

The selected menu is displayed.

Selecting Menu Items

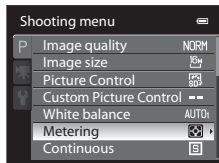

Press the rotary multi selector ▲ or ▼ to select an item, and then press ▶ or the OK button.

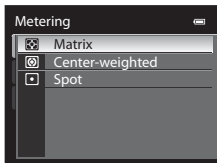

Press ▲ or ▼ to select an item and then press the OK button.



When you finished changing settings, press the MENU (menu) button to exit the menu.

Note on the Command Dial Operation When Menus are Displayed

Rotating the command dial when menus are displayed allows you to change the setting values of a selected item. There are some setting values that cannot be changed using the command dial.

Attaching the Camera Strap

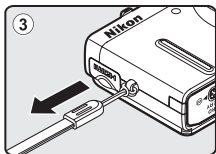
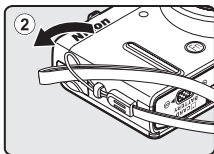
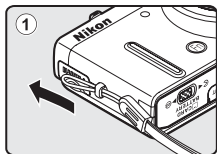



The Basics of Shooting and Playback

Preparation

Preparation 1 Insert the Battery	14
Preparation 2 Charge the Battery	16
Preparation 3 Insert a Memory Card	18



Shooting

Step 1 Turn the Camera On	20
Setting the Display Language, Date, and Time (First Use Only)	22
Step 2 Select a Shooting Mode	24
Step 3 Frame a Picture	26
Step 4 Focus and Shoot	28



Playback

Step 5 Play Back Images	30
Step 6 Delete Unwanted Images	32

Preparation 1 Insert the Battery

- 1** Open the battery-chamber/memory card slot cover.

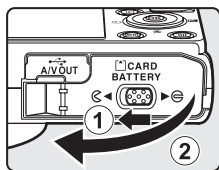

- 2** Insert the included EN-EL12 battery (rechargeable Li-ion battery).

- Use the battery to push the orange battery latch in the direction indicated by the arrow (1), and fully insert the battery (2).
- When the battery is inserted correctly, the battery latch will lock the battery in place.

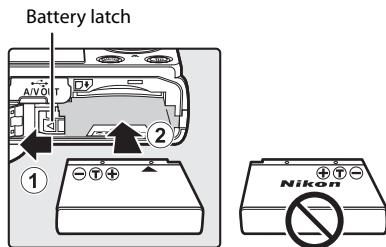

✓ Inserting the Battery Correctly

Inserting the battery upside down or backwards could damage the camera. Be sure to check that the battery is in the correct orientation.

- 3** Close the battery-chamber/memory card slot cover.

- Charge the battery before the first use or when the battery is running low (16).
- While the battery-chamber/memory card slot cover is open, the camera cannot be turned on. Additionally, the battery inserted in the camera cannot be charged.

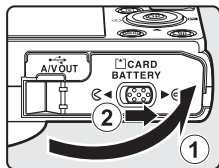

Removing the Battery

Turn the camera off (📖21) and be sure that the power-on lamp and the monitor have turned off before opening the battery-chamber/memory card slot cover. To eject the battery, open the battery-chamber/memory card slot cover and push the orange battery latch in the direction shown (①). Then, remove the battery straight (②).

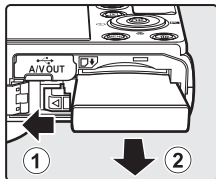

✔ High Temperature Caution

The camera, battery, and memory card may be hot immediately after using the camera. Observe caution when removing the battery or memory card.

✔ Notes on Battery

- Be sure to read and follow the warnings of "For Your Safety" (📖vi) thoroughly before using the battery.
- Be sure to read and follow the warnings for "The Battery" (🔋3) thoroughly before using the battery.

Preparation 2 Charge the Battery

1 Prepare the included Charging AC Adapter EH-69P.

If a plug adapter* is included with your camera, attach the plug adapter to the plug on the Charging AC Adapter. Push the plug adapter firmly until it is securely held in place. Once the two are connected, attempting to forcibly remove the plug adapter could damage the product.

* The shape of the plug adapter varies according to the country or region in which the camera was purchased.

The Charging AC Adapter comes with the plug adapter attached in Argentina and Korea.

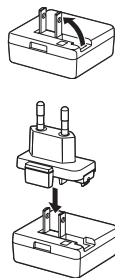

2 Make sure the battery is inserted in the camera, and then connect the camera to the Charging AC Adapter in order of ① to ③.

- Keep the camera turned off.
- When connecting the cable, be sure that the plug is properly oriented. Do not use force when connecting the cable to the camera. When disconnecting the cable, do not pull the plug at an angle.
- Close the battery-chamber/memory card slot cover.

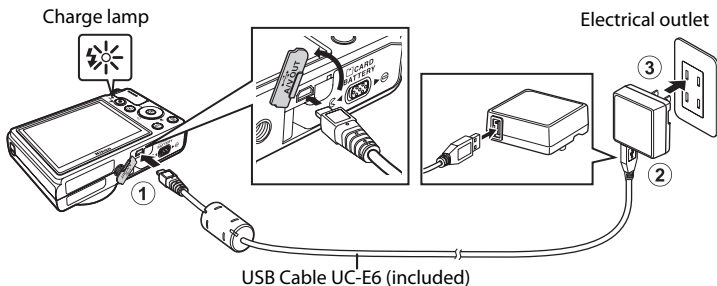

- When charging starts, the charge lamp flashes slowly in green.
- About four hours are required to charge a fully exhausted battery.
- When the battery has been completely charged, the charge lamp turns off.
- See "Understanding the Charge Lamp" (📖17) for more information.

3 Disconnect the Charging AC Adapter from the electrical outlet and then disconnect the USB cable.

- When the camera is connected to an electrical outlet with the Charging AC Adapter, the camera cannot be turned on.

Understanding the Charge Lamp

Status	Description
Flashes slowly (green)	The battery is charging.
Off	The battery is not charging. When charging is complete, the charge lamp flashing slowly in green stops and is turned off.
Flashes quickly (green)	<ul style="list-style-type: none"> The ambient temperature is not suited to charging. Charge the battery indoors with an ambient temperature of 5°C to 35°C (41°F to 95°F). The USB cable or Charging AC Adapter is not properly connected, or there is a problem with the battery. Disconnect the USB cable or unplug the Charging AC Adapter and correctly connect it again, or change the battery.

Notes on Charging AC Adapter

- Be sure to read and follow the warnings of “For Your Safety” (📖vi) thoroughly before using the Charging AC Adapter.
- Be sure to read thoroughly and follow the warnings for “Charging AC Adapter” (🔌4) before use.

Charging Using Computer or Battery Charger

- You can also charge the Rechargeable Li-ion Battery EN-EL12 by connecting the camera to a computer (📖86, 100).
- The EN-EL12 can be charged without using the camera by using the Battery Charger MH-65 (available separately; 🔌96).

AC Power Source

- You can take pictures and play back images while using the AC Adapter EH-62F (available separately; 🔌96) to power the camera from an electrical outlet.
- Do not, under any circumstances, use another make or model of AC adapter other than EH-62F. Failure to observe this precaution could result in overheating or damage to the camera.

Preparation 3 Insert a Memory Card

- 1 Confirm that the power-on lamp and the monitor are turned off and open the battery-chamber/memory card slot cover.

- Be sure to turn off the camera before opening the cover.

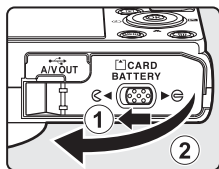

- 2 Insert the memory card.

- Slide the memory card until it clicks into place.

✓ Inserting the Memory Card Correctly

Inserting the memory card upside down or backwards could damage the camera or the memory card. Be sure to confirm that the memory card is in the correct orientation.

Memory card slot

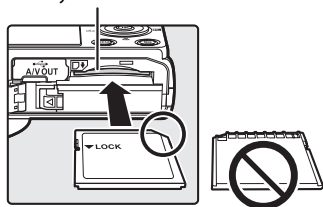

- 3 Close the battery-chamber/memory card slot cover.

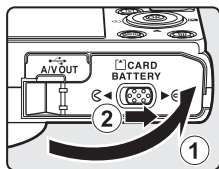

✓ Formatting a Memory Card

- The first time you insert a memory card that has been used in another device into this camera, be sure to format it with this camera.
- **All data stored on a memory card is permanently deleted when the card is formatted.** Be sure to make copies of any data you wish to keep before formatting the memory card.
- To format a memory card, insert the memory card into the camera, press the **MENU** button and select **Format card** from the setup menu (p.98).

✓ Note on Memory Cards

Refer to the documentation included with the memory card, as well as “The Memory Cards” (p.5) in “Caring for the Products”.

Removing Memory Cards

Before opening the battery-chamber/memory card slot cover, turn the camera off and confirm that the power-on lamp and the monitor are off.

Press the memory card in lightly with your finger (①) to partially eject it, and then pull it out straight (②).

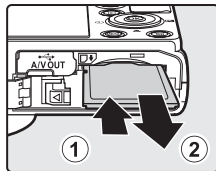

High Temperature Caution

The camera, battery, and memory card may be hot immediately after using the camera. Observe caution when removing the battery or memory card.

Internal Memory and Memory Cards

Camera data, including images and movies, can be saved in either the camera's internal memory (approximately 90 MB) or on a memory card. To use the camera's internal memory for shooting or playback, first remove the memory card.

Approved Memory Cards

The following Secure Digital (SD) memory cards have been tested and approved for use in this camera.

- When recording a movie onto a memory card, a memory card with an SD speed class of Class 6 or higher is recommended. If the transfer speed of the card is slow, the movie recording may end unexpectedly.

	SD memory cards	SDHC memory cards ²	SDXC memory cards ³
SanDisk	2 GB ¹	4 GB, 8 GB, 16 GB, 32 GB	64 GB
TOSHIBA	2 GB ¹	4 GB, 8 GB, 16 GB, 32 GB	64 GB
Panasonic	2 GB ¹	4 GB, 8 GB, 12 GB, 16 GB, 32 GB	48 GB, 64 GB
Lexar	-	4 GB, 8 GB, 16 GB, 32 GB	64 GB, 128 GB

1 Before using a card reader or similar device, check that the device supports 2 GB cards.

2 SDHC-compliant. Before using a card reader or similar device, check that the device supports SDHC.

3 SDXC-compliant. Before using a card reader or similar device, check that the device supports SDXC.



- Contact the manufacturer for details on the above cards.

Step 1 Turn the Camera On

1 Press the power switch to turn on the camera.

- **If you are turning the camera on for the first time, see “Setting the Display Language, Date, and Time”** (📖22).
- The lens extends, and the monitor is turned on.

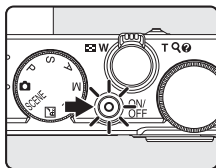

2 Check the battery level and number of exposures remaining.

Battery level indicator

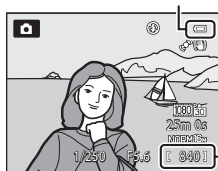

Number of exposures remaining

Battery Level

Display	Description
	Battery level high.
	Battery level low. Prepare to charge or replace the battery.
 Battery exhausted.	Cannot take pictures. Charge or replace the battery.

Number of Exposures Remaining

The number of exposures remaining is displayed.

- When a memory card is not inserted, is displayed and pictures are recorded to the internal memory (approx. 90 MB).
- The number of pictures that can be stored depends on the remaining capacity of the internal memory or memory card, the image quality, and the image size (📖72).
- The number of exposures remaining shown in the illustration differs from the actual value.

Turning the Camera On and Off

- When the camera is turned on, the power-on lamp (green) lights and the monitor is turned on (the power-on lamp turns off when the monitor is turned on).
- To turn off the camera, press the power switch. Both the monitor and the power-on lamp are turned off.
- To turn on the camera in playback mode, press and hold the  (playback) button. At this time, the lens does not extend.

Power Saving Function (Auto Off)

If no operations are performed for a while, the monitor will turn off, the camera will enter standby mode, and the power-on lamp will flash. If no operations are performed for another three minutes, the camera will turn off automatically.

To turn on the monitor again in standby mode, perform either one of the following operations.

- Press the power switch, shutter-release button,  button, or  (movie-record) button.
- Rotate the mode dial.

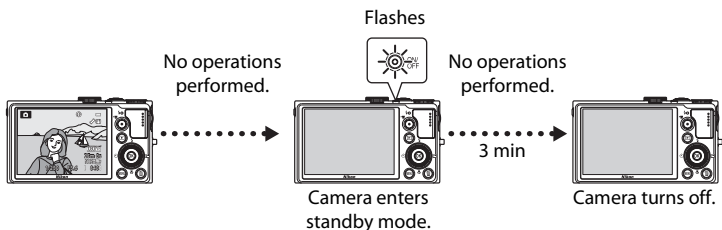

- The time that elapses before the camera enters standby mode can be changed using the **Auto off** setting in the setup menu ( 98).
- By default, the camera enters standby mode in about one minute when you are using shooting mode or playback mode.
- If you are using the optional AC Adapter EH-62F, the camera enters standby mode after 30 minutes. This setting cannot be changed.

Setting the Display Language, Date, and Time

Dialogs for language selection and camera clock setting are displayed the first time the camera is turned on.

- 1 Press the multi selector ▲ or ▼ to choose the desired language and press the **OK** button.

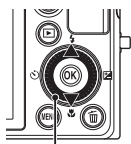

Multi selector

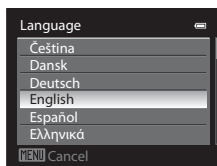

- 2 Press ▲ or ▼ to choose **Yes** and press the **OK** button.

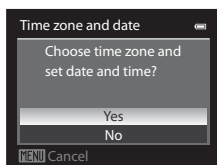

- 3 Press ◀ or ▶ to select your home time zone (Time zone), and press the **OK** button.

- See "Daylight Saving Time" (📖23) for more information.

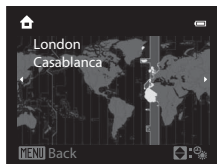
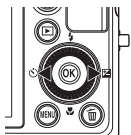

- 4 Press ▲ or ▼ to choose the date display order and press the **OK** button or ▶.

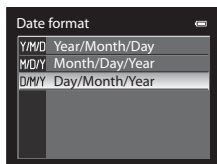

- 5 Press ▲, ▼, ◀ or ▶ to set date and time, and press the **OK** button.

- Choose an item: Press ▶ or ◀ (selected in the following order: **D** (day) → **M** (month) → **Y** (year) → **hour** → **minute**). The item can also be chosen by rotating the multi selector.
- Set the contents: Press ▲ or ▼. Date and time can also be set by rotating the command dial.
- Confirm the settings: Select the **minute** field and press the **OK** button or ▶.

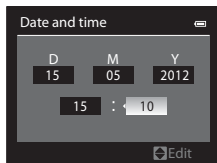

6 Press ▲ or ▼ to choose **Yes** and press the **OK** button.

- After finishing the setting, the lens extends and the shooting screen is displayed.

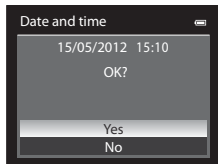

Daylight Saving Time

If daylight saving time is in effect, press the multi selector ▲ to enable the daylight saving time function while setting the region in step 3.

☀ is displayed at the top of the monitor.

Press ▼ to disable the daylight saving time function.

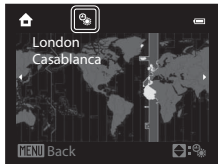

Changing the Language Setting and the Date and Time Setting

- You can change these settings using the **Language** and **Time zone and date** settings in **Y** setup menu (📖98).
- In the **Time zone** setting of **Time zone and date** in **Y** setup menu, when the daylight saving time function is enabled, the camera's clock is set forward by one hour, and when disabled, set back by one hour. When the ➔ travel destination is set, the camera automatically calculates the time difference between the travel destination and the 🏠 home time zone, and saves images using the date and time of the travel destination.
- If you exit without setting the date and time, ⌚ flashes when the shooting screen is displayed. Use the **Time zone and date** setting in the setup menu (📖98) to set the date and time.

The Clock Battery



- The camera's clock is powered by a backup battery that is separate from the camera's main battery.
- The backup battery charges after about ten hours of charging when the main battery is inserted into the camera or when the camera is connected to an optional AC adapter, and can store the set date and time for several days.
- If the camera's backup battery becomes exhausted, the date and time setting screen is displayed when the camera is turned on. Set the date and time again. See step 2 of "Setting the Display Language, Date, and Time" (📖22) for more information.

Imprinting the Shooting Date in Printed Images



- Set the date and time before shooting.
- You can imprint the shooting date in images as they are captured by setting **Print date** in the setup menu (📖98).
- If you want the shooting date to be printed without using the **Print date** setting, print using the ViewNX 2 software (📖87).

Step 2 Select a Shooting Mode

Rotate the mode dial to select the shooting mode.

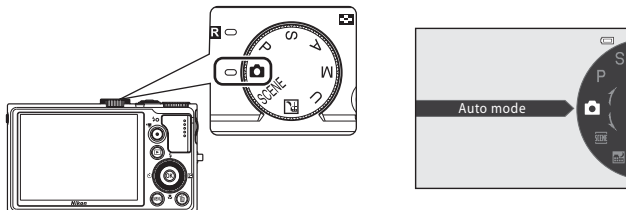
- The following describes how to take pictures in  (auto) mode as an example. Rotate the mode dial to .



- The camera switches to  (auto) mode and the shooting mode icon changes to .

Shooting mode icon

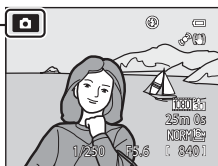

- See "The Monitor" () 6 for more information.

Available Shooting Modes

P, S, A, M mode (📖51)

Choose these modes for greater control over shutter speed and aperture value. Settings can be adjusted in the shooting menu (📖54) to suit the shooting conditions and the type of shot you want to capture.

U User settings mode (📖57)

Setting combinations that are frequently used for shooting can be saved. The saved settings can be immediately retrieved for shooting simply by rotating the mode dial to U.

📷 (auto) mode (📖36)

Shoot easily with basic camera operations without going into detailed settings.

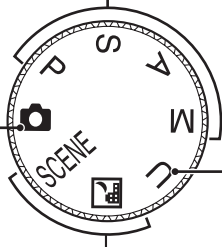

Scene mode (📖37)

When one of the scene modes is selected, pictures are captured using settings that are optimized for the selected scene.

SCENE (Scene): Choose the desired scene from 18 different scene types using the scene menu, and the camera's settings are automatically optimized for the selected scene.

In scene auto selector mode, the camera automatically selects the optimum scene mode for simpler shooting.

In special effects mode, effects can be applied to pictures during shooting. Nine different effects are available.

- To select a scene, first rotate the mode dial to **SCENE** and press the **MENU** button. Select the desired scene by pressing the multi selector ▲ or ▼, and then press the **OK** button.

🌃 (Night landscape): Captures the atmosphere of night landscapes.

📌 Note on the Flash

When the flash is lowered, the flash setting is fixed at off and 🔌 is displayed at the top of the monitor. In situations where a flash is needed, such as in dark locations or when the subject is backlit, be sure to raise the flash (📖60).

📌 Features That Are Available in Shooting Mode

- The functions of the multi selector ▲ (📷), ▼ (📷), ◀ (📷) or ▶ (📷) can be set. See "Features That Can Be Set Using the Multi Selector" (📖59) for more information.
- Press the **MENU** button to display the menu for the selected shooting mode. See "Shooting Features" (📖35) for more information about the settings available in the menu for the current shooting mode.

Step 3 Frame a Picture

1 Ready the camera.

- Keep your fingers, hair, strap and other objects away from the lens, flash, AF-assist illuminator and microphone.
- To shoot in the "tall" orientation, hold the camera so that the flash is above the lens.

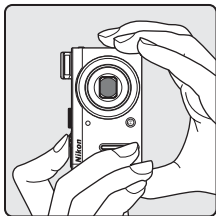
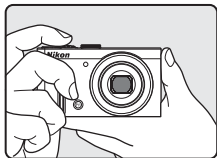

2 Frame the picture.

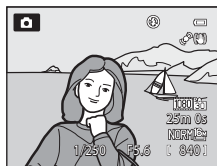

- Point the camera at the subject.



ISO Sensitivity

ISO (ISO sensitivity, ) may be displayed on the shooting screen. When **ISO** is displayed, the ISO sensitivity is automatically raised.

Using a Tripod

- In the following situations, use of a tripod is recommended to avoid the effects of camera shake:
 - When shooting in a dark location or with the flash mode () set to  (off)
 - When shooting in the telephoto zoom position
- To take a picture with the camera attached to a tripod, set **Vibration reduction** in the setup menu () to **Off**.

Using the Zoom

Rotate the zoom control to activate the optical zoom.

- To zoom in so that the subject fills a larger area of the frame, rotate toward **T** (telephoto zoom position).
- To zoom out so that the area visible increases in the frame, rotate toward **W** (wide-angle position).
- Rotating the zoom control all the way in either direction adjusts the zoom quickly, while rotating the control partially adjusts the zoom slowly (except during movie recording).
- A zoom indicator is displayed at the top of the monitor when the zoom control is rotated.

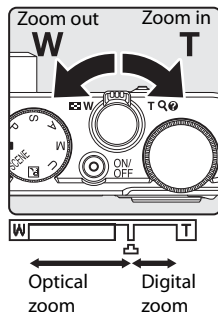

Digital Zoom

When the camera is already at the maximum optical zoom position, rotating the zoom control toward **T** (telephoto zoom position) triggers the digital zoom.

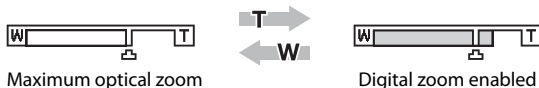

Digital zoom can magnify the subject up to about 2× beyond the maximum magnification of the optical zoom.



- The focus will be at the center of the frame and the focus area will not be displayed when the digital zoom is in effect.

Digital Zoom and Interpolation

Unlike the optical zoom, the digital zoom uses a digital imaging process known as interpolation to magnify images, resulting in slight deterioration of image quality depending on the image size (📖73) and digital zoom magnification.

 indicates the zoom position where interpolation is applied when shooting still pictures. When the zoom is increased beyond the  position, interpolation is initiated and the zoom indicator also turns yellow.

 moves to the right as the image size becomes smaller, allowing you to confirm the zoom position that can be used to capture still images without image degradation before shooting at the current image size setting.

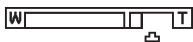

When the image size is small

- Digital zoom can be disabled from the **Digital zoom** option in the setup menu (📖98).

More Information

- See “Zoom memory” (📖56) for more Information.
- See “Startup zoom position” (📖56) for more Information.

Step 4 Focus and Shoot

- 1 Press the shutter-release button halfway, i.e., press the button slightly until you feel resistance.**

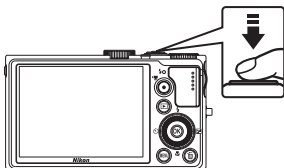

- When you press the shutter-release button halfway, the camera sets the focus and exposure (shutter speed and aperture value). Focus and exposure remain locked while the shutter-release button is pressed halfway.
- When the camera detects the main subject, it focuses on that subject. When the subject is in focus, the focus areas (up to 12 areas) light in green.
- The camera has nine focus areas, and if it does not detect the main subject, it automatically selects the focus areas containing the subject closest to the camera. When the subject is in focus, the focus areas that are in focus (up to nine areas) light in green.



Shutter speed Aperture value



- When the digital zoom is in effect, the camera focuses on the subject at the center of the screen, and the focus area is not displayed. When the subject is in focus, the focus indicator (📖6) lights in green.
- When the shutter-release button is pressed halfway and the focus area or focus indicator flashes in red, the subject is out of focus. Change the composition and press the shutter-release button halfway again.

- 2 Press the shutter-release button all the way, i.e., press the button the rest of the way down.**

- The shutter is released and the picture is recorded.
- If you press the shutter-release button with too much force, the camera may shake, causing images to be blurred. Press the button gently.



✔ Note on Recording Images and Saving Movies

The indicator showing the number of exposures remaining or the indicator showing the maximum movie length flashes while images are being recorded or while a movie is being saved. **Do not open the battery-chamber/memory card slot cover or remove the battery or memory card while an indicator is flashing.** Doing this could result in loss of data, or in damage to the camera or the memory card.

✔ Autofocus

Autofocus may not perform as expected in the following situations. In some rare cases, the subject may not be in focus despite the fact that the focus area or focus indicator lights in green.

- Subject is very dark
- Objects of sharply differing brightness are included in the scene (e.g. the sun behind the subject makes that subject appear very dark)
- No contrast between the subject and surroundings (e.g. a portrait subject, wearing a white shirt, is standing in front of a white wall)
- Several objects are at different distances from the camera (e.g., an animal inside a cage)
- Subjects with repeating patterns (window blinds, buildings with multiple rows of similarly shaped windows, etc.)
- Subject is moving rapidly

In these situations, try pressing the shutter-release button halfway to refocus several times, or focus on another subject and use focus lock (📖81). When using focus lock, be sure that the distance between the camera and the subject with which focus was locked is the same as that for the actual subject.

The camera can also focus using manual focus (📖66, 📷2).

✔ The Subject Is Too Close to the Camera

If the camera does not focus, try shooting with 📷 (macro close-up) (📖67) in the focus mode, or **Close-up** (📖43) scene mode.

📷 AF-assist Illuminator

In dark places, the AF-assist illuminator (📖99) may light when the shutter-release button is pressed halfway.

📷 To Make Sure You Do Not Miss a Shot

If you are concerned that you might miss a shot, press the shutter-release button all the way without first pressing it halfway.

📷 More Information

See "Focusing on Subject" (📖79) for more information.

Step 5 Play Back Images

1 Press the (playback) button.

- When you switch from shooting mode to playback mode, the last image saved will be displayed in full-frame playback mode.

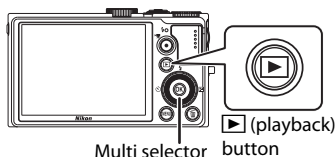

2 Use the multi selector to view previous or next images.

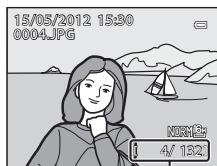

- To view previous images: ▲ or ◀
- To view next images: ▼ or ▶
- Images can also be selected by rotating the multi selector.
- To play back images that are saved in the internal memory, remove the memory card. **IN** is displayed in brackets, before "Current image number/total number of images" on the playback screen.



Current image number / Total number of images



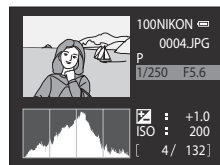

- To return to shooting mode, press the  button again, or press the shutter-release button, or  (movie-record) button.

Displaying Shooting Information

Press the  button in full-frame playback mode to display the histogram and shooting information (8). Press the  button again to return to full-frame playback mode.



Viewing Pictures

- Pictures taken using face detection (80) or pet detection (47) will be rotated automatically when displayed in full-frame playback mode according to the orientation of the face.
- The orientation of an image can be changed using **Rotate image** in the playback menu (84).
- When pictures taken with the continuous shooting feature are displayed, each series of images is treated as a group, and only the group's "key picture" is displayed (see "Sequence display options" (85) for more information). While the key picture of a sequence is displayed in full-frame playback mode, press the  button to display each image in the sequence individually. To return to key picture only display, press the multi selector ▲.
- Images may be displayed at low resolution immediately after switching to the previous or next image.

Changing How Images Are Displayed

When using playback mode, you can change how images are displayed by rotating the zoom control toward **W** (📐)/**T** (📏).

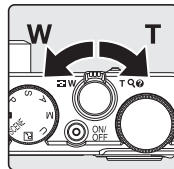

Playback Zoom

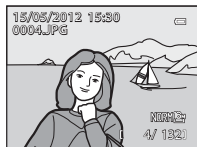

Image is displayed in full-frame playback mode.

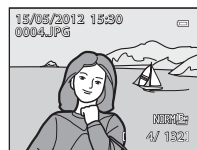

Image is zoomed in.

Display position guide

- To adjust the zoom ratio, rotate the zoom control toward **W** (📐)/**T** (📏) or rotate the command dial. The zoom increases up to about 10x.
- To view a different area of the image, press the multi selector ▲, ▼, ◀, or ▶.
- Pictures taken using face detection (📖80) or pet detection (📖47) are enlarged at the center of the face that was detected during shooting. If the camera detected multiple faces when the image was captured, use ▲, ▼, ◀, and ▶ to display a different face. Change the zoom ratio and press ▲, ▼, ◀, or ▶ to zoom in on an area of the image where there are no faces.
- You can crop the image and save the displayed area of the image as a separate file by pressing the **MENU** button (🔑23).
- Press the **OK** button to return to full-frame playback mode.

Thumbnail Playback, Calendar Display



Full-frame playback mode

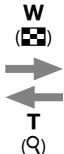



Image thumbnail display
(4, 9, 16 and 72 images per screen)





Calendar display

- You can view several images on one screen, making it easy to find the image you want.
- You can change the number of images displayed by rotating the zoom control toward **W** (📐)/**T** (📏).
- Rotate the multi selector or press ▲, ▼, ◀, or ▶ to select an image and then press the **OK** button to display that image in full-frame playback mode.
- When 72 images are displayed, rotate the zoom control toward **W** (📐) to switch to calendar display.
- While using calendar display mode, rotate the multi selector or press ▲, ▼, ◀, or ▶ to select a date and then press the **OK** button to display the first image captured on that day.

Step 6 Delete Unwanted Images



- 1 Press the  button to delete the image currently displayed on the monitor.



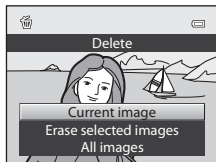

- 2 Press the multi selector  or  to select the desired deletion method and press the  button.

- **Current image:** Only the current image is deleted. If the key picture of a sequence is selected, all images in the sequence are deleted.
- **Erase selected images:** Multiple images can be selected and deleted. See “Operating the Erase Selected Images Screen” (📖33) for more information.
- **All images:** All images are deleted.
- To exit without deleting, press the **MENU** button.



- 3 Press  or  to select **Yes** and press the  button.

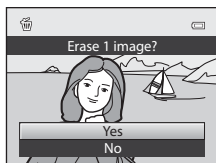

- Deleted images cannot be recovered.
- To cancel, press  or  to select **No** and press the  button.



Notes on Deletion

- Deleted images cannot be recovered. Transfer important images to a computer before deleting them.
- Protected images cannot be deleted (📖84).

Deleting Images in a Sequence

- When images are taken with continuous shooting, each series of images is treated as a group (pictures in a sequence) and only the group's “key picture” is displayed in the default setting (📖14).
- When you press the  button during key picture playback, all images in the key picture's sequence can be deleted (📖15).
- To delete each picture in a sequence, before pressing the  button, press the  button to display each image in the sequence individually.

Deleting the Last Image Captured While in Shooting Mode

When using shooting mode, press the  button to delete the last image that was saved.

Operating the Erase Selected Images Screen

1 Press the multi selector ◀ or ▶ to select an image to be deleted, and then press ▲ to display ✓.

- To cancel the selection, press ▼ to remove ✓.
- Rotate the zoom control (Ⓛ27) toward **T** (🔍) to switch back to full-frame playback or **W** (🖼️) to display thumbnails.



2 Add ✓ to all images that you want to delete and then press the **OK** button to apply the selection.

- A confirmation dialog is displayed. Follow the instructions displayed on the monitor.



A series of horizontal dashed lines spanning the width of the page, intended for handwriting practice. There are 15 lines in total, starting from the top right and extending to the bottom left.

Shooting Features

This chapter describes each of the camera's shooting modes and the features that are available when using shooting mode.

By referring to this information, you will learn how to select different shooting modes and adjust settings according to the shooting conditions and the kind of images you want to capture.

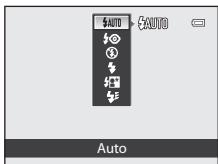
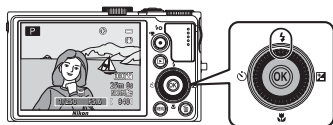
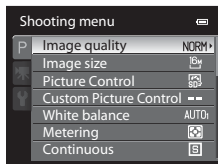
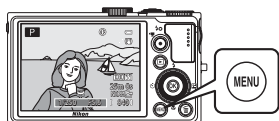
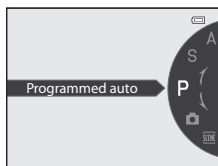
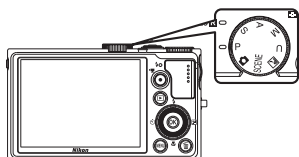

(Auto) Mode

Shoot easily with basic camera operations without going into detailed settings.

The camera selects the focus area for autofocus in accordance with the composition or subject.

- When the camera detects the main subject, it focuses on that subject (Target finding AF).
- The camera has nine focus areas, and if it does not detect the main subject, it automatically selects the focus areas containing the subject closest to the camera.
- See “Using the Target Finding AF” (📖79) for more information.

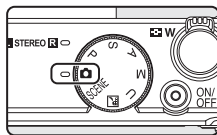

Changing (Auto) Mode Settings

- See “Features That Can Be Set Using the Multi Selector” (📖59) for more information on flash mode (📖60), self-timer (📖63), smile timer (📖64), focus mode (📖66) and exposure compensation (📖68).
- Functions that can be set using the **MENU** button: The image quality and image size can be set (📖72).

Features That Cannot Be Used Simultaneously

This feature may not be used in combination with certain features (📖75).

Scene Mode (Shooting Suited to Scenes)

When one of the following scenes is selected using the mode dial or the scene menu, images are captured using settings that are optimized for the selected scene.

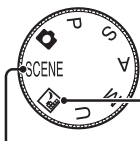

Night landscape (📖38)

Rotate the mode dial to and take pictures.

SCENE (Scene)

Press the **MENU** button to display the scene menu and choose one of the following shooting scenes.

Scene auto selector (default setting) (📖39)	Close-up (📖43)
Portrait (📖39)	Food (📖44)
Landscape (📖40)	Museum (📖44)
Sports (📖40)	Fireworks show (📖44)
Night portrait (📖41)	Black and white copy (📖44)
Party/indoor (📖42)	Backlighting (📖45)
Beach (📖42)	Panorama (📖46)
Snow (📖42)	Pet portrait (📖47)
Sunset (📖42)	Special effects (📖48)
Dusk/dawn (📖42)	3D 3D photography (📖49)

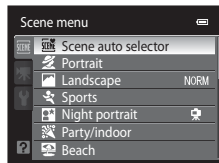
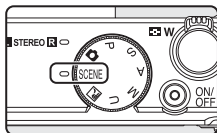

View a Description (Help Information) of Each Scene

Select the desired scene from the scene menu and rotate the zoom control (📖4) toward **T** (🔍) to view a description (help) of that scene. To return to the original screen, rotate the zoom control toward **T** (🔍) again.

More Information

See “Note on the Command Dial Operation When Menus are Displayed” (📖12) for more information.

Changing Scene Mode Settings

- “Features That Can Be Set Using the Multi Selector” (📖59) vary with scene mode. See “List of the Default Settings” (📖69) for more information.
- Functions that can be set using the **MENU** button: The image quality and image size can be set (📖72).

Characteristics of Each Scene

- Use of a tripod is recommended in scene modes with 📐 indicated. Set **Vibration reduction** in the setup menu (📖98) to **Off** when using a tripod to stabilize the camera.
- For scene modes that use the flash, be sure to slide the ⚡🔊 (flash pop-up) control to raise the flash before shooting (📖60).

📷 Night landscape







Use this mode to capture the atmosphere of night landscapes. Press the **MENU** button to select **Hand-held** or **Tripod** in **Night landscape**.



- **Hand-held** (default setting): This enables you to shoot with the minimum of camera shake and noise even when holding the camera by hand.
 - The 📷 icon is displayed on the shooting screen.
 - When the shutter-release button is pressed all the way, pictures are shot continuously, and the camera combines these pictures to save a single picture.
 - Once the shutter-release button is pressed all the way, hold the camera steady without moving it until a still picture is displayed. After taking a picture, do not turn the camera off before the monitor switches to the shooting screen.
 - The angle of view (image area) seen in the saved image will be narrower than that seen on the monitor at the time of shooting.
- **Tripod**: Select this mode when the camera is stabilized, such as with a tripod.
 - The 📐 icon is displayed on the shooting screen.
 - **Vibration reduction** (📖99) is automatically set to **Off** regardless of the applied option in the setup menu.
 - Press the shutter-release button all the way to shoot a single picture at slow shutter speeds.
- When the shutter-release button is pressed halfway, the focus area or focus indicator (📖6) always lights in green.











SCENE →  Scene auto selector

When you frame a picture, the camera automatically selects the optimum scene for simpler shooting.

: Portrait, : Landscape, : Night portrait, : Night landscape, : Close-up, : Backlighting, : Other scenes

- When the camera automatically selects a scene mode, the shooting mode icon changes to that for the scene mode currently enabled.
- The camera automatically selects the focus area for autofocus in accordance with the composition. The camera detects and focuses on faces (see “Using Face Detection” (□80) for more information).
- Depending upon shooting conditions, the camera may not select the desired scene mode. Should this occur, switch to  (auto) mode (□24) or select the optimum scene mode for the subject manually.
- The digital zoom is not available.

Notes on Selecting a Scene Mode Using Scene Auto Selector and Its Shooting Operation

- If the shooting mode icon is  or , the camera performs the optimal operation for shooting a close-up picture of one to two persons. If the icon is  or , the camera performs the optimal operation for shooting a picture of three or more persons or shooting a composition with a large background area.
- If the camera switches to / (Night portrait), the flash mode is fixed at red-eye reduction and the flash is used for capturing portraits (images are not captured continuously) just as when **Tripod** is selected when using **Night portrait** (□41).
- If the camera switches to  (Night landscape), the camera shoots images continuously and combines and saves them as one image, just as when **Hand-held** is selected when using  (Night landscape) (□38).
- If the shooting mode icon is , the camera performs the optimal operation for shooting non-human subjects. If the icon is , the camera performs the operation using face detection that is optimal for shooting human subjects.

SCENE →  Portrait

Use this mode for portraits.

- The camera detects and focuses on a face (see “Using Face Detection” (□80) for more information).
- After the skin softening feature makes facial skin tones softer, the camera records the image (□50).
- If no faces are detected, the camera focuses on the subject at the center of the frame.
- The digital zoom is not available.





Scene Mode (Shooting Suited to Scenes)

SCENE → Landscape

Use this mode for vivid landscapes and cityscapes.

Select **Noise reduction burst** or **Single shot** on the screen that is displayed when  **Landscape** scene mode is selected.



- **Noise reduction burst:** This enables you to shoot a sharp landscape with a minimum of noise.
 - The  icon is displayed on the shooting screen.
 - When the shutter-release button is pressed all the way, pictures are shot continuously, and the camera combines these pictures to save a single picture.
 - Once the shutter-release button is pressed all the way, hold the camera steady without moving it until a still picture is displayed. After taking a picture, do not turn the camera off before the monitor switches to the shooting screen.
 - The angle of view (image area) seen in the saved image will be narrower than that seen on the monitor at the time of shooting.
- **Single shot** (default setting): Records pictures with emphasized outlines and contrast.
 - When the shutter-release button is pressed all the way, one frame is taken.
- When the shutter-release button is pressed halfway, the focus area or focus indicator (6) always lights in green.

SCENE → Sports

Use this mode when shooting sporting events. The camera captures a series of still images that allow you to clearly see detailed movements in a moving subject.

- The camera focuses at the center area of the frame.
- To capture a series of images, hold down the shutter-release button all the way. Up to five pictures are shot at a rate of about seven frames per second (fps) (when image quality is set to **Normal** and image size is set to  **4608x3456**).
- The camera focuses the subject even when the shutter-release button is not pressed halfway. You may hear the sound of the camera focusing.
- Focus, exposure, and hue are fixed at the values determined with the first shot in each series.
- The frame rate with continuous shooting may become slow depending upon the current image quality setting, image size setting, memory card used, or shooting condition.







SCENE →  Night portrait

Use this mode for portraits taken at sunset or at night. Flash is used to illuminate the subject while maintaining the mood of the background.

Select **Hand-held** or **Tripod** on the screen that is displayed when  **Night portrait** scene mode is selected.



- **Hand-held:**
 - The  icon is displayed on the shooting screen.
 - For a scene with a dark background, when the shutter-release button is pressed all the way, pictures are shot continuously. The camera combines these pictures to save a single picture.
 - Once the shutter-release button is pressed all the way, hold the camera steady without moving it until a still picture is displayed. After taking a picture, do not turn the camera off before the monitor switches to the shooting screen.
 - If the subject moves while the camera is shooting continuously, the image may be distorted, overlapped or blurred.
- **Tripod** (default setting): Select this mode when the camera is stabilized, such as with a tripod.
 - The  icon is displayed on the shooting screen.
 - **Vibration reduction** () is automatically set to **Off** regardless of the applied option in the setup menu.
 - Press the shutter-release button all the way to shoot a single picture at slow shutter speeds.
- The camera detects and focuses on a face (see "Using Face Detection" ()80) for more information).
- After the skin softening feature makes facial skin tones softer, the camera records the image ()50).
- If no faces are detected, the camera focuses on the subject at the center of the frame.
- Shoot pictures with the flash raised.
- The digital zoom is not available.

Scene Mode (Shooting Suited to Scenes)

SCENE → Party/indoor

Suitable for taking pictures in parties. Captures the effects of candlelight and other indoor background lighting.

- The camera focuses at the center area of the frame.
- When shooting in a dark location, hold the camera steadily to avoid the effects of camera shake. To take a picture with the camera attached to a tripod, set **Vibration reduction** in the setup menu (📖98) to **Off**.



SCENE → Beach

Captures the brightness of such subjects as beaches or sunlit expanses of water.

- The camera focuses at the center area of the frame.



SCENE → Snow

Captures the brightness of sunlit snow.

- The camera focuses at the center area of the frame.



SCENE → Sunset



Preserves the deep hues seen in sunsets and sunrises.

- When the shutter-release button is pressed halfway, the focus area or focus indicator (📖6) always lights in green.



SCENE → Dusk/dawn



Preserves the colors seen in the weak natural light before sunrise or after sunset.

- When the shutter-release button is pressed halfway, the focus area or focus indicator (📖6) always lights in green.











SCENE →  Close-up

Use this mode to photograph flowers, insects, and other small objects at close range.

Select **Noise reduction burst** or **Single shot** on the screen that is displayed when  **Close-up** scene mode is selected.



- **Noise reduction burst:** This setting enables you to shoot a sharp picture with a minimum of noise.
 - The  icon is displayed on the shooting screen.
 - When the shutter-release button is pressed all the way, pictures are shot continuously, and the camera combines these pictures to save a single picture.
 - Once the shutter-release button is pressed all the way, hold the camera steady without moving it until a still picture is displayed. After taking a picture, do not turn the camera off before the monitor switches to the shooting screen.
 - If the subject moves or there is a significant camera shake during continuous shooting, the image may be distorted, overlapped, or blurred.
 - The angle of view (image area) seen in the saved image will be narrower than that seen on the monitor at the time of shooting.
- **Single shot** (default setting): Records pictures with emphasized outlines and contrast.
 - When the shutter-release button is pressed all the way, one frame is taken.
- The focus mode () setting is changed to  (macro close-up) and the camera automatically zooms to the closest position to the subject where the camera can shoot.
- You can move the focus area that the camera focuses on. Press the  button and then rotate the multi selector or press , , , or  to move the focus area. To adjust the following settings, press the  button to temporarily cancel focus area selection, and then adjust each setting.
 - Flash mode (when **Single shot** is selected)
 - Self-timer
 - Exposure compensation
- The camera focuses on the subject even when the shutter-release button is not pressed halfway. You may hear the sound of the camera focusing.

Scene Mode (Shooting Suited to Scenes)

SCENE → 🍴 Food

Use this mode when taking pictures of food.

- The focus mode (📖66) setting is changed to 🍷 (macro close-up) and the camera automatically zooms to the closest position to the subject where the camera can shoot.
- You can adjust the hue by pressing the multi selector ▲ or ▼. The hue adjustment setting is saved in the camera's memory even after the camera is turned off.
- You can move the focus area that the camera focuses on. Press the OK button and then rotate the multi selector or press ▲, ▼, ◀, or ▶ to move the focus area. To adjust the following settings, press the OK button to temporarily cancel focus area selection, and then adjust each setting.
 - Hue
 - Self-timer
 - Exposure compensation
- The camera focuses on the subject even when the shutter-release button is not pressed halfway. You may hear the sound of the camera focusing.

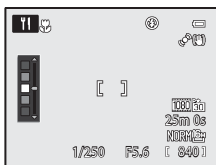

SCENE → 🏛️ Museum

Use indoors where flash photography is prohibited (for example, in museums and art galleries) or in other settings in which you do not want to use the flash.

- The camera focuses at the center area of the frame.
- The camera captures up to ten images while the shutter-release button is pressed all the way, and the sharpest image in the series is automatically selected and saved (BSS (Best Shot Selector) (📖55)).



SCENE → 🎆 Fireworks show



Slow shutter speeds are used to capture the expanding burst of light from fireworks.

- The camera focuses at infinity.
- When the shutter-release button is pressed halfway, the focus indicator (📖6) always lights in green.



SCENE → 📄 Black and white copy

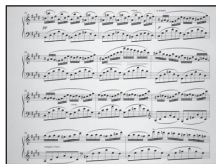

Provides clear images of text or drawings on a white board or in print.

- The camera focuses at the center area of the frame.
- When shooting nearby object, shoot with 🍷 (macro close-up) in the focus mode (📖66).



SCENE →  Backlighting

Use when light is coming from behind the subject, throwing features or details into shadow. HDR (high dynamic range) composition can be set on the screen that is displayed when  **Backlighting** scene mode is selected.











- When **HDR** is set to **Off** (default setting): The flash fires to prevent the backlit subject from being hidden in shadow.
 - Shoot pictures with the flash raised.
 - The camera focuses at the center area of the frame.
 - Press the shutter-release button all the way to shoot a single picture.
- 
- When **HDR** is set to **Level 1-Level 3**: Use when taking pictures with very bright and dark areas in the same frame. Select **Level 1** when there is less difference between bright and dark areas, and **Level 3** when there is more difference between bright and dark areas.
 - The **HDR** icon is displayed on the shooting screen.
 - The camera focuses at the center area of the frame.
 - When the shutter-release button is pressed all the way, the camera shoots pictures continuously and saves the following two images.
 - Non-HDR composite image
 - HDR composite image (loss of detail is reduced in highlights and shadows)
 - The second image saved is an HDR composite image. If there is only enough memory to save one image, an image processed by D-Lighting (📖84) at the time of shooting, in which dark areas of the image are corrected, is the only image saved.
 - Once the shutter-release button is pressed all the way, hold the camera steady without moving it until a still picture is displayed. After taking a picture, do not turn the camera off before the monitor switches to the shooting screen.
 - The angle of view (i.e., the area visible in the frame) seen in the saved image will be narrower than that seen on the monitor at the time of shooting.
 - Depending on the shooting conditions, dark shadows may appear around bright subjects and bright areas may appear around dark subjects. You can compensate by lowering the level setting.
 - Use of a tripod is recommended. Set **Vibration reduction** in the setup menu (📖98) to **Off** when using a tripod to stabilize the camera.
- 

SCENE →  Panorama



Use this mode for shooting panorama pictures.

On the screen that is displayed when  **Panorama** scene mode is selected, select  **Easy panorama** or  **Panorama assist**.

- **Easy panorama** (default setting): Shoots panorama pictures that can be played back on the camera by moving the camera in the direction you want to create a panorama picture.
 - Shooting range can be selected from **Normal (180°)** (default setting) or **Wide (360°)**.
 - Press the shutter-release button all the way and release it, then slowly move the camera in the horizontal direction. Shooting ends automatically when the selected shooting range has been captured.
 - When shooting starts, the camera focuses on the subject at the center area of the frame.
 - The zoom is fixed at the wide-angle position.
 - Display the picture recorded with easy panorama in full-frame playback mode and press the  button. The camera displays the short side of the picture filling the entire screen and scrolls the picture automatically.
See “Taking Pictures with Easy Panorama” (3).
- **Panorama assist**: Use this mode when shooting a series of pictures that can later be joined on a computer to form a single panorama.
 - Press the multi selector  ,  or  to select the direction in which pictures are to be joined and press the  button.
 - After shooting the first picture, shoot the necessary number of pictures while confirming the seams. To finish shooting, press the  button.
 - Transfer taken pictures to a computer and use the Panorama Maker 6 software (88, 7) to join them in a single panorama. See “Using Panorama Assist” (6) for more information.

Note on Printing Panorama Pictures

When printing panorama pictures, a full view may not be printed depending on the printer settings. Additionally, printing may not be available depending on the printer.

For more information, see your printer’s manual or contact a digital photo lab.

SCENE → 🐾 Pet portrait

Use this mode for shooting pictures of dogs or cats.



- Select **Single** or **Continuous** on the screen that is displayed when 🐾 **Pet portrait** scene mode is selected.
 - **Single**: One picture is captured at a time.
 - **Continuous** (default setting): When the camera focuses on the detected face in **Pet portrait auto release** (default setting) mode, three pictures are shot continuously (frame rate with continuous shooting: approximately three frames per second when image quality is set to **Normal** and image size is set to **4608x3456**). If pet portrait auto release is not used, approximately five pictures can be shot one after the other at the maximum rate of about three frames per second while the shutter-release button is fully held down (when image quality is set to **Normal** and image size is set to **4608x3456**).
- The camera detects and focuses on the face of a dog or cat. In the default setting, when the subject is in focus, the shutter is released automatically (Pet portrait auto release).
- Up to five pet faces are detected simultaneously. When two or more faces are detected, the camera focuses on the face closest to the camera in the frame.
- If a pet's face is not detected, press the shutter-release button halfway to focus on the subject at the center of the frame.
- Press the multi selector ◀ (🔄) to change the pet portrait auto release settings.
 - **Pet portrait auto release** (default setting): When the camera focuses on the detected face, the shutter is released automatically. When **Pet portrait auto release** is set, the 🐾 icon is displayed on the shooting screen.
 - **OFF**: Press the shutter-release button to release the shutter.
- In the following situations, **Pet portrait auto release** is automatically switched to **OFF**.
 - When a continuous shooting series with pet portrait auto release is repeated five times
 - When remaining capacity of the internal memory or memory card is low
 To continue shooting with pet portrait auto release, press the multi selector ◀ (🔄) to set again.
- The digital zoom is not available.
- Under some shooting conditions such as pet-to-camera distance, speed of moving pets, direction in which the pets are facing, and brightness of the faces, the camera may be unable to detect a dog or cat, or a border is displayed around something other than a dog or cat.

Viewing Pictures Taken Using Pet Detection

- During playback, the camera automatically rotates images according to the orientation of the pet's face detected at the time of shooting (except for pictures taken with continuous shooting).
- When zooming in on an image displayed in full-frame playback mode by rotating the zoom control toward **T** (🔍), the image is enlarged at the center of a pet's face detected during shooting (📐31) (except for pictures taken with continuous shooting).

SCENE → Special effects

You can add special effects for shooting. One of the following effects is selected on the screen that is displayed when  **Special effects** scene mode is selected.

- **Soft:** (default setting): Gently blur the entire picture to create a soft ambience.
 - **Nostalgic sepia:** Add a sepia tone with low contrast to make it look like an old picture.
 - **High-contrast monochrome:** Create a black-and-white photograph with a clear contrast.
 - **High key:** Give the overall image a bright tone.
 - **Low key:** Give the overall image a dark tone.
 - **Selective color:** Create a black and white image in which only the specified color remains.
 - **Painting:** Create images with the ambience of paintings.
 - **High ISO monochrome:** Create monotone (black and white) pictures by intentionally taking pictures with high ISO sensitivity. This setting is effective when shooting subjects in low lighting conditions. The pictures taken may contain noise (randomly-spaced bright pixels, fog or lines).
 - **Silhouette:** Create a silhouette photograph of a subject with a bright background.
- The camera focuses at the center of the frame.

- When **Selective color** is set, select a color that you want to retain from the slider by rotating the multi selector or pressing ▲ or ▼. To adjust the following settings, press the  button to temporarily cancel color selection, and then adjust each setting.

- Flash mode
- Self-timer
- Focus mode
- Exposure compensation

To return to the color selection screen, press the  button again.

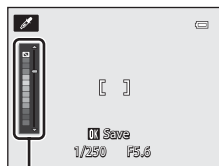

Slider

Special Effects Setting

When **Movie options** ( 95) is set to **VGA120 HS 120 fps (640×480)**, **Soft**, **Nostalgic sepia** or **Painting** cannot be selected.

SCENE → 3D 3D photography

Use this mode for taking 3D pictures viewable in three dimensions on a 3D-compatible TV or monitor. The camera takes one picture for each eye to simulate a three-dimensional image. Pictures taken in this mode are saved with **Normal** as the image quality and **16:9 2M 1920×1080** as the image size.

- After taking the first picture by pressing the shutter-release button, move the camera horizontally to the right so that the subject is aligned with the guide on the monitor. The camera takes the second picture automatically.
- The focus area that the camera focuses on can be moved to areas other than at the center of the frame. To move the focus area, press the **OK** button before taking the first picture, and then rotate the multi selector or press **▲**, **▼**, **◀**, or **▶**.
To adjust the following settings, press the **OK** button to cancel the status in which the focus area can be selected, and then perform each setting.
 - Focus mode **AF** (Autofocus) or **MF** (Macro close-up)
 - Exposure compensation
- The digital zoom is not available.
- The angle of view (i.e., the area visible in the frame) seen in the saved picture will be narrower than that seen on the monitor at the time of shooting.
- The camera cannot record 3D movies.
- The two captured images are saved as a 3D picture (MPO file) consisting of the left and right eye images. The first image (the left eye image) is also saved as a JPEG file. See "Using 3D Photography" (808) for more information.

✔ Note on 3D Photography

The camera may be unable to take a second picture or save pictures taken, depending on a variety of factors, for example, shooting a moving subject or a scene with low light or low contrast conditions.

✔ Viewing 3D Photography

- 3D pictures cannot be played back in 3D on the camera monitor. Only the left eye image is displayed during playback.
- To view 3D pictures in 3D, a 3D-compatible TV or monitor is required. 3D pictures can be played back in 3D by connecting the camera to a 3D-compatible TV or monitor using a 3D-compatible HDMI cable (886).
- When connecting the camera using an HDMI cable, set the following for the **TV settings** in the setup menu (98).
 - **HDMI: Auto** (default setting) or **1080i**
 - **HDMI 3D output: On** (default setting)
- When the camera is connected using an HDMI cable for playback, it may take a while to switch the display between 3D pictures and non-3D pictures. The images played back in 3D cannot be enlarged.
- See the documentation included with your TV or monitor to perform settings of the TV or monitor.

✔ Note on Viewing 3D Pictures

When viewing 3D pictures on a 3D-compatible TV or monitor for an extended period of time, you may experience discomfort such as eye strain or nausea. Carefully read the documentation included with your TV or monitor to ensure proper use.

Using Skin Softening

In the following shooting modes, the camera detects up to three human faces when the shutter is released, and processes the image to make facial skin tones softer before saving the image.

- **Scene auto selector** (📖39), **Portrait** (📖39) or **Night portrait** (📖41) in scene mode

Skin softening can also be applied to saved images (📖84).

✔ Notes on Skin Softening

- It may take more time to save images.
- Under some shooting conditions, the desired skin softening results may not be achieved, and skin softening may be applied to areas of the image where there are no faces.

P, S, A, M Modes (Setting the Exposure for Shooting)

Pictures can be shot with greater control by setting the shooting menu (📖54) items in addition to setting the shutter speed or aperture value manually according to shooting conditions and requirements.

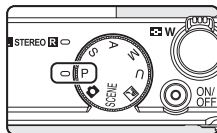

- The focus area for autofocus differs depending on the setting of **AF area mode** that can be selected in the **P, S, A** or **M** tab after pressing the **MENU** button.
- The camera has nine focus areas, and when **AF area mode** is set to **Auto** (default setting), it automatically selects the focus areas containing the subject closest to the camera. When the subject is in focus, the focus areas that are in focus (up to nine areas) light in green.

The procedure for shooting pictures at the desired brightness (exposure) by adjusting the shutter speed or aperture value is called “determine exposure.” The sense of dynamism and amount of background defocus in pictures to be shot vary depending on the combinations of shutter speed and aperture value even if the exposure is the same (📖52).

Rotate the command dial or multi selector to set the shutter speed and aperture value.

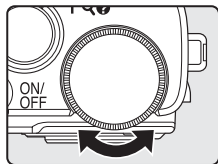

Command dial

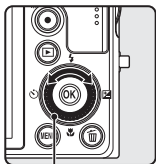

Multi selector

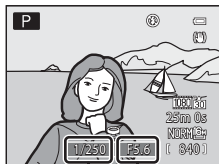

Shutter speed

Aperture value

Exposure mode	Shutter speed (📖78)	Aperture value (📖52)
P Programmed auto (📖53)	Automatically adjusted (flexible program is enabled by the command dial).	
S Shutter-priority auto (📖53)	Adjusted by the command dial.	Automatically adjusted.
A Aperture-priority auto (📖53)	Automatically adjusted.	Adjusted by the multi selector.
M Manual (📖53)	Adjusted by the command dial.	Adjusted by the multi selector.

The setting method for the flexible program, shutter speed, or aperture value can be changed using the **Toggle Av/Tv selection** in the setup menu (📖98).

Adjusting the Shutter Speed



Faster
1/1000 s



Slower
1/30 s

Adjusting the Aperture Value



Larger aperture
(Small f-number)
f/1.8



Smaller aperture
(Large f-number)
f/8

Aperture and Zoom

The aperture value (f-number) indicates the lens brightness. Large apertures (expressed by small f-numbers) let more light into the camera, and small apertures (large f-numbers) let less light. The aperture value of this camera zoom lens can be changed depending on the zoom position. The largest aperture at the wide-angle position is f/1.8 and that at the telephoto zoom position is f/4.9.

U (User Settings) Mode

Even when the mode dial is set to **U** (User settings) mode, you can shoot in **P** (Programmed auto), **S** (Shutter-priority auto), **A** (Aperture-priority auto) or **M** (Manual). The setting combinations (user settings) that are frequently used for shooting can be saved in **U** (☞58).

P (Programmed auto) (🔑10)

Use for automatic control of the exposure by the camera.

- Different combinations of shutter speed and aperture value can be selected without changing the exposure by rotating the command dial during shooting ("flexible program"). While flexible program is in effect, a flexible program mark (✖) is displayed next to the mode indicator (P) in the upper left of the monitor.
- To cancel flexible program, rotate the command dial until the flexible program mark (✖) is no longer displayed. Selecting another shooting mode, or turning off the camera, also cancels flexible program.

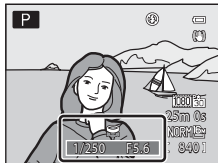

S (Shutter-priority auto) (🔑10)

Use to shoot fast moving subjects with a fast shutter speed, or use to emphasize the movements of a moving subject with a slow shutter speed.

- The shutter speed can be adjusted by rotating the command dial.

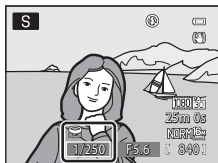

A (Aperture-priority auto) (🔑10)

Use to blur the background or bring both the foreground and background into focus.

- The aperture value can be adjusted by rotating the multi selector.

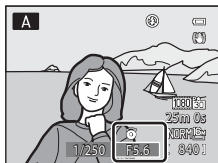

M (Manual) (🔑12)

Use to control the exposure according to shooting requirements.

- When adjusting the aperture value or shutter speed, the degree of deviation from the exposure value measured by the camera is displayed in the exposure indicator. The degree of deviation in the exposure indicator is displayed in EVs (-2 to +2 EV in increments of 1/3 EV).
- The shutter speed can be adjusted by rotating the command dial and the aperture value can be adjusted by rotating the multi selector.

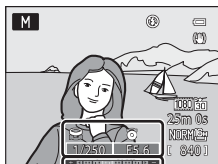

Exposure indicator

Changing P, S, A, M Modes

- See “Features That Can Be Set Using the Multi Selector” (📖59) for more information on flash mode (📖60), self-timer (📖63)/smile timer (📖64), focus mode (📖66) and exposure compensation (📖68).
- See “Options Available in the Shooting Menu” (below) for more information on functions that can be set using the **MENU** button.





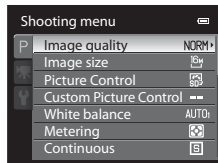



Options Available in the Shooting Menu

In the **P, S, A, M** mode, the following option settings can be changed.















Select **P, S, A, M** mode → **MENU** button → **P, S, A, M** tab (📖11)

Option	Description	📖
Image quality	Set the image quality to be recorded (compression ratio) (📖72). The default setting of image quality is Normal . This setting is also applied to other shooting modes (except for shooting mode U or scene mode Easy panorama or 3D photography).	72
Image size ¹	Set the image size to be recorded (📖73). The default setting is 4608×3456 . This setting is also applied to other shooting modes (except for shooting mode U or scene mode Easy panorama or 3D photography).	73
Picture Control ¹ (COOLPIX Picture Control)	Change the settings for image recording according to the shooting scene or your preferences. The default setting is Standard .	📷34
Custom Picture Control (COOLPIX Custom Picture Control)	Allow you to store the customized settings based in COOLPIX Picture Control, which can set picture editing options for recording images according to the shooting scene or your preferences.	📷38

Option	Description	
White balance ¹	Adjust colors in the image closer to the colors as they appear to the eye. Although Auto (normal) (default setting) can be used under most types of lighting, you can apply the white balance setting suited to the sky conditions or light source to achieve better results if the default setting results are unsatisfactory. <ul style="list-style-type: none"> The preset value for preset manual applies commonly to P, S, A, M, U shooting modes. 	 39
Metering ¹	Select the method that the camera uses to measure the brightness of the subject. The camera adjusts the exposure, which is a combination of shutter speed and aperture value, based on the brightness measurement. The default setting is Matrix .	 41
Continuous ¹	Set the mode used for taking a series of pictures. <ul style="list-style-type: none"> The default setting is Single (i.e. only one picture is captured at a time). When Continuous H, Continuous L, Pre-shooting cache, or BSS (44) is set, the pictures are shot continuously while the shutter-release button is fully held down. If Continuous H: 120 fps, Continuous H: 60 fps, or Multi-shot 16 is set, the specified number of pictures are shot continuously when the shutter-release button is fully held down. If the Intvl timer shooting is set, the pictures are shot continuously at the set interval of 30 s, 1 min, 5 min, or 10 min when the shutter-release button is fully held down once. 	 42
ISO sensitivity ¹	Higher ISO sensitivity allows you to take pictures of darker subjects. Additionally, even with subjects of similar brightness, pictures can be taken at faster shutter speeds, and blurring caused by camera shake and subject movement can be reduced. When ISO sensitivity is set to Auto (default setting), the camera sets the ISO sensitivity automatically. <ul style="list-style-type: none"> In M (manual) mode, ISO sensitivity is fixed at ISO 100 if Auto or Fixed range auto is selected. 	 46
Exposure bracketing	The exposure (brightness) can be changed automatically during continuous shooting. The default setting is Off .	 47
AF area mode ¹	Set how the camera determines the focus area using the autofocus to Face priority, Auto (default setting), Manual, Center, Subject tracking or Target finding AF .	 48

P, S, A, M Modes (Setting the Exposure for Shooting)

Option	Description	
Autofocus mode	When Single AF (default setting) is selected, the camera focuses only while the shutter-release button is pressed halfway. When Full-time AF is selected, the camera focuses even when the shutter-release button is not pressed halfway. You may hear the sound of the camera focusing.	 52
Flash exp. comp.	Compensate the flash output. Use this option when the flash is too bright or too dark. The default setting is 0.0 .	 53
Noise reduction filter	Set the strength of the noise reduction function that is normally performed when recording the picture. The default setting is Normal .	 53
Active D-Lighting	Prevent loss of contrast details in highlights and shadows when shooting images. The default setting is Off .	 54
Save user settings	The current settings are stored in mode dial U ( 57).	58
Reset user settings	The settings saved to mode dial U are reset.	58
Zoom memory	When the zoom control is operated when set to On , the camera changes in steps to the focal length (equivalent to 35mm [135] format of angle of view) of the zoom lens that is set in advance. The default setting is Off . <ul style="list-style-type: none"> Select On and press the  button to display the screen for focal length selection. Press the  button to switch the On []/Off setting, then press the multi selector  to apply the selection. 	 55
Startup zoom position ²	When the camera is turned on, the zoom position moves to the focal length (equivalent to 35mm [135] format of angle of view) of the zoom lens that is set in advance. The default setting is 24 mm .	 55

¹ The setting menu can also be displayed by pressing the **Fn** (FUNC) button during shooting. Select the **Fn button** function in the setup menu ( 98), and then assign a setting menu to be displayed when the **Fn** (FUNC) button is pressed.

² This function cannot be set when using **U** mode.

More Information

See “Note on the Command Dial Operation When Menus are Displayed” ( 12) for more information.

Features That Cannot Be Used Simultaneously

This feature may not be used in combination with certain features ( 75).

U (User Setting Modes)

Setting combinations that are frequently used for shooting (User settings) can be saved in **U**. Shooting is possible in **P** (Programmed auto), **S** (Shutter-priority auto), **A** (Aperture-priority auto) or **M** (Manual).

Rotate the mode dial to **U** to retrieve the settings saved in **Save user settings**.

See "Saving Settings in **U** Mode" (📖58) for more information.

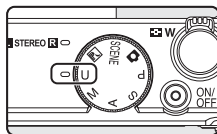

- Frame the subject and shoot with these settings, or change the settings as required.
- The setting combinations that are retrieved when the mode dial is rotated to **U** can be changed as many times as you want in **Save user settings**.

In **U**, the following settings can be saved.

General setup

- Shooting mode **P**, **S**, **A** or **M** (📖51)¹
- Flash mode (📖60)
- Exposure compensation (📖68)
- Zoom position (📖27)²
- Focus mode (📖66)³

Shooting menu

- Image quality (📖72)
- Picture Control (📖54)
- Metering (📖55)
- ISO sensitivity (📖55)
- AF area mode (📖55)⁵
- Flash exp. comp. (📖56)
- Active D-Lighting (📖56)
- Image size (📖73)
- White balance (📖55)⁴
- Continuous (📖55)
- Exposure bracketing (📖55)
- Autofocus mode (📖56)
- Noise reduction filter (📖56)
- Zoom memory (📖56)

¹ Choose the standard shooting mode. The current flexible program (when set to **P**), shutter speed (when set to **S** or **M**) or aperture value (when set to **A** or **M**) settings will also be saved.

² The current zoom position will also be saved. **Startup zoom position** (📖56) cannot be set.

³ The current focus distance will also be saved when set to **MF** (manual focus).

⁴ The preset value for preset manual applies commonly to **P**, **S**, **A**, **M** and **U** shooting modes.

⁵ The current focus area position is saved when **AF area mode** is set to **Manual**.

Saving Settings in U Mode

1 Rotate the mode dial to the desired exposure mode.

- Rotate to **P**, **S**, **A** or **M**.
- Settings can be saved even if rotated to **U** (the default settings of shooting mode **P** are saved when the camera is first purchased).

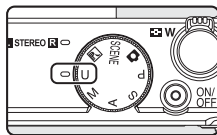

2 Change to a frequently used combination of shooting settings.

- See “U (User Setting Modes)” (p.57) for more information about the saved settings.

3 Press the **MENU** button.

- The shooting menu is displayed.

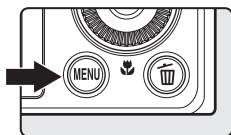

4 Use the multi selector to select **Save user settings**, and press the **OK** button.

- **Done** screen is displayed, and the current settings are saved.

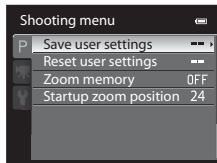

✔ Note on Clock Battery

If the internal clock battery (p.23) is exhausted, the settings saved in **U** will be reset. Writing down any important setting is recommended.

✎ Resetting for User settings

If **Reset user settings** is selected, the settings that are saved in the user settings are reset as follows:

- Shooting mode: **P** (Programmed auto)
- Zoom position: maximum wide-angle position
- Flash mode: **⚡AUTO** (Auto)
- Focus mode: **AF** (Autofocus)
- Exposure compensation: 0.0
- Shooting menu: Same as the default setting for each item

Features That Can Be Set Using the Multi Selector

Press the multi selector **▲** (🔦), **◀** (🕒), **▼** (🌸), or **▶** (📷) while shooting to operate the following functions.

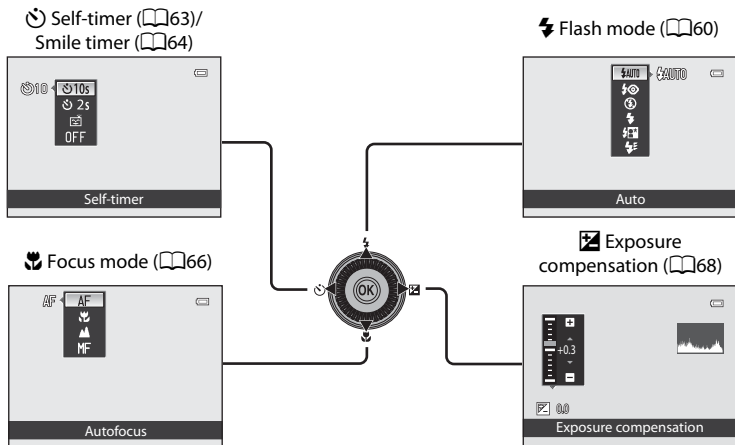

Available Functions

Available functions differ according to the shooting mode as follows.

- See “List of the Default Settings” (📖69) for more information on the default settings in each shooting mode.

Function	📷	SCENE, 📷	P, S, A, M, U
🔦 Flash mode (📖60)	✓	1	✓
🕒 Self-timer (📖63)	✓		✓
📷 Smile timer (📖64)	✓		✓
🌸 Focus mode (📖66)	✓		✓
📷 Exposure compensation (📖68)	✓		✓ ²

¹ The setting varies with scene mode. See “List of the Default Settings” (📖69) for more information.

² When the shooting mode is **M**, exposure compensation cannot be used.

Using the Flash (Flash Modes)

You can shoot pictures with a flash by raising the flash. You can set a flash mode that suits the shooting conditions.

1 Slide the (flash pop-up) control to raise the flash.

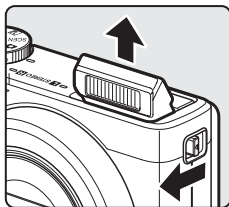

- When the flash is lowered, the flash mode is fixed at  (off).



2 Press (flash mode) on the multi selector.



3 Use the multi selector to select the desired mode and press the button.

- See “Available Flash Modes” (p.61) for more information.
- If the  button is not pressed within a few seconds, the selection will be canceled.
- When  (auto) is applied,  is only displayed for a few seconds, regardless of **Photo info** settings (p.98).

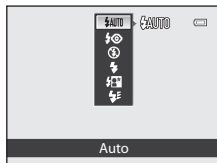

4 Frame the subject and take a picture.

- The flash lamp indicates the status of the flash when the shutter-release button is pressed halfway.
 - On: The flash will fire when you press the shutter-release button all the way.
 - Flashing: The flash is charging. The camera cannot take pictures.
 - Off: The flash will not fire when a picture is taken.
- If the battery is low, the monitor will be turned off while the flash is charging.

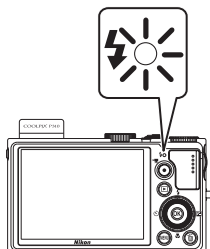

✓ Lowering the Flash

When not using the flash, gently push to lower the flash until it clicks shut.

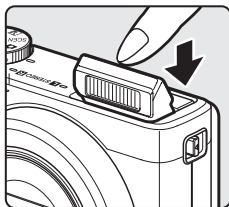

📌 Effective Range of the Flash

The flash has a range of about 0.5 to 6.5 m (1 ft 8 in. to 21 ft) for wide-angle position, and about 0.5 to 2.5 m (1 ft 8 in. to 8 ft 2 in.) for telephoto zoom position (when **ISO sensitivity** is set to **Auto**).

Available Flash Modes



Auto

Flash fires automatically when lighting is dim.



Auto with red-eye reduction

Best choice for portraits. Reduces red-eye effect caused by flash in portraits (📖62).



Off

Flash does not fire.

- Use of a tripod is recommended to avoid the effects of camera shake when shooting in a dark location.



Fill flash

The flash fires when a picture is taken, regardless of how bright the subject is. Use to “fill-in” (illuminate) shadows and backlit subjects.



Slow sync



Fill flash is combined with a slow shutter speed. Suitable for portraits of human subjects shot at night or under dim light. Flash illuminates main subject; slow shutter speeds are used to capture background.



Rear-curtain sync

Fill flash fires just before the shutter closes, creating the effect of a stream of light behind moving subjects.

Flash Mode Setting

- The setting varies with shooting mode. See “Available Functions” (📖69) and “List of the Default Settings” (📖69) for more information.
- This feature may not be used in combination with certain features. See “Features That Cannot Be Used Simultaneously” (📖75).
- The changed flash mode setting applied in the following situations is saved in the camera’s memory even after the camera is turned off.
 - When shooting mode **P**, **S**, **A** or **M** is used
 - When  (auto with red-eye reduction) is selected in  (auto) mode

Auto with Red-eye Reduction

This camera uses **advanced red-eye reduction (“In-Camera Red-Eye Fix”)**.

If the camera detects “red-eye” when a picture is taken, Nikon’s own In-Camera Red-Eye Fix processes the image before it is recorded.

Note the following when taking pictures:

- The time required to save the picture increases slightly.
- Advanced red-eye reduction may not produce the desired results in some situations.
- In extremely rare instances, areas not subject to red-eye may be affected by advanced red-eye reduction processing. In these cases, choose another mode and try again.

Using the Self-timer

The self-timer is suitable for taking group pictures and reducing the vibration when the shutter-release button is pressed.

When using the self-timer, use of a tripod is recommended. Set **Vibration reduction** in the setup menu (📖98) to **Off** when using a tripod to stabilize the camera.

- 1 Press ◀ (🕒 self-timer) on the multi selector.

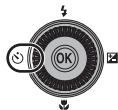

- 2 Use the multi selector to select 🕒 10s (or 🕒 2s) and press the OK button.

- 🕒 10s (ten seconds): suitable for group pictures.
- 🕒 2s (two seconds): suitable for preventing camera shake.
- When the shooting mode is set to **Pet portrait** in scene mode, 🐾 (Pet portrait auto release) is displayed (📖47). The self-timer 🕒10s and 🕒2s are not available.
- The mode selected for the self-timer is displayed.
- If the OK button is not pressed within a few seconds, the selection will be canceled.

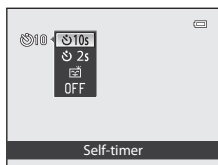

- 3 Frame the picture and press the shutter-release button halfway.

- Set the focus and exposure.

- 4 Press the shutter-release button all the way.

- The self-timer starts, and the number of seconds remaining before the shutter is released is displayed. The self-timer lamp flashes while the timer is counting down. About one second before the shutter is released, the lamp stops flashing and remains lit.
- When the shutter is released, the self-timer turns **OFF**.
- To stop the timer before a picture is taken, press the shutter-release button again.

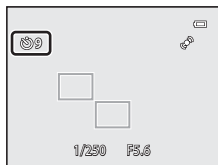

Smile Timer (Shooting Smiling Faces)

When this mode is selected, the camera detects smiling faces and automatically releases the shutter even if you don't press the shutter-release button.

- This function can be used when the shooting mode is (auto), **P**, **S**, **A**, **M**, **U**, scene mode **Portrait** or **Night portrait**.

1 Press (self-timer) on the multi selector.

- Change any flash mode, exposure, or shooting menu settings before pressing the button.

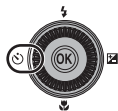

2 Use the multi selector to choose (Smile timer), and press the button.

- If the button is not pressed within a few seconds, the selection will be canceled.

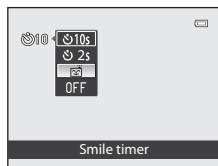

3 Frame the picture and wait for the subject to smile without pressing the shutter-release button.

- When the camera detects a face, a yellow double border (focus area) is displayed around that face. When the camera has focused on that face, the double border will turn green for a moment and focus is locked.
- Up to three faces are detected. When more than one face is detected, the face closest to the center of the frame is framed by a double border and the others by single borders.
- If the camera detects that the face framed by the double border is smiling, the shutter is automatically released.
- Each time the shutter is released, automatic shooting using face detection and smile detection is repeated.

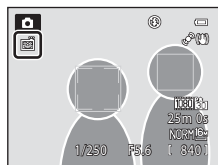

4 Finish shooting.

- To cancel smile detection and finish shooting, return to step 1 and select **OFF**.

Notes on Smile Timer

- The digital zoom is not available.
- Under some shooting conditions, faces and smiling faces may not be detected properly.
- See "Using Face Detection" (📖80) for more information.
- The smile timer cannot be used simultaneously with certain shooting modes. See "Available Functions" (📖59) and "List of the Default Settings" (📖69) for more information.
- This feature may not be used in combination with certain features. See "Features That Cannot Be Used Simultaneously" (📖75) for more information.

Auto Off in Smile Timer Mode

When using the smile timer, the auto off function (📖99) is activated and the camera turns off when either of the situations indicated below persists and no other operations are performed.

- The camera does not detect any faces.
- The camera detected a face, but cannot detect a smile.

When the Self-timer Lamp Flashes

When the camera detects a face, the self-timer lamp flashes. The lamp quickly flashes immediately after the shutter is released.

Releasing the Shutter Manually

The shutter can also be released by pressing the shutter-release button. If no faces are detected, the camera focuses on the subject at the center of the frame.

More Information

See "Autofocus" (📖29) for more information.

Using Focus Mode

Choose a focus mode according to the desired scene.

1 Press **▼** (📄 focus mode) on the multi selector.



2 Use the multi selector to choose the desired focus mode and press the **OK** button.

- See “Available Focus Modes” (📖67) for more information.
- If the **OK** button is not pressed within a few seconds, the selection will be canceled.
- When **AF** (autofocus) is applied, **AF** is only displayed for a few seconds regardless of **Photo info** settings (📖98).

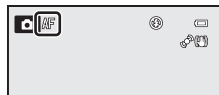
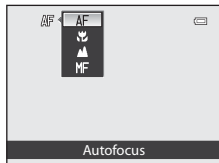



Available Focus Modes

AF Autofocus

The camera automatically adjusts the focus according to the distance to the subject. Use when the distance from the subject to the lens is 30 cm (1 ft) or more, or 60 cm (2 ft) or more at the maximum telephoto zoom position.

Macro close-up

Use for close-ups of flowers or small objects.

How close you can be to the subject while shooting depends on the zoom position. When the zoom position is set to a position where  and the zoom indicator light in green, the camera can focus on subjects as close as 9 cm (3.6 in.) from the lens. At the maximum wide-angle zoom position (the zoom position ) , the camera can focus on subjects as close as 2 cm (0.8 in.) from the lens.

Infinity

Use when shooting distant scenes through window glass or when shooting landscapes. The camera automatically adjusts the focus near infinity.

- The camera may not be able to focus on nearby objects.
- The flash mode is set to  (off).

MF Manual focus

The focus can be adjusted for any subject that is a distance of 2 cm (0.8 in.) to infinity from the lens (2). The closest distance at which the camera can focus varies depending on the zoom position.

- This function can be used when the shooting mode is **P**, **S**, **A**, **M**, **U**, scene mode **Sports** or **Special effects**.

Note on Shooting with the Flash

When the shooting distance is less than 50 cm (1 ft 8 in.), the flash may be unable to light up the entire subject.

Focus Mode Setting

- The setting varies with the shooting mode. See “Available Functions” (□□59) and “List of the Default Settings” (□□69) for more information.
- This feature may not be used in combination with certain features. See “Features That Cannot Be Used Simultaneously” (□□75) for more information.
- For shooting modes **P**, **S**, **A** and **M**, the changed focus mode setting is saved in the camera’s memory even after the camera is turned off.

Macro Close-up

When using **P**, **S**, **A**, **M** or **U** mode if **Autofocus mode** in the shooting menu (□□54) is set to **Full-time AF**, the camera will adjust focus even if the shutter-release button is not pressed halfway.

When using other shooting modes, **Full-time AF** is turned on automatically when macro close-up is turned on.

You may hear the sound of the camera focusing.

Adjusting Brightness (Exposure Compensation)

By adjusting exposure compensation when taking pictures, you can adjust overall image brightness.

- 1 Press **▶** (☒ exposure compensation) on the multi selector.



- 2 Press the multi selector **▲** or **▼** to select a compensation value.

- To make the image brighter, apply positive (+) exposure compensation.
- To make the image darker, apply negative (-) exposure compensation.

Exposure compensation guide

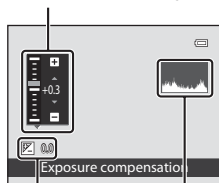

Exposure compensation value

Histogram

- 3 Press the **OK** button.

- If the **OK** button is not pressed within a few seconds, the selection is set and the setting menu disappears.
- Even when the shutter-release button is pressed without pressing the **OK** button, a picture can be shot using the selected compensation value.
- When an exposure compensation value other than **0.0** is applied, the value is displayed with the ☒ icon on the monitor.

- 4 Press the shutter-release button to take a picture.

- To turn off exposure compensation, return to step 1, change the value to **0.0**.



Exposure Compensation Value

- The changed exposure compensation value applied in **P**, **S** or **A** mode is saved in the camera's memory even after the camera is turned off.
- When the shooting mode is the **Fireworks show** scene mode (📖44) or **M** (Manual) (📖53), the exposure compensation cannot be used.

Using the Histogram





A histogram is a graph showing the distribution of tones in the image. Use as a guide when using exposure compensation and shooting without the flash.

- The horizontal axis corresponds to pixel brightness, with dark tones to the left and bright tones to the right. The vertical axis shows the number of pixels.
- Increasing exposure compensation shifts tone distribution to the right, and decreasing it shifts tone distribution to the left.



List of the Default Settings

The default settings in each shooting mode are described below.

- Similar information about scene mode can be found on the next page.

Shooting mode	Flash mode ¹ (📖60)	Self-timer (📖63)	Focus mode (📖66)	Exposure compensation (📖68)
 (auto) (📖36)	 AUTO	OFF	AF ²	0.0
P, S, A, M (📖51)	 AUTO	OFF	AF	0.0
U (User settings) (📖57)	 AUTO	OFF	AF	0.0











































































¹ When the flash is lowered, the flash mode is fixed at  (off).











² **AF** (autofocus),  (macro close-up) or  (infinity) can be selected.

- The setting applied in shooting modes **P**, **S**, **A** and **M** is saved in the camera's memory even after the camera is turned off (except for self-timer).

Features That Can Be Set Using the Multi Selector

The default settings in scene mode are described below.

	Flash mode ( 60)	Self-timer ( 63)	Focus mode ( 66)	Exposure compensation ( 68)
 ( 38)	 ¹	OFF	 ¹	0.0
 ( 39)	 AUTO ²	OFF	AF ¹	0.0
 ( 39)		OFF ³	AF ¹	0.0
 ( 40)	 ¹	OFF	 ¹	0.0
 ( 40)	 ¹	OFF ¹	AF ⁴	0.0
 ( 41)		OFF ³	AF ¹	0.0
 ( 42)		OFF	AF ¹	0.0
 ( 42)	 AUTO	OFF	AF ⁷	0.0
 ( 42)	 AUTO	OFF	AF ⁷	0.0
 ( 42)	 ¹	OFF	 ¹	0.0
 ( 42)	 ¹	OFF	 ¹	0.0
 ( 43)	 ⁸	OFF	 ¹	0.0
 ( 44)	 ¹	OFF	 ¹	0.0
 ( 44)	 ¹	OFF	AF ⁷	0.0
 ( 44)	 ¹	OFF ¹	 ¹	0.0 ¹
 ( 44)		OFF	AF ⁷	0.0
 ( 45)		OFF	AF ¹	0.0
 ( 46)	 ¹⁰	OFF ¹⁰	AF ¹¹	0.0
 ( 47)	 ¹	 ¹²	AF ⁷	0.0
 ( 48)	 ¹³	OFF	AF	0.0
3D ( 49)	 ¹	OFF ¹	AF ⁷	0.0

- ¹ The setting cannot be changed.
- ²  (auto) or  (off) can be selected. When  (auto) is selected, the camera automatically selects the flash mode appropriate for the scene it has selected.
- ³ Self-timer or smile timer can be set.
- ⁴ **AF** (autofocus) or **MF** (manual focus) can be selected.
- ⁵ The setting cannot be changed. Fill flash fires for red-eye reduction.
- ⁶ May switch to slow sync with red-eye reduction flash mode.
- ⁷ **AF** (autofocus) or  (macro close-up) can be selected.
- ⁸ Flash is fixed at  (off) when using **Noise reduction burst**.
- ⁹ Flash is fixed at  (fill flash) when **HDR** is set to **Off**, and is fixed at  (off) when **HDR** is set to other than **Off**.
- ¹⁰ The setting cannot be changed when using **Easy panorama**.
- ¹¹ The setting cannot be changed when using **Easy panorama**. **AF** (autofocus),  (macro close-up) or  (infinity) can be selected when using **Panorama assist**.
- ¹² The self-timer is not available. Pet portrait auto release (47) can be set to on or off.
- ¹³ Flash is fixed at  (off) when using **High ISO monochrome** and **Silhouette**.

**Features That Cannot Be Used Simultaneously**

This feature may not be used in combination with certain features (75).

Changing the Image Quality and Image Size

The image quality (compression ratio) and image size can be selected for recording.

Available Image Quality

Display the shooting screen → MENU button (📖11) → Shooting menu → Image quality

Lower compression ratios result in higher quality pictures, but also larger file sizes, limiting the number of pictures that can be recorded.

Option	Description
FINE Fine	Finer image quality than Normal , suitable for enlargement or high-quality prints. Compression ratio of about 1:4
NORM Normal (default setting)	Normal image quality, suitable for most applications. Compression ratio of about 1:8
BASIC Basic	Basic image quality is lower than with Normal , suitable for pictures attached to e-mails or used on web pages. Compression ratio of about 1:16

Image Quality Setting

- The setting for image quality is shown by an icon displayed on the monitor during shooting and playback (📖6 to 8).
- The image quality can be changed by selecting **Image quality** and rotating the command dial when menus are displayed.
- The setting is also applied to other shooting modes (except for shooting mode **U** or scene mode **Easy panorama** or **3D photography**).
- This feature may not be used in combination with certain features. See "Features That Cannot Be Used Simultaneously" (📖75) for more information.

More Information

- See "Number of Exposures Remaining" (📖74) for more information.
- See "File and Folder Names" (📖94) for more information.

Available Image Size

Display the shooting screen → MENU button (📖11) → Shooting menu → Image size

You can set the image size (amount of pixels) for pictures recorded.

The larger the image, the larger the size at which it can be printed or displayed without becoming noticeably “grainy,” limiting the number of pictures that can be recorded.

Conversely, small image sizes are suitable for pictures attached to e-mails or used on web pages. However, printing small images in large print sizes results in the image turning “grainy.”

Options*	Description
4608×3456 (default setting)	Record pictures with finer detail than those shot at 3264×2448 or 2272×1704 .
3264×2448	Good balance between file size and quality; suitable in most situations.
2272×1704	
1600×1200	Smaller than 4608×3456 , 3264×2448 and 2272×1704 ; for recording more pictures.
640×480	Record pictures suitable for display on a television with a screen aspect ratio of 4:3, or for e-mail attachment.
4608×2592	Record pictures with the same aspect ratio (16:9) as wide screen TV.
1920×1080	
4608×3072	Record pictures with the same aspect ratio (3:2) as those shot with 35mm [135] format film cameras.
3456×3456	Record square pictures.

* The total number of pixels captured, and the number of pixels captured horizontally and vertically.









Example: 4608 × 3456 = 16 megapixels, 4608 × 3456 pixels

Image Size Setting

- The setting for the image size is shown by an icon displayed on the monitor during shooting and playback (📖6 to 8).
- The image size can be changed by selecting **Image size** and rotating the command dial when menus are displayed.
- The setting is also applied to other shooting modes (except for shooting mode **U** or scene mode **Easy panorama** or **3D photography**).
- This feature may not be used in combination with certain features. See “Features That Cannot Be Used Simultaneously” (📖75) for more information.

Number of Exposures Remaining

The following table lists the approximate number of pictures that can be stored in the internal memory and on a 4 GB memory card, at each combination of **Image size** (📷73) and **Image quality** (📷72) settings. Note that the number of exposures that can be stored differs depending on the composition of the image (due to JPEG compression). In addition, this number may differ depending on the make of memory card, even if the capacity of the memory card is the same.

Image size	Image quality	Internal memory (90 MB)	Memory card ¹ (4 GB)	Print size ² (cm/in.)
 4608×3456 (default setting)	Fine	11	470	39 × 29/ 15 × 11.5
	Normal	19	840	
	Basic	35	1,480	
 3264×2448	Fine	22	930	28 × 21/11 × 8
	Normal	39	1,650	
	Basic	68	2,870	
 2272×1704	Fine	44	1,880	19 × 14/7.5 × 5.6
	Normal	79	3,350	
	Basic	135	5,740	
 1600×1200	Fine	87	3,650	13 × 10/5.3 × 4
	Normal	149	6,350	
	Basic	247	10,000	
 640×480	Fine	517	20,100	5 × 4/2 × 1.5
	Normal	812	30,100	
	Basic	1,137	40,200	
 4608×2592	Fine	14	620	39 × 22/15 × 8.5
	Normal	26	1,120	
	Basic	46	1,970	
 1920×1080	Fine	81	3,440	16 × 9/6 × 3.5
	Normal	142	6,030	
	Basic	237	10,000	
 4608×3072	Fine	12	530	39 × 26/15 × 10
	Normal	22	950	
	Basic	39	1,670	
 3456×3456	Fine	14	620	29 × 29/ 11.5 × 11.5
	Normal	26	1,120	
	Basic	46	1,970	

1 If the number of exposures remaining is 10,000 or more, "9999" is displayed.

2 The print size at an output resolution of 300 dpi.

Print sizes are calculated by dividing the number of pixels by the printer resolution (dpi) and multiplying by 2.54 cm (1 in.). However, even with the same image size setting, images printed at higher resolutions print smaller than the size indicated, and those printed at lower resolutions print larger than the size indicated.

Printing Images of Size 1:1

Change the printer setting to "Border" when printing images with the size set to 1:1.

The images may not be printed in 1:1 ratio depending on the printer.

See the instruction manual of the printer or check with the authorized print dealer for further details.

Features That Cannot Be Used Simultaneously

Some shooting settings cannot be used in combination with other functions.

Restricted function	Setting	Description
Flash mode	Focus mode (📖66)	When ▲ (infinity) is selected for shooting, the flash is not available.
	Continuous (📖55)	When Continuous H , Continuous L , Pre-shooting cache , Continuous H: 120 fps , Continuous H: 60 fps , BSS or Multi-shot 16 is selected for shooting, the flash is not available.
	Exposure bracketing (📖55)	The flash is not available.
Self-timer/Smile timer	AF area mode (📖55)	When Subject tracking is selected for shooting, the self-timer/smile timer are not available.
Focus mode	AF area mode (📖55)	When Subject tracking is selected, MF (manual focus) is not available.
Image quality	Continuous (📖55)	When Pre-shooting cache or Multi-shot 16 is selected for shooting, Image quality is fixed at Normal .
Image size	Continuous (📖55)	<ul style="list-style-type: none"> When Multi-shot 16 is selected for shooting, Image size is fixed at SM (2560×1920 pixels). When Pre-shooting cache is selected for shooting, Image size is fixed at SM (2048×1536 pixels). When Continuous H: 120 fps is selected for shooting, Image size is fixed at VGA (640×480 pixels) and when Continuous H: 60 fps is selected, Image size is fixed at L (1280×960 pixels).
ISO sensitivity	Continuous (📖55)	When Pre-shooting cache , Continuous H: 120 fps , Continuous H: 60 fps or Multi-shot 16 is selected for shooting, ISO sensitivity is fixed at Auto .
	Active D-Lighting (📖56)	<ul style="list-style-type: none"> When ISO sensitivity is set to Auto and Active D-Lighting is set to any mode other than Off, the maximum value for ISO sensitivity is set to ISO 800. When Active D-Lighting is set to any mode other than Off for shooting, 1600, 3200 or Hi 1 in ISO sensitivity is not available.

Features That Cannot Be Used Simultaneously

Restricted function	Setting	Description
White balance	Picture Control (☞54)	When Monochrome is selected for shooting, White balance is fixed at Auto (normal) .
Picture Control	Active D-Lighting (☞56)	When using Active D-Lighting for shooting, Contrast in manual adjustment cannot be adjusted.
Metering	Active D-Lighting (☞56)	When Active D-Lighting is set to any mode other than Off , Metering is reset to Matrix .
Continuous/ Exposure bracketing	Continuous (☞55)/Exposure bracketing (☞55)	Continuous and Exposure bracketing are not available simultaneously. Exposure bracketing is reset to Off when Continuous is set to any mode other than Single . The setting for Continuous is reset to Single when Exposure bracketing is set to any mode other than Off .
	Self-timer (☞63)/Smile timer (☞64)	Continuous or Exposure bracketing and self-timer/smile timer are not available simultaneously.
	Picture Control (☞54)	Exposure bracketing cannot be used when Monochrome is selected for shooting.
AF area mode	Smile timer (☞64)	The camera takes a picture using face detection regardless of the applied AF area mode option.
	Focus mode (☞66)	<ul style="list-style-type: none"> When a setting other than Subject tracking is selected and ▲ (infinity) is selected as the focus mode for shooting, the camera focuses at infinity regardless of the applied AF area mode option. When set to MF (manual focus), the AF area mode cannot be set.
	Picture Control (☞54)	When Target finding AF is selected and Picture Control is set to Monochrome , AF area mode operates using the Auto setting.
	White balance (☞55)	When Target finding AF is selected and White balance is set to Preset manual , Incandescent or 1 in Fluorescent , AF area mode operates using the Auto setting.
Autofocus mode	Smile timer (☞64)	Autofocus mode option cannot be changed when shooting with the smile timer.
	Focus mode (☞66)	When the focus mode is set to ▲ (infinity), the focus mode operates using the Single AF setting.
	AF area mode (☞55)	When AF area mode is set to Face priority , AF area mode operates using the Single AF setting.
Active D-Lighting	ISO sensitivity (☞55)	When ISO sensitivity is set to 1600 , 3200 or Hi 1 , Active D-Lighting is not available.

Restricted function	Setting	Description
Print date	Continuous (☞55)	When Pre-shooting cache , Continuous H: 120 fps or Continuous H: 60 fps is selected for shooting, print date is not available.
Sound settings	Continuous (☞55)	Shutter sound is disabled when Continuous H , Continuous L , Pre-shooting cache , Continuous H: 120 fps , Continuous H: 60 fps , BSS , or Multi-shot 16 is selected in the shooting menu.
	Exposure bracketing (☞55)	Shutter sound is disabled.
Blink warning	Smile timer (☞64)/ Continuous (☞55)/Exposure bracketing (☞55)	Blink warning does not take effect when using the smile timer, Continuous is set to a setting other than Single , or exposure bracketing is set.
Digital zoom	Smile timer (☞64)	The digital zoom cannot be used when shooting with the smile timer.
	Focus mode (☞66)	The digital zoom cannot be used when MF (manual focus) is selected.
	Continuous (☞55)	The digital zoom cannot be used when Multi-shot 16 is selected for shooting.
	AF area mode (☞55)	The digital zoom cannot be used when shooting with Subject tracking .
	Zoom memory (☞56)	The digital zoom cannot be used when Zoom memory is set to On .

✓ Notes on Digital Zoom

- The digital zoom cannot be used with certain shooting modes.
- When the digital zoom is in effect, selectable options for AF area mode or metering mode are restricted (☞79).

The Control Range of the Shutter Speed (P, S, A, M Modes)

The control range of the shutter speed differs depending on the aperture value or the ISO sensitivity setting. Additionally, the control range changes in the following continuous shooting settings.

Setting		Control range
ISO sensitivity (📖55) ¹	Auto ² , Fixed range auto ²	1/2000 ^{3,4} to 1 s (P, S, A mode) 1/2000 ³ to 8 s (M mode)
	ISO 100	1/2000 ^{3,4} to 4 s (P, S, A mode) 1/2000 ³ to 8 s (M mode)
	ISO 200, 400	1/2000 ^{3,4} to 4 s
	ISO 800	1/2000 ^{3,4} to 2 s
	ISO 1600	1/2000 ^{3,4} to 1 s
	ISO 3200, Hi 1	1/2000 ^{3,4} to 1/2 s
Continuous (📖55)	Continuous H, Continuous L, BSS	1/2000 ^{3,4} to 1/30 s
	Pre-shooting cache, Multi-shot 16	1/4000 to 1/30 s
	Continuous H: 120 fps	1/4000 to 1/125 s
	Continuous H: 60 fps	1/4000 to 1/60 s

¹ The ISO sensitivity setting is restricted depending on the continuous shooting setting (📖75).

² In **M** mode, the ISO sensitivity is fixed at ISO 100.

³ When the aperture value is set to f/1.8 (largest aperture), the shutter speed can be set to maximum 1/1600 second.

⁴ In **P** or **A** mode, when the aperture value is set to f/8 and the zoom is at the maximum wide-angle position or moved one increment to the telephoto position, the shutter speed can be set to maximum 1/1600 second.

Focusing on Subject

The focus area or focus range for adjusting focus varies depending on the shooting mode and focus mode (📖66).

- In **P, S, A, M** or **U** mode, an area can be set to adjust focus by selecting **AF area mode** (📖55) in the shooting menu.
- The camera may be unable to focus on the subjects for which autofocus does not perform as expected (📖29). If the camera does not focus, try pressing the shutter-release button halfway several times or try focus lock (📖81) or manual focus (🔑2).

Using the Target Finding AF

When **AF area mode** in 📷 (auto) mode or **P, S, A, M** or **U** mode is set to **Target finding AF**, the camera will adjust the focus during the following operations if you press the shutter-release button halfway.

- When the camera detects the main subject, it focuses on that subject. When the subject is in focus, the focus areas (up to twelve areas) that match up with the size of the subject will light in green. When detecting a human face, the camera focuses on it as a priority.
- The camera has nine focus areas, and if it does not detect the main subject, it automatically selects the focus areas containing the subject closest to the camera. When the subject is in focus, the focus areas that are in focus (up to nine areas) light in green.

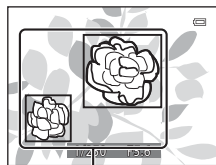

Focus area

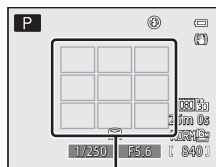

Focus area

✓ Notes on Target Finding AF

- Depending on shooting conditions, the subject that the camera determines to be the main subject may vary.
- The camera may not detect the main subject appropriately in the following situations:
 - When the image shown on the monitor is very dark or bright
 - When the main subject lacks clearly defined colors
 - When the shot is framed so that the main subject is on the edge of the monitor
 - When the main subject is composed of a repeating pattern
- The camera has nine focus areas, and in the following situations, it automatically selects the focus areas containing the subject closest to the camera:
 - When **White balance** is set to **Preset manual, Incandescent** or **1** in **Fluorescent**
 - When **Picture Control** is set to **Monochrome**

Using Face Detection

In the following shooting modes, the camera uses face detection to automatically focus on human faces. If the camera detects more than one face, a double border is displayed around the face that the camera will focus on, and single borders are displayed around the other faces.

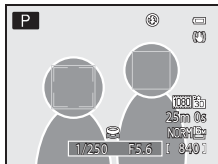

Shooting mode	Number of faces that can be detected	Focus area (double border)
Face priority is selected for AF area mode (☞55) in P, S, A, M or U mode. Scene auto selector, Portrait, Night portrait scene mode (☞37)	Up to 12	The face closest to the camera
☞ (Smile timer) (☞64)	Up to 3	The face closest to the center of the frame

- When using **Face priority**, if you press the shutter-release button halfway while no faces are detected or while framing a shot with no faces in it, the camera automatically selects the focus areas (up to nine) that contain the subject closest to the camera.
- When **Scene auto selector** is selected, the focus area changes depending on which scene the camera selects.
- If no faces are detected when the shutter-release button is pressed halfway in **Portrait** or **Night portrait** scene mode, the camera will focus on the subject at the center of the frame.
- When ☞ (smile timer) is selected, if you press the shutter-release button halfway while no faces are detected, the camera will focus on the subject at the center of the frame.

✓ Notes on Face Detection

- The camera's ability to detect faces depends on a variety of factors, including whether or not the subject is facing the camera. Additionally, the camera may be unable to detect faces in the following situations:
 - When faces are partially hidden by sunglasses or otherwise obstructed
 - When faces take up too much or too little of the frame
- When the frame includes more than one face, the faces detected by the camera and the face on which the camera focuses depend upon a variety of factors, including the direction in which the subject is facing.
- In some rare cases, such as those described in "Autofocus" (☞29), the subject may not be in focus even though the double border turns green. If the camera does not focus, try "Focus Lock" (☞81).

📷 Viewing Pictures Taken Using Face Detection

- During playback, the camera automatically rotates images according to the orientation of the faces that were detected at the time of shooting (except for pictures taken using **Continuous** (☞55) or **Exposure bracketing** (☞55)).
- When zooming in on an image displayed in full-frame playback mode by rotating the zoom control toward **T** (📷), the image is enlarged at the center of the face that was detected during shooting (☞31) (except for pictures taken using **Continuous** (☞55) or **Exposure bracketing** (☞55)).

Focus Lock

Use focus lock to focus on off-center subjects when center is selected for AF area mode.

To focus on off-center subjects when **AF area mode** (📖55) is set to **Center** in **P**, **S**, **A**, **M** or **U** mode, use focus lock as described below.

- 1 Position the subject at the center of the frame.

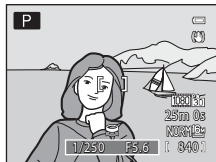

- 2 Press the shutter-release button halfway.

- Subject is in focus and the focus area lights in green.
- Exposure is also locked.

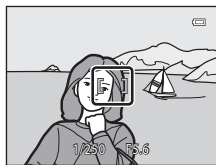

- 3 Continue holding down the shutter-release button halfway and recompose the picture.

- Be sure to maintain the same distance between the camera and the subject.

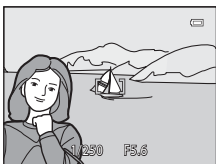

- 4 Press the shutter-release button all the way to take the picture.







A series of horizontal dashed lines for handwriting practice, starting from the top right and extending across the page.

Playback Features

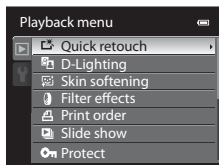
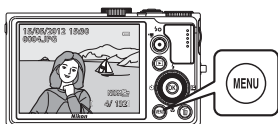
This chapter describes some of the features available when playing back images.







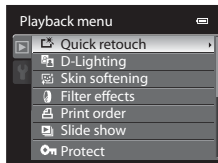

Features Available in Playback Mode (Playback Menu)

When viewing images in full-frame playback mode or thumbnail playback mode, you can configure the following functions by pressing the **MENU** button to display the menu, and then selecting the  tab (11).





Option	Description	
 Quick retouch ^{1, 2, 3}	Create retouched copies in which contrast and saturation have been enhanced.	 18
 D-Lighting ^{1, 3}	Create copies with enhanced brightness and contrast, brightening dark portions of an image.	 18
 Skin softening ^{1, 2, 3}	When this feature is enabled, the camera detects faces in pictures taken and creates a copy with softer facial skin tones.	 19
 Filter effects ^{1, 3}	Apply a variety of effects using digital filter. The available effects are Selective color , Cross screen , Fisheye , Miniature effect and Painting .	 20
 Print order ⁴	When using a printer to print images saved on the memory card, the print order function can be used to select which images are printed, and how many copies of each image are printed.	 56
 Slide show	Images saved in the internal memory or on a memory card are played back in an automatic slide show.	 58
 Protect	Protect selected images and movies from accidental deletion.	 59
 Rotate image ^{3, 4}	Specify the orientation in which saved images are displayed in playback mode.	 61
 Small picture ^{1, 3}	Create a small copy of the picture taken. This feature is useful for creating copies for display on Web pages or e-mail attachments.	 21
 Voice memo ^{3, 5}	Use the camera's microphone to record voice memos and attach them to the picture taken. Playback and deletion of voice memos can also be performed.	 62
 Copy	Copy images between the internal memory and a memory card. This function can also be used to copy movies.	 63
 Black border ^{1, 3}	Create a new picture surrounded by a black border.	 22

Option	Description	
 Sequence display options	Display a sequence of images shot continuously as individual images, or display only the key picture of a sequence.	 64
 Choose key picture	Change the key picture for the series of pictures that were shot continuously (Pictures in a sequence,  14). <ul style="list-style-type: none"> • When changing this setting, select the desired sequence before displaying the menu. 	 64

¹ This function is used to edit the currently selected image and save it as a separate file from the original file.

Note, however, that the following pictures cannot be edited.

- Pictures taken using an aspect ratio of 16:9, 3:2, or 1:1 (except when using the black border editing function)
- Pictures taken using **Easy panorama** or **3D photography**



Note also that there is a restriction on retouching edited images (16, 17)

² Picture that has been extracted from a movie cannot be edited.

³ This function cannot be used for pictures in the sequence when only the key picture is displayed. To use this function, press the  button to display individual images before displaying the menu.

⁴ The function cannot be applied to pictures taken in scene mode **3D photography**.

⁵ A voice memo cannot be attached to a picture that was shot using **Easy panorama**.

See “Editing Still Images” (16) and “The Playback Menu” (56) in the Reference Section for more information about each function.

Connecting the Camera to a TV, Computer, or Printer

You can enhance your enjoyment of images and movies by connecting the camera to a TV, computer, or printer.

- Before connecting the camera to an external device, make sure the remaining battery level is sufficient and turn the camera off. For information about the connection methods and subsequent operations, refer to the documentation included with the device in addition to this document.

USB/audio/video output connector

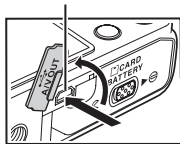

Insert the plug straight.

HDMI mini connector (Type C)

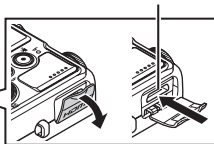

Insert the plug straight.

Viewing images on a TV

24



You can view the camera's images and movies on a TV.

Connection method: Connect the video and audio plugs of the included Audio Video Cable EG-CP16 to the TV's input jacks. Alternatively, connect a commercially available HDMI cable (Type C) to the TV's HDMI input jack.

Viewing and organizing images on a computer

87



If you transfer images to a computer, you can perform simple retouching and manage image data in addition to playing back images and movies.

Connection method: Connect the camera to the computer's USB input jack with the included USB Cable UC-E6.

- Before connecting to a computer, install ViewNX 2 on the computer using the included ViewNX 2 Installer CD. See 89 for more information about using the ViewNX 2 Installer CD and transferring images to a computer.
- If any USB devices that draw the power from the computer are connected, disconnect them from the computer before you connect the camera to it. Connecting the camera and other USB-powered devices to the same computer simultaneously may cause a camera malfunction or excessive power supply from the computer, which could damage the camera or memory card.

Printing images without using a computer

26



If you connect the camera to a PictBridge-compatible printer, you can print images without using a computer.

Connection method: Connect the camera directly to the printer's USB input jack with the included USB Cable UC-E6.

Using ViewNX 2

ViewNX 2 is an all-in-one software package which enables you to transfer, view, edit and share images.

Install ViewNX 2 using the ViewNX 2 Installer CD.



Installing ViewNX 2

- An Internet connection is required.

Compatible Operating Systems

Windows

- Windows 7 Home Basic/Home Premium/Professional/Enterprise/Ultimate (Service Pack 1)
- Windows Vista Home Basic/Home Premium/Business/Enterprise/Ultimate (Service Pack 2)
- Windows XP Home Edition/Professional (Service Pack 3)

Macintosh

- Mac OS X (version 10.5.8, 10.6.8, 10.7.2)

Refer to the Nikon website for the latest information on operating system compatibility.

-
- 1 Start the computer and insert the ViewNX 2 Installer CD into the CD-ROM drive.

- Mac OS: When the **ViewNX 2** window is displayed, double-click the **Welcome** icon.

2 Select a language in the language selection dialog to open the installation window.

- If the desired language is not available, click **Region Selection** to choose a different region and then choose the desired language (the **Region Selection** button is not available in the European release).
- Click **Next** to display the installation window.

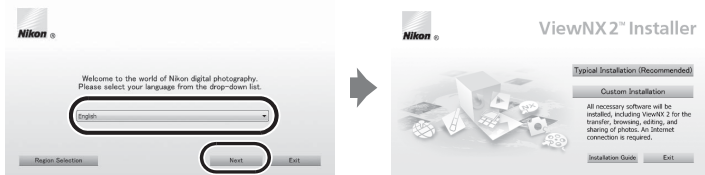

3 Start the installer.

- We recommend clicking **Installation Guide** in the installation window to check the installation help information and system requirements before installing ViewNX 2 .
- Click **Typical Installation (Recommended)** in the installation window.

4 Download the software.

- When the **Software Download** screen is displayed, click **I agree. Begin download.**
- Follow the on-screen instructions to install the software.

5 Exit the installer when the installation completion screen is displayed.

- Windows: Click **Yes**.
- Mac OS: Click **OK**.

The following software is installed:

- ViewNX 2 (consisting of the three modules below)
 - Nikon Transfer 2: For transferring images to the computer
 - ViewNX 2 : For viewing, editing, and printing transferred images
 - Nikon Movie Editor: For basic editing of transferred movies
- Panorama Maker 6 (for creating a single panorama photo using a series of images shot in panorama assist scene mode)
- QuickTime (Windows only)

6 Remove the ViewNX 2 Installer CD from the CD-ROM drive.

Transferring Images to the Computer

1 Choose how images will be copied to the computer.

Choose one of the following methods:

- **Direct USB connection:** Turn the camera off and ensure that the memory card is inserted in the camera. Connect the camera to the computer using the included USB Cable UC-E6. The camera automatically turns on. To transfer images that are saved in the camera's internal memory, remove the memory card from the camera before connecting it to the computer.

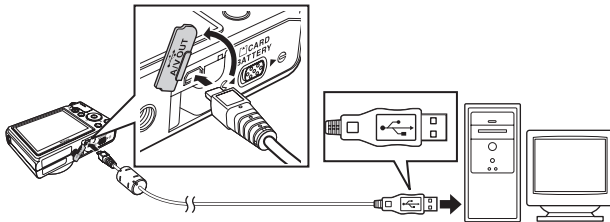

- **SD card slot:** If your computer is equipped with an SD card slot, the card can be inserted directly in the slot.
- **SD card reader:** Connect a card reader (available separately from third-party suppliers) to the computer and insert the memory card.

If a message is displayed prompting you to choose a program, select Nikon Transfer 2.

• When using Windows 7

If the dialog shown at right is displayed, follow the steps below to select Nikon Transfer 2.

- 1 Under **Import pictures and videos**, click **Change program**. A program selection dialog will be displayed; select **Import File using Nikon Transfer 2** and click **OK**.
- 2 Double-click **Import File**.



If the memory card contains a large number of images, it may take a while for Nikon Transfer 2 to start. Wait until Nikon Transfer 2 starts.

✔ Connecting the USB Cable

The connection may not be recognized if the camera is connected to the computer via a USB hub.

2 Transfer images to the computer.

- Confirm that the name of the connected camera or removable disk is displayed as the “Source” on the “Options” title bar of Nikon Transfer 2 (①).
- Click **Start Transfer** (②).

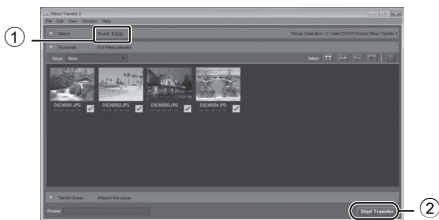

- At default settings, all the images on the memory card will be copied to the computer.

3 Terminate the connection.

- If the camera is connected to the computer, turn the camera off and then disconnect the USB cable.
- If you are using a card reader or card slot, choose the appropriate option in the computer operating system to eject the removable disk corresponding to the memory card and then remove the card from the card reader or card slot.

Viewing Images

Start ViewNX 2 .

- Images are displayed in ViewNX 2 when transfer is complete.
- Consult online help for more information on using ViewNX 2 .

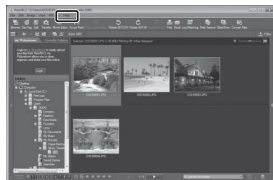

Starting ViewNX 2 Manually

- **Windows:** Double-click the **ViewNX 2** shortcut on the desktop.
- **Mac OS:** Click the **ViewNX 2** icon in the Dock.

Recording and Playing Back Movies

You can record movies by simply pressing the **●** (🎬 movie-record) button.

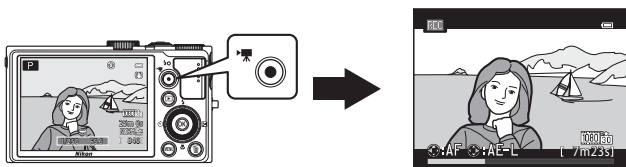

In playback mode, press the **OK** button to play a movie.

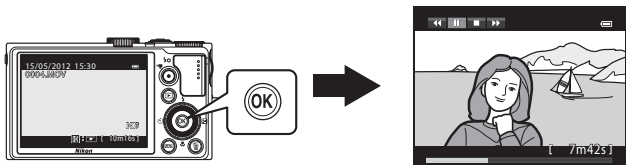

Recording Movies

You can record movies by simply pressing the **●** (📹 movie-record) button. Color tones, white balance, and other settings are the same as they are when taking still images.

1 Turn on the camera and display the shooting screen.

- The movie options icon indicates the type of movie recorded. The default setting is **1080P★ HD 1080p★ (1920×1080)** (📖95).
- When recording movies, the angle of view (i.e., the area visible in the frame) is narrower than that of still images. When **Photo info** (📖98) is set to **Movie frame+auto info**, you can confirm the area visible in the frame before recording movies.

* The maximum movie length shown in the illustration differs from the actual value.

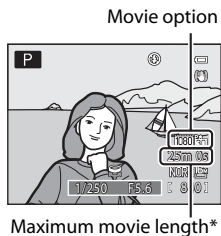

2 Press the **●** (📹 movie-record) button to start movie recording.

- The camera focuses on the subject at the center of the frame. Focus areas are not displayed during recording.
- When the multi selector **▶** is pressed during movie recording, the exposure is locked. To unlock, press **▶** again.

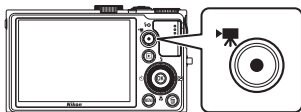

- When recording with the movie options of the aspect ratio of 16:9 (e.g., **Movie options** is **1080P★ HD 1080p★ (1920×1080)**), monitor display changes to an aspect ratio of 16:9 (the movie is recorded in the range shown in the screen on the right).
- The approximate remaining movie length is displayed on the monitor. **11** is displayed while saving to the internal memory.
- Recording stops automatically when the maximum movie length has been recorded.



3 Press the **●** (📹 movie-record) button again to end recording.

✔ Note on Recording Images and Saving Movies

The indicator showing the number of exposures remaining or the indicator showing the maximum movie length flashes while images are being recorded or while a movie is being saved. **Do not open the battery-chamber/memory card slot cover or remove the battery or memory card while an indicator is flashing.** Doing this could result in loss of data, or in damage to the camera or the memory card.

✓ Notes on Movie Recording

- When saving a movie onto a memory card, a memory card with an SD speed class of Class 6 or higher is recommended (□19). If the transfer speed of the card is slow, the movie recording may end unexpectedly.
- Using the digital zoom causes image quality to deteriorate. If you start recording the movie without using digital zoom, and you keep rotating the zoom control toward **T**, the zoom stops at the maximum optical zoom ratio. Release the zoom control and rotate it again toward **T** to trigger digital zoom. When recording ends, digital zoom turns off.
- The sounds of zoom control operation, zoom, autofocus, vibration reduction or aperture control when the brightness changes may be recorded.
- The following phenomena may be seen on the monitor while recording movies. These phenomena are saved in the recorded movies.
 - Banding may occur in images under fluorescent, mercury-vapor, or sodium-vapor lighting
 - Subjects that move quickly from one side of the frame to the other, such as a moving train or car, may appear skewed
 - The entire movie image may be skewed when the camera is panned
 - Lighting or other bright areas may leave residual images when the camera is moved

✓ Notes on the Camera Temperature





- The camera may become warm when recording movies for an extended period of time or when the camera is used in a hot area.
- When the temperature inside the camera becomes extremely high while recording a movie, recording automatically stops after 5 seconds. The remaining amount of recording time (▲ 5s) is displayed on the monitor. The camera turns off in 5 seconds after movie recording automatically stops. Leave the camera off until the inside of the camera has cooled and then use it.



✍ Focusing for Movie Recording

- When **Autofocus mode** (□95) in the movie menu is set to **AF-S Single AF** (default setting), the focus is locked when the **movie-record** button is pressed to start movie recording. To adjust the focus using the autofocus again while recording movies, press the multi selector ◀.
- When the focus mode (□66) is **MF** (manual focus), adjust the focus manually. The focus can be adjusted by pressing the multi selector ▲ (Far) or ▼ (Near) while recording movies.
- Autofocus may not perform as expected (□29). Should this occur, try **MF** (manual focus) or the following methods.
 1. Before recording, set **Autofocus mode** in the movie menu to **AF-S Single AF** (default setting).
 2. Position a different subject at the same distance in the middle of the screen. Press the **movie-record** button to start the movie recording, and change the composition.

Maximum Movie Length



Movie options (📖95)	Internal memory (90 MB)	Memory card (4 GB) ²
 HD 1080p★ (1920×1080)	37 s ¹	25 min
 HD 1080p (1920×1080)	57 s	40 min
 HD 720p (1280×720)	1 min 25 s	1 h
 iFrame 540 (960×540)	33 s ¹	25 min
 VGA (640×480)	4 min 11 s	2 h 50 min

All figures are approximate. The maximum movie length varies with the make of the memory card and the bitrate of the recorded movie.



¹ The maximum movie length for a single movie is 25 seconds.

² The maximum movie length for a single movie is 4 GB or 29 minutes, even when there is sufficient free space on the memory card. The maximum movie recording time for a single movie is displayed during recording.

Functions Available in Movie Recording

- The exposure compensation and **White balance** settings in shooting menu (📖54) are also applied with movie recording. When the focus mode is set to  (macro close-up), the camera can zoom to a position closer to the subject to record movies. Confirm settings before starting movie recording.
- The self-timer (📖63) can be used. If the self-timer is set and the  (movie-record) button is pressed, the camera starts movie recording after ten or two seconds.
- The flash does not fire.
- Press the **MENU** button before starting to record the movie to display the  (movie) tab and select movie menu settings (📖95).

Recording HS (High Speed) Movies

When **Movie options** in movie menu is set to  **HS 120 fps (640×480)**,  **HS 60 fps (1280×720)**, or  **HS 15 fps (1920×1080)**, movies that can be played back in slow motion or fast motion can be recorded (📖67).

More Information



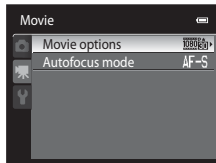

See "File and Folder Names" (📖94) for more information.

Changing Movie Recording Settings (Movie Menu)

The following option settings can be changed.



Display the shooting screen → MENU button →  tab (11)

Option	Description	
Movie options	Select the type of movie recorded. The camera can record normal speed movies and high speed (HS) movies, which can be played back in slow motion or fast motion. The default setting is  HD 1080p★ (1920×1080) .	 65
Autofocus mode	Select how the camera focuses when recording normal speed movies. Single AF (default setting) where the focus is locked when movie recording begins, or Full-time AF where the camera focuses continuously during movie recording can be selected. When Full-time AF is selected, the sound of the camera focusing may be heard in recorded movies. If you want to prevent the sound of the camera focusing from being recorded, select Single AF .	 69

More Information

See "Note on the Command Dial Operation When Menus are Displayed" (12) for more information.

Playing Back Movies

1 Press the  (playback) button to select playback mode.

- Press the multi selector to select a movie.
- Movies can be recognized by the movie options icon (94).

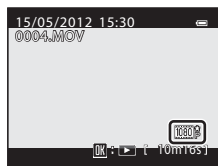



2 Press the  button to play back a movie.









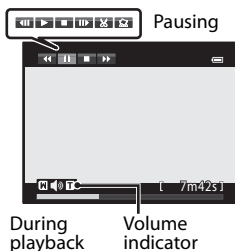





Adjusting the volume





Press the zoom control **T/W** (2) during playback.

Operations available during movie playback

Rotate the multi selector to fast forward or rewind. Playback controls appear at the top of the monitor. Press the multi selector  or  to select an icon of playback control, then press the  button to perform the following operations.



To	Use	Description
Rewind		Rewind the movie while the  button is pressed down.
Advance		Advance the movie while the  button is pressed down.
Pause		The following operations can be performed with the playback controls at the top of the monitor while playback is paused.
		 Rewind the movie by one frame. Hold down the  button to rewind continuously.*
		 Advance the movie by one frame. Hold down the  button to advance continuously.*
		 Extract and save only the required parts of the movie ( 32).
		 Save a frame extracted from a movie as a still picture ( 33).
		Resume playback.
End		Return to full-frame playback mode.

* The movie can also be advanced or rewound by one frame by rotating the multi selector. To delete a movie, use full-frame playback mode (30) or thumbnail playback mode (31) to select a movie and press the  button (32).

Note on Movie Playback

Movies recorded with cameras other than COOLPIX P310 cannot be played back.

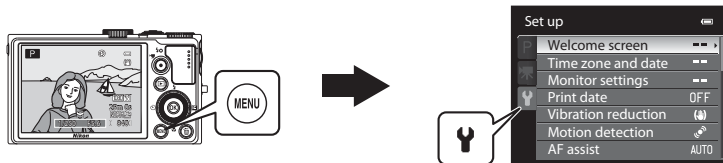

General Camera Setup

This chapter describes the various settings that can be adjusted in the  setup menu.









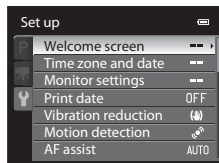

- See “Using Menus (the **MENU** Button)” (📖 11) for more information about using the camera’s menus.
- For further details about each setting, refer to “The Setup Menu” in the Reference Section (🔑 70).













The Setup Menu

Press the MENU button →  (setup) tab  11







From the menu screen, select the  tab to display the setup menu, and then you can change the following settings.









Option	Description	
Welcome screen	Select the image displayed as the welcome screen when the camera is turned on. Select COOLPIX to display the COOLPIX logo. Select Select an image to use a picture taken with the camera as the welcome screen. The default setting is None .	 70
Time zone and date	Set settings related to the camera's date and time. The Time zone setting allows you to specify the time zone where the camera is mainly used and whether or not daylight saving time is in effect. When the  travel destination is set, the camera automatically calculates the time difference between the travel destination and the  home time zone, and saves images using the date and time of the travel destination.	 71
Monitor settings	In Photo info , select the kind of information that is displayed on the monitor during shooting mode and playback mode. If you select Framing grid+auto info , a framing grid is displayed when shooting to help you frame the picture. Also set the image display after shooting, the screen brightness and whether or not to display histograms on the monitor.	 74
Print date	Imprint the shooting date and time on pictures at the time of shooting. The default setting is Off . <ul style="list-style-type: none"> Dates cannot be imprinted in the following situations. <ul style="list-style-type: none"> When the scene mode is set to Easy panorama, Panorama assist, or 3D photography When Pre-shooting cache, Continuous H: 120 fps or Continuous H: 60 fps is selected for Continuous  55) in the shooting menu During movie recording 	 76

Option	Description	
Vibration reduction	<p>Reduce blurring caused by camera shake when shooting. The default setting is On.</p> <ul style="list-style-type: none"> When using a tripod to stabilize the camera, set this feature to Off to prevent this feature from malfunctioning. 	 77
Motion detection	<p>When the camera detects camera shake or subject movement at the time of shooting, it automatically increases ISO sensitivity and shutter speed to reduce blurring. The default setting is Auto.</p> <p>The  indicator lights in green when the camera detects camera shake or subject movement and increases shutter speed.</p> <ul style="list-style-type: none"> When using certain shooting modes or settings, motion is not detected. In this case the  indicator is not displayed. 	 78
AF assist	<p>When set to Auto (default setting), the AF-assist illuminator (29) lights when shooting in dark surroundings to help the camera focus.</p> <ul style="list-style-type: none"> The illuminator has a range of about 5.3 m (17 ft) at the maximum wide-angle position and about 1.9 m (6 ft 2 in.) at the maximum telephoto position. Even if Auto is selected, the AF-assist illuminator may not light depending on the position of the focus area or the scene mode that is selected. 	 79
Digital zoom	<p>When set to On (default setting), when the optical zoom is at the maximum telephoto zoom position, rotating the zoom control toward T () triggers the digital zoom (27).</p> <ul style="list-style-type: none"> The digital zoom cannot be used simultaneously in certain settings such as the shooting mode. 	 79
Sound settings	<p>Turn various camera sounds on and off. In the default setting, beep sounds are on.</p> <ul style="list-style-type: none"> The operation sound is disabled in certain settings such as shooting mode. 	 80
Auto off	<p>Set the amount of time that passes before the monitor is turned off to save power. The default setting is 1 min.</p>	 80
Format memory/ Format card	<p>Format the internal memory (only when a memory card is not inserted) or the memory card (when a memory card is inserted).</p> <ul style="list-style-type: none"> All data stored in the internal memory or on the memory card is deleted during formatting and cannot be restored. Be sure to transfer important images to a computer and save them before formatting. 	 81

The Setup Menu

Option	Description	
Language	Change the camera's display language.	 81
TV settings	Adjust settings for connection to television. <ul style="list-style-type: none"> When the camera is connected to a television using an audio/video cable but no picture is displayed on the television, set Video mode to NTSC or PAL according to the type of signal compatible with the television. HDMI settings can be set. 	 82
Fn button	Assign the frequently used shooting menu to the Fn (FUNC) button. The default setting is Continuous .	 83
Charge by computer	When set to Auto (default setting), you can charge the camera's battery by connecting the camera to a computer (provided that the computer is able to supply power). <ul style="list-style-type: none"> When charging by computer, it may take more time to charge the battery than when using the Charging AC Adapter EH-69P. Additionally, when charging by computer and transferring images to the computer, it takes more time to charge the battery. 	 84
Toggle Av/Tv selection	Switch the method for setting the flexible program, shutter speed, or aperture value. When Do not toggle selection (default setting) is selected, use the command dial to set the flexible program or shutter speed and use the multi selector to set the aperture value. When Toggle selection is selected, use the multi selector to set the flexible program or shutter speed and use the command dial to set the aperture value. <ul style="list-style-type: none"> This option is enabled only when the shooting mode is P, S, A, M, or U. 	 86
Reset file numbering	When Yes is selected, the sequential numbering of file numbers is reset. After resetting, a new folder is created and the file number for the next image taken starts from "0001."	 86
Blink warning	When the camera detects that a human subject may have closed the eyes immediately after taking a picture using face detection while shooting with modes other than the smile timer ( 80), the Did someone blink? screen is displayed on the monitor to check the picture taken. The default setting is Off .	 87

Option	Description	
Filmstrip	When On is selected, thumbnails of previous and subsequent images are displayed at the bottom of the monitor when you rotate the multi selector quickly while viewing an image in full-frame playback mode ( 30). The default setting is Off .	 88
Eye-Fi upload	Set whether or not to enable the function for sending images to a computer using a commercially available Eye-Fi card. The default setting is Disable .	 89
Reverse indicators	Set the +/- display direction of exposure indicator to be displayed when the shooting mode is M .	 90
Reset all	Reset the camera's settings to their default values. <ul style="list-style-type: none"> Some of the settings such as Time zone and date and Language and user settings that were saved for mode dial U are not reset. 	 90
Firmware version	Display the current camera firmware version.	 93

More Information

See "Note on the Command Dial Operation When Menus are Displayed" (12) for more information.



A series of horizontal dashed lines spanning the width of the page, intended for handwriting practice.



Reference Section

The Reference Section provides detailed information and hints for using the camera.

Shooting

Taking Pictures with Manual Focus	2
Using Easy Panorama (Shooting and Playing back)	3
Using Panorama Assist	6
Using 3D Photography	8
P, S, A, M Modes	10

Playback

Playing and Deleting Images Captured Using Continuous Shooting Mode (Sequence)	14
Editing Still Images	16
Connecting the Camera to a TV (Viewing Images on a TV)	24
Connecting the Camera to a Printer (Direct Print)	26
Editing Movies	32

Menu

Shooting Menu (P, S, A or M Mode)	34
The Playback Menu	56
The Movie Menu	65
The Setup Menu	70

Additional Information

File and Folder Names	94
Optional Accessories	96
Error Messages	97

Taking Pictures with Manual Focus

Available when the shooting mode is **P**, **S**, **A**, **M**, **U**, the **Sports** or **Special effects** scene mode.

1 Press the multi selector ▼ (MF focus mode).

- Use the multi selector to choose **MF** (manual focus) and press the **OK** button.
- **MF** is displayed on the top of the monitor, and the center area of a picture is enlarged.

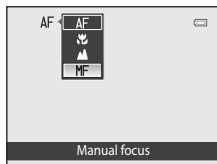

2 Adjust the focus.

- Use the multi selector to adjust the focus while viewing the image on the monitor.
- Press ▲ to focus on far subjects.
- Press ▼ to focus on near subjects.
- Press the shutter-release button halfway to check the composition. Press the shutter-release button all the way to take the picture.

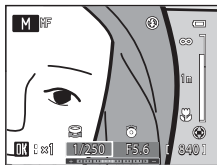

3 Press the **OK** button.

- The set focus is locked. You can continue shooting with the locked focus.
- To readjust the focus, press the **OK** button again to display the screen in step 2.
- To change back to autofocus, return to step 1 and choose any setting other than **MF**.

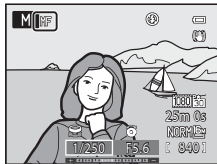



MF (Manual Focus)

- In step 2, the figure displayed with the gauge at the right of the monitor indicates an approximate distance (m) at which the subject can be in focus when the gauge is near the center. The actual range at which the subject can be in focus varies depending on the aperture value and zoom position. To see whether the subject is in focus, check the subject on the monitor.
- Press the shutter-release button halfway to preview an approximate depth of field (the area in focus behind and in front of the subject).
- The digital zoom is not available.



Using Easy Panorama (Shooting and Playing back)

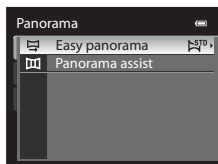

Taking Pictures with Easy Panorama

Rotate the mode dial to SCENE → MENU button →  Panorama

- 1 Select  **Easy panorama** and press the  button.



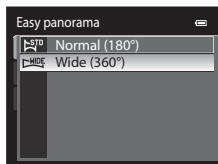

- 2 Select the shooting range from  **Normal (180°)** or  **Wide (360°)**, and press the  button.

- The image sizes (W × H) when the camera is held in landscape orientation are as follows.
 -  **Normal (180°)**:
3200 × 560 when the camera is moved horizontally,
1024 × 3200 when the camera is moved vertically
 -  **Wide (360°)**:
6400 × 560 when the camera is moved horizontally,
1024 × 6400 when the camera is moved vertically
- For the image sizes when the camera is held in "tall" orientation, the combinations of the moving direction and W × H are the opposites of the above.



- 3 Frame the first portion of the panorama scene, and press the shutter-release button halfway to adjust the focus.

- The zoom is fixed at the wide-angle position.
- The framing guide is displayed on the monitor.
- The camera focuses on the subject at the center of the frame.
- Exposure compensation (68) can be adjusted.
- If the focus or exposure cannot be set for the main subject, try the focus lock (81).

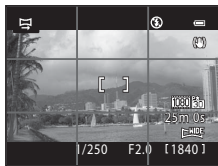

4 Press the shutter-release button all the way, and release it.

- The  icons showing the panorama direction are displayed.



5 Move the camera straight and slowly in one of the four directions to start shooting.



- When the camera detects the panorama direction, the shooting starts.
- The guide showing the current shooting point is displayed.
- When the guide showing the shooting point reaches the end, the shooting ends.

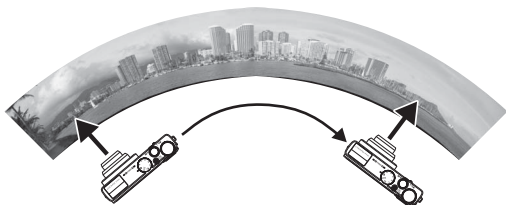

Guide

Example of moving the camera



- The user, without shifting position, moves the camera, from end to end of the guide, horizontally or vertically in an arc.
- If about 15 seconds (in  **Normal (180°)**) or 30 seconds (in  **Wide (360°)**) pass from the start of the shooting, and before the guide showing the shooting point reaches the end, the shooting ends.

✓ Notes on Easy Panorama Shooting

- The image area seen in the saved image will be narrower than that seen on the monitor at the time of shooting.
- When the camera movement speed is too fast, there is a large amount of camera shake or there is little change in subject such as wall or in the dark, the shooting ends in an error.
- Panorama pictures are not saved when the shooting stops before reaching half of the panorama range.
- When the shooting reaches more than half of the panorama range but finishes before the end point, the range that is not shot will be recorded as a gray area.

Viewing Easy Panorama (Scroll)

Switch to playback mode (📖30), display the picture recorded with easy panorama in full-frame playback mode and press the **OK** button. The camera displays the short side of the picture filling the entire screen and scrolls the displayed area automatically.

- **STD** or **WIDE** is displayed for pictures recorded with easy panorama.
- The picture is scrolled in the direction of the panorama shooting.
- Rotate the multi selector to advance or rewind.

Playback controls are displayed at the top of the monitor during playback. When you choose a playback control with the multi selector ◀ or ▶ and press the **OK** button, the following operations can be performed.



To	Use	Description	
Rewind	◀◀	Scroll quickly back while the OK button is pressed.	
Advance	▶▶	Scroll quickly forward while the OK button is pressed.	
Pause		The following operations can be performed with the playback controls at the top of the monitor while playback is paused.	
		◀	Rewind while the OK button is pressed.*
		▶	Scroll while the OK button is pressed.*
	▶	Restart the automatic scroll.	
End	■	Return to full-frame playback mode.	

* Scrolling can also be performed by rotating the multi selector.

✔ Note on Viewing Pictures Recorded with Easy Panorama

Panorama pictures recorded with functions other than easy panorama of the COOLPIX P310 may not be scrolled or zoomed on this camera.

Using Panorama Assist

Using a tripod makes the composition easier. When using a tripod to stabilize the camera, set **Vibration reduction** (6677) to **Off** in the setup menu.







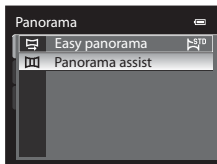



Rotate the mode dial to **SCENE** → **MENU** button →  Panorama

1 Select **Panorama assist** and press the **OK** button.

- The  icon is displayed to show the direction in which pictures are joined.



2 Use the multi selector to choose the direction, and press the **OK** button.

- Select the direction in which pictures are joined in the completed panorama: right () , left () , up () or down () .
- The yellow icon () moves to the selected direction, so press the **OK** button to select the direction. A white icon () is displayed in the selected direction.
- Apply flash mode () 60, self-timer () 63, focus mode () 66 and exposure compensation () 68 settings with this step, if necessary.
- Press the **OK** button again to reselect the direction.

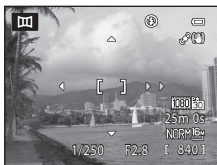

3 Frame the first portion of the panorama scene, and take the first picture.

- The camera focuses on the subject at the center of the frame.
- 1/3 of the image will be displayed as translucent.

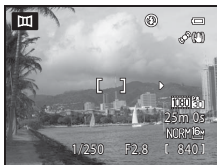

4 Shoot the next picture.

- Match the outline of the next picture so that 1/3 of the frame overlaps the previous picture, and press the shutter-release button.
- Repeat until you have taken the necessary number of pictures to complete the image.



5 Press the **OK** button when shooting is completed.

- The camera returns to step 2.

✓ Notes on Panorama Assist

- Set the flash mode, self-timer, focus mode and exposure compensation before releasing the shutter for the first picture. The settings cannot be changed after shooting the first picture. Pictures cannot be deleted, nor can zoom, **Image quality** (📖72), or **Image size** (📖73) be adjusted after shooting the first picture.
- The panorama series is terminated if the auto off function (🔌80) triggers the standby mode during shooting. To prevent this, setting a longer time for the auto off function is recommended.

📝 AE/AF-L (exposure lock) Indicator

When using panorama assist mode, all pictures in the panorama have the same exposure, white balance, and focus as the first picture of the panorama.

When the first picture is shot, **AE/AF-L** is displayed on the monitor to indicate that exposure, white balance, and focus are locked.

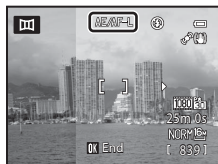

📝 Panorama Creation with Panorama Maker 6

Transfer pictures to a computer (📖89) and use Panorama Maker 6 to join them in a single panorama.

- Panorama Maker 6 can be installed on a computer using the included ViewNX 2 Installer CD (📖87).
- After installation is complete, follow the procedure described below to start Panorama Maker 6. Windows: Choose **Start** menu>**All Programs**>**ArcSoft Panorama Maker 6**>**Panorama Maker 6**. Mac OS X: Open **Applications** and double-click the **Panorama Maker 6** icon.
- For more information on using Panorama Maker 6, refer to the on-screen instructions and help information contained in Panorama Maker 6.

📝 More Information

See "File and Folder Names" (🔌94) for more information.

Using 3D Photography

The camera takes one picture for each eye to simulate a three-dimensional image on a 3D-compatible TV or monitor.

Rotate the mode dial to **SCENE** → **MENU** button → **3D** 3D photography

1 Frame the subject.

- The focus area that the camera focuses on can be moved to areas other than the center of the frame. To move the focus area, press the **OK** button before taking the first picture, and then rotate the multi selector or press **▲**, **▼**, **◀**, or **▶**. To adjust the following settings, press the **OK** button to temporarily cancel focus area selection, and then adjust each setting.
 - Focus mode (**AF** (Autofocus) or **MF** (macro close-up))
 - Exposure compensation

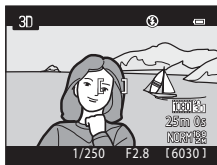

2 Press the shutter-release button to take the first picture.

- The focus, exposure and white balance are locked after the first shot, and **AE/AF-L** is displayed on the monitor.



3 Move the camera horizontally to the right until the translucent guide is aligned with the subject.

- To cancel shooting, press the **OK** button.

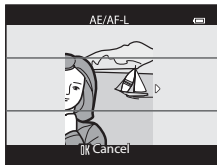

4 Wait for the camera to automatically release the shutter.

- The camera automatically takes the second picture when it detects that the subject is aligned with the guide.
- Shooting is canceled if the subject is not aligned with the guide within 10 seconds.

Taking 3D Pictures

- Moving subjects are not suited to 3D photography. We recommend shooting still subjects.
- Pictures have a less pronounced 3D feel as the distance between the camera and background is increased.
- Pictures may have a less pronounced 3D feel when the subject is dark or when the second picture is not aligned precisely.
- Be careful of camera shake when shooting at the telephoto zoom position.
- The digital zoom is not available.
- The angle of view (i.e., the area visible in the frame) seen in the saved picture will be narrower than that seen on the monitor at the time of shooting.
- Pictures taken under dim lighting may appear grainy with noise.
- If the camera does not take the second picture and cancels the shooting even when you align the guide with the subject, try shooting with the shutter-release button.

Notes on Viewing 3D Pictures

- 3D pictures cannot be played back in 3D on the camera monitor. See “Viewing 3D Photography” (p.49) for more information.
- When viewing 3D pictures on a 3D-compatible TV or monitor for an extended period of time, you may experience discomfort such as eye strain or nausea. Carefully read the documentation included with your TV or monitor to ensure proper use.

P, S, A, M Modes

P (Programmed auto), S (Shutter-priority auto) or A (Aperture-priority auto)

- 1 Rotate the mode dial to P, S or A.

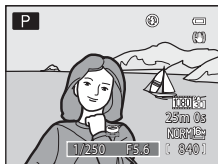
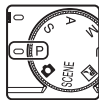

- 2 Rotate the command dial or multi selector to set the exposure.

- In **P** mode, the flexible program (☰53) can be set by rotating the command dial.
- In **S** mode, the shutter speed can be set in a range from a maximum speed of 1/2000 to 4 seconds by rotating the command dial.
- In **A** mode, the aperture value can be set in a range of f/1.8 to 8 (wide-angle position) and f/4.9 to 7.8 (telephoto zoom position) by rotating the multi selector.

- 3 Frame the subject and shoot.

- In the default setting, the camera has nine focus areas, and automatically selects the focus areas containing the subject closest to the camera. When the subject is in focus, the focus areas that are in focus (up to nine areas) light in green (👁48).



Notes on Shooting

- When zooming is performed after the exposure is set, exposure combinations or aperture value may be changed.
- When the subject is too dark or too bright, it may not be possible to obtain the appropriate exposure. In such cases, the shutter speed indicator or aperture value indicator flashes when the shutter-release button is pressed halfway. Change the shutter speed setting or aperture value. When settings such as ISO sensitivity (46) are changed, the appropriate exposure may be obtained.

Shutter Speed

- When the aperture value is set to $f/1.8$ (largest aperture), the shutter speed can be set to maximum 1/1600 second.
- In **P** or **A** mode, when the aperture value is set to $f/8$ and the zoom is at the maximum wide-angle position or moved one increment to the telephoto position, the shutter speed can be set to maximum 1/1600 second.
- The control range of the shutter speed differs depending on the aperture value or the ISO sensitivity setting. Additionally, the range is restricted during continuous shooting (78).

M (Manual) Mode

The user controls both the shutter speed and aperture value.

- The shutter speed can be set in a range from a maximum speed of 1/2000 to 8 seconds.

1 Rotate the mode dial to M.

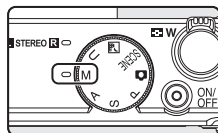

2 Rotate the command dial to set a shutter speed.

- See [53](#) for more information on exposure indicator.

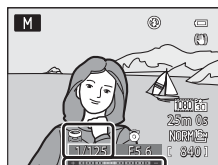

Exposure indicator

3 Rotate the multi selector to set an aperture value.

- Repeat steps 2 to 3 to adjust shutter speed and aperture value settings until the desired exposure is achieved.

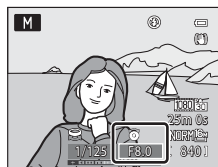

4 Focus and shoot.

- In the default setting, the camera has nine focus areas, and automatically selects the focus areas containing the subject closest to the camera. When the subject is in focus, the focus areas that are in focus (up to nine areas) light in green ([48](#)).



Note on Shooting

When zooming is performed after the exposure is set, aperture value may be changed.

Note on ISO Sensitivity

When **ISO sensitivity** () is set to **Auto** (default setting) or **Fixed range auto**, ISO sensitivity is fixed at ISO 100.

Shutter Speed

- When the aperture value is set to f/1.8 (largest aperture), the shutter speed can be set to maximum 1/1600 second.
- The control range of the shutter speed differs depending on the aperture value or the ISO sensitivity setting. Additionally, the range is restricted during continuous shooting ()78).

Playing and Deleting Images Captured Using Continuous Shooting Mode (Sequence)

The images shot in the following continuous shooting mode are saved as a group (called a “sequence”) each time you shoot.

- **Continuous H, Continuous L, Pre-shooting cache, Continuous H: 120 fps** or **Continuous H: 60 fps** in **Continuous** (📖42) in the shooting menu
- **Sports** (📖40) or **Continuous** in the **Pet portrait** (📖47) scene mode

Playing Images in a Sequence

In full-frame playback mode or thumbnail playback mode (📖31), the first image of a sequence is used as the “key picture”, i.e., it is displayed to represent the images in the sequence.

Sequence display



While the key picture of a sequence is displayed in full-frame playback mode, press the **OK** button to display each image in the sequence individually. To return to key picture only display, press the multi selector **▲**.

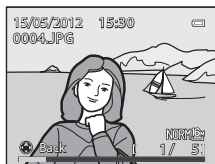

The following operations can be performed when each image in a sequence is displayed individually.

- Select an image: Rotate the multi selector or press **◀** or **▶**.
- Zoom in: Rotate the zoom control toward **T** (📖31).

✔ Note on Sequence

Pictures captured continuously with cameras other than COOLPIX P310 cannot be displayed as a sequence.

📎 Sequence Display Options

Select **Sequence display options** (📖64) in the playback menu to set all sequences to be displayed using their key pictures or to display them as individual images.

If an image in the sequence is selected when **Sequence display options** is set to **Individual pictures**, 📎 icon is displayed on the monitor.

📎 Changing Key Picture in Sequence

A sequence's key picture can be changed using **Choose key picture** (📖64) in the playback menu.

Playback Menu Options Available When Using Sequence



When the **MENU** button is pressed during an image sequence playback, the following menu operations are available.



- | | | | |
|-------------------------------|----------------------------------------------------------------------------------------|-------------------------------|----------------------------------------------------------------------------------------|
| • Quick retouch ¹ | →  18 | • D-Lighting ¹ | →  18 |
| • Skin softening ¹ | →  19 | • Filter effects ¹ | →  20 |
| • Print order ² | →  56 | • Slide show | →  58 |
| • Protect ² | →  59 | • Rotate image ¹ | →  61 |
| • Small picture ¹ | →  21 | • Voice memo ¹ | →  62 |
| • Copy ² | →  63 | • Black border ¹ | →  22 |
| • Sequence display options | →  64 | • Choose key picture | →  64 |

¹ Press the **MENU** button after displaying individual images. Settings can be applied to individual images.

² When the **MENU** button is pressed during displaying only the key picture, the same settings can be applied to all images in that sequence. Press the **MENU** button after displaying individual images to apply settings to individual images.

Deleting Images in a Sequence

When **Sequence display options** ( 64) is set to **Key picture only** in the playback menu, if the  button is pressed and the deletion method is selected, the following images are deleted.

- When a sequence is displayed by its key picture only:
 - **Current image:** When the sequence is selected, all images in the sequence are deleted.
 - **Erase selected images:** When the key picture is selected in the erase selected images screen ( 33), all images in the sequence are deleted.
 - **All images:** All images including the sequence that is displayed are deleted.
- If the key picture is selected and the  button is pressed to display individual images in the sequence before pressing the  button:

The deletion methods change to the followings.

 - **Erase current picture:** Delete the image that is displayed.
 - **Erase selected images:** Select multiple images in the sequence to delete in the erase selected images screen ( 33).
 - **Erase entire sequence:** All images in the sequence, including the image that is displayed, are deleted.

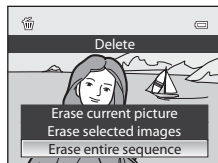

Editing Still Images

Editing Features

Images can be easily edited with this camera using the functions below. Edited images are stored as separate files (📷94).

Editing function	Application
Quick retouch (📷18)	Easily create a copy with enhanced contrast and richer colors.
D-Lighting (📷18)	Create a copy of the current picture with enhanced brightness and contrast, brightening dark portions of the picture.
Skin softening (📷19)	Make the facial skin tones softer.
Filter effects (📷20)	Apply a variety of effects using digital filter effects. The available effects are Selective color , Cross screen , Fisheye , Miniature effect and Painting .
Small picture (📷21)	Create a small copy of pictures suitable for uses such as e-mail attachments.
Black border (📷22)	Add a black frame around the picture. Use when you want to add a black border to a picture.
Crop (📷23)	Crop a portion of the picture. Use to zoom in on a subject or arrange a composition.

✓ Notes on Image Editing

- The following pictures cannot be edited.
 - Pictures taken using an aspect ratio of 16:9, 3:2, or 1:1 (except when using the black border editing function)
 - Pictures taken using **Easy panorama** or **3D photography**
 - Pictures taken with cameras other than COOLPIX P310
- When no faces are detected in the picture, skin softening cannot be applied (📷19).
- If a copy created using the COOLPIX P310 is viewed on a different digital camera, it may not be possible to display the picture properly or transfer it to a computer.
- Editing functions are not available when there is not enough free space in the internal memory or on the memory card.
- For a sequence displayed using the key picture only setting (📷14), perform one of the following operations before editing.
 - Press the **OK** button to display individual images, and then select an image in the sequence
 - Set **Sequence display options** (📷64) to **Individual pictures** so that each image is displayed individually, and then select an image



Restrictions on Image Editing

The following restrictions apply when editing pictures that were created by editing.

Editing functions used	Editing functions to add
Quick retouch D-Lighting	Skin softening, Filter effects, Small picture, Black border or Crop can be used. Quick retouch and D-Lighting cannot be used in combination with each other.
Skin softening	Quick retouch, D-Lighting, Filter effects, Small picture, Black border or Crop can be used.
Filter effects	Quick retouch, D-Lighting, Skin softening, Small picture, Black border or Crop can be used.
Small picture	No additional editing functions can be used.
Black border	Small picture can be used.
Crop	Black border can be used.

- Copies created by editing cannot be edited again using the same editing function.
- To use an editing function together with small picture, use the other editing function first, and use small picture as the last editing function performed on that picture.
- Pictures that were taken using skin softening can be edited using skin softening.
- Picture that has been extracted from a movie cannot be edited using the quick retouch or skin softening function.

Original Pictures and Edited Copies

- Copies created with editing functions are not deleted if the original pictures are deleted. The original pictures are not deleted if copies created with editing functions are deleted.
- Edited copies are stored with the same shooting date and time as the original.
- Even if the pictures that are marked for **Print order** () or **Protect** () are used for editing, these settings are not reflected on the edited copies.

Quick Retouch: Enhancing Contrast and Saturation

Select a picture (📖30) → MENU button(📖11) →  Quick retouch

Press the multi selector ▲ or ▼ to choose the setting level, and press the  button.

- The original version is displayed on the left and the edited version is displayed on the right.
- To cancel, press ◀.
- Quick retouched copies can be recognized by the  icon displayed in playback mode.

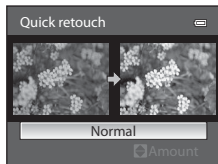

D-Lighting: Enhancing Brightness and Contrast

Select a picture (📖30) → MENU button (📖11) →  D-Lighting

Press the multi selector ▲ or ▼ to choose the setting level, and press the  button.

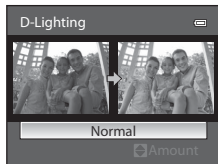

- The original version is displayed on the left and the edited version is displayed on the right.
- To cancel, press ◀.
- D-Lighting copies can be recognized by the  icon displayed in playback mode.



More Information

See "File and Folder Names" (📖94) for more information.

Skin Softening: Softening Skin Tones



Select a picture (30) → MENU button (11) →  Skin softening

1 Press the multi selector ▲ or ▼ to choose the setting level, and press the button.

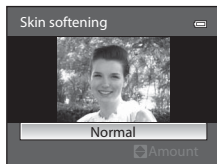
- A confirmation screen is displayed, and the image is displayed zoomed in on the face edited by skin softening.
- To cancel, press ◀.



2 Confirm the results.

- Up to 12 faces, in order of proximity to the center of the frame, can be enhanced.
- When multiple faces are edited using skin softening, use the multi selector ◀ or ▶ to switch the face that is displayed.
- To adjust the extent of skin softening, press the MENU button and return to step 1.
- To create a copy edited with skin softening, press the  button.
- Copies created by editing with skin softening can be recognized by the  icon displayed in playback mode.

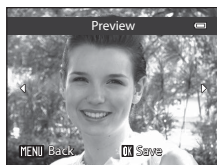

Notes on Skin Softening

- Depending on conditions such as the direction the subject is facing or the brightness of the face, the face may not be detected properly, or the desired effect may not be achieved.
- If no faces are detected in the image, a warning is displayed and the screen returns to the playback menu.

More Information

See "File and Folder Names" (94) for more information.

Filter Effects: Applying Digital Filter Effects

Select a picture (📖30) → MENU button (📖11) → 🎨 Filter effects

Option	Description
Selective color	Keep only the selected image color and make other colors black-and-white.
Cross screen	Produce star-like rays of light that radiate outward from bright objects such as sunlight reflections and city lights. Suitable for night scenes.
Fisheye	Create images that look like they were shot with a fisheye lens. Suitable for pictures shot in macro mode.
Miniature effect	Create images that look like close-up photos of a diorama. Suitable for pictures shot while looking down from a high location, with the main subject near the center of the frame.
Painting	Create images with the ambience of paintings.

1 Press the multi selector ▲ or ▼ to choose the filter effect type, and press the Ⓞ button.

- When **Cross screen**, **Fisheye**, **Miniature effect** or **Painting** is selected, proceed to step 3.

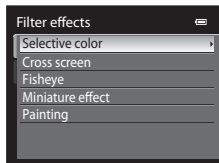

2 Adjust the effect and press the Ⓞ button.

- **Selective color:** Press ▲ or ▼ to select the color to keep.

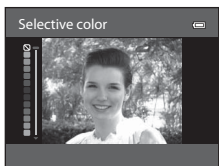

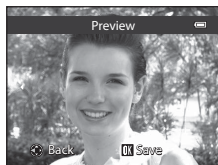

3 Confirm the result and press the **OK** button.

- A new, edited copy is created.
 - To cancel, press **◀**.
-
- Copies created by editing with filter effects can be recognized by the  icon displayed in playback mode.



Small Picture: Reducing the Size of an Image

Select a picture (30) → MENU button (11) →  Small picture

1 Press the multi selector **▲** or **▼** to choose the desired copy size, and press the **OK** button.

- The available sizes are **640×480**, **320×240** and **160×120**.

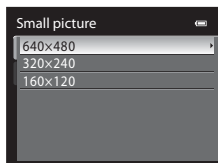

2 Choose **Yes** and press the **OK** button.

- A new, smaller copy is created.
- Image quality is saved as **Basic** (compression ratio of about 1:16).
- To cancel, choose **No** and press the **OK** button.
- Copies created by editing with small picture editing function are displayed with a black frame.

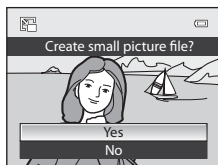

More Information

See "File and Folder Names" (94) for more information.

Black Border: Adding a Black Border to Pictures



Select a picture (📖30) → MENU button (📖11) →  Black border

- 1 Press the multi selector ▲ or ▼ to choose the desired frame thickness, and press the  button.

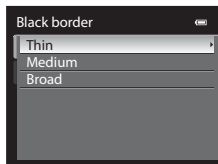
- Choose a frame thickness from **Thin**, **Medium** or **Broad** line.



- 2 Choose **Yes** and press the  button.

- A new copy with a black border is created.
- To cancel, choose **No** and press the  button.
- Copies created by editing with black border editing function can be recognized by the  icon displayed in playback mode.

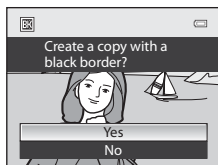

Notes on Black Border

- A part of the picture equivalent to the thickness of the black border is cut off because the black border overlaps the picture.
- When a picture with a black border is printed using a printer's borderless print function, the black border may not be printed.

More Information

See "File and Folder Names" (📖94) for more information.

✂ Crop: Creating a Cropped Copy

Create a copy containing only the portion visible on the monitor when **MENU**:✂ is displayed with playback zoom (📖31) enabled. Cropped copies are stored as separate files.

1 Enlarge the picture for cropping (📖31).

2 Refine copy composition.

- Rotate the zoom control toward **T** (📐) or **W** (📐) to adjust the zoom ratio.
- Press the multi selector ▲, ▼, ◀ or ▶ to scroll the picture until only the portion you want to copy is visible on the monitor.



3 Press the **MENU** button.

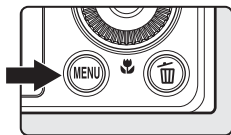

4 Use the multi selector to choose **Yes**, and press the **OK** button.

- A new cropped copy is created.
- To cancel, choose **No** and press the **OK** button.

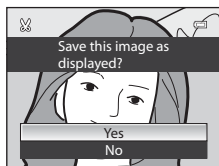

📐 Image Size

The narrower the cropping range, the smaller the size (amount of pixels) of the cropped picture copy. When the image size is resized to 320 × 240 or 160 × 120 by cropping, a black frame appears around the picture during playback, and the 📖 small picture icon is displayed on the left side of the monitor.

📐 Cropping the Picture in its Current “Tall” Orientation

Use the **Rotate image** option (🔄61) to rotate the picture so that it is displayed in landscape orientation. After cropping the picture, rotate the cropped picture back to “tall” orientation. The picture displayed in “tall” orientation can be cropped by zooming in on the picture until the black bars displayed on the both sides of the monitor disappear. The cropped picture is displayed in landscape orientation.

📐 More Information

See “File and Folder Names” (📁94) for more information.

Connecting the Camera to a TV (Viewing Images on a TV)

Connect the camera to a television to play back pictures on the television. If your television is equipped with an HDMI connector, you can connect it to the camera with a commercially available HDMI cable to play back pictures.

- 1 Turn off the camera.

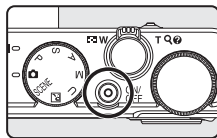

- 2 Connect the camera to the TV.

When connecting using the included audio/video cable

- Connect the yellow plug to the video-in jack on the TV, and the red and white plugs to the audio-in jacks.

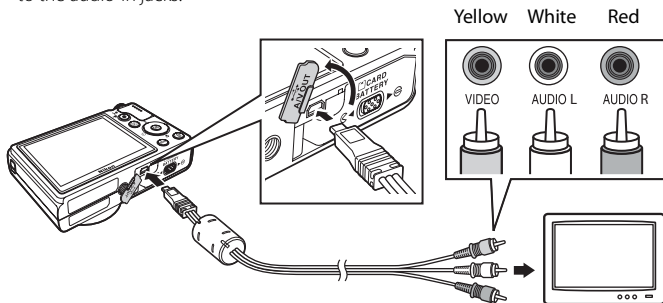

When connecting using a commercially available HDMI cable

- Connect the plug to the HDMI input connector on the TV.

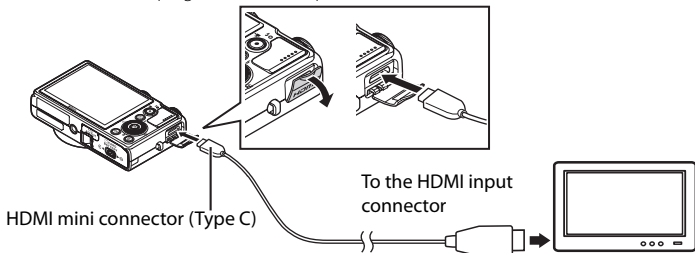

3 Tune the television to the video channel.

- See the instruction manual provided with your TV for details.

4 Hold down the  button to turn on the camera.

- The camera enters playback mode, and the recorded pictures are displayed on the TV.
- While the camera is connected to the TV, the monitor remains off.

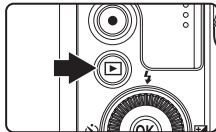
**✓ Notes on Connecting an HDMI Cable**

An HDMI cable is not included. Use a commercially available HDMI cable to connect the camera to a TV. The output terminal on this camera is a HDMI Mini Connector (Type C). When purchasing an HDMI cable, be sure that the device end of the cable is a HDMI Mini Connector.

✓ Notes on Connecting the Cable

- When connecting the cable, be sure that the plug is oriented correctly. Do not force the plug into the camera. When disconnecting the cable, do not pull the plug at an angle.
- Do not connect cables to the HDMI mini connector and USB/audio video connector simultaneously.

✓ When Nothing Appears on the TV

Make sure that **TV settings** (82) in the setup menu is appropriate for your TV.

 Using the TV's Remote Control (HDMI Device Control)

The remote control of a TV that conforms to the HDMI-CEC standard can be used to operate the camera during playback.

Instead of the multi selector or zoom control, the remote control can be used for picture selection, playback/pause of movies, switching between full-frame playback and 4-picture thumbnail display, etc.

- Set **HDMI device control** (82) of **TV settings** to **On** (default setting) in the setup menu, and connect the camera to the TV with an HDMI cable.
- Point the remote control at the TV to operate.
- See your TV's instruction manual or other related documentation to check whether your TV conforms to the HDMI-CEC standard.

Connecting the Camera to a Printer (Direct Print)

Users of PictBridge-compatible (🔦17) printers can connect the camera directly to the printer and print pictures without using a computer. The steps for printing are as follows.

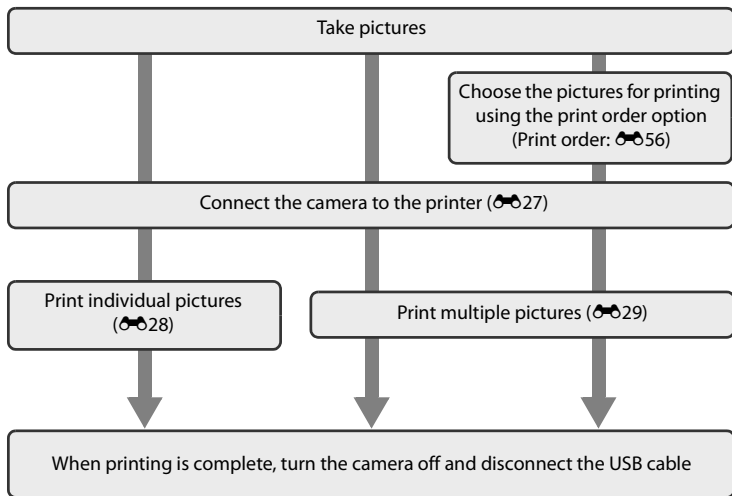

✔ Notes on Power Source

- When connecting the camera to a printer, use a fully charged battery to prevent the camera from turning off unexpectedly.
- If the AC Adapter EH-62F (available separately) (🔦96) is used, COOLPIX P310 can be powered from an electrical outlet. Do not, under any circumstances, use an AC Adapter other than the EH-62F. Failure to observe this precaution could result in overheating or damage to the camera.

📎 Printing Pictures

In addition to printing pictures transferred to a computer and printing pictures with a direct camera-to-printer connection, the following options are also available for printing pictures recorded on the memory card:

- Insert a memory card into a DPOF-compatible printer's card slot.
- Take a memory card to a digital photo lab.

For printing using these methods, specify the pictures and the number of prints each using the **Print order** (🔦56) option in the playback menu.

Connecting the Camera to a Printer

- 1 Turn off the camera.

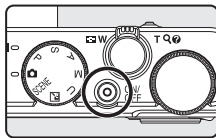

- 2 Turn on the printer.

- Check the printer settings.

- 3 Connect the camera to the printer using the included USB cable.

- Be sure that the plug is oriented correctly. When disconnecting the cable, do not pull the plug at an angle.

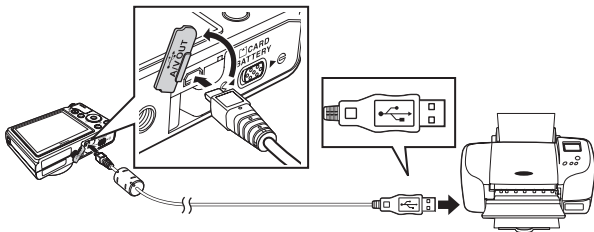

- 4 The camera is automatically turned on.

- When connected correctly, the **PictBridge** startup screen (①) is displayed on the camera monitor. Then the **Print selection** screen (②) is displayed.

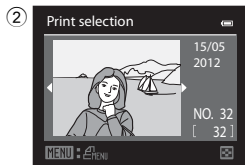
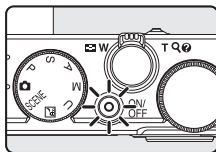

✔ If the PictBridge Startup Screen Is Not Displayed

Turn the camera off and disconnect the USB cable. Set the **Charge by computer** option (884) in the camera's setup menu to **Off** and reconnect the cable.

Printing Individual Images

After connecting the camera to the printer correctly (📷27), print pictures by following the procedure below.

1 Use the multi selector to choose the picture to be printed, and press the **OK** button.

- Rotate the zoom control toward **W** (📷) to display 12 thumbnails, or toward **T** (📺) to switch back to full-frame playback mode.

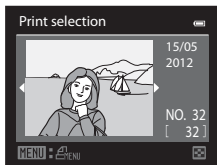

2 Choose **Copies** and press the **OK** button.

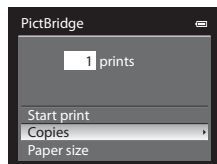

3 Choose the number of copies (up to nine) and press the **OK** button.



4 Choose **Paper size** and press the **OK** button.

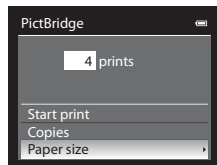

More Information

See "Printing Images of Size 1:1" (📖74) for more information.

5 Choose the desired paper size and press the **OK** button.

- To specify the paper size using the printer settings, choose **Default** in the paper size menu.

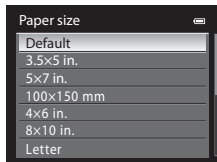

6 Choose **Start print** and press the **OK** button.

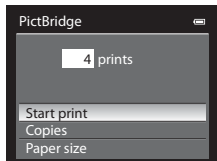

7 Printing starts.

- The monitor display returns to that shown in step 1 when printing is complete.
- To cancel before all copies have been printed, press the **OK** button.

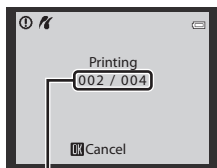

Current print/total number of prints

Printing Multiple Images

After connecting the camera to the printer correctly (027), print pictures by following the procedure below.

1 When the **Print selection** screen is displayed, press the **MENU** button.

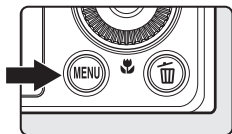

2 Use the multi selector to choose **Paper size**, and press the **OK** button.

- To exit the print menu, press the **MENU** button.

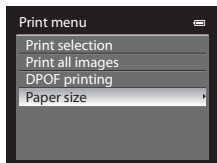

3 Choose the desired paper size and press the **OK** button.

- To specify the paper size using the printer settings, choose **Default** in the paper size menu.

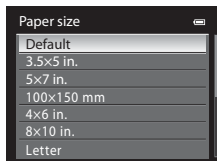

4 Choose **Print selection**, **Print all images** or **DPOF printing** and press the **OK** button.

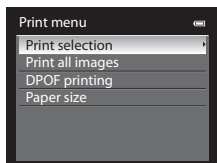

Print selection

Choose the pictures (up to a maximum of 99) and number of copies (up to nine per picture).

- Press the multi selector **◀** or **▶** to choose the pictures, and press **▲** or **▼** to set the number of copies for each.
- Pictures selected for printing can be recognized by the check mark icon and the numeral indicating the number of copies to be printed. A check mark is not displayed with pictures for which no copies have been specified and these pictures are not printed.
- Rotate the zoom control toward **T** (📷) to switch to full-frame playback mode, or **W** (📱) to switch to 12 thumbnail display.
- Press the **OK** button when setting is complete.
- When the menu shown on the right is displayed, choose **Start print** and press the **OK** button to start printing.
- Choose **Cancel** and press the **OK** button to return to the print menu.

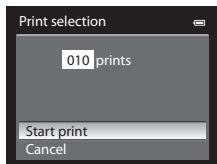

Print all images

All pictures stored in the internal memory or on the memory card are printed one per each.

- When the menu shown on the right is displayed, choose **Start print** and press the **OK** button to start printing.
- Choose **Cancel** and press the **OK** button to return to the print menu.

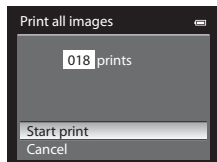

DPOF printing

Pictures for which a print order was created in **Print order** option (056) can be printed.

- When the menu shown on the right is displayed, choose **Start print** and press the **OK** button to start printing.
- Choose **Cancel** and press the **OK** button to return to the print menu.
- To view the current print order, choose **View images** and press the **OK** button. To print pictures, press the **OK** button again.

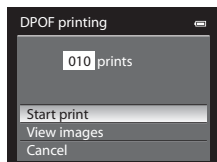

5 Printing starts.

- The monitor display returns to that shown in step 2 when printing is complete.
- To cancel before all copies have been printed, press the **OK** button.

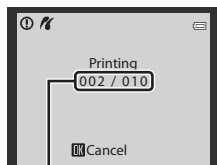

Current print/total number of prints

Paper Size

The camera supports the following paper sizes: **Default** (the default paper size for the current printer), **3.5×5 in.**, **5×7 in.**, **100×150 mm**, **4×6 in.**, **8×10 in.**, **Letter**, **A3**, and **A4**. Only sizes supported by the current printer are displayed.

Editing Movies

Extracting Only the Desired Portions of the Movie

The desired portions of a recorded movie can be saved as a separate file.

1 Play back the movie to be edited and pause at the start point of the portion that is to be extracted (📖96).

2 Use the multi selector ◀ or ▶ to choose ✂ on the playback control, and press the Ⓞ button.

- The movie editing screen is displayed.

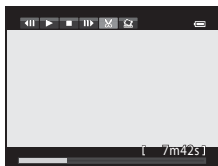

3 Press ▲ or ▼ to choose ⏮ (Choose start point) on the editing playback control.

- Rotate the multi selector or press ◀ or ▶ to adjust the start position.
- To cancel, press ▲ or ▼ to choose ⏪ (Back) and press the Ⓞ button.

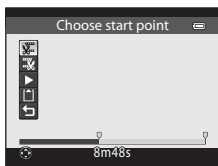

4 Press ▲ or ▼ to choose ⏭ (Choose end point).

- Rotate the multi selector or press ◀ or ▶ to move the end point at the right end to the end position of the required section.
- To check the playback of the movie in the specified range before saving it, choose ▶ (Preview) and press the Ⓞ button. During preview playback, the volume can be adjusted with the zoom control T/W. Use the multi selector to fast forward or rewind. To stop the preview playback, press the Ⓞ button again.

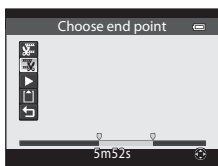

5 After finishing the settings, press ▲ or ▼ to choose 💾 (Save) and press the Ⓞ button.

6 Choose **Yes** and press the Ⓞ button.

- The edited movie is saved.
- To cancel the saving, choose **No**.

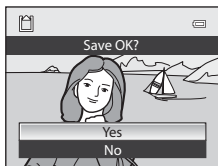

✓ Notes on Editing Movies





- Use a fully charged battery to prevent the camera from turning off during editing. When the battery level is , movie editing is not possible.
- Once a movie is created through editing, it cannot be used again for extracting a movie. To extract another range, select and edit the original movie.
- Because the edited movies are extracted in 1-second units, they may vary slightly from the set start point and end point. Sections shorter than two seconds cannot be extracted.
- Editing functions are not available when there is not enough free space in the internal memory or on the memory card.

✎ More Information



See "File and Folder Names" (94) for more information.

Saving a Frame from a Movie as a Still Picture



A frame from a recorded movie can be extracted and saved as a still picture.

- Pause a movie and display the frame to be extracted (96).
- Choose  on the playback control with the multi selector  or  and press the  button.

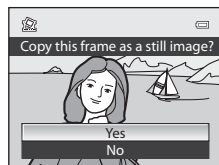

- When the confirmation dialog is displayed, choose **Yes** and press the  button to save. To cancel the saving, choose **No**.
- The still picture is saved with **Normal** as the image quality. The image size is determined by the type (image size) (65) of the original movie.



For example, a still picture saved from a movie recorded with  **HD 1080p★ (1920×1080)** is  (1920 × 1080 pixels).

Shooting Menu (P, S, A or M Mode)

Image Quality and Image Size







To set the image quality and image size, see “Changing the Image Quality and Image Size” (📖72).

Picture Control (COOLPIX Picture Control)

Rotate the mode dial to **P, S, A or M** → **MENU** button → **P, S, A or M** tab (📖11)
→ Picture Control

Change the settings for image recording according to the shooting scene or your preferences. Sharpness, contrast and saturation can be adjusted in detail.

Types of COOLPIX Picture Control

Option	Description
 Standard (default setting)	Standard processing for balanced results. Recommended for most situations.
 Neutral	Minimal processing for natural results. Choose for pictures that will later be extensively processed or retouched.
 Vivid	Pictures are enhanced for a vivid, photoprint effect. Choose for pictures that emphasize primary colors, such as blue, red, and green.
 Monochrome	Take monochrome photographs such as in black-and-white or sepia.
 Custom 1*	Change to the setting for Custom 1 in COOLPIX Custom Picture Control.
 Custom 2*	Change to the setting for Custom 2 in COOLPIX Custom Picture Control.

* Only displayed when the setting customized in **Custom Picture Control** (📖38) has been registered.

The icon for the current setting other than **Standard** is displayed on the monitor (📖6).

✔ Notes on COOLPIX Picture Control

- The COOLPIX Picture Control feature of the COOLPIX P310 cannot be used with other makes of cameras, Capture NX, Capture NX 2 and ViewNX 2 Picture Control feature.
- This feature may not be used in combination with certain features. See “Features That Cannot Be Used Simultaneously” (📖75) for more information.

Customizing Existing COOLPIX Picture Controls: Quick Adjust and Manual Adjust

COOLPIX Picture Control can be customized using Quick adjust, which allows for balanced adjustment of sharpness, contrast, saturation and other image editing components, or manual adjust, which allows for detailed adjusting of the components individually.

- 1 Use the multi selector to choose the type of COOLPIX Picture Control, and press the **OK** button.

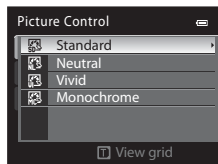

- 2 Press **▲** or **▼** to highlight the desired setting (6-36) and press **◀** or **▶** to choose a value.

- Press the **OK** button to set the value.
- When COOLPIX Picture Controls are modified from the default settings, an asterisk (*) is displayed after the options in the Picture Control Setting menu.
- To change the values to the default setting, select **Reset** and press the **OK** button.

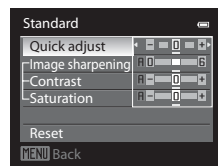

View Grid of COOLPIX Picture Control

When the zoom control is rotated toward **T** (Q) while the screen in step 1 of the above procedure is displayed, the contrast and saturation are displayed using a grid. The vertical axis indicates the contrast level, and the horizontal axis indicates the saturation. Rotate the zoom control toward **T** (Q) again to return to the previous screen.

The COOLPIX Picture Control grid displays the current and default settings in relation to the other COOLPIX Picture Controls.

- Rotate the multi selector to change to other COOLPIX Picture Controls.
- Press the **OK** button to display the COOLPIX Picture Control Setting screen (step 2 above).
- For **Monochrome**, the grid is displayed for contrast only.
- The grid is also displayed when adjusting **Contrast** or **Saturation** with manual adjustment.

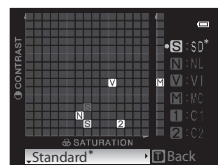

Types of Quick Adjust and Manual Adjust

Option	Description
Quick adjust ¹	Adjust the sharpness, contrast and saturation levels automatically. Five levels of adjustment are available from -2 to +2 . Choose from options between -2 and +2 to reduce or emphasize the effect of the selected COOLPIX Picture Control. The default setting is 0 .
Image sharpening	Control how much outlines are sharpened during shooting. Choose A (auto) to adjust sharpening automatically, or choose from seven levels of adjustment between 0 (no sharpening) and 6 . The higher the number, the sharper the image, and the lower the number, the softer the image. The default setting is 3 for Standard or Monochrome , 2 for Neutral and 4 for Vivid .
Contrast	Control the contrast. Choose A (auto) to adjust the contrast automatically according to the type of scene, or choose from seven levels of adjustment between -3 and +3 . – makes it into an image with a softer appearance, and + gives it a harder appearance. Choose lower values to prevent highlights in portrait subjects from being “washed out” in direct sunlight, higher values to preserve detail in misty landscapes and other low-contrast subjects. The default setting is 0 .
Saturation ²	Control the vividness of colors. Choose A (auto) to adjust saturation automatically according to the type of scene, or seven levels of adjustment can be done by choosing from values between -3 and +3 . Setting to the – side reduces the vividness, and setting to the + side increases the vividness. The default setting is 0 .
Filter effects ³	Simulate the effect of color filters on monochrome photographs. Choose from OFF (the default setting), Y (yellow), O (orange), R (red), and G (green). Y, O, R: Enhance contrast. Can be used to tone down the brightness of the sky in landscape photographs. The contrast is strengthened in the order Y → O → R . G: Soften skin tones. Suitable for portraits.

Option	Description
Toning ³	Control the tint used in monochrome photographs from B&W (black-and-white, the default setting), Sepia , and Cyanotype (blue-tinted monochrome). Pressing the rotary multi selector ▼ when Sepia or Cyanotype is selected enables you to choose from seven levels of gradation. Press ◀ or ▶ to adjust the saturation.

- 1 Quick adjust is not available in **Neutral**, **Monochrome**, **Custom 1** and **Custom 2**. The values set manually are disabled if quick adjust is used after manual setting.
- 2 Not displayed for **Monochrome**.
- 3 Only displayed for **Monochrome**.

✔ Note on Image sharpening

The effects of **Image sharpening** cannot be previewed on the monitor during shooting. Check the results in playback mode.

✔ Note on Contrast

When **Active D-Lighting** (54) is set to settings other than **Off**, the  mark is displayed for **Contrast** and **Contrast** cannot be adjusted.

✔ Contrast, Saturation and A (Auto)

- Results for contrast and saturation vary with the exposure, and the position and size of the subject in the frame.
- The setting for the COOLPIX Picture Control which has **A** (auto) selected for either **Contrast** or **Saturation** is displayed in green in the COOLPIX Picture Control grid.

✏ Options that Can Be Adjusted in Custom 1 and Custom 2

The option of the original COOLPIX Picture Control can be adjusted if **Custom 1** or **Custom 2** is selected.

Custom Picture Control (COOLPIX Custom Picture Control)

Rotate the mode dial to P, S, A or M → MENU button → P, S, A or M tab (11)
→ Custom Picture Control

The picture editing options created by customizing COOLPIX Custom Picture Controls can be registered up to two options. The registered options can be displayed as **Custom 1** and **Custom 2** in COOLPIX Custom Picture Control.

Creating COOLPIX Custom Picture Control

- 1 Use the multi selector to choose **Edit and save**, and press the **OK** button.

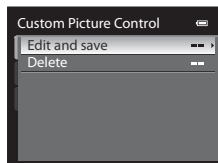

- 2 Choose the original COOLPIX Picture Control (35) to be edited, and press the **OK** button.

- 3 Press **▲** or **▼** to highlight the desired setting and press **◀** or **▶** to choose a value (35).
 - The options are the same as those for adjusting the COOLPIX Picture Control.
 - Press the **OK** button to display the **Save as** screen.
 - To change the values to the default setting, select **Reset** and press the **OK** button.

- 4 Choose the registration destination and press the **OK** button.

- The COOLPIX Custom Picture Control is registered.
- **Custom 1** or **Custom 2** can be selected from the **Picture Control** and **Custom Picture Control** selection screen after registration.

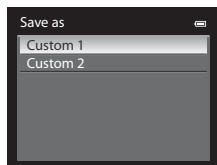

Deleting COOLPIX Custom Picture Control

Select **Delete** in step 1 of "Creating COOLPIX Custom Picture Control" to delete a registered Custom Picture Control.

White Balance (Adjusting Hue)

Rotate the mode dial to **P, S, A or M** → MENU button → **P, S, A or M** tab (📖11)
→ White balance

The color of light reflected from an object varies with the color of the light source. The human brain is able to adapt to changes in the color of the light source, with the result that white objects appear white whether seen in the shade, direct sunlight, or under incandescent lighting. Digital cameras can mimic this adjustment of the human eye by processing images according to the color of the light source. This is known as “white balance.” For natural colors, select a white balance setting that matches the light source before shooting.

Although the default setting, **Auto (normal)**, can be used under most types of lighting, you can apply the white balance setting suited to a particular light source to achieve more accurate results.

Option	Description
AUTO1 Auto (normal) (default setting)	White balance is automatically adjusted to suit lighting conditions. Best choice in most situations.
AUTO2 Auto (warm lighting)	When set to Auto (warm lighting) , the images are preserved with warm colors if they are shot under an incandescent light source. When using the flash, according to the brightness of the flash, the images are adjusted to suitable white balance.
PRE Preset manual	Useful when shooting under unusual lighting. See “Using Preset Manual” for more information (📖40).
☀️ Daylight *	White balance adjusted for direct sunlight.
💡 Incandescent *	Use under incandescent lighting.
🔦 Fluorescent (1 to 3)	Use under most types of fluorescent lighting. Choose one of 1 (white fluorescent), 2 (daylight white/neutral fluorescent) and 3 (daylight fluorescent).
☁️ Cloudy *	Use when taking pictures under overcast skies.
🔦 Flash *	Use with the flash.

* Fine adjustments in seven steps are available. Apply positive (+) to increase blue hue and negative (-) to increase red hue.

The icon for the current setting other than **Auto (normal)** is displayed on the monitor (📖6).

📌 Notes on White Balance

- At white-balance settings other than **Auto (normal)**, **Auto (warm lighting)** or **Flash**, set the flash mode to 📷 (off) (📖60).
- This feature may not be used in combination with certain features. See “Features That Cannot Be Used Simultaneously” (📖75) for more information.

Using Preset Manual

Use when you want to make pictures taken under unusual lighting conditions (e.g., lamps with reddish-light) look as though they were shot in normal light.

Use the procedure below to measure the white balance value under the lighting used during shooting.

1 Place a white or gray reference object under the lighting that will be used during shooting.

2 Display the shooting menu (📖54), use the multi selector to set **White balance to PRE Preset manual**, then press the **OK** button.

- The lens extends to the zoom position for measurement.

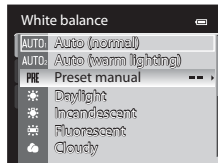

3 Choose **Measure**.

- To apply the most recently measured white balance value, select **Cancel** and press the **OK** button. The most recently measured white balance value will be set without re-measuring the value.

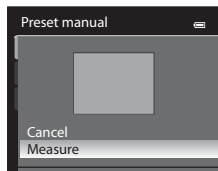

4 Frame a white or gray reference object in the reference object frame.

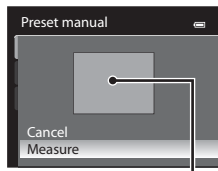

Reference object frame

5 Press the **OK** button to measure the white balance value.

- The shutter is released and the new white balance preset value is set (no picture is recorded).

✔ Note on Preset Manual



The camera cannot measure a white balance value for when the flash fires. When shooting with the flash, set **White balance to Auto (normal), Auto (warm lighting) or Flash**.

Metering

Rotate the mode dial to **P, S, A or M** → **MENU** button → **P, S, A or M** tab (📖11)
→ Metering

The process of measuring the brightness of the subject to determine the exposure is known as “metering.”

Use this option to choose how the camera meters exposure.

Option	Description
 Matrix (default setting)	The camera uses a wide area of the screen for metering. This metering mode provides the appropriate exposure for a variety of shooting conditions. Recommended for typical shooting.
 Center-weighted	The camera meters the entire frame but assigns greatest weight to the subject at the center of the frame. The classic metering for portraits; it preserves background details while letting lighting conditions at the center of the frame determine exposure. Can be used with focus lock (📖81) to meter off-center subjects.
 Spot	The camera meters the area shown by the circle in the center of the frame. This can be used when the subject metering target is lighter or darker than the background. Ensure that the subject is within the area shown by the circle when shooting. Can be used with focus lock (📖81) to meter off-center subjects.

Notes on Metering

- When the digital zoom is in effect, **Metering** is set to **Center-weighted** or **Spot**.
- This feature may not be used in combination with certain features. See “Features That Cannot Be Used Simultaneously” (📖75) for more information.











Metering Area





When **Center-weighted** or **Spot** is selected for **Metering**, the metering range guide (📖6) is displayed (except when digital zoom is used).

Continuous Shooting

Rotate the mode dial to P, S, A or M → MENU button → P, S, A or M tab (☰11)
→ Continuous

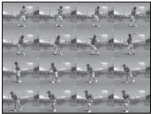

Change the settings for continuous shooting and BSS (Best Shot Selector).

Option	Description
 Single (default setting)	One picture is shot each time the shutter-release button is pressed.
 Continuous H	Pictures are continuously shot at a rate of about seven frames per second while the shutter-release button is pressed all the way (when image quality is set to Normal and image size is set to  4608×3456). Shooting ends when the shutter-release button is released, or five pictures have been taken continuously.
 Continuous L	Up to about 30 pictures are continuously shot at a rate of about one frame per second while the shutter-release button is pressed all the way (when image quality is set to Normal and image size is set to  4608×3456).
 Pre-shooting cache	Pre-shooting cache makes it easy to capture perfect moments, by saving images from before the shutter-release button was pressed all the way. Pre-shooting cache shooting begins when the shutter-release button is pressed halfway, and shooting continues when the shutter-release button is pressed all the way ( 44). <ul style="list-style-type: none"> • Frame rate: up to 15 fps • Number of frames: <ul style="list-style-type: none"> Up to 20 frames (including up to 5 frames captured in the pre-shooting cache) Shooting ends when the shutter-release button is released or when the maximum number of frames has been shot. The image quality is fixed at Normal and the image size is fixed at  (2048 × 1536 pixels).
120 Continuous H: 120 fps	Each time the shutter-release button is pressed all the way, 60 frames are captured at a speed of about 1/125 s or faster. The image size is fixed at  (640 × 480 pixels).
60 Continuous H: 60 fps	Each time the shutter-release button is pressed all the way, 60 frames are captured at a speed of about 1/60 s or faster. The image size is fixed at  (1280 × 960 pixels).

Option	Description
BSS BSS (Best Shot Selector)	BSS is recommended for shooting under low lighting without the flash, with the camera zoomed in, or in other situations in which camera shake is likely to blur pictures. Keep pressing the shutter-release button all the way, and up to ten pictures are shot and the camera automatically selects and saves only the sharpest picture in the series.
 Multi-shot 16	Each time the shutter-release button is pressed all the way, the camera shoots 16 pictures at a rate of about 30 frames per second and arranges them in a single picture.  <ul style="list-style-type: none"> • The image quality is fixed at Normal and the image size is fixed at  (2560 × 1920 pixels). • The digital zoom is not available.
 Intvl timer shooting	The camera shoots still pictures automatically at the specified interval ( 44).

The icon for the current setting other than **Single** is displayed on the monitor (6).

Notes on Continuous Shooting

- Focus, exposure and white balance are fixed at the values determined with the first shot in each series.
- The frame rate may become slower depending on the image quality, image size, memory card type or shooting conditions.
- When **ISO sensitivity** (46) is set to **3200** or **Hi 1**, the frame rate becomes slower.
- This feature may not be used in combination with certain features. See “Features That Cannot Be Used Simultaneously” (75) for more information.

Note on BSS

BSS is suited for shooting stationary subjects. BSS may not produce the desired results if the subject moves or the composition changes.

Note on Multi-shot 16

Banding or variance in brightness or hue may occur in images that were captured under lighting that flashes quickly, such as fluorescent, mercury-vapor, or sodium-vapor lighting.

Notes on Continuous H

- It may take some time to save the images after shooting. The amount of time it takes to finish saving the captured images depends on the number of images, the write speed of the memory card, etc.
- When ISO sensitivity increases, noise may appear in captured images.
- Accurate exposure may not be achieved (images may be overexposed) in images captured on bright sunny days.
- Banding or variance in brightness or hue may occur in images that were captured under lighting that flashes quickly, such as fluorescent, mercury-vapor, or sodium-vapor lighting.

Pre-shooting Cache

When **Pre-shooting cache** is selected, shooting begins when the shutter-release button is pressed halfway for 0.5 seconds or longer, and images captured before the shutter-release button is pressed all the way are saved along with images captured after the shutter-release button is pressed all the way. Up to five images can be saved in the pre-shooting cache.

The current pre-shooting cache setting is indicated by an icon when shooting (📖6). The pre-shooting cache icon lights in green while the shutter-release button is pressed halfway.

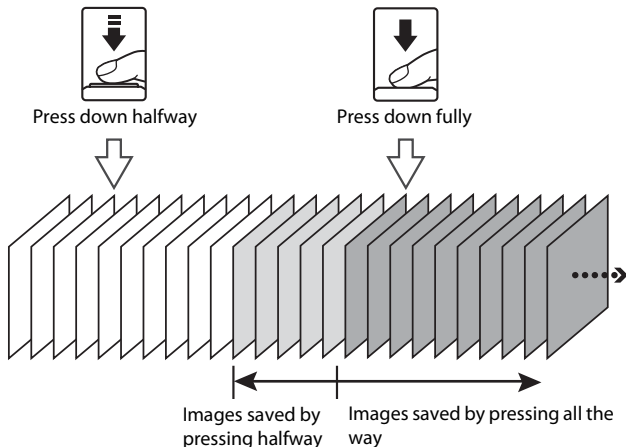

- If the number of exposures remaining is less than six, the pictures taken with the pre-shooting cache are not recorded. Before shooting, check that there are six or more exposures remaining.

Interval Timer Shooting

Rotate the mode dial to P, S, A or M → MENU button → P, S, A or M tab (📖11)
→ Continuous

Choose from **30 s**, **1 min**, **5 min** or **10 min**.

- 1 Use the multi selector to select  **Intvl timer shooting** for the **Continuous** setting, and then press the **OK** button.

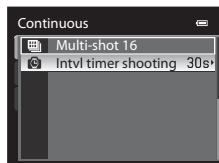

2 Choose the interval between each shot and press the **OK** button.

- The maximum amount of frames that can be taken during interval timer shooting differs according to the selected interval.
 - 30 s**: 600 images
 - 1 min**: 300 images
 - 5 min**: 60 images
 - 10 min**: 30 images

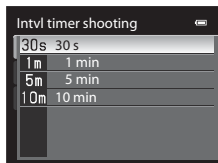

3 Press the **MENU** button.

- The camera returns to shooting screen.

4 Press the shutter-release button all the way to shoot the first picture and start interval timer shooting.

- The monitor is turned off and the power-on lamp flashes between shots.
- The monitor reactivates automatically immediately before the next picture is shot.

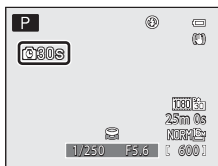

5 Press the shutter-release button all the way again to finish shooting.

- Shooting finishes automatically if the internal memory or memory card becomes full, or when the number of shot frames reaches the upper limit.

✓ Notes on Interval Timer Shooting

- To prevent the camera from turning off unexpectedly during shooting, use a fully charged battery.
- If the AC Adapter EH-62F (available separately) (0096) is used, COOLPIX P310 can be powered from an electrical outlet. Do not use any other make or model of AC adapter. Failure to observe this precaution could result in overheating or damage to the camera.
- Do not rotate the mode dial to a different setting while performing interval timer shooting.

📎 More Information

See "File and Folder Names" (0094) for more information.

ISO Sensitivity

Rotate the mode dial to **P, S, A or M** → **MENU** button → **P, S, A or M** tab (☞11)
 → ISO sensitivity

The higher the ISO sensitivity, the less light needed for taking pictures.

The higher the ISO sensitivity, the darker the subject that can be shot. Additionally, even with subjects of similar brightness, pictures can be taken at faster shutter speeds, and blurring caused by camera shake and subject movement can be reduced.

- Setting the ISO sensitivity to a high level is effective when shooting dark subjects, not using the flash, shooting at the telephoto zoom position and similar situations, but the pictures taken may be slightly grainy.

Types of ISO Sensitivity

Option	Description
ISO sensitivity	<ul style="list-style-type: none"> • Auto (default setting): The sensitivity is ISO 100 in bright places; in dark places the camera automatically raises the sensitivity to a maximum of ISO 1600. • Fixed range auto: Choose the range in which the camera automatically adjusts ISO sensitivity from ISO 100-400 (default setting) and ISO 100-800. The camera does not raise sensitivity beyond the maximum value in the selected range. Set the maximum value for ISO sensitivity to control “grain” that appears in images. • 100, 200, 400, 800, 1600, 3200, Hi 1 (equivalent to ISO 6400): ISO sensitivity is locked at the specified value.
Minimum shutter speed	<p>When the shooting mode is P or A and ISO sensitivity is set to Auto or Fixed range auto, the shutter speed at which the ISO sensitivity automatic control starts to function (1/125 to one second) can be set. The default setting is None. If the exposure is insufficient with the shutter speed that is set here, the ISO sensitivity is increased automatically to obtain the correct exposure. If the exposure is still insufficient even after the ISO sensitivity is increased, the shutter speed slows down.</p>

The icon for the current setting is displayed on the monitor during shooting (☞6).

- When **Auto** is selected, the **ISO** icon is not displayed at ISO 100, but is displayed if the ISO sensitivity automatically increases to higher than 100 (☞26).
- When **Fixed range auto** is selected, the **ISO** icon and the maximum ISO sensitivity value are displayed.

✓ Notes on ISO Sensitivity

- In **M** (Manual) mode, ISO sensitivity is fixed at ISO 100 if **Auto** or **Fixed range auto** is selected.
- This feature may not be used in combination with certain features. See “Features That Cannot Be Used Simultaneously” (☞75) for more information.

Exposure Bracketing

Rotate the mode dial to **P, S or A** → MENU button → **P, S or A** tab (📖11)
→ Exposure bracketing

The exposure (brightness) can be changed automatically during continuous shooting. This is effective for shooting when it is difficult to adjust the picture brightness.

Option	Description
±0.3	Camera varies exposure by 0, -0.3, and +0.3 over next three shots. The three shots are taken in sequence when the shutter-release button is pressed all the way.
±0.7	Camera varies exposure by 0, -0.7, and +0.7 over next three shots. The three shots are taken in sequence when the shutter-release button is pressed all the way.
±1.0	Camera varies exposure by 0, -1.0, and +1.0 over next three shots. The three shots are taken in sequence when the shutter-release button is pressed all the way.
Off (default setting)	Exposure bracketing is not performed.

When exposure bracketing is enabled, the current setting is displayed during shooting (📖6). When **Off** is selected, an icon for the current setting is not displayed.



✓ Notes on Exposure Bracketing





- **Exposure bracketing** is not available in **M** (Manual) mode.
- When exposure compensation (📖68) and **±0.3, ±0.7 or ±1.0** in **Exposure bracketing** are set simultaneously, the combined exposure compensation values are applied.
- This feature cannot be used simultaneously with certain features. See “Features That Cannot Be Used Simultaneously” (📖75) for more information.

AF Area Mode

Rotate the mode dial to **P, S, A or M** → MENU button → P, S, A or M tab (11) → AF area mode

You can set how the focus area is determined for autofocus.

Option	Description
 Face priority	<p>The camera automatically detects and focuses on a face (see “Using Face Detection” (180) for more information). If the camera detects multiple faces, the camera focuses on the face closest to the camera. When non-human subjects are photographed, or a subject with which no face can be detected is framed, AF area mode is set to Auto. The camera automatically selects the focus areas (up to nine) that contain the subject closest to the camera.</p> <div data-bbox="681 330 930 512" data-label="Image"> </div> <p data-bbox="707 526 811 547">Focus area</p>
 Auto (default setting)	<p>The camera automatically selects the focus areas (up to nine) that contain the subject closest to the camera. Press the shutter-release button halfway to activate the focus area. When the shutter-release button is pressed halfway, the focus area selected by the camera is displayed on the monitor (up to nine areas).</p> <div data-bbox="681 673 930 855" data-label="Image"> </div> <p data-bbox="743 865 857 886">Focus areas</p>

Option	Description
<p> Manual</p>	<p>Choose manually the focus position from 99 areas in the screen. This option is suited to situations in which the intended subject is relatively still and not positioned at the center of the frame. Rotate the multi selector or press ▲, ▼, ◀ or ▶ to move the focus area to where the subject is, and take a picture.</p> <ul style="list-style-type: none"> To adjust the following settings, press the  button to temporarily cancel focus area selection, and then adjust each setting. <ul style="list-style-type: none"> - Flash mode, focus mode, self-timer or exposure compensation To return to the focus area selection screen, press the  button again.
<p> Center</p>	<p>The camera focuses on the subject at the center of the frame. The focus area is always displayed at the center of the frame.</p>
<p> Subject tracking</p>	<p>Subject tracking begins once you select a subject to be focused on, and the focus area will move and follow the subject. See “Using Subject Tracking” (51).</p>

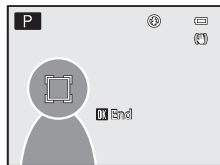
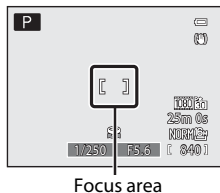
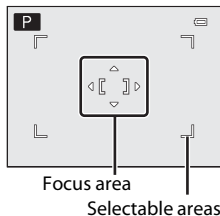

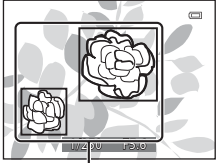
Option	Description
<input checked="" type="checkbox"/> Target finding AF	<p>When the camera detects the main subject, it focuses on that subject.</p> <p>See "Using the Target Finding AF" (879) for more information.</p>  <p style="text-align: center;">AF areas</p>

Notes on AF Area Mode

- When the digital zoom is in effect, the camera focuses on the subject at the center of the frame regardless of the applied **AF area mode** option.
- In some rare cases of shooting subjects for which autofocus does not perform as expected (829), the subject may not be in focus.
- This feature may not be used in combination with certain features. See "Features That Cannot Be Used Simultaneously" (875) for more information.
- If the camera does not focus on the desired subject when using a feature that selects and focuses on the subject, such as **Target finding AF**, set **AF area mode** to **Manual** or **Center** and align the focus area with the desired subject. You can also try using focus lock (881).

Using Subject Tracking

Rotate the mode dial to **P, S, A or M** → **MENU** button → **P, S, A or M** tab (11)
→ AF area mode

Choose this mode to shoot moving subjects. Subject tracking begins once you select a subject to be focused on, and the focus area will move and follow the subject.

1 Rotate the multi selector to select **Subject tracking**, and press the **OK** button.

- Press the **MENU** button after changing the settings and return to the shooting screen.

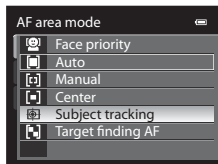

2 Frame the subject at the center of the border, and press the **OK** button.

- The subject is registered.
- When the camera is unable to focus on the subject, the border lights in red. Change the composition and try again.
- Once the subject is registered, it is framed by a yellow focus area display, and subject tracking begins.
- Press the **OK** button to cancel the registration of the subject.
- If the camera loses sight of the subject, the focus area display disappears; register the subject again.

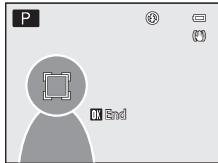
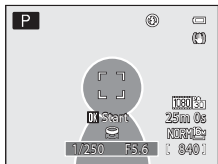

3 Press the shutter-release button all the way to take the picture.

- If the camera focuses on the focus area when the shutter-release button is pressed halfway, the focus area display lights in green and the focus is locked.
- If the shutter-release button is pressed halfway while the focus area is not displayed, the camera focuses the subject at the center of the frame.

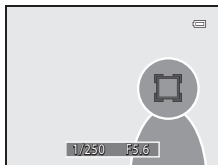

✔ Notes on Subject Tracking

- The digital zoom is not available.
- Set the zoom position, flash mode, focus mode, or menu settings before registering a subject. If any of these are changed after a subject is registered, the subject will be canceled.
- During certain conditions, such as when the subject is moving quickly, when there is a large amount of camera shake, or when there are multiple subjects that look alike, the camera may not be able to register or track a subject, or the camera may track a different subject. Additionally, the subject may not be tracked properly depending on factors such as the subject's size and brightness.
- In some rare cases of shooting subjects for which autofocus does not perform as expected (📖29), the subject may not be in focus despite the fact that the focus area lights in green. If you cannot focus, change the **AF area mode** to **Manual** or **Center** and try shooting with focus lock (📖81) by refocusing on another subject at the same distance.
- This feature may not be used in combination with certain features. See "Features That Cannot Be Used Simultaneously" (📖75) for more information.

Autofocus Mode

Rotate the mode dial to P, S, A or M → MENU button → P, S, A or M tab (📖11)
→ Autofocus mode

Choose how the camera focuses.

Option	Description
AF-S Single AF (default setting)	The camera focuses only when the shutter-release button is pressed halfway.
AF-F Full-time AF	The camera focuses continuously until the shutter-release button is pressed halfway. Use with moving subjects. A sound will be heard while the camera focuses.

✔ Note on AF mode

This feature may not be used in combination with certain features. See "Features That Cannot Be Used Simultaneously" (📖75) for more information.

✎ Autofocus Mode for Movie Recording

Autofocus mode for movie recording can be set with **Autofocus mode** (📖69) in the movie menu.

Flash Exp. Comp.

Rotate the mode dial to P, S, A or M → MENU button → P, S, A or M tab (📖11)
→ Flash exp. comp.

Compensate the flash output.

Use this option when the flash is too bright or too dark.

Option	Description
+0.3 to +2.0	The flash output is increased from +0.3 to +2.0 EV, in increments of 1/3 EV, to make the main subject of the frame appear brighter.
0.0 (default setting)	The flash output is not adjusted.
-0.3 to -2.0	The flash output is reduced from -0.3 to -2.0 EV, in increments of 1/3 EV, to prevent unwanted highlights or reflections.

The icon for the current setting other than **0.0** is displayed on the monitor (📖6).

Noise Reduction Filter

Rotate the mode dial to P, S, A or M → MENU button → P, S, A or M tab (📖11)
→ Noise reduction filter

Set the strength of the noise reduction function that is normally performed when recording the picture.

Option	Description
NR⁺ High	Perform noise reduction at a level higher than the standard strength.
NR Normal (default setting)	Perform noise reduction at the standard strength.
NR⁻ Low	Perform noise reduction at a level lower than the standard strength.

Noise reduction filter setting can be confirmed on the monitor when recording a picture (📖6).

Active D-Lighting

Rotate the mode dial to **P, S, A or M** → MENU button → **P, S, A or M** tab (📖11)
→ Active D-Lighting

“Active D-Lighting” preserves details in highlights and shadows, creating photographs with natural contrast. The image taken reproduces the contrast effect that is seen with the naked eye. This is particularly effective for shooting scenes with high contrast, such as brightly lit outdoor scenery from a dark room or shaded subjects at a sunny seaside.

Option	Description
 High Normal Low	Set the level of the Active D-Lighting effect that is applied during shooting.
OFF Off (default setting)	Active D-Lighting is not applied.

The icon for the current setting other than **Off** is displayed on the monitor (📖6).

✓ Notes on Active D-Lighting

- Additional time is required to record images when shooting using Active D-Lighting.
- The exposure is reduced in comparison to shooting with Active D-Lighting set to **Off**. To ensure that the gradation is appropriate, adjustments of the highlighted areas, shadow areas and mid-tones are made before recording.
- This feature may not be used in combination with certain features. See “Features That Cannot Be Used Simultaneously” (📖75) for more information.

✓ Active D-Lighting Versus D-Lighting



The **Active D-Lighting** option in the shooting menu reduces exposure before shooting to optimize the dynamic range. The **D-Lighting** (📖18) option in the playback menu optimizes dynamic range in pictures taken.

Save User Settings/Reset User Settings

See “Saving Settings in **U** Mode” (📖58) for more information about Save User Settings/Reset User Settings.

Zoom Memory

Rotate the mode dial to P, S, A or M → MENU button → P, S, A or M tab (📖11)
→ Zoom memory

Option	Description
On	<p>When the zoom control is operated, the camera changes in steps to the focal length (equivalent to 35mm [135] format of angle of view) of the zoom lens that is set in advance. The following settings are available: 24 mm, 28 mm, 35 mm, 50 mm, 70 mm, 85 mm and 100 mm.</p> <ul style="list-style-type: none"> Choose the focal length with the multi selector, and then press the  button to set the check box to On [✓] or Off. Multiple focal lengths can be chosen. The default setting is On [✓] for all the check boxes. To finish the setting, press the multi selector . The zoom position set in the Startup zoom position is automatically set to On [✓].
Off (default setting)	Even if zoom control is operated, the zoom position is not changed with each focal length.

Notes on Zoom Operation

- The changed focal length is the closest to that before the operation. To change the zoom position to the next focal length level, release the zoom control and then operate it again.
- Set **Zoom memory** to **Off** when using the digital zoom.

Startup Zoom Position

Rotate the mode dial to P, S, A or M → MENU button → P, S, A or M tab (📖11)
→ Startup zoom position



When the camera is turned on, the zoom position moves to the focal length (equivalent to 35mm [135] format of angle of view) of the zoom lens that is set in advance.

The following settings are available: **24 mm** (default setting), **28 mm, 35 mm, 50 mm, 70 mm, 85 mm and 100 mm.**

The Playback Menu

For more information about image editing functions; (**Quick retouch**, **D-Lighting**, **Skin softening**, **Filter effects**, **Small picture** and **Black border**), see “Editing Still Images” (📷16).

🖨️ Print Order (Creating a DPOF Print Order)

Press the  button (Playback mode) → MENU button (11) → 🖨️ Print order





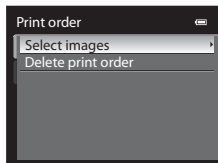

If you choose to use one of the following methods to print pictures that are stored on a memory card, the pictures to print and the number of copies can be set in advance on the memory card.

- Printing with a DPOF-compatible (📷17) printer that is equipped with a card slot.
- Ordering the prints to a digital photo lab that has a DPOF service.
- Printing by connecting the camera to a PictBridge-compatible (📷17) printer (📷26). (When the memory card is removed from the camera, the print order can also be performed for the pictures stored on the internal memory.)

1 Use the multi selector to choose **Select images**, and press the button.



2 Choose the pictures (up to a maximum of 99) and number of copies (up to nine per picture).

- Rotate the multi selector or press  or  to choose the pictures, and press  or  to set the number of copies for each.
- Pictures selected for printing can be recognized by the check mark icon and the numeral indicating the number of copies to be printed. If no copies have been specified for images, the selection is canceled.
- Rotate the zoom control toward **T** () to switch to full frame playback mode, or **W** () to switch to 12 thumbnail display.
- Press the  button when setting is complete.



3 Choose whether or not to also print shooting date and shooting information.

- Choose **Date** and press the **OK** button to print the shooting date on all pictures in the print order.
- Choose **Info** and press the **OK** button to print shooting information (shutter speed and aperture value) on all pictures in the print order.
- Choose **Done** and press the **OK** button to complete the print order.

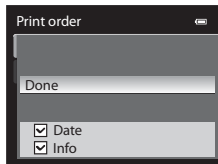

Pictures with the print orders are recognized by the  icon displayed in playback mode.



✓ Notes on Printing Shooting Date and Shooting Information

When the **Date** and **Info** options are enabled in the print order menu, shooting date and shooting information can be printed on pictures when a DPOF-compatible (17) printer which supports printing of shooting date and shooting information is used.

- Shooting information cannot be printed when the camera is connected directly to a printer, via the included USB cable, for DPOF printing (.
- **Date** and **Info** are reset each time the **Print order** menu is displayed.
- The date and time printed on the picture are the same as those set on the camera when the picture was taken. The date and time printed using this option are not affected if the camera's **Time zone and date** setting is changed from the setup menu after the pictures are taken.



✍ Deleting All Print Orders

In step 1 of the print order procedure (, 56), choose **Delete print order** and press the **OK** button to delete the print orders for all pictures.



✍ Print date

The shooting date and time can be imprinted on pictures at the time of shooting by using **Print date** (, 76) in the setup menu. This information can be printed even from printers that do not support printing of the date and time. Only the date and time of print date on the pictures are printed, even if **Print order** is enabled with the date selected in the print order screen.

✍ More Information



See "Printing Images of Size 1:1" (, 74) for more information.

Slide Show

Press the  button (Playback mode) → MENU button () →  Slide show



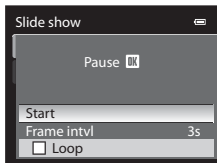

View pictures stored in the internal memory or on a memory card in an automatic slide show.

1 Use the multi selector to choose **Start**, and press the button.

- To change the interval between pictures, choose **Frame intvl**, and press the , and then select the desired interval time before choosing **Start**.
- To repeat the slide show automatically, enable **Loop** and press the  before choosing **Start**. The check mark () is added to the loop option when enabled.





2 The slide show begins.

- Press the multi selector  to display the next picture, or  to display the previous picture. Press and hold  to fast forward, or  to rewind.
- To exit partway or pause, press the  button.





3 Choose End or Restart.



- After the last frame is played back or during playback pause, the screen shown on the right is displayed. Choose  and press the  button to return to step 1. Choose  to play the slide show again.



Notes on Slide Shows

- Only the first frame of movies () included in slide shows is displayed.
- For sequences () whose sequence display options are set to **Key picture only**, only the key picture is displayed.
- Images captured using easy panorama are displayed full-frame when played in a slide show. They do not scroll.
- Slide shows play for a maximum of about 30 minutes, even when **Loop** is selected ()



Protect

Press the  button (Playback mode) → MENU button () →  Protect

Protect selected pictures from accidental deletion.

In the image selection screen, choose a picture and set or cancel protection. See “The Image Selection Screen” ( 60) for more information.

Note, however, that formatting the camera’s internal memory or the memory card ( 81) permanently erases the protected files.

Protected pictures are recognized by the  icon in playback mode ( 8).

The Image Selection Screen

The image selection screen is displayed in the following menus.

Only one image can be selected for some menu items, while for other menu items, multiple images can be selected.

Functions for which only one image can be selected	Functions for which multiple images can be selected
<ul style="list-style-type: none"> • Playback menu: Rotate image (👁️61), Choose key picture (👁️64) • Setup menu: Select an image in Welcome screen (👁️70) 	<ul style="list-style-type: none"> • Playback menu: Select images in Print order (👁️56), Protect (👁️59), Selected images in Copy (👁️63) • Erase selected images in Delete (📖32)

Follow the procedure described below to select images.

1 Rotate the multi selector, or press ◀ or ▶ to choose the desired image.

- Rotate the zoom control toward **T** (🔍) to switch to full-frame playback mode, or **W** (📐) to switch to 12 thumbnail display.
- For functions for which only one image is selected, proceed to step 3.



2 Press ▲ or ▼ to set **ON** or **OFF** (or the number of copies).

- When **ON** is selected, a check mark (☑️) is displayed with the image. Repeat steps 1 and 2 to select additional images.



3 Press the Ⓞ button to apply the image selection.



- With selections such as **Copy**, the confirmation dialog is displayed. Follow the instructions on the screen.

Rotate Image

Press the  button (Playback mode) → MENU button () →  Rotate image

Change the orientation of pictures played back in the camera's monitor after shooting. Still pictures can be rotated 90° clockwise or counterclockwise.

Pictures that were recorded in the "tall" orientation can be rotated up to 180° in either direction.

Select a picture in the picture selection screen () to display the rotate image screen. Rotate the multi selector, or press  or  to rotate the picture 90°.

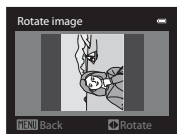

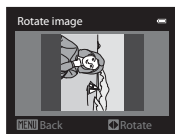
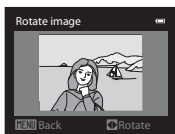

Rotated 90°
counterclockwise





Rotated 90°
clockwise

Press the  button to set the orientation displayed and save the orientation data with the picture.

Notes on Image Rotation

- Images captured with cameras other than COOLPIX P310 cannot be rotated.
- Images captured using 3D photography cannot be rotated.
- While only the key picture of a sequence is displayed, images cannot be rotated. Apply the setting after displaying individual images (, .



Voice Memo

Press the  button (Playback mode) → Select a picture → **MENU** button () →  Voice memo

Use the camera's microphone to record voice memos for pictures.

- The recording screen is displayed for a picture without voice memo, while the voice memo playback screen is displayed for a picture with voice memo (a picture marked with  in full-frame playback mode).

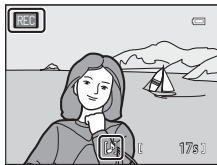

Recording Voice Memos

- Voice memo can be recorded for up to about 20 seconds while the  button is pressed.
- Do not touch the microphone during recording.
- During recording, **REC** and  flash on the monitor.
- When recording ends, the voice memo playback screen is displayed.





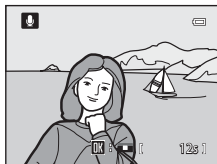

Playing Voice Memos

Pictures for which voice memos have been recorded are indicated by  in full-frame playback mode.

- Press the  button to play back a voice memo. To end playback, press the  button again.
- Rotate the zoom control toward **T** or **W** during playback to adjust playback volume.
- Press the multi selector  before or after playing a voice memo to return to the playback menu. Press the **MENU** button to exit the playback menu.



Deleting Voice Memos

Press the  button on the voice memo playback screen. Press the multi selector  or  to select **Yes** and press the  button to delete only the voice memo.

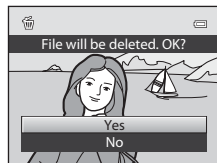



Notes on Voice Memos

- When a picture with a voice memo attached is deleted, both the picture and its voice memo are deleted.
- Voice memos cannot be recorded for a picture that already has a voice memo attached to it. The current voice memo must be deleted before a new voice memo can be recorded.
- Voice memos cannot be attached to pictures taken with cameras other than COOLPIX P310.
- Voice memos of the images with the **Protect** setting () cannot be deleted.
- Voice memos cannot be attached to pictures taken using easy panorama.

More Information

See "File and Folder Names" () for more information.

☰ Copy (Copy Between Internal Memory and Memory Card)

Press the  button (Playback mode) → MENU button (11) → ☰ Copy



Copy pictures between the internal memory and a memory card.

1 Use the multi selector to select an option from the copy screen, and press the  button.

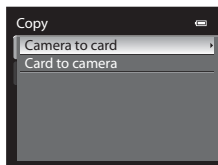
- **Camera to card:** Copy pictures from the internal memory to the memory card.
- **Card to camera:** Copy pictures from the memory card to the internal memory.







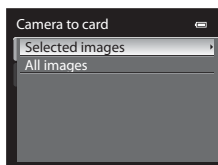

2 Select a copy option and press the  button.

- **Selected images:** Copy pictures selected from the image selection screen (60). If a sequence for which only a key picture is displayed is selected (14), all pictures in the displayed sequence are copied.
- **All images:** Copy all pictures. If a picture in a sequence is selected, this option is not displayed.
- **Current sequence:** This option is displayed when a picture in a sequence has been selected before displaying the playback menu. All pictures in the current sequence are copied.



☑ Notes on Copying Pictures

- JPEG-, MOV-, WAV-, and MPO-format files can be copied. Files recorded in any other format cannot be copied.
- **Voice memo** (62) attached to pictures and **Protect** setting (59) are also copied with the pictures.
- Pictures recorded with another make or model of camera or that have been modified on a computer cannot be copied.
- **Print order** settings(56) are not copied with the pictures.
- If **Sequence display options** (64) is set to **Key picture only** and a picture in the sequence is selected and the  button is pressed to display individual pictures (14), only **Card to camera** image copy is available.

 **Message: “Memory contains no images.”**

If there are no pictures stored on the memory card when playback mode is selected, the message, **Memory contains no images.**, is displayed. Press the **MENU** button and select **Copy** from the playback menu to copy the pictures stored in the camera’s internal memory to the memory card.

 **More Information**

See “File and Folder Names” (0694) for more information.

Sequence Display Options



Press the  button (Playback mode) → **MENU** button (011) →  Sequence display options

Choose the method used to display a series of pictures shot continuously (sequence, 014) when viewing them in full-frame playback mode (030) or in thumbnail playback mode (031).

Settings are applied to all sequences, and the setting is saved in the camera’s memory even if the camera is turned off.

Option	Description
Individual pictures	Each picture in a sequence is displayed.
Key picture only (default setting)	Return a sequence in which pictures are displayed individually to the key picture only display.

Choose Key Picture



Press the  button (Playback mode) → Select the desired sequence → **MENU** button (011) →  Choose key picture

When **Sequence display options** is set to **Key picture only**, the key picture displayed in full-frame playback mode (030) or thumbnail playback mode (031) can be set for each sequence of pictures.

- When changing this setting, before pressing **MENU**, first select the desired sequence using full-frame playback mode or thumbnail playback mode.
- When the key picture selection screen is displayed, select a picture. See “The Image Selection Screen” (060) for more information.

The Movie Menu

Movie Options





Display the shooting screen → MENU button →  (Movie) tab (11) → Movie options

You can choose the type of movie to shoot.

The camera can record normal speed movies and HS (high speed) movies (, 67), which can be played back in slow motion or fast motion.

The larger the image size and bit rate, the higher the image quality; however, the file size also becomes larger.

Normal Speed Movies



Option	Description
 HD 1080p★ (1920×1080) (default setting)	Movies with an aspect ratio of 16:9 are recorded. <ul style="list-style-type: none">• Movie bitrate: 18.8 Mbps• Frame rate: 30 frames per second
 HD 1080p (1920×1080)	Movies with an aspect ratio of 16:9 are recorded. <ul style="list-style-type: none">• Movie bitrate: 12.6 Mbps• Frame rate: 30 frames per second
 HD 720p (1280×720)	Movies with an aspect ratio of 16:9 are recorded. <ul style="list-style-type: none">• Movie bitrate: 8.4 Mbps• Frame rate: 30 frames per second
 iFrame 540 (960×540)	Movies with an aspect ratio of 16:9 are recorded. It is one of the formats supported by Apple Inc. <ul style="list-style-type: none">• Movie bitrate: 20.8 Mbps• Frame rate: 30 frames per second When using the camera's internal memory for recording, the movie recording may end unexpectedly depending on the composition of the image. Using a memory card (Class 6 or higher) is recommended when recording important movies.
 VGA (640×480)	Movies with an aspect ratio of 4:3 are recorded. <ul style="list-style-type: none">• Movie bitrate: 2.9 Mbps• Frame rate: 30 frames per second

More Information

See "Maximum Movie Length" (94) for more information.

HS Movies

See “Recording Movies in Slow Motion and Fast Motion (HS Movie)” (067) for more information.



Option	Description
 HS 120 fps (640×480)	1/4-speed slow motion movies with an aspect ratio of 4:3 are recorded. <ul style="list-style-type: none"> • Max. movie length: 7 min 15 s (playback time: 29 min) • Movie bitrate: 2.8 Mbps • Frame rate: 120 frames per second
 HS 60 fps (1280×720)	1/2-speed slow motion movies with an aspect ratio of 16:9 are recorded. <ul style="list-style-type: none"> • Max. movie length: 14 min 30 s* (playback time: 29 min) • Movie bitrate: 8.3 Mbps • Frame rate: 60 frames per second
 HS 15 fps (1920×1080)	2x speed fast motion movies with an aspect ratio of 16:9 are recorded. <ul style="list-style-type: none"> • Max. movie length: 29 min (playback time: 14 min 30 s) • Movie bitrate: 18.6 Mbps • Frame rate: 15 frames per second

* The maximum movie length for a single movie is 30 seconds when it is saved in the internal memory.

- The movie bitrate is the volume of movie data recorded per second. As a variable bitrate (VBR) system has been adopted, the movie bitrate varies automatically according to the subject so that more data is recorded per second for movies containing frequently moving subjects, thus increasing movie file size.

Note on HS Movie Recording and Special Effects Setting

 **HS 120 fps (640×480)** for **Movie options** cannot be selected when **Soft**, **Nostalgic sepia**, or **Painting** is selected for **Special effects** shooting mode.

Even if you select  **HS 120 fps (640×480)** for other recording mode while **Soft**, **Nostalgic sepia**, or **Painting** is selected for **Special effects** shooting mode,  **HS 60 fps (1280×720)** is automatically selected for **Movie options** when the mode dial is rotated to **SCENE**.

Recording Movies in Slow Motion and Fast Motion (HS Movie)

Display the shooting screen → MENU button →  (Movie) tab (L11) → Movie options



HS (high speed) movies can be recorded. Movies recorded using HS movie can be played back in slow motion at 1/4 or 1/2 of normal playback speed, or played back in fast motion at a speed two times faster than normal speed.

1 Use the multi selector to select HS movie ()66), and press the button.

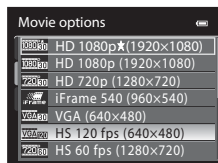
- Press the **MENU** button after changing the settings and return to the shooting screen.



2 Press the (movie-record) button to start recording.

- The monitor is turned off for a moment, and then the HS movie recording starts.
- The camera focuses at the center of the frame. Focus areas are not displayed during recording.
- When recording movies with  **HS 60 fps (1280x720)** or  **HS 15 fps (1920x1080)**, monitor display changes to an aspect ratio of 16:9.
- The maximum movie length display indicates the maximum HS movie length.

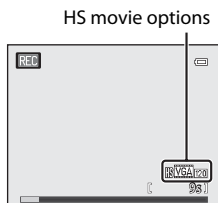

3 Press the (movie-record) button to end recording.

✓ Notes on HS Movie

- The sound is not recorded.
- Zoom position, focus, exposure and white balance are locked when the ● (🎬 movie-record) button is pressed to start recording.

📎 HS Movie

Recorded movies are played back at about 30 frames per second.

When **Movie options** (🔍 65) in the movie menu is set to **VGA120 HS 120 fps (640×480)** or **720p60 HS 60 fps (1280×720)**, movies that can be played back in slow motion can be recorded.

When set to **1080p15 HS 15 fps (1920×1080)**, movies that can be played back in fast motion at a speed two times faster than normal speed can be recorded.

Portions recorded at VGA120 HS 120 fps (640×480):

Movies are recorded for up to 7 minutes and 15 seconds at high speed, and are played back in slow motion at a speed four times slower than normal speed.

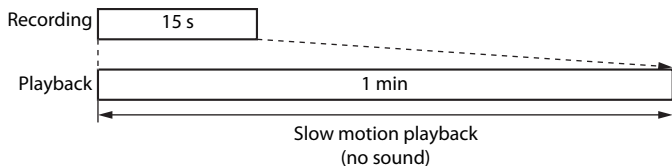

Portions recorded at 1080p15 HS 15 fps (1920×1080):

A movie of up to 29 minutes in length is recorded when shooting for the purpose of fast motion playback. Movies are played back two times faster than normal speed.

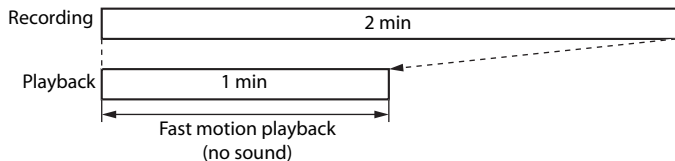

Autofocus Mode

Display the shooting screen → MENU button →  (Movie) tab (11)
→ Autofocus mode

Choose how the camera focuses when recording normal speed movies (65).

Option	Description
AF-S Single AF (default setting)	Lock on the focus when the ● () button is pressed to start recording. Select this option when the distance between the camera and the subject remains fairly consistent.
AF-F Full-time AF	The camera focuses continuously during movie recording. Suitable for shooting when the distance between the camera and subject changes. The operation sound of when the camera focuses may be recorded. Setting to Single AF is recommended if the sound is noticeable.

The Setup Menu

Welcome Screen

Press the MENU button → Y tab (11) → Welcome screen

Choose whether or not to display the welcome screen on the monitor when the camera is turned on.

Option	Description
None (default setting)	Display the shooting or playback screen without displaying the welcome screen.
COOLPIX	Display the welcome screen before displaying the shooting or playback screen.
Select an image	<p>Select a picture taken to display as the welcome screen. Display the image selection screen, choose an image (60), and press the OK button to register it.</p> <ul style="list-style-type: none">• Because the selected image is stored in the camera, the image appears in the welcome screen even if the original image is deleted.• The following pictures cannot be registered.<ul style="list-style-type: none">- Pictures taken with Image size (73) of 16:9 4608×2592, 2M 1920×1080, 32 4608×3072 or 1:1 3456×3456- Pictures reduced to 320 × 240 or smaller using small picture editing (21) or crop (23)- Pictures taken with easy panorama- Pictures taken using 3D photography

Time Zone and Date

Press the MENU button → Y tab (📖11) → Time zone and date

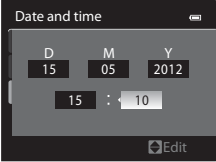
Option	Description
Date and time	<p>Set the camera clock to the current date and time. Use the multi selector to set the date and time.</p> <ul style="list-style-type: none"> Choose an item: Press ► or ◀ (selected in the following order: D (day) → M (month) → Y (year) → hour → minute). <p>The item can also be chosen by rotating the multi selector.</p> <ul style="list-style-type: none"> Set the contents: Press ▲ or ▼. Date and time can also be set by rotating the command dial. Finish setting: Choose minute and press the Ⓞ button or ►. 
Date format	<p>Choose the order in which the day, month, and year are displayed (Year/Month/Day, Month/Day/Year or Day/Month/Year).</p>
Time zone	<p>🏠 Home time zone can be specified and daylight saving can be enabled or disabled.</p> <p>When ➡ travel destination is registered, the time difference (🕒73) from the 🏠 home time zone is automatically calculated and the local date and time are recorded. Useful when traveling.</p>

Setting the Travel Destination Time Zone

1 Use the multi selector to choose **Time zone**, and press the **OK** button.

- The **Time zone** screen is displayed.

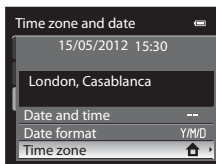

2 Choose **Travel destination** and press the **OK** button.

- The date and time displayed on the monitor change according to the region currently selected.

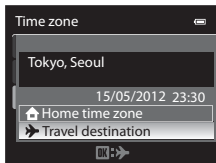

3 Press **▶**.

- The time zone selection screen is displayed.

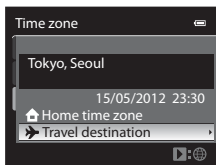

4 Press **◀** or **▶** to choose the travel destination (Time zone).

- The time difference between home and the travel destination is displayed.
- When using the camera in an area where daylight saving time is in effect, turn on the daylight saving setting with **▲**. When set to on, the **⌚** icon is displayed on the top of the monitor and the clock advances by one hour. To turn off, press **▼**.
- Press the **OK** button to register the travel destination time zone.
- While the travel destination time zone is selected, the **▶** icon is displayed on the monitor when the camera is in shooting mode.

Time difference

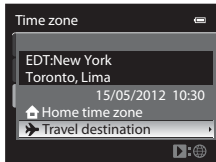
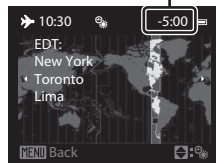

Home Time Zone

- To switch to the home time zone, choose **Home time zone** in step 2 and press the **OK** button.
- To change the home time zone, choose **Home time zone** in step 2 and perform the same procedure as for **Travel destination** to set the home time zone.

 **Time Zones**

The camera supports the time zones listed below.

For time differences not listed below, set the camera clock using **Time zone and date**.

UTC +/-	Location	UTC +/-	Location
-11	Midway, Samoa	+1	Madrid, Paris, Berlin
-10	Hawaii, Tahiti	+2	Athens, Helsinki, Ankara
-9	Alaska, Anchorage	+3	Moscow, Nairobi, Riyadh, Kuwait, Manama
-8	PST (PDT): Los Angeles, Seattle, Vancouver	+4	Abu Dhabi, Dubai
-7	MST (MDT): Denver, Phoenix	+5	Islamabad, Karachi
-6	CST (CDT): Chicago, Houston, Mexico City	+5.5	New Delhi
-5	EST (EDT): New York, Toronto, Lima	+6	Colombo, Dhaka
-4.5	Caracas	+7	Bangkok, Jakarta
-4	Manaus	+8	Beijing, Hong Kong, Singapore
-3	Buenos Aires, Sao Paulo	+9	Tokyo, Seoul
-2	Fernando de Noronha	+10	Sydney, Guam
-1	Azores	+11	New Caledonia
±0	London, Casablanca	+12	Auckland, Fiji

Monitor Settings

Press the **MENU** button → **Y** tab (📖11) → **Monitor settings**

Option	Description
Photo info	Select information displayed on the monitor during shooting and playback modes.
Image review	On (default setting): Picture is displayed on the monitor immediately after shooting and the monitor display returns to shooting screen. Off : Picture is not displayed immediately after shooting.
Brightness	Choose from five settings to select the monitor brightness. The default setting is 3 .
View/hide histograms	On : Histograms are displayed in the shooting mode even when the exposure compensation is not being set (📖6, 68). Off (default setting): Histograms are not displayed.

✔ Note on View/hide Histograms

Histograms are not displayed in the following situations.



- When recording a movie
- When the enlarged center of the picture is displayed in **MF** (manual focus)
- When the flash mode, self-timer or focus mode menu is displayed
- When borders for face detection (📖80) are displayed
- When the subject tracking is being activated in **AF area mode**

Photo info

Select whether or not the photo information is displayed on the monitor.

See “The Monitor” (📖6) for more information on indicators displayed on the monitor.

	Shooting mode	Playback mode
Show info		
Auto info (default setting)	The same information as in Show info is displayed. If no operations are performed after a few seconds, the display will be the same as Hide info . The information is displayed again when an operation is performed.	

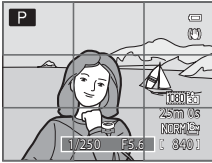
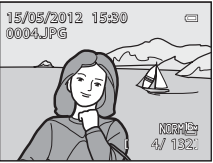
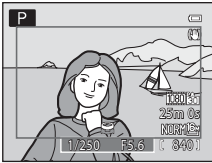
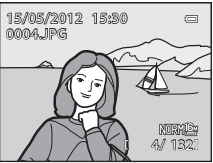
	Shooting mode	Playback mode
Hide info		
Framing grid+auto info	 <p>In addition to information shown with Auto info above, a framing grid is displayed to help frame pictures. It is not displayed while recording movies.</p>	 <p>The same information as in Auto info is displayed.</p>
Movie frame+auto info	 <p>In addition to information shown with Auto info above, the movie frame is displayed before recording movies.</p>	 <p>The same information as in Auto info is displayed.</p>

Print Date (Imprinting Date and Time on Pictures)

Press the **MENU** button → **Y** tab (📖11) → **Print date**

The shooting date and time can be imprinted on pictures at the time of shooting. This information can be printed even from printers that do not support printing of the date and time (🔍57).



Option	Description
DATE Date	The date is imprinted on pictures.
DATE Date and time	The date and time are imprinted on pictures.
OFF Off (default setting)	The date and time are not imprinted on pictures.

The icon for the current setting other than **Off** is displayed on the monitor (📖6).

✓ Notes on Print Date

- Imprinted dates cannot be deleted from the image, nor can dates be imprinted after the picture has been taken.
- Dates cannot be imprinted in the following situations.
 - When the scene mode is set to **Easy panorama**, **Panorama assist** or **3D photography**
 - When **Pre-shooting cache**, **Continuous H: 120 fps** or **Continuous H: 60 fps** is selected for **Continuous** (🔍42) in the shooting menu
 - During movie recording
- Dates imprinted with an **Image size** (📖73) setting of **VGA 640×480** may be difficult to read. Set the image size to **1600×1200** or higher.
- The date is recorded using the format selected in the setup menu's **Time zone and date** option (📖22, 🔍71).

📄 Print date and Print order

When printing from DPOF-compatible printers which support printing of shooting date and shooting information, the date and information can be printed on pictures without the date and time being imprinted on them with **Print date**, using options in the **Print order** menu (🔍56).

Vibration Reduction

Press the MENU button → Y tab (📖11) → Vibration reduction

Option	Description
 On (default setting)	<p>Compensate camera shake that commonly occurs when shooting at the telephoto zoom position or slow shutter speed. Camera shake is also compensated when recording movies as well as when shooting still images. The camera automatically detects the panning direction and only compensates for vibration caused by camera shake.</p> <p>When the camera is panned horizontally, for example, vibration reduction only compensates vertical shake. If the camera is panned vertically, vibration reduction only compensates for horizontal shake.</p>
OFF Off	Vibration Reduction is not enabled.

- When using a tripod to stabilize the camera, set vibration reduction to **Off**. When **On** is selected, an icon for this setting is displayed on the monitor (📖6).



Notes on Vibration Reduction

- After the power is turned on or the camera enters shooting mode from playback mode, wait until the display stabilizes before shooting.
- Due to the characteristics of the vibration reduction function, images displayed on the monitor immediately after shooting may appear blurry.
- Vibration reduction may be unable to completely eliminate the effects of camera shake in some situations.
- When the **Night landscape** or **Night portrait** scene mode is set to **Tripod**, vibration reduction is turned **Off**.

Motion Detection

Press the **MENU** button → **Y** tab (📖11) → Motion detection

Enable motion detection to reduce the effects of camera shake and subject movement when shooting still pictures.

Option	Description
 Auto (default setting)	<p>If the camera detects the movement of the subject or camera shake, the ISO sensitivity is raised and the shutter speed is increased to reduce their effects. However, motion detection does not function in the following situations.</p> <ul style="list-style-type: none"> • When the flash fires • In the following scene modes:  (Night landscape), Landscape, Sports, Night portrait, Noise reduction burst in Close-up, Fireworks show, Backlighting, Easy panorama in Panorama, Pet portrait, High ISO monochrome in Special effects • When shooting mode is P, S, A, M or U
OFF Off	Motion detection is not enabled.

When **Auto** is selected, an icon for this setting is displayed on the monitor (📖6). The motion detection icon lights in green when the camera detects any vibration and increases the shutter speed.

✔ Notes on Motion Detection

- Motion detection may be unable to completely reduce effects of camera shake and subject movement in some situations.
- Motion detection may not function if the subject exhibits significant movement or is too dark.
- The pictures taken may become grainy.

AF Assist

Press the MENU button → Y tab (📖11) → AF assist

Enable or disable the AF-assist illuminator that assists the autofocus when the lighting is dim.

Option	Description
Auto (default setting)	<p>AF-assist illuminator lights automatically if the lighting is dim. The illuminator has a range of about 5.3 m (17 ft) at the maximum wide-angle position and about 1.9 m (6 ft 2 in.) at the maximum telephoto position.</p> <ul style="list-style-type: none"> Even if Auto is selected, the AF-assist illuminator does not light depending on the position of the focus area or the scene mode such as Museum (📖44) and Pet portrait (📖47).
Off	AF-assist illuminator does not light. The camera may be unable to focus if lighting is dim.

Digital Zoom

Press the MENU button → Y tab (📖11) → Digital zoom

Enable or disable the digital zoom.

Option	Description
On (default setting)	When the camera is zoomed in to the maximum optical zoom position, rotating and holding the zoom control toward T (📖) triggers the digital zoom (📖27).
Off	The digital zoom is not activated.

✓ Notes on Digital Zoom

- When digital zoom is in effect, the camera focuses at the center of the frame.
- The digital zoom cannot be used when **Scene auto selector**, **Portrait**, **Night portrait**, **Easy panorama** in **Panorama**, **Pet portrait** or **3D photography** is selected in scene mode.
- This feature may not be used in combination with certain features. See “Features That Cannot Be Used Simultaneously” (📖75) for more information.
- When the digital zoom is in effect, **Metering** is set to **Center-weighted** or **Spot**.

Sound Settings

Press the **MENU** button → **Y** tab (📖11) → Sound settings

Adjust the following sound settings.

Option	Description
Button sound	Set the following all sound settings to On (default setting) or Off . <ul style="list-style-type: none"> • Setting beep (beep sounds once when the settings are completed) • Focus beep (beep sounds twice when the camera focuses on the subject) • Error beep (beep sounds three times when an error is detected) • Start-up sounds
Shutter sound	Choose whether to set the shutter sound to On (default setting) or Off .

Notes on Sound Settings

- In **Pet portrait** scene mode, even when **On** is set, the button sound and shutter sound are disabled.
- Even when **On** is set, the shutter sound is disabled during movie recording.
- This feature may not be used in combination with certain features. See "Features That Cannot Be Used Simultaneously" (📖75) for more information.

Auto Off

Press the **MENU** button → **Y** tab (📖11) → Auto off

If no operations are performed for a certain period while the camera is on, the monitor is turned off to save power and the camera enters standby mode (📖21). In this menu, set the time before the camera enters standby mode.

Choose from **30 s**, **1 min** (default setting), **5 min** and **30 min**.

Auto Off Setting

- In the following situations, the time taken for the camera to enter standby mode is fixed.
 - When menus are displayed: three minutes (when auto off is set to **30 s** or **1 min**)
 - During slideshow playback: maximum of 30 minutes
 - When the AC Adapter EH-62F is connected: 30 minutes
- The camera does not enter standby mode when transferring images using the Eye-Fi card.

Format Memory/Format Card

Press the MENU button → Y tab (📖11) → Format memory/Format card

Format the internal memory or a memory card.

Formatting permanently deletes all data in the internal memory or memory card. The deleted data cannot be recovered. Be sure to transfer important pictures to a computer before formatting.

Formatting the Internal Memory

To format the internal memory, remove the memory card from the camera. The

Format memory option is displayed on the setup menu.

Formatting Memory Cards

When a memory card is inserted in the camera, the memory card can be formatted.

The **Format card** option is displayed on the setup menu.

Formatting Internal Memory and Memory card

- Do not turn off the camera or open the battery-chamber/memory card slot cover during formatting.
- The first time you insert a memory card that has been used in another device into this camera, be sure to format it with this camera.

Language

Press the MENU button → Y tab (📖11) → Language

Choose one of 29 languages for displaying the camera menus and messages.

Čeština	Czech	Nederlands	Dutch	Türkçe	Turkish
Dansk	Danish	Norsk	Norwegian	Українська	Ukrainian
Deutsch	German	Polski	Polish	عربي	Arabic
English	(default setting)	Português (BR)	Brazilian Portuguese	简体中文	Simplified Chinese
Español	Spanish	Português (PT)	Portuguese	繁體中文	Traditional Chinese
Ελληνικά	Greek	Русский	Russian	日本語	Japanese
Français	French	Română	Romanian	한글	Korean
Indonesia	Indonesian	Suomi	Finnish	ภาษาไทย	Thai
Italiano	Italian	Svenska	Swedish	हिन्दी	Hindi
Magyar	Hungarian	Tiếng Việt	Vietnamese		

TV Settings

Press the **MENU** button → **Y** tab (📖11) → TV settings

Adjust the settings for connecting to a TV.

Option	Description
Video mode	Select the analog video output system from NTSC or PAL in accordance with your TV.
HDMI	Select a picture resolution for HDMI output from Auto (default setting), 480p , 720p , or 1080i . When Auto is set, the output resolution that is best suited to the connected TV is selected automatically from 480p , 720p or 1080i .
HDMI device control	Select whether or not the camera receives signals from a TV when a TV that conforms to the HDMI-CEC standard is connected with an HDMI cable. When set to On (default setting), the television remote control can be used to operate the camera during playback. See "Using the TV's Remote Control (HDMI Device Control)" (📖25) for more information.
HDMI 3D output	Set the method used to output 3D pictures to HDMI devices. Select On (default setting) to three-dimensionally play back 3D pictures taken with this camera on a TV or monitor that is connected via HDMI.

HDMI and HDMI-CEC

"HDMI" is an abbreviation of High-Definition Multimedia Interface, which is one type of multimedia interface.

"HDMI-CEC" is an abbreviation of HDMI-Consumer Electronics Control, which enables operations to be linked between compatible devices.

Fn Button

Press the MENU button → Y tab (📖11) → Fn button

Assign the frequently used shooting menu to the **Fn** (FUNC) button (📖2).

- This can be used when **P**, **S**, **A**, **M** or **U** is chosen for shooting mode.

Option	Description
Image size (📖73)	Display the setting for image size.
Picture Control (🔧34)	Display the setting for Picture Control.
White balance (🔧39)	Display the setting for white balance.
Metering (🔧41)	Display the setting for metering.
Continuous (default setting) (🔧42)	Display the settings for continuous shooting.
ISO sensitivity (🔧46)	Display the setting for ISO sensitivity.
AF area mode (🔧48)	Display the setting for AF area mode.

Charge by Computer

Press the MENU button → Y tab (📖11) → Charge by computer

Select whether or not the battery inserted into the camera is charged when the camera is connected to a computer via the USB cable (📖86).

Option	Description
Auto (default setting)	When the camera is connected to a computer that is running, the battery inserted into the camera is automatically charged using power supplied by the computer.
Off	The battery inserted into the camera is not charged when the camera is connected to a computer.

✔ Notes on Connecting the Camera to a Printer

- The battery cannot be charged with connection to a printer, even if the printer complies with the PictBridge standard.
- When **Auto** is selected for **Charge by computer**, it may be impossible to print images with direct connection of the camera to some printers. If the PictBridge startup screen is not displayed on the monitor after the camera is connected to a printer and turned on, turn the camera off and disconnect the USB cable. Set **Charge by computer** to **Off** and reconnect the camera to the printer.

✔ Notes on Charging with Connection to a Computer

- The battery cannot be charged, nor can data be transferred, when the camera is connected to a computer before the camera's display language and date and time have been set (📖22). If the camera's clock battery (📖23) has been exhausted, the date and time must be reset before the battery can be charged or images can be transferred with connection to a computer. In this case, use the Charging AC Adapter EH-69P (📖16) to charge the battery and then set the camera's date and time.
- If the camera is turned off, charging will also stop.
- If the computer enters sleep mode while charging, charging will stop and the camera may be turned off.
- When disconnecting the camera from the computer, turn the camera off and then disconnect the USB cable.
- It may take longer to charge the battery with connection to a computer than with charging using the Charging AC Adapter EH-69P. Charging time increases when images are transferred while the battery is charging.
- When the camera is connected to a computer, an application installed on the computer, such as Nikon Transfer 2, may start. If the camera was connected to the computer for the sole purpose of charging the battery, exit the application.
- The camera turns off automatically if there is no communication with the computer for 30 minutes after the battery has finished charging.
- Depending upon computer specifications, settings, and power supply and allocation, it may be impossible to charge the battery using a computer connection while it is inserted into the camera.

The Charge Lamp

The following chart explains charge lamp status when the camera is connected to a computer.

Option	Description
Flashes slowly (green)	Battery charging.
Off	Battery not charging. If the charge lamp changes from slow flashing (green) to off while the power-on lamp is lit, charging is complete.
Flashes quickly (green)	<ul style="list-style-type: none"> • The ambient temperature is not suited to charging. Charge the battery indoors with an ambient temperature of 5°C to 35°C (41°F to 95°F). • The USB cable is not connected correctly, or the battery is faulty. Make sure the USB cable is connected correctly and replace the battery if necessary. • The computer is in sleep mode and is not supplying power. Wake up the computer. • The battery cannot be charged because the computer cannot supply power to the camera, due to the computer's settings or its specifications.

Toggle Av/Tv Selection

Press the MENU button → Y tab (11) → Toggle Av/Tv selection

Switch the method for setting the flexible program, shutter speed or aperture value.

- This feature can be used when shooting mode is set to **P, S, A, M** or **U**.

Option	Description
Do not toggle selection (default setting)	Use the command dial to set the flexible program or shutter speed, and the multi selector to set the aperture value.
Toggle selection	Use the multi selector to set the flexible program or shutter speed, and the command dial to set the aperture value.

Reset File Numbering

Press the MENU button → Y tab (11) → Reset file numbering

When **Yes** is selected, the sequential numbering of file numbers is reset (94). After resetting, a new folder is created and the file number for the next picture taken starts from "0001."

Note on Reset File Numbering

Reset file numbering cannot be applied when the folder number reaches 999 and there are images in the folder. Insert a new memory card, or format the internal memory/memory card (81).

Blink Warning

Press the **MENU** button → **Y** tab (📖11) → Blink warning

Choose whether or not blinking eyes are detected when using face detection (📖80) in the following shooting modes.

- In the following scene modes: **Scene auto selector** (📖39), **Portrait** (📖39) or **Night portrait** (when **Tripod** is selected) (📖41)
- Shooting modes **P**, **S**, **A**, **M**, **U** (when **Face priority** (📖48) is selected for **AF area mode**)

Option	Description
On	The Did someone blink? screen is displayed on the monitor if the camera detects that a human subject may have closed the eyes immediately after taking a picture using face detection. The face of the human subject that may have closed his/her eyes is framed by a yellow border. You can check the picture taken and determine if you need to take the picture again.
Off (default setting)	The camera does not detect blinks.

The Did someone blink? Screen

- To zoom in the face for which blinking was detected, rotate the zoom control toward **T** (📖). To return to full-frame playback mode, rotate the zoom control toward **W** (📖).
- When the camera detects that one or more human subjects have closed their eyes, press ◀ or ▶ during playback zoom to display other faces.
- Press the 🗑️ button to delete the picture taken.
- Press the Ⓞ button or the shutter-release button to return to shooting screen.
- If no operations are performed for a few seconds, the screen automatically returns to the shooting screen.



✔ Note on Blink Warning

This feature may not be used in combination with certain features. See “Features That Cannot Be Used Simultaneously” (📖75) for more information.

Filmstrip

Press the **MENU** button → **Y** tab (11) → **Filmstrip**

Allows you to select whether or not filmstrips are displayed when you rotate the multi selector quickly in full-frame playback mode (30).

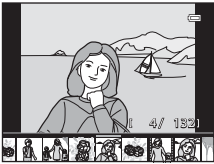
Option	Description
On	<p>Image thumbnail is displayed at the bottom of the monitor when you rotate the multi selector quickly while viewing an image in full-frame playback mode. You can view thumbnails of previous and subsequent images, and select an image. While the filmstrip is displayed, you can hide it by pressing the OK button.</p> 
Off (default setting)	Disables the filmstrip.

Note on Filmstrip Display

In order to display the filmstrip, at least ten images must be saved in the camera's internal memory or on the memory card.

Eye-Fi Upload

Press the MENU button → Y tab (11) → Eye-Fi upload





Option	Description
Enable	Upload images created by the camera to a preselected destination.
Disable (default setting)	Images will not be uploaded.

✓ Notes on Eye-Fi Cards

- Note that images will not be uploaded if signal strength is insufficient even if **Enable** is selected.
- Select **Disable** where wireless devices are prohibited.
- Refer to the instruction manual of your Eye-Fi card for more information. In the event of malfunction, contact the card manufacturer.
- The camera can be used to turn Eye-Fi cards on and off, but may not support other Eye-Fi functions.
- The camera is not compatible with the endless memory function. When it is set on a computer, disable the function. If the endless memory function is enabled, the number of pictures taken may not be displayed correctly.
- Eye-Fi cards are for use only in the country of purchase. Observe all local laws concerning wireless devices.
- Leaving the setting as **Enable** will result in the battery being depleted in a shorter period of time.

✎ Eye-Fi Communication Indicator

The communication status of the Eye-Fi card in the camera can be confirmed on the monitor (16).

- : **Eye-Fi upload** is set to **Disable**.
-  (lights): Eye-Fi upload enabled; waiting to begin upload.
-  (flashes): Eye-Fi upload enabled; uploading data.
- : An error occurred. The camera cannot control the Eye-Fi card.

✎ Supported Eye-Fi Cards

As of November 2011, the following Eye-Fi cards can be used. Be sure that Eye-Fi card firmware has been updated to the latest version.

- Eye-Fi Connect X2 SDHC 4GB
- Eye-Fi Mobile X2 SDHC 8GB
- Eye-Fi Pro X2 SDHC 8GB

Reverse Indicators

Press the MENU button → Y tab (📖11) → Reverse indicators

Change the +/- display direction of the exposure indicator displayed when shooting mode is **M**.

The + side of the indicators is set to the left and - side is set to the right in the default setting.

Reset All

Press the MENU button → Y tab (📖11) → Reset all

When **Reset** is selected, the camera settings are restored to the default values.

Pop-up Menu

Option	Default value
Flash mode (📖60)	Auto
Self-timer (📖63)/ Smile timer (📖64)	OFF
Focus mode (📖66)	Autofocus
Exposure compensation (📖68)	0.0

Shooting in the Scene Mode

Option	Default value
Scene menu (📖37)	Scene auto selector
Landscape (📖40)	Single shot
Night portrait (📖41)	Tripod
Close-up (📖43)	Single shot
Hue adjustment in Food mode (📖44)	Center
HDR in Backlighting (📖45)	Off
Panorama (📖46)	Normal (180°) in Easy panorama
Pet portrait (📖47)	Pet portrait auto release: ON Continuous: Continuous
Special effects (📖48)	Soft

Night Landscape Menu

Option	Default value
Night landscape (📖38)	Hand-held

Shooting Menu

Option	Default value
Image quality (📖72)	Normal
Image size (📖73)	📷 4608×3456
Picture Control (🔍34)	Standard
White balance (🔍39)	Auto (normal)
White balance fine adjustments (🔍39)	0
Metering (🔍41)	Matrix
Continuous (🔍42)	Single
Intvl timer shooting (🔍44)	30 s
ISO sensitivity (🔍46)	Auto
Minimum shutter speed (🔍46)	None
Exposure bracketing (🔍47)	Off
AF area mode (🔍48)	Auto
Autofocus mode (🔍52)	Single AF
Flash exp. comp. (🔍53)	0.0
Noise reduction filter (🔍53)	Normal
Active D-Lighting (🔍54)	Off
Zoom memory (🔍55)	Off
Startup zoom position (🔍55)	24 mm

Movie Menu

Option	Default value
Movie options (🔍65)	📹 1080p HD 1080p★ (1920×1080)
Autofocus mode (🔍69)	Single AF

Setup Menu

Option	Default value
Welcome screen (🔍70)	None
Photo info (🔍74)	Auto info
Image review (🔍74)	On
Brightness (🔍74)	3
Histogram (🔍74)	Off
Print date (🔍76)	Off
Vibration reduction (🔍77)	On

The Setup Menu

Option	Default value
Motion detection (🔍78)	Auto
AF assist (🔍79)	Auto
Digital zoom (🔍79)	On
Button sound (🔍80)	On
Shutter sound (🔍80)	On
Auto off (🔍80)	1 min
HDMI (🔍82)	Auto
HDMI device control (🔍82)	On
HDMI 3D output (🔍82)	On
Fn button (🔍83)	Continuous
Charge by computer (🔍84)	Auto
Toggle Av/Tv selection (🔍86)	Do not toggle selection
Blink warning (🔍87)	Off
Filmstrip (🔍88)	Off
Eye-Fi upload (🔍89)	Disable
Reverse indicators (🔍90)	+0-

Others

Option	Default value
Paper size (🔍28, 🔍29)	Default
Frame intvl for Slide show (🔍58)	3 s
Sequence display options (🔍64)	Key picture only

- Choosing **Reset all** also clears the current file number (🔑94) in the memory. After resetting, numbering continues from the lowest number available in the internal memory or the memory card. If **Reset all** is performed after all pictures are deleted from the internal memory or memory card (📖32), the file numbers for the next pictures taken start from "0001."
- The following settings remain unaffected even if **Reset all** is performed.
 - Shooting menu: **Custom Picture Control** registration (🔑38), preset manual data for **White balance** (🔑40)
 - Setup menu: **Time zone and date** (🔑71), **Language** (🔑81) and **Video mode** (🔑82) in **TV settings**
- User settings that were saved for mode dial **U** are not reset to the default settings when **Reset all** is performed. To change these settings back to the default settings, use **Reset user settings** (🔑54).

Firmware Version

Press the **MENU** button → **Y** tab (📖11) → Firmware version

Displays the current camera firmware version.

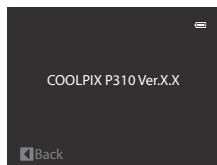

File and Folder Names

Pictures, movies and voice memos are assigned file names as follows.

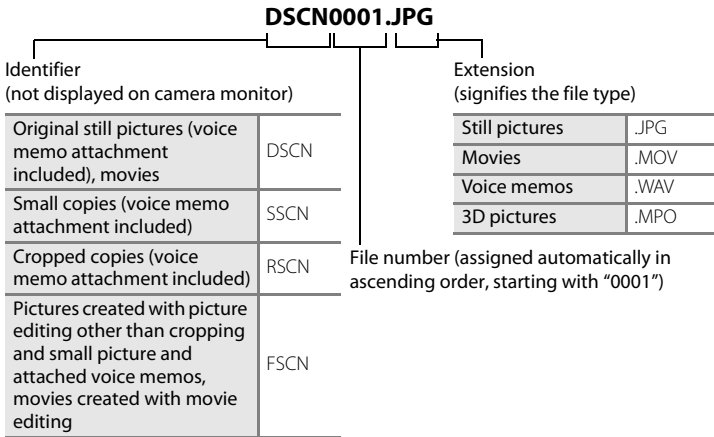

- A folder for storing files is automatically created using the following naming convention: "Folder number + NIKON" (e.g., "100NIKON"). If there are 200 files in a folder, a new folder is created. (For example, the folder name following "100NIKON" becomes "101NIKON.") A new folder is also created when the file numbers in a folder reach 9999 or **Reset file numbering** (📷86) is performed. The next file number is set automatically to "0001." If a folder contains no files, a new folder is not created even if **Reset file numbering** is performed.
- Voice memo file names have the same identifier and file number as the picture to which the voice memo is attached.
- In Panorama assist (📷6), a folder is created for each shooting session using the following naming convention: "Folder number + P_XXX" (e.g., "101P_001"). Pictures are saved in sequence in file numbers starting from 0001.
- Each time a picture is taken in Interval timer shooting (📷44), a folder named with the convention: 'Folder number + INTVL' (e.g., 101INTVL) is created. Pictures are saved in sequence in file numbers starting from 0001.

- When image files or voice files are copied to or from the internal memory or memory card (📷63), the file naming conventions are as follows:
 - Selected images:
Files copied using selected images are copied to the current folder (or to the folder used for subsequent pictures), where they are assigned file numbers in ascending order following the largest file number in memory.
 - All images:
Files copied using all images, along with their folder, are copied together. Folder numbers are assigned in ascending order, following the largest folder number on the destination medium.
File names are not changed.
- When the current folder is numbered 999, if there are 200 files in the folder or if a file is numbered 9999, no further pictures can be shot until the internal memory or memory card is formatted (📷81), or a new memory card is inserted.

Optional Accessories

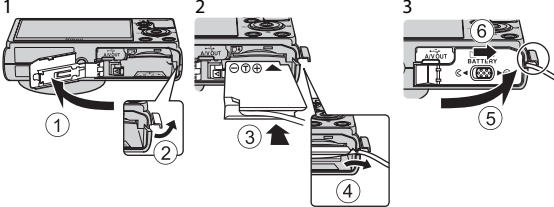
Rechargeable battery	Rechargeable Li-ion Battery EN-EL12 ¹
Charging AC adapter	Charging AC Adapter EH-69P ^{1, 2}
Battery charger	Battery Charger MH-65 (Charging time when the battery is completely used up: Approx. 2 hours 30 minutes)
AC adapter	<p>AC Adapter EH-62F (connect as shown)</p>  <p>Properly align the power connector cord in the power connector groove, and then insert the AC adapter. Before closing the battery-chamber/memory card slot cover, properly align the power connector cord in the battery chamber groove. If part of the cord runs out of the grooves, the cover or cord may be damaged when the cover is closed.</p>
USB cable	USB Cable UC-E6 ¹
Audio/video cable	Audio Video Cable EG-CP16 ¹





¹ Included with the camera at the time of purchase. (See “Confirming the Package Contents” (📖ii) for more information.)

² When using in other countries, use a commercially available plug adapter as necessary. For more information about plug adapters, consult your travel agency.







See our websites or product catalogs for up-to-date information on accessories for the COOLPIX P310.











Error Messages

The following table lists the error messages and other warnings displayed on the monitor, as well as the solutions for dealing with them.











Display	Cause/Solution	
 (flashes)	Clock not set. Set date and time.	 71
Battery exhausted.	Battery exhausted. Charge or replace the battery.	14, 16
Battery temperature high	Battery temperature is high. Turn off camera, and allow battery to cool down before resuming use. Five seconds after this message appears, the monitor is turned off, and the power-on lamp, the AF/access lamp and the flash lamp flash quickly. After the lamps flash for three minutes, the camera turns off automatically, but you can also press the power switch to turn it off manually.	21
The camera will turn off to prevent overheating.	Inside of the camera has become hot. The camera turns off automatically. Leave the camera off until the inside of the camera has cooled and then turn it on again.	–
 (flashes red)	Camera cannot focus. <ul style="list-style-type: none"> • Refocus. • Use focus lock. 	28 81
Please wait for the camera to finish recording.	Camera cannot perform other operations until recording is complete. Wait until message clears from display automatically when recording is complete.	–
Memory card is write protected.	Write-protect switch of the memory card is in "lock" position. Slide the write-protect switch to "write" position.	–
Not available if Eye-Fi card is locked.	Write-protect switch of Eye-Fi card is in "lock" position. Slide the write-protect switch to "write" position.	–
	Error accessing Eye-Fi card. <ul style="list-style-type: none"> • Use an approved card. • Check that the terminal is clean. • Confirm that memory card is correctly inserted. 	19 18 18
This card cannot be used.	Error accessing memory card. <ul style="list-style-type: none"> • Use an approved card. 	19
This card cannot be read.	<ul style="list-style-type: none"> • Check that the terminal is clean. • Confirm that memory card is correctly inserted. 	18
		18

Error Messages

Display	Cause/Solution	
Card is not formatted. Format card? Yes No	Memory card has not been formatted for use in this camera. All data stored on the memory card is deleted when formatted. If there is any data on the card that you want to keep, select No , and backup the data to a computer before formatting the memory card. To format the memory card, select Yes and press the  button.	18
Out of memory.	Memory card is full. <ul style="list-style-type: none"> • Choose lower image quality or smaller image size. • Delete pictures and movies. • Replace memory card. • Remove memory card and use internal memory. 	72, 73 32, 96 18 19
Image cannot be saved.	Error occurred while recording picture. Format the internal memory or memory card.	 81
	Camera has run out of file numbers. Replace the memory card, or format the internal memory/ memory card.	18,  81
	Picture cannot be used for welcome screen.	 70
	There is insufficient space to save a copy. Delete pictures from destination.	32
Unable to create panorama.	Cannot perform easy panorama shooting. Easy panorama shooting may not be available in the following situations. <ul style="list-style-type: none"> • When shooting has not finished after a certain period of time • When the camera movement speed is too fast • When the camera is not straight relative to the panorama direction 	 3
Unable to create panorama. Pan the camera in one direction only.		
Unable to create panorama. Pan the camera more slowly.		
Failed to take second shot	When taking 3D pictures, the second shot could not be successfully taken after the first shot. <ul style="list-style-type: none"> • Try shooting again. After taking the first shot, move the camera horizontally and frame the subject so that it is aligned with the guide. • In some shooting conditions, such as when the subject moves or the subject is dark or low in contrast, the second shot may not be taken. 	 8 —

Display	Cause/Solution	
Failed to save 3D image	Failed to save the 3D pictures. <ul style="list-style-type: none"> Try shooting again. Delete unnecessary pictures. In some shooting conditions, such as when the subject moves or the subject is dark or low in contrast, 3D pictures may not be created, resulting in failure to save them. 	 8 32 –
Sound file cannot be saved.	A voice memo cannot be attached to this file. <ul style="list-style-type: none"> Voice memos cannot be attached to movies. Select a picture taken with this camera. 	–  62
Image cannot be modified.	Cannot edit selected picture. <ul style="list-style-type: none"> Confirm the conditions that are required for editing. These options cannot be used with movies. 	 16 –
Cannot record movie.	Time out error while recording movie. Choose memory card with faster write speed.	19
Cannot reset file numbering.	No more folders can be created. Insert a new memory card, or format the internal memory/ memory card.	18,  81
Memory contains no images.	No pictures in the internal memory or memory card. <ul style="list-style-type: none"> To view the pictures stored in the internal memory, remove the memory card. To copy pictures from internal memory to a memory card, press the MENU button and select Copy from the playback menu. 	18  63
File contains no image data.	File not created with COOLPIX P310. File cannot be viewed on this camera.	–
This file cannot be played back.	View file using the computer or any other devices which was used to create or edit this file.	–
All images are hidden.	No images available for a slide show.	–
This image cannot be deleted.	Picture is protected. Disable protection.	 59
Travel destination is in the current time zone.	Destination in same time zone as home.	 73
Mode dial is not in the proper position.	Mode dial is between two modes. Rotate the mode dial to select the desired mode.	24
Raise the flash.	The flash is lowered when the scene mode is Night portrait or Backlighting with HDR set to Off . Slide the   (flash pop-up) control to raise the flash.	41, 45, 60

Error Messages

Display	Cause/Solution	
The flash is lowered.	The flash is not raised during the scene auto selector. Slide the  (flash pop-up) control to raise the flash. The camera can still shoot normally with the flash lowered if you do not wish to use it.	39, 60
Lens error	Lens is not operating properly. Turn camera off and then on again. If error persists, contact retailer or Nikon-authorized service representative.	21
Communications error	Error occurred during communication with printer. Turn off camera and reconnect the USB cable.	 27
System error	Error has occurred in camera's internal circuitry. Turn off camera, remove and reinsert battery, and turn on camera. If the error persists, contact retailer or Nikon-authorized service representative.	21
Printer error: check printer status.	Printer error Check printer. After solving the problem, select Resume and press the  button to resume printing.*	–
Printer error: check paper	Specified size of paper is not loaded. Load the specified size of paper, select Resume and press the  button to resume printing.*	–
Printer error: paper jam	Paper has jammed in the printer. Remove the jammed paper, select Resume and press the  button to resume printing.*	–
Printer error: out of paper	No paper is loaded in the printer. Load the specified size of paper, select Resume and press the  button to resume printing.*	–
Printer error: check ink	Ink error Check ink, select Resume and press the  button to resume printing.*	–
Printer error: out of ink	Ink cartridge is empty. Replace ink cartridge, select Resume and press the  button to resume printing.*	–
Printer error: file corrupt	An error caused by the image file has occurred. Select Cancel and press the  button to cancel printing.	–

* See the instruction manual provided with your printer for further guidance and information.



Technical Notes and Index

Caring for the Products	2
The Camera.....	2
The Battery.....	3
Charging AC Adapter	4
The Memory Cards.....	5
Caring for the Camera	6
Cleaning.....	6
Storage.....	6
Troubleshooting.....	7
Specifications.....	14
Supported Standards.....	17
Index.....	18

Caring for the Products

The Camera

To ensure continued enjoyment of this Nikon product, observe the following precautions when using or storing the device.

Be sure to read and follow the warnings of “For Your Safety” (📖vi to 📖viii) thoroughly before using the products.

✔ **Keep Dry**

The device will be damaged if immersed in water or subjected to high humidity.

✔ **Do Not Drop**

The product may malfunction if subjected to strong shock or vibration.

✔ **Handle the Lens and All Moving Parts with Care**

Do not apply force to the lens, lens cover, monitor, memory card slot, or battery chamber. These parts are easily damaged. Applying force to the lens cover could result in camera malfunction or damage to the lens. Should the monitor break, care should be taken to avoid injury caused by broken glass and to prevent the liquid crystal from the display touching the skin or entering the eyes or mouth.

✔ **Do Not Point the Lens at Strong Light Sources for Extended Periods**

Avoid pointing the lens at the sun or other strong light sources for extended periods when using or storing the camera. Intense light may cause deterioration of the image sensor, producing a white blur effect in photographs.

✔ **Keep away from Strong Magnetic Fields**

Do not use or store this device in the vicinity of equipment that generates strong electromagnetic radiation or magnetic fields. Strong static charge or the magnetic fields produced by equipment such as radio transmitters could interfere with the monitor, damage data saved on the memory card, or affect the product's internal circuitry.

✔ **Avoid Sudden Changes in Temperature**

Sudden changes in temperature, such as when entering or leaving a heated building on a cold day, can cause condensation to form inside the device. To prevent condensation, place the device in a carrying case or a plastic bag before exposing it to sudden changes in temperature.



✔ **Turn the Product off Before Removing or Disconnecting the Power Source or the Memory Card**

Do not remove the battery while the product is on, or while images are being saved or deleted. Forcibly cutting power in these circumstances could result in loss of data or in damage to product memory or internal circuitry.

Notes on the Monitor

- Monitors and electronic viewfinders are constructed with extremely high precision; at least 99.99% of pixels are effective, with no more than 0.01% being missing or defective. Hence while these displays may contain pixels that are always lit (white, red, blue, or green) or always off (black), this is not a malfunction and has no effect on images recorded with the device.
- Images on the monitor may be difficult to see under bright lighting.
- The monitor is lit by an LED backlight. Should the monitor begin to dim or flicker, contact your Nikon-authorized service representative.

The Battery

- Be sure to read and follow the warnings of “For Your Safety” (vi to viii) thoroughly before using the battery.
- Check the battery level before using the camera and replace or charge the battery if necessary. Do not continue charging once the battery is fully charged as this will result in reduced battery performance. Whenever possible, carry a fully charged spare battery when taking pictures on important occasions.
- Do not use the battery at ambient temperatures below 0°C (32°F) or above 40°C (104°F).
- Charge the battery indoors with an ambient temperature of 5°C to 35°C (41°F to 95°F) before use.
- When the battery temperature is between 45°C and 60°C (113°F and 140°F), the chargeable capacity may decrease.
- The battery is not charged at ambient temperatures below 0°C (32°F) or above 60°C (140°F).
- Note that the battery may become hot during use; wait for the battery to cool before charging. Failure to observe these precautions could damage the battery, impair its performance, or prevent it from charging normally.
- On cold days, the capacity of batteries tends to decrease. Be sure that the battery is fully charged before heading outside to take pictures in cold weather. Keep spare batteries in a warm place and exchange as necessary. Once warmed, a cold battery may recover some of its charge.
- Dirt on the battery terminals can prevent the camera from functioning. Should the battery terminals become dirty, wipe them off with a clean, dry cloth before use.

Caring for the Products

- If the battery will not be used for some time, insert it in the camera and run it flat before removing it for storage. The battery should be stored in a cool location with an ambient temperature of 15°C to 25°C (59°F to 77°F). Do not store the battery in hot or extremely cold locations.
- Always remove the battery from the camera or battery charger when it is not being used. When inserted, minute amounts of current are drawn from the battery even when not in use. This may result in excessive draining of the battery and complete loss of function. Turning the camera on or off while the battery is exhausted can result in reduced battery life. When the battery level is low, be sure to charge the battery before using it.
- Recharge the battery at least once every six months and completely exhaust it before returning it to storage.
- After removing the battery from the camera or battery charger, attach the included terminal cover to the battery and store it in a cool place.
- A marked drop in the time a fully-charged battery retains its charge, when used at room temperature, indicates that the battery needs to be replaced. Purchase a new EN-EL12 battery.
- Replace the battery when it no longer holds a charge. Used batteries are a valuable resource. Please recycle used batteries in accordance with local regulations.

Charging AC Adapter

- Be sure to read and follow the warnings of "For Your Safety" (📖vi to 📖viii) thoroughly before using the Charging AC Adapter.
- The Charging AC Adapter EH-69P is for use only with compatible devices. Do not use with another make or model of device.
- The EH-69P is compatible with AC 100-240 V, 50/60 Hz electrical outlets. When using in other countries, use a plug adapter (commercially available) as necessary. For more information about plug adapters, consult your travel agency.
- Do not, under any circumstances, use another make or model of AC adapter other than Charging AC Adapter EH-69P or USB-AC adapter. Failure to observe this precaution could result in overheating or in damage to the camera.

The Memory Cards

- Use only Secure Digital memory cards. See “Approved Memory Cards” (📖19).
- Be sure to observe the precautions in the memory card documentation when you use the memory card.
- Do not affix labels or stickers to the memory card.
- Do not format the memory card using a computer.
- When a memory card that has been used in another device is used for the first time, be sure to format it with this camera.
When a new memory card is used, it is recommended to format it with this camera first.
- Formatting permanently deletes all data in the memory card. Be sure to transfer important pictures to a computer before formatting.
- If the error message “Card is not formatted. Format card?” is displayed when you insert a memory card into this camera, the memory card must be formatted. If the memory card contains images you wish to keep, select **No** and save those images on your computer before formatting the memory card. To format the card, select **Yes** and press the **OK** button.
- Do not perform the following during formatting, while data is being written to or deleted from the memory card, or during data transfer to a computer. Failure to observe this precaution could result in loss of data or damage to the memory card:
 - Open the battery-chamber/memory card slot cover to remove the battery or memory card.
 - Turn off the camera
 - Disconnect the AC adapter

Caring for the Camera

Cleaning

Lens	Avoid touching glass parts with your fingers. Remove dust or lint with a blower (typically a small device with a rubber bulb attached to one end that is pumped to produce a stream of air out the other end). To remove fingerprints, oily substances, or other stains that cannot be removed with a blower, carefully wipe the lens with a dry soft cloth or eyewear cleaning cloth, using a spiral motion that starts at the center of the lens and working toward the edges. Do not wipe the lens forcibly or with a hard material. Failure to observe this precaution could result in damage or trouble. If this fails, clean the lens using a cloth lightly dampened with commercial lens cleaner.
Monitor	Remove dust or lint with a blower. To remove fingerprints, oily substances or other stains, carefully wipe the monitor with a dry soft cloth or eyewear cleaning cloth. Do not wipe the monitor forcibly or with a hard material. Failure to observe this precaution could result in damage or trouble.
Body	Use a blower to remove dust, dirt, or sand, then wipe gently with a soft, dry cloth. After using the camera at the beach or other sandy or dusty environment, wipe off any sand, dust, or salt with a dry cloth lightly dampened with fresh water and dry thoroughly. Note that foreign matter inside the camera could cause damage not covered by the warranty.

Do not use volatile organic solvents such as alcohol or thinner, chemical detergents, anticorrosive agents, or anti-fogging agents.

Storage

Remove the battery if the camera will not be used for an extended period. Do not store the camera with naphtha or camphor moth balls, or in any of the following locations:

- Next to equipment that produces strong electromagnetic fields, such as televisions or radios
- Exposed to temperatures below -10°C (14°F) or above 50°C (122°F)
- Places that are poorly ventilated or subject to humidity of over 60%

To prevent mold or mildew, take the camera out of storage at least once a month. Turn the camera on and release the shutter a few times before putting the camera away again.

Be sure to read and follow the warnings given in "The Battery" (🔋:3) of "Caring for the Products" to store the battery.

Troubleshooting













If the camera fails to function as expected, check the list of common problems below before consulting your retailer or Nikon-authorized service representative. Refer to the page numbers in the right-most column for more information.



- See “Error Messages” (🔍97) for more information.

Power, Display, Settings Issues

Problem	Cause/Solution	
The battery inserted in the camera cannot be charged.	<ul style="list-style-type: none"> • Confirm all connections. • Close the battery-chamber/memory card slot cover. 	16 18
The battery cannot be charged by connecting the camera to a computer.	<ul style="list-style-type: none"> • Off is selected for Charge by computer in the setup menu. • When charging by connecting the camera to a computer, battery charging stops when the camera is turned off. • When charging by connecting the camera to a computer, battery charging stops when the computer is suspended (sleeping), and the camera may turn off. • Depending upon computer specifications, settings, and status, charging the battery inserted in the camera may not be possible via computer connection. 	100, 🔍84 🔍84 🔍84 –
Camera cannot be turned on.	<ul style="list-style-type: none"> • Battery is exhausted. • The camera cannot be turned on while connected to an electrical outlet via the Charging AC Adapter. • Camera cannot be turned on if the battery-chamber/memory card slot cover is open. 	20 16 18
Camera turns off without warning.	<ul style="list-style-type: none"> • Battery is exhausted. • If no operations are performed for a while, camera has turned off automatically by auto off to save power. • The camera turns off if the Charging AC Adapter is connected while the camera is on. • The camera turns off if the USB cable connecting it to a computer or printer is disconnected. Reconnect the USB cable. • Inside of the camera has become hot. Leave the camera off until the inside of the camera has cooled. • At low temperatures, the camera and the battery may not function normally. 	20 21 16 86, 89, 🔍27 – 🔍3

Troubleshooting





Problem	Cause/Solution	
Monitor is blank.	<ul style="list-style-type: none"> • Camera is off. • Battery is exhausted. • Standby mode for saving power: Press the power switch, shutter-release button,  button or  movie-record) button, or rotate the mode dial. • When flash lamp flashes, wait until flash has charged. • Camera and computer are connected via USB cable. • Camera and TV are connected via audio/video cable or HDMI cable. • Interval timer shooting in progress. 	21 20 21 60 86, 89 86,  24  44
Monitor is hard to see.	<ul style="list-style-type: none"> • Adjust monitor brightness. • Monitor is dirty. Clean monitor. 	98,  74  6
Date and time of recording are not correct.	<ul style="list-style-type: none"> • If the camera clock has not been set ("Date not set" indicator flashes during shooting), still pictures have a time stamp of "00/00/0000 00:00"; and movies are dated "01/01/12 00:00." Set the correct date and time using Time zone and date in the setup menu. • The camera clock is not as accurate as a normal clock, such as watches. Check camera clock regularly against more accurate timepieces and reset as required. 	22, 98  71 98,  71
No information displayed in monitor.	Hide info is selected for Photo info of Monitor settings in the setup menu.	98,  74
Print date not available.	Time zone and date in the setup menu has not been set.	22, 98,  71
Date is not appeared on pictures even when Print date is enabled.	<ul style="list-style-type: none"> • A shooting mode that does not support print date is selected. • Another function that is set now is restricting the print date. • The date cannot be imprinted onto a movie. 	98,  76 75 –
Screen for setting time zone and date is displayed when camera is turned on.	Clock battery is exhausted; all settings were restored to their default values.	23
Camera settings reset.		

Problem	Cause/Solution	
Reset file numbering cannot be done.	Reset file numbering cannot be applied when the folder number reaches 999 and there are images in the folder. Change the memory card, or format the internal memory/memory card.	100,  86
Monitor is turned off, and the power-on lamp flashes quickly.	Battery temperature is high. Turn off camera, and allow battery to cool down before resuming use. After the lamp flashes for three minutes, the camera turns off automatically, but you can also press the power switch to turn it off manually.	21
Camera temperature rises.	When functions such as movie recording or sending images using an Eye-Fi card are used for a long time, or when the camera is used in a location with a high ambient temperature, the camera temperature may rise. This is not a malfunction.	93





● Electronically Controlled Cameras











In extremely rare instances, unusual characters may appear on the monitor and the camera may stop functioning. In most cases, this phenomenon is caused by a strong external static charge. Turn the camera off, remove and replace the battery, then turn the camera on again. Note that disconnecting the power source as described above may result in the loss of any data not recorded on the internal memory or memory card at the time the problem occurred. Data already recorded is not affected. In the event of continued malfunction, contact your retailer or Nikon-authorized service representative.

Shooting Issues





Problem	Cause/Solution	
Cannot set to shooting mode.	Disconnect the HDMI cable or USB cable.	86, 89,  24,  27
No picture can be taken.	<ul style="list-style-type: none"> When camera is in playback mode, press the  button, shutter-release button or  (movie-record) button. When menus are displayed, press the MENU button. Battery is exhausted. When the scene mode is Night portrait or Backlighting with HDR set to Off, raise the flash. When flash lamp flashes, flash is charging. 	30 11 20 41, 45, 60 60
Cannot take 3D pictures	In some shooting conditions, such as when the subject moves or the subject is dark or low in contrast, the second shot may not be taken or the 3D picture may not be saved.	–

Troubleshooting



Problem	Cause/Solution	
Camera cannot focus.	<ul style="list-style-type: none"> Subject is too close to the camera. Try shooting with  (macro close-up) in the focus mode, or Scene auto selector or Close-up scene mode. The intended subject is one with which autofocus does not perform well. Set AF assist in the setup menu to Auto. Subject is not in focus area when shutter-release button is pressed halfway. The focus mode is set to MF (manual focus). Turn camera off and then on again. 	39, 43, 66 29 99,  79 28, 55 66 21
Colored stripes appear on the monitor when shooting.	Colored stripes may appear when shooting subjects with repeating patterns (such as window blinds); this is not a malfunction. The colored stripes will not appear in captured images or recorded movies. However, when using Continuous H: 120 fps or HS 120 fps (640x480) , the colored stripes may be seen in the captured images and recorded movies.	–
Pictures are blurred.	<ul style="list-style-type: none"> Use flash. Use vibration reduction or motion detection. Use BSS (Best Shot Selector). Use a tripod to stabilize the camera (use with the self-timer for better results). 	60 99, 99 55 63
Bright specks appear in pictures shot using flash.	Flash is reflecting off particles in air. Set the flash to  (off).	61
Flash does not fire.	<ul style="list-style-type: none"> Flash is set to  (off). A shooting mode where flash cannot fire is selected. Another function that is set now is restricting the flash. 	61 69 75
The digital zoom is not available.	<ul style="list-style-type: none"> Off is selected for Digital zoom in the setup menu. When Scene auto selector, Portrait, Night portrait, Easy panorama in Panorama, Pet portrait or 3D photography is selected in scene mode, the digital zoom cannot be used. Other functions that restrict the use of digital zoom are set. 	99 39, 41, 46, 49 75
Image size not available.	Another function that is set now is restricting Image size .	75

Problem	Cause/Solution	
No sound when shutter is released.	<ul style="list-style-type: none"> • Off is selected for Shutter sound under Sound settings in the setup menu. • Sports, Museum or Pet portrait is selected in scene mode. • Other functions that restrict the use of the shutter sound are set. • Do not block the speaker. 	99 40, 44, 47 75 3
AF-assist illuminator does not light.	Off is selected for AF assist in the setup menu. Even when Auto is set, AF-assist illuminator may not light depending on the focus area position or scene mode.	99
Pictures appear smeared.	Lens is dirty. Clean lens.	 6
Colors are unnatural.	White balance does not match light source.	55,  39
Ring-shaped or rainbow-colored bands are seen on the screen or the shot image.	When the subject is backlit or when shooting with an extremely bright light source in the display, such as in sunlight, ring-shaped or rainbow-colored bands may appear on the image. Change the position of the light source or remove it from the display, and try shooting again.	–
The image taken becomes grainy.	As the subject is dark, shutter speed is too slow or ISO sensitivity is too high. <ul style="list-style-type: none"> • Use flash. • Specify a lower ISO sensitivity setting. 	60 55,  46
Pictures are too dark (underexposed).	<ul style="list-style-type: none"> • Flash is set to  (off). • Flash window is blocked. • Subject is beyond flash range. • Adjust exposure compensation. • Raise the ISO sensitivity. • Subject is backlit. Raise the flash, and set the scene mode to Backlighting with HDR set to Off or set the flash mode to . 	61 26 60 68 55,  46 45, 60
Pictures are too bright (overexposed).	Adjust exposure compensation.	68
Areas not affected by red-eye are also corrected.	When  (auto with red-eye reduction) or “fill flash with red-eye reduction” of the Night portrait scene mode is applied during shooting, In-Camera Red-Eye Fix may, in very rare cases, be applied to areas not affected by red-eye. Set a flash mode other than  (auto with red-eye reduction), select a scene mode other than Night portrait , and resume shooting.	41, 61
Skin softening results are not as expected.	<ul style="list-style-type: none"> • Skin softening may not produce the desired results depending on shooting conditions. • For pictures with four or more faces, try using Skin softening in the playback menu. 	50 84,  19

Troubleshooting

Problem	Cause/Solution	
Saving images takes time.	<p>It may take more time to save images in the following situations.</p> <ul style="list-style-type: none"> When the noise reduction function is in operation When flash is set to  (auto with red-eye reduction) When taking pictures in the following scene modes. <ul style="list-style-type: none"> - Hand-held in  (Night landscape) - Noise reduction burst in Landscape or Close-up - Hand-held in Night portrait - HDR set to other than Off in Backlighting - Easy panorama in Panorama Continuous in the shooting menu is set to Continuous H: 120 fps or Continuous H: 60 fps When using smile timer while shooting When using Active D-Lighting while shooting 	– 61 38 40, 43 41 45 46 55,  42 64 56,  54
Cannot set or use Continuous or Exposure bracketing .	Another function that is set now is restricting the Continuous setting or Exposure bracketing .	75
Cannot set COOLPIX Picture Control.	Another function that is set now is restricting COOLPIX Picture Control.	75

Playback Issues

Problem	Cause/Solution	
File cannot be played back.	<ul style="list-style-type: none"> File was overwritten or renamed by computer or another make or model of camera. File cannot be played back during interval timer shooting. Movies recorded with cameras other than COOLPIX P310 cannot be played back. 	– 55 92
Cannot play a sequence.	<ul style="list-style-type: none"> Pictures shot continuously with cameras other than COOLPIX P310 cannot be played as a sequence. Check the Sequence display options setting. 	– 85,  64
Cannot zoom in on picture.	<ul style="list-style-type: none"> Playback zoom cannot be used with movies, small pictures, or cropped copies of size 320 × 240 pixels or smaller. Playback zoom may not be available for pictures taken with cameras other than COOLPIX P310. 3D pictures cannot be enlarged when the camera is connected via HDMI and they are played back in 3D. 	– –  8
Cannot record or play back voice memo.	<ul style="list-style-type: none"> Voice memos cannot be attached to movies. Voice memos cannot be attached to pictures taken with cameras other than COOLPIX P310, and voice memos recorded by other cameras cannot be played back. 	96 84

Problem	Cause/Solution	
Pictures and movies cannot be edited.	<ul style="list-style-type: none"> • Confirm the conditions that are required for editing pictures or movies. • Pictures and movies taken with cameras other than COOLPIX P310 cannot be edited. 	17, 32 –
Pictures are not displayed on television.	<ul style="list-style-type: none"> • Video mode or HDMI is not correctly set in the TV settings setup menu. • Cables are connected to both the HDMI mini connector and USB/audio video connector. • Memory card contains no pictures. Replace memory card. Remove memory card to play back pictures from internal memory. 	100, 82 86 18
Nikon Transfer 2 does not start when camera is connected to a computer.	<ul style="list-style-type: none"> • Camera is off. • Battery is exhausted. • USB cable is not correctly connected. • Camera is not recognized by the computer. • Confirm that the operating system used is compatible with the camera. • Computer is not set to launch Nikon Transfer 2 automatically. For more information on Nikon Transfer 2, refer to help information contained in ViewNX 2. 	21 20 86 – 87 90
The PictBridge startup screen is not displayed when the camera is connected to a printer.	With some PictBridge-compatible printers, the PictBridge startup screen may not be displayed and it may be impossible to print images when Auto is selected for the Charge by computer option. Set the Charge by computer option to Off and reconnect the camera to the printer.	100, 84
Pictures to be printed are not displayed.	<ul style="list-style-type: none"> • Memory card contains no pictures. Replace memory card. • Remove memory card to print pictures from internal memory. • Pictures taken by 3D photography cannot be printed. 	18 19 8
Cannot select paper size with camera.	Paper size cannot be selected from the camera in the following situations, even for PictBridge compatible printers. Use the printer to select paper size. <ul style="list-style-type: none"> • The paper size selected using the camera is not compatible with the printer. • A printer that automatically sets the paper size is being used. 	28, 29 –

Specifications

Nikon COOLPIX P310 Digital Camera

Type	Compact digital camera
Effective pixels	16.1 million
Image sensor	1/2.3-in. type CMOS; approx. 16.79 million total pixels
Lens	4.2x optical zoom, NIKKOR lens
Focal length	4.3-17.9mm (angle of view equivalent to that of 24-100 mm lens in 35mm [135] format)
f/-number	f/1.8-4.9
Construction	7 elements in 6 groups
Digital zoom	Up to 2x (angle of view equivalent to that of approx. 200 mm lens in 35mm [135] format)
Vibration reduction	Lens shift
Autofocus (AF)	Contrast-detect AF
Focus range (from lens)	<ul style="list-style-type: none"> • [W]: Approx. 30 cm (1 ft) to ∞, [T]: Approx. 60 cm (2 ft) to ∞ • Macro close-up mode: Approx. 2 cm (0.8 in.) (at a wide-angle position) to ∞
Focus-area selection	Face priority, auto (9-area automatic selection), center, manual with 99 focus areas, subject tracking, Target finding AF
Monitor	7.5-cm (3-in.), approx. 921k-dot, wide viewing angle TFT LCD monitor with anti-reflection coating and 5-level brightness adjustment
Frame coverage (shooting mode)	Approx. 100% horizontal and 100% vertical (compared to actual picture)
Frame coverage (playback mode)	Approx. 100% horizontal and 100% vertical (compared to actual picture)
Storage	
Media	Internal memory (approx. 90 MB) SD/SDHC/SDXC memory card
File system	DCF, Exif 2.3, DPOF, MPF compliant
File formats	Still pictures: JPEG 3D pictures: MPO Sound files (voice memo): WAV Movies: MOV (Video: H.264/MPEG-4 AVC, Audio: AAC stereo)
Image size (pixels)	<ul style="list-style-type: none"> • 16 M 4608×3456 • 8 M 3264×2448 • 4 M 2272×1704 • 2 M 1600×1200 • VGA 640×480 • 16:9 12M 4608×2592 • 16:9 2M 1920×1080 • 3:2 4608×3072 • 1:1 3456×3456

ISO sensitivity (Standard output sensitivity)	<ul style="list-style-type: none"> • ISO 100, 200, 400, 800, 1600, 3200, Hi 1 (equivalent to 6400) • Auto (auto gain from ISO 100 to 1600) • Fixed range auto (ISO 100 to 400, 100 to 800) • Hi 2 (equivalent to 12800) (Special effects is set to High ISO monochrome in scene mode)
Exposure	
Metering	224-segment matrix, center-weighted, spot
Exposure control	Programmed auto exposure with flexible program, shutter priority auto, aperture-priority auto, manual, exposure bracketing, motion detection, exposure compensation (–2.0 to +2.0 EV in steps of 1/3 EV)
Shutter	Mechanical and CMOS electronic shutter
Speed	<p>Auto mode, scene mode</p> <ul style="list-style-type: none"> • 1/2000* to 1 s • 1/2000* to 2 s (Tripod in Night landscape scene mode) • 4 s (Fireworks show scene mode) <p>P, S, A, and M modes</p> <ul style="list-style-type: none"> • 1/2000* to 8 s (when ISO sensitivity is set to 100 in M mode: including when set to Auto or Fixed range auto) • 1/2000* to 4 s (when ISO sensitivity is fixed at 100, 200, or 400 in P, S, or A mode, and when ISO sensitivity is fixed at 200 or 400 in M mode) • 1/2000* to 2 s (when ISO sensitivity is fixed at 800) • 1/2000* to 1 s (when ISO sensitivity is fixed at 1600, and when set to Auto or Fixed range auto in P, S, or A mode) • 1/2000* to 1/2 s (when ISO sensitivity is fixed at 3200 or Hi 1) • 1/4000 to 1/125 s (Continuous H: 120 fps) • 1/4000 to 1/60 s (Continuous H: 60 fps) <p>* When the aperture value is set to f/1.8 (largest aperture), the fastest shutter speed is 1/1600 second. When the aperture value is set to f/8 and the zoom is at the maximum wide-angle position or moved one increment to the telephoto position, the fastest shutter speed is 1/1600 second (except during S and M modes).</p>
Aperture	Electronically-controlled 6-blade iris diaphragm
Range	14 steps of 1/3 EV (W) (A , M mode)
Self-timer	Durations of 2 or 10 seconds can be selected
Built-in flash	
Range (approx.) (ISO sensitivity: Auto)	[W]: 0.5 to 6.5 m (1 ft 8 in. to 21 ft) [T]: 0.5 to 2.5 m (1 ft 8 in. to 8 ft 2 in.)
Flash control	TTL auto flash with monitor preflashes
Interface	Hi-Speed USB
Data transfer protocol	MTP, PTP
Video output	Can be selected from NTSC and PAL
HDMI output	Can be selected from Auto, 480p, 720p, and 1080i

Specifications

I/O terminal	Audio/video output; digital I/O (USB); HDMI Mini Connector (Type C) (HDMI output)
Supported languages	Arabic, Brazilian Portuguese, Chinese (Simplified and Traditional), Czech, Danish, Dutch, English, Finnish, French, German, Greek, Hindi, Hungarian, Indonesian, Italian, Japanese, Korean, Norwegian, Polish, Portuguese, Romanian, Russian, Spanish, Swedish, Thai, Turkish, Ukrainian, Vietnamese
Power sources	<ul style="list-style-type: none">• One Rechargeable Li-ion Battery EN-EL12 (included)• AC Adapter EH-62F (available separately)
Charging time	Approx. 4 hours (when using Charging AC Adapter EH-69P and when no charge remains)
Battery life (EN-EL12)	Still pictures ¹ : Approx. 230 shots Movies ² : Approx. 1 h 5 min (HD 1080p ★ (1920×1080))
Tripod socket	1/4 (ISO 1222)
Dimensions (W × H × D)	Approx. 103.0 × 58.3 × 32.0 mm (4.1 × 2.3 × 1.3 in.) (excluding projections)
Weight	Approx. 194 g (6.9 oz) (including battery and SD memory card)
Operating environment	
Temperature	0°C to 40°C (32°F to 104°F)
Humidity	85% and below (no condensation)

- Unless otherwise stated, all figures are for a camera with a fully-charged Rechargeable Li-ion Battery EN-EL12 operated at an ambient temperature of 25°C (77°F).

¹ Based on Camera and Imaging Products Association (CIPA) standards for measuring the life of camera batteries. Measured at 23 (±2)°C (73 (±4)°F); zoom adjusted with each shot, flash fired with every other shot, image quality set to **Normal**, image size set to  **4608×3456**. Battery life may vary depending on shooting interval and length of time menus and images are displayed.

² When recording a single movie, the maximum recording time is 4 GB or 29 minutes, even when there is enough free space on the memory card.

Rechargeable Li-ion Battery EN-EL12

Type	Rechargeable lithium-ion battery
Rated capacity	DC 3.7 V, 1050 mAh
Operating temperature	0°C to 40°C (32°F to 104°F)
Dimensions (W × H × D)	Approx. 32 × 43.8 × 7.9 mm (1.3 × 1.7 × 0.3 in.)
Weight	Approx. 22.5 g (0.8 oz) (excluding terminal cover)

Charging AC Adapter EH-69P

Rated input	AC 100-240 V, 50/60 Hz, 0.068-0.042 A
Rated output	DC 5.0 V, 550 mA
Operating temperature	0°C to 40°C (32°F to 104°F)
Dimensions (W × H × D)	Approx. 55 × 22 × 54 mm (2.2 × 0.9 × 2.2 in.) (excluding plug adapter) For Argentina: Approx. 55 × 59 × 63 mm (2.2 × 2.4 × 2.5 in.) For Korea: Approx. 55 × 59 × 66.5 mm (2.2 × 2.4 × 2.7 in.)
Weight	Approx. 55 g (2.0 oz) (excluding plug adapter) For Argentina and Korea: Approx. 80 g (2.9 oz)

Specifications

- Nikon will not be held liable for any errors this manual may contain.
- The appearance of this product and its specifications are subject to change without notice.

Supported Standards

- **DCF:** Design Rule for Camera File System is a standard widely used in the digital camera industry to ensure compatibility among different makes of camera.
- **DPOF:** Digital Print Order Format is an industry-wide standard that allows pictures to be printed at a digital photo lab or with a household printer from print orders stored on the memory card.
- **Exif version 2.3:** This camera supports Exif (Exchangeable Image File Format for Digital Still Cameras) version 2.3, a standard that allows information stored with photographs to be used for optimal color reproduction when images are output from Exif-compliant printers.
See the instruction manual of the printer for further details.
- **PictBridge:** A standard developed cooperatively by the digital camera and printer industries, allowing photographs to be output directly to a printer without connecting the camera to a computer.

Index

Symbols

7, 8

A Aperture-priority auto mode 51, 10

Apply selection button 5, 10

Auto mode 24

Delete button 4, 5, 32, 62

Flash mode 60

Flash pop-up control 60

Focus mode 66

Fn FUNC button 4, 83

M Manual mode 51, 12

MENU Menu button 4, 5, 11

Night landscape mode 38

Playback button 4, 5, 30

Playback zoom 31

P Programmed auto mode 51, 10

SCENE Scene mode 37

Self-timer/Smile timer 63, 64

S Shutter-priority auto mode 51, 10

T Tele 27

Thumbnail playback 5, 31

U User settings mode 57

W Wide 27

movie-record) button 92

.JPG 94

.MOV 94

.MPO 94

.WAV 94

Numerics

3D photography 49, 8

A

AC adapter 17, 96

Active D-Lighting 56, 54

AF area mode 55, 48

AF assist 99, 79

AF mode 56, 95, 52

AF/access lamp 28

Aperture value 51

Aperture-priority auto mode 51, 10

Audio/video cable 86, 24

Audio/video-in jack 24

Auto 61

Auto bracketing 55

Auto off 99, 80

Auto with red-eye reduction 61

Autofocus 56, 52

Autofocus mode 56, 67, 52, 69

AV cable 86, 24, 96

B

Backlighting 45

Battery 14, 96

Battery charger 96

Battery level indicator 20

Battery-chamber/memory card slot cover 18

Beach 42

Best shot selector 55, 43

Black and white copy 44

Black border 84, 22

Blink warning 100, 87

BSS 55, 43

Button sound 99, 80

C

Calendar display 31

Charger 16, 96

Charging AC Adapter 16, 96

Choose key picture 85, 64

Close-up 43

Command dial 4, 5

Computer 86

Continuous 55, 42

Contrast 36









COOLPIX Custom Picture Control 54, 38

COOLPIX Picture Control 54, 34







Crop 23, 32

Custom Picture Control 54, 38

















D





- Date and time 22, 71
- Daylight saving time 23
- Delete 32, 62
- Digital zoom 27, 99, 79
- Direct Print 26
- D-Lighting 84, 18
- DPOF printing 31
- DSCN 94
- Dusk/dawn  42

E







- Easy panorama 46, 3
- Editing movies 32
- Editing Pictures 16
- Exposure compensation 68
- Exposure mode 51
- Extension 94
- Extracting still pictures 33
- Eye-Fi upload 101, 89

E







- Face detection 80
- Face priority 55, 48
- Features that cannot be used simultaneously 75
- File name 94
- Fill flash 61
- Filmstrip 101, 88
- Filter effects 84, 20, 36
- Fireworks show  44
- Firmware version 101, 93
- Flash 60
- Flash exp. comp. 56, 53
- Flash mode 60
- Fn button 100, 83
- Focal length 55, 14
- Focus 28, 48, 52
- Focus area 28, 48
- Focus lock 81
- Focus mode 66
- Folder name 94
- Food  44
- Format 18, 99, 81

- Format the internal memory 99, 81
- Format the memory card 18, 81
- FSCN 94
- Full-frame playback 30
- Full-time AF 52, 69





H

- HDMI 100, 24, 82
- HDMI device control 100, 82
- HDMI mini connector 86, 24
- HDR 45
- Histogram 6, 8
- HS movie 95, 66, 67







I

- Identifier 94
- Image copy 84, 63
- Image quality 72
- Image sharpening 36
- Image size 72, 73
- Infinity 67
- Internal memory indicator 20
- Interval Timer Shooting 55, 43, 44
- ISO sensitivity 55, 46

L

- Landscape  40
- Language 100, 81
- Lens 6, 14
- Li-ion rechargeable battery 16, 96
- Lithium-ion type battery 14, 96

M

- Macro close-up 67
- Manual focus 67, 2
- Manual mode 51, 12
- Memory capacity 20
- Memory card 18, 19
- Memory card slot 18
- Metering 55, 41
- Microphone 92, 62
- Minimum shutter speed 55, 46
- Monitor 6, 8, 6
- Monitor brightness 98, 74

Index

Monitor settings 98, 74
Motion detection 99, 78
Movie length 92, 94
Movie options 95, 65
Movie playback 96
Movie recording 92
Multi selector 4, 5, 10, 59
Multi-shot 16 55, 43
Museum 44

N

Night landscape 38
Night portrait 41
Noise reduction filter 56, 53
Number of exposures remaining 20, 74

O

Off 61
Optical zoom 27
Optional accessories 96

P

Panorama assist 46, 6
Panorama 46
Paper size 28, 29
Party/indoor 42
Pet portrait 47
Photo info 98, 74
PictBridge 26, 17
Picture Control 54, 34
Playback 30, 96, 62
Playback menu 84
Playback mode 9, 30
Playback zoom 31
Portrait 39
Power 20, 21, 22
Power switch/power-on lamp 21
Pressing halfway 4, 28
Print 26, 28, 29
Print date 98, 76
Print order 84, 56
Print order option 57
Printer 86, 26
Programmed auto mode 51, 10
Protect 84, 59

Q

Quick adjust 36
Quick retouch 84, 18

R







Rear-curtain sync 61
Rechargeable battery 14, 96
Recording slow motion movies 67
Reset all 101, 90
Reset file numbering 100, 86
Reset user settings 56, 58
Reverse indicators 101, 90
Rotary multi selector 4, 5, 10, 59
Rotate image 84, 61
RSCN 94

S





Saturation 36
Save user setting 54
Scene auto selector 39
Scene mode 37, 38
Selecting pictures 60
Self-timer 63
Self-timer lamp 63
Sequence 14
Sequence display options 85, 64
Setup menu 98
Shooting 24
Shooting menu 54
Shutter sound 99, 80
Shutter speed 51
Shutter-priority auto mode 51, 10
Shutter-release button 4, 5, 28
Single 55, 42
Single AF 52, 69
Skin softening 50, 84, 19
Slide show 84, 58
Slow sync 61
Small picture 84, 21
Smile timer 64
Snow 42
Sound settings 99, 80
Special effects 48
Sports 40

SSCN 94
Startup zoom position 56, 55
Subject tracking 55, 49, 51
Sunset  42





I

Target finding AF 55, 50
Tele 27
Thumbnail playback 31
Time difference 73
Time zone 22, 73
Time zone and date 22, 98, 71
Toggle Av/Tv selection 100, 86
Toning 37
TV settings 100, 82



U

USB cable 16, 86, 27, 96
USB/audio/video output connector 16,
86, 24, 27
User setting modes 57

V

Vibration reduction 99, 77
Video mode 100, 82
View grid 35
View/hide histograms 98, 74
ViewNX 2 87
Voice memo 84, 62
Volume 96

W

Welcome screen 98, 70
White balance 55, 39
Wide 27

Z

Zoom 27
Zoom control 4, 5, 27
Zoom memory 56, 55



A series of horizontal dashed lines spanning the width of the page, intended for handwriting practice.



A series of horizontal dashed lines for handwriting practice, spanning the width of the page.

Nikon

No reproduction in any form of this manual, in whole or in part (except for brief quotation in critical articles or reviews), may be made without written authorization from NIKON CORPORATION.



NIKON CORPORATION

© 2012 Nikon Corporation

FX2B02(11)
6MM17611-02