

Nikon

DIGITAL CAMERA

COOLPIX AW100

Reference Manual

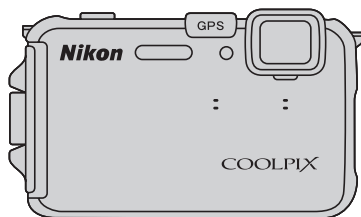

En

Trademark Information

- Microsoft, Windows and Windows Vista are either registered trademarks or trademarks of Microsoft Corporation in the United States and/or other countries.
- Macintosh, Mac OS, and QuickTime are trademarks of Apple Inc., registered in the U.S. and other countries. The iFrame logo and the iFrame symbol are trademarks of Apple Inc.
- Adobe and Acrobat are registered trademarks of Adobe Systems Inc.
- SDXC, SDHC and SD Logos are trademarks of SD-3C, LLC.
- PictBridge is a trademark.
- HDMI, **HDMI** logo and High-Definition Multimedia Interface are trademarks or registered trademarks of HDMI Licensing LLC.
- All other trade names mentioned in this manual or the other documentation provided with your Nikon product are trademarks or registered trademarks of their respective holders.

AVC Patent Portfolio License

This product is licensed under the AVC Patent Portfolio License for the personal and non-commercial use of a consumer to (i) encode video in compliance with the AVC standard ("AVC video") and/or (ii) decode AVC video that was encoded by a consumer engaged in a personal and non-commercial activity and/or was obtained from a video provider licensed to provide AVC video. No license is granted or shall be implied for any other use. Additional information may be obtained from MPEG LA, L.L.C.

See <http://www.mpegla.com>.

Introduction

Parts of the Camera and Basic Operations

The Basics of Shooting and Playback

Shooting Features

Playback Features

Recording and Playing Back Movies

Using GPS/Displaying Maps

General Camera Setup

Reference Section

Technical Notes and Index

Read This First

Thank you for purchasing the Nikon COOLPIX AW100 digital camera. Before using the camera, please read the information in "For Your Safety" (📖vi) and "<Important> Shockproof, waterproof, dustproof, condensation, GPS/digital compass" (📖xi), and familiarize yourself with the information provided in this manual. After reading, please keep this manual handy and refer to it to enhance your enjoyment of your new camera.

Confirming the Package Contents

In the event that any items are missing, please contact the store where you purchased the camera.

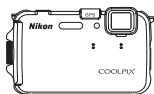

COOLPIX AW100
Digital Camera



Camera strap for land use

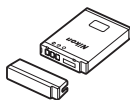

Rechargeable Li-ion Battery
EN-EL12
(with terminal cover)



Battery Charger MH-65
(with power cable)*



Filter Adapter UR-E23
(with cord)

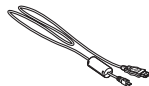

USB Cable UC-E6

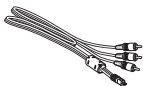

Audio Video Cable EG-CP16



ViewNX 2 Installer CD



Reference Manual CD

- Warranty

* Shape of power cable depends on country of use.

NOTES:

- Accessories are not waterproof.
- A memory card is not included with the camera.

About This Manual





If you want to start using the camera right away, see “The Basics of Shooting and Playback” (📖15).

To learn about the parts of the camera and basic operations, see “Parts of the Camera and Basic Operations” (📖1).

Other Information

- Symbols and Conventions

To make it easier to find the information you need, the following symbols and conventions are used in this manual:

Icon	Description
	This icon indicates cautions and information that should be read before using the camera.
	This icon marks notes, information that should be read before using the camera.
	These icons indicate other pages containing relevant information;  : “Reference Section”,  : “Technical Notes and Index.”

- SD, SDHC and SDXC memory cards are referred to as “memory cards” in this manual.
- The setting at the time of purchase is referred to as the “default setting.”
- The names of menu items displayed in the camera monitor, and the names of buttons or messages displayed on a computer monitor appear in bold.
- In this manual, images are sometimes omitted from monitor display samples so that monitor indicators can be more clearly shown.
- Illustrations and monitor content shown in this manual may differ from the actual product.

Information and Precautions

Life-Long Learning

As part of Nikon's "Life-Long Learning" commitment to ongoing product support and education, continually updated information is available online at the following sites:

- For users in the U.S.A.: <http://www.nikonusa.com/>
- For users in Europe and Africa: <http://www.europe-nikon.com/support/>
- For users in Asia, Oceania, and the Middle East: <http://www.nikon-asia.com/>

Visit these sites to keep up-to-date with the latest product information, tips, answers to frequently asked questions (FAQs), and general advice on digital imaging and photography. Additional information may be available from the Nikon representative in your area. Visit the site below for contact information:

<http://imaging.nikon.com/>

Use Only Nikon Brand Electronic Accessories

Nikon COOLPIX cameras are designed to the highest standards and include complex electronic circuitry. Only Nikon brand electronic accessories (including battery chargers, batteries, and AC adapters) certified by Nikon specifically for use with this Nikon digital camera are engineered and proven to operate within the operational and safety requirements of this electronic circuitry.

THE USE OF NON-NIKON ELECTRONIC ACCESSORIES COULD DAMAGE THE CAMERA AND MAY VOID YOUR NIKON WARRANTY.

The use of third-party rechargeable Li-ion batteries not bearing the Nikon holographic seal could interfere with normal operation of the camera or result in the batteries overheating, igniting, rupturing, or leaking.

For more information about Nikon brand accessories, contact a local authorized Nikon dealer.

Holographic seal: Identifies this device as an authentic Nikon product.



Before Taking Important Pictures

Before taking pictures on important occasions (such as at weddings or before taking the camera on a trip), take a test shot to ensure that the camera is functioning normally. Nikon will not be held liable for damages or lost profits that may result from product malfunction.

About the Manuals

- No part of the documentation included with this product may be reproduced, transmitted, transcribed, stored in a retrieval system, or translated into any language in any form, by any means, without Nikon's prior written permission.
- Nikon will not be held liable for any damages resulting from the use of this product.
- Nikon reserves the right to change the specifications of the hardware and software described in the documentation at any time and without prior notice.
- While every effort was made to ensure that the information in the documentation is accurate and complete, we would appreciate it were you to bring any errors or omissions to the attention of the Nikon representative in your area (address provided separately).

Notice Concerning Prohibition of Copying or Reproduction

Note that simply being in possession of material that was digitally copied or reproduced by means of a scanner, digital camera or other device may be punishable by law.

• Items prohibited by law from being copied or reproduced

Do not copy or reproduce paper money, coins, securities, government bonds or local government bonds, even if such copies or reproductions are stamped "Sample." The copying or reproduction of paper money, coins, or securities which are circulated in a foreign country is prohibited. Unless the prior permission of the government was obtained, the copying or reproduction of unused postage stamps or post cards issued by the government is prohibited.

The copying or reproduction of stamps issued by the government and of certified documents stipulated by law is prohibited.

• Cautions on certain copies and reproductions

The government has issued cautions on copies or reproductions of securities issued by private companies (shares, bills, checks, gift certificates, etc.), commuter passes, or coupon tickets, except when a minimum of necessary copies are to be provided for business use by a company. Also, do not copy or reproduce passports issued by the government, licenses issued by public agencies and private groups, ID cards and tickets, such as passes and meal coupons.

• Comply with copyright notices

The copying or reproduction of copyrighted creative works such as books, music, paintings, woodcut prints, maps, drawings, movies, and photographs is governed by national and international copyright laws. Do not use this product for the purpose of making illegal copies or to infringe copyright laws.

Disposing of Data Storage Devices

Please note that deleting images or formatting data storage devices such as memory cards or built-in camera memory does not completely erase the original image data. Deleted files can sometimes be recovered from discarded storage devices using commercially available software, potentially resulting in the malicious use of personal image data. Ensuring the privacy of such data is the user's responsibility.

Before discarding a data storage device or transferring ownership to another person, erase all data using commercial deletion software, or format the device and then completely refill it with images containing no private information (for example, pictures of empty sky). Be sure to also replace any pictures selected for the **Select an image** option in the **Welcome screen** setting (□□94). Care should be taken to avoid injury or damage to property when physically destroying data storage devices.

For Your Safety

To prevent damage to your Nikon product or injury to yourself or to others, read the following safety precautions in their entirety before using this equipment. Keep these safety instructions where all those who use the product will read them.



This icon marks warnings, information that should be read before using this Nikon product, to prevent possible injury.

WARNINGS

Turn off in the event of malfunction

Should you notice smoke or an unusual smell coming from the camera or Battery Charger, unplug the AC adapter and remove the battery immediately, taking care to avoid burns. Continued operation could result in injury. After removing or disconnecting the power source, take the equipment to a Nikon-authorized service representative for inspection.

Do not disassemble

Touching the internal parts of the camera or Battery Charger could result in injury. Repairs should be performed only by qualified technicians. Should the camera or Battery Charger break open as the result of a fall or other accident, take the product to a Nikon-authorized service representative for inspection, after unplugging the product and/or removing the battery.

Do not use the camera or Battery Charger in the presence of flammable gas

Using the camera in the presence of flammable gases such as propane and gasoline, as well as flammable sprays or dust could result in explosion or fire.

Remove the strap when using the camera underwater

Twisting the camera strap around the neck may cause suffocation.

Handle the camera strap with care

Never place the strap around the neck of an infant or child.

Keep out of reach of children

Do not keep the products within reach of children. Doing so may cause injury. Particular care should be taken to prevent infants from putting the battery or other small parts into their mouths.

Do not remain in contact with the camera, battery charger, or AC adapter for extended periods while the devices are on or in use.

Parts of the devices become hot. Leaving the devices in direct contact with the skin for extended periods may result in low-temperature burns.

⚠ Observe caution when handling the battery

The battery may leak, overheat, or explode if improperly handled. Observe the following precautions when handling the battery for use in this product:

- Before replacing the battery, turn the product off. If you are using the Battery Charger/AC adapter, be sure it is unplugged.
- Use only a Rechargeable Li-ion Battery EN-EL12 (included). Charge the battery by inserting it in a Battery Charger MH-65 (included).
- When inserting the battery, do not attempt to insert it upside down or backwards.
- Do not short or disassemble the battery or attempt to remove or break the battery insulation or casing.
- Do not expose the battery to flame or to excessive heat.
- Do not immerse in or expose to water.
- Replace the terminal cover when transporting the battery. Do not transport or store with metal objects such as necklaces or hairpins.
- The battery is prone to leakage when fully discharged. To avoid damage to the product, be sure to remove the battery when no charge remains.
- Discontinue use immediately should you notice any change in the battery, such as discoloration or deformation.
- If liquid from the damaged battery comes in contact with clothing or skin, rinse immediately with plenty of water.

⚠ Observe the following precautions when handling the Battery Charger

- Keep dry. Failure to observe this precaution could result in fire or electric shock.
- Dust on or near the metal parts of the plug should be removed with a dry cloth. Continued use could result in fire.
- Do not handle the power cable or go near the Battery Charger during lightning storms. Failure to observe this precaution could result in electric shock.
- Do not damage, modify, forcibly tug or bend the power cable, place it under heavy objects, or expose it to heat or flames. Should the insulation be damaged and the wires become exposed, take it to a Nikon-authorized service representative for inspection. Failure to observe these precautions could result in fire or electric shock.
- Do not handle the plug or Battery Charger with wet hands. Failure to observe this precaution could result in electric shock.
- Do not use with travel converters or adapters designed to convert from one voltage to another or with DC-to-AC inverters. Failure to observe this precaution could damage the product or cause overheating or fire.

⚠ Use appropriate cables

When connecting cables to the input and output jacks, use only the cables provided or sold by Nikon for the purpose, to maintain compliance with product regulations.

⚠ Handle moving parts with care

Be careful that your fingers or other objects are not pinched by the lens cover or other moving parts.

⚠ CD-ROMs

The CD-ROMs included with this device should not be played back on audio CD equipment. Playing CD-ROMs on an audio CD player could cause hearing loss or damage the equipment.

⚠ Observe caution when using the flash

Using the flash close to your subject's eyes could cause temporary visual impairment. Particular care should be observed if photographing infants, when the flash should be no less than 1 m (3 ft 4 in.) from the subject.

⚠ Do not operate the flash with the flash window touching a person or object

Failure to observe this precaution could result in burns or fire.

⚠ Avoid contact with liquid crystal

Should the monitor break, care should be taken to avoid injury caused by broken glass and to prevent liquid crystal from the monitor touching the skin or entering the eyes or mouth.

⚠ Turn the power off when using inside an airplane or the hospital

Turn the power off while inside an airplane during takeoff and landing. Also, before boarding an airplane, set the GPS tracking information recording function to OFF. If using in a hospital, be sure to follow the instructions of the hospital. The electromagnetic waves emitted by this camera may disrupt the electronic systems of the airplane or the instruments of the hospital.

⚠ Do not touch the camera directly for a long time in low temperatures of 0°C (32°F) or lower

If the skin contacts metal parts etc., it may result in injury to the skin. Wear gloves etc.

⚠ Drivers should not operate the camera while driving.

This could cause a traffic accident.

⚠ Observe caution when using the movie light

Do not look directly into the movie light. This could damage the eyes or result in visual impairment.

Notices

Notices for Customers in the U.S.A.

IMPORTANT SAFETY INSTRUCTIONS -

SAVE THESE INSTRUCTIONS.

DANGER - TO REDUCE THE RISK OF FIRE OR ELECTRIC SHOCK, CAREFULLY FOLLOW THESE INSTRUCTIONS

For connection to a supply not in the U.S.A., use an attachment plug adapter of the proper configuration for the power outlet if needed.

The power supply unit is intended to be correctly orientated in a vertical or floor mount position.

Federal Communications Commission (FCC) Radio Frequency Interference Statement

This equipment has been tested and found to comply with the limits for a Class B digital device, pursuant to Part 15 of the FCC rules. These limits are designed to provide reasonable protection against harmful interference in a residential installation. This equipment generates, uses, and can radiate radio frequency energy and, if not installed and used in accordance with the instructions, may cause harmful interference to radio communications. However, there is no guarantee that interference will not occur in a particular installation. If this

equipment does cause harmful interference to radio or television reception, which can be determined by turning the equipment off and on, the user is encouraged to try to correct the interference by one or more of the following measures:

- Reorient or relocate the receiving antenna.
- Increase the separation between the equipment and receiver.
- Connect the equipment into an outlet on a circuit different from that to which the receiver is connected.
- Consult the dealer or an experienced radio/television technician for help.



Nikon

COOLPIX AW100

CAUTIONS

Modifications

The FCC requires the user to be notified that any changes or modifications made to this device that are not expressly approved by Nikon Corporation may void the user's authority to operate the equipment.

Interface Cables

Use the interface cables sold or provided by Nikon for your equipment. Using other interface cables may exceed the limits of Class B Part 15 of the FCC rules.

Notice for Customers in the State of California

WARNING

Handling the cord on this product will expose you to lead, a chemical known to the State of California to cause birth defects or other reproductive harm.

Wash hands after handling.

Nikon Inc.,
1300 Walt Whitman Road,
Melville, New York 11747-3064
USA
Tel: 631-547-4200

Notice for Customers in Canada

CAUTION

This Class B digital apparatus complies with Canadian ICES-003.

ATTENTION

Cet appareil numérique de la classe B est conforme à la norme NMB-003 du Canada.

Notices for Customers in Europe

CAUTIONS

RISK OF EXPLOSION IF BATTERY IS REPLACED BY AN INCORRECT TYPE.

DISPOSE OF USED BATTERIES ACCORDING TO THE INSTRUCTIONS.

This symbol indicates that this product is to be collected separately.

The following apply only to users in European countries:



- This product is designated for separate collection at an appropriate collection point. Do not dispose of as household waste.
- For more information, contact the retailer or the local authorities in charge of waste management.

This symbol on the battery indicates that the battery is to be collected separately.

The following apply only to users in European countries:



- All batteries, whether marked with this symbol or not, are designated for separate collection at an appropriate collection point. Do not dispose of as household waste.
- For more information, contact the retailer or the local authorities in charge of waste management.

<Important> Shockproof, waterproof, dustproof, condensation, GPS/digital compass

- Make sure to read the following instructions as well as the instructions provided in “Caring for the Products” (P.2).

Notes on shockproof performance

This camera has passed Nikon's in-house test (drop test from a height of 152 cm (60 in.) on a 5 cm (2 in.) thick plywood panel) compliant with MIL-STD 810F Method 516.5-Shock*.

This test does not guarantee the waterproof performance of the camera or that the camera will be free from damage or trouble under all conditions.

Changes in appearance, such as paint peeling off and deformation of the drop shock portion are not subject to the Nikon's in-house test.

* U.S. Department of Defense test method standard.

This drop test drops 5 cameras in 26 directions (8 edges, 12 corners, and 6 faces) from a height of 122 cm (48 in.) to make sure that one to five cameras pass the test (if any defect is detected during the test, another five cameras are tested to make sure that the test criteria are satisfied for one to five cameras).

● Do not subject the camera to excessive shock, vibration or pressure by dropping or hitting it.

Failure to observe this precaution could cause water to seep inside the camera and result in camera malfunction.

- Do not use the camera deeper than 10 m (33 ft) underwater.
- Do not subject the camera to water pressure by exposing it to running water.
- Do not sit down with the camera in the pocket of your trousers.
Do not forcibly stuff the camera into a bag.

Notes on waterproof and dustproof performances

The camera is equivalent to IEC/JIS waterproof grade 8 (IPX8) and IEC/JIS dustproof grade 6 (IP6X) and enables shooting pictures underwater at a depth of 10 m (33 ft) for up to 60 minutes.*

This rating does not guarantee the waterproof performance of the camera or that the camera will be free from damage or trouble under all conditions.

* This rating indicates that the camera has been designed to withstand the specified water pressure for the specified period of time when the camera is used according to the methods defined by Nikon.

● If the camera is subjected to excessive shock, vibration or pressure by dropping or hitting it, the waterproof performance is not guaranteed.

- If the camera is exposed to shocks, it is recommended to consult your retailer or Nikon-authorized service representative to confirm the waterproof performance (charged service).
 - Do not use the camera deeper than 10 m (33 ft) underwater.
 - Do not subject the camera to water pressure by exposing it to the running water.
 - Your Nikon warrantee may not cover troubles caused by water seeping inside the camera due to improper handling of the camera.

- The waterproof performance of this camera is designed to work for fresh water and seawater only.
- The inner portion of this camera is not waterproof. Water seeping inside the camera could cause a malfunction.
- Accessories are not waterproof.
- Do not handle the camera with wet hands.
Do not insert a wet memory card or battery in the camera.
- If a liquid such as water droplets falls on the outside of the camera or inside of the battery-chamber/memory card slot cover, immediately wipe it off with a soft dry cloth. If the battery-chamber/memory card slot cover is opened or closed under wet conditions near a waterfront or underwater, this could cause water to seep inside the camera or result in camera malfunction.
Do not open or close the cover with wet hands. This could cause water to seep inside the camera or result in camera malfunction.
- If a foreign substance adheres to the outside of the camera or inside of the battery-chamber/memory card slot cover (in locations such as yellow waterproof packing, hinges, memory card slot, or terminals), immediately remove it with a blower or brush.
- If a foreign substance such as suntan oil, sunscreen lotion, hot spring, bath mix powder, detergent, soap, organic solvent, oil, or alcohol adheres to the camera, immediately wipe it off.
- Do not leave the camera in low temperature conditions in cold climate regions or in high-temperature conditions of 40°C (104°F) or more (in particular, a place exposed to direct sunlight, inside the cabin of a car, on a boat, on the beach, or near heating apparatus) for a long period of time. This could cause deterioration of the waterproof performance.

Before using the camera underwater

Remove the strap for land use before using the camera underwater.

1. Make sure that there are no foreign substances inside the battery-chamber/memory card slot cover.

- Any foreign substances such as sand, dust or hair inside the battery-chamber/memory card slot cover should be removed with a blower or brush.
- Any liquid such as water droplets inside the battery-chamber/memory card slot cover should be wiped off with a soft dry cloth.

2. Make sure that the waterproof packing of the battery-chamber/memory card slot cover is not cracked or deformed.

- The waterproof performance of waterproof packing may start to deteriorate after one year.
It is recommended to consult your retailer or Nikon-authorized service representative once a year to replace the waterproof packing with a new one (charged service).

3. Make sure that the battery-chamber/memory card slot cover is firmly closed.

- Rotate the battery-chamber/memory card slot cover latch until it clicks into place. Make sure that the thin cord of the camera strap does not get caught.
- Make sure that the latch indicator indicates the "Close" status.

Notes on using the camera underwater

Observe the following precautions to prevent water from seeping inside the camera.

- Do not dive into water deeper than 10 m (33 ft) with the camera.
- Do not continuously use the camera underwater for 60 minutes or more.
- Use the camera in the water temperature range from 0°C to 40°C (32°F to 104°F) when using it underwater.
Do not immerse the camera in hot water (such as bath or hot spring) that is higher than 40°C (104°F).
- Do not open or close the battery-chamber/memory card slot cover underwater.
- Do not subject the camera to shock when using it underwater.
Do not jump into water with the camera or subject it to high water pressure conditions such as rapids or waterfalls.
- This camera does not float in water. Make sure not to drop the camera underwater.

Cleaning after using the camera underwater

- After using the camera underwater, clean the camera within 60 minutes. If you leave the camera in wet conditions where salt particles, hot spring particles, or other foreign substances are adhered to it, this could cause damage, discoloration, corrosion, a bad smell or deterioration of waterproof performance.
- Before cleaning the camera, thoroughly remove water droplets, sand, salt particles, hot spring particles, or other foreign substances from your hands, body, and hair.
- It is recommended to clean the camera indoors to avoid a place where it could be exposed to water spray or sand.
- Do not open the battery-chamber/memory card slot cover until all foreign substances are washed off with water and all moisture is wiped off.

1. Keep the battery-chamber/memory card slot cover closed and wash off the camera with fresh water.

Immerse the camera in a shallow basin filled with freshwater for 10 minutes.

- If the buttons or switches do not operate properly, foreign substances may have adhered. Since this could cause a malfunction, immerse the camera in fresh water and shake it sufficiently in the water to remove the any foreign substances from the camera.
- When the camera is immersed in the water, a few air bubbles may come out from the water drain holes of the camera such as openings in the microphone or speakers. This is not a malfunction.

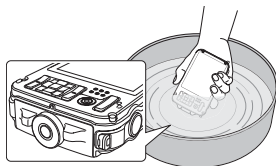

2. Wipe off water droplets with a soft cloth and dry the camera in the well-ventilated and shady place.

- Place the camera on a dry cloth to dry it.
Water will flow out from openings in the microphone or speakers.
- Do not dry the camera with hot air from a hair dryer or clothes dryer.
- Do not use chemicals (such as benzine, thinner, alcohol, or cleanser), soap, or neutral detergents.
If the waterproof packing or body of the camera becomes deformed, the waterproof performance will deteriorate.

3. After making sure that there are no water droplets on the camera, open the battery-chamber/memory card slot cover and gently wipe off any water or sand remaining inside the camera with a dry soft cloth.

- If you open the cover before the camera is thoroughly dried, water droplets may fall on a memory card or battery.
The water droplets may also seep inside the battery-chamber/memory card slot cover (in locations such as waterproof packing, hinges, memory card slot, or terminals).
If that happens, wipe the water off with a dry soft cloth.
- If the cover is closed when the inside is wet, this could cause condensation or malfunction.
- If the microphone or speaker openings are clogged with water droplets, the sound may deteriorate or become distorted.
 - Wipe the water off with a dry soft cloth.
 - Do not puncture the microphone or speaker openings with a sharp implement. If the inside of the camera is damaged, the waterproof performance will deteriorate.

Notes on operating temperature and humidity and condensation

The operation of this camera has been tested at temperatures from -10°C to +40°C (14°F to 104°F).

When you use the camera in cold climate regions, observe the following precautions. Keep the camera and spare batteries in a warm place before use.

- The performance of the batteries (number of pictures shot and shooting time) will drop temporarily.
- If the camera is in a very cold state, the performance may drop temporarily, for example, the monitor may be darker than normal immediately after the camera is turned on or residual images may be produced.
- When snow or water droplets adhere to the exterior of the camera, immediately wipe them off.
 - If the buttons or switches are frozen, they may not operate smoothly.
 - If the microphone or speaker openings are clogged with water droplets, the sound may deteriorate or become distorted.

- **Operating environmental conditions such as temperature and humidity may cause fogging (condensation) on the inside of the monitor or lens. This is not the camera malfunction or defect.**

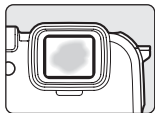

- **Environmental conditions that are likely to cause condensation inside of the camera**

Fogging (condensation) may occur on the inside of the monitor or lens in the following environmental conditions where there are sharp temperature changes or high humidity.

- The camera is suddenly immersed in low temperature underwater from high temperature on land.
- The camera is brought to a warm place such as inside a building from the cold climate outside.
- The battery-chamber/memory card slot cover is opened or closed in a high-humidity environment.

- **Clearing the fogging**

- Open the battery-chamber/memory card slot cover after turning off the camera in a place where the ambient temperature is stable (avoid any place that has high-temperature/high-humidity, sand or dust).

To clear the fogging, remove the battery and memory card, and leave the camera with the battery-chamber/memory card slot cover open to allow the camera to adjust to the ambient temperature.

- If the fogging does not clear, consult your retailer or Nikon-authorized service representative.

Notes on GPS/digital compass

● Map/location name data of this camera

Before using the GPS function, make sure to read "USER LICENSE AGREEMENT FOR MAP DATA AND LOCATION NAME DATA" (📄:9) and agree to the terms.

- The maps and location name information (Point of Interest: POI) are as of December 2010. The maps and location name information will not be updated.
- The details of geological formations are displayed simplistically according to the scale of a map. The scale of a map and level of detail of the location information vary depending on country and region.

If the latitude becomes higher, the horizontal and vertical scales displayed on the monitor vary, therefore displayed geological formations differ from the actual formations. Use the maps and location name information only as a guide.

● Notes on GPS/digital compass

- Do not operate the GPS/digital compass while you are driving a car.
- Use information (such as direction and distance) measured by the camera as a guideline only. This information cannot be used for navigation of an airplane, car, and person or land survey applications.
- When you use the camera for mountain climbing, trekking, or underwater, be sure to take a map, navigation device, or measuring instrument separately.
- When the camera lens is facing upward, the digital compass is not displayed.
- An individual may be identified from still pictures or movies that have been recorded with location information.

Observe caution when you transfer still pictures or movies recorded with location information, or GPS log files to a third party or upload them to a network such as the Internet where the public can view them.

Be sure to read "Disposing of Data Storage Devices" (📖).

● When the Record GPS data of the GPS options menu is On, the GPS function will continue to operate even when the camera is turned off.

- The electromagnetic waves emitted from the camera may affect the measuring instruments of an airplane or medical equipment.
When use of the camera is prohibited during airplane takeoffs and landings or inside a hospital, set the **Record GPS data** to **Off** and turn off the camera.
- When the **Record GPS data** is set to **On**, the battery will be drained, even when the camera is turned off.

● Using the camera overseas

- Before taking the camera with GPS function overseas for travel, consult your travel agency or embassy of the country you are visiting to confirm whether there is any restriction on use.





For example, you cannot record location information logs without permission from the government in China.

Set the **Record GPS data** of the **GPS options** menu to **Off**.









































- The GPS may not function properly in China and on the borders between China and neighbouring countries (as of December 2010).

Table of Contents





































Introduction	ii
Read This First.....	ii
Confirming the Package Contents.....	ii
About This Manual.....	iii
Information and Precautions.....	iv
For Your Safety	vi
WARNINGS	vi
Notices	ix
<Important> Shockproof, waterproof, dustproof, condensation, GPS/digital compass.....	xi
Notes on shockproof performance.....	xi
Notes on waterproof and dustproof performances	xi
Before using the camera underwater.....	xii
Notes on using the camera underwater.....	xiii
Cleaning after using the camera underwater.....	xiii
Notes on operating temperature and humidity and condensation	xv
Notes on GPS/digital compass.....	xvi
Parts of the Camera and Basic Operations	1
Parts of the Camera	2
The Camera Body.....	2
Controls Used in Shooting Mode.....	4
Controls Used in Playback Mode	5
The Monitor.....	6
Basic Operations.....	9
Switching Between Shooting Mode and Playback Mode	9
Using the Multi Selector.....	10
Using Menus (the MENU Button).....	11
Using the Action Button.....	13
Attaching the Camera Strap for Land Use	14
Use of the Filter Adapter and the Attachment Method	14

The Basics of Shooting and Playback	15
Preparation 1 Charge the Battery	16
Preparation 2 Insert the Battery	18
Preparation 3 Insert a Memory Card	20
Internal Memory and Memory Cards.....	21
Approved Memory Cards.....	21
Step 1 Turn the Camera On	22
Turning the Camera On and Off.....	23
Setting the Display Language, Date, and Time.....	24
Step 2 Select a Shooting Mode	26
Available Shooting Modes.....	27
Step 3 Frame a Picture	28
Using the Zoom.....	29
Step 4 Focus and Shoot	30
Step 5 Play Back Images	32
Changing How Images Are Displayed.....	33
Step 6 Delete Unwanted Images	34
Shooting Features	37
 (Easy Auto) Mode	38
Changing  (Easy Auto) Mode Settings.....	38
Scene Mode (Shooting Suited to Scenes)	39
Changing Scene Mode Settings.....	39
Characteristics of Each Scene.....	40
Special Effects Mode (Applying Effects When Shooting)	47
Characteristics of Each Special Effect.....	47
Changing Special Effects Mode Settings.....	48
Smart Portrait Mode (Shooting Smiling Faces)	49
Changing Smart Portrait Mode Settings.....	50
Options Available in the Smart Portrait Menu.....	50
 (Auto) Mode	51
Changing  (Auto) Mode Settings.....	51
Options Available in the Shooting Menu ( (Auto) Mode).....	51
Features That Can Be Set Using the Multi Selector	53
Available Functions.....	53
Flash Modes (Using the Flash).....	54
Using the Self-timer.....	56
Using Macro Mode.....	57
Exposure Compensation (Adjusting Brightness).....	58
Default Settings.....	59

Changing the Image Size (Image Mode)	61
Image Mode Settings (Image Size and Quality)	61
Features That Cannot Be Used Simultaneously	63
Using Face Detection	65
Using Skin Softening	66
Focus Lock	67
<hr/>	
Playback Features	69
Selecting Certain Types of Images for Playback	70
Available Playback Modes	70
Switching Between Playback Modes	70
Features Available in Playback Mode (Playback Menu)	71
Connecting the Camera to a TV, Computer, or Printer	73
Using ViewNX 2	74
Installing ViewNX 2	74
Transferring Images to the Computer	76
Viewing Images	77
Retouching Photographs	78
Editing Movies	78
Printing Images	78
<hr/>	
Recording and Playing Back Movies	79
Recording Movies	80
Changing Movie Recording Settings (Movie Menu)	83
Playing Back Movies	84
<hr/>	
Using GPS/Displaying Maps	85
Starting GPS Data Recording	86
Displaying Maps	88
When Using Shooting Mode	88
When Using Playback Mode	88
Changing the GPS or Electronic Compass Settings (Map Menu)	90
<hr/>	
General Camera Setup	93
The Setup Menu	94

Reference Section.....		1
Using Easy Panorama (Shooting and Playing back).....		2
Taking Pictures with Easy Panorama.....		2
Viewing Easy Panorama (Scroll).....		4
Using Panorama Assist.....		5
Playing and Deleting Images Captured Using Continuous Shooting Mode (Sequence).....		7
Playing Images in a Sequence.....		7
Deleting Images in a Sequence.....		8
Favorite Pictures Mode.....		9
Adding Images to Albums.....		9
Playing Back Images in Albums.....		10
Removing Images From Albums.....		10
Changing the Favorites Album Icon.....		11
Auto Sort Mode.....		12
List by Date Mode.....		14
Editing Images (Still Pictures).....		15
Editing Features.....		15
 Quick Retouch: Enhancing Contrast and Saturation.....		17
 D-Lighting: Enhancing Brightness and Contrast.....		17
 Glamour Retouch: Making Facial Skin Tones Softer, Face Smaller, or Eyes Larger.....		18
 Filter Effects: Applying Digital Filter Effects.....		19
 Small Picture: Reducing the Size of an Image.....		20
 Crop: Creating a Cropped Copy.....		21
Connecting the Camera to a TV (Playback on a TV).....		22
Connecting the Camera to a Printer (Direct Print).....		24
Connecting the Camera to a Printer.....		25
Printing Individual Images.....		26
Printing Multiple Images.....		27
Editing Movies.....		30
Extracting Only the Desired Portions of the Movie.....		30
The Smart Portrait Menu.....		32
Image Mode (Image Size and Quality).....		32
Skin Softening.....		32
Smile Timer.....		32
Blink Proof.....		33

The Shooting Menu (📷 (Auto) Mode)	🔍🔍34
Image Mode (Image Size and Quality)	🔍🔍34
White Balance (Adjusting Hue)	🔍🔍34
Continuous Shooting	🔍🔍36
ISO Sensitivity	🔍🔍37
AF Area Mode	🔍🔍38
Subject Tracking Mode (Focusing on a Moving Subject)	🔍🔍40
Autofocus Mode	🔍🔍41
The Playback Menu	🔍🔍42
🖨️ Print Order (Creating a DPOF Print Order)	🔍🔍42
🖼️ Slide Show	🔍🔍45
🔒 Protect	🔍🔍46
The Image Selection Screen	🔍🔍47
🔄 Rotate Image	🔍🔍48
🗣️ Voice Memo	🔍🔍49
📄 Copy (Copy Between Internal Memory and Memory Card)	🔍🔍50
📄 Sequence Display Options	🔍🔍51
🖼️ Choose Key Picture	🔍🔍51
The Movie Menu	🔍🔍52
Movie Options	🔍🔍52
Open with HS Footage	🔍🔍53
Recording Movies in Slow Motion and Fast Motion (HS Movie)	🔍🔍54
Autofocus Mode	🔍🔍56
Movie Light	🔍🔍56
Wind Noise Reduction	🔍🔍56
Map Menu	🔍🔍57
GPS Settings	🔍🔍57
Distance Units	🔍🔍58
Calculate Distance	🔍🔍59
Points of interest (POI) (Recording and Displaying Location Name Information)	🔍🔍60
Create Log (Record the log of moving information)	🔍🔍61
View Log (View the log on a map)	🔍🔍63
Electronic Compass	🔍🔍64

The Setup Menu	 66
Welcome Screen	 66
Time Zone and Date	 67
Monitor Settings.....	 70
Print Date (Imprinting Date and Time on Pictures)	 72
Vibration Reduction	 73
Motion Detection	 74
AF Assist.....	 75
Digital Zoom.....	 75
Sound Settings.....	 76
Action Control Response	 77
Auto Off	 77
Format Memory/Format Card.....	 78
Language.....	 78
TV Settings.....	 79
Blink Warning	 80
Assign Action Button.....	 81
Reset All	 81
Firmware Version.....	 84
File and Folder Names	 85
Optional Accessories	 87
Error Messages	 88
<hr/>	
Technical Notes and Index	 1
Caring for the Products	 2
The Camera	 2
The Battery.....	 4
The Battery Charger	 5
The Memory Cards.....	 6
Caring for the Camera	 7
Cleaning	 7
Storage.....	 8
USER LICENSE AGREEMENT FOR MAP DATA AND LOCATION NAME DATA	 9
Troubleshooting	 13
Specifications	 20
Supported Standards	 23
Index	 24



Parts of the Camera and Basic Operations

This chapter describes the parts of the camera and also explains the main functions of each part and basic camera operations.

Parts of the Camera	2
The Camera Body	2
Controls Used in Shooting Mode	4
Controls Used in Playback Mode	5
The Monitor	6
Basic Operations	9
Switching Between Shooting Mode and Playback Mode	9
Using the Multi Selector	10
Using Menus (the MENU Button)	11
Using the Action Button	13
Attaching the Camera Strap for Land Use	14
Use of the Filter Adapter and the Attachment Method	14

➔ If you want to start using the camera right away, see “The Basics of Shooting and Playback” (📖15).

Parts of the Camera

The Camera Body

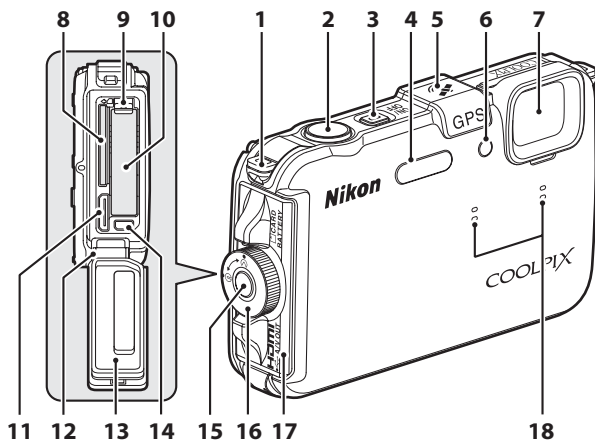



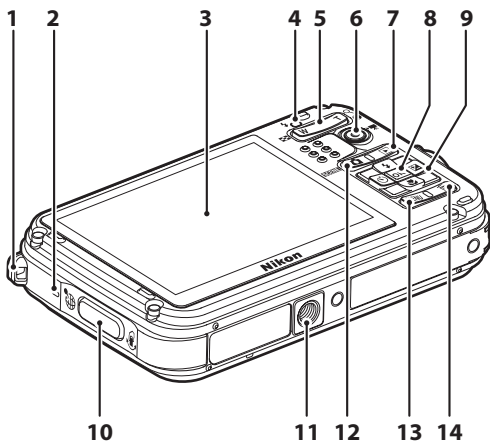







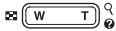

1	Eyelet for camera strap	14	10	Battery chamber	18
2	Shutter-release button	4, 30	11	HDMI mini connector (Type C)	73
3	Power switch/power-on lamp	23	12	Hinge	xii
4	Flash	54	13	Waterproofing packing	xiii
5	GPS antenna	86	14	USB/Audio video connector	73
6	Self-timer lamp	56	15	Battery-chamber/memory card slot cover latch release	18, 20
	AF-assist illuminator	95	16	Battery-chamber/memory card slot cover latch	18, 20
	Movie illuminator	83	17	Battery-chamber/ memory card slot cover	18, 20
7	Lens		18	Microphone (stereo)	71, 80
8	Memory card slot	20			
9	Battery latch	18, 19			

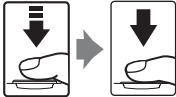











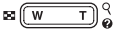



1	Eyelet for camera strap.....	14	8	OK (apply selection) button	10
2	Speaker	71, 84, 95	9	Multi selector	10
3	Monitor	6, 26	10	Action button : Display map.....	13
4	Flash lamp	54		: Action control	13
5	Zoom buttons	29	11	Tripod socket	
	W : Wide	29	12	(shooting mode) button	9, 26
	T : Tele.....	29	13	MENU (menu) button	11, 50, 51, 83
	: Thumbnail playback.....	33	14	(delete) button.....	34, 84
	: Playback zoom.....	33			
	: Help	39			
6	(movie-record) button.....	80			
7	(playback) button.....	9, 32			

Controls Used in Shooting Mode

Control	Name	Main Function	
	 (shooting mode) button	Change the shooting mode (displays the shooting-mode selection screen).	26
	Zoom buttons	Press T () (telephoto zoom position) to zoom in, and W () (wide-angle position) to zoom out.	29
	Multi selector	See “Using the Multi Selector” for more information.	10
	MENU (menu) button	Display and hides the menu.	11
	Shutter-release button	When pressed halfway (i.e., if you stop pressing when you feel resistance slightly): Set focus and exposure. When pressed all the way (i.e., if you press the button all the way down): Release the shutter.	30
	 movie-record) button	Start and stop movie recording.	80
	Playback button	Play back images.	9, 32
	Delete button	Delete the last image that was saved.	34
	Action button	<ul style="list-style-type: none"> Operate the function when the camera is shaken. Display the current location on a map. 	13 13

Controls Used in Playback Mode

Control	Name	Main Function	
	Playback button	<ul style="list-style-type: none"> When the camera is turned off, press and hold this button to turn the camera on in playback mode. Return to shooting mode. 	23 9
	Zoom buttons	<ul style="list-style-type: none"> Magnify the image with T (); display image thumbnails or the calendar with W (). Adjust the volume for voice memo and movie playback. 	33 71, 84
	Multi selector	See "Using the Multi Selector" for more information.	10
	Apply selection button	<ul style="list-style-type: none"> Display individual images of a sequence in full-frame. Scroll a picture recorded with easy panorama. Play back movies. Switch from image thumbnail or zoomed image display to full-frame playback mode. 	10 10 84 10
	MENU (menu) button	Display and hide the menu.	11
	Delete button	Delete images.	34
	 (shooting mode) button	Return to shooting mode.	-
	Shutter-release button		
	 (movie-record) button		
	Action button	Display the location of a picture taken on a map.	13

The Monitor

- The information that is displayed on the monitor during shooting and playback changes depending on the camera's settings and state of use. Information is displayed when the camera is first turned on and when you operate the camera, and turns off after a few seconds (when **Photo info** in **Monitor settings** (94) is set to **Auto info**).

Shooting Mode

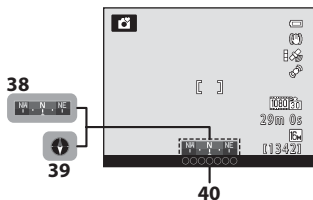
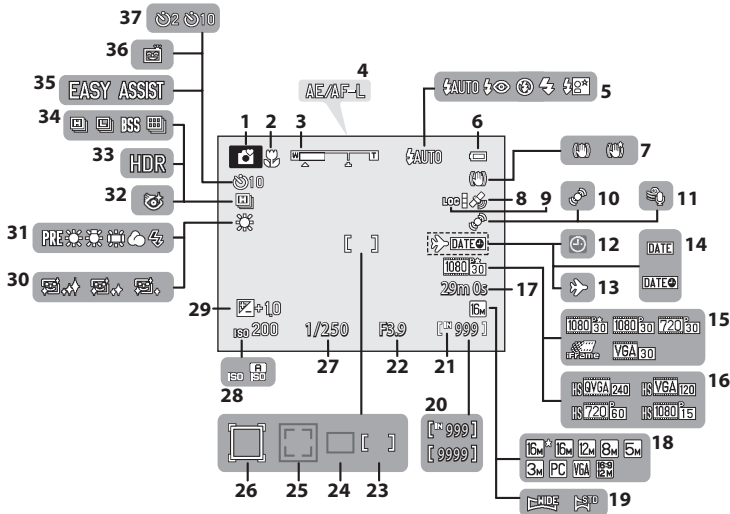

1	Shooting mode.....	26, 27	23	Focus area (for manual, center)	30, 52
2	Macro mode	57	24	Focus area (for auto)	52
3	Zoom indicator	29	25	Focus area (for face detection, pet detection)	46, 52, 65
4	AE/AF-L indicator.....	 56	26	Focus area (for subject tracking)	52
5	Flash mode	54	27	Shutter speed.....	30
6	Battery level indicator	22	28	ISO sensitivity.....	28, 52
7	Vibration reduction icon	94	29	Exposure compensation value.....	58
8	GPS reception	86	30	Skin softening.....	50
9	Log display.....	91	31	White balance	52
10	Motion detection icon.....	95	32	Blink proof icon	50
11	Wind noise reduction.....	83	33	Backlighting (HDR)	44
12	"Date not set" indicator.....	25, 94	34	Continuous shooting mode	52
13	Travel destination indicator.....	94	35	Panorama shooting.....	45
14	Print date.....	94	36	Smile timer	50
15	Movie options.....	83	37	Self-timer	56
16	HS movie options.....	83	38	Compass display (Direction gauge)	91
17	Movie length	80, 82	39	Compass display (Compass)	91
18	Image mode	61	40	Location name information (POI information).....	91
19	Easy panorama	45			
20	Number of exposures remaining (still pictures).....	22, 62			
21	Internal memory indicator	22			
22	Aperture value	30			

Playback Mode

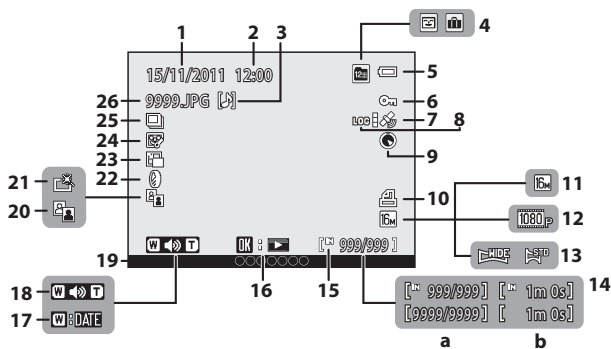

1	Date of recording.....	24
2	Time of recording.....	24
3	Voice memo indicator	71
	Album icon in favorite pictures mode	70
4	Category icon in auto sort mode.....	70
	List by date mode.....	70
5	Battery level indicator.....	22
6	Protect icon	71
7	GPS reception.....	86
8	Log display	91
9	Compass display (Compass)	91
10	Print order icon.....	71
11	Image mode.....	61
12	Movie options.....	83
13	Easy panorama indicator.....	45
14	(a) Current image number/total number of images.....	32
	(b) Movie length	84

15	Internal memory indicator	32
	Easy panorama playback guide	4
16	Sequence playback guide	7
	Movie playback guide	84
17	List by date guide	14
18	Volume indicator	71, 84
19	Location name information (POI information).....	91
20	D-Lighting icon	71
21	Quick retouch icon.....	71
22	Filter effects icon	71
23	Small picture	71, 21
24	Glamour retouch icon.....	71
25	Sequence display	72
26	File number and type.....	85

Basic Operations

Switching Between Shooting Mode and Playback Mode



The camera has two modes of operation: Shooting mode, which is used for taking pictures, and playback mode, which is used for viewing pictures.

Press the  (playback) button to switch to playback mode.

Press the  (shooting mode) button to switch to shooting mode.

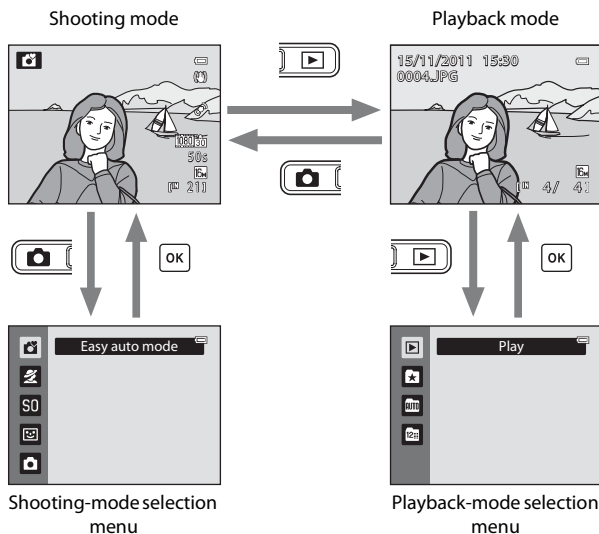
- While using playback mode, you can also switch to shooting mode by pressing the shutter-release button or the  (movie-record) button.



- If you press the  (shooting mode) button while the shooting mode is displayed, the shooting-mode selection menu is displayed, from which you can select one of the available shooting modes (📖26, 27).
- If you press the  (playback) button while the playback mode is displayed, the playback-mode selection menu is displayed, from which you can select one of the available playback modes (📖70).
- Use the multi selector to select a shooting mode or playback mode (📖10).

Using the Multi Selector

Operate by pressing up (▲), down (▼), left (◀), right (▶), or the **OK** button.

When Using Shooting Mode

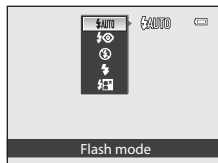
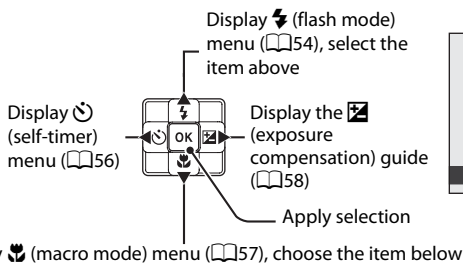

When Using Playback Mode

Select the previous image, move the displayed area when the image is magnified (☞33)



Select the next image, move the displayed area when the image is magnified (☞33)

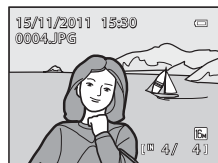

Plays back images of a sequence (☞67),
plays back panorama pictures (☞64),
plays back movies (☞84)*

* When displaying image thumbnails or when the image is magnified, this button switches the camera to full-frame playback mode.

When Displaying Menus

Select the item above

Select the item on the left, return display to the previous screen

Select the item below



Select the item on the right, display sub-menu (apply selection)

Apply selection

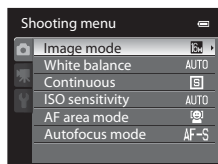

Using Menus (the MENU Button)

When the **MENU** button is pressed while the shooting screen or playback screen is displayed, the menu for the current mode is displayed. Once the menu is displayed, various settings can be changed.

Shooting mode

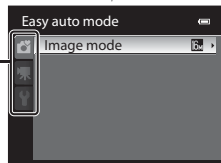
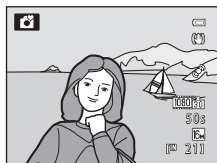

Playback mode

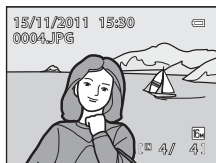

tab:
Displays available settings in the current shooting mode (□□27). Depending on the current shooting mode, the tab icon that is displayed will be different.

tab:
Displays the settings that deal with movie recording.

tab:
Displays the setup menu (basic camera setup) items.

tab:
Displays available settings in the current playback mode (□□70). Depending on the current playback mode, the tab icon that is displayed will be different.

tab:
Displays the setup menu (basic camera setup) items.

If Tabs Are Not Displayed

If you press the **MENU** button and the screen that allows you to change the image mode is displayed, press to display the tabs.

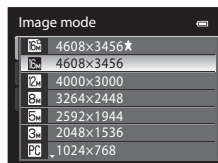

Switching Between Tabs

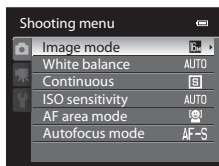

Press the multi selector ◀ to highlight the tab.

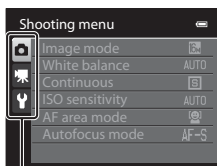

Press the multi selector ▲ or ▼ to select a tab, and press the OK button or ▶.

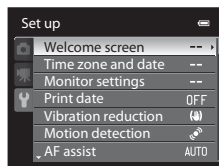

The selected menu is displayed.

Selecting Menu Items

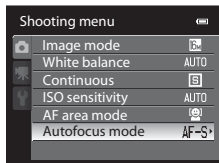

Press the multi selector ▲ or ▼ to select an item, and then press ▶ or the OK button.

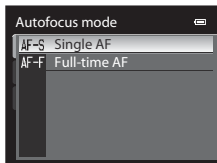

Press ▲ or ▼ to select an item and then press the OK button.

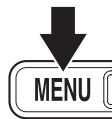

When you finish changing settings, press the MENU (menu) button to exit the menu.

Displayed When the Menu Contains Two or More Pages

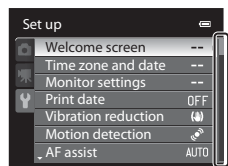

The scroll bar is displayed to indicate the current page.

Using the Action Button

When the action button is pressed, either of the following operations set in **Assign action button** of the setup menu (📖94) can be performed.

- Display maps.
- Perform the function by shaking the camera (action control).

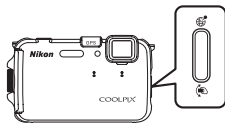

Display map

Display the current location on a map during shooting (only when **Record GPS data** in **GPS options** of the map menu (📖86) is set to **On**).

Display the shooting location of an image on a map during playback (only images on which position information is recorded).



Action control

As shown in the illustration, use your wrist and shake the camera for a single up/down or forward/backward stroke to perform the functions.



In the action menu, you can select the following options by shaking the camera up/down or forward/backward.

- Shooting mode: You can select the **Easy auto mode**, **Auto mode**, **Beach**, **Snow**, **Landscape** and **Underwater** modes.
- **Start movie recording**: Press the action button to begin shooting. Press the button again to exit shooting.
- **Quick playback**: Display images in full-frame playback mode.
- **Current position**: Display the current location on a map (only when **Record GPS data** in **GPS options** of the map menu (📖86) is set to **On**).

Press the action button to select the function.

In **Quick playback** or full-frame playback mode, shake the camera up/down to display the next image or forward/backward to display the previous image.

✓ Notes on Action Control

- When using the action control, be sure to hold the camera firmly by passing your hand through the camera strap.
- In the action control, only the action button, shutter-release button and power switch can be used.
- Action control may not perform well depending on how the camera is shaken. Change the Action control response (📖95).

Attaching the Camera Strap for Land Use

Remove the strap for land use before using the camera underwater.

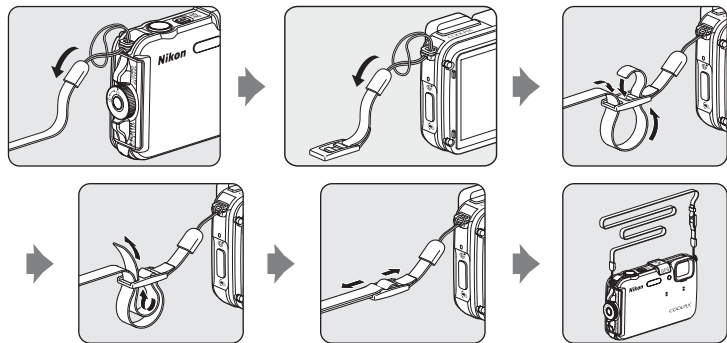

Use of the Filter Adapter and the Attachment Method

Use the included filter adapter to attach a commercially available ϕ 40.5 mm filter. The filter adapter is used in cases such as when attaching the color filter or polarizing filter.

Attach the filter adapter to the camera strap using a cord.

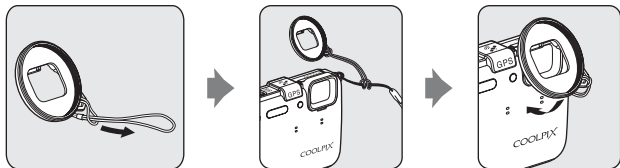

✓ Note on Using the Filter Adapter

Lights of AF-assist illuminator/movie illuminator (📖2) are blocked out when the filter adapter is attached. Set AF illuminator (📖95) and movie illuminator (📖83) to **Off** when using the filter adapter.

The Basics of Shooting and Playback

Preparation

Preparation 1 Charge the Battery	16
Preparation 2 Insert the Battery	18
Preparation 3 Insert a Memory Card	20



Shooting

Step 1 Turn the Camera On	22
Setting the Display Language, Date, and Time (First Use Only)	24
Step 2 Select a Shooting Mode	26
Step 3 Frame a Picture	28
Step 4 Focus and Shoot	30



Playback

Step 5 Play Back Images	32
Step 6 Delete Unwanted Images	34

Preparation 1 Charge the Battery

- 1** Connect the power cable in the order indicated below.

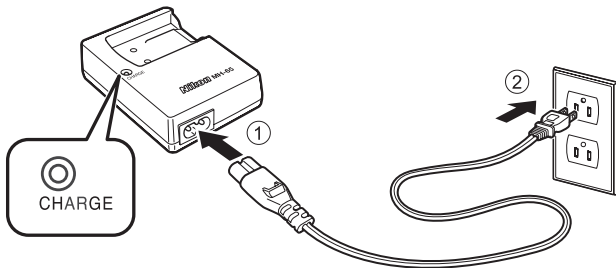

- 2** Insert the battery into the battery charger by sliding the battery forward (1), and press down until it locks into place (2).

- CHARGE lamp starts blinking when charging starts.
- A fully-exhausted battery charges in about two hours and 30 minutes.
- When charging is complete, the CHARGE lamp stops blinking.
- See "Understanding CHARGE Lamp" (17).

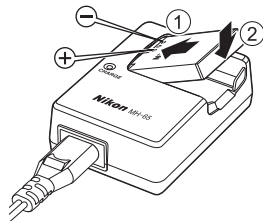

- 3** When charging is complete, remove the battery, and then unplug the charger.

Understanding CHARGE Lamp

Status	Description
Blinks	Battery charging.
On	Battery fully charged.
Flickers	<ul style="list-style-type: none"> The battery is not inserted correctly. Remove the battery and reinsert it into the battery charger so that the battery is lying flat. The ambient temperature is not suited to charging. Charge the battery indoors with an ambient temperature of 5°C to 35°C (41°F to 95°F) before use. The battery is faulty. Stop charging immediately, unplug the charger, and take both the battery and charger to your retailer or Nikon-authorized service representative.

Notes on Battery Charger

- Be sure to read and follow the warnings of “For Your Safety” (📖vi) thoroughly before using the Battery Charger.
- Be sure to read and follow the warnings for “The Battery Charger” (🔋5) thoroughly before using the battery.

Notes on Battery

- Be sure to read and follow the warnings of “For Your Safety” (📖vi) thoroughly before using the battery.
- Be sure to read and follow the warnings for “The Battery” (🔋4) thoroughly before using the battery.

AC Power Supply

- If the AC Adapter EH-62F (available separately) (🔌87) is used, power is included to the camera from an electrical outlet, enabling taking and playing back pictures.
- Do not, under any circumstances, use an AC Adapter other than the EH-62F. Failure to observe this precaution could result in overheating or in damage to the camera.

Preparation 2 Insert the Battery

- 1 Press the battery-chamber/memory-card slot cover latch release (①) and rotate the battery-chamber/memory-card slot cover latch (②) to open the cover (③).

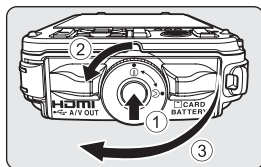

- 2 Insert the battery.

- Use the battery to push the orange battery latch in the direction shown (①), and fully insert the battery (②).
- When the battery is fully inserted, the battery latch locks it in place.

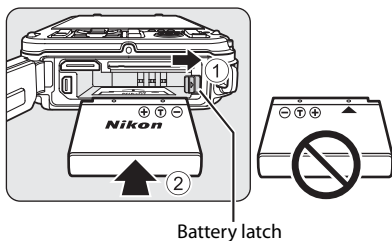

Battery latch

✓ Inserting the Battery Correctly

Inserting the battery upside down or backwards could damage the camera. Be sure to confirm that the battery is in the correct orientation.

- 3 Push the battery chamber/memory card slot-cover to the camera (①) and rotate the battery chamber/memory card slot-cover latch until the cover is locked (②).

- Rotate the battery-chamber/memory-card slot cover latch until it clicks into place.

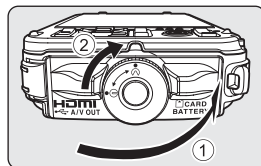

✓ Note on Closing the Cover without Getting the Camera Strap or Cord Caught

If the camera strap or filter adapter's cord gets caught in the battery-chamber/memory card slot cover when it is closed, the cover could be damaged. Before closing the battery-chamber/memory card slot cover, make sure that the strap or cord does not get caught in it.

Removing the Battery

Before opening the battery-chamber/memory card slot cover, turn the camera off (🔌23) and confirm that the power-on lamp and the monitor are off.

To eject the battery, open the battery-chamber/memory card slot cover and slide the orange battery latch in the direction shown (①). Then, remove the battery straight (②).

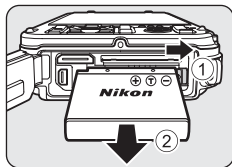

✔ High Temperature Caution

The camera, battery, and memory card may be hot immediately after using the camera. Observe caution when removing the battery or memory card.

✔ Opening/Closing the Battery Chamber/Memory Card Slot-Cover

Do not open and close the battery chamber/memory card slot-cover in a sandy or dusty environment or with wet hands. If the cover is closed without removing foreign particles, water may seep inside the camera or the camera may become damaged.

- If foreign particles get inside the cover or camera, immediately remove them with a blower or brush.
- If liquid such as water gets inside the cover or camera, immediately wipe it off with a soft and dry cloth.

Preparation 3 Insert a Memory Card

- 1 Confirm that the power-on lamp and the monitor are turned off and open the battery-chamber/memory card slot cover.

- Be sure to turn off the camera before opening the cover.

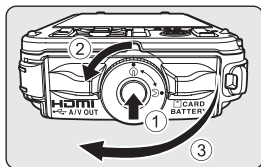

- 2 Insert the memory card.

- Slide the memory card until it clicks into place.

✓ Inserting the Memory Card Correctly

Inserting the memory card upside down or backwards could damage the camera or the memory card. Be sure to confirm that the memory card is in the correct orientation.

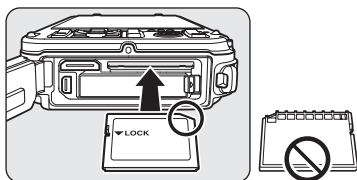

- 3 Close the battery-chamber/memory card slot cover.

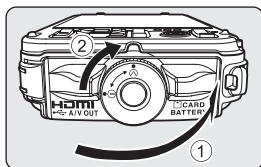

✓ Note on Closing the Cover without Getting the Camera Strap or Cord Caught

If the camera strap or filter adapter's cord gets caught in the battery-chamber/memory card slot cover when it is closed, the cover could be damaged. Before closing the battery-chamber/memory card slot cover, make sure that the strap or cord does not get caught in it.

✓ Formatting a Memory Card

- The first time you insert a memory card that has been used in another device into this camera, be sure to format it with this camera.
- **All data stored on a memory card is permanently deleted when the card is formatted.** Be sure to make copies of any data you wish to keep before formatting the memory card.
- To format a memory card, insert the memory card into the camera and press the **MENU** button, and select **Format card** from the setup menu (📖94).

✓ Note on Memory Cards

Refer to the documentation included with the memory card, as well as "The Memory Cards" (🔍6) in "Caring for the Products".

Removing Memory Cards

Before opening the battery-chamber/memory card slot cover, turn the camera off and confirm that the power-on lamp and the monitor are off.

Press the memory card in lightly with your finger (①) to partially eject it, and then pull it out straight (②).

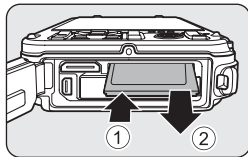

High Temperature Caution

The camera, battery, and memory card may be hot immediately after using the camera. Observe caution when removing the battery or memory card.

Internal Memory and Memory Cards

Camera data, including images and movies, can be saved in either the camera's internal memory (approximately 83 MB) or on a memory card. To use the camera's internal memory for shooting or playback, first remove the memory card.

Approved Memory Cards

The following Secure Digital (SD) memory cards have been tested and approved for use in this camera.

- When recording a movie onto a memory card, a memory card with an SD speed class of Class 6 or higher is recommended. If the transfer speed of the card is slow, the movie recording may end unexpectedly.

	SD memory cards ¹	SDHC memory cards ²	SDXC memory cards ³
SanDisk	2 GB	4 GB, 8 GB, 16 GB, 32 GB	64 GB
TOSHIBA	2 GB	4 GB, 8 GB, 16 GB, 32 GB	64 GB
Panasonic	2 GB	4 GB, 8 GB, 12 GB, 16 GB, 32 GB	48 GB, 64 GB
Lexar	-	4 GB, 8 GB, 16 GB, 32 GB	-

1 Before using a card reader or similar device, check that the device supports 2 GB cards.

2 SDHC-compliant. Before using a card reader or similar device, check that the device supports SDHC.

3 SDXC-compliant. Before using a card reader or similar device, check that the device supports SDXC.



- Contact the manufacturer for details on the above cards.

Step 1 Turn the Camera On

1 Press the power switch to turn on the camera.

- **If you are turning the camera on for the first time, see “Setting the Display Language, Date, and Time”** (📖24).
- The monitor is turned on.

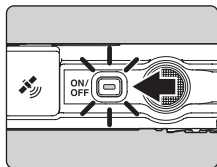

2 Check the battery level and number of exposures remaining.

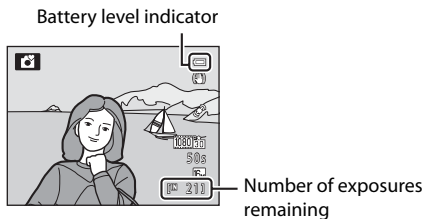

Battery Level

Display	Description
	Battery level high.
	Battery level low. Prepare to charge or replace the battery.
Battery exhausted.	Cannot take pictures. Charge or replace the battery.

Number of Exposures Remaining

The number of exposures remaining is displayed.

- When a memory card is not inserted, is displayed and images are recorded to the internal memory (approx. 83 MB).
- The number of pictures that can be stored depends on the remaining capacity of the internal memory or memory card, and the image quality and image size (image mode) (📖61).
- The number of exposures remaining shown in the illustration differs from the actual value.



Turning the Camera On and Off

- When the camera is turned on, the power-on lamp (green) lights, and the monitor is turned on (the power-on lamp turns off when the monitor is turned on).
- To turn off the camera, press the power switch. Both the monitor and the power-on lamp are turned off.
- Hold down the  (playback) button to turn on the camera in playback mode.

Power Saving Function (Auto Off)

If no operations are performed for a while, the monitor will be turned off, the camera will enter standby mode, and the power-on lamp will blink. If no operations are performed for another three minutes, the camera will turn off automatically.

While the camera is in standby mode, the monitor is turned on again when any of the following buttons is pressed.

→ Power switch, shutter-release button, , (shooting mode) button, , (playback) button, or  movie-record) button

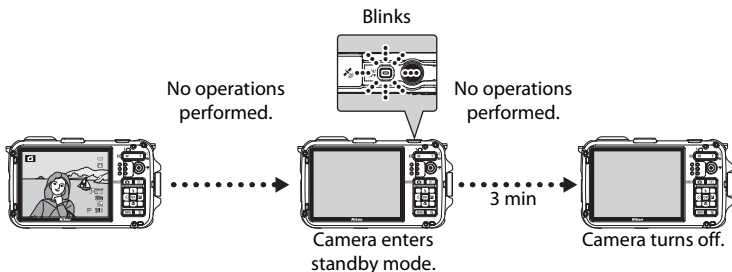

- The time that elapses before the camera enters standby mode can be changed using the **Auto off** setting in the setup menu (94).
- In the default setting, the camera enters standby mode in about five minutes when you are using shooting mode or playback mode.
- If you are using the optional AC Adapter EH-62F, the camera enters standby mode after 30 minutes.

Setting the Display Language, Date, and Time

Dialogs for language selection and camera clock setting are displayed the first time the camera is turned on.

- 1 Press the multi selector **▲** or **▼** to choose the desired language and press the **OK** button.

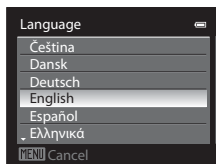
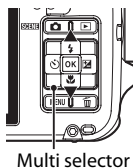

- 2 Press **▲** or **▼** to choose **Yes** and press the **OK** button.

- To cancel setting, select **No**.

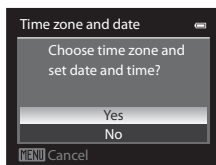

- 3 Press **◀** or **▶** to select your home time zone (Time zone), and press the **OK** button.

- See "Daylight Saving Time" (📖25) for more information about daylight saving time.

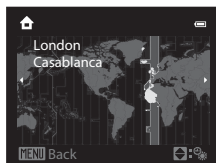
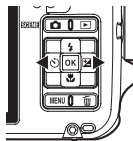

- 4 Press **▲** or **▼** to choose the date display order and press the **OK** button or **▶**.

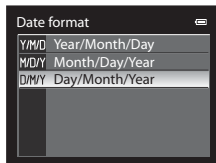

5 Press ▲, ▼, ◀ or ▶ to set date and time, and press the **OK** button.

- To choose an item: Press ▶ or ◀ (selected in the following order: **D** (day) → **M** (month) → **Y** (year) → **hour** → **minute**).
- To set the contents: Press ▲ or ▼.
- Finish setting: Choose **minute**, and press the **OK** button or ▶.
- After finishing the setting, the shooting screen is displayed.

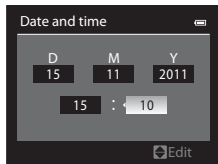

Daylight Saving Time

If daylight saving time is in effect, press the multi selector ▲ to enable the daylight saving time function while setting the region in step 3.

When the daylight-saving time function is enabled, ☀ is displayed at the top of the monitor.

Press ▼ to disable the daylight saving time function.



Changing the Language Setting and the Date and Time Setting

- You can change these settings using the **Language** and **Time zone and date** setting in the **Y** setup menu (📖94).
- In the **Time zone** setting of **Time zone and date** in **Y** setup menu, when the daylight saving time function is enabled, the camera's clock is set forward by one hour, and when disabled, set back by one hour. When the ▶ travel destination is set, the camera automatically calculates the time difference between the travel destination and the 🏠 home time zone, and saves images using the date and time of the travel destination.
- If you exit without setting the date and time, ⌚ will blink when the shooting screen is displayed. Use the **Time zone and date** setting in the setup menu (📖94) to set the date and time.

The Clock Battery

- The camera's clock is powered by a backup battery that is separate from the camera's main battery.
- The backup battery charges after about ten hours of charging when the main battery is inserted into the camera or when the camera is connected to an optional AC adapter, and can store the set date and time for several days.
- If the camera's backup battery becomes exhausted, the date and time setting screen is displayed when the camera is turned on. Set the date and time again. See step 2 of "Setting the Display Language, Date, and Time" (📖24) for more information.

Imprinting the Shooting Date in Printed Images

- Set the date and time before shooting.
- You can imprint the shooting date in images as they are captured by setting **Print date** in the setup menu (📖94).
- If you want the shooting date to be printed without using the **Print date** setting, print using the ViewNX 2 software (📖74).

Step 2 Select a Shooting Mode

1 Press the button.

- The shooting-mode selection menu which allows you to select the desired shooting mode, is displayed.







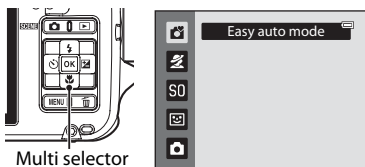



2 Press the multi selector or to select a shooting mode.

-  Easy auto mode is used in this example. Select  **Easy auto mode**.



3 Press the button.





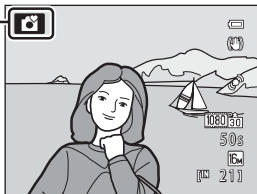











- The camera switches to  (easy auto) mode. The shooting mode icon changes to , , , , ,  or  according to the subject and composition.

Shooting mode icon 







- See “The Monitor” (6) for more information.
- The selected shooting mode is saved even if the power is turned off.

Available Shooting Modes

	Easy auto mode 📖38
	By simply framing a picture, the camera automatically selects the optimum scene mode for simple shooting.
	Scene 📖39
	Camera settings are automatically optimized for the selected scene. <ul style="list-style-type: none"> To select a scene, first display the shooting-mode selection menu and then press the multi selector . Select the desired scene by pressing , , , or , and then press the  button.
S0	Special effects 📖47
	Effects can be applied to pictures during shooting. Six different effects are available. <ul style="list-style-type: none"> To select an effect, press the multi selector  in the shooting-mode selection menu, press , , , or  to select effects, and press the  button.
	Smart portrait 📖49
	The camera detects smiling faces and automatically releases the shutter even if you don't press the shutter-release button (smile timer). The skin softening function makes facial skin tones softer.
	Auto mode 📖51
	Basic shooting operations can be performed. Also, change the settings for the options in the shooting menu (📖51) according to the shooting conditions and the kind of images you want to capture.

Features That Are Available in Shooting Mode

- The functions of the multi selector , , , or  can be set. See “Features That Can Be Set Using the Multi Selector” (📖53) for more information.
- Press the **MENU** button to display the menu for the selected shooting mode. See “Shooting Features” (📖38) for more information about the settings available in the menu for the current shooting mode.

Action Control

When **Assign action button** in the setup menu (📖94) is set to **Action control**, the shooting mode can be switched by action control (📖13).

Step 3 Frame a Picture

1 Ready the camera.

- Keep your fingers, hair, camera strap and other objects away from the lens, flash, AF-assist illuminator and microphone.
- To shoot in the “tall” orientation, hold the camera so that the flash is above the lens.

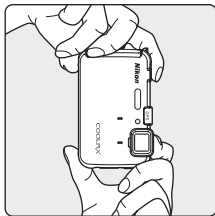
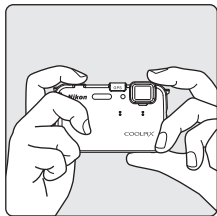

2 Frame the picture.

- When the camera determines a scene mode, the shooting mode icon changes (📖26).
- When the camera detects a face, a yellow double border (focus area) is displayed. See “Using Face Detection” (📖65) for more information.
- When non-human subjects are photographed, or a subject with which no face can be detected is framed, the focus area is not displayed. Position the main subject near the center of the monitor.

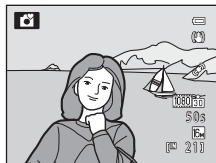

✓ Notes on 📷 (Easy Auto) Mode

- When the digital zoom is in effect, the shooting mode is set to 📷.
- Depending upon shooting conditions, the camera may not select the desired scene mode. In this case, select another shooting mode.

✎ ISO Sensitivity

ISO (ISO sensitivity, 📖7) may be displayed on the shooting screen. When **ISO** is displayed, the ISO sensitivity is automatically raised.

✎ Using a Tripod

- In the following situations, use of a tripod is recommended to stabilize the camera during shooting and to avoid the effects of camera shake.
 - When shooting in dark surroundings or when flash mode (📖54) is set to Ⓜ (off)
 - When shooting at the telephoto zoom position
- To take a picture with the camera attached to a tripod, set **Vibration reduction** in the setup menu (📖94) to **Off**.

Using the Zoom

Press the zoom buttons to activate the optical zoom.

- The subject fills a larger area of the frame: Press **T** (zoom in).
- The area visible increases in the frame: Press **W** (zoom out).
- When the power is turned on, the zoom is at the maximum wide-angle position.
- A zoom position is displayed at the top of the monitor when the zoom button is pressed.

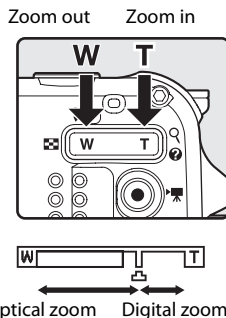

Digital Zoom

If the zoom button **T** is pressed continuously when optical zoom is set at the maximum telephoto zoom position (maximum optical zoom), digital zoom will be activated.

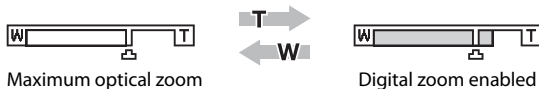

Digital zoom can magnify the subject up to about 4x beyond the maximum magnification of the optical zoom.



- The focus will be at the center of the frame and the focus area will not be displayed when the digital zoom is in effect.

Digital Zoom and Interpolation

Unlike the optical zoom, the digital zoom uses a digital imaging process known as interpolation to magnify images, resulting in slight deterioration of image quality depending on the image mode (□61) and digital zoom magnification.

Interpolation is applied at zoom positions beyond . When the zoom is increased beyond the  position, interpolation is initiated and the zoom indicator also turns yellow.

 moves right as the image size becomes smaller, allowing you to confirm the zoom position that can be used to capture still images without image degradation before shooting at the current image mode setting.



When the image size is small

- Using **Digital zoom** in the setup menu (□94), it is possible to set the digital zoom so that it does not operate.

Step 4 Focus and Shoot

1 Press the shutter-release button halfway, i.e., press the button slightly until you feel resistance.

- When you press the shutter-release button halfway, the camera sets the focus and exposure (shutter speed and aperture value). Focus and exposure remain locked while the shutter-release button is pressed halfway.
- When a face is detected:
Focuses on the face around which a double border (focus area) is displayed (see “Using Face Detection” (📖65) for more information). When the camera has focused on that face, the double border will turn green.

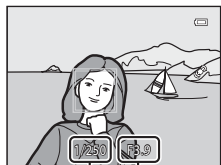

Aperture value
Shutter speed

- When a face is not detected:
Focuses on the focus area selected by the camera according to the shooting scene. When the subject is in focus, the focus area (active focus area) lights in green (maximum of nine areas).

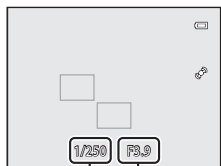

Aperture value
Shutter speed

- When the digital zoom is in effect, the camera focuses on the subject at the center of the frame, and the focus area is not displayed. When the subject is in focus, the focus indicator (📖6) lights in green.
- When the shutter-release button is pressed halfway and the focus area or focus indicator may blink red, the camera is unable to focus. Change the composition and press the shutter-release button halfway again.

2 Press the shutter-release button all the way, i.e., press the button the rest of the way down.

- The shutter is released and the picture is recorded.
- If you press the shutter-release button with too much force, the camera may shake, causing images to be blurred. Press the button gently.



During Recording

- While the indicator showing the number of exposures remaining is blinking, images are being recorded. **Do not open the battery-chamber/memory card slot cover.** Cutting the power or removing the memory card in these circumstances could result in loss of data or in damage to the camera or card.
- Depending on the settings or shooting conditions, the image recording time may take longer than usual (🔧16).

Autofocus

Autofocus may not perform as expected in the following situations. In some rare cases, the subject may not be in focus despite the fact that the active focus area lights in green:

- Subject is very dark
- Objects of sharply differing brightness are included in the scene (e.g. the sun behind the subject makes that subject appear very dark)
- No contrast between the subject and surroundings (e.g. a portrait subject, wearing a white shirt, is standing in front of a white wall)
- Several objects are at different distances from the camera (e.g., an animal inside a cage)
- Subjects that repeat the same pattern (e.g., as window blinds or buildings lined with windows of the same shape)
- Subject is moving rapidly

In these situations, try pressing the shutter-release button halfway again to refocus, several times if necessary. If the subject is still not in focus, select auto mode and use focus lock (📖67) to take the picture by first focusing on an object that is at the same distance from the camera as the desired subject.

AF-assist Illuminator and Flash

In dark places, the AF-assist illuminator (📖95) may light when the shutter-release button is pressed halfway, and the flash (📖54) may fire when the shutter-release button is pressed all the way.

To Make Sure You Do Not Miss a Shot

If you are concerned that you might miss a shot, press the shutter-release button all the way without first pressing it halfway.







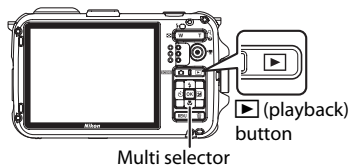

Step 5 Play Back Images

1 Press the (playback) button.

- When you switch from shooting mode to playback mode, the last image saved will be displayed in full-frame playback mode.





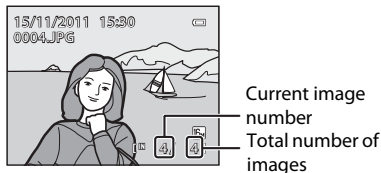

2 Use the multi selector to view the previous and next images.



- To view previous images:  or 
- To view next images:  or 
- The image can be also selected by using action control () and shaking the camera.
- To return to shooting mode, press the  button, the shutter-release button, or the  button.
- To play back images that are saved in the internal memory, remove the memory card.  is displayed around "current image number/total number of images" on the playback screen.



Viewing Pictures

- Pictures taken using face detection () or pet detection () will be rotated automatically when displayed in full-frame playback mode according to the orientation of the face (except for pictures taken when **Continuous** in the shooting menu () was set).
- When pictures taken with the continuous shooting feature are displayed, each series of images is treated as a group, and only the group's "key picture" is displayed (see "Playing Images Captured Using Continuous Shooting Mode (Sequence)" () for more information).
- Images may be displayed at low resolution immediately after switching to the previous or next image.

More Information

- See "Features Available in Playback Mode (Playback Menu)" () for more information.
- See "Selecting Certain Types of Images for Playback" () for more information.

Changing How Images Are Displayed

When using playback mode, you can change how images are displayed by pressing the zoom button **W** (📷)/**T** (🔍).

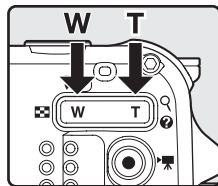

Playback Zoom

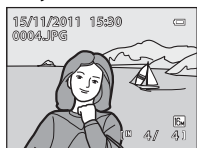

Image is displayed in full-frame playback mode.

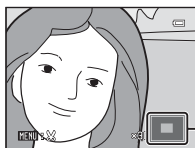
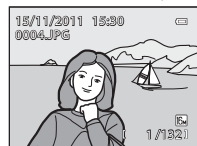

Image is zoomed in.

- To adjust the zoom ratio by pressing the zoom button **W** (📷)/**T** (🔍). Images can be zoomed up to 10x.
- To view a different area of the image, press the multi selector ▲, ▼, ◀, or ▶.
- Pictures taken using face detection (📖65) or pet detection (📖46) are enlarged at the center of the face that was detected during shooting (except for pictures taken when **Continuous** in the shooting menu (📖51) was set). If more than one face is detected when the image was captured, use ▲, ▼, ◀, or ▶ to display a different face. To zoom in on an area of the image where there are no faces, first change the zoom ratio, and then press ▲, ▼, ◀, or ▶.
- You can crop the displayed area of the image and save it as a separate image by pressing the **MENU** button (📖21).
- Press the **OK** button to return to full-frame playback mode.

Thumbnail Playback, Calendar Display



Full-frame Playback Mode



Image Thumbnail Display
(4, 9 and 16 images per screen)





Calendar Display

- You can view several images on one screen, making it easy to find the image you want.
- You can change the number of images displayed by pressing the zoom button **W** (📷)/**T** (🔍).
- Press the multi selector ▲, ▼, ◀, or ▶ to select an image and then press the **OK** button to display that image in full-frame playback mode.
- When 16 images are displayed, press the zoom button **W** (📷) to switch to calendar display.
- While using calendar display mode, press the multi selector ▲, ▼, ◀, or ▶ to select a date and then press the **OK** button to display the first picture taken on that day.

Step 6 Delete Unwanted Images



- 1 Press the  button to delete the image currently displayed on the monitor.



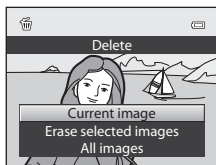

- 2 Press the multi selector  or  to select the desired deletion method and press the  button.

- **Current image:** Only the current image is deleted.
- **Erase selected images:** Multiple images can be selected and deleted. See “Operating the Erase Selected Images Screen” (📖35) for more information.
- **All images:** All images are deleted.
- To exit without deleting, press the **MENU** button.



- 3 Press  or  to select **Yes** and press the  button.



- Deleted images cannot be recovered.
- To cancel, press  or  to select **No** and press the  button.



Notes on Deletion

- Deleted images cannot be recovered. Transfer important images to a computer before deleting them.
- Protected images cannot be deleted (📖71).

Deleting Images in a Sequence

- When images are taken with continuous shooting, each series of images is treated as a group (pictures in a sequence) and only the group's “key picture” is displayed in the default setting (📷7).
- When the  button is pressed during displaying only the key picture, all images in the sequence, including the key picture, are deleted.
- To delete each picture in a sequence, before pressing the  button, press the  button to display each image in the sequence individually.

Deleting the Last Image Captured While in Shooting Mode

When using shooting mode, press the  button to delete the last image that was saved.

Operating the Erase Selected Images Screen

- 1 Press the multi selector ◀ or ▶ to select an image to be deleted, and then press ▲ to display ✓.
 - To cancel the selection, press ▼ to remove ✓.
 - Press the zoom button (📖29) T (🔍) to switch back to full-frame playback mode or W (🖼️) to display thumbnails.



- 2 Add ✓ to all images that you want to delete and then press the OK button to apply the selection.
 - A confirmation dialog is displayed. Follow the instructions displayed on the monitor.

Selecting Certain Types of Images for Deletion

When using favorite pictures mode, auto sort mode, or list by date mode (📖70), images in the same album or category, or pictures taken on the same date can be deleted.



A series of horizontal dashed lines spanning the width of the page, intended for handwriting practice. There are 15 lines in total, starting from the top right and extending to the left edge of the page.

Shooting Features

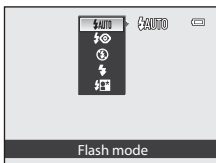
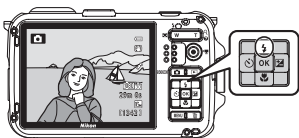
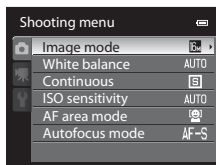
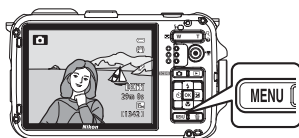
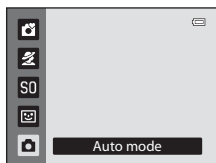
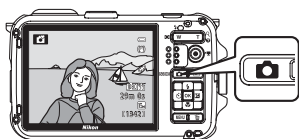

This chapter describes each of the camera's shooting modes and the features that are available when using shooting mode.

By referring to this information, you will learn how to select different shooting modes and adjust settings according to the shooting conditions and the kind of images you want to capture.



(Easy Auto) Mode

When you frame a picture, the camera automatically selects the optimum scene for simple shooting.

Display the shooting screen →  (shooting mode) button →  (Easy auto) mode
( 26, 27)

When the camera is pointed at the subject, the camera automatically switches to the setting that is suited for the following shooting mode.

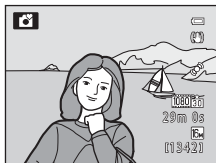

- : Portrait
- : Landscape
- : Night portrait
- : Night landscape
- : Close-up
- : Backlighting
- : Underwater*
- : Other scenes

* The camera is switched to underwater mode when it is lowered into water.

- The camera automatically selects the focus area for autofocus in accordance with the composition. The camera detects and focuses on faces (see “Using Face Detection” ( 65) for more information).

Notes on Easy Auto Mode





- When the digital zoom is in effect, the shooting mode is set to .
- The desired scene mode may not be selected in certain conditions. In this case, select another shooting mode.

Note after Taking the Camera out of the Water

After taking the camera out of water, sometimes it may not automatically switch to another scene from underwater mode.

Gently brush any water droplets with your hand from the camera or wipe it off with a soft and dry cloth. See “Cleaning after using the camera underwater” ( xiii) for more information on caring for the camera.

Changing (Easy Auto) Mode Settings



- See “Features That Can Be Set Using the Multi Selector” ( 53) for more information on flash mode ( 54), self-timer ( 56), and exposure compensation ( 58).
- Functions that can be set using the **MENU** button:
The combination of image size and image quality (image mode) can be set using the **MENU** button ( 61).

Features That Cannot Be Used Simultaneously



















These features may not be used in combination with certain features ( 63).

Scene Mode (Shooting Suited to Scenes)

When one of the following scenes is selected, pictures are captured using settings that are optimized for the selected scene.

Display the shooting screen →  (shooting mode) button →  (the second icon from the top*) →  → select a scene (📖26, 27)

* The icon for the last scene mode selected is displayed. The default setting is  (portrait).

 Portrait (📖40)	 Close-up (📖42)
 Landscape (📖40)	 Food (📖43)
 Sports (📖40)	 Museum (📖43)
 Night portrait (📖41)	 Fireworks show (📖43)
 Party/indoor (📖41)	 Black and white copy (📖43)
 Beach (📖41)	 Backlighting (📖44)
 Snow (📖41)	 Panorama (📖45)
 Sunset (📖41)	 Pet portrait (📖46)
 Dusk/dawn (📖42)	 Underwater (📖46)
 Night landscape (📖42)	

View a Description of Each Scene (Help Information)

Select the desired scene from the scene selection screen and press the zoom button (📖29) **T** (🔍) to view a description of that scene (help). To return to the original screen, press the zoom button **T** (🔍) again.

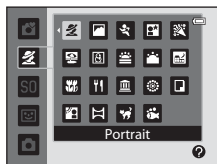



Changing Scene Mode Settings

- See “Features That Can Be Set Using the Multi Selector” (📖53) for more information. The setting varies with scene mode. See “Default Settings” (📖59) for more information.
- Functions that can be set using the **MENU** button:
The combination of image size and image quality (image mode) can be set by pressing the **MENU** button in shooting mode (📖61, except **Easy panorama**).

Features That Cannot Be Used Simultaneously



These features may not be used in combination with certain features (📖63).

Characteristics of Each Scene

Use of a tripod is recommended in scenes with which  is indicated. Set **Vibration reduction** in the setup menu (94) to **Off** when using a tripod to stabilize the camera.

Portrait

Use this mode for portraits.

- The camera detects and focuses on a face (see “Using Face Detection” (65) for more information).
- After the skin softening feature makes the subject’s skin appear smoother, the camera records the image (66).
- If no faces are detected, the camera focuses on the subject at the center of the frame.
- The digital zoom is not available.

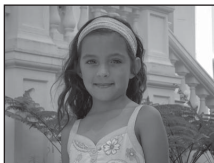

Landscape

Use this mode for vivid landscapes and cityscapes.

- When the shutter-release button is pressed halfway, the focus area or focus indicator (6) always lights in green.



Sports

Use this mode when shooting sporting events. The camera captures a series of still pictures that allow you to clearly see detailed movements in a moving subject.

- The camera focuses on the subject at the center area of the frame.
- To capture a series of images, hold down the shutter-release button all the way. Up to 12 pictures are shot at a rate of about 1.4 frames per second (fps) (when image mode is set to 4608×3456).
- The camera focuses on the subject even when the shutter-release button is not pressed halfway. You may hear the sound of the camera focusing.
- Focus, exposure, and hue are fixed at the values determined with the first shot in each series.
- The frame rate with continuous shooting may decrease depending upon the current image mode setting, the memory card used, or shooting condition.



Night portrait



Use this mode for portraits taken at sunset or at night.

- The camera detects and focuses on a face (see "Using Face Detection" (📖65) for more information).
- After the skin softening feature makes facial skin tones softer, the camera records the image (📖66).
- If no faces are detected, the camera focuses on the subject at the center of the frame.
- The digital zoom is not available.



Party/indoor

Suitable for taking pictures in parties. Captures the effects of candlelight and other indoor background lighting.

- The camera focuses on the subject at the center area of the frame.
- When shooting in dark surroundings, hold the camera steadily to avoid the effects of camera shake. To take a picture with the camera attached to a tripod, set **Vibration reduction** in the setup menu (📖94) to **Off**.



Beach

Capture the brightness of such subjects as beaches or sunlit expanses of water.

- The camera focuses on the subject at the center area of the frame.



Snow

Capture the brightness of sunlit snow.

- The camera focuses on the subject at the center area of the frame.



Sunset



Preserve the deep hues seen in sunsets and sunrises.

- The camera focuses on the subject at the center area of the frame.



Scene Mode (Shooting Suited to Scenes)

Dusk/dawn



Preserve the colors seen in the weak natural light before sunrise or after sunset.

- When the shutter-release button is pressed halfway, the focus area or focus indicator () always lights in green.



Night landscape









Slow shutter speeds are used to capture the atmosphere of a night landscape.

- When the shutter-release button is pressed halfway, the focus area or focus indicator () always lights in green.



Close-up

Use this mode to photograph flowers, insects, and other small objects at close range.

- Macro mode () is enabled and the camera automatically zooms to the closest position to the subject where the camera can shoot.
- You can move the focus area that the camera focuses on. Press the  button and then press the multi selector , , , or  to move the focus area.









To adjust the following settings, press the  button to temporarily cancel focus area selection, and then adjust each setting.

- Flash mode, self-timer or exposure compensation
- The camera focuses on the subject even when the shutter-release button is not pressed halfway. You may hear the sound of the camera focusing.



Food

Use this mode when taking pictures of food.

- Macro mode (57) is enabled and the camera automatically zooms to the closest position to the subject where the camera can shoot.
- You can adjust the hue by pressing the multi selector  or . The hue adjustment setting is saved in the camera's memory even after the camera is turned off.
- You can move the focus area that the camera focuses on. Press the  button and then press the multi selector , , , or  to move the focus area.

To adjust the following settings, press the  button to temporarily cancel focus area selection, and then adjust each setting.

- Hue, self-timer or exposure compensation
- The camera focuses on the subject even when the shutter-release button is not pressed halfway. You may hear the sound of the camera focusing.

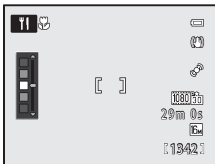

Museum

Use indoors where flash photography is prohibited (for example, in museums and art galleries) or in other settings in which you do not want to use the flash.

- The camera focuses on the subject at the center area of the frame.
- The camera captures up to ten images while the shutter-release button is pressed all the way, and the sharpest image in the series is automatically selected and saved (BSS (Best Shot Selector) (52)).



Fireworks show



Slow shutter speeds are used to capture the expanding burst of light from fireworks.

- The camera focuses at infinity.
- When the shutter-release button is pressed halfway, the focus area or focus indicator (6) always lights in green.



Black and white copy

Provide clear images of text or drawings on a white board or in print.

- The camera focuses on the subject at the center area of the frame.
- When shooting nearby object, shoot with macro mode (57).

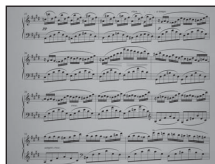

Backlighting

Use when light is coming from behind the subject, throwing features or details into shadow.

In the screen that is displayed when  **Backlighting** scene mode is selected, **On** or **Off** can be selected in HDR (high dynamic range) composition.

- **Off** (default setting): The flash fires to prevent the backlit subject from being hidden in shadow.
 - The camera focuses on the subject at the center area of the frame.
 - Press the shutter-release button all the way to shoot a single picture.
- **On**: Use when shooting scenes with high contrast.
 - The **HDR** icon is displayed on the shooting screen. If there are very bright areas and very dark areas in the frame, the **HDR** icon lights in green.
 - The camera focuses on the subject at the center area of the frame.
 - When the shutter-release button is pressed all the way, the camera shoots pictures continuously, and saves the following two images.
 - An image processed by D-Lighting (📖71) at the time of shooting
 - HDR composite image (loss of detail is reduced in highlights and shadows)
 - The second image saved is an HDR composite image. If only one image can be saved, an image processed by D-Lighting is the only image saved.
 - Once the shutter-release button is pressed all the way, hold the camera steady without moving it until a still picture is displayed. After taking a picture, do not turn the camera off before the monitor switches to the shooting screen.
 - Use of a tripod is recommended. Set **Vibration reduction** in the setup menu (📖94) to **Off** when using a tripod to stabilize the camera.
 - The digital zoom is not available.













Panorama



Use this mode for shooting panorama pictures.

In the screen that is displayed when  **Panorama** scene mode is selected, Select **Easy panorama** or **Panorama assist**.

- **Easy panorama** (default setting): Shoots panorama pictures that can be played back on the camera by moving the camera in the direction you want to create a panorama picture.
 - Shooting range can be selected from **Normal (180°)** (default setting) or **Wide (360°)**.
 - Press the shutter-release button all the way and release it, then move the camera slowly in the horizontal or vertical direction.
 - When shooting starts, the camera focuses on the subject at the center area of the frame.
 - The zoom is fixed at the wide-angle position.
 - Display the picture recorded with easy panorama in full-frame playback mode and press the  button. The camera displays the short side of the picture filling the entire screen and scrolls the picture automatically.
See “Using Easy Panorama (Shooting and Playing back)” (2).
- **Panorama assist**: Use this mode when shooting a series of pictures that can later be joined on a computer to form a single panorama.
 - Press the multi selector , ,  or  to select the direction in which pictures are to be joined and press the  button.
 - After shooting the first picture, shoot the necessary number of pictures while confirming the seams. To finish shooting, press the  button.
 - Transfer taken pictures to a computer and use the included **Panorama Maker 5** software (76, 6) to join them in a single panorama. See “Panorama Assist” (5) for more information.





Note on Printing Panorama Pictures

When printing panorama pictures, a full view may not be printed depending on the printer settings. Additionally, printing may not be available depending on the printer.

For more information, see your printer’s manual or contact a digital photo lab.

Pet portrait

Use this mode for shooting pictures of dogs or cats.

- Select **Single** or **Continuous** (three pictures are shot continuously).
 - **Single**: One picture is captured at a time.
 - **Continuous** (default setting): When the camera focuses on the detected face in **Pet portrait auto release** (default setting) mode, three pictures are shot continuously (frame rate with continuous shooting: approximately 1.4 frames per second when image mode is set to  **4608x3456**). If pet portrait auto release is not used, up to 12 pictures are shot at a rate of about 1.4 frames per second while the shutter-release button is fully held down (when image mode is set to  **4608x3456**).
- The camera detects and focuses on the face of a dog or cat. In the default setting, when the subject is in focus, the shutter is released automatically (Pet portrait auto release).
- Up to five pet faces are detected simultaneously.
- If a pet's face is not detected, press the shutter-release button halfway to focus on the subject at the center of the frame.
- Press the multi selector  to change the pet portrait auto release settings.
 - **Pet portrait auto release** (default setting): When the camera focuses on the detected face, the shutter is released automatically. When **Pet portrait auto release** is selected,  is displayed on the shooting screen.
 - **OFF**: Press the shutter-release button to release the shutter.
- In the following situations, **Pet portrait auto release** is automatically switched to **OFF**.
 - When pet portrait auto release is repeated five times
 - When remaining capacity of the internal memory or memory card is lowTo continue shooting with pet portrait auto release, press the multi selector  to set again.
- The digital zoom is not available.
- Under some shooting conditions such as pet-to-camera distance, speed of moving pets, direction in which the pets are facing, and brightness of the faces, the camera may be unable to detect a dog or cat, or a border is displayed around something other than a dog or cat.



Underwater

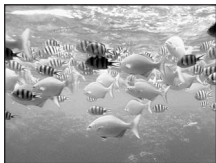

Use this mode for underwater shooting.

- The camera focuses on the subject at the center area of the frame.
- The digital zoom is not available.
- See "<Important> Shockproof, waterproof, dustproof, condensation, GPS/digital compass" ( xi) for more information on shooting underwater.



Special Effects Mode (Applying Effects When Shooting)

Select one of the six special effects for shooting. The effect is applied to pictures during shooting.



Display the shooting screen →  (shooting mode) button → SO (the third icon from the top*) →  → Select the effect ( 26, 27)

* The last icon you selected is displayed. The default setting is SO (Soft).

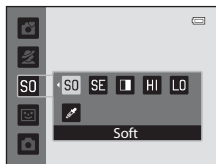

- The camera focuses on the subject at the center area of the frame.



Characteristics of Each Special Effect

Option	Description
SO Soft	Soften the image by adding a slight blur to the overall image.
SE Nostalgic sepia	Add a sepia tone and reduce the contrast to simulate the qualities of an old photograph.
 High-contrast monochrome	Change the image to black and white and gives it sharp contrast.
HI High key	Give the overall image a bright tone.
LO Low key	Give the overall image a dark tone.
 Selective color	Create a black and white image in which only the specified color remains.

- When **Selective color** is set, select a color that you want to retain using the multi selector ▲ or ▼. To adjust the following settings, press the  button to temporarily cancel color selection, and then adjust each setting.

- Flash mode ( 54)
- Macro mode ( 57)

To return to the color selection screen, press the  button again.



Changing Special Effects Mode Settings

- See “Features That Can Be Set Using the Multi Selector” (📖53) for more information on flash mode (📖54), self-timer (📖56), macro mode (📖57), and exposure compensation (📖58).
- Functions that can be set using the **MENU** button: The combination of image size and image quality (image mode) can be set using the **MENU** button (📖61).



Features That Cannot Be Used Simultaneously

These features may not be used in combination with certain features (📖63).

Smart Portrait Mode (Shooting Smiling Faces)

If the camera detects smiling faces, the shutter is automatically released without pressing the shutter-release button (Smile timer). The skin softening function makes facial skin tones softer.

Display the shooting screen → 📷 (shooting mode) button → 😊 Smart portrait mode
(📖26, 27)

1 Frame the picture and wait for the subject to smile.

- When the camera detects a human face, a yellow double border (focus area) is displayed around that face. When the camera has focused on that face, the double border will light in green for a moment and focus is locked.
- Up to three faces can be detected. When more than one face is detected, the face closest to the center of the frame is framed by a double border and the others by single borders.
- If the camera detects that the face framed by the double border is smiling, the **Smile timer** (📖50) feature is activated and the shutter is automatically released.
- Each time the shutter is released, automatic shooting using face detection and smile detection is repeated.

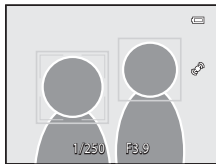

2 Shooting ends.

- To finish automatic shooting of smile detection, press the 📷 button to switch to another shooting mode.

✔ Notes on Smart Portrait Mode

- The digital zoom is not available.
- Under some shooting conditions, faces and smiling faces may not be detected properly.
- See “Notes on Face Detection” (📖65) for more information.

🔪 Auto Power Off in Smile Timer Mode

When **Smile timer** is set to **On**, the auto off function (📖95) is activated and the camera turns off when any one of the situations indicated below persists and no other operations are performed.

- The camera does not detect any faces.
- The camera detected a face, but cannot detect a smile.

🔪 When the Self-timer Lamp Blinks

When using smile timer, the self-timer lamp blinks when the camera detects a face and flickers immediately after the shutter is released.

🔪 Releasing the Shutter Manually

The shutter can also be released by pressing the shutter-release button. If no faces are detected, the camera focuses on the subject at the center of the frame.

Changing Smart Portrait Mode Settings

- See “Features That Can Be Set Using the Multi Selector” (📖53) for more information on flash mode (📖54), self-timer (📖56), and exposure compensation (📖58).
- See “Options Available in the Smart Portrait Menu” (below) for more information on functions that can be set using the **MENU** button.

Options Available in the Smart Portrait Menu

In smart portrait mode, the following option settings can be changed.

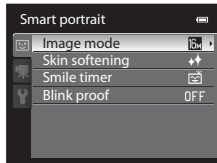



Display the shooting screen in smart portrait mode → MENU button → 📷 tab (📖11)

Option	Description	📖
Image mode	Allow you to select the combination of image size and image quality used when saving images (📖61). The default setting is 📷 4608x3456 . This setting is also applied to other shooting modes.	61
Skin softening	Enable skin softening. The camera makes facial skin tones softer before saving images. The extent of effect applied can be selected. The default setting is Normal .	📷32
Smile timer	When set to On (default setting), the camera detects human faces and then automatically releases the shutter whenever a smile is detected. Self-timer cannot be used with this feature.	📷32
Blink proof	When On is selected, the camera automatically releases the shutter twice each time a picture is taken. Of the two shots, one in which the subject's eyes are open is saved. The flash cannot be used when On is selected. The default setting is Off .	📷33

(Auto) Mode

Basic shooting operations can be performed. In addition, the options of shooting menu can be adjusted according to the shooting conditions and the kind of images you want to capture.

Display the shooting screen →  (shooting mode) button →  (auto) mode (📖26, 27)

- The focus area for autofocus differs depending on the setting of **AF area mode** that can be selected in the  tab after pressing the **MENU** button.
- When **AF area mode** is set to **Face priority** (default setting), the camera focuses as follows:
 - The camera detects and focuses on faces (see “Using Face Detection” (📖65) for more information).
 - If no faces are detected, the camera automatically selects one or more of the nine focus areas containing the subject closest to the camera. When the subject is in focus, the focus area (active focus area) lights in green (maximum of nine areas).

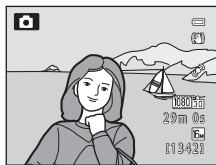



Changing (Auto) Mode Settings

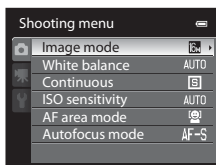

- See “Features That Can Be Set Using the Multi Selector” (📖53) for more information on flash mode (📖54), self-timer (📖56), macro mode (📖57), and exposure compensation (📖58).
- See the shooting menu below for more information on functions that can be set using the **MENU** button.

Options Available in the Shooting Menu ((Auto) Mode)

In  (auto) mode, the following option settings can be changed.



Display the shooting screen in  (auto) mode → **MENU** button →  tab (📖11)

Option	Description	
Image mode	Allow you to select the combination of image size and image quality used when saving images (📖61). The default setting is  4608×3456 . This setting is also applied to other shooting modes.	61

Option	Description	
White balance	<p>Adjust colors in the image closer to the colors as they appear to the eye. Although Auto (default setting) can be used under most types of lighting, you can apply the white balance setting suited to the sky conditions or light source to achieve better results if default setting results are unsatisfactory.</p> <ul style="list-style-type: none"> When the white balance setting is other than Auto or Flash, set the flash mode (54) to (off). 	34
Continuous	<p>Select the mode used for taking a series of pictures from Single, Continuous H, Continuous L, BSS (43) and Multi-shot 16. The default setting is Single (i.e., only one picture is captured at a time).</p> <p>When set to Continuous H, up to three pictures are shot at a rate of about 7.1 frames per second while the shutter-release button is pressed all the way (when image mode is set to 4608x3456).</p>	36
ISO sensitivity	<p>Higher ISO sensitivity allows you to take pictures of darker subjects. Additionally, even with subjects of similar brightness, pictures can be taken with faster shutter speeds, and blurring caused by camera shake and subject movement can be reduced. When set to Auto (default setting), the camera sets the ISO sensitivity automatically. If ISO sensitivity has increased automatically when Auto is selected, ISO (28) is displayed on the shooting screen.</p>	37
AF area mode	<p>Allow you to determine how the camera selects the focus area for autofocus to Face priority (default setting), Auto, Manual, Center or Subject tracking mode.</p>	38
Autofocus mode	<p>Single AF (default setting) to adjust the focus only when the shutter-release button is pressed halfway or Full-time AF to adjust the focus even when the shutter-release button is not pressed halfway can be selected. You may hear the sound of the camera focusing.</p>	41

Features That Cannot Be Used Simultaneously

These features may not be used in combination with certain features (63).

Features That Can Be Set Using the Multi Selector

Press the multi selector ▲ (⚡), ◀ (⌚), ▼ (🌸), or ▶ (📷) while shooting to operate the following functions.

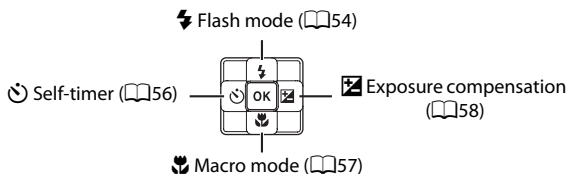

Available Functions

Available functions differ according to the shooting mode as follows.

- See “Default Settings” (📖59) for more information on the default settings in each shooting mode.

Function	Easy auto mode	Scene	Special effects	Smart portrait	📷 (Auto)
⚡ Flash mode (📖54)	✓	*	✓	✓	✓
⌚ Self-timer (📖56)	✓		✓	✓	✓
🌸 Macro mode (📖57)	-		✓	-	✓
📷 Exposure compensation (📖58)	✓		✓	✓	✓

* The setting varies with scene mode or special effects. See “Default Settings” (📖59) for more information.

Flash Modes (Using the Flash)

You can set a flash mode that suits the shooting conditions.

- 1 Press **▲** (⚡ flash mode) on the multi selector.



- 2 Press the multi selector to select the desired mode and press the **OK** button.

- See “Available Flash Modes” (📖55) for more information.
- If the **OK** button is not pressed within a few seconds, the selection will be canceled.
- When **⚡AUTO** (auto) is applied, **⚡AUTO** is only displayed for a few seconds, regardless of **Photo info** settings (📖94).

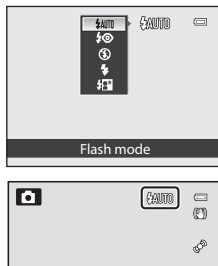

- 3 Frame the subject and take a picture.





- The flash lamp indicates the status of the flash when you press the shutter-release button halfway.
 - On: The flash will fire when you press the shutter-release button all the way.
 - Blinking: The flash is charging. The camera cannot take pictures.
 - Off: The flash will not fire when a picture is taken.
- If the battery is low, the monitor will be turned off while the flash is charging.



Effective Range of the Flash

The flash has a range of about 0.3 to 3.5 m (1 ft to 11 ft) for wide-angle position, and about 0.5 to 2.2 m (1 ft 8 in. to 7 ft 2 in.) for telephoto zoom position (when **ISO sensitivity** is set to **Auto**).

Available Flash Modes

	Auto
	The flash fires automatically when lighting is dim.
	Auto with red-eye reduction
	Suitable for portraits. Reduces red-eye effect caused by flash in portraits.
	Off
	The flash does not fire. Using a tripod is recommended to stabilize the camera when shooting in dark surroundings.
	Fill flash
	The flash fires when a picture is taken, regardless of how bright the subject is. Use to “fill-in” (illuminate) shadows and backlit subjects.
	Slow sync
	Auto flash mode is combined with a slow shutter speed. Suitable for portraits of human subjects shot at night or under dim light. Flash illuminates main subject; slow shutter speeds are used to capture background.

Flash Mode Setting

- The setting varies with shooting mode. See “Available Functions” (📖53) and “Default Settings” (📖59) for more information.
- This feature cannot be used in combination with certain features. See “Features That Cannot Be Used Simultaneously” (📖63).
- The changed flash mode setting applied in  (auto) mode is saved in the camera’s memory even after the camera is turned off.

Auto with Red-eye Reduction

This camera uses advanced red-eye reduction (“In-Camera Red-Eye Fix”).

Pre-flashes are fired repeatedly at low intensity before the main flash, reducing the red-eye effect.

If the camera detects “red-eye” when a picture is taken, Nikon’s own In-Camera Red-Eye Fix processes the image before it is recorded.

Note the following when taking pictures:

- Because pre-flashes are fired, there is a slight lag between when the shutter-release button is pressed and when the picture is shot.
- The time required to save the picture increases slightly.
- Advanced red-eye reduction may not produce the desired results in some situations.
- In extremely rare instances, areas not subject to red-eye may be affected by advanced red-eye reduction processing. In these cases, choose another flash mode and try again.

Using the Self-timer

The self-timer is suitable for taking group pictures and reducing the vibration when the shutter-release button is pressed.

When using the self-timer, use of a tripod is recommended. Set **Vibration reduction** in the setup menu (📖94) to **Off** when using a tripod to stabilize the camera.

1 Press ◀ (🕒 self-timer) on the multi selector.



2 Press the multi selector ▲ or ▼ to select **10s** or **2s** and press the Ⓞ button.

- **10s** (ten seconds): suitable for group pictures.
- **2s** (two seconds): suitable for preventing camera shake.
- When the shooting mode is set to **Pet portrait** in scene mode, 🐾 (pet portrait auto release) is displayed (📖46). The self-timer **10s** and **2s** are not available.
- The mode selected for the self-timer is displayed.
- If the Ⓞ button is not pressed within a few seconds, the selection will be canceled.

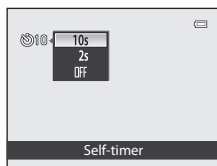

3 Frame the subject and press the shutter-release button halfway.

- The focus and exposure are set.

4 Press the shutter-release button all the way.

- The self-timer starts, and the number of seconds remaining before the shutter is released is displayed. The self-timer lamp blinks while the timer is counting down. About one second before the shutter is released, the lamp stops blinking and remains lit.
- When the shutter is released, the self-timer turns **OFF**.
- To stop the timer before a picture is taken, press the shutter-release button again.

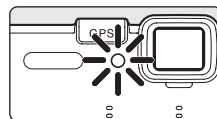
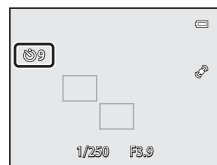

Using Macro Mode

When using macro mode, the camera can focus on subjects as close as 1 cm (0.4 in.) from the front of the lens.

This feature is useful when taking close-up pictures of flowers and other small subjects.

- 1 Press **▼** (🌸 macro mode) on the multi selector.



- 2 Press the multi selector **▲** or **▼** to select **ON** and press the **OK** button.

- The macro mode icon 🌸 is displayed.
- If the **OK** button is not pressed within a few seconds, the selection will be canceled.

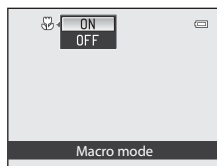

- 3 Use the zoom buttons to set the zoom ratio to a position where 🌸 and the zoom indicator light in green.

- How close you can be to the subject when shooting depends on the zoom ratio.

When the zoom ratio is set to a position where 🌸 and the zoom indicator light in green, the camera can focus on subjects as close as 10 cm (4 in.) from the lens. At the zoom position between the maximum wide-angle position and 🌸 icon, the camera can focus on subjects as close as 1 cm (0.4 in.) from the lens.

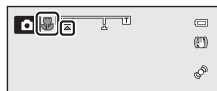

✔ Note on Using the Flash

The flash may be unable to light the entire subject at distances of less than 50 cm (1 ft 8 in.).

✍ Autofocus

In the **📷** (auto) mode, you can focus without pressing the shutter-release button halfway by setting **Autofocus mode** in the shooting menu (📖51) to **Full-time AF**.

When using other shooting modes, **Full-time AF** is turned on automatically when macro mode is turned on.

You may hear the sound of the camera focusing.

✍ The Macro Mode Setting

- Macro mode cannot be used when using certain shooting modes. See "Available Functions" (📖53) and "Default Settings" (📖59) for more information.
- The changed macro mode setting applied in **📷** (auto) mode is saved in the camera's memory even after the camera is turned off.

Exposure Compensation (Adjusting Brightness)

By adjusting exposure compensation when taking pictures, you can adjust overall image brightness.

- 1 Press **▶** (☒ exposure compensation) on the multi selector.



- 2 Press the multi selector **▲** or **▼** to select a compensation value.

- To make the image brighter, apply positive (+) exposure compensation.
- To make the image darker, apply negative (-) exposure compensation.

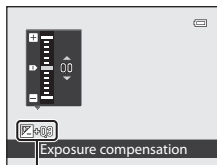

Exposure compensation value

- 3 Press the **OK** button.

- If the **OK** button is not pressed within a few seconds, the selection is set and the setting menu disappears.
- Even when the shutter-release button is pressed without pressing the **OK** button, a picture can be shot using the selected compensation value.
- When an exposure compensation value other than **0.0** is applied, the value is displayed with the ☒ icon on the monitor.

- 4 Press the shutter-release button to take a picture.

- To turn off exposure compensation, return to step 1, change the value to **0.0**.

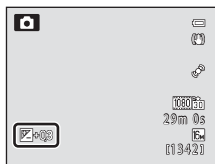















Exposure Compensation Value



- The changed exposure compensation value applied in **☒** (auto) mode is saved in the camera's memory even after the camera is turned off.
- When the shooting mode is the **Fireworks show** scene mode ()43), the exposure compensation cannot be used.

Default Settings

The default settings in each shooting mode are described below.

- Similar information about scene mode can be found on the next page.

Shooting mode	Flash mode ( 54)	Self-timer mode ( 56)	Macro mode ( 57)	Exposure compensation ( 58)
 (Easy auto mode) ( 38)	 AUTO ¹	OFF	OFF ²	0.0
Special effects ( 47)		OFF	OFF	0.0
 (Smart portrait) ( 49)	 AUTO ³	OFF ⁴	OFF ²	0.0
 (Auto mode) ( 51)	 AUTO	OFF	OFF	0.0

¹  AUTO (auto) and  (off) can be selected. When  AUTO (auto) is selected, the camera selects the flash mode appropriate for the scene it has automatically selected.

² The setting cannot be changed.

³ Cannot be used when **Blink proof** is set to **On**.

⁴ Can be set when **Smile timer** is set to **Off**.

- The setting applied in  (auto) mode is saved in the camera's memory even after the camera is turned off (except for self-timer).

Features That Can Be Set Using the Multi Selector

The default settings in each scene mode are described below.

	Flash mode (📖54)	Self-timer mode (📖56)	Macro mode (📖57)	Exposure compensation (📖58)
(📖40)		OFF	OFF ¹	0.0
(📖40)	¹	OFF	OFF ¹	0.0
(📖40)	¹	OFF ¹	OFF ¹	0.0
(📖41)	²	OFF	OFF ¹	0.0
(📖41)	³	OFF	OFF ¹	0.0
(📖41)	AUTO	OFF	OFF ¹	0.0
(📖41)	AUTO	OFF	OFF ¹	0.0
(📖41)	¹	OFF	OFF ¹	0.0
(📖42)	¹	OFF	OFF ¹	0.0
(📖42)	¹	OFF	OFF ¹	0.0
(📖42)	¹	OFF	ON ¹	0.0
(📖43)	¹	OFF	ON ¹	0.0
(📖43)	¹	OFF	OFF	0.0
(📖43)	¹	OFF ¹	OFF ¹	0.0 ¹
(📖43)		OFF	OFF	0.0
(📖44)	AUTO ⁴	OFF	OFF ¹	0.0
(📖45)	⁵	OFF ⁵	OFF ⁵	0.0
(📖46)	¹		OFF	0.0
(📖46)		OFF	OFF	0.0

¹ The setting cannot be changed.

² The setting cannot be changed. The flash mode setting is fixed at fill flash with slow sync and red-eye reduction.

³ May switch to slow sync with red-eye reduction flash mode.

⁴ When **HDR** is set to **Off**, the flash mode is fixed at (fill flash).
When **HDR** is set to **On**, the flash mode is fixed at (off).

⁵ The setting cannot be changed when using **Easy panorama**.

⁶ The self-timer is not available. Pet portrait auto release (📖46) can be set to on or off.

Features That Cannot Be Used Simultaneously

These features may not be used in combination with certain features (📖63).















Changing the Image Size (Image Mode)

Display the shooting screen → MENU button (📖11) → Shooting Menu → Image mode

Use the **Image mode** setting in the shooting menu to select the combination of image size and image quality (compression rate) that is used when saving images. Select the image mode best suited to the manner in which images will be used and the capacity of the internal memory or memory card.

The higher the image mode setting, the larger the size at which it can be printed or displayed without appearing noticeably grainy, but the number of images that can be saved is reduced.

Image Mode Settings (Image Size and Quality)

Option*	Description
 4608×3456★	Images will be higher quality than  . The compression ratio is approximately 1:4.
 4608×3456 (default setting)	Good balance between file size and image quality; suitable in most situations. The compression ratio is approximately 1:8.
 4000×3000	
 3264×2448	
 2592×1944	
 2048×1536	Smaller size than    or  and therefore allows more images to be captured. The compression ratio is approximately 1:8.
 1024×768	Suited to display on a computer monitor. The compression ratio is approximately 1:8.
 640×480	Suited to full-screen display on a television with an aspect ratio of 4:3, or e-mail attachments. The compression ratio is approximately 1:8.
 4608×2592	Images with an aspect ratio of 16:9 can be shot. The compression ratio is approximately 1:8.

* The total number of pixels recorded, and the number of pixels recorded horizontally and vertically.
Example:  4608×3456 = 16 megapixels, 4608×3456 pixels

The icon for the current setting is displayed on the monitor in shooting and playback modes (📖6, 8).









Image Mode Setting

- The setting is also applied to other shooting modes.
- This function cannot be used simultaneously with certain features. See "Features That Cannot Be Used Simultaneously" (📖63) for more information.

Changing the Image Size (Image Mode)

Number of Exposures Remaining

The following table lists the approximate number of images that can be saved in the internal memory and on a 4 GB memory card. Note that due to JPEG compression, the number of exposures remaining differs depending on the composition of the image. In addition, this number may vary depending on the make of the memory card, even when the memory cards have the same specified capacity.

Image mode	Internal memory (approx. 83 MB)	Memory card ¹ (4 GB)	Print size ² (cm/in.)
 4608×3456★	10	490	39 × 29/15.3 × 11.5
 4608×3456	21	970	39 × 29/15.3 × 11.5
 4000×3000	28	1,280	34 × 25/13 × 10
 3264×2448	42	1,910	28 × 21/11 × 8
 2592×1944	65	2,940	22 × 16/8.5 × 6.5
 2048×1536	102	4,640	17 × 13/7 × 5
 1024×768	334	15,000	9 × 7/3.5 × 2.5
 640×480	593	24,100	5 × 4/2 × 1.5
 4608×2592	28	1,290	39 × 22/15.3 × 8.6

¹ If the number of exposures remaining is 10,000 or more, the number of exposures remaining display shows “9999.”

² Print size at an output resolution of 300 dpi.

Print sizes are calculated by dividing the number of pixels by printer resolution (dpi) and multiplying by 2.54 cm (1 in.). However, at the same image size, images printed at higher resolutions will print smaller than the size indicated, and those printed at lower resolutions will print larger than the size indicated.

Features That Cannot Be Used Simultaneously

Some shooting settings cannot be used in combination with other functions.

Restricted function	Option	Descriptions
Flash mode	Continuous (📖52)	When continuous is used for shooting, the flash cannot be used.
	Blink proof (📖50)	When Blink proof is set to On , the flash cannot be used.
Self-timer	Smile timer (📖50)	When Smile timer is used for shooting, the self-timer cannot be used.
	AF area mode (📖52)	When Subject tracking is used for shooting, the self-timer cannot be used.
Macro mode	AF area mode (📖52)	When Subject tracking is used for shooting, the macro mode cannot be used.
Image mode	Continuous (📖52)	When Multi-shot 16 is used for shooting, the setting is fixed at 5 (image size: 2560×1920 pixels).
Continuous	Self-timer (📖56)	When using the self-timer, the setting is fixed at Single .
ISO sensitivity	Continuous (📖52)	<ul style="list-style-type: none"> When Continuous L is used, 3200 of ISO sensitivity cannot be used. If Continuous L is selected when 3200 is set, the setting is changed to 1600. When Multi-shot 16 is used for shooting, the ISO sensitivity is automatically specified according to the brightness.
Autofocus mode	AF area mode (📖52)	When Face priority is used for shooting, Autofocus mode is fixed at Single AF .
Print date	Continuous (📖52)	When Continuous H , Continuous L or BSS is used for shooting, the print date cannot be used.
	Blink proof (📖50)	When Blink proof is set to On for shooting, the print date cannot be used.
Motion detection	Continuous (📖52)	When Multi-shot 16 is used for shooting, Motion detection is disabled.
	ISO sensitivity (📖52)	When the ISO sensitivity is fixed to a setting other than Auto , Motion detection is disabled.

Features That Cannot Be Used Simultaneously

Restricted function	Option	Descriptions
Sound settings	Continuous (📖52)	When continuous is used for shooting, shutter sound is disabled.
	Smile timer (📖50)	When Smile timer is set to On , shutter sound is disabled.
Blink warning	Continuous (📖52)	When continuous is used for shooting, blink warning is disabled.
Digital zoom	AF area mode (📖52)	When Subject tracking is used for shooting, the digital zoom cannot be used.
	Continuous (📖52)	When Multi-shot 16 is used for shooting, the digital zoom cannot be used.

✔ Notes on Digital Zoom

- The digital zoom is not available depending on the shooting mode.
- When the digital zoom is used, the camera focuses on the subject at the center of the frame.

Using Face Detection

In the following shooting modes, the camera uses face detection to automatically focus on human faces. If more than one face is detected, a double border is displayed around the face that the camera will focus on, and single borders are displayed around the other faces.

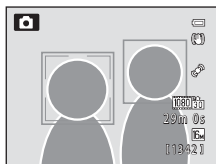

Shooting mode	Number of faces that can be detected	Focus area (double border)
(Easy auto mode) (📖38)	Up to 12	The face closest to the camera
(Auto mode) (AF area mode (📖51) is Face priority)		
Portrait, Night portrait scene mode (📖39)		
Smart portrait mode (📖49)	Up to 3	The face closest to the center of the frame

- When (easy auto) mode is selected, the focus area changes depending on which scene the camera automatically selects.
- When using **Face priority**, if you press the shutter-release button halfway while no faces are detected, the camera automatically selects one or more of the nine focus areas containing the subject closest to the camera.
- If no faces are detected when the shutter-release button is pressed halfway in **Portrait** or **Night portrait** scene mode or smart portrait mode, the camera will focus on the subject at the center of the frame.

Notes on Face Detection

- The camera's ability to detect faces depends on a variety of factors, including whether or not the subject is facing the camera. Additionally, the camera may be unable to detect faces in the following situations:
 - When faces are partially hidden by sunglasses or otherwise obstructed
 - When faces take up too much or too little of the frame
- When the frame includes more than one face, the faces detected by the camera and the face on which the camera focuses depend upon a variety of factors, including the direction in which the subject is facing.
- In some rare cases, such as those described in "Autofocus" (📖31), the subject may not be in focus even though the double border turns green. If the camera does not focus, use "Focus Lock" (📖67).

Viewing Pictures Taken Using Face Detection

- During playback, the camera automatically rotates images according to the orientation of the faces that were detected at the time of shooting. (Pictures taken when using **Continuous** (📖52) are not rotated.)
- When zooming in on an image displayed in full-frame playback mode by pressing the zoom button **T** (📖), the image is enlarged at the center of the face that was detected during shooting (📖33). (Pictures taken when using **Continuous** (📖52) are not displayed.)

Using Skin Softening

In the following mode, the camera detects up to three human faces when the shutter is released, and processes the image to make facial skin tones softer before saving the image.

-  (easy auto) mode (📖38)
- **Portrait** (📖40) or **Night portrait** (📖41) in scene mode
- Smart portrait mode (📖49)

Skin softening in **Glamour retouch** (📖71) can also be applied to saved images, even after shooting.

Notes on Skin Softening

- It may take more time to save images.
- Under some shooting conditions, the desired skin softening results may not be achieved, and skin softening may be applied to areas of the image where there are no faces. If the desired results are not produced, select another shooting mode or set **Skin softening** to **Off** when using smart portrait mode and shoot again.
- The skin softening level cannot be adjusted when shooting in  (easy auto) mode, or **Portrait** or **Night portrait** scene mode.

Focus Lock

Use focus lock to focus on off-center subjects when center is selected for AF area mode.

To focus on off-center subjects when **Center** is selected for **AF area mode** for the shooting menu (📖51) in 📷 (auto) mode, use focus lock as described below.

- 1 Position the subject at the center of the frame.

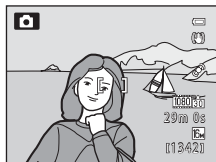

- 2 Press the shutter-release button halfway.

- Focus is locked and the focus area lights in green.
- Exposure is also locked.



- 3 Continue holding down the shutter-release button halfway and recompose the picture.

- Be sure to maintain the same distance between the camera and the subject.

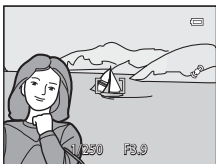

- 4 Press the shutter-release button all the way to take the picture.





A series of horizontal dashed lines for handwriting practice, spanning the width of the page.

Playback Features

This chapter describes how to select certain types of images for playback as well as some of the features available when playing back images.

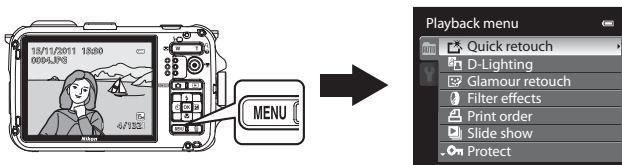
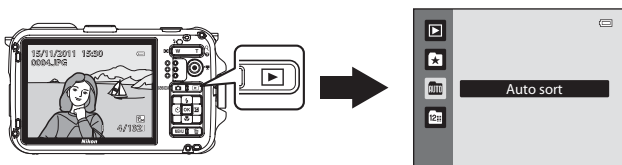



Selecting Certain Types of Images for Playback



Playback mode can be changed according to the type of images you want to view.



Available Playback Modes

 **Play**  32



All images are played back without selecting types of images. When you switch from shooting mode to playback mode, this mode is selected.

 **Favorite pictures**  9

Play back only the images added to an album. Before switching to this mode, images must be added to the album folder ( 72,  9).

 **Auto sort**  12

The pictures taken are automatically sorted into categories such as portrait, landscape, and movies. Only images of the same category are played back.

 **List by date**  14



Only images captured on the same date are played back.

Switching Between Playback Modes

1 When viewing images, press the  button.

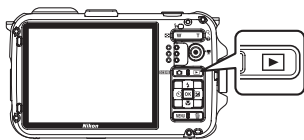
- The screen for selecting a playback mode (the playback-mode selection menu) is displayed.







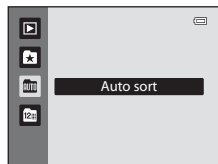

2 Press the multi selector  or  to select a mode and then press the  button.

- If you select **Play**, the playback screen is displayed.
- If you select other than **Play**, the selection screen for favorite pictures, auto sort, or list by date is displayed.
- To return to the current playback mode without switching playback modes, press the  button.





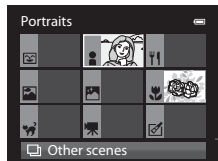

3 Select an album, a category or shooting date and then press the  button.

-  See "Favorite Pictures Mode" ( 9) for more information.
-  See "Auto Sort Mode" ( 12) for more information.
-  See "List by Date Mode" ( 14) for more information.
- To select favorite pictures, auto sort, or list by date again, repeat the operation from step 1.

























Auto sort mode











Features Available in Playback Mode (Playback Menu)





When viewing images in full-frame playback mode or thumbnail playback mode, you can configure the following functions by pressing the **MENU** button to display the menu, and then selecting the  tab,  tab,  tab or  tab ( 11).



Option	Description	
 Quick retouch ¹	Create retouched copies in which contrast and saturation have been enhanced.	 17
 D-Lighting ¹	Create copies with enhanced brightness and contrast, brightening dark portions of an image.	 17
 Glamour retouch ¹	Make facial skin tones softer and make faces look smaller with larger eyes.	 18
 Filter effects ¹	Apply a variety of effects using digital filter. The available effects are Color options, Soft, Selective color, Cross screen, Fisheye, Miniature effect and Fog removal .	 19
 Print order ²	When using a printer to print images saved on the memory card, the print order function can be used to select which images are printed, and how many copies of each image are printed.	 42
 Slide show ²	Images saved in the internal memory or on a memory card are played back in an automatic slide show.	 45
 Protect ²	Protect selected images from accidental deletion.	 46
 Rotate image	Specify the orientation in which saved images are displayed in playback mode.	 48
 Small picture ¹	Create a small copy of the pictures taken. This feature is useful for creating copies for display on Web pages or e-mail attachments.	 20
 Voice memo	Use the camera's microphone to record voice memos and attach them to the picture taken. Playback and deletion of voice memos can also be performed.	 49
 Copy ³	Copy images between the internal memory and a memory card.	 50

Features Available in Playback Mode (Playback Menu)

Option	Description	
 Sequence display options	Display a sequence of images shot continuously as individual images, or display only the key picture of a sequence.	 51
 Choose key picture ⁴	Change the key picture for the series of pictures that were shot continuously (Pictures in a sequence  7).	 51
 Favorite pictures ⁵	Select and add pictures to an album.	 9
 Remove from favorites ⁶	Remove a picture from an album.	 10

¹ This function is applied to edit the image currently selected and store it as separate files from the original files. Pictures shot with an **Image mode** (61) of **4608x2592**, pictures shot with easy panorama and movies cannot be edited (15, 16). Edited images may not be retouched again in some cases (16).



² When using list by date mode, press the **MENU** button from the list by date screen (14) to apply the same setting to all images captured on the selected date.

³ This function is not selected when using favorite pictures mode, auto sort mode, or list by date mode.

⁴ When changing this setting, select the desired sequence before displaying the menu.

⁵ This option is not displayed in favorite pictures mode.

⁶ This option is displayed only in favorite pictures mode.

See “Editing Images (Still Pictures)” (15) and “The Playback Menu” (42) in the Reference Section for more information about each function.

Connecting the Camera to a TV, Computer, or Printer

You can enhance your enjoyment of images and movies by connecting the camera to a TV, computer, or printer.

- Before connecting the camera to an external device, make sure the remaining battery level is sufficient and turn the camera off. For information about the connection methods and subsequent operations, refer to the documentation included with the device in addition to this document.

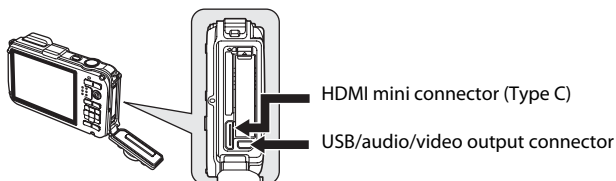

How to open the battery/
memory-card slot cover (📖18)

Insert the plug straight.

Viewing images on a TV

📺22



You can view the camera's images and movies on a TV.
Connection method: Connect the video and audio plugs of the included Audio Video Cable EG-CP16 to the TV's input jacks. Alternatively, connect a commercially available HDMI cable (Type C) to the TV's HDMI input jack.

Viewing and organizing images on a computer

📖74



If you transfer images to a computer, you can perform simple retouching and manage image data in addition to playing back images and movies.

Connection method: Connect the camera to the computer's USB input jack with the included USB Cable UC-E6.

- Before connecting to a computer, install ViewNX 2 on the computer using the included ViewNX 2 Installer CD. See 📖76 for more information about using the ViewNX 2 Installer CD and transferring images to a computer.

Printing images without using a computer

📺24



If you connect the camera to a PictBridge-compatible printer, you can print images without using a computer.

Connection method: Connect the camera directly to the printer's USB input jack with the included USB Cable UC-E6.

Using ViewNX 2

ViewNX 2 is an all-in-one software package which enables you to transfer, view, edit and share images.

Install ViewNX 2 using the ViewNX 2 Installer CD.



Installing ViewNX 2

- An Internet connection is required.

Compatible Operating Systems

Windows

- Windows 7 Home Basic/Home Premium/Professional/Enterprise/Ultimate
- Windows Vista Home Basic/Home Premium/Business/Enterprise/Ultimate (Service Pack 2)
- Windows XP Home Edition/Professional (Service Pack 3)

Macintosh

- Mac OS X (version 10.5.8, 10.6.7)

Refer to the Nikon website for the latest information on operating system compatibility.

-
- 1** Start the computer and insert the ViewNX 2 Installer CD into the CD-ROM drive.

- Mac OS: When the **ViewNX 2** window is displayed, double-click the **Welcome** icon.

2 Select a language in the language selection dialog to open the installation window.

- If the desired language is not available, click **Region Selection** to choose a different region and then choose the desired language (the **Region Selection** button is not available in the European release).
- Click **Next** to display the installation window.

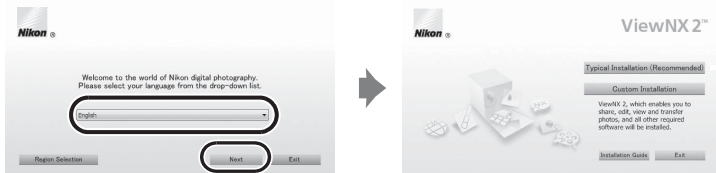

3 Start the installer.

- We recommend clicking **Installation Guide** in the installation window to check the installation help information and system requirements before installing ViewNX 2.
- Click **Typical Installation (Recommended)** in the installation window.

4 Download the software.

- When the **Software Download** screen is displayed, click **I agree - Begin download**.
- Follow the on-screen instructions to install the software.

5 Exit the installer when the installation completion screen is displayed.

- Windows: Click **Yes**.
- Mac OS: Click **OK**.

The following software is installed:

- ViewNX 2 (consisting of the three modules below)
 - Nikon Transfer 2: For transferring images to the computer
 - ViewNX 2: For viewing, editing, and printing transferred images
 - Nikon Movie Editor: For basic editing of transferred movies
- Panorama Maker 5 (for creating a single panorama photo using a series of images shot in panorama assist scene mode)
- QuickTime (Windows only)

6 Remove the ViewNX 2 Installer CD from the CD-ROM Drive.

Transferring Images to the Computer

1 Choose how images will be copied to the computer.

Choose one of the following methods:

- **Direct USB connection:** Turn the camera off and ensure that the memory card is inserted in the camera. Connect the camera to the computer using the included USB Cable UC-E6 and then turn the camera on.

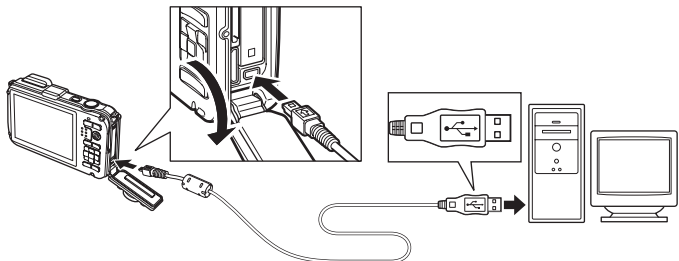

- **SD card slot:** If your computer is equipped with an SD card slot, the card can be inserted directly in the slot.
- **SD card reader:** Connect a card reader (available separately from third-party suppliers) to the computer and insert the memory card.

If a message is displayed prompting you to choose a program, select Nikon Transfer 2.

• When using Windows 7

If the dialog shown at right is displayed, follow the steps below to select Nikon Transfer 2.

- 1 A program selection dialog will be displayed; select **Import File using Nikon Transfer 2** and click **OK**.
- 2 Double-click **Import File**.

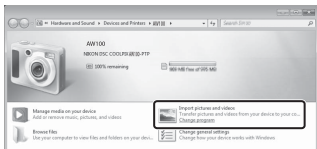

If the memory card contains a large number of images, it may take a while for Nikon Transfer 2 to start. Wait until Nikon Transfer 2 starts.

✔ Connecting the USB Cable

The connection may not be recognized if the camera is connected to the computer via a USB hub.

2 Transfer images to the computer.

- Confirm that the name of the connected camera or removable disk is displayed in the “Source” panel in the Nikon Transfer 2 “Options” area (①).
- Click **Start Transfer** (②).

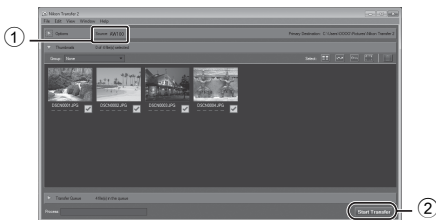

- At default settings, all the images on the memory card will be copied to the computer.

3 Terminate the connection.

- If the camera is connected to the computer, turn the camera off and disconnect the USB cable. If you are using a card reader or card slot, choose the appropriate option in the computer operating system to eject the removable disk corresponding to the memory card and then remove the card from the card reader or card slot.

Viewing Images

Start ViewNX 2.

- Images are displayed in ViewNX 2 when transfer is complete.
- Consult online help for more information on using ViewNX 2.

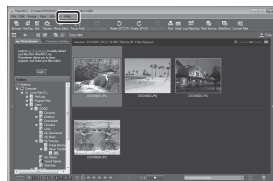

Starting ViewNX 2 Manually

- **Windows:** Double-click the **ViewNX 2** shortcut on the desktop.
- **Mac OS:** Click the **ViewNX 2** icon in the Dock.

Retouching Photographs

Click **Edit** in the ViewNX 2 toolbar.



Image editing functions include tone compensation, sharpness adjustment, and trimming (cropping).

Editing Movies

Click **Movie Editor** in the ViewNX 2 toolbar.



Movie editing functions include the ability to delete unwanted scenes.

Printing Images

Click **Print** in the ViewNX 2 toolbar.



A dialog is displayed and images can be printed using a printer connected to the computer.

Recording and Playing Back Movies

You can record movies by simply pressing the **●** (🎥 movie-record) button.

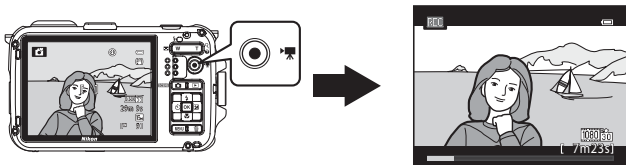

In playback mode, press the **OK** button to play a movie.

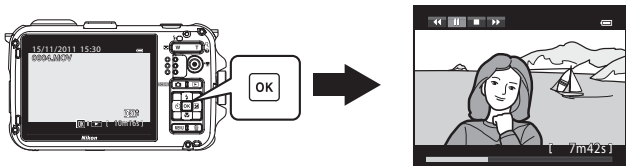

Recording Movies

You can record movies by simply pressing the  movie-record) button. Color tones, white balance, and other settings are the same when recording movies as they are when taking still images.



1 Turn on the camera and display the shooting screen.

- The movie options icon indicates the type of movie recorded. The default setting is  **HD 1080p★ (1920×1080)** (☞83).
- When recording movies, the angle of view (i.e., the area visible in the frame) is narrower than that of still images. When **Photo info** (☞94) is set to **Movie frame+auto info**, you can confirm the area visible in the frame before recording movies.

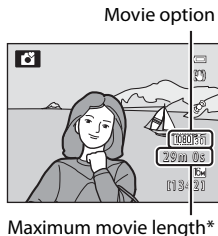
* The maximum movie length shown in the illustration differs from the actual value.



2 Press the button to start movie recording.

- The camera focuses on the subject at the center of the frame. Focus areas are not displayed during recording.
- When recording with the movie options of the aspect ratio of 16:9 (i.e., **Movie options** is  **HD 1080p★ (1920×1080)**), monitor display changes to an aspect ratio of 16:9 (the movie is recorded in the range shown in the screen on the right).
- The approximate remaining movie length is displayed on the monitor.  is displayed while saving to the internal memory.
- Recording stops automatically when the maximum movie length has been recorded.

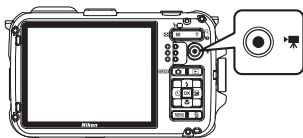

3 Press the button again to end recording.

Note on Saving Movies

After a movie has been recorded, it is not fully saved to the internal memory or memory card until monitor display returns to the shooting screen. **Do not open the battery-chamber/memory card slot cover.** Removing the memory card or the battery while a movie is being saved may result in loss of the movie data or damage to the camera or to the memory card.



Action Control

When **Assign action button** in the setup menu (☞94) is set to **Action control** (☞13), movies can be recorded by using the action control.

✓ Notes on Movie Recording

- When saving a movie onto a memory card, a memory card with an SD speed class of Class 6 or higher is recommended (☞21). If the transfer speed of the card is slow, the movie recording may end unexpectedly.
- Using the digital zoom causes image quality to deteriorate. If you start recording the movie without using digital zoom, and you keep pressing the zoom button **T**, the zoom stops at the maximum optical zoom ratio. Release the zoom button and press again **T** to trigger digital zoom. When recording ends, digital zoom turns off.
- The sound using the zoom, autofocus, vibration reduction or aperture control when the brightness changes may be recorded.
- The following phenomena may be seen on the monitor while recording movies. These phenomena are saved in the recorded movies.
 - Banding may occur in images under fluorescent, mercury-vapor, or sodium-vapor lighting
 - Subjects that move quickly from one side of the frame to the other, such as a moving train or car, may appear skewed
 - The entire movie image may be skewed when the camera is panned
 - Lighting or other bright areas may leave residual images when the camera is moved

✓ Notes on Autofocus





- When **Autofocus mode** (☞83) in the movie menu is set to **AF-S Single AF** (default setting), the focus is locked when the  movie-record button is pressed to start movie recording.
- Autofocus may not perform as expected (☞31). Should this occur, try the following:
 1. Before recording, set **Autofocus mode** in the movie menu to **AF-S Single AF** (default setting).
 2. Position a different subject at the same distance in the middle of the screen. Press the  button to start the movie recording, and change the composition.

✓ Notes on the Camera Temperature

- The camera may become warm when recording movies for an extended period of time or when the camera is used in a hot area.
- When the temperature inside the camera becomes extremely high while recording a movie, recording automatically stop after 30 seconds. The remaining amount of recording time ( 30 s) is displayed on the monitor. The camera turns off in 5 seconds after movie recording automatically stops. Leave the camera off until the inside of the camera has cooled and then use it.





Maximum Movie Length

Movie options (📖83)	Internal memory (approx. 83 MB)	Memory card (4 GB)*
 HD 1080p★ (1920×1080)	50 s	35 min
 HD 1080p (1920×1080)	58 s	40 min
 HD 720p (1280×720)	1 min 18 s	55 min
 iFrame 540 (960×540)	29 s	20 min
 VGA (640×480)	3 min 53 s	2 h 55 min





All figures are approximate. The maximum movie length varies with the make of the memory card and the bitrate of the recorded movie.

* The maximum movie length for a single movie is 4 GB or 29 minutes, even when there is sufficient free space on the memory card. The maximum movie recording time for a single movie is displayed during recording.

Functions Available in Movie Recording

- The exposure compensation and **White balance** settings in shooting menu (📖51) are also applied with movie recording. When macro mode is enabled, movies of subjects closer to the camera can be recorded. Confirm settings before starting movie recording.
- The self-timer (📖56) can be used. If the self-timer is set and the  (movie-record) button is pressed, the camera starts movie recording after ten or two seconds.
- The flash does not fire.
- Press the **MENU** button before starting to record the movie to display the  (movie) tab and select movie menu settings (📖83).

Recording HS (High Speed) Movies

When **Movie options** in movie menu is set to  **HS 240 fps (320×240)**,  **HS 120 fps (640×480)**,  **HS 60 fps (1280×720)**, or  **HS 15 fps (1920×1080)**, movies that can be played back in slow motion or fast motion can be recorded (54).

More Information

See "File and Folder Names" (85) for more information.

Changing Movie Recording Settings (Movie Menu)

The following option settings can be changed.

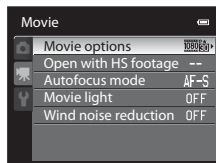

Display the shooting screen → MENU button → tab (📖11)

Option	Description	
Movie options	<p>Select the type of movie recorded. The default setting is 1080p60 HD 1080p★ (1920×1080).</p> <ul style="list-style-type: none"> Normal speed movies: When iFrame 540 (960×540) is selected, movies can be recorded in the format supported by Apple Inc. HS movies: When HS 240 fps (320×240), HS 120 fps (640×480), or HS 60 fps (1280×720) is selected, movies played back in slow motion can be recorded. When HS 15 fps (1920×1080) is selected, movies played back in fast motion can be recorded. <p>The camera switches between normal speed movie recording and HS movie recording each time the button is pressed.</p>	52
Open with HS footage	When On (default setting) is selected, record slow motion or fast motion movies from the start of HS movie recording.	53
Autofocus mode	<p>Select how the camera focuses when recording normal speed movies.</p> <p>Single AF (default setting) where the focus is locked when movie recording begins, or Full-time AF where the camera focuses continuously during movie recording can be selected. When Full-time AF is selected, the sound of the camera focusing may be heard in recorded movies. If you want to prevent the sound of the camera focusing from being recorded, select Single AF.</p>	56
Movie light	When On is selected, enable the movie light that assists recording in dark places during movie recording. The default setting is Off .	56
Wind noise reduction	Set whether or not to reduce wind noise during movie recording. During playback, not only wind noise, but other sounds may also become difficult to hear. The default setting is Off .	56

Playing Back Movies

1 Press the  (playback) button to enter playback mode.

- Use the multi selector to select the movie.
- Movies can be recognized by the movie options icon (, 82, 83).

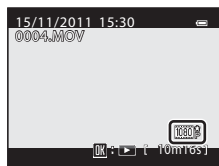



2 Press the  button to play back the movie.

Adjusting volume









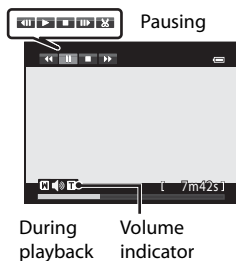



Use the zoom button **T** or **W** (, 3) during playback.

Operation during playback

Playback controls are displayed at the top of the monitor.

Press the multi selector  or  to choose a playback control, then press the  button to perform the selected operation. The following operations can be performed.



To	Use	Description
Rewind		Rewind the movie while the  button is pressed down.
Advance		Advance the movie while the  button is pressed down.
Pause		The following operations can be performed with the playback controls at the top of the monitor while playback is paused.
		 Rewind the movie by one frame. Hold down the  button to rewind continuously.
		 Advance the movie by one frame. Hold down the  button to advance continuously.
		 Extract and save only the required parts of the movie ( , 30).
		Resume playback.
End		Return to full-frame playback mode.

To delete a movie, use full-frame playback mode (, 32) or thumbnail display mode (, 33) to select a movie and press the  button (, 34).

Note on Movie Playback

Movies recorded with cameras other than COOLPIX AW100 cannot be played back.

Using GPS/Displaying Maps

This chapter describes how to record the position information on the image using GPS and how to display the current position and image shooting location on the screen using the camera's internal map information.

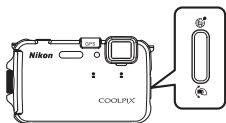

Starting GPS Data Recording

The Global Positioning System (GPS) is a satellite-based navigation system using the electro-magnetic waves of a network of GPS satellites placed into orbit. It allows users to determine their locations anywhere on Earth. The camera's internal GPS receives signals from the GPS satellites and calculate its current time and position.

Calculation of the position is known as positioning.

The position information (latitude and longitude) can be recorded on the pictures to be shot.

To start recording of the position information, set **GPS options** to **Record GPS data**.





Display the shooting screen → Press the action button to display a map* (📖13) → MENU button (📖11) → GPS options → Record GPS data

* To display the map by pressing the action button, set **Assign action button** in the setup menu (📖94) to **Display map**.

When set to **On**, signals are received from the GPS satellite and positioning starts.

- The default setting is **Off**.
- Operate in an open-air area when starting to receive signals from GPS satellites.
- Set the camera's date/time if it has not been set before using the GPS function (📖24). Functions such as create log cannot be used if the date/time has not been set.

GPS Reception Indicator and Point of Interest (POI) Information

- GPS reception can be checked on the shooting screen (📖6).
 - : Signals are being received from four or more satellites and determines position. Position information is recorded on the image.
 - : Signals are being received from three satellites and determines position. Position information is recorded on the image.
 - : Signals are being received from the satellite, but positioning is not possible. The position information is not recorded on the image.
 - : Signals cannot be received from the satellite, and positioning is not possible. The position information is not recorded on the image.

GPS reception

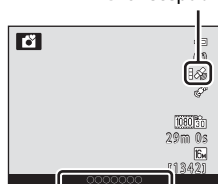



Point of interest (POI) information

- When **Display POI** in **Points of interest (POI)** of the map menu (📖90) is set to **On**, the point of interest (POI) information is displayed. The POI information displays the names of the nearest landmarks (facilities) and other details.
- "----" may be displayed depending on the setting level in **Level of detail** of **Points of interest (POI)**. Also, certain landmark names may not be registered, or the landmark name may be different.
- To record the POI information on an image, set **Embed POI** in **Points of interest (POI)** to **On**.

Notes on GPS

- When positioning for the first time, when positioning was unable to be performed for about two hours, or after the battery was changed, it takes a few minutes to obtain the position information.
- Positions of the GPS satellites change constantly. You may not be able to determine the position or it may take some time depending on your location and the time. To use the GPS feature, use the camera as much as possible in an open-air area. Signal receiving will be smoother if the GPS antenna () is facing the sky.
- If the camera needs to be turned off inside an airplane or hospital, set the **Record GPS data** to **Off**.
- The following locations which block or reflect signals may result in failed or inaccurate positioning.
 - Inside buildings or at the basement of buildings
 - Between high-rise buildings
 - Under overpasses
 - Inside tunnels
 - Near high-voltage electrical power lines
 - Between clusters of trees
 - Underwater
- Using a mobile phone of 1.5 GHz band near this camera may disrupt positioning.
- When carrying this camera around while positioning, do not place it in a metal bag. Positioning cannot be performed if the camera is covered in metal materials.
- When there is a significant difference in the signals from the GPS satellite, there could be a deviation of up to several hundred meters.
- Be aware of your surroundings when positioning.
- If **Record GPS data** is set to **On** and the camera is turned off, positioning will be done every 30 minutes for up to six hours. If positioning cannot be done, positioning will be done every 15 minutes for up to an hour. Positioning will cancel if positioning cannot be done after three minutes.
- The date and time of the camera's internal clock at the time of shooting is recorded at the date and time of recording indicators displayed on the camera during playback. The time obtained by the position information and recorded on images will not be displayed on the camera.
- Position information will be recorded on the first frame of pictures shot using continuous shooting mode.
- The Geodetic system for this camera's GPS function uses the WGS 84 (World Geodetic System 1984).

Pictures with Recorded Position Information

- The  icon is displayed during playback for images which have the position information recorded ()8).
- Position information recorded on a picture can be checked on a map with ViewNX2 after transferring the image to a computer ()74).
- The actual place of shooting may differ from the GPS information recorded on the image files due to the accuracy of the position information obtained and a difference in the Geodetic system used.

Displaying Maps

The current position or image shooting location can be displayed on the screen using the camera's internal map information.

To display the map, press the action button in shooting mode or playback mode.

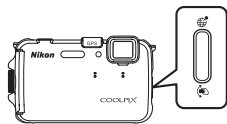

When Using Shooting Mode

To display the current position on the screen, press the action button in shooting mode when **Record GPS data** in **GPS options** of the map menu is set to **On**.

- To adjust the scale of the map, use the zoom button (**W** (🗨️)/**T** (🗨️)).

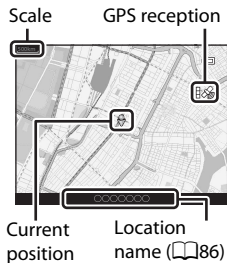

When Using Playback Mode

If an image displaying 📷 in the full-frame display is selected and the action button is pressed, the image shooting location is displayed on the screen.

- To adjust the scale of the map, use the zoom button (**W** (🗨️)/**T** (🗨️)).
- To move the map display, press the multi selector ▲, ▼, ◀ or ▶.

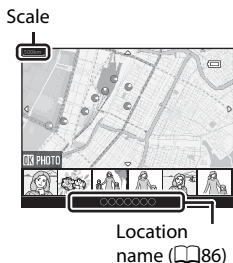

- When the **OK** button is pressed, another image can be selected. Only images with the recorded position information are displayed in the thumbnail display.
- The image shooting location and a rough direction are indicated by 📍 (📍 indicates north), and the selected image is highlighted in yellow.
- Press the multi selector ◀ or ▶ to select the image.
- To enlarge the image, press the zoom button **T** (🗨️). To return to the map display, press **W** (🗨️).

Image shooting location and direction

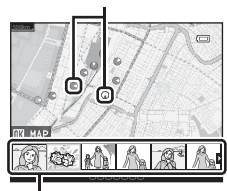

Thumbnail display

Map Display

- The map display cannot be rotated. Only the north up display (the top of the screen indicates the north) is available.
- The map display scale may vary depending on the country where the map is displayed.
- In shooting mode, when **Record GPS data** in **GPS options** of the map menu is set to **Off** or when positioning could not be performed, a world map centered on the region that was set in **Time zone** of **Time zone and date** in the setup menu (📖94) is displayed.
- If the position information is not recorded on the playback image, the map cannot be displayed.

Action Control

If **Assign action button** in the setup menu (📖94) is set to **Action control**, the map can be displayed by the action control (📖13).





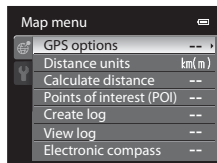

Changing the GPS or Electronic Compass Settings (Map Menu)

In map display mode, the following option settings can be changed.

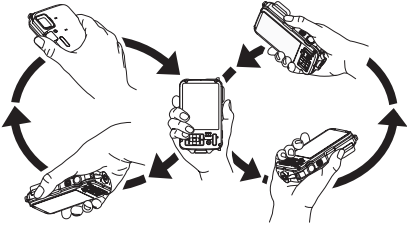

Press the action button (display map, 13) → MENU button → globe tab (11)

Option	Description	
GPS options	<p>Record GPS data: When set to On, signals are being received from the GPS satellite and positioning starts (186). The default setting is Off.</p> <p>Synchronize: Signals from the GPS satellite are used to set the date and time of the camera's internal clock (only when Record GPS data in GPS options of the map menu is set to On).</p> <p>Update A-GPS file: A memory card is used to update the A-GPS (assist GPS) file. Using the latest A-GPS file can shorten the time needed for tracking the position information.</p>	57
Distance units	The distance units of the map display can be selected from km (m) (kilometers (meters)) (default setting) or mi (yd) (miles (yards)).	58
Calculate distance	Calculate the linear distance from the current location to the shooting location on the image (only when Record GPS data of GPS options of the map menu is set to On) or between image shooting locations (only when using playback mode).	59

Option	Description	
Points of interest (POI)	<p>Make the settings for the POI (points of interest, location name information).</p> <p>Embed POI: When set to On, the location name information is recorded on the pictures to be shot. The default setting is Off.</p> <p>Display POI: When set to On, the location name information is displayed on the shooting screen or playback screen. The default setting is Off.</p> <p>Level of detail: Set the display level of the location name information. A higher display level shows more detailed regional information, and a lower display level shows regional information for a wider area (such as country names).</p> <p>Edit POI: The level of the location name information recorded on the image can be changed, and the regional information can be deleted.</p>	 60
Create log	<p>When log recording starts, the measured tracking information for a certain duration is recorded until a preset time has elapsed (only when Record GPS data in GPS options of the map menu is set to On).</p> <ul style="list-style-type: none"> To display the log data, save it to a memory card. 	 61
View log	<p>Display the recorded log data on the map for checking your movement route.</p>	 63
Electronic compass	<p>Compass display: When set to On, the compass is displayed on the shooting screen. The default setting is Off.</p> <p>Compass correction: Corrects the compass when the compass direction is not displayed correctly. Swing the camera to draw a figure eight in the air while turning your wrist to face the camera forward and backward, side to side, or up and down.</p> 	 64



A series of horizontal dashed lines for handwriting practice, starting from the top right and extending across the page.

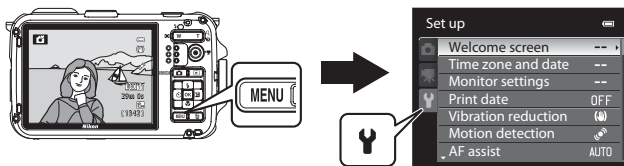

General Camera Setup

This chapter describes the various settings that can be adjusted in the  setup menu.









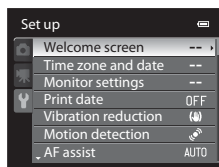

- See “Using Menus (the **MENU** Button)” (📖 11) for more information about using the camera’s menus.
- For further details about each setting, refer to “The Setup Menu” in the Reference Section (🔧 66).













The Setup Menu

Press the MENU button →  (setup) tab  11









From the menu screen, select the  tab to display the setup menu, and then you can change the following settings.



Option	Description	
Welcome screen	Select the image displayed as the welcome screen when the camera is turned on. Select COOLPIX to display the COOLPIX logo. Select Select an image to use a picture taken with the camera as the welcome screen. The default setting is None .	 66
Time zone and date	Set settings related to the camera's date and time. The Time zone setting allows you to specify the time zone where the camera is mainly used and whether or not daylight saving time is in effect. When the  travel destination is selected, the camera automatically calculates the time difference between the travel destination and the  home time zone, and saves images using the date and time of the travel destination.	 67
Monitor settings	In Photo info , select the kind of information that is displayed on the monitor during shooting mode and playback mode. If you select Framing grid+auto info , a framing grid is displayed when shooting to help you frame the picture. Also, set the image review display after shooting and the screen brightness.	 70
Print date	Imprint the shooting date and time on pictures at the time of shooting. The default setting is Off . <ul style="list-style-type: none"> When the scene mode is set to Sports, Museum, Backlighting with HDR set to On, Panorama, Pet portrait with Continuous, or when recording movies, date cannot be imprinted. 	 72
Vibration reduction	Reduce blurring caused by camera shake when shooting. The default setting is On . <ul style="list-style-type: none"> When using a tripod to stabilize the camera, set this feature to Off to prevent this feature from malfunctioning. 	 73

Option	Description	
Motion detection	<p>When the camera detects camera shake or subject movement at the time of shooting, it automatically increases ISO sensitivity and shutter speed to reduce blurring. The default setting is Auto.</p> <p>The  icon lights in green when the camera detects camera shake and increases shutter speed.</p> <ul style="list-style-type: none"> When using certain shooting modes or settings, motion is not detected. In this case the  icon is not displayed. 	 74
AF assist	<p>When set to Auto (default setting), the AF-assist illuminator () lights when shooting in dark surroundings to help the camera focus.</p> <ul style="list-style-type: none"> The illuminator has a range of about 3.5 m (11 ft) at the maximum wide-angle position and about 2.0 m (6 ft 6 in.) at the maximum telephoto position. Even if Auto is selected, the AF-assist illuminator may not light depending on the position of the focus area or the scene mode that is selected. 	 75
Digital zoom	<p>When set to On (default setting), the digital zoom is enabled if the zoom button T () is pressed when optical zoom is set at the maximum telephoto zoom position ()</p> <ul style="list-style-type: none"> When using certain shooting modes or settings, the digital zoom cannot be used simultaneously. 	 75
Sound settings	<p>Turn various camera sounds on and off. A beep will sound in the default setting.</p> <ul style="list-style-type: none"> When using certain shooting modes or settings, the operation sound is disabled. 	 76
Action control response	<p>Set the operation sensitivity of the action button. When this option is set to High (default setting), the operation is performed even if the camera shake movement is small. When this option is set to Low, the operation is performed if the camera shake movement is large.</p> <ul style="list-style-type: none"> When viewing images with Quick playback of action control or in full-frame playback mode, operation response of selecting images is fixed. 	 77
Auto off	<p>Set the amount of time that passes before the monitor is turned off to save power. The default setting is 5 min.</p>	 77

The Setup Menu

Option	Description	
Format memory/ Format card	Format the internal memory (only when a memory card is not inserted) or the memory card (when a memory card is inserted). <ul style="list-style-type: none"> • All data stored in the internal memory or on the memory card is deleted during formatting and cannot be restored. Be sure to transfer important images to a computer and save them before formatting. 	 78
Language	Change the camera's display language.	 78
TV settings	Select this option if no image is displayed on a TV even when the audio/video or HDMI cable is connected to the TV. HDMI device control is used for setting whether or not the camera receives signals from a TV when the TV that conforms to the HDMI-CEC standard is connected with an HDMI cable.	 79
Blink warning	When the camera detects that a human subject may have closed the eyes immediately after recognizing the face while shooting with modes other than the smart portrait mode ( 65), the Did someone blink? screen is displayed on the monitor to check the picture taken. The default setting is Off .	 80
Assign action button	Switch the operation of the action button. In the default setting, the camera displays a map when the action button is pressed.	 81
Reset all	Reset the camera's settings to their default values. <ul style="list-style-type: none"> • Some of the settings such as Time zone and date and Language are not reset. 	 81
Firmware version	View the current camera firmware version.	 84



Reference Section

The Reference Section provides detailed information and hints for using the camera.

Shooting

Using Easy Panorama (Shooting and Playing back)	02
Using Panorama Assist	05

Playback

Playing and Deleting Images Captured Using Continuous Shooting Mode (Sequence)	07
Favorite Pictures Mode	09
Auto Sort Mode.....	12
List by Date Mode	14
Editing Images (Still Pictures).....	15
Connecting the Camera to a TV (Playback on a TV).....	22
Connecting the Camera to a Printer (Direct Print)	24
Editing Movies	30

Menu



The Smart Portrait Menu.....	32
The Shooting Menu ((Auto) Mode)	34
The Playback Menu.....	42
The Movie Menu	52
Map Menu	57
The Setup Menu.....	66

Additional Information

File and Folder Names	85
Optional Accessories	87
Error Messages	88

Using Easy Panorama (Shooting and Playing back)

Taking Pictures with Easy Panorama

Display the shooting screen →  (shooting mode) button →  (the second icon from the top*) →  (panorama)

* The icon for the last scene mode selected is displayed. The default setting is  (portrait).

- 1 Select **Easy panorama** and press the  button.

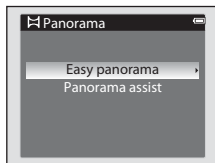

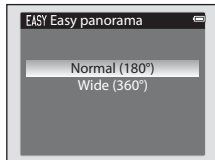

- 2 Select the shooting range from **Normal (180°)** or **Wide (360°)**, and press the  button.

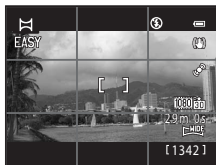

- The image size (W × H) when the camera is held in landscape orientation is as follows.
 - **Normal (180°):**
3200 × 560 when the camera is moved horizontally,
1024 × 3200 when the camera is moved vertically
 - **Wide (360°):**
6400 × 560 when the camera is moved horizontally,
1024 × 6400 when the camera is moved vertically
- For the image size when the camera is held in "tall" orientation, the combinations of the moving direction and W × H are the opposites of the above.

- 3 Frame the first portion of the panorama scene, and press the shutter-release button halfway to adjust the focus.



- The zoom is fixed at the wide-angle position.
- The framing guide is displayed on the monitor.
- The camera focuses on the subject at the center of the frame.
- Exposure compensation (58) can be adjusted.
- If the focus or exposure cannot be set for the main subject, try the focus lock (67).

4 Press the shutter-release button all the way, and release it.

- The  icons showing the panorama direction are displayed.



5 Move the camera straight and slowly in one of the four directions to start shooting.

- When the camera detects the panorama direction, the shooting starts.
- The guide showing the current shooting point is displayed.
- When the guide showing the shooting point reaches the end, the shooting ends.



Guide

Example of moving the camera

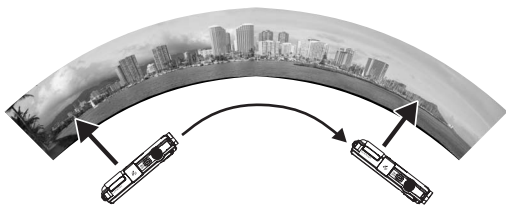

- The operator, without shifting operation, moves the camera, from end to end, horizontally or vertically in an arc.
- If about 15 seconds (in **Normal (180°)**) or 30 seconds (in **Wide (360°)**) pass from the start of the shooting, and before the guide showing the shooting point reaches the end, the shooting ends.

✓ Notes on Easy Panorama Shooting

- The image area seen in the saved image will be narrower than that seen on the monitor at the time of shooting.
- When the camera movement speed is too fast, there is a large amount of camera shake or there is little change in subject such as wall or in the dark, the shooting ends in an error.
- Panorama pictures are not saved when the shooting stops before reaching half of the panorama range.
- When the shooting reaches more than half of the panorama range but finishes before the end point, the range that is not shot will be recorded as a gray area.

Viewing Easy Panorama (Scroll)

Switch to playback mode (📖32), display the picture recorded with easy panorama in full-frame playback mode and press the **OK** button. The camera displays the short side of the picture filling the entire screen and scrolls the displayed area automatically.



- The picture is scrolled in the direction of the panorama shooting.

Playback controls are displayed at the top of the monitor during playback. When you choose a playback control with the multi selector ◀ or ▶ and press the **OK** button, the following operations can be performed.



To	Use	Description	
Rewind	◀◀	Scroll quickly back while the OK button is pressed.	
Advance	▶▶	Scroll quickly forward while the OK button is pressed.	
Pause		The following operations can be performed with the playback controls at the top of the monitor while playback is paused.	
		◀	Rewind while the OK button is pressed.
		▶	Scroll while the OK button is pressed.
		▶	Restart the automatic scroll.
End	■	Return to full-frame playback mode.	

✔ Note on Viewing Pictures Recorded with Easy Panorama

Panorama pictures recorded with functions other than easy panorama of the COOLPIX AW100 may not be scrolled or zoomed on this camera.

Using Panorama Assist

Using a tripod makes the composition easier. When using a tripod to stabilize the camera, set **Vibration reduction** (📷73) to **Off** in the setup menu.

Display the shooting screen → 📷 (shooting mode) button → 📷 (the second icon from the top*) → ▶▶▶ (panorama)

* The icon for the last scene mode selected is displayed. The default setting is 📷 (portrait).

1 Choose **Panorama assist** and press the **OK** button.

- The ▶ icons are displayed to show the direction in which pictures are joined.

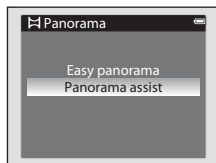

2 Use the multi selector to choose the direction and press the **OK** button.

- Select the direction in which pictures are joined in the completed panorama: right (▶), left (◀), up (▲) or down (▼).
- The yellow panorama direction icon (▶▶) is displayed for the current direction and the direction is fixed when the **OK** button is pressed. A white icon (▶) is displayed in the selected direction.
- Apply flash mode (📷54), self-timer (📷56), macro mode (📷57) and exposure compensation (📷58) settings with this step, if necessary.
- Press the **OK** button again to reselect the direction.



3 Frame the first portion of the panorama scene and take the first picture.

- The camera focuses on the subject at the center of the frame.
- 1/3 of the image will be displayed as translucent.



4 Shoot the next picture.

- Match the outline of the next picture so that 1/3 of the frame overlaps the previous picture, and press the shutter-release button.
- Repeat until you have taken the necessary number of pictures to complete the image.

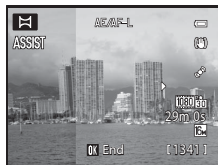

5 Press the **OK** button when shooting is completed.

- The camera returns to step 2.

✓ Notes on Panorama Assist

- Set the flash mode, self-timer, macro mode and exposure compensation before releasing the shutter for the first picture. The settings cannot be changed after shooting the first picture. Pictures cannot be deleted, nor can zoom, or **Image mode** (📖61) be adjusted after shooting the first picture.
- The panorama series is terminated if the auto off function (🔋77) triggers the standby mode during shooting. To prevent this, setting a longer time for the auto off function is recommended.

📎 AE/AF-L (exposure lock) Indicator

When using panorama assist mode, all pictures in the panorama have the same exposure, white balance, and focus as the first picture of the panorama.

When the first picture is shot, **AE/AF-L** is displayed on the monitor to indicate that exposure, white balance, and focus are locked.



📎 Panorama Creation

Transfer pictures taken to a computer (📖76) and use Panorama Maker 5 to join them in a single panorama.

Install Panorama Maker 5 on a computer using the included ViewNX 2 Installer CD.

📎 More Information

See "File and Folder Names" (🔍85) for more information.

Playing and Deleting Images Captured Using Continuous Shooting Mode (Sequence)

The images shot in the following continuous shooting mode are saved as a group (called a “sequence”) each time you shoot.

- **Continuous H, Continuous L** in **Continuous** (📷36) in the shooting menu
- **Sports** (📖40) or **Continuous** in the **Pet portrait** (📖46) scene mode

Playing Images in a Sequence

In full-frame playback mode or thumbnail playback mode (📖33), the first image of a sequence is used as the “key picture”, i.e., it is displayed to represent the images in the sequence.

While the key picture of a sequence is displayed in full-frame playback mode, press the **OK** button to display each image in the sequence individually. To return to key picture only display, press the multi selector **▲**.

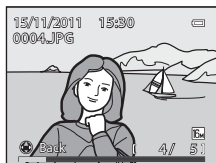

The following operations can be performed when each image in a sequence is displayed individually.

- Choose an image: Press the multi selector **◀** or **▶**.
- Zoom in: Press the zoom button **T** (📷) (📖33).

✔ **Note on Sequence**

Pictures captured continuously with cameras other than COOLPIX AW100 cannot be displayed as a sequence.

📌 **Sequence Display Options**

Select **Sequence display options** (📷51) in the playback menu to set all sequences to be displayed using their key pictures or to display them as individual images.

If an image in the sequence is selected when **Sequence display options** is set to **Individual pictures**, 📖 icon is displayed on the screen.

📌 **Changing Key Picture in Sequence**

A sequence's key picture can be changed using **Choose key picture** (📷51) in the playback menu.

Playback Menu Options Available When Using Sequence



When the **MENU** button is pressed during an image sequence playback, the following menu operations are available.



- | | | | |
|--------------------------------|--|----------------------------------|--|
| • Quick retouch ¹ | →  17 | • D-Lighting ¹ | →  17 |
| • Glamour retouch ¹ | →  18 | • Filter effects ¹ | →  19 |
| • Print order ² | →  42 | • Slide show | →  45 |
| • Protect ² | →  46 | • Rotate image ¹ | →  48 |
| • Small picture ¹ | →  20 | • Voice memo ¹ | →  49 |
| • Copy ² | →  50 | • Sequence display options | →  51 |
| • Choose key picture | →  51 | • Favorite pictures ² | →  9 |

¹ Press the **MENU** button after displaying individual images. Settings can be applied to individual images.

² When the **MENU** button is pressed during displaying only the key picture, the same settings can be applied to all images in that sequence. Press the **MENU** button after displaying individual images to apply settings to individual images.

Deleting Images in a Sequence

When **Sequence display options** ( 51) is set to **Key picture only** in the playback menu, if the  button is pressed and the deletion method is selected, the following images are deleted.

- When a sequence is displayed by its key picture only:
 - **Current image:** When the sequence is selected, all images in the sequence are deleted.
 - **Erase selected images:** When the key picture is selected in the erase selected images screen ( 35), all images in the sequence are deleted.
 - **All images:** All images including the sequence that is displayed are deleted.
- If the key picture is selected and the  button is pressed to display each individual image in the sequence before pressing the  button:

The deletion methods change to the following.

 - **Erase current picture:** Delete the image that is displayed.
 - **Erase selected images:** Select multiple images in the sequence to delete in the erase selected images screen ( 35).
 - **Erase entire sequence:** All images in the sequence, including the image that is displayed, are deleted.

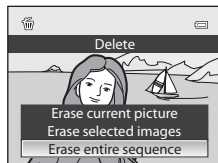

Favorite Pictures Mode

You can add favorite pictures to one of nine albums after shooting in accordance with the category (excluding movies).

After images are added, they can be easily played back using “★ favorite pictures mode.”

- It is easier to find the images when they are added to separate albums in accordance with events or type of subjects.
- The same image can be added to multiple albums.
- The maximum number of images that can be added to an album is 200.

Adding Images to Albums

Select a mode other than favorite pictures mode → MENU button → Playback menu (BOOK 11) → ★ Favorite pictures

1 Press the multi selector ◀ or ▶, and then choose an image and press ▲ to display ✓.

- To add more images to the same album, repeat this step as necessary.
- To cancel the selection, press ▼ to remove ✓.
- Press the zoom button (BOOK 29) T (Q) to switch to full-frame playback mode or W (R) to display thumbnails.



2 Display ✓ for all images to be added to an album and press the OK button to set the chosen images.

3 Use the multi selector to choose the album to which the images will be added and press the OK button.

- The selected images are added and the camera switches to the playback menu.
- To add the same image to multiple albums, select ★ **Favorite pictures** and repeat from step 1.

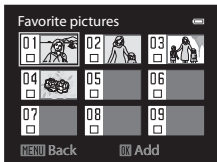

✓ Note on Favorite Pictures

When images are added to an album, they are not moved from the folder to which they were saved (BOOK 85) or copied to the album. Only the file names of the images are added to the album. When using favorite pictures mode, images are played back by retrieving the images that correspond to the file names added to the albums.

Playing Back Images in Albums

Select playback mode → button (📖70) → Favorite pictures

Use the multi selector to select an album and press the button to play back only images added to the same album.

- The following operations can be performed on the album list screen.
 - (delete) button: Delete all images in the currently selected album.
 - MENU** button: Change album icon (color and design) (11).
- When viewing images in full-frame playback mode or thumbnail playback mode, if you press the **MENU** button to display the menu and then select the tab (favorite pictures menu), you can then select a feature from the playback menu (📖71).

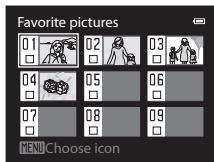

Removing Images From Albums

Select favorite pictures mode → Select an album from which images are removed (10) → button → **MENU** button → tab (📖11) → Remove from favorites

- Press the multi selector or , and then choose an image and press to display .
 - To remove more images from the same album, repeat this step as necessary.
 - To cancel the selection, press to remove .
 - Press the zoom button (📖29) **T** () to switch back to full-frame playback mode or **W** () to display thumbnails.



- Display for all images to be removed and press the button to set the chosen images.
- Choose **Yes** and press the button.
 - To cancel removal, select **No**.

Note on Deletion

If an image is deleted while using favorite pictures mode, the image will be removed from the album and it will be permanently deleted from the internal memory or the memory card.

Changing the Favorites Album Icon

Select favorite pictures mode → Select an album to change its icon (📷10) → MENU button

- 1 Press the multi selector ◀ or ▶ to choose an icon color and press the **OK** button.

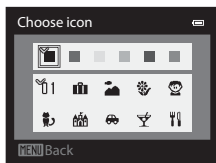

- 2 Press ▲, ▼, ◀ or ▶ to choose an icon and press the **OK** button.
 - The icon changes and the monitor display returns to the list of albums screen.

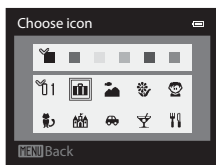

✓ Notes on Album Icons

Set the album icons separately for the internal memory and for the memory card.

- To change the album icons for the internal memory, first remove the memory card from the camera.
- The default setting for the icon is the number icon (black).

Auto Sort Mode

Captured images are automatically sorted into categories, such as portraits, landscape, and movie.

If you select **AUTO** **Auto sort** using the procedure described in “Switching Between Playback Modes” (📖70), the category selection screen is displayed.

Use the multi selector to select a category and then press the **OK** button to play back images in the selected category.

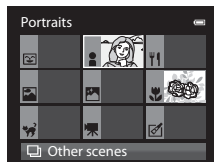

Auto Sort Mode Categories

Option	Description
Smile	Images captured in smart portrait mode (📖49) with the smile timer setting set to On
Portraits	Images captured in (auto) mode (📖51) with the face detection (📖65) Images captured in Portrait* , Night portrait* , Party/indoor , or Backlighting* scene mode (📖39) Images captured in smart portrait mode (📖50) with the smile timer setting set to Off
Food	Images captured in Food scene mode (📖39)
Landscape	Images captured in Landscape* scene mode (📖39)
Dusk to dawn	Images captured in Night landscape* , Sunset , Dusk/dawn , or Fireworks show scene mode (📖39)
Close-ups	Images captured in (auto) mode with macro mode (📖57) Images captured in Close-up* scene mode (📖39)
Pet portrait	Images captured in Pet portrait scene mode (📖39)
Movie	Movies (📖80)
Retouched copies	Copy created using editing function (🔧15)
Other scenes	All other images that cannot be defined by the categories described above

* Images captured in (easy auto) mode (📖38) are also sorted to the appropriate categories.

- The following operation can be performed while the category selection screen is displayed.
 - (delete) button: Delete all images in the selected category.
- When viewing images in full-frame playback mode or thumbnail playback mode, if you press the **MENU** button to display the menu and then select the **AUTO** tab (auto sort mode menu), you can then select a feature from the playback menu (📖71).

 **Notes on Auto Sort Mode**

- Up to 999 images and movie files can be sorted to each category in auto sort mode. If 999 images or movies have already been sorted to a specific category, new images and movies cannot be sorted to that category nor can they be displayed in auto sort mode. You can play back images and movies that could not be sorted to a category by using normal playback mode (📄32) or list by date mode (📅14).
- Images copied from the internal memory or a memory card cannot be displayed in auto sort mode.
- Images or movies saved by a camera other than COOLPIX AW100 cannot be played back in auto sort mode.

List by Date Mode

If you select **f2** **List by date** using the procedure described in “Switching Between Playback Modes” (70), the shooting date selection screen is displayed. Use the multi selector to select a date and then press the **OK** button to play back images captured on the selected date.

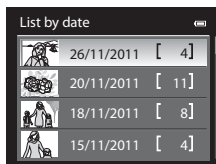

- The first picture taken on the selected date is displayed.
- The following operations can be performed while the shooting date list screen is displayed.
 - **DELETE** (delete) button: Delete all images captured on the selected date.
 - **MENU** button: If you select the **f2** tab (list by date menu) from the menu screen to display the playback menu (71), you can select one of the following features and apply that feature to images captured on the selected date.
 - Print order, slide show, protect and favorite pictures
- When viewing images in full-frame playback mode or thumbnail playback mode, if you press the **MENU** button to display the menu and then select the **f2** tab (list by date menu), you can then select a feature from the playback menu (71).
- Calendar display mode (33) cannot be used in list by date mode.

✓ Notes on List by Date Mode

- Up to 29 dates can be selected. If images exist for more than 29 dates, all images saved earlier than most recent 29 dates will be combined under **Others**.
- The 9,000 most recent images can be displayed in list by date mode.
- Pictures taken when the camera's date is not set are treated as images captured on January 1, 2011.

Editing Images (Still Pictures)

Editing Features

Images can be easily edited with this camera using the functions below. Edited images are stored as separate files (📷85).

Editing function	Application
Quick retouch (📷17)	Easily create a copy with enhanced contrast and richer colors.
D-Lighting (📷17)	Create a copy of the current picture with enhanced brightness and contrast, brightening dark portions of the picture.
Glamour retouch (📷18)	Make facial skin tones softer and make faces look smaller with larger eyes.
Filter effects (📷19)	Apply a variety of effects using digital filter. The available effects are Color options, Soft, Selective color, Cross screen, Fisheye, Miniature effect and Fog removal .
Small picture (📷20)	Create a small copy of pictures suitable for uses such as e-mail attachments.
Crop (📷21)	Crop a portion of the picture. Use to zoom in on a subject to arrange a composition.

✓ Notes on Image Editing

- Pictures shot with an **Image mode** (📖61) of 📷 4608×2592 cannot be modified.
- Pictures recorded with easy panorama cannot be edited.
- When no faces are detected in the picture, **Glamour retouch** cannot be applied (📷18).
- COOLPIX AW100's editing functions are not available for pictures taken with cameras other than COOLPIX AW100.
- If a copy created using the COOLPIX AW100 is viewed on a different digital camera, it may not be possible to display the picture properly or transfer it to a computer.
- Editing functions are not available when there is not enough free space in the internal memory or on the memory card.
- For sequences for which only a key picture is displayed (📷7), perform one of the following operations before editing.
 - Press the **OK** button to display individual images, and then select an image in the sequence
 - Set **Sequence display options** (📷51) to **Individual pictures** so that each image is displayed individually, and then select an image

Restrictions on Image Editing

The following restrictions apply when editing pictures that were created by editing.

Editing functions used	Editing functions to add
Quick retouch D-Lighting Filter effects	Glamour retouch, Small picture or Crop can be used. Quick retouch, D-Lighting or Filter effects cannot be used in combination with each other.
Glamour retouch	Quick retouch, D-Lighting, Filter effects, Small picture or Crop can be used.
Small picture Crop	No additional editing functions can be used.

- Copies created by editing cannot be edited again using the same editing function.
- When combining the small picture or crop function and another editing function, use the small picture or crop functions after other editing functions have been applied.
- Retouch effects such as the glamour retouch function's skin softening effect can be applied to pictures taken with the skin softening function during shooting.



Original Pictures and Edited Copies

- Copies created with editing functions are not deleted if the original pictures are deleted. The original pictures are not deleted if copies created with editing functions are deleted.
- Edited copies are stored with the same shooting date and time as the original.
- Even if the pictures that are marked for **Print order** (0042) or **Protect** (0046) are used for editing, these settings are not reflected on the edited copies.

Quick Retouch: Enhancing Contrast and Saturation

Select a picture (📖32) → MENU button → Playback menu (📖11) →  Quick retouch

Press the multi selector ▲ or ▼ to choose the setting level, and press the  button.

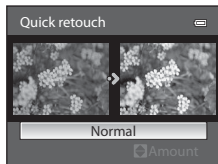

- The original version is displayed on the left and the edited version is displayed on the right.
- To cancel, press .
- Quick retouched copies can be recognized by the  icon displayed in playback mode.



D-Lighting: Enhancing Brightness and Contrast

Select a picture (📖32) → MENU button → Playback menu (📖11) →  D-Lighting

Press the multi selector ▲ or ▼ to choose **OK**, and press the  button.

- The original version is displayed on the left and the edited version is displayed on the right.
- To cancel, select **Cancel** and press the  button.
- D-Lighting copies can be recognized by the  icon displayed in playback mode.

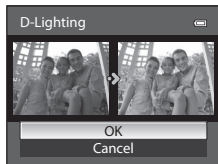

More Information

See "File and Folder Names" (📖85) for more information.

Glamour Retouch: Making Facial Skin Tones Softer, Face Smaller, or Eyes Larger



Select a picture (📖32) → MENU button → Playback menu (📖11) →  Glamour retouch

1 Press the multi selector ▲ or ▼ to select the effect type, and press the button.

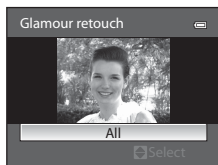
- **All:** Soften facial skin tones, make faces look smaller, and make eyes look larger.
- **Skin softening:** Make facial skin tones softer.
- A confirmation screen is displayed, and the image is displayed zoomed in on the edited face.
- To cancel, press ◀.



2 Confirm the results.

- Up to 12 faces, in order of proximity to the center of the frame, can be enhanced.
- When multiple faces are edited, press the multi selector ◀ and ▶ to switch the face that is displayed.
- To change the effect type of glamour retouch, press the MENU button and return to step 1.
- To create a copy edited with glamour retouch, press the  button.
- Copies created using the glamour retouch function can be recognized by the  icon displayed in playback mode.

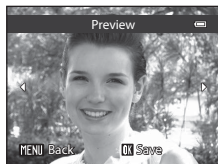

Notes on Glamour Retouch

- Depending on conditions such as the direction the subject is facing or the brightness of the face, the face may not be detected properly, or the desired effect may not be achieved.
- If no faces are detected in the image, a warning is displayed and the screen returns to the playback menu.

More Information

See "File and Folder Names" (📖85) for more information.

Filter Effects: Applying Digital Filter Effects

Select a picture (📖32) → MENU button → Playback menu (📖11) → 🎛️ Filter effects

Option	Description
Color options	Modify color tones. • Select the option from Vivid color , Black-and-white , Sepia , or Cyanotype .
Soft	Gently soften the focus of the image from the center to the edge. In pictures taken with face detection (📖65) or pet detection (📖46) selected, areas around faces will be blurred.
Selective color	Keep only selected image colors and makes other colors black-and-white.
Cross screen	Produce star-like rays of light that radiate outward from bright objects such as sunlight reflections and city lights. Suitable for night scenes.
Fisheye	Create images that look like they were shot with a fisheye lens. Suitable for pictures shot in macro mode.
Miniature effect	Create images that look like close-up photos of a diorama. Suitable for pictures shot while looking down from a high location, with the main subject near the center of the frame.
Fog removal	Reduce blurring of images caused by underwater shooting.

1 Press the multi selector ▲ or ▼ to choose the filter effect type and press the Ⓞ button.

- When **Cross screen**, **Fisheye**, **Miniature effect** or **Fog removal** is selected, proceed to step 3.

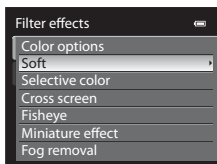

2 Adjust the effect and press the Ⓞ button.

- **Color options:** Press ▲ or ▼ to select a color tone.
- **Soft:** Press ▲ or ▼ to select the extent of the effect.
- **Selective color:** Press ▲ or ▼ to select the color to keep.

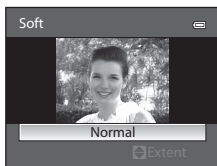

Soft

3 Check the effect and press the **OK** button.

- A new, edited copy is created.
 - To cancel, press **◀**.
-
- Copies created by editing with filter effect can be recognized by the  icon displayed in playback mode.

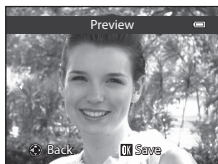

Small Picture: Reducing the Size of an Image

Select a picture (32) → MENU button → Playback menu (11) →  Small picture

1 Press the multi selector **▲** or **▼** to choose the desired copy size and press the **OK** button.

- The available size is **640×480**, **320×240** or **160×120**.

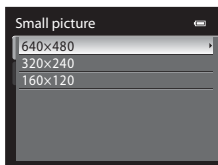

2 Select **Yes** and press the **OK** button.

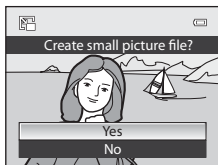

- A new, smaller copy is created.
- The compression ratio of the created image is 1:16.
- To cancel, choose **No** and press the **OK** button.
- The copy is displayed with a black frame.



More Information



See "File and Folder Names" (85) for more information.

Crop: Creating a Cropped Copy

Create a copy containing only the portion visible on the monitor when **MENU**: is displayed with playback zoom () enabled. Cropped copies are stored as separate files.

1 Enlarge the picture for cropping ()

2 Refine copy composition.

- Press the zoom button **T** () or **W** () to adjust the zoom ratio.
- Press the multi selector **▲**, **▼**, **◀** or **▶** to scroll the picture until only the portion you want to copy is visible on the monitor.



3 Press the **MENU** button.

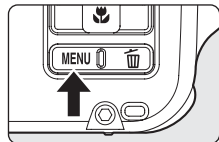

4 Use the multi selector to select **Yes** and press the **OK** button.

- A new picture, containing only the portion visible on the monitor, is created.
- To cancel, select **No** and press the **OK** button.

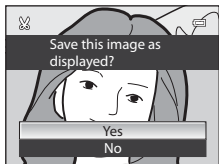





Image Size

The narrower the cropping range, the smaller the size (amount of pixels) of the cropped picture copy. When the image size setting for a cropped copy is 320×240 or 160×120, a black frame appears around the picture in playback mode, and  small picture icon is displayed on the left side of the monitor.

Cropping the Picture in its Current “Tall” Orientation

Use the **Rotate image** option () to rotate the picture so that it is displayed in landscape orientation. After cropping the picture, rotate the cropped picture back to “tall” orientation. The picture displayed in “tall” orientation can be cropped by zooming in on the picture until the black bars displayed on the both sides of the monitor disappear. The cropped picture is displayed in landscape orientation.

More Information

See “File and Folder Names” () for more information.

Connecting the Camera to a TV (Playback on a TV)

Connect the camera to a television to play back pictures on the television. If your television is equipped with an HDMI connector, you can connect it to the camera with a commercially available HDMI cable to play back movies.

- 1 Turn off the camera.

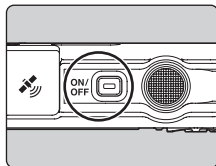

- 2 Connect the camera to the TV.

When connecting using the included audio/video cable

- Connect the yellow plug to the video-in jack on the TV, and the red and white plugs to the audio-in jacks.

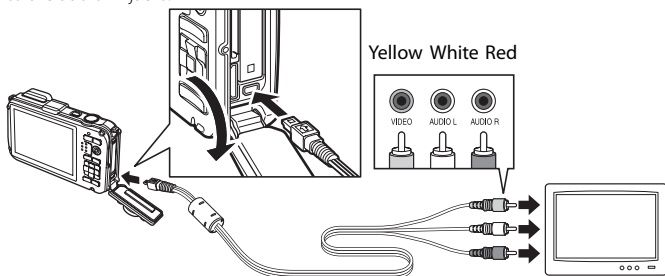

When connecting using a commercially available HDMI cable

- Connect the plug to the HDMI jack on the TV.

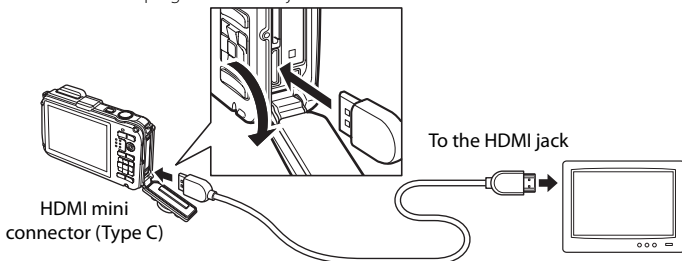

3 Tune the television to the video channel.



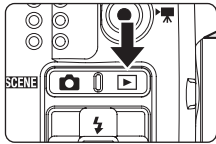

- See the instruction manual provided with your television for details.

4 Hold down the button to turn on the camera.

- The camera enters playback mode, and the recorded pictures are displayed on the television.
- While the camera is connected to the TV, the monitor remains off.



Notes on Connecting an HDMI Cable

- An HDMI cable is not included. Use a commercially available HDMI cable to connect the camera to a TV. The output terminal on this camera is a HDMI mini connector (Type C). When purchasing an HDMI cable, be sure that the device end of the cable is a HDMI mini connector.
- We recommend shooting still pictures with **Image mode** (61) set to  **2048×1536** or higher, and recording movies with **Movie options** (52) set to  **720p HD 720p (1280×720)** or higher.

Notes on Connecting the Audio/Video Cable

- When connecting the cable, be sure that the plug is oriented correctly. Do not force the plug into the camera. When disconnecting the cable, do not pull the plug at an angle.
- Do not connect cables to the HDMI mini connector and USB/audio video connector simultaneously.

When Nothing Appears on the TV

Make sure that **TV settings** (79) in the setup menu is appropriate for your television.

Using the TV's Remote Control (HDMI Device Control)

The remote control of a TV that conforms to the HDMI-CEC standard can be used to operate the camera during playback.

Instead of the multi selector or zoom buttons, the remote control can be used for picture selection, playback/pause of movies or easy panorama pictures, and switching between full-frame playback mode and four thumbnails display.

- Set **HDMI device control** (79) of **TV settings** to **On** (default setting) in the setup menu, and connect the camera to the TV with an HDMI cable.
- Point the remote control at the TV to operate.
- See your TV's instruction manual or other related documentation to check whether your TV supports the HDMI-CEC standard.

Connecting the Camera to a Printer (Direct Print)

Users of PictBridge-compatible (🔍23) printers can connect the camera directly to the printer and print pictures without using a computer. The steps for printing are as follows.

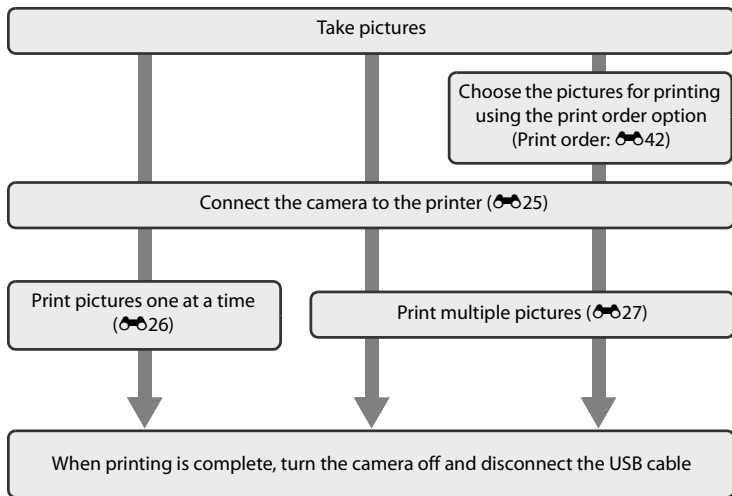

✔ Notes on Power Source

- When connecting the camera to a printer, use a fully charged battery to prevent the camera from turning off unexpectedly.
- If the AC Adapter EH-62F (available separately) (🔍87) is used, COOLPIX AW100 can be powered from an electrical outlet. Do not, under any circumstances, use an AC Adapter other than the EH-62F. Failure to observe this precaution could result in overheating or damage to the camera.

📎 Printing Pictures

In addition to printing pictures transferred to a computer and printing pictures with a direct camera-to-printer connection, the following options are also available for printing pictures recorded on the memory card:

- Insert a memory card into a DPOF-compatible printer's card slot.
- Take a memory card to a digital photo lab.

For printing using these methods, specify the pictures and the number of prints each using the **Print order** (🔍42) option in the playback menu.

Connecting the Camera to a Printer

- 1** Turn off the camera.

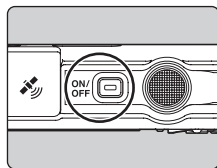

- 2** Turn on the printer.

- Check the printer settings.

- 3** Connect the camera to the printer using the included USB cable.

- Be sure that the plug is oriented correctly. When disconnecting the cable, do not pull the plug at an angle.

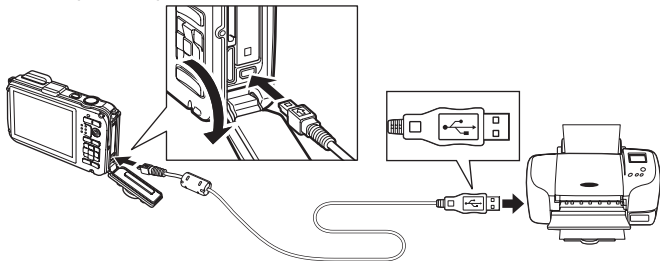

- 4** Turn on the camera.

- When connected correctly, the **PictBridge** startup screen (①) is displayed on the camera monitor. Then the **Print selection** screen (②) is displayed.

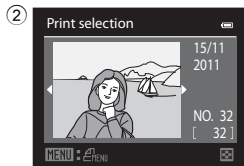
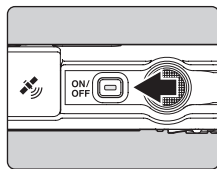

Printing Individual Images

After connecting the camera to the printer correctly (📷25), print pictures by following the procedure below.

1 Use the multi selector to choose the picture to be printed and press the **OK** button.

- Press the zoom button **W** (📐) to display 12 thumbnails, or **T** (🔍) to switch back to full-frame playback mode.

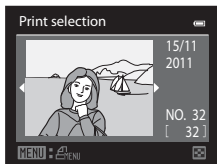

2 Choose **Copies** and press the **OK** button.

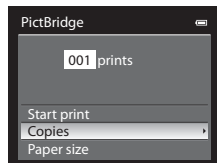

3 Choose the number of copies (up to nine) and press the **OK** button.



4 Choose **Paper size** and press the **OK** button.

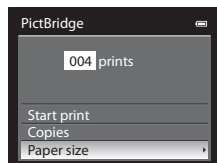

5 Choose the desired paper size and press the **OK** button.

- To specify the paper size using the printer settings, choose **Default** in the paper size menu.

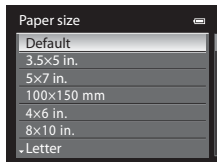

6 Choose **Start print** and press the **OK** button.

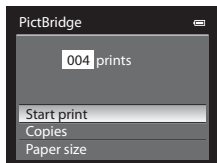

7 Printing starts.

- The monitor display returns to that shown in step 1 when printing is complete.
- To cancel before all copies have been printed, press the **OK** button.

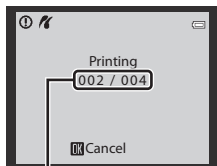

Current print/total number of prints

Printing Multiple Images

After connecting the camera to the printer correctly (📷25), print pictures by following the procedure below.

1 When the **Print selection** screen is displayed, press the **MENU** button.

- The **Print menu** screen is displayed.

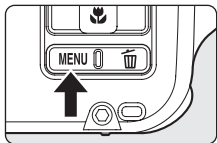

2 Use the multi selector to choose **Paper size** and press the **OK** button.

- To exit the print menu, press the **MENU** button.

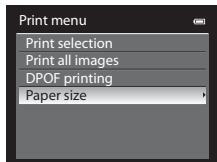

3 Choose the desired paper size and press the **OK** button.

- To specify the paper size using the printer settings, choose **Default** in the paper size menu.

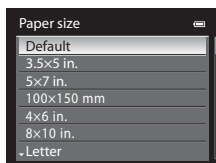

4 Choose **Print selection**, **Print all images** or **DPOF printing** and press the **OK** button.

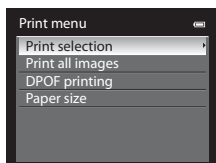

Print selection

Choose the pictures (up to a maximum of 99) and number of copies (up to nine per picture).

- Press the multi selector ◀ or ▶ to choose the pictures, and press ▲ or ▼ to set the number of copies for each.
- Pictures selected for printing can be recognized by the check mark icon and the numeral indicating the number of copies to be printed. If no copies have been specified for images, the selection is canceled.
- Press the zoom button **T** (Q) to switch to full-frame playback mode or **W** (R) to display 12 thumbnails.
- Press the **OK** button when setting is complete.
- When the menu shown on the right is displayed, choose **Start print** and press the **OK** button to start printing.
- Choose **Cancel** and press the **OK** button to return to the print menu.

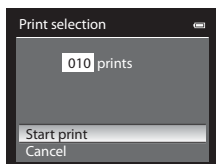
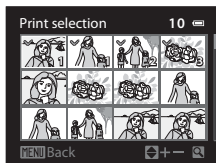

Print all images

All pictures stored in the internal memory or on the memory card are printed one per each.

- When the menu shown on the right is displayed, choose **Start print** and press the **OK** button to start printing.
- Choose **Cancel** and press the **OK** button to return to the print menu.

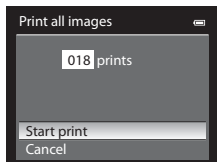
**DPOF printing**

Pictures for which a print order was created in **Print order** option (0-42) can be printed.

- When the menu shown on the right is displayed, choose **Start print** and press the **OK** button to start printing.
- Choose **Cancel** and press the **OK** button to return to the print menu.
- To view the current print order, choose **View images** and press the **OK** button. To print pictures, press the **OK** button again.

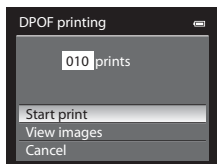
**5 Printing starts.**

- The monitor display returns to that shown in step 2 when printing is complete.
- To cancel before all copies have been printed, press the **OK** button.

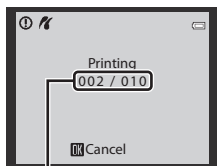

Current print/total number of prints

Paper Size





The camera supports the following paper sizes: **Default** (the default paper size for the current printer), **3.5×5 in.**, **5×7 in.**, **100×150 mm**, **4×6 in.**, **8×10 in.**, **Letter**, **A3**, and **A4**. Only sizes supported by the current printer are displayed.

Editing Movies

Extracting Only the Desired Portions of the Movie



The desired portions of a recorded movie can be saved as a separate file (except for movies recorded with  **iFrame 540 (960x540)**).







1 Play back the movie to be edited and pause at the start point of the portion that is to be extracted (84).

2 Use the multi selector  or  to choose  on the playback control and press the  button.



- The movie editing screen is displayed.





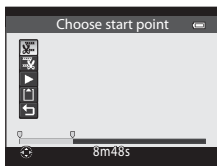

3 Press  or  to choose  (Choose start point) on the editing playback control.





- Press  or  to adjust the start position.
- To cancel, press  or  to choose  (Back) and press the  button.

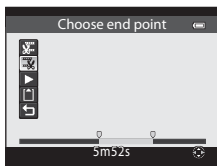

4 Press  or  to choose  (Choose end point).

- Press  or  to move the end point at the right end to the end position of the desired portion.
- To check the playback of the movie in the specified range before saving it, choose  (Preview) and press the  button. During preview playback, the volume can be adjusted with the zoom button **T/W**. To stop the preview playback, press the  button again.



5 After finishing the settings, press  or  to choose  (Save) and press the  button.

6 Choose **Yes** and press the  button.

- The edited movie is saved.
- To cancel the saving, choose **No**.

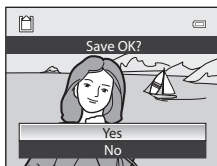

 Notes on Editing Movies

- Once a movie is created through editing, it cannot be used again for extracting a movie. To extract another range, select and edit the original movie.
- Because the edited movies are extracted in 1-second units, they may vary slightly from the set start point and end point. Sections shorter than two seconds cannot be extracted.
- Editing functions are not available when there is not enough free space in the internal memory or on the memory card.

 More Information

See "File and Folder Names" ( 85) for more information.

The Smart Portrait Menu

Image Mode (Image Size and Quality)

See “Changing the Image Size (Image Mode)” (📖61) for more information on **Image mode**.

Skin Softening

Display the shooting screen in smart portrait mode (📖49) → MENU button → 📷 tab (📖11) → Skin softening

Enable skin softening.

When the shutter is released, the camera detects one or more human faces (up to three), and processes the image to make facial skin tones softer before saving the image. The degree of skin softening applied can be selected from **High**, **Normal** (default setting), and **Low**.

- When skin softening is enabled, the icon for the current setting is displayed on the monitor during shooting (📖6). When **Off** is selected, an icon for the current setting is not displayed. The effects of skin softening are not visible when framing pictures for shooting. Check the degree of skin softening performed in playback mode.

Smile Timer

Display the shooting screen in smart portrait mode (📖49) → MENU button → 📷 tab (📖11) → Smile timer

When **On** (default setting) is selected, the camera detects human faces and then automatically releases the shutter whenever a smile is detected.

- When smile timer is enabled, the icon for the current setting is displayed on the monitor during shooting (📖6). When **Off** is selected, an icon for the current setting is not displayed.

Blink Proof

Display the shooting screen in smart portrait mode (📖49) → MENU button → 📷 tab (📖11) → Blink proof

When **On** is selected, the camera automatically releases the shutter twice each time a picture is taken. Of the two shots, one in which the subject's eyes are open is saved.

- If the camera saved an image in which the subject's eyes may have been closed, the dialog shown on the right is displayed for a few seconds.
- Flash cannot be used when **On** is selected.
- The default setting is **Off**.
- When blink proof is enabled, the icon for the current setting is displayed on the monitor during shooting (📖6). When **Off** is selected, an icon for the current setting is not displayed.



The Shooting Menu (📷 (Auto) Mode)

Image Mode (Image Size and Quality)

See “Changing the Image Size (Image Mode)” (📖61) for more information on **Image mode**.

White Balance (Adjusting Hue)

Display the shooting screen in 📷 (Auto) mode (📖51) → MENU button → 📷 tab (📖11) → White balance

The color of light reflected from an object varies with the color of the light source. The human brain is able to adapt to changes in the color of the light source, with the result that white objects appear white whether seen in the shade, direct sunlight, or under incandescent lighting. Digital cameras can mimic this adjustment of the human eye by processing images according to the color of the light source. This is known as “white balance.” For natural colors, select a white balance setting that matches the light source before shooting.

Although the default setting, **Auto**, can be used under most types of lighting, you can apply the white balance setting suited to a particular light source to achieve more accurate results.

Option	Description
AUTO Auto (default setting)	White balance is automatically adjusted to suit lighting conditions. Best choice in most situations.
PRE Preset manual	Useful when shooting under unusual lighting. See “Using Preset Manual” for more information (📷35).
☀️ Daylight	White balance adjusted for direct sunlight.
💡 Incandescent	Use under incandescent lighting.
💡 Fluorescent	Use under fluorescent lighting.
☁️ Cloudy	Use when taking pictures under overcast skies.
🔦 Flash	Use with the flash.

The icon for the current setting other than **Auto** is displayed on the monitor (📖6).

📌 Notes on White Balance

- At white-balance settings other than **Auto** or **Flash**, set the flash mode to ⏻ (off) (📖54).
- This feature may not be used in combination with certain features. See “Features That Cannot Be Used Simultaneously” (📖63) for more information.

Using Preset Manual

Use when white balance setting (**Auto**, **Incandescent**, etc.) may not produce the desired results, such as when shooting under unusual lighting conditions (e.g., when you want to make pictures taken under lamps with reddish-light look as though they were shot in normal light).

Use the procedure below to measure the white balance value under the lighting used during shooting.

1 Place a white or gray reference object under the lighting that will be used during shooting.

2 Display the shooting menu (📖51), use the multi selector to set **White balance to PRE Preset manual**, then press the **OK** button.

- The lens extends to the zoom position for measurement.

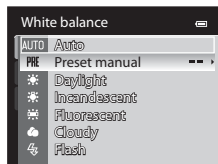

3 Choose **Measure**.

- To apply the most recently measured white balance value, select **Cancel** and press the **OK** button. The most recently measured white balance value will be set.

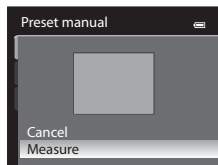

4 Frame a white or gray reference object in the reference object frame.

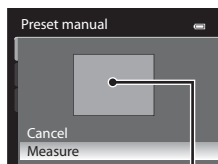

Reference object frame

5 Press the **OK** button to measure the white balance value.

- The shutter is released and the new white balance preset value is set (no picture is recorded).

✔ Note on Preset Manual

The camera cannot measure a white balance value for when the flash fires. When shooting with the flash, set **White balance to Auto or Flash**.

Continuous Shooting

Display the shooting screen in 📷 (Auto) mode (📖51) → MENU button → 📷 tab (📖11) → Continuous

Change the settings for continuous shooting and BSS (Best Shot Selector).

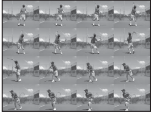
Option	Description
📷 Single (default setting)	One picture is shot each time the shutter-release button is pressed.
📷 Continuous H	While the shutter-release button is pressed all the way, images are captured continuously at a rate of about 7.1 frames per second (when the image mode is 📷 4608×3456). Shooting ends when the shutter-release button is released, or three pictures have been taken continuously.
📷 Continuous L	While the shutter-release button is pressed all the way, about 12 pictures are captured continuously at a rate of about 1.4 frames per second (when the image mode is 📷 4608×3456).
BSS BSS (Best Shot Selector)	BSS is recommended for shooting under low lighting without the flash, with the camera at telephoto zoom position, or in other situations in which camera shake is likely to blur pictures. The camera takes up to ten images while the shutter-release button is pressed all the way. The sharpest image (image with the most details) in the series is automatically selected and saved.
📷 Multi-shot 16	Each time the shutter-release button is pressed all the way, the camera shoots 16 pictures at a rate of about 30 frames per second and arranges them in a single picture. <ul style="list-style-type: none"> • The image mode is fixed at 📷 (2560 × 1920 pixels). • The digital zoom is not available. 

The icon for the current setting other than **Single** is displayed on the monitor (📖6).

✓ Notes on Continuous Shooting

- Focus, exposure and white balance are fixed at the values for the first picture in each series.
- The frame rate may become slower depending on the image mode, memory card type or shooting conditions.
- This feature may not be used in combination with certain features. See "Features That Cannot Be Used Simultaneously" (📖63) for more information.

✓ Note on Best Shot Selector

BSS is suited for shooting stationary subjects. **BSS** may not produce the desired results if the subject moves or the composition changes.

✓ Note on Multi-shot 16

Banding or variance in brightness or hue may occur in images that were captured under lighting that flickers at high speeds, such as fluorescent, mercury-vapor, or sodium-vapor lighting.

ISO Sensitivity

Display the shooting screen in 📷 (Auto) mode (📖51) → MENU button → 📷 tab (📖11) → ISO sensitivity

The higher the ISO sensitivity, the less light needed for taking pictures.

The higher the ISO sensitivity, the darker the subject that can be shot. Additionally, even with subjects of similar brightness, pictures can be taken at faster shutter speeds, and blurring caused by camera shake and subject movement can be reduced.

- Setting the ISO sensitivity to a high level is effective when shooting dark subjects, not using the flash, shooting at the telephoto zoom position and similar situations, but the pictures taken may be slightly grainy.

Option	Description
Auto (default setting)	Sensitivity is ISO 125 when there is sufficient lighting; the camera compensates by raising sensitivity to a maximum of ISO 800 when lighting is dim.
Fixed range auto	Sensitivity is ISO 125–400 when the camera automatically adjusts ISO sensitivity. ISO sensitivity does not exceed the maximum value. Set the maximum value for ISO sensitivity for effective control over the amount of “grain” that appears in images.
125, 200, 400, 800, 1600, 3200	ISO sensitivity is locked at the specified value.

The icon for the ISO sensitivity setting is displayed on the monitor (📖6).

- When **Auto** is selected, the **ISO** icon is not displayed at ISO 125, but is displayed if the ISO sensitivity automatically increases to more than 125 (📖28).
- When **Fixed range auto** is selected, **ISO** icon and the maximum value for ISO sensitivity are displayed.



✔ Note on ISO Sensitivity Settings

This feature may not be used in combination with certain features. See “Features That Cannot Be Used Simultaneously” (📖63) for more information.

AF Area Mode

Display the shooting screen in 📷 (Auto) mode (📖51) → MENU button → 📷 tab (📖11) → AF area mode

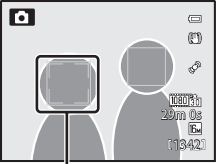
You can set how the camera selects the focus area for autofocus.

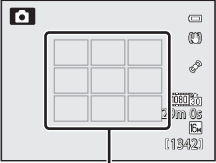
Option	Description
 <p>Face priority (default setting)</p>	<p>The camera detects and focuses on a face (see “Using Face Detection” (📖65) for more information). If more than one face is detected, the camera focuses on the face closest to the camera. When non-human subjects are photographed, or a subject with which no face can be detected is framed, AF area mode is set to Auto. The camera automatically selects the focus area (up to nine areas) containing the subject closest to the camera.</p>  <p style="text-align: center;">Focus area</p>
 <p>Auto</p>	<p>The camera automatically selects the focus area (up to nine areas) containing the subject closest to the camera. Press the shutter-release button halfway to activate the focus area. When the shutter-release button is pressed halfway, the focus area selected by the camera is displayed on the monitor (up to nine areas).</p>  <p style="text-align: center;">Focus areas</p>

Option	Description
<p>☐ Manual</p>	<p>Choose manually the focus position from 99 areas in the screen. This option is suited to situations in which the intended subject is relatively still and not positioned at the center of the frame. Press the multi selector ▲, ▼, ◀ or ▶ to select one of 99 focus areas displayed on the monitor's focus-area selection screen, and shoot.</p> <ul style="list-style-type: none"> To adjust the following settings, press the OK button to temporarily cancel focus area selection, and then adjust each setting. <ul style="list-style-type: none"> - Flash mode, macro mode or self-timer - Exposure compensation <p>To return to the focus area selection screen, press the OK button again.</p>
<p>☐ Center</p>	<p>The camera focuses on the subject at the center of the frame. The focus area is always displayed at the center of the frame.</p>
<p>☐ Subject tracking</p>	<p>Subject tracking begins once you select a subject to be focused on, and the focus area will move and follow the subject. See "Subject Tracking Mode (Focusing on a Moving Subject)" (🎮40).</p>

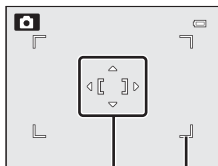

Focus area Selectable areas

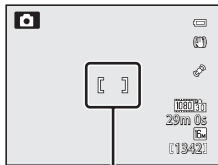

Focus area

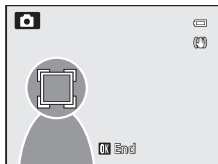

☑ Notes on AF Area Mode

- When the digital zoom is in effect, the camera focuses on the subject at the center of the frame regardless of the applied **AF area mode** option.
- In some rare cases of shooting subjects for which autofocus does not perform as expected (📖31), the subject may not be in focus.
- This feature may not be used in combination with certain features. See "Features That Cannot Be Used Simultaneously" (📖63) for more information.

Subject Tracking Mode (Focusing on a Moving Subject)

Display the shooting screen in 📷 (Auto) mode (📖51) → MENU button → 📷 tab (📖11) → AF area mode

Choose this mode to shoot moving subjects. Subject tracking begins once you select a subject to be focused on, and the focus area will move and follow the subject.

1 Use the multi selector to select Subject tracking and press the button.

- The camera enters subject tracking mode, and a white border is displayed at the center of the frame.

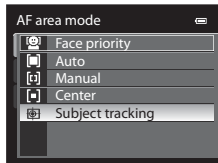

2 Frame the subject at the center of the border, and press the button.

- The subject is registered.
- When the camera is unable to focus on the subject, the border lights in red. Change the composition and try again.
- Once the subject is registered, it is framed by a yellow focus area display, and subject tracking begins.
- Press the  button to cancel the registration of the subject.
- If the camera loses sight of the subject, the focus area display disappears; register the subject again.

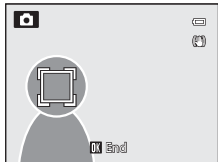
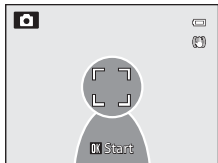

3 Press the shutter-release button to take the picture.

- If the camera focuses on the focus area when the shutter-release button is pressed halfway, the focus area display lights in green and the focus is locked.
- If the shutter-release button is pressed halfway while the focus area is not displayed, the camera focuses on the subject at the center of the frame.

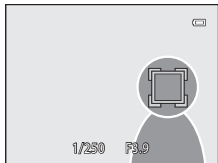

✓ Notes on Subject Tracking

- The digital zoom is not available.
- Set the zoom position, flash mode, or menu settings before registering a subject. If any of these are changed after a subject is registered, the subject will be canceled.
- During certain conditions, such as when the subject is moving quickly, when there is a large amount of camera shake, or when there are multiple subjects that look alike, the camera may not be able to register or track a subject, or the camera may track a different subject. Additionally, the subject may not be tracked properly depending on factors such as the subject's size and brightness.
- In some rare cases of shooting subjects for which autofocus does not perform as expected (📖31), the subject may not be in focus despite the fact that the focus area lights in green. If you cannot focus, change the AF area mode setting to **Manual** or **Center**, or try shooting with focus lock (📖67) by refocusing on another subject at the same distance.
- This feature may not be used in combination with certain features. See "Features That Cannot Be Used Simultaneously" (📖63) for more information.

Autofocus Mode

Display the shooting screen in 📷 (Auto) mode (📖51) → MENU button → 📷 tab (📖11) → Autofocus mode

Choose how the camera focuses.

Option	Description
AF-S Single AF (default setting)	The camera focuses only when the shutter-release button is pressed halfway.
AF-F Full-time AF	The camera focuses continuously until the shutter-release button is pressed down halfway. Use with moving subjects. A sound will be heard while the camera focuses.

✓ Note on AF mode

This feature may not be used in combination with certain features. See "Features That Cannot Be Used Simultaneously" (📖63) for more information.

✎ Autofocus Mode for Movie Recording

Autofocus mode for movie recording can be set with **Autofocus mode** (📷56) in the movie menu.

The Playback Menu

See “Editing Images (Still Pictures)” (📷15) for the function of editing features (**Quick retouch, D-Lighting, Glamour retouch, Filter effects, Small picture**).

🖨️ Print Order (Creating a DPOF Print Order)

Press the  button (Playback mode) → MENU button (📖11) → 🖨️ Print order

If you choose to use one of the following methods to print pictures that are stored on a memory card, the pictures to print and the number of copies can be set in advance on the memory card.



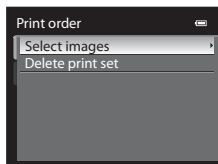

- Printing with a DPOF-compatible (📷23) printer that is equipped with a card slot.
- Ordering the prints from a digital photo lab that has a DPOF service.
- Printing by connecting the camera to a PictBridge-compatible (📷24) printer (📷24). (When the memory card is removed from the camera, the print orders can also be performed for the pictures stored on the internal memory.)

1 Use the multi selector to choose **Select images** and press the **OK** button.

- When favorite pictures mode (📷9), auto sort mode (📷12) or list by date mode (📷14) is selected, the menu shown on the right is not displayed. Proceed to the step 2.



2 Choose the pictures (up to a maximum of 99) and number of copies (up to nine per picture).

- Press the multi selector  or  to choose the pictures, and press  or  to set the number of copies for each.
- Pictures selected for printing can be recognized by the check mark icon and the numeral indicating the number of copies to be printed. If no copies have been specified for images, the selection is canceled.
- Press the zoom button **T** (📷) to switch to full-frame playback mode or **W** (📷) to display 12 thumbnails.
- Press the **OK** button when setting is complete.



3 Choose whether or not to also print shooting date and shooting information.

- Choose **Date** and press the **OK** button to print the shooting date on all pictures in the print order.
- Choose **Info** and press the **OK** button to print shooting information (shutter speed and aperture value) on all pictures in the print order.
- Choose **Done** and press the **OK** button to complete the print order.

Pictures selected for printing are recognized by the  icon displayed in playback mode.

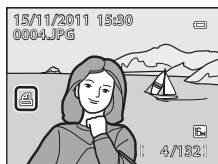
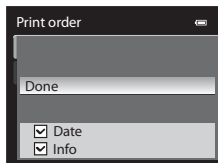

Notes on Printing Shooting Date and Shooting Information

When the **Date** and **Info** options are enabled in the print order menu, shooting date and shooting information are printed on pictures when a DPOF-compatible (:23) printer which supports printing of shooting date and shooting information is used.

- Shooting information cannot be printed when the camera is connected directly to a printer, via the included USB cable, for DPOF printing (:29).
- **Date** and **Info** are reset each time the **Print order** menu is displayed.
- The date and time printed on the picture is the date and time recorded on the camera when the picture was taken. The date and time printed using this option are not affected if the camera's **Time zone and date** setting is changed from the setup menu after the pictures are taken.



✓ Notes on Print order

When a print order is created in favorite pictures mode, auto sort mode, or list by date mode, the screen shown below is displayed if pictures other than those in the selected album, category, or shooting date have been marked for printing.

- Select **Yes** to add the print order setting to the existing print order.
- Select **No** to remove the existing print order and restrict the print order setting.

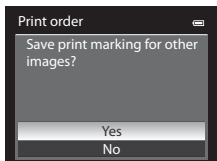

Favorite pictures mode
or auto sort mode

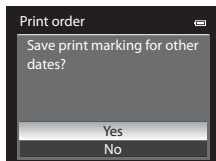

List by date mode

Additionally, if there are more than 99 pictures as a result of adding the current print order settings, the screen shown below will be displayed.

- Select **Yes** to remove the existing print order and restrict the print order setting.
- Select **Cancel** to retain the existing print order and remove the print order setting.

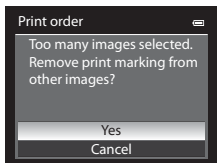

Favorite pictures mode
or auto sort mode

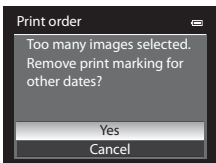

List by date mode



✎ Deleting All Print Orders

In step 1 of the print order procedure (📷42), choose **Delete print order** and press the Ⓞ button to delete the print orders for all pictures.

✎ Print Date



The shooting date and time can be imprinted in pictures at the time of shooting by using **Print date** (📷72) in the setup menu. This information can be printed even from printers that do not support printing of the date and time. Only the date and time of print date on the pictures are printed, even if **Print order** is enabled with the date selected in the print order screen.

Slide Show

Press the  button (Playback mode) → MENU button (11) →  Slide show



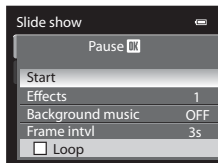

View pictures stored in the internal memory or on a memory card in an automatic slide show.

1 Use the multi selector to choose **Start** and press the button.

- Before selecting **Start**, select the following options and press the  button to change the setting.
 - **Effects**: Select the effect for a slide show from **Classic** (default setting) or **Zoom**.
 - **Background music**: Select BGM from **On/Off** (default setting).
 - **Frame intvl**: Select **Manual advance only** or display time of an image.
- To repeat the slide show automatically, enable **Loop** and press the  button before choosing **Start**. The check mark () is added to the loop option when enabled.





2 The slide show begins.

- Press the multi selector  to display the next picture, or  to display the previous picture. Press and hold  to fast forward, or  to rewind.
- When **Background music** is set, press the zoom button **T** or **W** to adjust the volume.
- To exit partway or pause, press the  button.





3 Choose End or Restart.



- When exiting or pausing the slide show, the screen shown on the right is displayed. Choose  and press the  button to return to step 1. Choose  to play the slide show again.



Notes on Slide Shows

- Only the first frame of movies (84) included in slide shows is displayed.
- For sequences (51) whose sequence display options are set to **Key picture only**, only the key picture is displayed.
- Pictures recorded with easy panorama are displayed in full-frame playback mode when played in a slide show. They do not scroll.
- Slide shows play for a maximum of 30 minutes, even when **Loop** is selected (.



Protect

Press the  button (Playback mode) → MENU button (11) →  Protect

Protect selected pictures from accidental deletion.

In the picture selection screen, choose a picture and set or cancel protection. See “The Image Selection Screen” (47) for more information.

Note, however, that formatting the camera’s internal memory or the memory card permanently erases the protected files (78).

Protected pictures are recognized by the  icon in playback mode (8).

The Image Selection Screen

The image selection screen is displayed in the following menus.

Only one image can be selected for some menu items, while for other menu items, multiple images can be selected.

Functions for which only one image can be selected	Functions for which multiple images can be selected
<ul style="list-style-type: none"> • Playback menu: Rotate image (🔍48), Choose key picture (🔍51) • Setup menu: Select an image in Welcome screen (🔍66) 	<ul style="list-style-type: none"> • Playback menu: Select images in Print order (🔍42), Protect (🔍46), Selected images in Copy (🔍50), Favorite pictures (🔍9), Remove from favorites (🔍10) • Erase selected images in Deleting unnecessary images (📖34)

Follow the procedure described below to select images.

1 Press the multi selector ◀ or ▶ to choose the desired image.

- Press the zoom button **T** (🔍) to switch to full-frame playback mode or **W** (📐) to switch to 12 thumbnails.
- For functions for which only one image is selected, proceed to step 3.



2 Press ▲ or ▼ to select or deselect (or the number of copies).

- When an image is selected, a check mark (☑) is displayed with the image. Repeat steps 1 and 2 to select additional images.



3 Press the (OK) button to apply the image selection.

- With selections such as **Selected images**, the confirmation dialog is displayed. Follow the instructions on the screen.

Rotate Image

Press the  button (Playback mode) → MENU button (11) →  Rotate image



Change the orientation of pictures played back in the camera's monitor after shooting. Still pictures can be rotated 90° clockwise or counterclockwise.

Pictures that were recorded in the "tall" orientation can be rotated up to 180° in either direction.

Select a picture in the picture selection screen (47) to display the rotate image screen. Press the multi selector ◀ or ▶ to rotate the picture 90°.

Press the  button to set the orientation displayed and save the orientation data with the picture.

Rotating Images in a Sequence

While the key picture of a sequence is displayed, images cannot be rotated. Apply the setting after displaying individual images (7, 51).



Voice Memo

Press the  button (Playback mode) → MENU button (11) →  Voice memo

Use the camera's microphone to record voice memos for pictures.

- The recording screen is displayed for a picture without voice memo, while the voice memo playback screen is displayed for a picture with voice memo (a picture marked with  in full-frame playback mode).

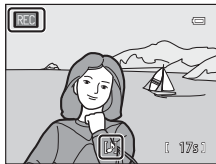

Recording Voice Memos

- Recording ends after about 20 seconds or when the  button is released.
- Do not touch the microphone during recording.
- During recording, **REC** and  blink on the monitor.
- When recording ends, the voice memo playback screen is displayed.





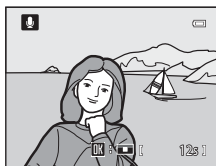

Playing Voice Memos

Pictures for which voice memos have been recorded are indicated by  in full-frame playback mode.

- Press the  button to play back a voice memo. To end playback, press the  button again.
- Press the zoom button **T** or **W** during playback to adjust playback volume.
- Press the multi selector  before or after playing a voice memo to return to the playback menu. Press the **MENU** button to exit the playback menu.



Deleting Voice Memos

Press the  button on the voice memo playback screen. Press the multi selector  or  to select **Yes** and press the  button to delete only the voice memo.





Notes on Voice Memos

- When a picture with a voice memo attached is deleted, both the picture and its voice memo are deleted.
- Voice memos cannot be recorded for a picture that already has a voice memo attached on it. The current voice memo must be deleted before a new voice memo can be recorded.
- COOLPIX AW100 is not able to record a voice memo for a picture taken with cameras other than COOLPIX AW100.
- Voice memos cannot be deleted for a picture in **Protect** (46).

More Information



See "File and Folder Names" (85) for more information.

Copy (Copy Between Internal Memory and Memory Card)

Press the  button (Playback mode) → MENU button (11) →  Copy



Copy pictures between the internal memory and a memory card.

1 Use the multi selector to select an option from the copy screen and press the button.

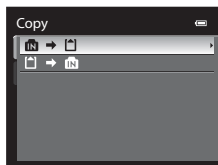
- : Copy pictures from the internal memory to the memory card.
- : Copy pictures from the memory card to the internal memory.







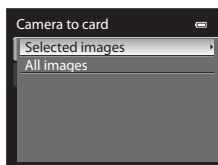



2 Select a copy option and press the button.

- **Selected images:** Copy pictures selected from the image selection screen (47). If a sequence for which only a key picture is displayed is selected (7), all pictures in the displayed sequence are copied.
- **All images:** Copy all pictures. If a picture in a sequence is selected, this option is not displayed.
- **Current sequence:** This option is displayed when a picture in a sequence has been selected before displaying the playback menu. All pictures in the current sequence are copied.



Notes on Copying Pictures

- JPEG-, MOV-, and WAV-format files can be copied. Files recorded in any other format cannot be copied.
- "Voice Memo" (49) attached to pictures and **Protect** setting (46) are also copied with the pictures.
- Pictures recorded with another make or model of camera or that have been modified on a computer cannot be copied.
- **Print order** settings(42) and the contents of the album (9) are not copied with the pictures.
- Pictures or movies copied from the internal memory or a memory card cannot be displayed in auto sort mode (12).
- If **Sequence display options** (51) is set to **Key picture only** and a picture in the sequence is selected and the  button is pressed to display individual pictures (7), only  (memory card to internal memory) image copy is available.

 Message: “Memory contains no images.”



If there are no pictures stored on the memory card when playback mode is selected, the message, **Memory contains no images.**, is displayed. Press the **MENU** button to display the copy option screen, and copy the pictures stored in the camera’s internal memory to the memory card.

 More Information

See “File and Folder Names” (85) for more information.

 Sequence Display Options

Press the  button (Playback mode) → **MENU** button (11) →  Sequence display options



Choose the method used to display a series of pictures shot continuously (sequence, 7) when viewing them in full-frame playback mode (32) or in thumbnail playback mode (33).

Settings are applied to all sequences, and the setting is saved in the camera’s memory even if the camera is turned off.

Option	Description
Individual pictures	Each picture in a sequence is displayed.
Key picture only (default setting)	Return a sequence in which pictures are displayed individually to the key picture only display.

 Choose Key Picture



Press the  button (Playback mode) → **MENU** button (11) →  Choose key picture

When **Sequence display options** is set to **Key picture only**, the key picture displayed in full-frame playback mode (32) or thumbnail playback mode (33) can be set for each sequence of pictures.

- When changing this setting, before pressing **MENU**, first select the desired sequence using full-frame playback mode or thumbnail playback mode.
- When the key picture selection screen is displayed, select a picture. See “The Image Selection Screen” (47) for more information.

The Movie Menu

Movie Options





Display the shooting screen → MENU button →  (Movie) tab (11) → Movie options

You can choose the type of movie to shoot.

The camera can record normal speed movies and HS (high speed) movies ()54), which can be played back in slow motion or fast motion.

The larger the image size and bit rate, the higher the image quality; however, the file size also becomes larger.

Normal Speed Movies

Option	Description
 HD 1080p★ (1920×1080) (default setting)	Movies with an aspect ratio of 16:9 are recorded. <ul style="list-style-type: none">• Movie bitrate: 14 Mbps• Frame rate: 30 frames per second
 HD 1080p (1920×1080)	Movies with an aspect ratio of 16:9 are recorded. <ul style="list-style-type: none">• Movie bitrate: 12 Mbps• Frame rate: 30 frames per second
 HD 720p (1280×720)	Movies with an aspect ratio of 16:9 are recorded. <ul style="list-style-type: none">• Movie bitrate: 9 Mbps• Frame rate: 30 frames per second
 iFrame 540 (960×540)	Movies with an aspect ratio of 16:9 are recorded. It is one of the formats supported by Apple Inc. <ul style="list-style-type: none">• Movie bitrate: 24 Mbps• Frame rate: 30 frames per second When using the camera's internal memory for recording, the movie recording may end unexpectedly depending on the composition of the image. Using a memory card (Class 6 or higher) is recommended when taking important movies.
 VGA (640×480)	Movies with an aspect ratio of 4:3 are recorded. <ul style="list-style-type: none">• Movie bitrate: 3 Mbps• Frame rate: 30 frames per second

Note on iFrame 540 (960×540)





The movie editing functions cannot be used.

More Information

See "Maximum Movie Length" (82) for more information.

HS Movies

See “Recording Movies in Slow Motion and Fast Motion (HS Movie)” (054) for more information.

Option	Description
 HS 240 fps (320×240)	1/8-speed slow motion movies with an aspect ratio of 4:3 are recorded. <ul style="list-style-type: none"> • Max. movie length*: 10 s (playback time: 1 min 20 s) • Movie bitrate: 640 kbps • Frame rate: 240 frames per second
 HS 120 fps (640×480)	1/4-speed slow motion movies with an aspect ratio of 4:3 are recorded. <ul style="list-style-type: none"> • Max. movie length*: 15 s (playback time: 1 min) • Movie bitrate: 3 Mbps • Frame rate: 120 frames per second
 HS 60 fps (1280×720)	1/2-speed slow motion movies with an aspect ratio of 16:9 are recorded. <ul style="list-style-type: none"> • Max. movie length*: 30 s (playback time: 1 min) • Movie bitrate: 9 Mbps • Frame rate: 60 frames per second
 HS 15 fps (1920×1080)	2x speed fast motion movies with an aspect ratio of 16:9 are recorded. <ul style="list-style-type: none"> • Max. movie length*: 2 min (playback time: 1 min) • Movie bitrate: 14 Mbps • Frame rate: 15 frames per second

* The maximum recording time refers only to the section shot for slow motion or fast motion playback.

- The movie bitrate is the volume of movie data recorded per second. As a variable bitrate (VBR) system has been adopted, the movie recording rate varies automatically according to the subject so that more data is recorded per second for movies containing frequently moving subjects, thus increasing movie file size.

Open with HS Footage

Display the shooting screen → MENU button →  (Movie) tab (11) → Open with HS footage

Select whether or not to record slow motion or fast motion movies from the start of the recording when HS movies are recorded.

Option	Description
On (default setting)	HS movies are recorded when recording begins.
Off	Normal speed movies are recorded when recording begins. Press the  button to switch to HS movie recording at the point where the camera should record for slow motion or fast motion playback.

Recording Movies in Slow Motion and Fast Motion (HS Movie)

Display the shooting screen → MENU button →  (Movie) tab (11) → Movie options



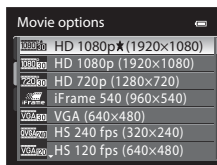

HS (high speed) movies can be recorded. Movies recorded using HS movie can be played back in slow motion at 1/8, 1/4 or 1/2 of normal playback speed, or played back in fast motion at a speed two times faster than normal speed. While recording movies, the camera can be switched from normal speed movie recording to slow motion or fast motion movie recording.

1 Use the multi selector to select HS movie (53) and press the **OK** button.

- Press the **MENU** button after changing the settings and return to the shooting screen.



2 Press the (movie-record) button to start recording.

- The monitor is turned off for a moment, and then the HS movie recording starts.
- The camera focuses at the center of the frame. Focus areas are not displayed during recording.
- When recording movies with  **HS 60 fps (1280x720)** or  **HS 15 fps (1920x1080)**, monitor display changes to an aspect ratio of 16:9.
- When the **Open with HS footage** (53) is set to **Off**, normal speed movies are recorded when recording begins. Press the **OK** button to switch to HS movie recording at the point where the camera should record for slow motion or fast motion playback.
- The camera switches between normal speed movie recording and HS movie recording each time the **OK** button is pressed.
- If recording time for HS movies (53) runs out, the camera switches to normal speed movie recording.
- When recording HS movies, the maximum movie length display changes and displays the amount of recording time available for HS movie recording.
- The HS movie options show the type of HS movie that will be recorded and change depending on the type of movie being recorded.

HS movie options

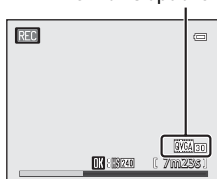

When recording normal speed movies



When recording HS movies

3 Press the (movie-record) button to end recording.

✓ Notes on HS Movie

- Portions recorded for slow motion or fast motion playback is not recorded with sound.
- Zoom position, focus, exposure and white balance are locked when the  button is pressed to start recording.

HS Movie

Recorded movies can be played back at about 30 frames per second, including portions recorded using HS movie.

When **Movie options** () in the movie menu is set to **VGA₄₂₀ HS 240 fps (320×240)**, **VGA₄₂₀ HS 120 fps (640×480)** or **720₆₀ HS 60 fps (1280×720)**, movies that can be played back in slow motion can be recorded.

When set to **1080₁₅ HS 15 fps (1920×1080)**, movies that can be played back in fast motion at a speed two times faster than normal speed can be recorded.

Portions recorded at **VGA₄₂₀ HS 120 fps (640×480)**:

A movie of up to 15 seconds in length is recorded when recording for the purpose of high-speed capture. Movies recorded at high speed can be played back in slow motion at a speed four times slower than normal speed.

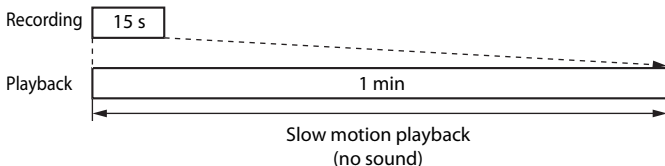

Portions recorded at **1080₁₅ HS 15 fps (1920×1080)**:

A movie of up to 2 minutes in length is recorded when recording for the purpose of high-speed playback. Playback is two times faster.

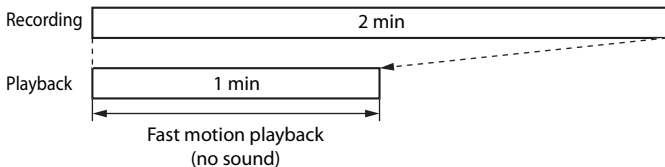

Autofocus Mode

Display the shooting screen → MENU button →  (Movie) tab (📖11) → Autofocus mode

Choose how the camera focuses when recording normal speed movies (52).

Option	Description
AF-S Single AF (default setting)	Lock on the focus when the  (Movie-record) button is pressed to start recording. Select this option when the distance between the camera and the subject remains fairly consistent.
AF-F Full-time AF	The camera focuses continuously during movie recording. Suitable for shooting when the distance between the camera and subject changes. The operation sound when the camera focuses may be recorded. Setting to Single AF is recommended if the sound is noticeable.

Movie Light

Display the shooting screen → MENU button →  (Movie) tab (📖11) → Movie light

Enable or disable the movie light that assists recording in dark places during movie recording.

Option	Description
On	The movie light is turned on for lighting when movies are recorded.
Off (default setting)	The movie light is turned off.

Wind Noise Reduction

Display the shooting screen → MENU button →  (Movie) tab (📖11) → Wind noise reduction

Set whether or not to reduce wind noise during normal-speed movie recording (52).

Option	Description
 On	The noise of wind blowing on the camera's built-in microphone is minimized during recording. This setting is suitable for recording in strong winds. Other sounds may become difficult to hear in playback mode.
OFF Off (default setting)	Wind noise is not reduced.

When **On** is selected, an icon for this setting is displayed on the monitor during movie recording (📖6).

Map Menu

GPS Settings

Display a map (📖88) → MENU button → 🌐 tab (📖11) → GPS options

Option	Description
Record GPS data	When set to On , signals are being received from the GPS satellite, and positioning starts (📖86). <ul style="list-style-type: none">The default setting is Off.
Synchronize	Signals from the GPS satellite are used to set the date and time of the camera's internal clock (only when Record GPS data in GPS options of the map menu is set to On). Check the positioning status before starting Synchronize.
Update A-GPS file	A memory card is used to update the A-GPS (assist GPS) file. Using the latest A-GPS file can shorten the time needed for tracking of the position information.

Updating the A-GPS File

Download the latest A-GPS file from the website below, and use it to update the file.

<http://nikonimglib.com/agps/index.html>

- The A-GPS file for COOLPIX AW100 is only available from the website above.

- 1 Download the latest A-GPS file to the computer from the website.
- 2 Use a card reader or other device to copy the downloaded file to the "NCFL" folder of the memory card.
 - The "NCFL" folder is located directly under the memory card root directory. If the memory card does not have "NCFL" folder, create a new folder.
- 3 Insert the memory card containing the copied file into the camera.
- 4 Turn on the camera, and press the action button to display a map.
- 5 Press the MENU button to display the map menu, and use the multi selector to select **GPS options**.
- 6 Select **Update A-GPS file**, and update the file.

Notes on Synchronize

- Date/time adjustment by **Synchronize** is set according to the time zone set in **Time zone and date** (📖24, 🏠67) of the setup menu. Check the time zone before setting **Synchronize**.
- The date/time set using **Synchronize** is not as accurate as radio clocks. Use **Time zone and date** in the setup menu to set the time if it is not accurate in **Synchronize**.

Notes on Updating A-GPS File





- The validity period of the A-GPS file is seven days. The validity period can be checked on the update screen.
- Once the validity period of the A-GPS file has expired, tracking of the position information will not become faster. Updating of the A-GPS file before using the GPS feature is recommended.

Distance Units

Display a map (📖88) → MENU button → 🌐 tab (📖11) → Distance units

The distance units of the map display can be selected from **km (m)** (kilometers, meters) (default setting) or **mi (yd)** (miles, yards).

Calculate Distance



Press the  button (Playback mode) → Display a map (88) → MENU button →  tab (11) → Calculate distance

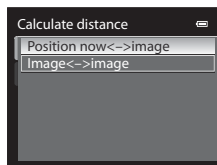

This calculates the linear distance from the current location to the shooting location on the image or between the shooting locations of two images.

1 Use the multi selector to select the target for calculating the distance, and press the  button.



- **Position now<->image**: Calculates the distance from the current location to the image shooting location (only when **Record GPS data** in **GPS options** of the map menu is set to **On**). Confirmation of the current position starts. Proceed to step 3.
- **Image<->image**: Calculates the distance between the shooting locations of two images.



2 Press  or  to select the image that is the start point, and press the  button.

- To adjust the scale of the map, use the zoom button (**W** /**T** ).



3 Press  or  to select the image that is the end point.

- Each time an image is selected, the distance is displayed on the screen.
- Press the  button to end the distance calculation.



Distance

Note on Distance Calculation

If the position information is not recorded on the image, the distance cannot be calculated.

Points of interest (POI) (Recording and Displaying Location Name Information)

Display a map (📖88) → MENU button → 🌐 tab (📖11) → Points of interest (POI)

This shows how to set the POI (point of interest, location name information).

Option	Description
Embed POI	<p>When set to On, the location name information is recorded on the pictures to be shot.</p> <ul style="list-style-type: none"> • The default setting is Off. • The location name information can be recorded on a still image or video.
Display POI	<p>When set to On, the location name information is displayed on the shooting screen or playback screen (📖6, 8).</p> <ul style="list-style-type: none"> • The default setting is Off.
Level of detail	<p>Set the display level of the location name information. A higher display level shows more detailed regional information, and a lower display level shows regional information for a wider area (such as country names).</p> <p>When set to level 1, country names are displayed. When set to level 6, landmark names (facilities) are displayed. The information displayed for levels 2 to 5 vary depending on the country where the map is displayed.</p>
Edit POI	<p>If Update POI is selected during playback mode, the location name information recorded on the image can be changed.</p> <ul style="list-style-type: none"> • When level 6 is selected, press the multi selector ◀ or ▶ to change the landmark name. • To change the map information level, press the multi selector ▲ or ▼. <p>If Remove POI is selected, the location name information recorded on the image is deleted.</p>

POI Display

If there is no location name information in the display level that was set, "—" is displayed.

Create Log (Record the log of moving information)

Display a map (☰88) → MENU button → 🗺️ tab (☰11) → Create log

When log recording starts, the measured tracking information for a certain duration is recorded until a preset time has elapsed. To display the log data (🗺️63), save it to a memory card.

- 1 Use the multi selector to select **Start log**, and press the **OK** button.

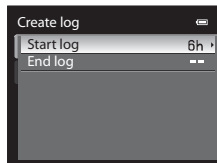

- 2 Select the duration that the log will be recorded, and press the **OK** button.

- Log recording starts.
- The log data is recorded every minute until the preset time is reached.
- **LOG** is displayed on the screen during log recording.

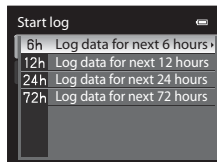

- 3 When log recording is completed, select **End log** in **Create log** in the map menu, and press the **OK** button.

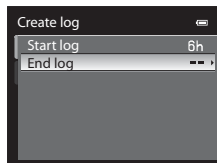

4 Select **Save log**, and press the **OK** button.

- The log data is saved to a memory card.

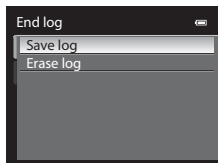

✓ **Notes on Log Recording**

- If the date and time are not set, the log cannot be recorded.
- If the date and time is changed in **Time zone and date** (📖24, 🎧67) in the setup menu or **Synchronize** in **GPS options** (🎧57) of the map menu during log recording, log recording is canceled.
- Log recording is paused during the operations below. Log recording resumes once these operations are canceled.
 - During continuous shooting
 - During movie recording
 - When connected with a USB cable
- Although the log recording time elapses based on the internal clock even if the camera battery is removed, the log is not recorded.
- The log data is temporarily stored in the camera. New logs cannot be recorded if the log data remains in the camera. After recording log data, save it to a memory card.
- A maximum of 36 log data events can be recorded in one day.
- A maximum of 100 log data events can be saved to a single memory card.

✍ **To Erase Log Data**

- To erase the log data that is temporarily stored in the camera, select **Erase log** in step 4.
- To erase the log data that is stored in the memory card, press the **🗑** button in **View log** (🎧63).

View Log (View the log on a map)

Display a map (📖88) → MENU button → 🗺️ tab (📖11) → View log

Display on the map the log data saved in the memory card using **Create log** (🔑61) to check your movement route.

1 Use the multi selector to select the log data to be displayed, and press the **OK** button.

- The movement route is indicated by a blue line.



2 Check the movement route.

- To adjust the scale of the map, use the zoom button (**W** 🗺️/**T** 🔍).
- To move the map display, use the multi selector ▲, ▼, ◀, or ▶.
- To erase the displayed log data, press the 🗑️ button.



To Erase Log Data

To erase the log data, press the 🗑️ button in step 1.

- Selected log:** The selected log data is erased.
- All logs:** All log data stored on the memory card is erased.

📎 Log Data

Log data is NMEA format-compliant. However, display in any software or on any camera is not guaranteed.

Electronic Compass

Display a map (📖88) → MENU button → 🌐 tab (📖11) → Electronic compass

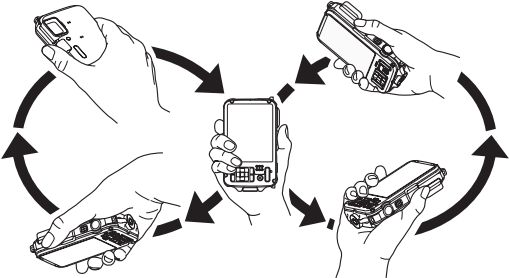
Option	Description
<p>Compass display</p>	<p>When set to On, a compass is displayed on the shooting screen.</p> <ul style="list-style-type: none"> • The default setting is Off. • The compass indicator changes based on the direction that the camera is held (📖6). • Compass display gives indication of direction for the destination from the actual location on the basis of measured direction information. <ul style="list-style-type: none"> - Display style: north, east, south and west - Display range: 16 cardinal points - The red arrow of the circle compass display points north.
<p>Compass correction</p>	<p>Correct the compass when the compass direction is not displayed correctly.</p> <p>When the screen shown on the right is displayed, swing the camera to draw a figure eight in the air while turning your wrist to face the camera forward and backward, side to side, or up and down.</p> <div data-bbox="687 575 933 754" style="border: 1px solid black; padding: 5px; margin: 10px 0;"> <p>Compass correction</p> <p>Move camera in a figure eight</p>  </div> 

 Notes on Using the Digital Compass

- The digital compass is not displayed when the camera lens is facing upwards.
- Do not use the digital compass in this camera for mountain climbing and other specialized applications. The displayed information is intended as a general guide only.
- Direction may not be measured correctly near the following objects: magnet, metal, electrical motor, electrical home appliance or electrical power cable
- Direction may not be measured correctly in the following places: in automobiles, trains, ships, airplanes, inside buildings or in underground malls
- Direction may not be measured correctly if the position information is not recorded.

The Setup Menu

Welcome Screen

Press the **MENU** button → **Y** tab (📖11) → Welcome screen

Choose whether or not to display the welcome screen on the monitor when the camera is turned on.

Option	Description
None (default setting)	Display the shooting or playback screen without displaying the welcome screen.
COOLPIX	Display the welcome screen before displaying the shooting or playback screen.
Select an image	Select an image taken to display as the welcome screen. Display the image selection screen, choose an image (📷47), and press the OK button to register it. <ul style="list-style-type: none">• Because the selected image is stored in the camera, the image appears in the welcome screen even if the original image is deleted.• Pictures taken with Image mode (📖61) of 4608x2592, pictures recorded with easy panorama (📷2), and pictures created with small picture (📷20) or crop function (📷21) that are 320x240 or smaller cannot be registered.

Time Zone and Date

Press the MENU button → Y tab (📖11) → Time zone and date

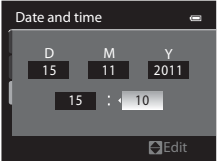
Option	Description
Date and time	<p>Set the camera clock to the current date and time. Use the multi selector to set the date and time.</p> <ul style="list-style-type: none"> Choose an item: Press ► or ◀ (selected in the following order: D (day) → M (month) → Y (year) → hour → minute). Set the contents: Press ▲ or ▼. Finish setting: Choose minute and press the OK button or ►. 
Date format	<p>Choose the order in which the day, month, and year are displayed (Year/Month/Day, Month/Day/Year or Day/Month/Year).</p>
Time zone	<p>🏠 Home time zone can be specified and daylight saving can be enabled or disabled. When ➡ travel destination is registered, the time difference (🕒69) from the 🏠 home time zone is automatically calculated and the local date and time are recorded. Useful when traveling.</p>

Setting the Travel Destination Time Zone

1 Use the multi selector to choose **Time zone** and press the **OK** button.

- The **Time zone** screen is displayed.

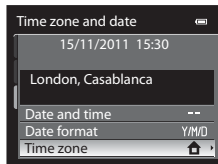

2 Choose **Travel destination** and press the **OK** button.

- The date and time displayed on the monitor change according to the region currently selected.

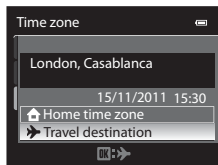

3 Press **▶**.

- The time zone selection screen is displayed.

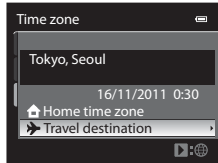

4 Press **◀** or **▶** to choose the travel destination (Time zone).

- The time difference between home and the travel destination is displayed.
- When using the camera in an area where daylight saving time is in effect, turn on the daylight saving setting with **▲**. When set to on, the **☀** icon is displayed on the top of the monitor and the clock advances by one hour. To turn off, press **▼**.
- Press the **OK** button to register the travel destination time zone.
- While the travel destination time zone is selected, the **▶** icon is displayed on the monitor when the camera is in shooting mode.

Time difference

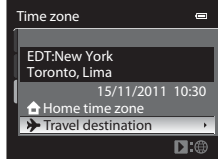
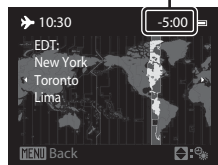

Home Time Zone

- To switch to the home time zone, choose **Home time zone** in step 2 and press the **OK** button.
- To change the home time zone, choose **Home time zone** in step 2 and perform the same procedure as for **Travel destination** to set the home time zone.

 **Time Zones**

The camera supports the time zones listed below.

For time differences not listed below, set the camera clock using **Time zone and date**.

UTC +/-	Location	UTC +/-	Location
-11	Midway, Samoa	+1	Madrid, Paris, Berlin
-10	Hawaii, Tahiti	+2	Athens, Helsinki, Ankara
-9	Alaska, Anchorage	+3	Moscow, Nairobi, Riyadh, Kuwait, Manama
-8	PST (PDT): Los Angeles, Seattle, Vancouver	+4	Abu Dhabi, Dubai
-7	MST (MDT): Denver, Phoenix	+5	Islamabad, Karachi
-6	CST (CDT): Chicago, Houston, Mexico City	+5.5	New Delhi
-5	EST (EDT): New York, Toronto, Lima	+6	Colombo, Dhaka
-4.5	Caracas	+7	Bangkok, Jakarta
-4	Manaus	+8	Beijing, Hong Kong, Singapore
-3	Buenos Aires, Sao Paulo	+9	Tokyo, Seoul
-2	Fernando de Noronha	+10	Sydney, Guam
-1	Azores	+11	New Caledonia
±0	London, Casablanca	+12	Auckland, Fiji



Monitor Settings

Press the MENU button → Y tab (11) → Monitor settings

Option	Description
Photo info	Select information displayed on the monitor during shooting and playback mode.
Image review	On (default setting): Picture is displayed on the monitor immediately after shooting and the monitor display returns to shooting screen. Off : Picture is not displayed immediately after shooting.
Brightness	Choose from five settings to select the monitor brightness. The default setting is 3 .

Photo info

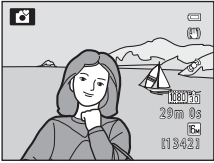
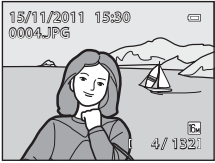
Select whether or not the photo information is displayed on the monitor. See “The Monitor” (6) for more information on indicators displayed on the monitor.

	Shooting mode	Playback mode
Show info	 The monitor shows a woman's portrait in the foreground and a landscape with mountains and a sailboat in the background. An information overlay in the bottom right corner displays: 1880/15, 29m 0s, and 113421. A battery icon is in the top right corner.	 The monitor shows the same scene as the shooting mode. The information overlay in the top left corner displays: 15/11/2011 15:30 and 0004.JPG. A battery icon is in the top right corner, and a photo counter '4/1821' is in the bottom right corner.
Auto info (default setting)	The same information as in Show info is displayed. If no operations are performed after a few seconds, the display will be the same as Hide info . The information is displayed again when an operation is performed.	
Hide info	 The monitor shows the same scene as the shooting mode, but without the information overlay.	 The monitor shows the same scene as the playback mode, but without the information overlay.

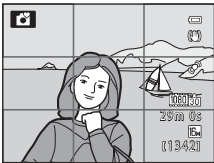
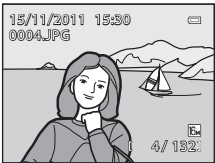
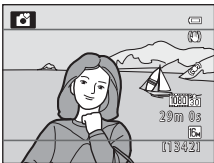
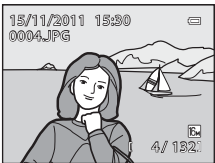
	Shooting mode	Playback mode
Framing grid+auto info	 <p>In addition to information shown with Auto info above, a framing grid is displayed to help frame pictures. It is not displayed while recording movies.</p>	 <p>The same information as in Auto info is displayed.</p>
Movie frame+auto info	 <p>In addition to information shown with Auto info above, the movie frame is displayed before recording movies.</p>	 <p>The same information as in Auto info is displayed.</p>

Print Date (Imprinting Date and Time on Pictures)

Press the **MENU** button → **Y** tab (☞11) → **Print date**

The shooting date and time can be imprinted on pictures at the time of shooting. This information can be printed even from printers that do not support printing of the date and time (🔍43).



Option	Description
DATE Date	The date is imprinted on pictures.
DATE Date and time	The date and time are imprinted on pictures.
OFF Off (default setting)	The date and time are not imprinted on pictures.

The icon for the current setting other than **Off** is displayed on the monitor (☞6).

✓ Notes on Print Date

- Imprinted dates cannot be deleted from the image, nor can dates be imprinted after the picture has been taken.
- Dates cannot be imprinted in the following situations.
 - When the scene mode is set to **Sports, Museum, Backlighting** with **HDR** set to **On**, **Panorama**, or **Pet portrait** with **Continuous**
 - When **Blink proof** (🔍33) in smart portrait mode is set to **On**
 - During movie recording
- This feature may not be used in combination with certain features. See "Features That Cannot Be Used Simultaneously" (☞63) for more information.
- Dates imprinted with an **Image mode** (☞61) setting of **16M 640×480** may be difficult to read. Set the image size to **1024×768** or higher.
- The date is recorded using the format selected in the setup menu's **Time zone and date** option (☞24, 🔍67).

✍ Print date and Print order



When printing from DPOF-compatible printers which support printing of shooting date and shooting information, the date and information can be printed on pictures without the date and time being imprinted on them with **Print date**, using options in the **Print order** menu (🔍42).

Vibration Reduction

Press the **MENU** button → **Y** tab (📖11) → **Vibration reduction**

Specify the vibration reduction setting for shooting still pictures or movies. Correct blur, caused by slight hand movement known as camera shake, that commonly occurs when shooting with zoom applied or at slow shutter speeds.

When using a tripod to stabilize the camera, set vibration reduction to **Off**.

Option	Description
 On (hybrid)	Record with optical compensation for camera shake during still picture shooting using the lens shift method, and under the following conditions, also performs electronic VR using image enhancement. <ul style="list-style-type: none"> • When the flash does not fire • When the shutter speed is slower than 1/60 second • When the self-timer is off • When Single is selected for the Continuous setting
 On (default setting)	Compensate for camera shake using the lens shift method. The camera automatically detects the panning direction and only corrects for vibration caused by camera shake. When the camera is panned horizontally, for example, vibration reduction only reduces vertical shake. If the camera is panned vertically, vibration reduction only compensates for horizontal shake.
OFF Off	Vibration reduction is not enabled.

The icon for the current setting other than **Off** is displayed on the monitor (📖6).

✔ Notes on Vibration Reduction

- It may take a few seconds to activate vibration reduction after the power is turned on or the camera enters shooting mode from playback mode. Wait until the display stabilizes before shooting.
- Due to characteristics of the vibration reduction function, images displayed on the camera's monitor immediately after shooting may appear blurry.
- Vibration reduction may be unable to completely eliminate the effects of camera shake in some situations.
- When the camera shake is extremely high or low, picture compensation with electronic VR may not be possible even when **On (hybrid)** is set.
- When the shutter speed is fast or extremely slow, electronic VR may not operate even when **On (hybrid)** is set.
- When electronic VR in **On (hybrid)** operates, saving the picture takes longer than normal, because when the picture is shot, the shutter is released twice automatically to perform picture compensation. **Shutter sound** (🔊76) is heard only once. One frame is recorded.

Motion Detection

Press the MENU button → Y tab (📖11) → Motion detection

Enable motion detection to reduce the effects of camera shake and subject movement when shooting still pictures.

Option	Description
 Auto (default setting)	<p>If the camera detects the movement of the subject or camera shake, the ISO sensitivity is raised and the shutter speed is increased to reduce their effects.</p> <p>However, motion detection does not function in the following situations.</p> <ul style="list-style-type: none"> • When the flash fires • In the following scene modes: Sports, Night portrait, Dusk/dawn, Night landscape, Museum, Fireworks show, Backlighting and Pet portrait • When Continuous (🔍36) is set to Multi-shot 16 • When ISO sensitivity (🔍37) is set to other than Auto • When AF area mode is set to Subject tracking
OFF Off	Motion detection does not function.

When **Auto** is selected, an icon for this setting is displayed on the monitor (📖6). The motion detection icon lights in green when the camera detects any vibration and increases the shutter speed.

✓ Notes on Motion Detection

- Motion detection may be unable to completely reduce effects of camera shake and subject movement in some situations.
- Motion detection may not function if the subject exhibits significant movement or is too dark.
- The pictures taken may become grainy.
- This feature may not be used in combination with certain features. See “Features That Cannot Be Used Simultaneously” (📖63) for more information.

AF Assist

Press the MENU button → Y tab (📖11) → AF assist

Enable or disable the AF-assist illuminator that assists the autofocus when the lighting is dim.

Option	Description
Auto (default setting)	<p>AF-assist illuminator lights automatically if the lighting is dim. The illuminator has a range of about 3.5 m (11 ft) at the maximum wide-angle position and about 2.0 m (6 ft 6 in.) at the maximum telephoto position.</p> <ul style="list-style-type: none"> For some focus areas and scene modes such as Museum (📖43) and Pet portrait (📖46), AF-assist illuminator does not turn on even if Auto is set.
Off	AF-assist illuminator does not light. The camera may be unable to focus if lighting is dim.

Digital Zoom

Press the MENU button → Y tab (📖11) → Digital zoom

Enable or disable the digital zoom.

Option	Description
On (default setting)	If the zoom button T (📖) is pressed when optical zoom is set at the maximum telephoto zoom position, digital zoom (📖29) will be activated.
Off	Digital zoom is not activated.

✓ Notes on Digital Zoom

- When the digital zoom is used, the camera focuses at the center of the frame.
- The digital zoom cannot be used when **Portrait**, **Night portrait**, **Backlighting** with **HDR** set to **On**, **Pet portrait**, **Underwater**, or smart portrait mode is selected in scene mode.
- This feature may not be used in combination with certain features. See “Features That Cannot Be Used Simultaneously” (📖63) for more information.

Sound Settings

Press the **MENU** button → **Y** tab (📖11) → **Sound settings**

Adjust the following sound settings.

Option	Description
Button sound	Set the following all sound settings to On (default setting) or Off . <ul style="list-style-type: none"> • Setting beep (beep sounds once when the settings are completed) • Focus beep (beep sounds twice when the camera focuses on the subject) • Error beep (beep sounds three times when an error is detected) • Start-up sounds
Shutter sound	Choose whether to set the shutter sound to On (default setting) or Off .

✓ Notes on Sound Settings

- In **Pet portrait** scene mode, even when **On** is set, the button sound and shutter sound are disabled.
- Even when **On** is set, the shutter sound is disabled during movie recording.
- This feature may not be used in combination with certain features. See "Features That Cannot Be Used Simultaneously" (📖63) for more information.

Action Control Response

Press the MENU button → Y tab (📖11) → Action control response

Set the sensitivity of the operation performed when shaking the camera (action control) (📖13). When this option is set to **High** (default setting), the operation is performed even if the camera shake movement is small. When this option is set to **Low**, the operation is performed if the camera shake movement is large.

Note on Action Control Response

When viewing images with **Quick playback** of action control or in full-frame playback mode, operation response of selecting images is fixed.

Auto Off

Press the MENU button → Y tab (📖11) → Auto off

If no operations are performed for a certain period while the camera is on, the monitor is turned off to save power and the camera enters standby mode (📖23). This option sets the amount of time allowed to elapse before the camera enters standby mode.

Choose from **30 s**, **1 min**, **5 min** (default setting) and **30 min**.

Auto Off Setting

In the following situations, the time taken for the camera to enter standby mode is fixed.

- When menus are displayed: three minutes
- During slideshow playback: maximum of 30 minutes
- When the AC Adapter EH-62F is connected: 30 minutes

Format Memory/Format Card

Press the MENU button → Y tab (📖11) → Format memory/Format card

Format the internal memory or a memory card.

Formatting permanently deletes all data in the internal memory or memory card. The deleted data cannot be recovered. Be sure to transfer important pictures to a computer before formatting.

Formatting the Internal Memory

To format the internal memory, remove the memory card from the camera. The **Format memory** option is displayed in the setup menu.

Formatting Memory Cards

When a memory card is inserted in the camera, the memory card can be formatted. The **Format card** option is displayed on the setup menu.

Formatting Internal Memory and Memory card

- When formatting the camera's internal memory or the memory card, album icons (📖11) are reset to their default icons (number icon).
- Do not turn off the camera or open the battery-chamber/memory card slot cover during formatting.
- The first time you insert a memory card that has been used in another device into this camera, be sure to format it with this camera.

Language

Press the MENU button → Y tab (📖11) → Language

Choose one of 29 languages for displaying the camera menus and messages.

Čeština	Czech	Nederlands	Dutch	Türkçe	Turkish
Dansk	Danish	Norsk	Norwegian	Українська	Ukrainian
Deutsch	German	Polski	Polish	عربي	Arabic
English	(default setting)	Português (BR)	Brazilian Portuguese	简体中文	Simplified Chinese
Español	Spanish	Português (PT)	Portuguese	繁體中文	Traditional Chinese
Ελληνικά	Greek	Русский	Russian	日本語	Japanese
Français	French	Română	Romanian	한글	Korean
Indonesia	Indonesian	Suomi	Finnish	ภาษาไทย	Thai
Italiano	Italian	Svenska	Swedish	हिन्दी	Hindi
Magyar	Hungarian	Tiếng Việt	Vietnamese		

TV Settings

Press the **MENU** button → **Y** tab (📖11) → **TV settings**

Adjust the settings for connecting to a TV.

Option	Description
Video mode	Select the analog video output system from NTSC and PAL in accordance with your TV.
HDMI	Choose a picture resolution for HDMI output from Auto (default setting), 480p , 720p , or 1080i . When Auto is set, the output resolution that is best suited to the connected TV is selected automatically from 480p , 720p or 1080i .
HDMI device control	Choose whether or not the camera receives signals from a TV when a TV that conforms to the HDMI-CEC standard is connected with an HDMI cable. When set to On (default setting), the television remote control can be used to operate the camera during playback. See "Using the TV's Remote Control (HDMI Device Control)" (🔍23) for more information.

HDMI and HDMI-CEC

"HDMI" is an abbreviation of High-Definition Multimedia Interface, which is one type of multimedia interface.

"HDMI-CEC" is an abbreviation of HDMI-Consumer Electronics Control, which enables operations to be linked between compatible devices.

Blink Warning

Press the **MENU** button → **Y** tab (📖11) → **Blink warning**

Choose whether or not blinking eyes are detected when using face detection (📖65) in the following shooting modes.

- 📷 (Easy auto) mode
- In the following scene modes: **Portrait** (📖40) or **Night portrait** (📖41)
- 📷 (Auto) mode (when **Face priority** (📷38) is selected for **AF area mode**)

Option	Description
On	The Did someone blink? screen is displayed on the monitor if the camera detects that a human subject may have closed the eyes immediately after recognizing the face. The face of the human subject that may have closed his/her eyes is framed by a yellow border. You can check the picture taken and determine if you need to take the picture again.
Off (default setting)	The camera does not detect blinks.

The Did someone blink? Screen

If no operations are performed for a few seconds, the screen automatically returns to the shooting screen.

- To zoom in to the face for which blinking was detected, press the zoom button **T** (🔍). To return to full-frame playback mode, press the zoom button **W** (📷).
- When the camera detects that one or more human subjects have closed their eyes, press **▲**, **▼**, **◀** or **▶** during playback zoom to display other faces.
- Press the **🗑️** button to delete the picture taken.
- Press the **OK** button to return to shooting screen.



✔️ Note on Blink Warning

This feature may not be used in combination with certain features. See "Features That Cannot Be Used Simultaneously" (📖63) for more information.

Assign Action Button

Press the MENU button → Y tab (📖11) → Assign action button

Set the function to be performed when the action button (📖13) is pressed.

Option	Description
Display map (default setting)	Display a map (📖13).
Action control	Operate the function by shaking the camera (action control).

Reset All

Press the MENU button → Y tab (📖11) → Reset all

When **Reset** is selected, the camera settings are restored to the default values.

Pop-up Menu

Option	Default value
Flash mode (📖54)	Auto
Self-timer (📖56)	OFF
Macro mode (📖57)	OFF
Exposure compensation (📖58)	0.0

Scene Mode

Option	Default value
Scene (📖39)	Portrait
Hue adjustment in Food mode (📖43)	Center
HDR in Backlighting (📖44)	Off
Panorama (📖45)	Normal (180°) in Easy panorama
Pet portrait (📖46)	Pet portrait auto release: ON Continuous: Continuous

Special Effects Mode

Option	Default value
Special effects (📖47)	Soft

Smart Portrait Menu

Option	Default value
Skin softening (🔍32)	Normal
Smile timer (🔍32)	On
Blink proof (🔍33)	Off

Shooting Menu

Option	Default value
Image mode (📖61)	 4608x3456
White balance (🔍34)	Auto
Continuous (🔍36)	Single
ISO sensitivity (🔍37)	Auto
AF area mode (🔍38)	Face priority
Autofocus mode (🔍41)	Single AF

Movie Menu

Option	Default value
Movie options (🔍52)	 HD 1080p★ (1920x1080)
Open with HS footage (🔍53)	On
Autofocus mode (🔍56)	Single AF
Movie light (🔍56)	Off
Wind noise reduction (🔍56)	Off

Map Menu

Option	Default value
Record GPS data (🔍57)	Off
Distance units (🔍58)	km (m)
Embed POI (🔍60)	Off
Display POI (🔍60)	Off
Level of detail (🔍60)	Level 6 (detailed)
Compass display (🔍64)	Off

Setup Menu

Option	Default value
Welcome screen (🔍66)	None
Photo info (🔍70)	Auto info
Image review (🔍70)	On

Option	Default value
Brightness (🔧70)	3
Print date (🔧72)	Off
Vibration reduction (🔧73)	On
Motion detection (🔧74)	Auto
AF assist (🔧75)	Auto
Digital zoom (🔧75)	On
Button sound (🔧76)	On
Shutter sound (🔧76)	On
Action control response (🔧77)	High
Auto off (🔧77)	5 min
HDMI (🔧79)	Auto
HDMI device control (🔧79)	On
Blink warning (🔧80)	Off
Assign action button (🔧81)	Display map

Others

Option	Default value
Paper size (🔧26, 🔧27)	Default
Slide show (🔧45)	Effects: Classic Background music: Off Frame intvl: 3 s
Album icons and color (🔧11)	Number icon (black)

- Choosing **Reset all** also clears the current file number (🔧85) in the memory. After resetting, numbering continues from the lowest number available in the internal memory or the memory card. If **Reset all** is performed after all pictures are deleted from the internal memory or memory card (📖34), the file numbers for the next pictures taken start from **0001**.
- The following settings remain unaffected even if **Reset all** is performed.
 - Shooting menu:** Preset manual data for **White balance** (🔧34)
 - Playback menu:** **Sequence display options** (🔧51) and **Choose key picture** (🔧51)
 - Setup menu:** **Time zone and date** (🔧67), **Language** (🔧78) and **Video mode** (🔧79) in **TV settings**

Firmware Version

Press the **MENU** button → **Y** tab (📖11) → Firmware version

Displays the current camera firmware version.

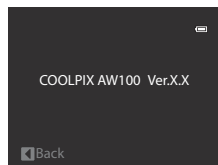

File and Folder Names

Pictures, movies and voice memos are assigned file names as follows.

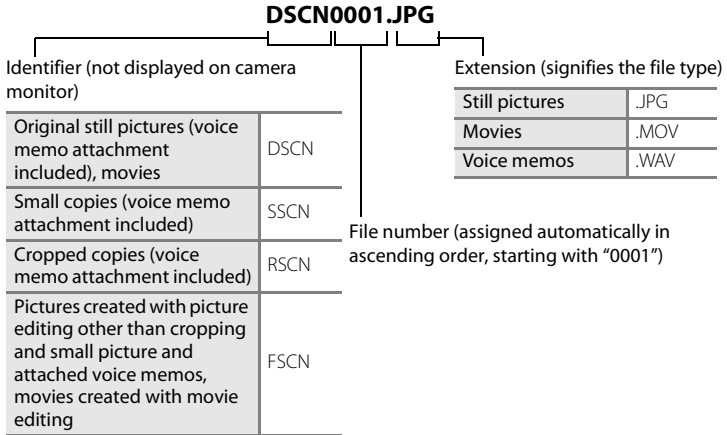

- A folder for storing files is automatically created using the following naming convention: "Folder number + NIKON" (e.g., "100NIKON"). If there are 200 files in a folder, a new folder is created. (For example, the folder name following "100NIKON" becomes "101NIKON.") A new folder is also created when the file numbers in a folder reach 9999. The next file number is set automatically to "0001."
- Voice memo file names have the same identifier and file number as the picture to which the voice memo is attached.
- In Panorama assist (P₀₅), a folder is created for each shooting session using the following naming convention: "Folder number + P_XXX" (e.g., "101P_001"). Pictures are saved in sequence in file numbers starting from 0001.

File and Folder Names

- When image files or voice files are copied to or from the internal memory or memory card (📷50), the file naming conventions are as follows:
 - Files copied using **Selected images** are copied to the current folder (or to the folder used for subsequent pictures), where they are assigned file numbers in ascending order following the largest file number in memory.
 - Files copied using **All images**, along with their folder, are copied together. Folder numbers are assigned in ascending order, following the largest folder number on the destination medium.
File names are not changed.
- When the current folder is numbered 999, if there are 200 files in the folder or if a file is numbered 9999, no further pictures can be shot until the internal memory or memory card is formatted (📷78), or a new memory card is inserted.

Optional Accessories

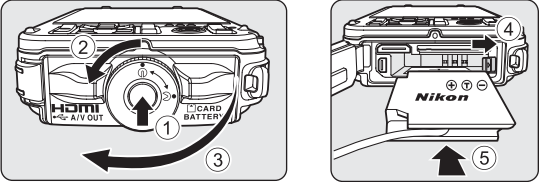
Rechargeable battery	Rechargeable Li-ion Battery EN-EL12*
Battery charger	Battery Charger MH-65*
AC adapter	AC Adapter EH-62F (connect as shown)  <p>Fully insert the cord of the AC Adapter into the slot in the AC Adapter, then insert the AC Adapter in the battery chamber.</p> <ul style="list-style-type: none">• While using the AC adapter, the battery-chamber/memory card slot cover cannot be closed. Do not pull the cord of the AC adapter. If the cord is pulled, the connection between the camera and power source is interrupted, and the camera turns off.
USB cable	USB Cable UC-E6*
Audio/Video cable	Audio Video Cable EG-CP16*
Filter adapter	Filter Adapter UR-E23*











* Included with the camera at the time of purchase (see “Confirming the Package Contents” (ii) for more information).















See our websites or product catalogs for up-to-date information on accessories for the COOLPIX AW100.

Accessories are not waterproof.















Error Messages















The following table lists the error messages and other warnings displayed on the monitor, as well as the solutions for dealing with them.

Display	Description	Solution	
 (blinks)	Clock not set.	Set date and time.	 67
 Battery exhausted.	Battery exhausted.	Charge or replace the battery.	16, 18
 Battery temperature high	Battery temperature is high.	Turn off camera, and allow battery to cool down before resuming use. Five seconds after this message appears, the monitor is turned off, and the power-on lamp, the AF lamp and the flash lamp flicker. After the lamps blink for three minutes, the camera turns off automatically, but you can also press the power switch to turn it off manually.	23
 The camera will turn off to prevent overheating.	Inside of the camera has become hot. The camera turns off automatically.	Leave the camera off until the inside of the camera has cooled and then turn it on again.	–
 (blinks red)	Camera cannot focus.	<ul style="list-style-type: none"> • Refocus. • Use focus lock. 	30, 31 67
 Please wait for the camera to finish recording.	Camera cannot perform other operations until recording is complete.	Wait until message clears from display automatically when recording is complete.	–
 Memory card is write protected.	Write-protect switch is in “lock” position.	Slide the write-protect switch to “write” position.	–
 This card cannot be used.	Error accessing memory card.	<ul style="list-style-type: none"> • Use an approved card. • Check that connectors are clean. • Confirm that memory card is correctly inserted. 	21 20 20
 This card cannot be read.			





Display	Description	Solution	
 Card is not formatted. Format card? Yes No	Memory card has not been formatted for use in this camera.	All data stored on the memory card is deleted when formatted. If there is any data on the card that you want to keep, select No , and backup the data to a computer before formatting the memory card. To format the memory card, select Yes and press the  button.	20
 Out of memory.	Memory card is full.	<ul style="list-style-type: none"> • Choose smaller image mode. • Delete pictures and movies. • Replace memory card. • Remove memory card and use internal memory. 	61 34, 84 20 21
 Image cannot be saved.	Error occurred while recording picture.	Format the internal memory or memory card.	 78
	Camera has run out of file numbers.	Replace the memory card, or format the internal memory/memory card.	20,  78
	Picture cannot be used for welcome screen.	The following pictures cannot be used. <ul style="list-style-type: none"> • Pictures taken with Image mode of  4608x2592 • Pictures created with small picture or crop function that are 320 x 240 or smaller • Pictures recorded with easy panorama 	61  20,  21  2
	There is insufficient space to save a copy.	Delete images from destination.	34
 Album is full. No further pictures can be added.	200 pictures have already been recorded on the album.	<ul style="list-style-type: none"> • Remove pictures from the album. • Save pictures on the another album. 	 10  9















Error Messages

Display	Description	Solution	
 Unable to create panorama.	Cannot perform easy panorama shooting.	Easy panorama shooting may not be available in the following situations. <ul style="list-style-type: none"> • When shooting has not finished after a certain period of time • When the camera movement speed is too fast • When the camera is not straight relative to the panorama direction 	 2
 Unable to create panorama. Pan the camera in one direction only.			
 Unable to create panorama. Pan the camera more slowly.			
 Sound file cannot be saved.	A voice memo cannot be attached to this file.	<ul style="list-style-type: none"> • Voice memos cannot be attached to movies. • Select a picture taken with this camera. 	–  49
 A blink was detected in the picture just taken.	Someone may have had their eyes closed when the picture was taken.	Check results in playback mode.	 33
 Image cannot be modified.	Cannot edit selected picture.	<ul style="list-style-type: none"> • Confirm the conditions that are required for editing. • These options cannot be used with movies. 	 15 –
 Cannot record movie.	Time out error while recording movie.	Choose memory card with faster write speed.	21
 Memory contains no images.	No pictures in the internal memory or memory card.	<ul style="list-style-type: none"> • Pictures stored in the internal memory can only be viewed if no memory card is inserted. • To copy files from internal memory to memory card, press the MENU button to display the copy screen, then copy the files from internal memory to memory card. 	20  50

Display	Description	Solution	
 File contains no image data.	File not created with COOLPIX AW100.	File cannot be viewed on this camera. View file using the computer or any other devices which was used to create or edit this file.	-
 This file cannot be played back.			
 All images are hidden.	The picture cannot be played back in a slide show.	-	 45
 This image cannot be deleted.	Picture is protected.	Disable protection.	 46
 Travel destination is in the current time zone.	Destination in same time zone as home.	-	 69
Lens error 	Lens is not operating properly.	Turn camera off and then on again. If error persists, contact retailer or Nikon-authorized service representative.	23
 Communications error	Error occurred during communication with printer.	Turn off camera and reconnect cable.	 25
System error 	Error has occurred in camera's internal circuitry.	Turn off camera , remove and reinsert battery, and turn on camera. If the error persists, contact retailer or Nikon-authorized service representative.	23
 Initializing lens. Cannot focus.	The camera cannot focus.	Wait until the camera recovers automatically.	-
 Could not obtain GPS data.	The camera clock is not set correctly.	Change the location or time and determine the location again.	-

Error Messages

Display	Description	Solution	
i No A-GPS file found on card	An A-GPS file that can be updated is not found in the memory card.	Check the following items. <ul style="list-style-type: none"> • Whether the memory card is inserted • Whether the A-GPS file is stored in the memory card • Whether the A-GPS file saved in a memory card is more recent than the A-GPS file saved in the camera • Whether the A-GPS file is still valid 	–
i Update failed	Unable to update A-GPS file.	The A-GPS file may be corrupted. Download the file from the website once more.	 57
i Unable to determine current position	Unable to determine the current position when distance is calculated.	Change the location or time and determine the location again.	–
i Cannot save to card	A memory card is not inserted.	Insert a memory card.	20
	36 log data events have been already saved in one day.	–	–
	100 log data events have been already saved.	Delete log data that is no longer required from a memory card or replace the memory card with a new one.	 63
i Unable to correct compass	Unable to correct the digital compass correctly.	Swing the camera to draw a figure eight in the air outdoors while turning your wrist to face the camera forward and backward, side to side, or up and down.	 64

Display	Description	Solution	
 Printer error: check printer status.	Printer error	Check printer. After solving the problem, select Resume and press the  button to resume printing.*	–
 Printer error: check paper	Specified size of paper is not loaded.	Load the specified size of paper, select Resume and press the  button to resume printing.*	–
 Printer error: paper jam	Paper has jammed in the printer.	Remove the jammed paper, select Resume and press the  button to resume printing.*	–
 Printer error: out of paper	No paper is loaded in the printer.	Load the specified size of paper, select Resume and press the  button to resume printing.*	–
 Printer error: check ink	Ink error	Check ink, select Resume and press the  button to resume printing.*	–
 Printer error: out of ink	Ink cartridge is empty.	Replace ink cartridge, select Resume and press the  button to resume printing.*	–
 Printer error: file corrupt	An error caused by the image file has occurred.	Select Cancel and press the  button to cancel printing.	–

* See the instruction manual provided with your printer for further guidance and information.



A series of horizontal dashed lines spanning the width of the page, intended for handwriting practice.



Technical Notes and Index

Caring for the Products	2
The Camera.....	2
The Battery.....	4
The Battery Charger.....	5
The Memory Cards.....	6
Caring for the Camera	7
Cleaning.....	7
Storage.....	8
USER LICENSE AGREEMENT FOR MAP DATA AND LOCATION NAME DATA.....	9
Troubleshooting	13
Specifications.....	20
Supported Standards.....	23
Index.....	24

Caring for the Products

The Camera

To ensure continued enjoyment of this Nikon product, observe the following precautions when using or storing the device.

Be sure to read and follow the warnings of “For Your Safety” (📖vi to viii) and “<Important> Shockproof, waterproof, dustproof, condensation, GPS/digital compass” (📖xi to xvi) thoroughly before using the products.

✔ Do Not Allow Damp to Enter Inside the Camera

COOLPIX AW100 is provided with JIS/IEC protection class 8 (IPX8) equivalent waterproofing. If water seeps inside the camera, however, this could cause the components to rust and result in a high repair charge or the camera may not be repairable. After using the camera at the beach or underwater, make sure that the battery-chamber/memory card slot cover is firmly closed, and then immerse the camera in a shallow container filled with freshwater for ten minutes. After using the camera underwater, do not leave the camera wet for 60 minutes or more. This could cause deterioration of the waterproofing performance.

✔ Prevent Water From Seeping Inside the Camera

If the inside of the camera becomes wet, this could result in camera malfunction and the camera may not be repairable. To prevent water seeping (water submersion) accidents, be sure to observe the following cautions when using the camera.

- When the battery-chamber/memory card slot cover is closed, make sure that the camera strap, hair, lint, dust, sand grains, other foreign substances, or dirt are not attached on the waterproofing packing and portions that make a contact with the waterproofing packing.
- Do not open and close the battery-chamber/memory card slot cover in areas exposed to water spray, high winds, dust or sand.
- When an external force is applied on the camera, it could become deformed or the airtight seals may become damaged and cause water to seep inside the camera. Do not place a heavy object on the camera, drop the camera, or apply excessive force on the camera.
- If water seeps inside the camera, immediately stop using the camera. Wipe off moisture from the camera, and at once take the camera to your Nikon-authorized service representative.

✔ Shock and Vibration

Do not drop the camera, strike it against a hard object such as a rock, or throw it at a water surface. Do not leave the camera in an area subject to vibration. If the camera is subjected to excessive shock, this could result in camera malfunction or damage.

✔ Maximum Depth

COOLPIX AW100 is designed to withstand water pressure up to a depth of 10 m (33 ft) for approximately 60 minutes. At greater depth, water could seep inside the camera, resulting in camera malfunction.

✔ Precautions on Handling the Camera in Cold Locations

- The operation of this camera has been confirmed at temperatures of -10°C (14°F). If the camera is left with snow or water droplets adhered to the exterior, snow or water droplets between the gaps may become frozen and it may be difficult to operate parts of the camera.

- At temperatures from -10°C to 0°C (14°F to 32°F), the performance of the batteries (number of pictures shot and shooting time) will drop temporarily.
- If the camera becomes extremely cold in cold locations, the monitor performance may drop temporarily immediately after the power is turned on (i.e., the monitor appears darker than usual or a residual image occurs).
- When using the camera in cold locations or at high altitudes, keep the camera warm inside a protection against cold or clothing.

Do Not Drop

The product may malfunction if subjected to strong shock or vibration.

Handle the Lens and All Moving Parts with Care

Do not apply force to the lens, lens cover, monitor, memory card slot, or battery chamber. These parts are easily damaged. Applying force to the lens cover could result in camera malfunction or damage to the lens. Should the monitor break, care should be taken to avoid injury caused by broken glass and to prevent the liquid crystal from the display touching the skin or entering the eyes or mouth.

Do Not Point the Lens at Strong Light Sources for Extended Periods

Avoid pointing the lens at the sun or other strong light sources for extended periods when using or storing the camera. Intense light may cause deterioration of the image sensor, producing a white blur effect in photographs.

Keep away from Strong Magnetic Fields

Do not use or store this device in the vicinity of equipment that generates strong electromagnetic radiation or magnetic fields. Strong static charge or the magnetic fields produced by equipment such as radio transmitters could interfere with the monitor, damage data saved on the memory card, or affect the product's internal circuitry.

Avoid Sudden Changes in Temperature

Sudden changes in temperature, such as when entering or leaving a heated building on a cold day, can cause condensation to form inside the device. To prevent condensation, place the device in a carrying case or a plastic bag before exposing it to sudden changes in temperature.

Do not expose the camera to high temperatures by leaving it on the beach or in direct sunlight before entering the water.

Turn the Product off Before Removing or Disconnecting the Power Source or the Memory Card

Do not remove the battery while the product is on, or while images are being saved or deleted. Forcibly cutting power in these circumstances could result in loss of data or in damage to product memory or internal circuitry.

The Monitor

- The monitor may contain a few pixels that are always lit or that do not light. This is a characteristic common to all TFT LCD displays, and does not indicate a malfunction. Images saved using the product will not be affected.
- Images on the monitor may be difficult to see under bright lighting.
- The monitor is lit by an LED backlight. Should the monitor begin to dim or flicker, contact your Nikon-authorized service representative.

The Battery

- Be sure to read and follow the warnings of “For Your Safety” (📖vi to viii) thoroughly before using the battery.
- Check the battery level before using the camera and replace or charge the battery if necessary. Do not continue charging once the battery is fully charged as this will result in reduced battery performance. Whenever possible, carry a fully charged spare battery when taking pictures on important occasions.
- Do not use the battery at ambient temperatures below -10°C (14°F) or above 40°C (104°F).
- Charge the battery indoors with an ambient temperature of 5°C to 35°C (41°F to 95°F) before use.
- When the battery temperature is between 0°C and 10°C (32°F to 50°F) or 45°C to 60°C (113°F to 140°F), the chargeable capacity may decrease.
- The battery is not charged at ambient temperatures below 0°C (32°F) or above 60°C (140°F).
- Note that the battery may become hot during use; wait for the battery to cool before charging. Failure to observe these precautions could damage the battery, impair its performance, or prevent it from charging normally.
- On cold days, the capacity of batteries tends to decrease. Be sure that the battery is fully charged before heading outside to take pictures in cold weather. Keep spare batteries in a warm place and exchange as necessary. Once warmed, a cold battery may recover some of its charge.
- Dirt on the battery terminals can prevent the camera from functioning. Should the battery terminals become dirty, wipe them off with a clean, dry cloth before use.
- If the battery will not be used for some time, insert it in the camera and run it flat before removing it for storage. The battery should be stored in a cool location with an ambient temperature of 15°C to 25°C (59°F to 77°F). Do not store the battery in hot or extremely cold locations.
- Always remove the battery from the camera or battery charger when it is not being used. When inserted, minute amounts of current are drawn from the battery even when not in use. This may result in excessive draining of the battery and complete loss of function. Turning the camera on or off while the battery is exhausted can result in reduced battery life. When the battery level is low, be sure to charge the battery before using it.
- Recharge the battery at least once every six months and completely exhaust it before returning it to storage.
- After removing the battery from the camera or battery charger, attach the included terminal cover to the battery and store it in a cool place.

- A marked drop in the time a fully-charged battery retains its charge, when used at room temperature, indicates that the battery needs to be replaced. Purchase a new EN-EL12 battery.
- Replace the battery when it no longer holds a charge. Used batteries are a valuable resource. Please recycle used batteries in accordance with local regulations.

The Battery Charger

- Be sure to read and follow the warnings of "For Your Safety" (📖vi to viii) thoroughly before using the battery charger.
- The included Battery Charger is for use only with a Rechargeable Li-ion Battery EN-EL12.

The Memory Cards

- Use only Secure Digital memory cards. See “Approved Memory Cards” (📖 21).
- Be sure to observe the precautions in the memory card documentation when you use the memory card.
- Do not affix labels or stickers to the memory card.
- Do not format the memory card using a computer.
- When a memory card is used for the first time, it is recommended to format it with this camera. In particular, the first time you insert a memory card that has been used in another device into this camera, be sure to format it with this camera.
- Formatting permanently deletes all data in the memory card. Be sure to transfer important pictures to a computer before formatting.
- If the error message “Card is not formatted. Format card?” is displayed when you insert a memory card into this camera, the memory card must be formatted. If the memory card contains images you wish to keep, select **No** and save those images on your computer before formatting the memory card. To format the card, select **Yes** and press the **OK** button.
- Do not perform the following during formatting, while data is being written to or deleted from the memory card, or during data transfer to a computer. Failure to observe this precaution could result in loss of data or damage to the memory card:
 - Open the battery-chamber/memory card slot cover to remove the battery or memory card.
 - Turn off the camera
 - Disconnect the AC adapter

Caring for the Camera

Cleaning

Lens	Avoid touching glass parts with your fingers. Remove dust or lint with a blower (typically a small device with a rubber bulb attached to one end that is pumped to produce a stream of air out the other end). To remove fingerprints, oily substances, or other stains that cannot be removed with a blower, carefully wipe the lens with a dry soft cloth or eyewear cleaning cloth, using a spiral motion that starts at the center of the lens and working toward the edges. Do not wipe the lens forcibly or with a hard material. Failure to observe this precaution could result in damage or trouble. If this fails, clean the lens using a cloth lightly dampened with commercial lens cleaner.
Monitor	Remove dust or lint with a blower. To remove fingerprints, oily substances or other stains, carefully wipe the monitor with a dry soft cloth or eyewear cleaning cloth. Do not wipe the monitor forcibly or with a hard material. Failure to observe this precaution could result in damage or trouble.
Body	Use a blower to remove dust, dirt, or sand, then wipe gently with a soft, dry cloth. After using the camera underwater or at the beach, gently wipe off any sand or salt with a soft cloth lightly dampened with fresh water and dry thoroughly. If you handle the camera using hands where sunscreen lotion is applied, this could cause deterioration of the camera exterior. Note that foreign matter inside the camera could cause damage not covered by the warranty.

Do not use volatile organic solvents such as alcohol or thinner, chemical detergents, anticorrosive agents, or anti-fogging agents.

Storage

Remove the battery if the camera will not be used for an extended period. Do not store the camera with naphtha or camphor moth balls, or in any of the following locations:

- Next to equipment that produces strong electromagnetic fields, such as televisions or radios
- Exposed to temperatures below -10°C (14°F) or above 50°C (122°F)
- Places that are poorly ventilated or subject to humidity of over 60%

To prevent mold or mildew, take the camera out of storage at least once a month. Turn the camera on and release the shutter a few times before putting the camera away again.

Be sure to read and follow the warnings given in "The Battery" (🔋:4) of "Caring for the Products" to store the battery.

USER LICENSE AGREEMENT FOR MAP DATA AND LOCATION NAME DATA

The map data and location name data that are stored in this digital camera ("Data") is provided for your personal, internal use only and not for resale. It is protected by copyright, and is subject to the following terms and conditions which are agreed to by you, on the one hand, and Nikon Corporation ("Nikon") and its licensors (including their licensors and suppliers) on the other hand.

For information on copyrights and licensors, refer to "Notices related to licensed software copyright holders." (P.11).

Terms and Conditions

Personal Use Only. You agree to use this Data together with this digital camera and the image data taken by the digital camera for the solely personal, non-commercial purposes for which you were licensed, and not for service bureau, time-sharing or other similar purposes.

Accordingly, but subject to the restrictions set forth in the following paragraphs, you agree not to otherwise reproduce, copy, modify, decompile, disassemble or reverse engineer any portion of this Data, and may not transfer or distribute it in any form, for any purpose, except to the extent permitted by mandatory laws.

Restrictions. Except where you have been specifically licensed to do so by Nikon, and without limiting the preceding paragraph, you may not (a) use this Data with any products, systems, or applications installed or otherwise connected to or in communication with vehicles, capable of vehicle navigation, positioning, dispatch, real time route guidance, fleet management or similar applications; or (b) with or in communication with any positioning devices or any mobile or wireless-connected electronic or computer devices, including without limitation cellular phones, palmtop and handheld computers, pagers, and personal digital assistants or PDAs.

Warning. The Data may contain inaccurate or incomplete information due to the passage of time, changing circumstances, sources used and the nature of collecting comprehensive geographic data, any of which may lead to incorrect results.

No Warranty. This Data is provided to you "as is," and you agree to use it at your own risk. Nikon and its licensors (and their licensors and suppliers) make no guarantees, representations or warranties of any kind, express or implied, arising by law or otherwise, including but not limited to, content, quality, accuracy, completeness, effectiveness, reliability, fitness for a particular purpose, usefulness, use or results to be obtained from this Data, or that the Data or server will be uninterrupted or error-free.

Disclaimer of Warranty: NIKON AND ITS LICENSORS (INCLUDING THEIR LICENSORS AND SUPPLIERS) DISCLAIM ANY WARRANTIES, EXPRESS OR IMPLIED, OF QUALITY, PERFORMANCE, MERCHANTABILITY, FITNESS FOR A PARTICULAR PURPOSE OR NON-INFRINGEMENT. Some States, Territories and Countries do not allow certain warranty exclusions, so to that extent the above exclusion may not apply to you.

Disclaimer of Liability: NIKON AND ITS LICENSORS (INCLUDING THEIR LICENSORS AND SUPPLIERS) SHALL NOT BE LIABLE TO YOU: IN RESPECT OF ANY CLAIM, DEMAND OR ACTION, IRRESPECTIVE OF THE NATURE OF THE CAUSE OF THE CLAIM, DEMAND OR ACTION ALLEGING ANY LOSS, INJURY OR DAMAGES, DIRECT OR INDIRECT, WHICH MAY RESULT FROM THE USE OR POSSESSION OF THE INFORMATION; OR FOR ANY LOSS OF PROFIT, REVENUE, CONTRACTS OR SAVINGS, OR ANY OTHER DIRECT, INDIRECT, INCIDENTAL, SPECIAL OR CONSEQUENTIAL DAMAGES ARISING OUT OF YOUR USE OF OR INABILITY TO USE THIS INFORMATION, ANY DEFECT IN THE INFORMATION, OR THE BREACH OF THESE TERMS OR CONDITIONS, WHETHER IN AN ACTION IN CONTRACT OR TORT OR BASED ON A WARRANTY, EVEN IF NIKON OR ITS LICENSORS HAVE BEEN ADVISED OF THE POSSIBILITY OF SUCH DAMAGES. Some States, Territories and Countries do not allow certain liability exclusions or damages limitations, so to that extent the above may not apply to you.

USER LICENSE AGREEMENT FOR MAP DATA AND LOCATION NAME DATA

Export Control. You agree not to export from anywhere any part of the Data or any direct product thereof except in compliance with, and with all licenses and approvals required under, applicable export laws, rules and regulations, including but not limited to the laws, rules and regulations administered by the Office of Foreign Assets Control of the U.S. Department of Commerce and the Bureau of Industry and Security of the U.S. Department of Commerce. To the extent that any such export laws, rules or regulations prohibit Nikon and its licensors from complying with any of its obligations hereunder to deliver or distribute Data, such failure shall be excused and shall not constitute a breach of this Agreement.

Entire Agreement. These terms and conditions constitute the entire agreement between Nikon (and its licensors, including their licensors and suppliers) and you pertaining to the subject matter hereof, and supersedes in their entirety any and all written or oral agreements previously existing between us with respect to such subject matter.

Governing Law. The above terms and conditions shall be governed by the laws of the Japan, without giving effect to (i) its conflict of laws provisions, or (ii) the United Nations Convention for Contracts for the International Sale of Goods, which is explicitly excluded; provided that in the event that the laws of the Japan is not deemed applicable to this Agreement for any reason in the country where you obtained the Data, this Agreement shall be governed with the laws of the country where you obtained the Data. You agree to submit to the jurisdiction of Japan for any and all disputes, claims and actions arising from or in connection with the Data provided to you hereunder.

Notices related to licensed software copyright holders.

- Map data and location name data for Japan



© 2011 ZENRIN CO., LTD.. All rights reserved.
 This service uses map and POI data of ZENRIN CO., LTD.. "ZENRIN" is a registered trademark of ZENRIN CO., LTD..

- Map data and location name data except for Japan



© 1993-2010 NAVTEQ. All rights reserved.

Austria	© Bundesamt für Eich- und Vermessungswesen
Croatia Cyprus Estonia Latvia Lithuania Moldova Poland Slovenia Ukraine	© EuroGeographics
Belgium (Traffic Codes for Belgium)	Traffic Codes for Belgium are provided by the Ministerie van de Vlaamse Gemeenschap and the Ministère de l'Équipement et des Transports.
France	source: © IGN 2009 - BD TOPO ®
Germany	"Die Grundlagendaten wurden mit Genehmigung der zuständigen Behörden entnommen"
Great Britain	Contains Ordnance Survey data © Crown copyright and database right 2010
Great Britain (Royal Mail data)	Contains Royal Mail data © Royal Mail copyright and database right 2010
Greece **	Copyright Geomatics Ltd.
Hungary	Copyright © 2003; Top-Map Ltd.
Italy	La Banca Dati Italiana è stata prodotta usando quale riferimento anche cartografia numerica ed al tratto prodotta e fornita dalla Regione Toscana.
Norway	Copyright © 2000; Norwegian Mapping Authority
Portugal	Source: IgeoE - Portugal
Spain	Información geográfica propiedad del CNIG
Sweden	Based upon electronic data © National Land Survey Sweden.
Switzerland	Topografische Grundlage: © Bundesamt für Landestopographie

USER LICENSE AGREEMENT FOR MAP DATA AND LOCATION NAME DATA





Canada	This data includes information taken with permission from Canadian authorities, including © Her Majesty the Queen in Right of Canada, © Queen's Printer for Ontario, © Canada Post Corporation, GeoBase ®, © The Department of Natural Resources Canada. All rights reserved.
Mexico	Fuente: INEGI (Instituto Nacional de Estadística y Geografía.)
United States	© United States Postal Service ® 2010. Prices are not established, controlled or approved by the United States Postal Service ®. The following trademarks and registrations are owned by the USPS: United States Postal Service, USPS, and ZIP+4.
Australia	© Hema Maps Pty. Ltd, 2010. Copyright. Based on data provided under license from PSMA Australia Limited (www.pasma.com.au). Product incorporates data which is © 2010 Telstra Corporation Limited, GM Holden Limited, Intelomatics Australia Pty Ltd, NAVTEQ International LLC, Sentinel Content Pty Limited and Continental Pty Ltd.
Israel	© Survey of Israel data source
Jordan	© Royal Jordanian Geographic Centre
Mozambique	Certain Data for Mozambique provided by Cenacarta © 2010 by Cenacarta
Réunion	source: © IGN 2009 - BD TOPO ®
Ecuador	INSTITUTO GEOGRAFICO MILITAR DEL ECUADRO AUTORIZACION N° IGM-2011-01- PCO-01 DEL 25 DE ENERO DE 2011
Guadeloupe	source: © IGN 2009 - BD TOPO ®
Guatemala	Aprobado por el INSTITUTO GEOGRAFICO NACIONAL - Resolución del IGN N° 186-2011
French Guiana	source: © IGN 2009 - BD TOPO ®
Martinique	source: © IGN 2009 - BD TOPO ®
Mexico	Fuente: INEGI (Instituto Nacional de Estadística y Geografía)

Troubleshooting

If the camera fails to function as expected, check the list of common problems below before consulting your retailer or Nikon-authorized service representative. Refer to the page numbers in the right-most column for more information.

- See “Error Messages” (🔍 88) for more information.

Power, Display and Settings Issues





Problem	Cause/Solution	
Camera turns off without warning.	<ul style="list-style-type: none"> • Battery is exhausted. • Camera has turned off automatically by auto off to save power. • Inside of the camera has become hot. Leave the camera off until the inside of the camera has cooled. • At low temperatures, the camera and the battery may not function normally. 	22 23 – 🌞:4
Monitor is blank.	<ul style="list-style-type: none"> • Camera is off. • Battery is exhausted. • Standby mode for saving power: press the power switch, the shutter-release button,  button,  button, or  button. • Camera and computer are connected via USB cable. • Camera and TV are connected via A/V cable or HDMI cable. 	23 22 23 73 73
Monitor is hard to see.	<ul style="list-style-type: none"> • Adjust monitor brightness. • Monitor is dirty. Clean monitor. 	94 🌞:2
Date and time of recording are not correct.	<ul style="list-style-type: none"> • If the camera clock has not been set (“Date not set” indicator blinks during shooting), still pictures have a time stamp of “00/00/0000 00:00”; and movies are dated “01/01/2011 00:00.” Set the correct date and time using Time zone and date in the setup menu. • The camera clock is not as accurate as a normal clock, such as watches. Check camera clock regularly against more accurate timepieces and reset as required. 	24, 94 94
No information displayed in monitor.	Hide info is selected for Photo info under Monitor settings in the setup menu.	94
Print date not available.	Time zone and date in the setup menu has not been set.	24, 94
Date not appearing on pictures even when Print date is enabled.	<ul style="list-style-type: none"> • A shooting mode that does not support print date is selected. • Another function that is set now is restricting the print date. • The date cannot be imprinted onto a movie. 	94 63 –
Camera settings reset.	Clock battery is exhausted; all settings were restored to their default values.	25





Problem	Cause/Solution	
Monitor is turned off, and the power-on lamp blinks.	Battery temperature is high. Turn off camera, and allow battery to cool down before resuming use. After the lamp blinks for three minutes, the camera turns off automatically, but you can also press the power switch to turn it off manually.	23
Camera temperature rises.	When functions such as movie recording are used for a long time, or when the camera is used in a location with a high ambient temperature, the camera temperature may rise. This is not a malfunction.	81

● Electronically Controlled Cameras







In extremely rare instances, unusual characters may appear on the monitor and the camera may stop functioning. In most cases, this phenomenon is caused by a strong external static charge. Turn the camera off, remove and replace the battery, then turn the camera on again. Note that disconnecting the power source as described above may result in the loss of any data not recorded on the internal memory or memory card at the time the problem occurred. Data already recorded is not affected. In the event of continued malfunction, contact your retailer or Nikon-authorized service representative.

Shooting Issues



Problem	Cause/Solution	
Cannot set to shooting mode.	Disconnect the HDMI cable or USB cable.	73
No picture taken when shutter-release button is pressed.	<ul style="list-style-type: none"> When camera is in playback mode, press the  button, the shutter-release button, or the  button. 	32
	<ul style="list-style-type: none"> When menus are displayed, press the MENU button. 	11
	<ul style="list-style-type: none"> Battery is exhausted. 	22
	<ul style="list-style-type: none"> When flash lamp blinks, flash is charging. 	54
Camera cannot focus.	<ul style="list-style-type: none"> Subject is too close to the camera. Try shooting with macro mode,  (easy auto) mode or Close-up scene mode. 	38, 42, 57
	<ul style="list-style-type: none"> The intended subject is one with which autofocus does not perform well. 	31
	<ul style="list-style-type: none"> Set AF assist in the setup menu to Auto. 	94
	<ul style="list-style-type: none"> Subject not in focus area when shutter-release button pressed halfway. 	30, 51
	<ul style="list-style-type: none"> Turn camera off and then on again. 	23
Pictures are blurred.	<ul style="list-style-type: none"> Use flash. 	54
	<ul style="list-style-type: none"> Use vibration reduction and motion detection. 	94
	<ul style="list-style-type: none"> Use BSS (Best Shot Selector). 	51
	<ul style="list-style-type: none"> Use a tripod to stabilize the camera (use with the self-timer for better results). 	56

Problem	Cause/Solution	
Bright specks appear in pictures shot using flash.	Flash is reflecting off particles in air. Set the flash to  (off).	55
Flash does not fire.	<ul style="list-style-type: none"> Flash is set to  (off). 	55
	<ul style="list-style-type: none"> A scene mode that cannot turn on flash is selected. 	54
	<ul style="list-style-type: none"> When the camera is recording a movie. Another function that is set now is restricting the flash. 	63
The digital zoom is not available.	<ul style="list-style-type: none"> Off is selected for Digital zoom in the setup menu. 	94
	<ul style="list-style-type: none"> When Portrait, Night portrait, Backlighting with HDR set to On, Pet portrait or Underwater is selected in scene mode, the digital zoom cannot be used. 	40, 41, 44, 46
	<ul style="list-style-type: none"> Other functions that restrict the use of digital zoom is set. 	63
Image mode not available.	Another function that is set now is restricting Image mode .	63
No sound when shutter is released.	<ul style="list-style-type: none"> Off is selected for Shutter sound under Sound settings in the setup menu. 	94
	<ul style="list-style-type: none"> Sports, Museum or Pet portrait is selected in scene mode. 	40, 43, 46
	<ul style="list-style-type: none"> When the camera is recording a movie. Other functions that restrict the use of the shutter sound are set. 	63
	<ul style="list-style-type: none"> Do not block the speaker. 	3
AF-assist illuminator does not light.	Off is selected for AF assist in the setup menu. Even when Auto is set, AF-assist illuminator may not light depending on the focus area position or scene mode.	94
Pictures appear smeared.	Lens is dirty. Clean lens.	 2
Colors are unnatural.	White balance does not match light source.	51
Ring-shaped or rainbow-colored bands are seen on the screen or the shot image.	When the subject is backlit or when shooting with an extremely bright light source in the display, such as in sunlight, ring-shaped or rainbow-colored bands may appear on the image. Change the position of the light source or remove it from the display, and try shooting again.	-
Randomly spaced bright pixels ("noise") appear in image.	As the subject is dark, shutter speed is too slow or ISO sensitivity is too high.	54
	<ul style="list-style-type: none"> Use flash. Specify a lower ISO sensitivity setting. 	51







Troubleshooting

Problem	Cause/Solution	
Pictures are too dark (underexposed).	<ul style="list-style-type: none"> Flash is set to  (off). Flash window is blocked. Subject is beyond flash range. Adjust exposure compensation. Raise the ISO sensitivity. Subject is backlit. Set the scene mode to Backlighting with HDR set to Off, or set the flash mode to  (fill flash). 	55 28 54 58 51 44, 54
Pictures are too bright (overexposed).	Adjust exposure compensation.	58
Areas not affected by red-eye are also corrected.	When  (auto with red-eye reduction) or “fill flash with red-eye reduction” of the Night portrait scene mode is applied during shooting, In-Camera Red-Eye Fix may, in very rare cases, be applied to areas not affected by red-eye. Set a flash mode other than  (auto with red-eye reduction), select a scene mode other than Night portrait , and resume shooting.	41, 54
Skin softening results are not as expected.	<ul style="list-style-type: none"> Skin softening may not produce the desired results depending on shooting conditions. For pictures with four or more faces, try using Skin softening in the playback menu. 	66 71
Saving images takes time.	<p>It may take more time to save images in the following situations.</p> <ul style="list-style-type: none"> When the noise reduction function is in operation When flash is set to  (auto with red-eye reduction) When taking pictures in the following scene modes <ul style="list-style-type: none"> HDR set to On in  (backlighting) Easy panorama in Panorama When using skin softening function while shooting 	– 55 44 45 66
Cannot set or use Continuous.	Another function that is set now is restricting the continuous setting.	63





Playback Issues

Problem	Cause/Solution	
File cannot be played back.	<ul style="list-style-type: none"> File was overwritten or renamed by computer or another make or model of camera. Movies recorded with cameras other than COOLPIX AW100 cannot be played back. 	<p>–</p> <p>84</p>
Cannot play a sequence.	<ul style="list-style-type: none"> Pictures shot continuously with cameras other than COOLPIX AW100 cannot be played as a sequence. Check the Sequence display options setting. 	<p>–</p> <p>71</p>
Cannot zoom in on picture.	<ul style="list-style-type: none"> Playback zoom cannot be used with movies, small pictures, or cropped copies of size 320 × 240 pixels or smaller. Playback zoom may not be available for pictures taken with cameras other than COOLPIX AW100. 	<p>–</p> <p>–</p>
Cannot record or play back voice memo.	<ul style="list-style-type: none"> Voice memos cannot be attached to movies. Voice memos cannot be attached to pictures taken with cameras other than COOLPIX AW100, and voice memos recorded by other cameras cannot be played back. 	<p>84</p> <p>71</p>
Pictures and movies cannot be edited.	<ul style="list-style-type: none"> Confirm the conditions that are required for editing pictures or movies. Pictures and movies taken with cameras other than COOLPIX AW100 cannot be edited. 	<p>72,</p> <p> 16</p> <p>–</p>
Pictures not displayed on television.	<ul style="list-style-type: none"> Video mode or HDMI is not correctly set in the TV settings setup menu. Cables are connected to both the HDMI mini connector and USB/audio/video output connector. Memory card contains no pictures. Replace memory card. Remove memory card to play back pictures from internal memory. 	<p>94</p> <p>73</p> <p>20</p>
Album icons are reset to their default icons, or images added to albums cannot be displayed in favorite pictures mode.	<p>Data saved in the internal memory or on the memory card may not be played back if overwritten by a computer.</p>	<p>–</p>

Troubleshooting

Problem	Cause/Solution	
<p>The saved images are not displayed in auto sort mode.</p>	<ul style="list-style-type: none"> The desired image was sorted to a category other than the category currently displayed. Images saved by cameras other than COOLPIX AW100 and images copied using the Copy option cannot be displayed in auto sort mode. Images saved in the internal memory or on the memory card may not be played back correctly if overwritten by a computer. Up to 999 images and movies in total can be added to each category. If the desired category already contains 999 images or movies in total, new images or movies cannot be added. 	<p>70, 12 13 – 13</p>
<p>Nikon Transfer 2 does not start when camera is connected to a computer.</p>	<ul style="list-style-type: none"> Camera is off. Battery is exhausted. USB cable is not correctly connected. Camera is not recognized by the computer. Confirm that the operating system used is compatible with the camera. Computer is not set to launch Nikon Transfer 2 automatically. <p>For more information on Nikon Transfer 2, refer to help information contained in ViewNX 2.</p>	<p>23 22 73 – 74 77</p>
<p>Pictures to be printed are not displayed.</p>	<ul style="list-style-type: none"> Memory card contains no pictures. Replace memory card. Remove memory card to print pictures from internal memory. 	<p>20 21</p>
<p>Cannot select paper size with camera.</p>	<p>Paper size cannot be selected from the camera in the following situations, even for PictBridge compatible printers. Use the printer to select paper size.</p> <ul style="list-style-type: none"> The paper size selected using the camera is not compatible with the printer. A printer that automatically sets the paper size is being used. 	<p>26, 27 –</p>

GPS

Problem	Cause/Solution	
Unable to identify the location or it takes time to identify the location.	<ul style="list-style-type: none"> • The camera may not be able to identify the location in some shooting environments. To use the GPS feature, use the camera as much as possible in an open-air area. • When positioning for the first time, when positioning was unable to be performed for about two hours, or after the battery was changed, it takes a few minutes to obtain the positioning information. 	87 87
Unable to record position information on shot images.	When  or  is displayed on the shooting screen, the position information is not recorded. Before shooting pictures, make sure that the camera is receiving a GPS signal at sufficient strength.	86
Difference between the actual shooting location and recorded position information.	The acquired position information may deviate in some shooting environments. When there is a significant difference in the signals from the GPS satellite, there could be a deviation of up to several hundred meters.	87
An incorrect location name is recorded or the correct location name is not displayed.	The desired landmark name is not registered or an incorrect landmark name is displayed.	-
Unable to update the A-GPS file.	<ul style="list-style-type: none"> • Check the following items. <ul style="list-style-type: none"> - Whether the memory card is inserted - Whether the A-GPS file is stored in the memory card - Whether the A-GPS file saved in a memory card is more recent than the A-GPS file saved in the camera - Whether the A-GPS file is still valid • The A-GPS file may be corrupted. Download the file from the website once more. 	-  57
Unable to save log data.	<ul style="list-style-type: none"> • Be sure that a memory card is inserted in the camera. • Up to 36 log data events can be recorded in a day. • Up to 100 log data events can be stored on a single memory card. Delete log data that is no longer required from a memory card or replace the memory card with a new one. 	- -  63

Specifications

Nikon COOLPIX AW100 Digital Camera

Type	Compact digital camera
Effective pixels	16.0 million
Image sensor	1/2.3-in. type CMOS; approx. 16.79 million total pixels
Lens	5× optical zoom, NIKKOR lens
Focal length	5.0-25.0mm (angle of view equivalent to that of 28-140 mm lens in 35mm [135] format)
f/-number	f/3.9-4.8
Construction	12 elements in 10 groups (including 2 ED lens elements)
Digital zoom	Up to 4× (angle of view equivalent to that of approx. 560 mm lens in 35mm [135] format)
Vibration reduction	Lens shift and electronic VR methods (still pictures) Lens shift method (movies)
Autofocus (AF)	Contrast-detect AF
Focus range (from lens)	<ul style="list-style-type: none">• Approx. 50 cm (1 ft 8 in.) to ∞ (W); approx. 1 m (3 ft 4 in.) to ∞ (T)• Macro mode: 1 cm (0.4 in.) (at a wide-angle zoom position beyond ) to ∞
Focus-area selection	Face priority, auto (9-area automatic selection), center, manual with 99 focus areas, subject tracking
Monitor	7.5 cm (3-in.), approx. 460k-dot, wide viewing angle TFT LCD monitor with anti-reflection coating and 5-level brightness adjustment
Frame coverage (shooting mode)	Approx. 98% horizontal and 98% vertical (compared to actual picture)
Frame coverage (playback mode)	Approx. 100% horizontal and 100% vertical (compared to actual picture)
Storage	
Media	Internal memory (approx. 83 MB), SD/SDHC/SDXC memory card
File system	DCF, Exif 2.3, and DPOF compliant
File formats	Still pictures: JPEG Sound files (voice memo): WAV Movies: MOV (Video: H.264/MPEG-4 AVC, Audio: AAC stereo)
Image size (pixels)	<ul style="list-style-type: none">• 16 M (High) 4608×3456★• 16 M 4608×3456• 12 M 4000×3000• 8 M 3264×2448• 5 M 2592×1944• 3 M 2048×1536• PC 1024×768• VGA 640×480• 16:9 4608×2592

ISO sensitivity (Standard output sensitivity)	<ul style="list-style-type: none"> • ISO 125, 200, 400, 800, 1600, 3200 • Auto (auto gain from ISO 125 to 800) • Fixed range auto (ISO 125 to 400)
Exposure	
Metering	256-segment matrix, Center-weighted (when digital zoom is below 2x), spot (when digital zoom is 2x or higher)
Exposure control	Programmed auto, motion detection, exposure compensation (-2.0 to +2.0 EV in steps of 1/3 EV)
Shutter	Mechanical and CMOS electronic shutter
Speed	1/1500 - 1 s, 4 s (Fireworks show scene mode)
Aperture	Electronically-controlled ND filter (-2 AV) selection mode
Range	2 (f/3.9, f/7.8 [W])
Self-timer	Durations of 2 or 10 seconds can be selected
Built-in flash	
Range (approx.) (ISO sensitivity: Auto)	[W]: Approx. 0.3 to 3.5 m (1 ft to 11 ft) [T]: Approx. 0.5 to 2.2 m (1 ft 8 in. to 7 ft 2 in.)
Flash control	TTL auto flash with monitor preflashes
Interface	Hi-Speed USB
Data transfer protocol	MTP, PTP
Video output	Can be selected from NTSC and PAL
HDMI output	Can be selected from Auto, 480p, 720p, and 1080i
I/O terminal	Audio/video (AV) output; digital I/O (USB), HDMI Mini Connector (Type C) (HDMI output)
Digital compass	8 cardinal and intercardinal direction to be detected (position correction using 3-axis acceleration sensor, automatic correction for the deviated angle, and automatic offset adjustment)
GPS	Receiver frequency 1574.52 MHz (C/A code), geodetic system WGS 84
Supported languages	Arabic, Brazilian Portuguese, Chinese (Simplified and Traditional), Czech, Danish, Dutch, English, Finnish, French, German, Greek, Hindi, Hungarian, Indonesian, Italian, Japanese, Korean, Norwegian, Polish, Portuguese, Romanian, Russian, Spanish, Swedish, Thai, Turkish, Ukrainian, Vietnamese
Power sources	<ul style="list-style-type: none"> • One Rechargeable Li-ion Battery EN-EL12 (included) • AC Adapter EH-62F (available separately)
Battery life (EN-EL12)	Still pictures ¹ : Approx. 250 shots Movies ² : Approx. 1 h 35 min (HD 1080p★ (1920×1080))
Tripod socket	1/4 (ISO 1222)
Dimensions (W × H × D)	Approx. 110.1 × 64.9 × 22.8 mm (4.4 × 2.6 × 0.9 in.) (excluding projections)
Weight	Approx. 178 g (6.3 oz) (including battery and SD memory card)

Specifications

Operating environment	
Temperature	-10°C to +40°C (14°F to 104°F) (for land use) 0°C to 40°C (32°F to 104°F) (for underwater use)
Humidity	85% and below (no condensation)
Waterproof	JIS/IEC protection class 8 (IPX8) equivalent (under our testing conditions) Capacity to shoot pictures underwater up to a depth of 10 m (33 ft) and for 60 minutes
Dustproof	JIS/IEC protection class 6 (IP6X) equivalent (under our testing conditions)
Shockproof	Cleared our testing conditions ³ compliant with MIL-STD 810F Method 516.5-Shock

- Unless otherwise stated, all figures are for a camera with a fully-charged Rechargeable Li-ion Battery EN-EL12 operated at an ambient temperature of 25°C (77°F).

¹ Based on Camera and Imaging Products Association (CIPA) standards for measuring the life of camera batteries. Measured at 23 (±2) °C (73 (±4) °F); zoom adjusted with each shot, flash fired with every other shot, Image mode set to **16:9 4608×3456**. Battery life may vary depending on shooting interval and length of time menus and images are displayed.

² When recording a single movie, the maximum recording time is 29 minutes and file size is up to 4 GB even when there is enough free space on the memory card.

³ Dropped from a height of 152 cm (60 in.) onto a surface of 5cm (2 in.) thick plywood (changes in appearance, such as paint peeling off and deformation of the drop shock portion and waterproof performance are not subject to the test). These tests do not guarantee that the camera will be free from damage or trouble under all conditions.

Rechargeable Li-ion Battery EN-EL12

Type	Rechargeable lithium-ion battery
Rated capacity	DC 3.7 V, 1050 mAh
Operating temperature	-10°C to +40°C (14°F to 104°F)
Dimensions (W × H × D)	Approx. 32 × 43.8 × 7.9 mm (1.3 × 1.7 × 0.3 in.) (excluding projections)
Weight	Approx. 22.5 g (0.8 oz) (excluding terminal cover)

Battery Charger MH-65

Rated input	AC 100 to 240 V, 50/60 Hz, 0.08 to 0.05 A
Rated output	DC 4.2 V, 0.7 A
Supported rechargeable battery	Rechargeable Li-ion Battery EN-EL12
Charging time	Approx. 2 hours and 30 minutes when no charge remains
Operating temperature	0°C to 40°C (32°F to 104°F)
Dimensions (W × H × D)	Approx. 58 × 27.5 × 80 mm (2.3 × 1.1 × 3.1 in.) (excluding power cable)
Length of power cable	Approx. 1.8 m (6 ft)
Weight	Approx. 70 g (2.5 oz) (excluding power cable)

Specifications

- Nikon will not be held liable for any errors this manual may contain.
- The appearance of this product and its specifications are subject to change without notice.

Supported Standards

- **DCF:** Design Rule for Camera File System is a standard widely used in the digital camera industry to ensure compatibility among different makes of camera.
- **DPOF:** Digital Print Order Format is an industry-wide standard that allows pictures to be printed at a digital photo lab or with a household printer from print orders stored on the memory card.
- **Exif version 2.3:** This camera supports Exif (Exchangeable Image File Format for Digital Still Cameras) version 2.3, a standard that allows information stored with photographs to be used for optimal color reproduction when images are output from Exif-compliant printers.
See the instruction manual of the printer for further details.
- **PictBridge:** A standard developed cooperatively by the digital camera and printer industries, allowing photographs to be output directly to a printer without connecting the camera to a computer.

Index

Symbols

AE/AF-L 

OK Apply selection button 5, 10



 Auto mode 51

Auto Auto sort mode 70, 

 Delete button 4, 5, 34, 

 Easy auto mode 38

 Exposure compensation 58

 Favorite pictures mode 70, 

 Flash mode 54

 Image thumbnail display 33

 List by Date Mode 70, 

 Macro mode 57

MENU Menu button 4, 5, 11

 movie-record) button 80

 Playback button 4, 5, 32

 Playback zoom 33

 Scene mode 39

 Self-timer 56

 Shooting mode button 9, 26

 Smart portrait mode 49

T Tele 29

W Wide 29

.JPG 

.MOV 

.WAV 

A

A/V cable 

AC adapter 17, 

Action button 13

Action control 13

Action control response 95, 

AF area mode 52, 

AF assist 95, 

Album 9, 11

Assign action button 96, 

Attaching the camera strap 14

Audio/video cable 73, 

Audio/video-in jack 73, 



Auto 55

Auto mode 51

Auto off 95, 

Auto sort mode 70, 

Autofocus 52, 57, 41, 56

Autofocus mode 52, 83, 41, 56

AV cable 73, 

B

Backlighting  44

Battery 16, 18, 

Battery charger 16, 

Battery level indicator 22

Battery-chamber/memory card slot cover
18, 20

Beach  41

Best shot selector 52, 

Black and white copy  43

Blink proof 50, 

Blink warning 96, 

BSS 52, 

Button sound 

C

Calendar Display 33

Camera strap for land use 14

Charger 16, 

Choose key picture 72, 

Close-up  42

Compression ratio 61

Computer 73

Continuous 52, 

Crop 21, 30

D

Date and time 24, 

Date imprint 94, 

Daylight saving time 25

Delete 34, 84, 

Digital zoom 29, 95, 

Direct Print 

Displaying map 13





D-Lighting 71, 

DPOF printing 

















DSCN 

Dusk/dawn  42

E

Easy auto shooting menu 38
 Easy panorama 45, 
 Editing Images 
 Editing movies 
 Exposure compensation 58
 Extension 
 Extracting parts of the movie 84
 Eyelet for camera strap 14



E



Face detection 65
 Face priority 52, 
 Favorite pictures 72, 
 Favorite pictures mode 70, 
 Features that cannot be used simultaneously 63
 File name 
 Fill flash 55
 Filter adapter 14
 Filter effects 71, 
 Fireworks show  43
 Firmware version 96, 
 Flash 54
 Flash mode 54
 Focus 30, 52, 
 Focus area 52, 
 Focus lock 67
 Folder name 
 Food  43
 Format 20, 96, 
 Format the internal memory 96, 
 Format the memory card 20, 
 FSCN 
 Full-time AF 52, 

G



Glamour retouch 71, 

H







HDMI 96, 
 HDMI device control 96, 
 HDMI mini connector 73, 

HS movie 83, 











I

Identifier 
 Image copy 71, 
 Image mode 61, 62
 ISO sensitivity 52, 



L

Landscape  40
 Language 96, 
 Lens 28, 
 Li-ion rechargeable battery 16, 
 List by date mode 70, 
 Lithium-ion type battery 



M

Macro mode 57
 Memory capacity 22
 Memory card 20, 21
 Memory card slot 20
 Microphone 71, 83, 
 Monitor 6, 8, 
 Monitor brightness 94, 
 Monitor settings 94, 
 Motion detection 95, 
 Movie length 82
 Movie light 83, 
 Movie options 83, 
 Movie recording 80
 Multi selector 4, 5, 10, 53
 Multi-shot 16 52, 
 Museum  43

N



















Night landscape  42
 Night portrait  41
 Number of exposures remaining 22, 62

O

Off 55
 Open with HS footage 83, 
 Operation sound 95, 
 Optical zoom 29
 Optional accessories 

Index







P

Panorama assist 45, 
Panorama  45
Paper size 26, 27
Party/indoor  41
Pet portrait  46
Photo info 94, 70
PictBridge 24, 23
Playback 32, 70, 84, 49
Playback menu 71
Playback modes 70
Playback zoom 33
Playing back movies 84
Portrait  40
Power 22, 23, 24
Power switch/Power-on lamp 23
Preset manual 35
Print 24, 26, 27
Print order 71, 42
Print Order Date Option 43
Printer 73, 24
Protect 71, 46



Q















Quick retouch 71, 17

R





Rechargeable battery 16, 87
Recording slow motion movies 54
Red-eye reduction 55
Remove from favorites 72, 10
Reset all 96, 81
Rotate image 71, 48
RSCN 85

S

Scene mode 39, 40
Selecting pictures 47
Self-timer 56
Self-timer lamp 56
Sequence 7
Sequence display options 72, 51
Setup menu 94
Shooting 26
Shooting menu 51

Shutter sound 95, 76
Shutter-release button 4, 5, 30
Single 52, 36
Single AF 52, 41, 56
Skin softening 50, 66, 32
Slide show 71, 45
Slow sync 55
Small picture 71, 20
Smart portrait menu 50
Smart portrait mode 49
Smile timer 50, 32
Snow  41
Sound settings 95, 76
Special effects menu 48
Special effects mode 47
Sports  40
SSCN 85
Subject tracking 52, 39, 40
Sunset  41



T

Tele 29
Thumbnail Playback 33
Time difference 69
Time zone 24, 69
Time zone and date 24, 94, 67
TV settings 96, 79



U

Underwater  46
USB cable 73, 25, 87
USB/audio/video output connector 73, 22, 25

V

Vibration reduction 94, 73
Video mode 96
Video output 79
ViewNX 2 74
Voice memo 71, 49
Volume 84

W

Welcome screen 94, 66
White balance 52, 34

Wide 29

Wind noise reduction 83, 56

Z

Zoom 29

Zoom buttons 4, 5, 29

Nikon

No reproduction in any form of this manual, in whole or in part (except for brief quotation in critical articles or reviews), may be made without written authorization from NIKON CORPORATION.



NIKON CORPORATION

© 2011 Nikon Corporation

FX1H03(11)
6MM15311-03