

Nikon

DIGITAL CAMERA

1 s1

Reference Manual

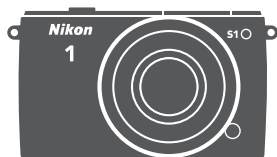

En

Thank you for your purchase of a Nikon digital camera. To get the most from your camera, please be sure to read all instructions thoroughly and keep them where they will be read by all who use the product.

Camera Settings

The explanations in this manual assume that default settings are used.

Symbols and Conventions

To make it easier to find the information you need, the following symbols and conventions are used:



This icon marks cautions; information that should be read before use to prevent damage to the camera.



This icon marks notes; information that should be read before using the camera.



This icon marks references to other pages in this manual.

The ▲, ▼, ◀, and ▶ symbols represent up, down, left, and right on the multi selector.

Digitutor

































“Digitutor”, a series of “watch and learn” manuals in movie form, is available from the following website:

http://www.nikondigitutor.com/index_eng.html

For Your Safety

Before using the camera for the first time, read the safety instructions in “For Your Safety” (□ x–xii).

1 S1

Getting the Most from Your Camera	 ii
Table of Contents	 iv
 Introduction	 1
 Auto Mode	 23
 Creative Mode	 33
 Best Moment Capture Mode	 45
 Motion Snapshot Mode	 53
 Recording and Viewing Movies	 57
 More on Photography	 67
 More on Playback	 79
 Connections	 91
 The Playback Menu	 107
 The Shooting Menu	 117
 The Movie Menu	 137
 The Image Processing Menu	 141
 The Setup Menu	 155
 Technical Notes	 163

Getting the Most from Your Camera

Take photos with the shutter-release button.

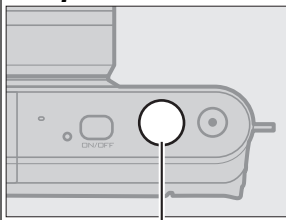

Shutter-release button

Photos can be taken in any mode by pressing the shutter-release button. See page 8 for more information.

Shoot movies with the movie-record button.

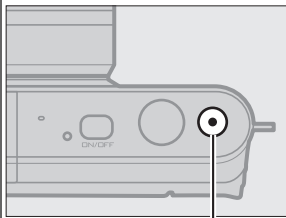

Movie-record button

Movies can be recorded by pressing the movie-record button in auto (📖 31), creative (📖 43), and advanced movie (📖 57) modes.

Create short movies with music.

Install the supplied software (📖 91), **copy** photos and movies to your computer using ViewNX 2 (📖 95), and use Short Movie Creator to **create** short movies (📖 98).

View short movies in high definition.

Transfer short movies to the camera (📖 99) and use an HDMI cable to **connect the camera to an HDTV** (📖 100).

Accessories

Expand your photographic horizons with a wide variety of interchangeable lenses and other accessories (📖 163).



Lenses



Wireless mobile adapters



Software for Nikon digital cameras (available on CD)



Mount adapters



Waterproof cases

Table of Contents

Getting the Most from Your Camera	ii
Accessories	iii
For Your Safety.....	x
Notices.....	xiii
Introduction	1
Before You Begin	1
Parts of the Camera.....	2
The Camera Body	2
The Monitor.....	4
The Multi Selector	6
The MENU Button	7
First Steps.....	13
Auto Mode	23
Taking Photos in Auto Mode.....	23
Viewing Photographs	29
Deleting Pictures	30
Recording Movies in Auto Mode	31
Creative Mode	33
Choosing a Creative Mode.....	33
Choosing a Scene	34
Taking Photos in P, S, A, and M Modes	36
P Programmed Auto.....	36
S Shutter-Priority Auto.....	37
A Aperture-Priority Auto	38
M Manual	39
Backlighting	42
Recording Movies in Creative Mode	43

Best Moment Capture Mode	45
Slow View.....	45
Smart Photo Selector.....	47
Viewing Photos Taken with the Smart Photo Selector	50
Choosing the Best Shot	50
Deleting Pictures.....	51
Motion Snapshot Mode	53
Shooting in Motion Snapshot Mode	53
Viewing Motion Snapshots	56
Deleting Motion Snapshots	56
Recording and Viewing Movies	57
Recording HD Movies.....	58
Recording Slow-Motion Movies	62
Viewing Movies	65
Deleting Movies	66
More on Photography	67
Single-Frame, Continuous, and Self-Timer Modes	67
Continuous Mode.....	67
Self-Timer Modes.....	69
Exposure Compensation	71
The Built-in Flash.....	72
Choosing a Flash Mode	73
The WU-1b Wireless Mobile Adapter	76
More on Playback	79
Photo Information	79
Thumbnail Playback.....	82
Calendar Playback	83
Playback Zoom	84

Deleting Pictures	85
Deleting the Current Picture	85
The Playback Menu	85
Rating Pictures	86
Slide Shows	87
Connections	91
<hr/>	
Installing the Supplied Software	91
System Requirements	93
Viewing and Editing Pictures on a Computer	95
Transferring Pictures	95
Viewing Pictures	96
Creating Short Movies	98
Viewing Pictures on TV	100
High-Definition Devices	100
Printing Photographs	102
Connecting the Printer	102
Printing Pictures One at a Time	103
Printing Multiple Pictures	104
Creating a DPOF Print Order: Print Set	106
The Playback Menu	107
<hr/>	
Selecting Multiple Images	109
Image Review	110
Rotate Tall	110
Protect	110
Rating	110
D-Lighting	111
Resize	112
Crop	113
Face-Priority Zoom	114
Edit Movie	114
Change Theme	115

The Shooting Menu	117
Reset Shooting Options	119
Exposure Mode	119
Image Quality	120
Image Size	120
Number of Shots Saved	122
Movie Before/After	122
File Format	123
Metering	123
Auto Distortion Control	124
Color Space	125
Active D-Lighting	126
Long Exposure NR	127
Optical VR	127
Electronic VR	128
Focus Mode	128
Manual Focus	131
AF-Area Mode	133
Focus Lock	134
Face-Priority	135
Built-in AF Assist	135
Flash Compensation	136
The Movie Menu	137
Reset Movie Options	138
Frame Rate	138
Movie Settings	139
Movie Sound Options	140

The Image Processing Menu **141**

Reset Processing Options	142
White Balance	142
Fine-Tuning White Balance	143
Preset Manual	144
ISO Sensitivity	147
Picture Control	148
Modifying Picture Controls.....	148
Custom Picture Control	152
Edit/Save.....	152
Load from/Save to Card	153
High ISO Noise Reduction	154

The Setup Menu **155**

Reset Setup Options	156
Format Memory Card.....	156
Slot Empty Release Lock	157
Display	157
Display Brightness	157
Grid Display	157
Shooting	157
Playback.....	158
Sound Settings	158
Auto Power Off	158
Shutter Button AE Lock	159
Flicker Reduction	159
Reset File Numbering	159
Time Zone and Date	160
Language	160
Auto Image Rotation	161
Pixel Mapping	162
Firmware Version	162

Optional Accessories	163
Approved Memory Cards.....	165
Approved Eye-Fi Cards	166
Attaching a Power Connector and AC Adapter.....	167
Storage and Cleaning.....	169
Storage	169
Cleaning	169
Caring for the Camera and Battery: Cautions.....	170
Available Settings	174
Defaults	178
Memory Card Capacity.....	179
Troubleshooting.....	181
Battery/Display	181
Shooting (All Modes).....	182
Shooting (P, S, A, and M Modes).....	183
Movies.....	183
Playback	184
Miscellaneous	184
Error Messages.....	185
Specifications.....	188
Nikon 1 S1 Digital Camera.....	188
Battery Life	204
Index.....	205

For Your Safety

To prevent damage to your Nikon product or injury to yourself or to others, read the following safety precautions in their entirety before using this equipment. Keep these safety instructions where all those who use the product will read them.

The consequences that could result from failure to observe the precautions listed in this section are indicated by the following symbol:



This icon marks warnings. To prevent possible injury, read all warnings before using this Nikon product.

■ WARNINGS

- ⚠ **Keep the sun out of the frame.** Keep the sun well out of the frame when shooting backlit subjects. Sunlight focused into the camera when the sun is in or close to the frame could cause a fire.
- ⚠ **Do not disassemble.** Touching the product's internal parts could result in injury. In the event of malfunction, the product should be repaired only by a qualified technician. Should the product break open as the result of a fall or other accident, remove the battery and/or AC adapter and then take the product to a Nikon-authorized service center for inspection.
- ⚠ **Turn off immediately in the event of malfunction.** Should you notice smoke or an unusual smell coming from the equipment or AC adapter (available separately), unplug the AC adapter and remove the battery immediately, taking care to avoid burns. Continued operation could result in injury. After removing the battery, take the equipment to a Nikon-authorized service center for inspection.
- ⚠ **Keep out of reach of children.** Failure to observe this precaution could result in injury. In addition, note that small parts constitute a choking hazard. Should a child swallow any part of this equipment, consult a physician immediately.
- ⚠ **Do not use in the presence of flammable gas.** Do not use electronic equipment in the presence of flammable gas, as this could result in explosion or fire.
- ⚠ **Do not place the strap around the neck of an infant or child.** Placing the camera strap around the neck of an infant or child could result in strangulation.

⚠ Do not remain in contact with the camera, battery, or charger for extended periods while the devices are on or in use. Parts of the device become hot. Leaving the device in direct contact with the skin for extended periods may result in low-temperature burns.

⚠ Do not aim the flash at the operator of a motor vehicle. Failure to observe this precaution could result in accidents.

⚠ Observe caution when using a flash.

- Using the camera with the flash in close contact with the skin or other objects could cause burns.
- Using a flash close to the subject's eyes could cause temporary visual impairment. Particular care should be observed when photographing infants, when the flash should be no less than one meter (39 in.) from the subject.

⚠ Avoid contact with liquid crystal. Should the display break, care should be taken to avoid injury due to broken glass and to prevent the liquid crystal from the display touching the skin or entering the eyes or mouth.

⚠ Observe proper precautions when handling batteries. Batteries may leak or explode if improperly handled. Observe the following precautions when handling batteries for use in this product:

- Use only batteries approved for use in this equipment.
- Do not short or disassemble the battery.
- Be sure the product is off before replacing the battery. If you are using an AC adapter, be sure it is unplugged.

- Do not attempt to insert the battery upside down or backwards.
- Do not expose the battery to flame or to excessive heat.
- Do not immerse in or expose to water.
- Replace the terminal cover when transporting the battery. Do not transport or store the battery with metal objects such as necklaces or hairpins.
- Batteries are prone to leakage when fully discharged. To avoid damage to the product, be sure to remove the battery when no charge remains.
- When the battery is not in use, attach the terminal cover and store in a cool, dry place.
- The battery may be hot immediately after use or when the product has been used on battery power for an extended period. Before removing the battery turn the camera off and allow the battery to cool.
- Discontinue use immediately should you notice any changes in the battery, such as discoloration or deformation.

⚠ Observe proper precautions when handling the charger:

- Keep dry. Failure to observe this precaution could result in fire or electric shock.
- Do not short the charger terminals. Failure to observe this precaution could result in overheating and damage to the charger.
- Dust on or near the metal parts of the plug should be removed with a dry cloth. Continued use could result in fire.
- Do not go near the charger during thunderstorms. Failure to observe this precaution could result in electric shock.
- Do not handle the plug or charger with wet hands. Failure to observe this precaution could result in electric shock.
- Do not use with travel converters or adapters designed to convert from one voltage to another or with DC-to-AC inverters. Failure to observe this precaution could damage the product or cause overheating or fire.

⚠ Use appropriate cables. When connecting cables to the input and output jacks, use only the cables provided or sold by Nikon for the purpose to maintain compliance with product regulations.

⚠ CD-ROMs: CD-ROMs containing software or manuals should not be played back on audio CD equipment. Playing CD-ROMs on an audio CD player could cause hearing loss or damage the equipment.

Notices

- No part of the manuals included with this product may be reproduced, transmitted, transcribed, stored in a retrieval system, or translated into any language in any form, by any means, without Nikon's prior written permission.
- Nikon reserves the right to change the specifications of the hardware and software described in these manuals at any time and without prior notice.
- Nikon will not be held liable for any damages resulting from the use of this product.
- While every effort has been made to ensure that the information in these manuals is accurate and complete, we would appreciate it were you to bring any errors or omissions to the attention of the Nikon representative in your area (address provided separately).

Notice for Customers in Canada

CAUTION

This Class B digital apparatus complies with Canadian ICES-003.

ATTENTION

Cet appareil numérique de la classe B est conforme à la norme NMB-003 du Canada.

Notice for Customers in Europe

CAUTION: RISK OF EXPLOSION IF BATTERY IS REPLACED BY AN INCORRECT TYPE. DISPOSE OF USED BATTERIES ACCORDING TO THE INSTRUCTIONS.

This symbol indicates that electrical and electronic equipment is to be collected separately.



The following apply only to users in European countries:

- This product is designated for separate collection at an appropriate collection point. Do not dispose of as household waste.
- Separate collection and recycling helps conserve natural resources and prevent negative consequences for human health and the environment that might result from incorrect disposal.
- For more information, contact the retailer or the local authorities in charge of waste management.

This symbol on the battery indicates that the battery is to be collected separately.



The following apply only to users in European countries:

- All batteries, whether marked with this symbol or not, are designated for separate collection at an appropriate collection point. Do not dispose of as household waste.
- For more information, contact the retailer or the local authorities in charge of waste management.

Notice for Customers in the U.S.A.

The Battery Charger

IMPORTANT SAFETY INSTRUCTIONS—SAVE THESE INSTRUCTIONS

DANGER—TO REDUCE THE RISK OF FIRE OR ELECTRIC SHOCK, CAREFULLY FOLLOW THESE INSTRUCTIONS

For connection to a supply not in the U.S.A., use an attachment plug adapter of the proper configuration for the power outlet if needed. This power unit is intended to be correctly oriented in a vertical or floor mount position.

Federal Communications Commission (FCC) Radio Frequency Interference Statement

This equipment has been tested and found to comply with the limits for a Class B digital device, pursuant to Part 15 of the FCC rules. These limits are designed to provide reasonable protection against harmful interference in a residential installation. This equipment generates, uses, and can radiate radio frequency energy and, if not installed and used in accordance with the instructions, may cause harmful interference to radio communications. However, there is no guarantee that interference will not occur in a particular installation. If this equipment does cause harmful interference to radio or television reception, which can be determined by turning the equipment off and on, the user is encouraged to try to correct the interference by one or more of the following measures:

- Reorient or relocate the receiving antenna.
- Increase the separation between the equipment and receiver.
- Connect the equipment into an outlet on a circuit different from that to which the receiver is connected.
- Consult the dealer or an experienced radio/television technician for help.



Nikon
1 S1

CAUTIONS

Modifications

The FCC requires the user be notified that any changes or modifications made to this device that are not expressly approved by Nikon Corporation may void the user's authority to operate the equipment.

Interface Cables

Use the interface cables sold or provided by Nikon for your equipment. Using other interface cables may exceed the limits of Class B Part 15 of the FCC rules.

Notice for Customers in the State of California

WARNING: Handling the cord on this product may expose you to lead, a chemical known to the State of California to cause birth defects or other reproductive harm. *Wash hands after handling.*

Nikon Inc., 1300 Walt Whitman Road,
Melville, New York 11747-3064, U.S.A.
Tel.: 631-547-4200

Notice Concerning Prohibition of Copying or Reproduction

Note that simply being in possession of material that has been digitally copied or reproduced by means of a scanner, digital camera, or other device may be punishable by law.

• Items prohibited by law from being copied or reproduced

Do not copy or reproduce paper money, coins, securities, government bonds, or local government bonds, even if such copies or reproductions are stamped "Sample."

The copying or reproduction of paper money, coins, or securities which are circulated in a foreign country is prohibited.

Unless the prior permission of the government has been obtained, the copying or reproduction of unused postage stamps or post cards issued by the government is prohibited.

The copying or reproduction of stamps issued by the government and of certified documents stipulated by law is prohibited.

• Cautions on certain copies and reproductions

The government has issued cautions on copies or reproductions of securities issued by private companies (shares, bills, checks, gift certificates, etc.), commuter passes, or coupon tickets, except when a minimum of necessary copies are to be provided for business use by a company. Also, do not copy or reproduce passports issued by the government, licenses issued by public agencies and private groups, ID cards, and tickets, such as passes and meal coupons.

• Comply with copyright notices

The copying or reproduction of copyrighted creative works such as books, music, paintings, woodcuts, prints, maps, drawings, movies, and photographs is governed by national and international copyright laws. Do not use this product for the purpose of making illegal copies or to infringe copyright laws.

Disposing of Data Storage Devices

Please note that deleting images or formatting memory cards or other data storage devices does not completely erase the original image data. Deleted files can sometimes be recovered from discarded storage devices using commercially available software, potentially resulting in the malicious use of personal image data. Ensuring the privacy of such data is the user's responsibility.

Before discarding a data storage device or transferring ownership to another person, erase all data using commercial deletion software, or format the device and then completely refill it with images containing no private information (for example, pictures of empty sky). Care should be taken to avoid injury when physically destroying data storage devices.

AVC Patent Portfolio License

THIS PRODUCT IS LICENSED UNDER THE AVC PATENT PORTFOLIO LICENSE FOR THE PERSONAL AND NON-COMMERCIAL USE OF A CONSUMER TO (I) ENCODE VIDEO IN COMPLIANCE WITH THE AVC STANDARD (“AVC VIDEO”) AND/OR (II) DECODE AVC VIDEO THAT WAS ENCODED BY A CONSUMER ENGAGED IN A PERSONAL AND NON-COMMERCIAL ACTIVITY AND/OR WAS OBTAINED FROM A VIDEO PROVIDER LICENSED TO PROVIDE AVC VIDEO. NO LICENSE IS GRANTED OR SHALL BE IMPLIED FOR ANY OTHER USE. ADDITIONAL INFORMATION MAY BE OBTAINED FROM MPEG LA, L.L.C. SEE <http://www.mpegla.com>

Temperature Warnings

The camera may become warm to the touch during use; this is normal and does not indicate a malfunction. At high ambient temperatures, after extended periods of continuous use, or after several photographs have been taken in quick succession, a temperature warning may be displayed, following which the camera will turn off automatically to minimize damage to its internal circuits. Wait for the camera to cool before resuming use.

Use Only Nikon Brand Electronic Accessories

Nikon cameras are designed to the highest standards and include complex electronic circuitry. Only Nikon brand electronic accessories (including chargers, batteries, AC adapters, and lens accessories) certified by Nikon specifically for use with this Nikon digital camera are engineered and proven to operate within the operational and safety requirements of this electronic circuitry.

The use of non-Nikon electronic accessories could damage the camera and may void your Nikon warranty. The use of third-party rechargeable Li-ion batteries not bearing the Nikon holographic seal shown at right could interfere with normal operation of the camera or result in the batteries overheating, igniting, rupturing, or leaking.



For more information about Nikon brand accessories, contact a local authorized Nikon dealer.

Use Only Nikon Brand Accessories

Only Nikon brand accessories certified by Nikon specifically for use with your Nikon digital camera are engineered and proven to operate within its operational and safety requirements. THE USE OF NON-NIKON ACCESSORIES COULD DAMAGE YOUR CAMERA AND MAY VOID YOUR NIKON WARRANTY.

Servicing the Camera and Accessories

The camera is a precision device and requires regular servicing. Nikon recommends that the camera be inspected by the original retailer or a Nikon-authorized service representative once every one to two years, and that it be serviced once every three to five years (note that fees apply to these services). Frequent inspection and servicing are particularly recommended if the camera is used professionally. Any accessories regularly used with the camera, such as lenses, should be included when the camera is inspected or serviced.

Before Taking Important Pictures

Before taking pictures on important occasions (such as at weddings or before taking the camera on a trip), take a test shot to ensure that the camera is functioning normally. Nikon will not be held liable for damages or lost profits that may result from product malfunction.

Life-Long Learning

As part of Nikon's "Life-Long Learning" commitment to ongoing product support and education, continually-updated information is available on-line at the following sites:

- **For users in the U.S.A.:** <http://www.nikonusa.com/>
- **For users in Europe and Africa:** <http://www.europe-nikon.com/support/>
- **For users in Asia, Oceania, and the Middle East:** <http://www.nikon-asia.com/>

Visit these sites to keep up-to-date with the latest product information, tips, answers to frequently-asked questions (FAQs), and general advice on digital imaging and photography. Additional information may be available from the Nikon representative in your area. For contact information, visit <http://imaging.nikon.com/>

Introduction

Before You Begin

Before using your camera for the first time, confirm that the package contains the items listed in the *User's Manual*.



Parts of the Camera

Take a few moments to familiarize yourself with camera controls and displays. You may find it helpful to bookmark this section and refer to it as you read through the rest of the manual.

The Camera Body

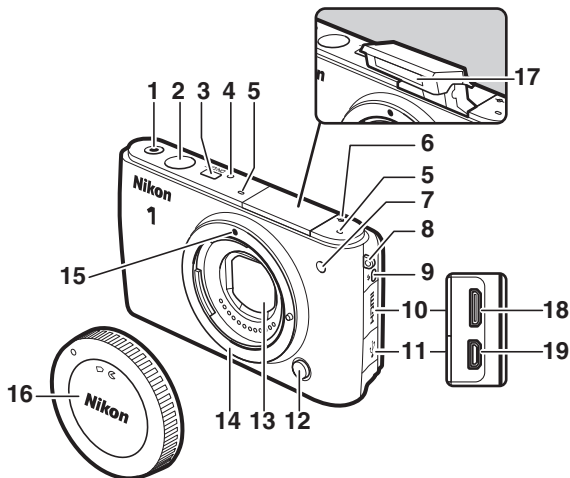

1 Movie-record button 31, 43, 57, 59, 63	9 Flash pop-up button..... 72
2 Shutter-release button 25, 46, 48, 54, 61	10 HDMI connector cover 100
3 Power switch..... 19	11 USB connector cover 76, 95, 102
4 Power lamp 19	12 Lens release button..... 196
5 Microphone..... 140	13 Dust shield 169, 170
6 Focal plane mark (☉)..... 132	14 Lens mount 18, 132
7 AF-assist illuminator 135	15 Mounting mark 18
Self-timer lamp 69	16 Body cap 164
Red-eye reduction lamp 74	17 Built-in flash..... 72
8 Eyelet for camera strap..... 13	18 HDMI mini-pin connector..... 100
	19 USB connector 76, 95, 102

The Camera Body (Continued)

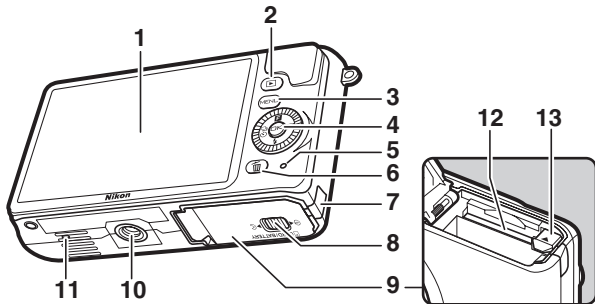

1 Monitor 4, 79, 157	6 (delete) button..... 30, 85
2 (playback) button 29, 50, 56	7 Power connector cover for optional power connector 167
3 MENU (menu) button 7	8 Battery-chamber/memory card slot cover latch..... 15, 17, 167
4 Multi selector..... 6	9 Battery-chamber/ memory card slot cover ... 15, 17, 167
(OK) button..... 6	10 Tripod socket *
(feature) 11	11 Speaker
(exposure compensation)..... 71	12 Memory card slot..... 15
(flash mode)..... 73	13 Battery latch..... 15, 17, 167
(continuous shooting/ self-timer)..... 67, 69	
5 Memory card access lamp 17, 24	

* Camera does not support TA-N100 tripod mounting spacer.

Holding the Camera

When framing photographs, hold the camera as shown below.

*Hold the camera in
your right hand.*

*Keep your elbows
propped lightly
against your torso.*

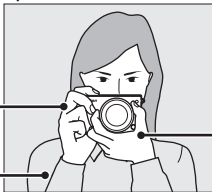

*Cradle the lens with
your left hand.*

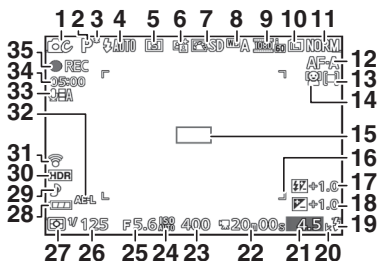

1 Shooting mode	8	19 Flash-ready indicator	72
2 Live image control	27	20 "K" (appears when memory remains	22
Creative mode	33, 34	for over 1000 exposures)	22
Best moment capture		21 Number of exposures remaining	22
selection	45, 47	Number of shots remaining	
Advanced movie selection	57, 62	before memory buffer fills	68
Exposure mode	119	White balance	
3 Flexible program indicator	36	recording indicator	145
4 Flash mode	72	Card warning indicator.....	157, 185
5 Self-timer	67, 69	22 Time available.....	59, 63
Continuous mode *	67	23 ISO sensitivity	147
6 Active D-Lighting *	126	24 ISO sensitivity indicator.....	147
7 Picture Control *	148	Auto ISO sensitivity indicator	147
8 White balance *	142	25 Aperture.....	38, 39
9 Movie settings (HD movies) *	139	26 Shutter speed	37, 39
Frame rate		27 Metering	123
(slow-motion movies) *	138	28 Battery indicator *	22
10 Image size *	120	29 Sound settings *	158
11 Image quality *	120	30 HDR	42
12 Focus mode *	128	31 Eye-Fi connection indicator *	166
13 AF-area mode *	133	32 Autoexposure (AE) lock	
14 Face-priority *	26, 135	indicator	159
15 Focus area	24, 133	33 Microphone sensitivity *	140
16 AF-area brackets *	128	34 Time elapsed.....	59, 63
17 Flash compensation	136	35 Recording indicator.....	59, 63
18 Exposure compensation	71		

* Available only when **Detailed** is selected for **Display > Shooting** in the setup menu (□ 157).

The Framing Grid

A framing grid can be displayed by selecting **On** for **Display > Grid display** in the setup menu (📖 157).

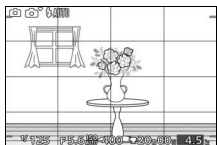

See also

For information on adjusting monitor brightness, see page 157.



The Multi Selector

The multi selector and  button are used to adjust settings and navigate the camera menus.

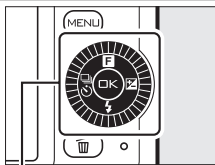

Multi selector

Settings:

See page 11.

Menu navigation:

Move cursor up.

Settings:

View continuous shooting/self-timer menu ( 67).

Menu navigation:

Return to previous menu.

Settings:

View flash mode menu ( 72).

Menu navigation:

Move cursor down.

Select highlighted item.

Settings:

View exposure compensation menu ( 71).

Menu navigation:

Select highlighted item or display sub-menu.

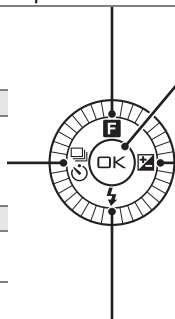

The Multi Selector

Items can be highlighted by rotating the multi selector as shown at right.



The MENU Button

The shooting mode and most shooting, playback, and setup options can be accessed from the camera menus. Press the MENU button to display the menu selection dialog shown below, then use the multi selector to highlight the icon for the desired menu and press \odot .

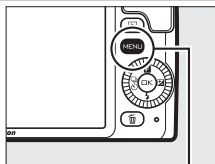

MENU button



Playback menu (📖 107):

Adjust playback settings.

Shooting menu (📖 117):

Adjust settings for still photography.

Shooting mode

menu (📖 8):
Choose a shooting mode.



Movie menu (📖 137):

Adjust movie-recording options.

Setup menu (📖 155):

Adjust basic camera settings.

Image processing menu (📖 141):

Adjust white balance, ISO sensitivity, Picture Controls, and other image processing settings for photographs and movies.

■ Choosing a Shooting Mode

To display the shooting mode menu, press the MENU button, highlight **Shooting mode**, and press \odot . Use the multi-selector to highlight a shooting mode and press \odot to select the highlighted option.



📷 Motion Snapshot mode (📖 53): Each time the shutter is released, the camera records a still image and about 1.6 s of movie footage. When the resulting “Motion Snapshot” is viewed on the camera, the movie will play back in slow motion over approximately 4 s, followed by the still image.

📷+ Best moment capture mode (📖 45): Choose the moment to release the shutter as the scene plays back in slow motion (slow view), or let the camera choose the best shot based on composition and motion (Smart Photo Selector).

📷 Auto mode (📖 23): Let the camera pick the settings for photographs and movies.

📷C Creative mode (📖 33): For photographs in which you want to use special effects, match settings to the scene, or control shutter speed and aperture.

📷+ Advanced movie mode (📖 57): Choose the shutter speed and aperture for HD movies or shoot slow-motion movies.

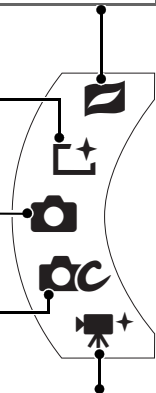

Options for each mode can be displayed by highlighting the mode and pressing ►. Press ◀ to return to the shooting mode menu.

📷 **Motion Snapshot mode:** Choose a theme (📖 55).

- **Beauty (1)**
- **Waves (2)**
- **Relaxation (3)**
- **Tenderness (4)**

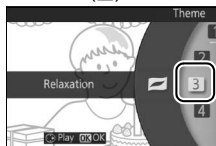
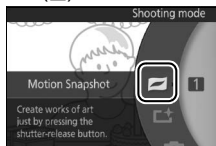

📷 **Best moment capture mode:** Choose between slow view and Smart Photo Selector modes (📖 45).

- **Slow view (📷)**
- **Smart Photo Selector (📷)**

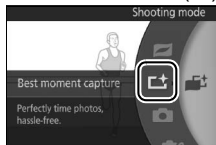

📷 **Auto mode:** Take photographs using live controls (📖 27).

- **Active D-Lighting (📷)**
- **Background softening (📷)**
- **Motion control (📷)**
- **Brightness control (📷)**

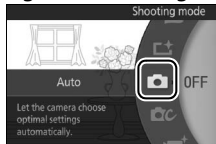

 **Creative mode:** Choose a scene (📖 33).

- **Programmed auto (P)**
- **Shutter-priority auto (S)**
- **Aperture-priority auto (A)**
- **Manual (M)**
- **Night landscape** 
- **Night portrait** 
- **Backlighting** 
- **Soft** 
- **Miniature effect** 
- **Selective color** 

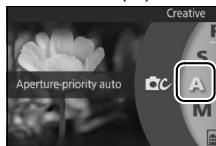

 **Advanced movie mode:** Choose between HD (📖 57) and slow-motion movies (📖 62).

- **Programmed auto (P)**
- **Shutter-priority auto (S)**
- **Aperture-priority auto (A)**
- **Manual (M)**
- **Slow motion** 

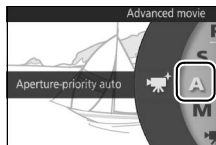
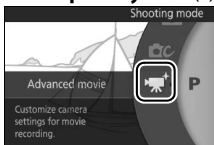

F (Feature)

The options for each mode can also be displayed by pressing the **F** key on the multi-selector after selecting the shooting mode.

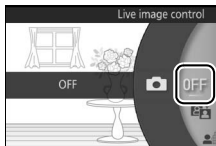
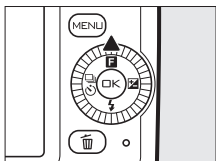

In playback mode, the **F** key can be used to rate pictures ( 86).

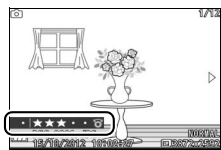

■ Using the Menus

Use the multi selector (📖 6) to navigate the playback, shooting, movie, image processing, and setup menus.

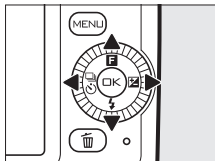

Multi selector

1 Select an item.

Press ▲ or ▼ to highlight menu items and press ► to view options for the highlighted item.

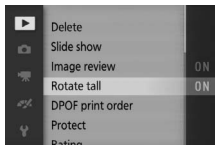

2 Select an option.

Press ▲ or ▼ to highlight the desired option and press Ⓞ to select.

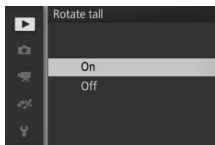

🔪 Using the Menus

The items listed may vary with camera settings. Items displayed in gray are not currently available (📖 174). To exit the menus and return to shooting mode, press the shutter-release button halfway (📖 25).

🔪 Choosing a Menu

To display another menu, press ◀ in Step 1 and then press ▲ or ▼ to highlight the desired icon. Press ► to position the cursor in the highlighted menu.

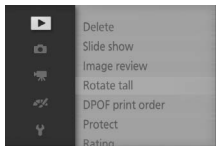

First Steps

1 Attach the camera strap.

Attach the strap securely to the two camera eyelets.

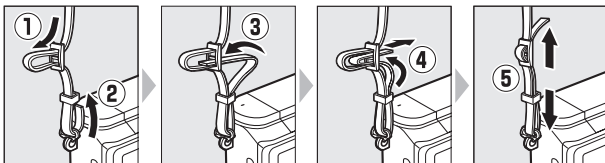

2 Charge the battery.

Insert the battery into the charger ① and plug the charger in ②. An exhausted battery fully charges in about two hours. Unplug the charger and remove the battery when charging is complete.

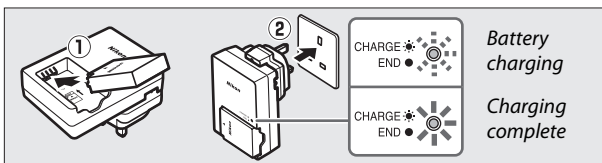

The Plug Adapter

Depending on the country or region of purchase, a plug adapter may be supplied with the charger. The shape of the adapter varies with the country or region of purchase. If a plug adapter is supplied, raise the wall plug and connect the plug adapter as shown at right, making sure the plug is fully inserted. Attempting to forcibly remove the plug adapter could damage the product.

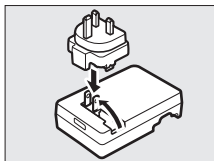



✔ The Battery and Charger

Read and follow the warnings and cautions on pages x–xii and 170–173 of this manual. Do not use the battery at ambient temperatures below 0°C (32°F) or above 40°C (104°F); failure to observe this precaution could damage the battery or impair its performance. Capacity may be reduced and charging times may increase at battery temperatures from 0°C (32°F) to 10°C (50°F) and from 45°C (113°F) to 60°C (140°F); the battery will not charge if its temperature is below 0°C (32°F) or above 60°C (140°F).

Charge the battery at ambient temperatures between 5°C (41°F) and 35°C (95°F). If the **CHARGE** lamp flashes quickly during charging, cease use immediately and take battery and charger to your retailer or a Nikon-authorized service representative.

Do not move the charger or touch the battery during charging. Failure to observe this precaution could in very rare instances result in the charger showing that charging is complete when the battery is only partially charged. Remove and reinsert the battery to begin charging again.

Use the charger with compatible batteries only. Unplug when not in use.

3 Insert the battery and a memory card.

Check to be sure the battery and card are in the correct orientation. Using the battery to keep the orange battery latch pressed to one side, slide the battery in until it latches, and then slide in the memory card until it clicks into place.

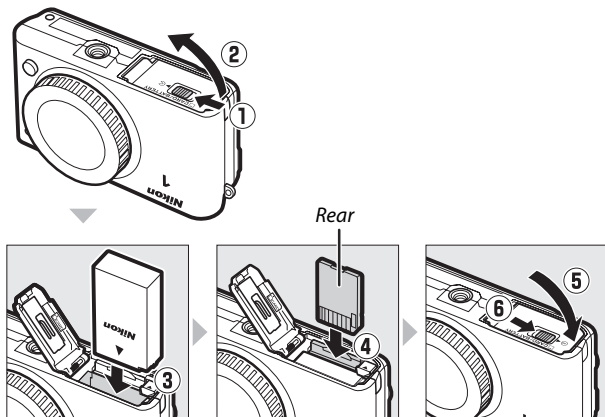

✔ Inserting and Removing Batteries and Memory Cards

Always turn the camera off before inserting or removing batteries or memory cards. Note that the battery and memory cards may be hot after use; observe due caution when removing the battery and memory cards.

✍ Formatting Memory Cards

If this is the first time the memory card will be used in the camera or if the card has been formatted in another device, select **Format memory card** in the setup menu and follow the on-screen instructions to format the card (📖 156). *Note that this permanently deletes any data the card may contain.* Be sure to copy any photographs and other data you wish to keep to a computer before proceeding.

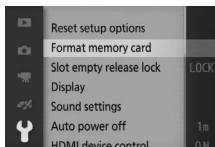

✍ The Write Protect Switch

Memory cards are equipped with a write protect switch to prevent accidental loss of data. When this switch is in the “lock” position, the memory card can not be formatted and photos can not be deleted or recorded. To unlock the memory card, slide the switch to the “write” position.

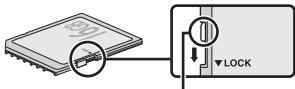

Write-protect switch

Removing Batteries and Memory Cards

After turning the camera off, confirm that the memory card access lamp (☐ 3) is off and open the battery-chamber/memory card slot cover. To remove the battery, first release it by pressing the orange battery latch in the direction shown by the arrow and then remove the battery by hand.

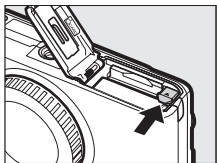

To remove a memory card, first press the card in to eject it (①); the card can then be removed by hand (②).

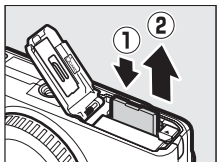

Memory Cards

- The camera stores pictures on SD, SDHC, and SDXC memory cards (available separately; ☐ 165).
- Do not remove memory cards from the camera, turn the camera off, or remove or disconnect the power source during formatting or while data are being recorded, deleted, or copied to a computer. Failure to observe these precautions could result in loss of data or in damage to the camera or card.
- Do not touch the card terminals with your fingers or metal objects.
- Do not bend, drop, or subject to strong physical shocks.
- Do not apply force to the card casing. Failure to observe this precaution could damage the card.
- Do not expose to water, heat, high levels of humidity, or direct sunlight.
- Do not format memory cards in a computer.



4 Attach a lens.

Be careful to prevent dust from entering the camera when the lens or body cap is removed. The lens generally used in this manual for illustrative purposes is a 1 NIKKOR VR 10–30mm f/3.5–5.6. See page 127 for information on vibration reduction (VR) and page 196 for information on removing lenses.

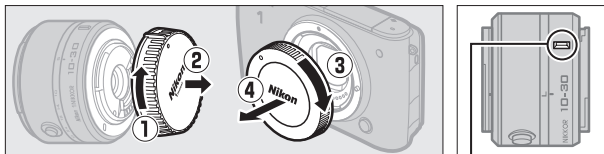

Mounting mark (lens)

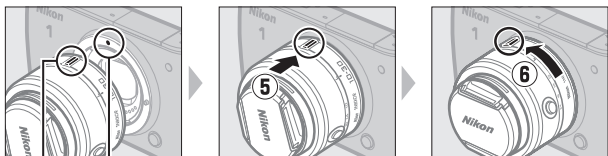

Mounting mark
(camera)

Keeping marks aligned, position lens on camera, then rotate until it clicks into place.

Mounting mark (lens)

Lenses with Retractable Lens Barrel Buttons

Lenses with retractable lens barrel buttons can not be used when retracted. To unlock and extend the lens, keep the retractable lens barrel button pressed (1) while rotating the zoom ring (2). The lens can be retracted and the zoom ring locked by pressing the retractable lens barrel button and rotating the ring in the opposite direction. Be careful not to press the retractable lens barrel button while attaching or removing the lens.

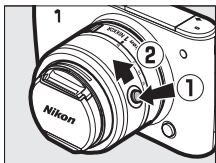

5 Turn the camera on.

Press the power switch to turn the camera on. The power lamp will briefly light green and the monitor will turn on. Be sure to remove the lens cap before shooting.

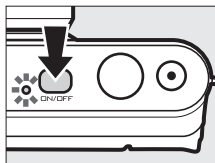

Turning the Camera Off

To turn the camera off, press the power switch again. The monitor will turn off.

Auto Power Off

If no operations are performed for about a minute, the display will turn off and the power lamp start to flash (if desired, the delay before the display turns off automatically can be changed using the **Auto power off** option in the setup menu;  158). The camera can be reactivated by operating the shutter-release button. If no operations are performed for about three minutes after the display has turned off, the camera will turn off automatically.

Attaching and Removing Lenses



Turn the camera off before attaching or removing lenses. Note that when the camera is turned off, the sensor protection barrier in the lens will close, protecting the camera image sensor.

Lenses with Retractable Lens Barrel Buttons



If you are using a lens with a retractable lens barrel button ( 18), the camera will turn on automatically when the retractable lens barrel lock is released; in addition, if the view through the lens is displayed or the monitor is off, the camera will turn off when the lens barrel is locked (in the case of 1 NIKKOR VR 10–30mm f/3.5–5.6 and 1 NIKKOR VR 30–110mm f/3.8–5.6 lenses, firmware version 1.10 or later is required if locking the lens barrel is to turn the camera off when the monitor is off; for information on updating lens firmware, visit the Nikon website for your area).





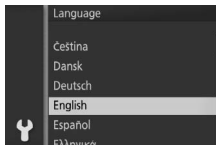

6 Choose a language and set the clock.

A language-selection dialog will be displayed the first time the camera is turned on. Use the multi selector and  button ( 6) to choose a language and set the camera clock. Photos can not be taken until you have set the time and date.

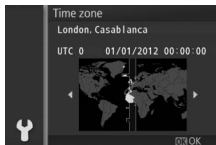



Press  or  to highlight language and press .



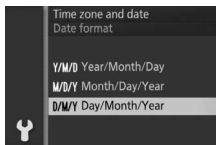

Press  or  to highlight time zone and press .



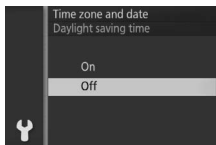



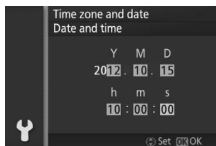

Press  or  to highlight date format and press .



Press  or  to highlight daylight saving time option and press .



Press  or  to select items and press  or  to change. Press  when finished.

Note: The camera uses a 24-hour clock. Language and clock can be changed at any time using **Language** ( 160) and **Time zone and date** ( 160) options in setup menu.

The Camera Clock

The camera clock is less accurate than most watches and household clocks. Check the clock regularly against more accurate time pieces and reset as necessary.

The camera clock is powered by an independent, rechargeable power source, which is charged as necessary when the main battery is installed or the camera is powered by an optional EP-5C power connector and EH-5b AC adapter (□ 167). Three days of charging will power the clock for about a month. If a message warning that the clock is not set is displayed when the camera is turned on, the clock battery is exhausted and the clock has been reset. Set the clock to the correct time and date.



7 Check the battery level and memory card capacity.

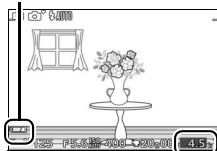

Check the battery level and number of exposures remaining in the monitor.

Battery level



Exposures remaining

■ ■ Battery Level

Display	Description
NO ICON	Battery fully charged or partially discharged; level shown by  or  icon in detailed display (□ 157).
	Low battery. Ready fully-charged battery or prepare to charge battery.
Cannot take pictures. Insert fully-charged battery.	Battery exhausted; shutter-release disabled. Insert charged battery.

■ ■ Number of Exposures Remaining

The monitor shows the number of pictures that can be stored on the memory card at current settings (values over 1000 are rounded down to the nearest hundred; e.g., values between 1200 and 1299 are shown as 1.2 k). If a warning is displayed stating that there is not enough memory for additional images, insert another memory card (□ 15) or delete some photos (□ 85).

Auto Mode

Shoot photographs and movies. The camera automatically adjusts settings to suit the subject.

Taking Photos in Auto Mode

1 Select mode.

Press the MENU button to display the menus and select  (auto) for **Shooting mode** (📖 8).



2 Ready the camera.

Hold the camera securely with both hands, being careful not to obstruct the lens, AF-assist illuminator, or microphone. Rotate the camera as shown at lower right when taking pictures in "tall" (portrait) orientation.

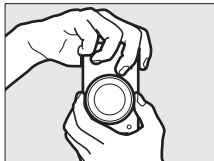
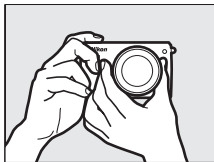

3 Frame the photograph.

Position your subject in the center of the frame.

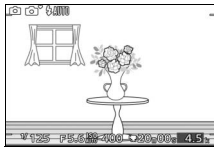

4 Focus.

Press the shutter-release button half-way to focus. If the subject is poorly lit, the flash may pop up (📖 72) and the AF-assist illuminator (📖 135) may light to assist the focus operation.



If the camera is able to focus, the selected focus area will be highlighted in green and a beep will sound (a beep may not sound if the subject is moving).

Focus area

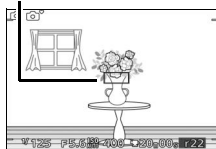

If the camera is unable to focus, the focus area will be displayed in red. See page 130.

5 Shoot.

Smoothly press the shutter-release button the rest of the way down to release the shutter and record the photograph. The memory card access lamp will light and the photograph will be displayed in the monitor for a few seconds (the photo will automatically clear from the display when the shutter-release button is pressed half-way). *Do not eject the memory card or remove or disconnect the power source until the lamp has gone out and recording is complete.*

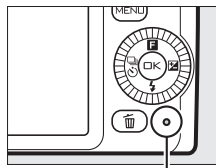

Memory card access lamp

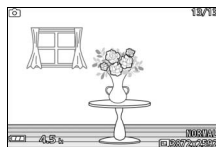

The Shutter-Release Button

The camera has a two-stage shutter-release button. The camera focuses when the shutter-release button is pressed halfway. To take the photograph, press the shutter-release button the rest of the way down.



Taking Several Photographs in Succession





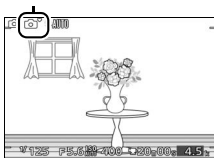

If **Off** is selected for **Image review** in the playback menu (📖 110), you can take additional photographs without refocusing by keeping the shutter-release button pressed halfway between shots.

Automatic Scene Selection

In auto mode, the camera automatically analyzes the subject and selects the appropriate scene. The selected scene is shown in the monitor.

Scene icon



- | | |
|---|---|
|  | Portrait: Human portrait subjects. |
|  | Landscape: Landscapes and cityscapes. |
|  | Night portrait: Portrait subjects framed against dark backgrounds. |
|  | Close up: Subjects close to the camera. |
|  | Night landscape: Poorly-lit landscapes and cityscapes. |
|  | Auto: Subjects that do not fall into the categories listed above. |



Using a Zoom Lens

Use the zoom ring to zoom in on the subject so that it fills a larger area of the frame, or zoom out to increase the area visible in the final photograph (select longer focal lengths on the lens focal length scale to zoom in, shorter focal lengths to zoom out).

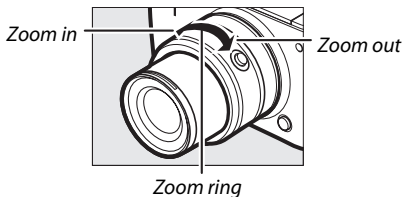

If you are using an optional lens with a power drive zoom switch, select **T** to zoom in and **W** to zoom out. The speed with which the camera zooms in and out varies with how far you slide the switch. The zoom position is shown by the zoom guide in the display.

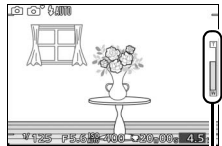

Zoom guide

Face Priority

The camera detects and focuses on portrait subjects (face priority). A double yellow border will be displayed if a portrait subject is detected facing the camera (if multiple faces, up to a maximum of five, are detected, the camera will select the closest subject). Press the shutter-release button halfway to focus on the subject in the double yellow border. The border will clear from the display if the camera can no longer detect the subject (because, for example, the subject has looked away).



Available Settings

For information on the options available in auto mode, see page 174.

See Also

See page 158 for information on silencing the beep that sounds when the camera focuses or the shutter is released.

Live Image Control

Live image controls let you preview how changes to each control will affect the final photograph. To choose a live image control for auto mode, press ▲ (F), use the multi selector to highlight a control, and press ○ (OK) to view the effect.

Rotate the multi selector to choose a setting and press ○ (OK) to select. To cancel live image controls, press ▲ (F) again.

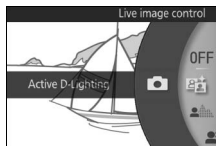
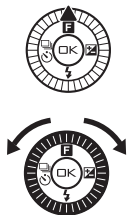

Active D-Lighting: Preserve details in highlights and shadows for natural contrast.



Active D-Lighting: High *Active D-Lighting: Low*

Background softening: Soften background details to make your subject stand out, or bring both background and foreground into focus.



Background sharp

Background softened

Increase effect

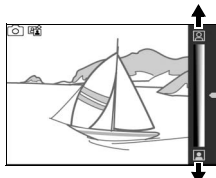

Reduce effect

Sharpen background

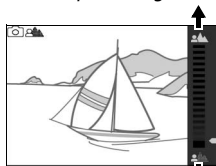

Soften background



Motion control: Suggest motion by blurring moving objects, or “freeze” motion to capture moving objects clearly.



Freeze motion

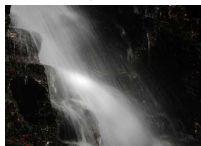

Blur motion

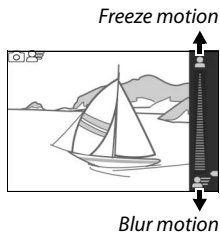

Brightness control: Make pictures brighter or darker.



Brighter



Darker

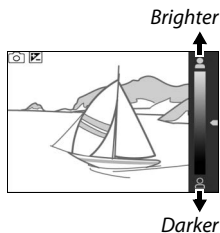

Live Image Control

Continuous shooting is not available (📖 67) and the built-in flash can not be used when live image control is in effect. Pressing the movie-record button cancels live image control.

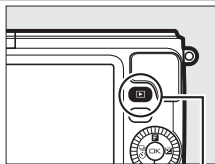

Viewing Photographs

Press  to display your most recent photograph full frame in the monitor (full-frame playback).

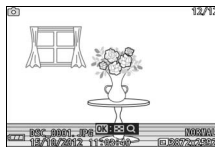

▶ button



Press  or  or rotate the multi selector to view additional pictures.



To end playback and return to shooting mode, press the shutter-release button halfway.

See Also

For information on toggling photo info on or off, see page 158. See page 82 for information on viewing multiple images. For information on zooming in on the center of the current image, see page 84. See page 87 for information on slide shows.

Deleting Pictures

To delete the current picture, press . Note that once deleted, pictures can not be recovered.

1 Display the photograph.

Display the photograph you wish to delete as described on the preceding page.

2 Press .

A confirmation dialog will be displayed.

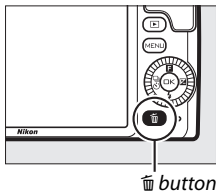

3 Delete the photograph.

Press again to delete the picture and return to playback, or press to exit without deleting the picture.

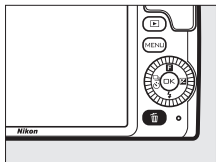

Deleting Multiple Pictures

The **Delete** option in the playback menu (85) can be used to delete all or selected pictures.

Recording Movies in Auto Mode

In auto mode, the movie-record button can be used to shoot HD movies with sound at an aspect ratio of 16 : 9 (the movie crop is shown in the display). Press the movie-record button to start and stop recording.

Taking Photographs During Recording

Photographs with an aspect ratio of 16 : 9 can be taken at any time during recording by pressing the shutter-release button all the way down. Movie recording is not interrupted.

See Also

See page 65 for information on viewing movies.

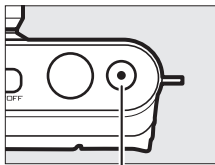

Movie-record button

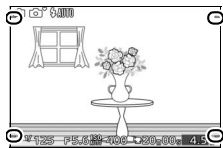



Creative Mode

Choose creative mode when to take photos using special effects, match settings to the scene, or control shutter speed and aperture.

Choosing a Creative Mode

1 Select mode.

Press the MENU button to display the menus and select  (creative mode) for **Shooting mode** (📖 8).



2 Choose a scene.

Press  (**F**) and highlight a scene using the multi selector (📖 34).

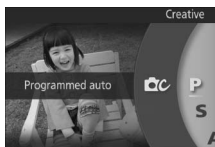

Press  to select the highlighted scene. Your selection is indicated by an icon in the display.

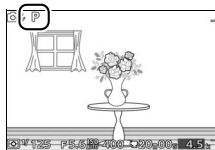

Choosing a Scene

Creative mode offers a choice of the following scenes:

Option	Description
Programmed auto (P)	The camera sets shutter speed and aperture for optimal exposure (☞ 36). Recommended for snapshots and in other situations in which there is little time to adjust camera settings.
Shutter-priority auto (S)	You choose the shutter speed; the camera selects an aperture for best results (☞ 37). Use to freeze or blur motion.
Aperture-priority auto (A)	You choose the aperture; the camera selects a shutter speed for best results (☞ 38). Use to blur the background or bring both foreground and background into focus.
Manual (M)	You control both shutter speed and aperture (☞ 39). Choose a shutter speed of "Bulb" for long time-exposures (☞ 40).
Night landscape (📷)	Each time the shutter-release button is fully pressed, the camera takes a series of shots and combines them to capture low lighting in night scenes; during processing, a message is displayed and no pictures can be taken. The flash does not fire and the edges of photos are cropped out. Note that the desired results may not be obtained if the camera or subject moves during shooting; if the camera is unable to combine the images, a warning will be displayed and only one picture will be taken.





Option	Description
Night portrait (📷)	Each time the shutter-release button is fully pressed, the camera takes a series of shots, some with the flash and some without, and combines them to capture background lighting in portraits taken at night or under low light; during processing, a message is displayed and no pictures can be taken. Note that the edges of photos are cropped out and that the desired results may not be obtained if the camera or subject moves during shooting; if the camera is unable to combine the images, a warning will be displayed and the camera will take a single picture using the flash.
Backlighting (📷)	Photograph backlit subjects (📖 42).
Soft (📷)	Shoot photographs with a soft filter effect. To choose the amount of softening, press OK when the view through the lens is displayed, highlight an option using the multi selector, and press OK to select. <div data-bbox="650 535 930 722" style="float: right; border: 1px solid black; padding: 5px;"> </div>
Miniature effect (📷)	The top and bottom of each photo is blurred so that the subject appears to have been a diorama photographed at short range. Works best when shooting from a high vantage point.
Selective color (🖌️)	Take photos in which only a selected hue appears in color. To choose the hue, press OK when the view through the lens is displayed and use the multi selector and OK button. <div data-bbox="650 936 930 1122" style="float: right; border: 1px solid black; padding: 5px;"> </div>

🔧 Available Settings

For information on the options available in creative mode, see page 176.

Taking Photos in P, S, A, and M Modes

P, S, A, and M modes offer varying degrees of control over shutter speed and aperture. Choose a mode and adjust settings according to your creative intent.

P Programmed Auto

In this mode, the camera automatically adjusts shutter speed and aperture for optimal exposure in most situations. This mode is recommended for snapshots and other situations in which you want to leave the camera in charge of shutter speed and aperture.



Choosing a Combination of Shutter Speed and Aperture

Although the shutter speed and aperture chosen by the camera will produce optimal results, you can also choose from other combinations that will produce the same exposure (“flexible program”). Rotate the multi selector clockwise for large apertures (low f-numbers) that blur background details or fast shutter speeds that “freeze” motion. Rotate the multi selector counterclockwise for small apertures (high f-numbers) that increase depth of field or slow shutter speeds that blur motion. * is displayed while flexible program is in effect.

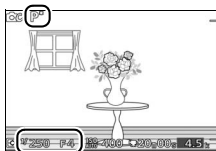

Restoring Default Shutter Speed and Aperture Settings

To restore default shutter speed and aperture settings, rotate the multi selector until * is no longer displayed or turn the camera off. The default shutter speed and aperture is automatically restored when the camera enters standby mode.

S Shutter-Priority Auto

In shutter-priority auto, you choose the shutter speed while the camera automatically selects the aperture that will produce the optimal exposure. Use slow shutter speeds to suggest motion by blurring moving subjects, fast shutter speeds to “freeze” motion.



Fast shutter speed ($1/1600$ s)

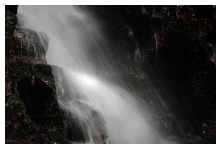

Slow shutter speed (1 s)



■ ■ Choosing a Shutter Speed

Rotate the multi selector to choose from shutter speeds between 30 s and $1/16,000$ s. Rotate the selector clockwise for faster shutter speeds, counterclockwise for slower shutter speeds.



Continuous Shooting

The selected shutter speed may change when continuous shooting ( 67) is in effect.

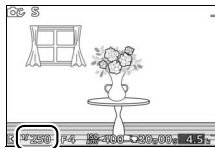

A Aperture-Priority Auto

In aperture-priority auto, you choose the aperture while the camera automatically selects the shutter speed that will produce the optimal exposure. Large apertures (low f-numbers) reduce depth of field, blurring objects behind and in front of the main subject. Small apertures (high f-numbers) increase depth of field, bringing out details in the background and foreground. Short field depths are generally used in portraits to blur background details, long field depths in landscape photographs to bring the foreground and background into focus.



Large aperture (f/5.6)



Small aperture (f/16)

■ ■ Choosing an Aperture

Rotate the multi selector counterclockwise for larger apertures (lower f-numbers), clockwise for smaller apertures (higher f-numbers). The minimum and maximum values depend on the lens currently in use.

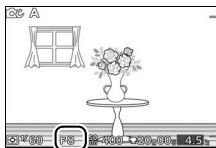

M Manual

In manual mode, you control both shutter speed and aperture.

■ Choosing Shutter Speed and Aperture

Adjust shutter speed and aperture with reference to the exposure indicator (see below). Press **▶** to highlight shutter speed or aperture and rotate the multi-selector to choose a value, then repeat for the remaining item. Rotate the selector clockwise for faster shutter speeds or smaller apertures (higher f-numbers), counterclockwise for slower shutter speeds and larger apertures (lower f-numbers). Shutter speeds can be set to values as fast as $\frac{1}{16,000}$ s or as slow as 30 s, or to “Bulb” to hold the shutter open indefinitely for a long time-exposure (☞ 40). Aperture can be set to values between the minimum and maximum for the lens.

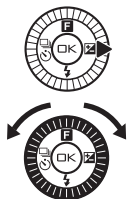

Shutter speed

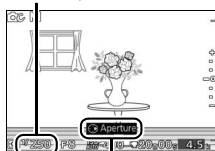

Press **▶** to highlight aperture.

Aperture

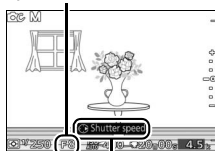

Press **▶** to highlight shutter speed.

Continuous Shooting

The selected shutter speed may change when continuous shooting (☞ 67) is in effect.



The Exposure Indicator

When shutter speeds other than “Bulb” are selected, the exposure indicator shows whether the photograph would be under- or over-exposed at current settings.

Optimal exposure	Underexposed by $\frac{1}{3}$ EV	Overexposed by over 2 EV
+ · · -o · · -	+ · · =o · · -	+ · · · · · · o · · · -



■ Long Time-Exposures (M Mode Only)

Select a shutter speed of “Bulb” for long time-exposures of moving lights, the stars, night scenery, or fireworks. The shutter remains open while the shutter-release button is held down. To prevent blur, use a tripod.



1 Ready the camera.

Mount the camera on a tripod or place it on a stable, level surface. To prevent loss of power before the exposure is complete, use a fully charged EN-EL20 battery or an optional EH-5b AC adapter and EP-5C power connector. Note that noise (bright spots, randomly-spaced bright pixels, or fog) may be present in long exposures; before shooting, choose **On** for **Long exposure NR** in the shooting menu (📖 127).

2 Choose a shutter speed of “Bulb”.

Press ► to highlight shutter speed and rotate the multi selector counterclockwise to select “Bulb”.

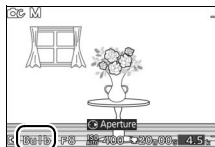

3 Open the shutter.

After focusing, press the shutter-release button all the way down. Keep the shutter-release button pressed until the exposure is complete.

4 Close the shutter.

Take your finger off the shutter-release button.

Shooting ends automatically after about two minutes. Note that some time may be required to record long exposures.



Backlighting

The method used to capture details in shaded areas of back-lit subjects depends on the option selected for **HDR** in the shooting menu (☞ 117).

On

Details in highlights and shadows are preserved using HDR (high dynamic range); **HDR** appears in the display. Each time the shutter-release button is fully pressed, the camera takes two shots in quick succession and combines them to preserve details in highlights and shadows in high-contrast scenes; the built-in flash does not fire. While the shots are combined, a message will be displayed and the shutter release will be disabled. The final photograph will be displayed when processing is complete.



*First exposure
(darker)*

+



*Second exposure
(brighter)*



*Combined HDR
image*

Off

The flash fires to “fill in” (illuminate) shadows in back-lit subjects. Only one shot is taken when the shutter-release button is fully pressed, and the flash fires with each shot.

Framing HDR Photographs

The edges of the image will be cropped out. The desired results may not be achieved if the camera or subject moves during shooting. Depending on the scene, shading may be uneven and shadows may appear around bright objects or halos around dark objects. If the camera is unable to successfully combine the two images, a single image will be recorded at normal exposure and Active D-Lighting (☞ 126) will be applied.

Recording Movies in Creative Mode

In creative mode, the movie-record button can be used to shoot HD movies with sound at an aspect ratio of 16 : 9 (the corners of the movie crop are shown in the display). Press the movie-record button to start and stop recording. Note that regardless of the mode selected, movies are recorded using programmed auto exposure; to adjust exposure when shooting movies, select advanced movie mode (📖 57).

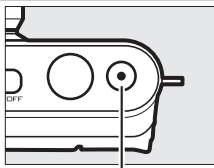

Movie-record button

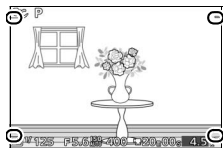

Movie crop

🔍 Taking Photographs During Recording

Photographs with an aspect ratio of 16 : 9 can be taken at any time during recording by pressing the shutter-release button all the way down. Movie recording is not interrupted.

🔍 See Also

See page 65 for information on viewing movies.





Best Moment Capture Mode

This mode is ideal for fast-changing, hard-to-capture subjects. Choose when to release the shutter as the scene plays back in slow motion (slow view), or let the camera choose the best shot based on composition and motion (Smart Photo Selector; [book 47](#)).

Slow View

In this mode, the camera captures a short sequence of still images and plays them back in slow motion so that you can choose the precise moment for a photograph. While the shutter-release button is pressed halfway, the camera records up to 15 frames over about 1 s and plays them back in a continuous slow-motion loop. When the frame you want to keep is displayed, press the shutter-release button the rest of the way down to record the current frame and discard the remaining images. To use slow view, select **Slow view** from the **▲ (F)** button menu in best moment capture mode.

1 Select mode.

Press the MENU button to display the menus and select  (best moment capture) for **Shooting mode** ([book 8](#)). If **Smart Photo Selector** is selected, choose **Slow view**.

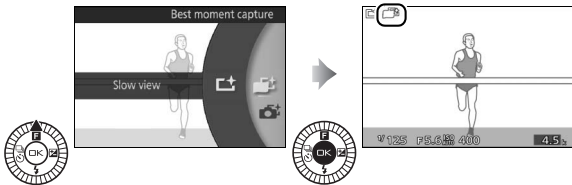
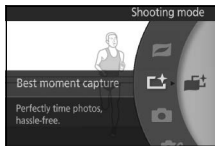

2 Frame the photograph.

Compose the photograph with your subject in the center of the frame.

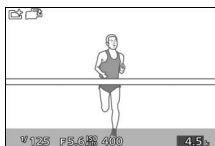

3 Press the shutter-release button halfway.

The camera will focus (📖 24) and then, over a span of about 1 s, record 15 frames to a temporary memory buffer.



4 View the buffer contents.

Keep the shutter-release button pressed halfway to play the frames in the buffer back in a continuous loop about 5 s long. The position of the current frame is shown by a progress indicator.

Progress indicator

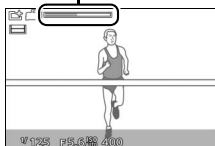

5 Record the desired frame.

Press the shutter-release button all the way down to record the current frame and discard the remaining images; the selected frame will be displayed for a few seconds when recording is complete. To exit without recording a photograph, release the button without pressing it all the way down.

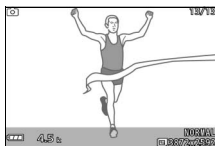

Viewing and Deleting Photos Taken in Slow View

Photos taken in slow view can be viewed as described on page 29 or deleted as described on page 30.

Smart Photo Selector

Choose Smart Photo Selector mode to let the camera help you take photos that capture a fleeting expression on the face of a portrait subject or other hard-to-time shots such as group photos in party scenes. Each time the shutter is released, the camera automatically selects the best shot and a number of best shot candidates based on composition and motion. To use the Smart Photo Selector, select **Smart Photo Selector** from the ▲ (F) button menu in best moment capture mode.

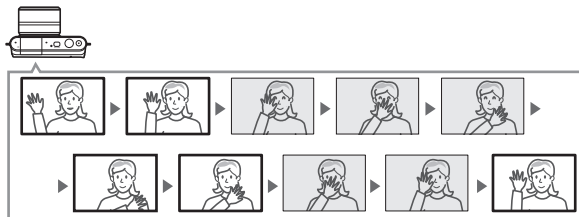

1 Select mode.

Press the MENU button to display the menus and select  (best moment capture) for **Shooting mode** (8). If **Slow view** is selected, choose **Smart Photo Selector**.

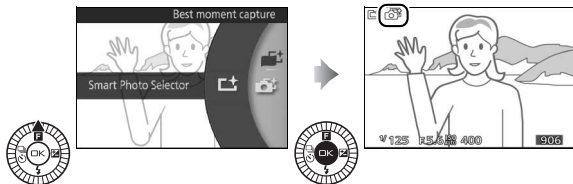
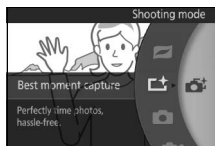

2 Frame the photograph.

Compose the photograph with your subject in the center of the frame.



3 Begin buffering photographs.

Press the shutter-release button half-way to focus (□ 24). An icon will be displayed as the camera begins recording images to the memory buffer. The camera continuously adjusts focus to account for changes in the distance to the subject while the shutter-release button is pressed halfway.



4 Shoot.

Smoothly press the shutter-release button the rest of the way down. The camera will compare shots recorded to the buffer both before and after the shutter-release button was pressed all the way down, and select five to copy to the memory card. Note that some time may be required. The best picture is displayed in the monitor when recording is complete.



Buffering

Buffering begins when the shutter-release button is pressed halfway and ends after about 90 seconds or when the shutter-release button is pressed all the way down.

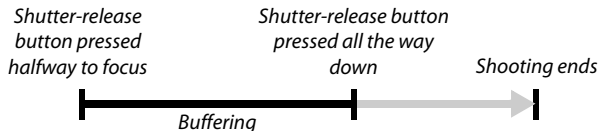

Smart Photo Selector Files

Do not delete the "NCSPSLST.LST" file from the "NCFL" folder on the memory card or change the file names of images taken with the Smart Photo Selector. The camera will no longer recognize the affected files as Smart Photo Selector images and will instead handle them as independent photographs.

Available Settings

For information on the options available in best moment capture mode, see page 174.

Best Moment Capture Mode



The camera automatically chooses a scene mode appropriate to the subject. Movies can not be recorded, and pressing the movie-record button has no effect. The flash can not be used.

See Also

Use the **Number of shots saved** option in the shooting menu to choose the number of shots selected by the Smart Photo Selector (📖 122).



Viewing Photos Taken with the Smart Photo Selector



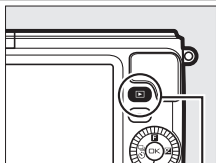

Press  and use the multi selector to display photographs taken with the Smart Photo Selector (📖 29; pictures taken with the Smart Photo Selector are indicated by a  icon). Of the photographs recorded by the Smart Photo Selector, only the best shot will be displayed (when you press the multi selector right to view the next picture, the camera will skip over the best shot candidates, with the result that the next picture displayed will not have a file number that immediately follows that of the current picture). To end playback and return to shooting mode, press the shutter-release button halfway.



 button





Choosing the Best Shot

When a photograph taken with the Smart Photo Selector is displayed, you can choose the best shot by pressing . Press  or  to view the other pictures in the sequence and press  to select the current picture as the best shot. To return to normal playback, press .



Deleting Pictures

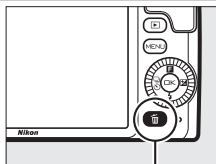

Pressing  when a picture taken with the Smart Photo Selector is selected displays a confirmation dialog; press  again to delete the best shot and the best shot candidates, or press  to exit without deleting the pictures. *Note that once deleted, pictures can not be recovered.*

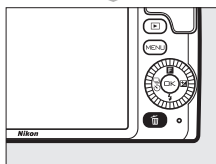

 button



Deleting Individual Photographs

Pressing the  button in the best shot selection dialog displays the following options; highlight an option using the multi selector and press  to select.

- **This image:** Delete the current photo (note that the picture currently selected as the best shot can not be deleted).
- **All except best shot:** Delete the best shot candidates, but not picture currently selected as the best shot.

A confirmation dialog will be displayed; to delete the selected image or images, highlight **Yes** and press .

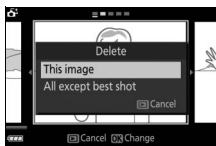



Motion Snapshot Mode

Record brief movie vignettes with your photographs. Each time the shutter is released, the camera records a still image and about 1.6 s of movie footage. When the resulting “Motion Snapshot” is viewed on the camera, the movie will play back in slow motion over approximately 4 s, followed by the still image; playback is accompanied by a background track about 10 s long.

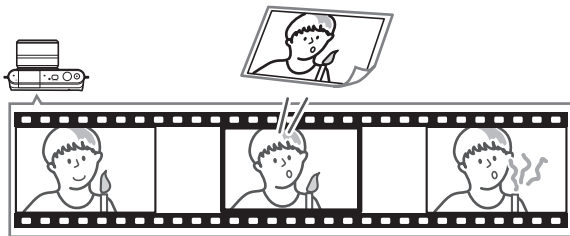

Shooting in Motion Snapshot Mode

1 Select mode.

Press the MENU button to display the menus and select  (Motion Snapshot mode) for **Shooting mode** (📖 8).

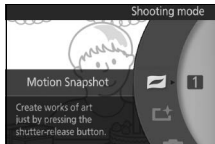

2 Frame the picture.

Compose the photograph with your subject in the center of the frame.



Available Settings

For information on the options available in Motion Snapshot mode, see page 174.

3 Begin buffering.

Press the shutter-release button half-way to focus (📖 24). An icon will be displayed as the camera begins recording footage to the memory buffer.



4 Shoot.

Smoothly press the shutter-release button the rest of the way down. The camera will record a photograph, together with about 1.6 s of movie footage beginning before and ending after the time the shutter-release button was pressed all the way down. Note that some time may be required. When recording is complete, the photograph will be displayed for a few seconds.



Buffering

Buffering begins when the shutter-release button is pressed halfway and ends after about 90 seconds or when the shutter-release button is pressed all the way down.

*Shutter-release
button pressed
halfway to focus*

*Shutter-release button
pressed all the way
down*

Shooting ends



■ ■ Choosing a Theme

To choose the background music for the movie, press ▲ (F) and use the multi selector and OK button to select from **Beauty, Waves, Relaxation, and Tenderness.**

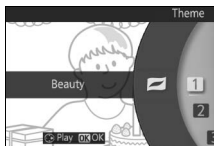

To play the background music for the highlighted theme, press ► and rotate the multi selector to adjust volume.



🔍 Motion Snapshot Mode





Live audio is not recorded. Movies can not be recorded using the movie-record button and the flash can not be used.

🔍 See Also

See page 122 for information on choosing what portions of the buffer are included in the movie footage. For information on saving Motion Snapshots in a format that can be viewed in most movie playback software, see page 123.



Viewing Motion Snapshots

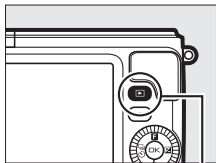

Press  and use the multi selector to display a Motion Snapshot ( 29; Motion Snapshots are indicated by a  icon). Pressing  when a Motion Snapshot is displayed plays back the movie portion in slow motion over a period of about 4 s, followed by the photo; the background track plays for about 10 s (to choose a new background track, use the **Change theme** option in the playback menu;  115). To end playback and return to shooting mode, press the shutter-release button halfway.



 button



Deleting Motion Snapshots

To delete the current Motion Snapshot, press . A confirmation dialog will be displayed; press  again to delete the photo and movie and return to playback, or press  to exit without deleting the file. *Note that once deleted, Motion Snapshots can not be recovered.*

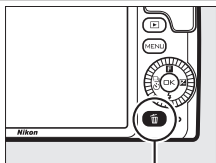

 button

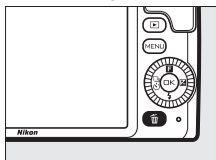
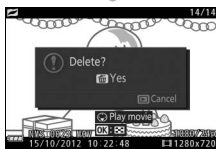

Recording and Viewing Movies

The camera can record high-definition (HD) movies with an aspect ratio of 16 : 9 and slow-motion movies with an aspect ratio of 8 : 3. Movies can be recorded by pressing the movie-record button in the following shooting modes:

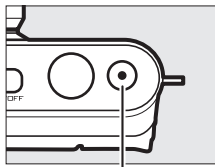

Movie-record button

Mode	Movie type	Description
Auto mode (□ 31)		The camera automatically optimizes settings for the current subject or scene.
Creative mode (□ 43)		Shoot movies. Regardless of the scene selected with the camera, movies are recorded in mode P ; shutter speed and aperture are controlled by the camera.
Advanced movie mode (□ 58, 62)	Programmed auto (P)	HD (16 : 9) Shutter speed and aperture are controlled by the camera.
	Shutter-priority auto (S)	You choose the shutter speed; the camera automatically adjusts aperture for optimal exposure (□ 37).
	Aperture-priority auto (A)	You choose the aperture; the camera automatically adjusts shutter speed for optimal exposure (□ 38).
	Manual (M)	You choose the shutter speed and aperture (□ 39).
	Slow motion (●●●)	Slow motion (8 : 3) Record silent slow-motion movies. Movies are recorded at 400 fps and play back at about 30 fps (□ 62).

Available Settings

For information on the options available in advanced movie mode, see page 174.



Recording HD Movies

Record movies with sound at an aspect ratio of 16 : 9.

1 Choose a shooting mode.

Press the MENU button to display the menus (7) and choose an option for **Shooting mode** that supports HD movie recording (57).

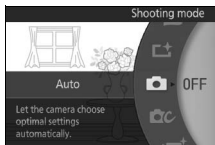

For greater control of exposure, select **+** (advanced movie mode), press **▲** (**F**), and choose from **P Programmed auto**, **S Shutter-priority auto**, **A Aperture-priority auto**, and **M Manual** (57).

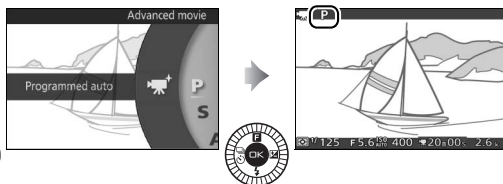

2 Frame the opening shot.

Frame the opening shot with your subject in the center of the display.

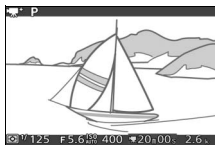

The Icon

A  icon indicates that movies can not be recorded.

3 Start recording.

Press the movie-record button to begin recording. A recording indicator, the time elapsed, and the time available are displayed while recording is in progress.

Audio Recording

Be careful not to cover the microphone and note that the built-in microphone may record sounds made by the camera or lens. By default, the camera focuses continuously; to avoid recording focus noise, select **Single AF** for **Focus mode** in the movie menu (□ 128). The **Movie sound options** item in the movie menu offers microphone sensitivity and wind noise options (□ 140).

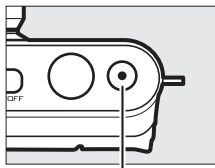

Movie-record button

*Recording indicator/
Time elapsed*



Time available

4 End recording.

Press the movie-record button again to end recording. Recording will end automatically when the maximum length is reached (□ 139), the memory card is full, the lens is removed, or the camera becomes hot (□ xvi).

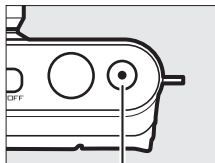

Movie-record button

Maximum Length

At default settings, HD movies can be up to 4 GB in size and 20 minutes in length (for more information, see page 139); note that depending on memory card write speed, shooting may end before this length is reached (□ 165).



The Movie Crop

The movie crop is shown in the monitor.

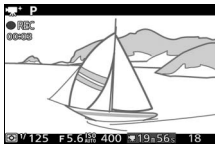

HD crop (16:9)



*Slow-motion movie crop
(8:3)*

Focus Lock

If **Single AF** is selected for **Focus mode** in the movie menu for advanced movie mode, focus will lock while the shutter-release button is pressed halfway ( 134).



■ Taking Photographs During HD Movie Recording

Press the shutter-release button all the way down to take a photograph without interrupting HD movie recording. Photographs taken during movie recording have an aspect ratio of 16 : 9.

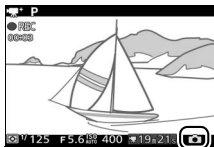

🔍 Taking Photographs During Movie Recording

Up to 18 photographs can be taken with each movie shot. Please note that photographs can not be taken with slow-motion movies.

🔍 Recording Movies



Flicker, banding, or distortion may be visible in the display and in the final movie under fluorescent, mercury vapor, or sodium lamps or if the camera is panned horizontally or an object moves at high speed through frame (flicker and banding can be reduced in HD movies by choosing a **Flicker reduction** option that matches the frequency of the local AC power supply as described on page 159, but note that the slowest shutter speed available is $\frac{1}{100}$ s at **50 Hz**, $\frac{1}{60}$ s at **60 Hz**; flicker reduction is not available with slow-motion movies). Bright light sources may leave after-images when the camera is panned. Jagged edges, color fringing, moiré, and bright spots may also appear. When recording movies, avoid pointing the camera at the sun or other strong light sources. Failure to observe this precaution could result in damage to the camera's internal circuitry.

🔍 See Also



Frame size and frame rate options are described on page 139.



Recording Slow-Motion Movies

Silent slow-motion movies with an aspect ratio of 8 : 3 can be recorded by selecting  **Slow motion** from the  (F) button menu in advanced movie mode. Slow-motion movies are recorded at 400 fps and play back at about 30 fps.

1 Select mode.

Press the MENU button to display the menus and select  (advanced movie mode) for **Shooting mode** (□ 8). If an option other than  **Slow motion** is selected, choose  **Slow motion**.

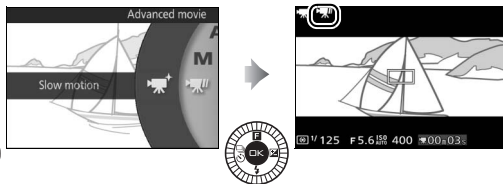
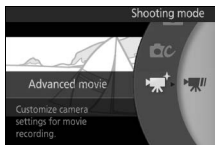

2 Frame the opening shot.

Frame the opening shot with your subject in the center of the display.



3 Focus.



Focus area

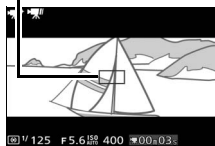

4 Start recording.

Press the movie-record button to begin recording. A recording indicator, the time elapsed, and the time available are displayed while recording is in progress. The camera focuses on the subject at the center of the display; face detection (26) is not available and focus and exposure can not be adjusted.

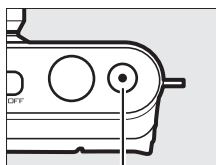

Movie-record button

*Recording indicator/
Time elapsed*

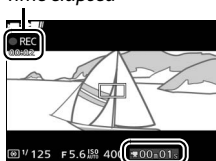

Time available



5 End recording.

Press the movie-record button again to end recording. Recording will end automatically when the maximum length is reached, the memory card is full, the lens is removed, or the camera becomes hot (📖 xvi).

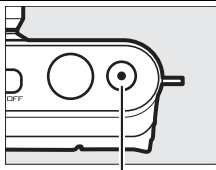

Movie-record button

Maximum Length



Up to 2.5 seconds of footage can be recorded; note that depending on memory card write speed, shooting may end before this length is reached (📖 165).

See Also

Frame rate options are described on page 138.



Viewing Movies

Movies are indicated by a  icon in full-frame playback (29). Press  to start playback.



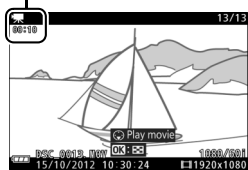



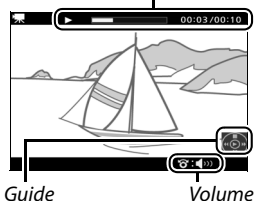



 icon/Length



Movie playback indicator/
Current position/total length





The following operations can be performed:

To	Use	Description
Pause		Pause playback.
Play		Resume playback when the movie is paused or during rewind/advance.
Advance/ rewind		Press  to rewind,  to advance. Speed increases with each press, from 2x to 4x to 8x to 16x. If playback is paused, the movie rewinds or advances one frame at a time; keep the button pressed for continuous rewind or advance.
Adjust volume		Rotate the multi selector to adjust volume.
Return to full-frame playback	 / 	Press  or  to exit to full-frame playback.



Deleting Movies

To delete the current movie, press . A confirmation dialog will be displayed; press  again to delete the movie and return to playback, or press  to exit without deleting the movie. *Note that once deleted, movies can not be recovered.*

See Also

See page 114 for information on trimming unwanted footage from movies.

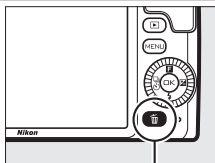

 button

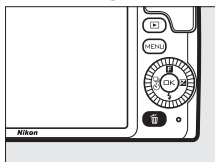



More on Photography

Single-Frame, Continuous, and Self-Timer Modes

Pressing ◀ (S) on the multi selector displays a choice of shutter-release modes for still photography:

[S]	The camera takes pictures one at a time.
5 fps	Continuous: The camera records photographs at about 5, 15, 30, or 60 fps while the shutter-release button is pressed all the way down.
15 fps	
30 fps	
60 fps	
⌚ 10 s	The shutter is released about 10, 5, or 2 seconds after the shutter-release button is pressed all the way down. Choose 10 s or 5 s for self-portraits, 2 s to reduce camera shake.
⌚ 5 s	
⌚ 2 s	

Continuous Mode

To take pictures in continuous mode:

1 Display release mode options.

Press ◀ (S) to display release mode options.



2 Select a frame rate.

Highlight **5 fps**, **15 fps**, **30 fps**, or **60 fps** and press OK.

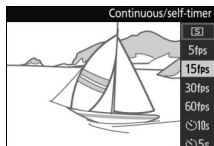

3 Compose the shot and start shooting.

The camera takes pictures while the shutter-release button is held all the way down.



✔ Continuous Mode

The maximum number of shots that can be taken in a single burst varies with the release mode. At frame rates of 30 and 60 fps, the maximum number of shots that can be taken in a single burst is 15.

The built-in flash can be used when **5 fps** is selected, but only one picture will be taken each time the shutter-release button is pressed; at settings of 15, 30, and 60 fps, the built-in flash will not fire.

While photographs are being recorded to the memory card, the memory card access lamp will light. Depending on shooting conditions and memory card write speed, recording may take some time. If the battery is exhausted before all photographs are recorded, the shutter release will be disabled and the remaining images transferred to the memory card.

Continuous shooting is not available in creative modes other than **P**, **S**, **A**, or **M**, in best moment capture, advanced movie, or Motion Snapshot mode, or when live image control is used in auto mode (□ 27).

✍ Buffer Size

The camera is equipped with a memory buffer for temporary storage, allowing shooting to continue while photographs are being saved to the memory card. Note that the frame rate will drop or shooting will pause when the buffer is full. The approximate number of images that can be stored in the memory buffer at current settings is displayed while the shutter-release button is pressed halfway (this number is an approximation only and varies with shooting conditions; □ 179). The illustration shows the display when space remains in the buffer for about 22 pictures.

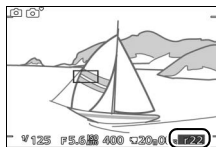

Self-Timer Modes

The self-timer can be used to reduce camera shake or for self-portraits.

1 Display release mode options.

Press ◀ (📷) to display release mode options.



2 Select the desired self-timer option.

Use the multi selector to highlight 10 s, 5 s, or 2 s and press (OK).

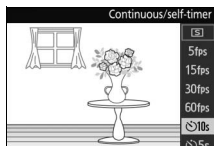

3 Mount the camera on a tripod.

Mount the camera on a tripod or place the camera on a stable, level surface.

4 Frame the photograph and shoot.

Press the shutter-release button half-way to focus, and then press the button the rest of the way down. The self-timer lamp will start to flash and a beep will begin to sound. Two seconds before the photo is taken, the lamp will stop flashing and the beeping will become more rapid.



Note that the timer may not start or a photograph may not be taken if the camera is unable to focus or in other situations in which the shutter can not be released. Turning the camera off cancels the self-timer.

 **Movie Mode**

In self-timer mode, start and stop the timer by pressing the movie-record button instead of the shutter-release button.

 **Raising the Flash**

In **P**, **S**, **A**, or **M** mode, press the flash pop-up button to raise the flash before shooting. Shooting will be interrupted if the flash is raised while the timer is counting down.

 **See Also**

For information on controlling the beeps that sound when the self-timer is used, see page 158.



Exposure Compensation

Exposure compensation is used to alter exposure from the value suggested by the camera, making pictures brighter or darker.



-1 EV



No compensation



+1 EV

1 Display exposure compensation options.

Press **▶** (**☒**) to display exposure compensation options.



2 Choose a value.

Use the multi selector to choose from values between -3 EV (underexposure) and +3 EV (overexposure) in increments of $\frac{1}{3}$ EV. In general, positive values make the image brighter while negative values make it darker.

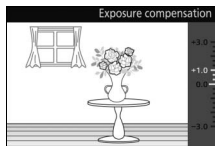

Normal exposure can be restored by setting exposure compensation to ± 0 . In modes **P**, **S**, and **A**, exposure compensation is not reset when the camera is turned off.

Exposure Compensation

Exposure compensation is most effective when used with center-weighted or spot metering (**☐** 123).

The Built-in Flash



When used with the built-in flash, exposure compensation affects both background exposure and flash level.



The Built-in Flash

Use the built-in flash for additional lighting when the subject is poorly lit or to “fill-in” (illuminate) back-lit subjects. The camera offers a choice of flash modes; choose a mode according to lighting conditions and your creative intent. The built-in flash is available in the following shooting modes:

■ Auto Pop-up Modes

In  (auto) and in night portrait, backlighting, soft, miniature effect, and selective color  (creative) modes, the flash will pop-up automatically and fire when required.

1 Choose a flash mode (📖 73).

2 Take pictures.

The flash will pop up and fire as required. In night portrait (📖 35) and (if HDR is off) in backlighting (📖 42) mode, the flash will pop up and fire with every shot.

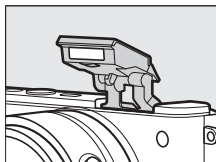

■ Manual Pop-up Modes

When **P**, **S**, **A**, or **M** is selected in  (creative) mode, the flash must be raised manually. The flash will not fire if it is not raised.

1 Raise the flash.

Press the flash pop-up button to raise the flash.

2 Choose a flash mode (📖 73).

3 Take pictures.

The flash will fire with every shot. To disable the flash, press it gently downward until it latches (📖 75).

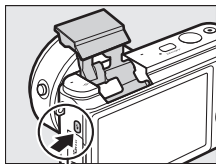

Flash pop-up button

Choosing a Flash Mode

The options available vary with the shooting mode.

Auto, Soft (Q), Miniature effect (M), Selective color (S)

⚡ AUTO	Auto
⚡ AUTO	Auto+red-eye reduction
⊖	Off ¹

Night portrait (N), Backlighting (B)

⚡	Fill flash
⚡ EYE	Red-eye reduction

S, M

⚡	Fill flash
⚡ EYE	Red-eye reduction
⚡ REAR	Rear-curtain sync
⊖	Off ²

1 Select to disable built-in flash.

2 Available only when built-in flash is raised.

P, A

⚡	Fill flash
⚡ EYE	Red-eye reduction
⚡ EYE SLOW	Red-eye reduction + slow sync
⚡ SLOW	Fill flash + slow sync
⚡ SLOW REAR	Rear curtain + slow sync
⊖	Off ²



To choose a flash mode:

1 Display flash modes.

Press ▼ (⚡) on the multi selector to display a list of the available flash modes.



2 Select a flash mode.

Use the multi selector to highlight a flash mode and press OK to select.

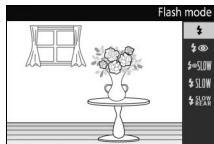

Charging begins when the flash is raised; once charging is complete, a flash-ready indicator (⚡) will be displayed when the shutter-release button is pressed halfway.

✓ Raising the Flash

When using the flash, be sure it is fully raised as shown at right. Do not touch the flash during shooting.

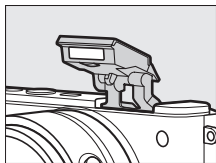

✎ Flash Modes

The flash modes listed on the previous page may combine one or more of the following settings, as shown by the flash mode icon:

- **AUTO (auto flash):** When lighting is poor or subject is backlit, flash pops up automatically when shutter-release button is pressed halfway and fires as required.
- **☉ (red-eye reduction):** Use for portraits. Red-eye reduction lamp lights before flash fires, reducing "red-eye."
- **⊗ (off):** Flash does not fire even when lighting is poor or subject is backlit.
- **SLOW (slow sync):** Shutter speed slows automatically to capture background lighting at night or under low light. Use to include background lighting in portraits.
- **REAR (rear-curtain sync):** Flash fires just before shutter closes, creating a stream of light behind moving light sources (below at right). If this icon is not displayed, flash will fire as the shutter opens (front-curtain sync; the effect this produces with moving light sources is shown below at left).



Front-curtain sync



Rear-curtain sync

Lowering the Built-in Flash

To save power when the flash is not in use, press it gently downward until the latch clicks into place. *Do not use force.* Failure to observe this precaution could result in product malfunction.

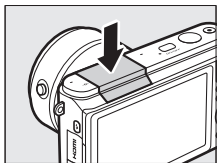

Using the Built-in Flash

The built-in flash can not be used with live image control (📖 27) and will not fire during continuous shooting at frame advance rates faster than 5 fps (📖 67) or when **On** is selected for **HDR** in the shooting menu (📖 42). If the flash is fired multiple times in quick succession, the flash and shutter may be temporarily disabled to protect the flash. Shooting can be resumed after a brief pause.

Objects close to the camera may be overexposed in photographs taken with the flash at high ISO sensitivities.

To avoid vignetting, remove lens hoods and shoot at ranges of at least 0.6 m (2 ft). Some lenses may cause vignetting at greater distances or obstruct the red-eye reduction lamp, interfering with red-eye reduction. The following illustrations show the effect of vignetting caused by shadows cast by the lens when the built-in flash is used.

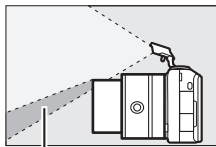

Shadow



Shadow

Aperture, Sensitivity, and Flash Range

Flash range varies with sensitivity (ISO equivalency) and aperture. With the standard zoom lens at maximum aperture and ISO sensitivity set to ISO 100 to 6400, the range is approximately 0.6 m–7.0 m (2 ft–23 ft) when the lens is zoomed all the way out, 0.6 m–4.2 m (2 ft–13.8 ft) at maximum zoom.

See Also

See page 136 for information on adjusting flash level.



The WU-1b Wireless Mobile Adapter

Attach an optional WU-1b wireless mobile adapter to the camera USB connector to copy images to, or control the camera from, smartphone or tablet devices running the Wireless Mobile Utility app.

1 Connect the WU-1b.

After removing the rubber cap from the WU-1b USB connector, turn the camera off and attach the adapter to the camera USB connector.

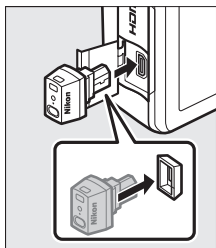

2 Activate the adapter.

Select **Wireless mobile adapter** in the setup menu (155). A confirmation dialog will be displayed; select **Yes** to activate the WU-1b, allowing wireless connection to smart devices, or **No** to deactivate the WU-1b and prevent wireless connection.

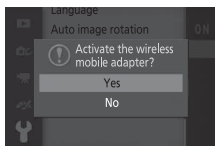

Using the WU-1b for the First Time

After connecting the WU-1b, you will need to adjust smart device wireless settings. See the WU-1b manual for more information.

3 Launch the Wireless Mobile Utility.

Launch the Wireless Mobile Utility on the smart device.

4 Take pictures remotely.

Once a wireless connection is established, the smart device will display the view through the camera lens; the camera will display a message stating that a wireless connection is active.

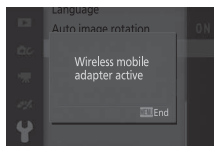

Wireless Networks

Camera settings can not be adjusted while the camera is connected to a wireless network. To end the connection, press the MENU button.

The Wireless Mobile Utility

The Wireless Mobile Utility is available from Google Play and the App Store. System requirements and Information on installation, wireless connections and use may be found in the Wireless Mobile Utility manual available in pdf format from the following URL:

<http://nikonimglib.com/ManDL/WMAU/>





More on Playback

Photo Information

Photo information is superimposed on images displayed in full-frame playback (☞ 29). The information displayed can be selected using the **Display > Playback** option in the setup menu (☞ 158).

Basic Info

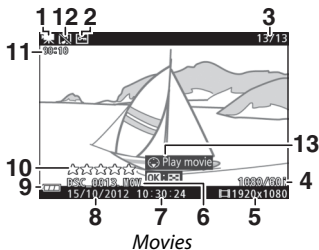
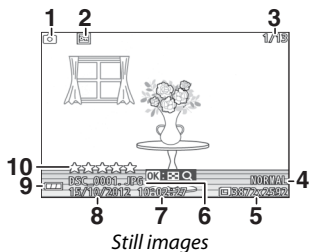

1 Shooting mode	6 File name	121
2 Protect status	7 Time of recording	20, 160
3 Frame number/total number of images	8 Date of recording	20, 160
4 Image quality	9 Battery indicator	22
Frame rate	10 Rating	86
5 Image size	11 Movie length	65
Frame size	12 Audio recording indicator	140
	13 On-screen guide (for movies)	65



■ Detailed Photo Information

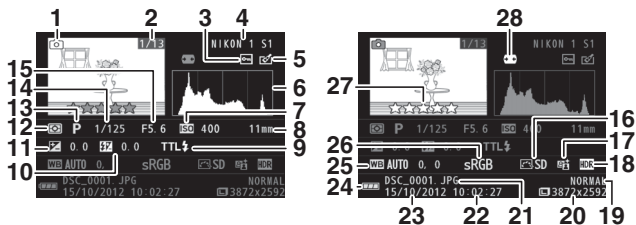

Still images

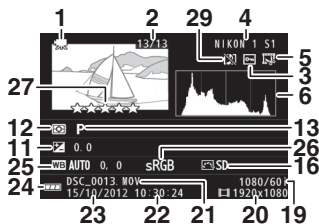

Movies

1 Shooting mode	14 Shutter speed	37, 39
2 Frame number/total number of images	15 Aperture.....	38, 39
3 Protect status.....	16 Picture Control	148
4 Camera name	17 Active D-Lighting indicator	126
5 Retouch indicator	18 HDR indicator	42
111, 112, 113	19 Image quality.....	120
6 Histogram showing distribution of tones in image	Frame rate	138, 139
81	20 Image size.....	120
7 ISO sensitivity	Frame size.....	138, 139
147	21 File name	121
8 Focal length	22 Time of recording	20, 160
193	23 Date of recording.....	20, 160
9 Flash mode.....	24 Battery indicator	22
73	25 White balance.....	142
10 Flash compensation.....	White balance fine-tuning	143
136	26 Color space.....	125
11 Exposure compensation	27 Rating	86
71	28 Auto distortion control.....	124
12 Metering	29 Audio recording indicator	140
123		
13 Creative mode		
33, 34		
Best moment capture selection....		
45, 47		
Advanced movie selection		
57, 62		
Exposure mode		
119		

📷 Histograms (📖 80)

Camera histograms are intended only as a guide and may differ from those in imaging applications. Sample histograms are shown below:

- **If brightness varies evenly across the image**, the distribution of tones will be relatively even.



- **If the image is dark**, tone distribution will be shifted to the left.



- **If the image is bright**, tone distribution will be shifted to the right.













Exposure compensation shifts the distribution of tones to the right when raised, to the left when lowered. Histograms can give you a rough idea of overall exposure when bright ambient lighting makes it difficult to see the display in the monitor.



Thumbnail Playback

To view pictures in “contact sheets” of 4, 9, or 72 images, press  when a picture is displayed full frame and rotate the multi selector counterclockwise.









The following operations can be performed:

To	Use	Description
Display more images		Rotate the multi selector counterclockwise to increase the number of images displayed from 1 to 4, from 4 to 9, or from 9 to 72. To view images taken on selected dates ( 83), rotate the selector counterclockwise when 72 images are displayed. 
Display fewer images		Rotate the multi selector clockwise to reduce the number of images displayed from 72 to 9 or 9 to 4. To view the highlighted image full frame, rotate the selector clockwise when 4 images are displayed. 
Highlight images		Use the multi selector to highlight images. You can delete ( 85) the highlighted image or zoom in for a closer look ( 84).
View highlighted image		Press  to view the highlighted image full frame.
Delete highlighted image		See page 85.

Calendar Playback

To view pictures taken on a selected date, rotate the multi selector counterclockwise when 72 pictures are displayed (📖 82).

The following operations can be performed:













To	Use	Description
Display calendar		To view the calendar, rotate the multi selector counterclockwise when 72 images are displayed (📖 82).  → 
Exit to thumbnail playback		To return to the 72-image display, rotate the multi selector clockwise when the calendar is displayed.  → 
Highlight date		Use multi selector to highlight date in calendar display.
View pictures taken on highlighted date		Press OK to view the first picture taken on the highlighted date.
Delete pictures taken on highlighted date		Press 🗑 to delete all pictures taken on the highlighted date.

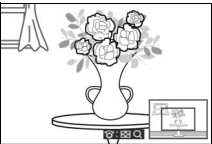

Playback Zoom

To zoom in on a photograph, display it full frame and press  and rotate the multi selector clockwise. Playback zoom is not available with movies or Motion Snapshots.

The following operations can be performed:

To	Use	Description	
Zoom in		Rotate the multi selector clockwise to zoom in, counterclockwise to zoom out. Whenever you zoom in or out, a navigation window will appear with the area currently visible in the display indicated by a yellow border. Press  ,  ,  , or  to scroll the image.	
Zoom out			
View other areas of image			
View faces		Faces (up to five) detected during face priority are indicated by white borders in the navigation window. Press  or  to view other faces.	
Exit zoom		Return to full-frame playback.	

See Also

The **Face-priority zoom** option in the playback menu ( 114) is used to choose whether the multi selector to be used to scroll from face to face during face-priority zoom.

Deleting Pictures

Pictures can be deleted from the memory card as described below. *Note that once deleted, pictures can not be recovered; protected images, however, will not be deleted.*

Deleting the Current Picture

To delete the picture currently displayed in full-frame playback or selected in the thumbnail list, press . A confirmation dialog will be displayed; press again to delete the picture and return to playback, or press to exit without deleting the picture.

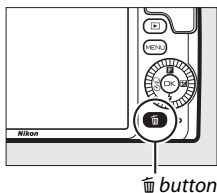

The Playback Menu

To delete multiple images, press the MENU button, select **Delete** in the playback menu, and choose from the options below. A confirmation dialog will be displayed; select **Yes** to delete the images (note that some time may be required if a large number of images is selected).

Delete selected images	Highlight images and press to select or deselect (109). Press to exit when the selection is complete.
Delete all images	Delete all pictures on the memory card.



Rating Pictures

Rate pictures or mark them as candidates for later deletion. Rating is not available with protected images.

1 Select a picture.

Display a picture in full-frame playback.

2 Press ▲ (F).

Press ▲ (F) and rotate the multi-selector to choose from ratings of zero to five stars, or select  to mark the picture as a candidate for later deletion.

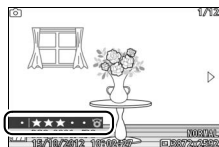

Slide Shows

To view a slide show of the pictures on the memory card, press the **MENU** button, select **Slide show** in the playback menu, and follow the steps below.

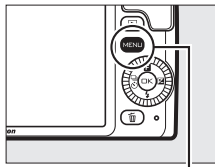

MENU button

1 Select the type of image used in the show.

Highlight the desired option and press **OK**.

All images	Display all the images on the memory card.
Still images	Display still images only.
Movies	Display movies only.
Motion Snapshot	Display only the movie portion of Motion Snapshots. The associated photographs are not displayed.
Select images by date	Display only images recorded on a selected date. A calendar will be displayed; use the multi-selector to highlight a date. 
Selected scene	Display only photos belonging to a specific scene. Choose from Auto , Portrait , Landscape , Night landscape , Night portrait , Backlighting , Close-up , Soft , Miniature effect , and Selective color .
Face priority	Display only images in which the camera has detected a face (26).



2 Adjust display times and choose a background track.

Adjust the following options:

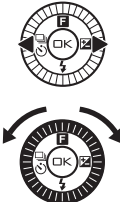
Frame interval	Choose how long each still image is displayed.
Movie playback time	Choose how much of each movie is played back before the next slide is displayed. Choose Same as frame interval to display the next slide after the time selected for Frame interval , No limit to play back the entire movie before displaying the next slide.
Audio	Mute audio playback or choose a slide show background track (to play the highlighted background track prior to selection, press ► and rotate the multi selector to adjust volume; to end playback, press ► again). Select Movie sound tracks to play only audio recorded with movies; in this case, no sound is played for still images or Motion Snapshots. 







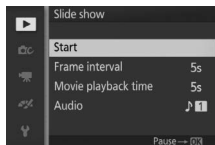

3 Select Start.

Highlight **Start** and press  to start the slide show.



The following operations can be performed while a slide show is in progress:

To	Use	Description
Skip back/skip ahead		Press  to return to the previous frame,  to skip to the next frame.
Pause/resume		Pause the show. Press again to resume.
Adjust volume		Rotate the multi selector to adjust volume.
Exit to playback mode		End the show and return to playback mode.

The options shown at right are displayed when the show ends. Select **Resume** to restart or **Exit** to exit to the playback menu.

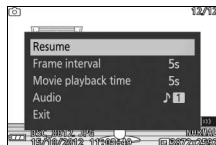



Connections

Installing the Supplied Software

Install the supplied software to copy pictures to your computer for viewing and editing pictures and creating short movies. Before installing the software, confirm that your system meets the requirements on page 93.

1 Launch the installer.

Start the computer, insert the ViewNX 2/Short Movie Creator installer CD, and launch the installer.

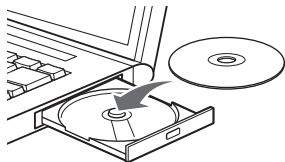

2 Select a language.

If the desired language is not available, click **Region Selection** to choose a different region and then choose the desired language (region selection is not available in the European release).

① Select region (if required)



② Select language

③ Click Next

3 Start the installer.

Click **Install** and follow the on-screen instructions.

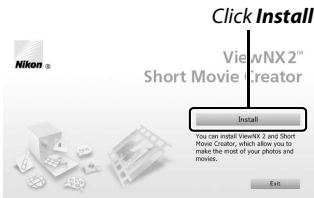

4 Exit the installer.

Click **Yes** (Windows) or **OK** (Mac OS) when installation is complete.



The following software is installed:

- ViewNX 2
- Short Movie Creator
- Apple QuickTime (Windows only)

5 Remove the installer CD from the CD-ROM drive.

Supplied Software

Be sure to update to the latest versions of the supplied software. Nikon Message Center 2 will periodically check for updates while the computer is connected to the Internet.



System Requirements

The system requirements for ViewNX 2 are:

Windows	
CPU	<ul style="list-style-type: none">• Photos/JPEG movies: Intel Celeron, Pentium 4, or Core series, 1.6 GHz or better• H.264 movies (playback): 3.0 GHz Pentium D or better• H.264 movies (editing): 2.6 GHz Core 2 Duo or better
OS	Pre-installed versions of Windows XP, Windows Vista, Windows 7, and Windows 8
RAM	<ul style="list-style-type: none">• Windows 8/Windows 7/Windows Vista: 1 GB or more (2 GB or more recommended)• Windows XP: 512 MB or more (2 GB or more recommended)
Hard-disk space	A minimum of 500 MB available on the startup disk (1 GB or more recommended)
Monitor	<ul style="list-style-type: none">• Resolution: 1024 × 768 pixels (XGA) or more (1280 × 1024 pixels/SXGA or more recommended)• Color: 24-bit color (True Color) or more

Mac OS	
CPU	<ul style="list-style-type: none">• Photos/JPEG movies: Intel Core or Xeon series• H.264 movies (playback): 2 GHz Core Duo or better• H.264 movies (editing): 2.6 GHz Core 2 Duo or better
OS	Mac OS X version 10.6, 10.7, or 10.8
RAM	512 MB or more (2 GB or more recommended)
Hard-disk space	A minimum of 500 MB available on the startup disk (1 GB or more recommended)
Monitor	<ul style="list-style-type: none">• Resolution: 1024 × 768 pixels (XGA) or more (1280 × 1024 pixels/SXGA or more recommended)• Color: 24-bit color (millions of colors) or more

Motion Snapshots

ViewNX 2 is required to view Motion Snapshots saved using the **File format > NMS files** option in the shooting menu (📄 123).



The system requirements for Short Movie Creator are:

Windows	
CPU	2 GHz intel Core 2 Duo or better
OS	Pre-installed versions of Windows XP, Windows Vista, Windows 7, and Windows 8
RAM	1.5 GB or more with at least 128 MB of video RAM (2 GB or more with at least 256 MB of video RAM recommended for creating HD movies)
Hard-disk space	A minimum of 500 MB available on the startup disk (1 GB or more recommended)
Monitor	<ul style="list-style-type: none">• Resolution: 1024 × 768 pixels (XGA) or more• Color: 32-bit color (True Color) or more
Other	DirectX 9 or later and OpenGL 1.4 or later

Mac OS	
CPU	2 GHz intel Core 2 Duo or better
OS	Mac OS X version 10.6, 10.7, or 10.8
RAM	1 GB or more
Hard-disk space	A minimum of 500 MB available on the startup disk (1 GB or more recommended)
Monitor	<ul style="list-style-type: none">• Resolution: 1024 × 768 pixels (XGA) or more• Color: 24-bit color (millions of colors) or more

If your system does not meet the above requirements, only ViewNX 2 will be installed (📖 93).



Supported Operating Systems

See the websites listed on page xvii for the latest information on supported operating systems.

Viewing and Editing Pictures on a Computer

Transferring Pictures

1 Choose how pictures will be copied to the computer.

Choose one of the following methods:

- **Direct USB connection:** Turn the camera off and ensure that the memory card is inserted in the camera. Connect the camera to the computer using the supplied USB cable (do not use force or insert the connectors at an angle) and then turn the camera on.

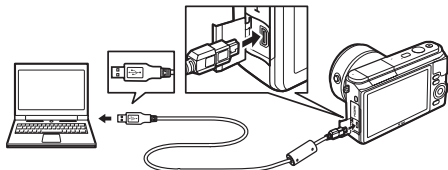

- **SD card slot:** If your computer is equipped with an SD card slot, the card can be inserted directly in the slot.
- **SD card reader:** Connect a card reader (available separately from third-party suppliers) to the computer and insert the memory card.

2 Start the Nikon Transfer 2 component of ViewNX 2.

If a message is displayed prompting you to choose a program, select Nikon Transfer 2.

Windows 7

If the following dialog is displayed, select Nikon Transfer 2 as described below.

- 1 Under **Import pictures and videos**, click **Change program**. A program selection dialog will be displayed; select **Import File using Nikon Transfer 2** and click **OK**.

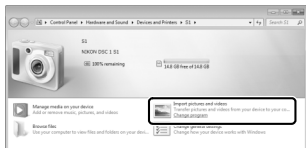

- 2 Double-click **Import file**.



3 Click Start Transfer.

At default settings, all the pictures on the memory card will be copied to the computer.



Click **Start Transfer**

4 Terminate the connection.

If the camera is connected to the computer, turn the camera off and disconnect the USB cable. If you are using a card reader or card slot, choose the appropriate option in the computer operating system to eject the removable disk corresponding to the memory card and then remove the card from the card reader or card slot.

Viewing Pictures

Pictures are displayed in ViewNX 2 when transfer is complete.

Starting ViewNX 2 Manually

- **Windows:** Double-click the ViewNX 2 shortcut on the desktop.
- **Mac OS:** Click the ViewNX 2 icon in the Dock.

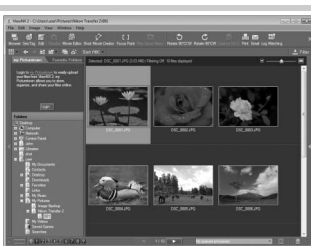

■ ■ Retouching Photographs

To crop pictures and perform such tasks as adjusting sharpness and tone levels, click the **Edit** button in the toolbar.



■ ■ Creating Short Movies

Use the Short Movie Creator to create short movies combining photos, music, Motion Snapshots, and movie footage (98).



■ ■ Printing Pictures

Click the **Print** button in the toolbar. A dialog will be displayed, allowing you to print pictures on a printer connected to the computer.



■ For More Information

Consult online help for more information on using ViewNX 2.

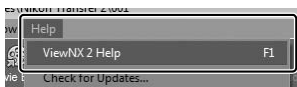

Creating Short Movies

Use the supplied Short Movie Creator software to create movies combining photographs with Motion Snapshots, movies, and music.

1 Transfer pictures.

Transfer pictures as described on page 95.

2 Select components.

Select pictures in ViewNX 2.

3 Start Short Movie Creator.

Click the **Short Movie Creator** button in ViewNX 2.

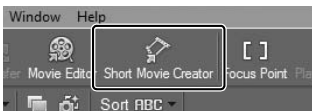

The images selected in Step 2 will be displayed in the Short Movie Creator “Components” panel; if desired, additional pictures can be dragged into the “Components” panel from ViewNX 2 and re-ordered using drag and drop. In the case of photos taken with the Smart Photo Selector, only the best shot will be displayed. The photo and movie components of Motion Snapshots appear as separate files.

“Components” panel



4 Select a style and background track.

Select a style in the “Styles” panel and a background track in the “Music” panel. To preview the movie, click .

5 Save the movie.

Click **Create Movie**. The dialog shown at right will be displayed; select one of the following options and click **Create**.

- **Save file:** Save the movie to a folder on the computer.
- **Save to Camera (memory card):** Save the movie to a memory card so that it can later be played back on the camera. To use this option, you will first need to insert a memory card that has been formatted in the camera (📖 156) into a card reader or card slot.

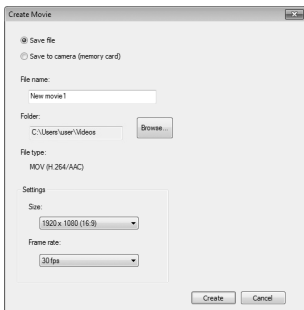

Starting Short Movie Creator

If ViewNX 2 is not running, you can start Short Movie Creator by double-clicking the **Short Movie Creator** icon on the desktop (Windows) or clicking the **Short Movie Creator** icon in the Dock (Mac OS).

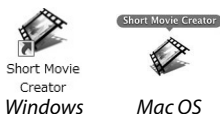

Viewing Short Movies on Other Devices

Movies saved to a memory card using the **Save to Camera (memory card)** option in Short Movie Creator can be viewed on the camera, or displayed on a television monitor when the camera is connected to a TV (📖 100). Movies created in other applications or using the **Save file** option in Short Movie Creator can not be viewed on the camera.

For More Information

Consult online help for more information on using Short Movie Creator.

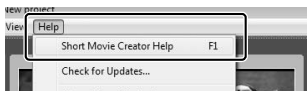

Viewing Pictures on TV

Connect the camera to a television for playback.

Connecting an HDMI Cable

Always turn the camera off before connecting or disconnecting HDMI cables. When connecting cables, do not use force or attempt to insert the connectors at an angle.

High-Definition Devices

A type C mini-pin High-Definition Multimedia Interface (HDMI) cable (available separately from third-party suppliers) can be used to connect the camera to high-definition video devices.

1 Connect the HDMI cable.

Turn the camera off and connect the HDMI cable.

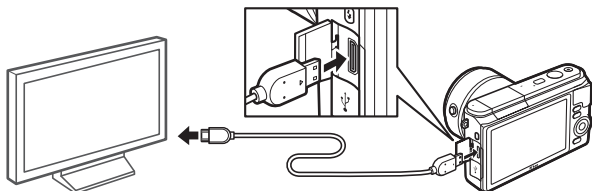

*Connect to HD device
(choose cable with
appropriate connector)*

Connect to camera

2 Tune the device to the HDMI channel.

3 Turn the camera on.

Turn the camera on; the camera monitor will remain off and the camera shooting mode display will appear on the HD device. Pictures can be played back using camera controls as described elsewhere in this manual; note that the edges of images may not be visible in the display.

Close the Connector Cover



Close the connector cover when the connectors are not in use. Foreign matter in the connectors can interfere with data transfer.

Television Playback

Volume can be adjusted using the controls on the television; adjusting volume on the camera has no effect. Use of an EH-5b AC adapter and EP-5C power connector (available separately) is recommended for extended playback.

■ ■ HDMI Device Control

To control the camera remotely from a device that supports HDMI-CEC (**H**igh-**D**efinition **M**ultimedia **I**nterface-**C**onsumer **E**lectronics **C**ontrol), select **On** for **HDMI device control** in the camera setup menu. The HDMI-CEC device will display a remote control guide and the remote control can be used in place of the following camera controls:

Camera	Remote control
▲, ▼, ◀, ▶	Up, down, left, and right buttons
	Center button
	Blue button
MENU	Red button
Slide show menu	Green button

The remote control guide can be hidden or displayed at any time by pressing the yellow button on the remote control. See the television manual for details.



Printing Photographs

Selected JPEG images can be printed on a PictBridge printer connected directly to the camera.

Connecting the Printer

Connect the camera using the supplied USB cable.

1 Turn the camera off.

2 Connect the USB cable.

Turn the printer on and connect the USB cable as shown. Do not use force or attempt to insert the connectors at an angle.

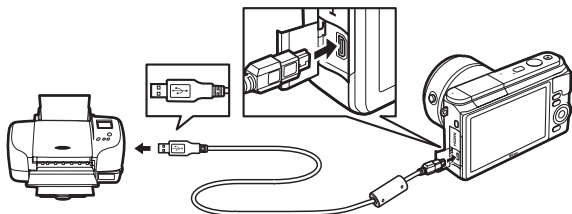

USB Hubs

Connect the camera directly to the printer; do not connect the cable via a USB hub.

3 Turn the camera on.

A welcome screen will be displayed in the monitor, followed by a PictBridge playback display.



PictBridge

Printing Via Direct USB Connection

Be sure the EN-EL20 battery is fully charged or use an optional EH-5b AC adapter and EP-5C power connector.

Printing Pictures One at a Time

1 Select a picture.

Press ◀ or ▶ to view additional pictures. Rotate the multi selector clockwise to zoom in on the current frame (📖 84; rotate the multi selector counterclockwise to exit zoom). To view nine pictures at a time, rotate the selector counterclockwise when a picture is displayed full frame. Press ▲, ▼, ◀, or ▶ to highlight pictures, or rotate the multi selector clockwise to display the highlighted picture full frame.

2 Adjust print options.

Press Ⓞ to display PictBridge print options (📖 105). Press ▲ or ▼ to highlight options and press ▶ to select.

3 Start printing.

Highlight **Start printing** and press Ⓞ to start printing. To cancel before all copies have been printed, press Ⓞ again.



Selecting Photographs for Printing

Movies and NEF (RAW) photographs (📖 120) can not be selected for printing. If Motion Snapshots are selected, only the photographs will be printed; the movie portion will not be printed. If photographs taken with the Smart Photo Selector are selected, only the best shot will be printed.



Printing Multiple Pictures

1 Display the PictBridge menu.

Press the MENU button in the PictBridge playback display (see Step 3 on page 102).

2 Choose an option.

Highlight one of the following options and press ►.

- **Select images for printing:** Select pictures for printing.
 - **Print DPOF print order:** Print an existing print order created with the **DPOF print order** option in the playback menu (📖 106). The current print order will be displayed in Step 3.
 - **Index print:** To create an index print of all JPEG pictures on the memory card, proceed to Step 4. Note that if the memory card contains more than 256 pictures, a warning will be displayed and only the first 256 images will be printed.
-

3 Select pictures.



Press ◀ or ▶ to highlight pictures. To select the current picture for printing, press ▲. The number of prints will be set to 1; press ▲ or ▼ to specify the number of prints (up to 99; to deselect the picture, press ▼ when the number of prints is 1). Continue until all the desired pictures have been selected.

4 Adjust print options.

Press Ⓞ to display PictBridge print options. Press ▲ or ▼ to highlight page size, border, or time stamp items and press ► to display the options described on page 105; note that a warning will be displayed if the selected page size is too small for an index print.



5 Start printing.













Highlight **Start printing** and press  to start printing. To cancel before all copies have been printed, press  again.



Errors

See page 185 for information on what to do if an error occurs during printing.

PictBridge Print Options

Page size	Highlight a page size (only sizes supported by the current printer are listed) and press  to select and exit to the previous menu (to print at the default page size for the current printer, select Use printer settings).
Number of copies	This option is listed only when pictures are printed one at a time. Press  or  to choose number of copies (maximum 99), then press  to select and return to the previous menu.
Print border	This option is listed only if supported by the printer. Highlight Use printer settings (use current printer settings), Yes (print white borders), or No (no borders) and press  to select and exit to the previous menu.
Print time stamp	Highlight Use printer settings (use current printer settings), Yes (print times and dates of recording on photos), or No (no time stamp) and press  to select and exit to the previous menu.
Crop	This option is listed only when pictures are printed one at a time on a printer that supports cropping. To exit without cropping, highlight No and press  . To crop the current picture, highlight Yes and press  . A crop selection dialog will be displayed; rotate the multi-selector clockwise to increase the size of the crop, counterclockwise to decrease. Press  ,  ,  , or  to position the crop and press  . Note that print quality may drop if small crops are printed at large sizes.



Creating a DPOF Print Order: Print Set

The **DPOF print order** option is used to create digital “print orders” for PictBridge-compatible printers and devices that support DPOF. Press the MENU button, select **DPOF print order** in the playback menu, and choose from the following options:

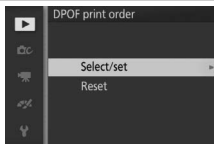

Select/ set	Press ◀ or ▶ to highlight pictures (☐ 109). To select the current picture for printing, press ▲. The picture will be marked with a 🖨 icon and the number of prints will be set to 1; press ▲ or ▼ to specify the number of prints (up to 99; to deselect the picture, press ▼ when the number of prints is 1). When the selection is complete, press Ⓞ to display printing options. Highlight Print shooting info (print the shutter speed and aperture on all pictures in the print order) or Print date (print the date of recording on all pictures in the print order) and press ▶ to select or deselect, and then press Ⓞ to complete the print order.	A screenshot of the camera's menu system. The title is 'DPOF print order'. Below the title is 'Select/set'. There are two options: 'Print shooting info' and 'Print date', both with checkboxes to their left. At the bottom right, there is a 'Set' option with a camera icon and an 'OK' button.
Reset	Remove all pictures from the print order.	

DPOF Print Order

DPOF date and shooting info options are not supported when printing via direct USB connection; to print the date of recording on photographs in the current print order, use the PictBridge **Print time stamp** option (☐ 105).

The **DPOF print order** option can not be used if there is not enough space on the memory card to store the print order. For restrictions on the types of images that can be selected for printing, see page 103.

Print orders may not print correctly if images are deleted using a computer or other device after the print order is created.

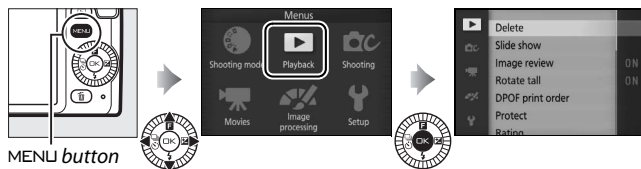

The Playback Menu

To display the playback menu, press **MENU** and select **Playback**.



The playback menu contains the following options:

Option	Description	Default	
Delete	Delete multiple images.	—	85
Slide show	View movies and photos in a slide show.	Image type: All images Selected scene: Auto Frame interval: 5 s Movie playback time: Same as frame interval Audio: Background track 1	87
Image review	Choose whether pictures are displayed after shooting.	On	110
Rotate tall	Rotate “tall” (portrait-orientation) pictures for display during playback.	On	110
DPOF print order	Create digital “print orders”.	—	106
Protect	Protect pictures from accidental deletion.	—	110
Rating	Rate pictures.	—	110
D-Lighting	Brighten shadows in dark or back-lit photos, creating a retouched copy that is saved separately from the unmodified original.	—	111
Resize	Create small copies of selected pictures.	Choose size: 1.1 M	112

Option	Description	Default	
Crop	Create cropped copies of selected pictures.	Aspect ratio: 3:2	113
Face-priority zoom	Choose whether ◀ and ▶ can be used during playback zoom ( 84) to select faces detected with face priority.	On	114
Edit movie	Create copies of movies from which unwanted footage has been trimmed.	—	114
Change theme	Change the themes for existing Motion Snapshots.	—	115

Playback

The camera may be unable to display or retouch images that were created or have been edited with other devices.

Image Quality

Copies created from JPEG photos are the same quality as the original, while copies created from NEF (RAW) photos are saved as fine-quality JPEG images ( 120).



Selecting Multiple Images

Choosing the options listed below displays an image selection dialog. Press ◀ or ▶ to highlight pictures (only pictures to which the operation applies are available for selection).

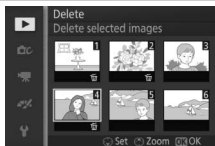

- **Delete > Delete selected images** (📖 85)
- **DPOF print order > Select/set** (📖 106)
- **Protect > Select/set** (📖 110)
- **D-Lighting** (📖 111)
- **Crop > Select images** (📖 113)
- **Change theme** (📖 115)
- **Rating** (📖 110)
- **Resize > Select images** (📖 112)
- **Edit movie** (📖 114)

🔍 Inspecting Pictures

The picture currently highlighted in the thumbnail display can be inspected by pressing ▲; except in the cases of **DPOF print order**, **Rating**, and **Change theme**, the picture will be displayed full screen while the button is pressed.



Image Review

If **On** is selected, pictures will be displayed immediately after shooting. To view pictures when **Off** is selected, press the  button.

Rotate Tall

Choose whether to rotate “tall” (portrait-orientation) pictures for display during playback. Note that because the camera itself is already in the appropriate orientation during shooting, images are not rotated automatically during image review.







On	“Tall” (portrait-orientation) pictures are automatically rotated for display in the camera monitor. Pictures taken with Off selected for Auto image rotation ( 161) will be displayed in “wide” (landscape) orientation.
Off	“Tall” (portrait-orientation) pictures are displayed in “wide” (landscape) orientation.

Protect

Protect selected images from accidental deletion. Note that this option does NOT protect files from deletion when the memory card is formatted ( 156).

 Select/set	Press  or  to highlight pictures ( 109) and press  to select or deselect. Press  to exit when the operation is complete.
Reset	Remove protection from all pictures.



Rating

Press  or  to highlight pictures ( 109) and press  or  to choose a rating ( 86). Press  to exit when the operation is complete.

D-Lighting

Applied to selected images, D-Lighting creates copies that have been processed to brighten shadows. Use to retouch dark or backlit photographs.



Press ◀ or ▶ to highlight an image (📖 109) and press  to display the options shown at right. Press ▲ or ▼ to choose the amount of correction performed (the effect can be previewed in the display) and press  to create a retouched copy.

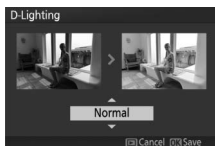

D-Lighting

Noise (randomly-spaced bright pixels, fog, or lines) may appear in copies created with **D-Lighting**. Uneven shading may be visible with some subjects.

Image Size

Copies created from JPEG photos are the same size as the original, while copies created from NEF (RAW) photos are saved as JPEG images with a size of 3872 × 2592.



Resize

Create small copies of selected photographs. Select **Choose size** and choose a size from **1.1 M**, **0.6 M**, and **0.3 M**, and then choose **Select images**. Press ◀ or ▶ to highlight pictures (📖 109) and press ▼ to select or deselect. When the selection



is complete, press Ⓞ to display a confirmation dialog and select **Yes** to save the resized copies. Copies are resized according to the aspect ratio of the original and the option selected for **Choose size**:

	3:2	16:9
1.1 M	1280 × 856 pixels	1280 × 720 pixels
0.6 M	960 × 640 pixels	960 × 536 pixels
0.3 M	640 × 424 pixels	640 × 360 pixels

Resized Copies

Playback zoom may not be available with resized copies.



Crop

Create a cropped copy of selected photographs.

Select images	To select an image for trimming, choose Select images , highlight a picture (□ 109), and press OK .
Aspect ratio	Choose from aspect ratios of 3 : 2, 4 : 3, 1 : 1, and 16 : 9.

The selected image will be displayed with a default crop of the selected aspect ratio shown in yellow. Use the controls below to size and position the crop and save the copy.

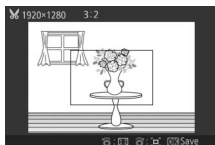

To	Use	Description
Decrease crop size		Rotate the multi selector counterclockwise to decrease the size of the crop.
Increase crop size		Rotate the multi selector clockwise to increase the size of the crop.
Position crop		Press ▲, ▼, ◀, or ▶ to position the crop.
Create copy		Save the current crop as a separate file.

Cropped Copies

Playback zoom may not be available with cropped copies. The size of the copy varies with crop size and aspect ratio and appears at upper left in the crop display.

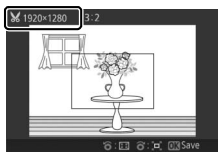

Face-Priority Zoom

If **On** is selected, ◀ and ▶ can be used during playback zoom to select faces detected with face priority. If **Off** is selected, ◀ and ▶ can be used with ▲ and ▼ to scroll the display.

Edit Movie

Trim footage from movies to create edited copies.

1 Select **Choose start point** or **Choose end point**.

Choose from the following options:

- **Choose start point:** Trim the opening footage.
- **Choose end point:** Trim the closing footage.

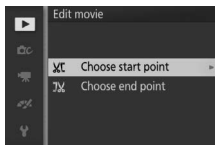

2 Select a movie.

Press ◀ or ▶ to highlight a movie (📖 109) and press ⏹ to select.

3 Pause the movie on opening or closing frame.

Play the movie back, pressing ⏹ to begin and resume playback and ▼ to pause (📖 65; the first frame is indicated by a ⏮ icon in the display, the last frame by ⏭). Pause playback when you reach the frame that will become the new opening or closing frame.



4 Delete the unwanted frames.

Press ▲ to delete all frames before (**Choose start point**) or after (**Choose end point**) the current frame.

5 Save the copy.

Highlight **Yes** and press  to save the edited copy. If necessary, the copy can be trimmed as described above to remove additional footage.

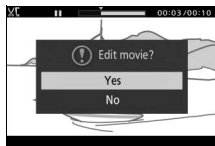



Trimming Movies

Movies must be at least two seconds long. If a copy can not be created at the current playback position, the current position will be displayed in red in Step 4 and no copy will be created. The copy will not be saved if there is insufficient space available on the memory card.

To prevent the camera from turning off unexpectedly, use a fully-charged battery when editing movies.

Change Theme

Assign existing Motion Snapshots new themes (NMS-format files only; Motion Snapshots created with **MOV file** selected for **File format** in the shooting menu can not be assigned new themes). Choose from **Beauty, Waves, Relaxation, Tenderness,** and **None**. Highlight a Motion Snapshot and press  to display a list of themes (to play a theme, highlight it and press ; volume can be adjusted by rotating the multi selector). Highlight the new theme and press . A confirmation dialog will be displayed; select **Yes** to save the selected Motion Snapshot with the new theme.

See Also

See page 123 for information on Motion Snapshot file formats.





The Shooting Menu

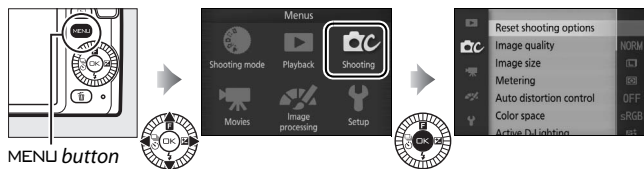

To display the shooting menu, press **MENU** and select **Shooting**.



The shooting menu contains the following options:

Option	Description	Default	
Reset shooting options	Reset shooting options to default values.	—	119
Exposure mode	Choose how the camera sets shutter speed and aperture in Motion Snapshot mode (□ 53).	Scene auto selector	119
Image quality	Choose a file format and compression ratio.	JPEG normal	120
Image size	Choose a size for new photos.	3872×2592; 10.0 M	120
Number of shots saved	Choose the number of shots selected by the Smart Photo Selector (□ 47).	5	122
Movie before/after	Choose when the movie portion of Motion Snapshots is recorded (□ 53).	1.0 s : 0.6 s	122
File format	Choose a file format for new Motion Snapshots (□ 53).	NMS files	123
Metering	Choose how the camera meters exposure.	Matrix	123



Option	Description	Default	
Autodistortion control	Choose whether the camera corrects barrel and pincushion distortion.	Off	124
Color space	Choose a color space for new pictures.	sRGB	125
Active D-Lighting	Avoid loss of detail in highlights and shadows.	On	126
HDR	Enhance detail in highlights and shadows when photographing high-contrast scenes with Backlighting selected in creative mode.	On	42
Long exposure NR	Reduce noise in long time-exposures.	Off	127
Optical VR	Adjust settings for 1 NIKKOR lenses with vibration reduction.	Active/On*	127
Electronic VR	Choose whether to use vibration reduction in Motion Snapshot mode ( 53). This feature is available even if vibration reduction is not offered by the attached 1 NIKKOR lens.	On	128
Focus mode	Choose how the camera focuses.	See page 129	128
AF-area mode	Choose how the focus area is selected.	Auto-area	133
Face-priority	Turn face priority on or off.	On	135
Built-in AF assist	Control the built-in AF-assist illuminator.	On	135
Flash compensation	Control flash output.	0.0	136

* Varies with lens ( 127).

Reset Shooting Options

Select **Yes** to reset the options in the shooting menu and other shooting settings to default values (☐ 117, 178).

Exposure Mode

The options in the exposure mode menu offer varying degrees of control over shutter speed and aperture in Motion Snapshot mode (☐ 53).

 Scene auto selector	An automatic, “point-and-shoot” mode in which the camera not only chooses shutter speed and aperture but adjusts other settings to suit the subject (automatic scene selection; ☐ 25).
P Programmed auto	The camera sets shutter speed and aperture for optimal exposure (☐ 36). Recommended for snapshots and in other situations in which there is little time to adjust camera settings.
S Shutter-priority auto	You choose the shutter speed; the camera selects an aperture for best results (☐ 37). Use to freeze or blur motion.
A Aperture-priority auto	You choose the aperture; the camera selects a shutter speed for best results (☐ 38). Use to blur the background or bring both foreground and background into focus.
M Manual	You control both shutter speed and aperture (☐ 39). Set shutter speed to “Bulb” for long time-exposures.

ISO Sensitivity (P, S, A, and M Modes)

When an “auto” option is selected for **ISO sensitivity** (☐ 147), the camera will automatically adjust sensitivity within the selected range if optimal exposure can not be achieved at the selected shutter speed or aperture.





Image Quality

Choose a file format and compression ratio for photographs.

Option	File type	Description
NEF (RAW)	NEF	Compressed 12-bit raw data from the image sensor are saved directly to the memory card. White balance, contrast, and other settings can be adjusted on a computer after shooting.
JPEG fine	JPEG	Record JPEG images at a compression ratio of roughly 1 : 4 (fine quality).
JPEG normal		Record JPEG images at a compression ratio of roughly 1 : 8 (normal quality).
JPEG basic		Record JPEG images at a compression ratio of roughly 1 : 16 (basic quality).

Image Size

Choose the size of photographs.

Option	Size (pixels)	Approximate print size at 300 dpi (cm/in.)*
 3872×2592; 10.0 M	3872 × 2592	32.8 × 21.9/12.9 × 8.6
 2896×1944; 5.6 M	2896 × 1944	24.5 × 16.5/ 9.7 × 6.5
 1936×1296; 2.5 M	1936 × 1296	16.4 × 11.0/ 6.5×4.3

* Print size in inches equals image size in pixels divided by printer resolution in dots per inch (dpi); 1 inch=approximately 2.54 cm).





NEF (RAW)

The option selected for image size does not affect the size of NEF (RAW) images. NEF (RAW) images can be viewed on the camera or using software such as Capture NX 2 (available separately;  164) or ViewNX 2 (supplied).

File Names

Photos and movies are stored as image files with names of the form “xxx_nnnn.yyy,” where:

- xxx is either NMS (Motion Snapshots recorded with **NMS files** selected for **File format**;  123) or DSC (photos, MOV-format Motion Snapshots, and movies, including copies created with **Edit movie**;  114),
- nnnn a four-digit number between 0001 and 9999 assigned automatically in ascending order by the camera, and
- yyy one of the following three letter extensions: “NEF” for NEF (RAW) images, “JPG” for JPEG images, or “MOV” for movies.



Trimmed copies created with **Edit movie** ( 114) have file names beginning with “DSC”; copies created with the other retouch options in the playback menu have file names beginning with “CSC” (e.g., “CSC_0001.JPG”). Images recorded with **Adobe RGB** selected for **Color space** ( 125) have names that begin with an underscore (e.g., “_DSC0001.JPG”).

Image Quality and Size

Together, image quality and size determine how much space each photograph occupies on the memory card. Larger, higher quality images can be printed at larger sizes but also require more memory, meaning that fewer such images can be stored on the memory card ( 179).





Number of Shots Saved

Choose the number of shots selected by the Smart Photo Selector. If **5** is selected, the camera will save the best shot and 4 best shot candidates. If **1** is selected, the camera will save only the best shot.

Movie Before/After

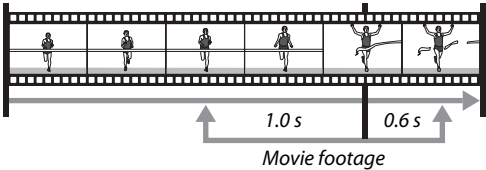
Choose whether the movie portions of Motion Snapshots end when the shutter-release button is pressed all the way or about 0.6 s after (📖 53). If **1.6 s : 0 s** is selected, the photograph used for the Motion Snapshot will feature the last frame of the movie.

1.0 s : 0.6 s	<p>Movie footage starts about a second before the shutter-release button is pressed all the way down and ends about 0.6 s after.</p> <p><i>Shutter-release button pressed halfway</i> <i>Shutter-release button pressed all the way down</i></p>  <p>Movie footage</p>
1.6 s : 0 s	<p>The camera records about 1.6 s of movie footage, ending when the shutter-release button is pressed all the way down.</p> <p><i>Shutter-release button pressed halfway</i> <i>Shutter-release button pressed all the way down</i></p>  <p>Movie footage</p>

File Format

Choose the file format for Motion Snapshots (📖 53).

NMS files	Motion Snapshots are recorded as a 4 s MOV file and a JPEG image. Motion Snapshots can only be viewed on the camera or using ViewNX 2 (📖 93).
MOV file	Motion Snapshots are recorded as a 10 s MOV file that can be viewed in a variety of computer applications. The Motion Snapshot is not displayed automatically when shooting ends (📖 54); for information on viewing Motion Snapshot movies, see page 65.

Metering

Choose how the camera sets exposure.

<input checked="" type="checkbox"/> Matrix	The camera meters a wide area of the frame and adjusts for contrast (tone distribution), color, composition, and subject distance, producing natural results in most situations.
<input checked="" type="checkbox"/> Center-weighted	The camera meters the entire frame but assigns the greatest weight to the center area. This is the classic meter for portraits and is recommended if you are using filters with an exposure factor (filter factor) over 1×.
<input type="checkbox"/> Spot	The camera meters the current focus area; use to meter off-center subjects (if Auto-area is selected for AF-area mode as described on page 133, the camera will meter the center focus area, while during face priority the camera will meter the focus area closest to the center of the selected face; 📖 26). Spot metering ensures that the subject will be correctly exposed, even when framed against a background that is much brighter or darker.



Metering and Shooting Mode

In auto and best moment capture modes and in creative modes other than **P**, **S**, **A**, and **M**, and when  **Scene auto selector** (📖 119) is chosen in Motion Snapshot mode, metering is adjusted automatically according to the scene.

Auto Distortion Control

Select **On** to reduce barrel distortion in photos taken with wide-angle lenses and to reduce pin-cushion distortion in photos taken with long lenses (note that the edges of photographs may be cropped out, and that there may be an increase in the time needed to process images before they are saved). This option is available only with 1 NIKKOR lenses and not with other NIKKOR lenses attached using the FT1 mount adapter (📖 198). Results are not guaranteed with third-party lenses.



Color Space

The color space determines the gamut of colors available for color reproduction. Choose **sRGB** for photos that will be used “as is,” with no further modification, **Adobe RGB** for photos that will be extensively processed or retouched after leaving the camera. Note that regardless of the option selected, sRGB is used for movies and Motion Snapshots and for photos taken during movie recording.

Color Space

Color spaces define the correspondence between colors and the numeric values by which they are represented in a digital image file. The sRGB color space is widely used, while Adobe RGB is typically used in publishing and commercial printing. sRGB is recommended when taking photographs that will be printed without modification or viewed in applications that do not support color management, or when taking photographs that will be printed with ExifPrint, the direct printing option on some household printers, or kiosk printing or other commercial print services. Adobe RGB photographs can also be printed using these options, but colors will not be as vivid.

JPEG photographs taken in the Adobe RGB color space are DCF compliant; applications and printers that support DCF will select the correct color space automatically. If the application or device does not support DCF, select the appropriate color space manually. For more information, see the documentation provided with the application or device.

Nikon Software

ViewNX 2 (supplied) and Capture NX 2 (available separately) automatically select the correct color space when opening photographs created with this camera.



Active D-Lighting

Active D-Lighting preserves details in highlights and shadows for natural contrast. Use with high contrast scenes such as a brightly lit outdoor view framed in a door or window or a subjects in the shade on a sunny day. It is most effective when used with **Matrix** metering (☐ 123).



Active D-Lighting: **Off**



Active D-Lighting: ☑ **On**

☑ Active D-Lighting

Noise (randomly-spaced bright pixels, fog, or lines) may appear in photographs taken with Active D-Lighting. Uneven shading may be visible with some subjects.

✎ “Active D-Lighting” Versus “D-Lighting”

The **Active D-Lighting** option in the shooting menu adjusts exposure before shooting to optimize the dynamic range, while the **D-Lighting** option in the playback menu (☐ 111) brightens shadows in images after shooting.



Long Exposure NR

Photographs taken at slow shutter speeds are automatically processed to reduce “noise” (bright spots, randomly-spaced bright pixels, or fog), slightly increasing recording times. Selecting **On** increases the amount of noise reduction performed at shutter speeds slower than 1 s and increases the time required to record images by roughly 1.5 to 2 times. During processing, a warning will be displayed and pictures can not be taken (if the camera is turned off before processing is complete, the picture will be saved but noise reduction will not be performed). In continuous release mode, frame rates will slow and while photographs are being processed, the capacity of the memory buffer will drop.

Optical VR

This option is available with 1 NIKKOR lenses that support vibration reduction (VR). The options available vary with the type of lens: **Normal/Active/Off** for lenses that support active vibration reduction and **On/Off** for other VR lenses. Choose **Active, Normal**, or **On** to reduce the effects of vibration; choose **Active** when shooting from a moving vehicle or while walking or for other forms of strong camera shake, **Normal** for the relatively mild camera shake that occurs while standing still.

Vibration Reduction

When the camera is panned, vibration reduction applies only to motion that is not part of the pan (if the camera is panned horizontally, for example, vibration reduction will be applied only to vertical shake), making it much easier to pan the camera smoothly in a wide arc. The composition may appear to change after the shutter is released, but this does not indicate a malfunction.



Electronic VR

Select **On** to enable electronic vibration reduction while recording Motion Snapshots. This feature is available even if the attached 1 NIKKOR lens does not support vibration reduction. Note that there will be a slight delay before recording begins and that the edges of the image will be cropped out when **On** is selected.

Focus Mode

Choose how the camera focuses.

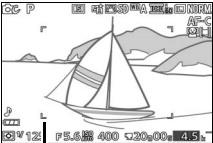
AF-A	Auto-select AF: The camera automatically selects AF-S if the subject is stationary, AF-C if it is moving.
AF-S	Single AF: For stationary subjects. Focus locks when the shutter-release button is pressed halfway.*
AF-C	Continuous AF: For subjects in motion. The camera focuses continuously on the subject in the AF-area brackets while the shutter-release button is pressed halfway (note that the AF-area brackets appear only in the detailed display; □ 157). Photos can be taken whether or not the camera is in focus. 
AF-F	Full-time AF: For subjects in motion. The camera focuses continuously; photos can be taken whether or not the camera is in focus.
MF	Manual focus: Focus manually (□ 131). Photos can be taken whether or not the camera is in focus.

* Shutter can only be released if camera is able to focus.



 Focus Mode

The options available vary as shown below.

Menu		Focus mode
Shooting		AF-A (default), AF-S, AF-C, MF
Movies	P Programmed auto, S Shutter-priority auto, A Aperture-priority auto, M Manual	AF-F (default), AF-S, MF
	⏏ Slow motion	AF-S (default), MF



Getting Good Results with Autofocus

Autofocus does not perform well under the conditions listed below. The shutter release may be disabled if the camera is unable to focus under these conditions, or the focus area may be displayed in green and the camera may sound a beep, allowing the shutter to be released even when the subject is not in focus. In these cases, focus manually (☐ 131) or use focus lock (☐ 134) to focus on another subject at the same distance, and then recompose the photograph.

There is little or no contrast between the subject and the background.

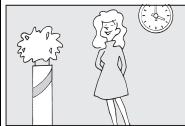

Example: The subject is the same color as the background.

The subject contains areas of sharply contrasting brightness.

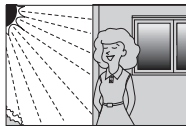

Examples: The subject is half in the shade; a night scene with point illumination.

The subject contains objects at different distances from the camera.



Example: The subject is inside a cage.

Background objects appear larger than the subject.



Example: A building is in the frame behind the subject.

The subject is dominated by regular geometric patterns.

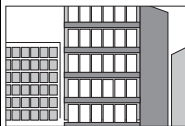

Example: Blinds or a row of windows in a skyscraper.

The subject contains many fine details or is made up of objects that are small or lack variation in brightness.

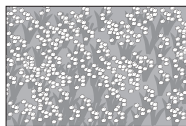

Example: A field of flowers.

See Also

See page 158 for information on controlling the beep that sounds when the camera focuses.



Manual Focus

Manual focus can be used when autofocus does not produce the desired results.

1 Select manual focus.

Highlight **Manual focus** in the focus mode menu (📖 128) and press ▶.

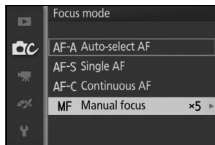

2 Choose a magnification.

To choose the magnification for the manual focus display, highlight **10x zoom**, **5x zoom**, or **2x zoom** and press .

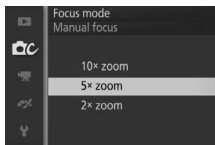





3 Display the manual focus guides.

In the shooting display, press  to magnify the view at the center of the frame by the amount selected in Step 2 (this feature is not available during movie recording or in slow-motion movie mode). Manual focus guides are also displayed.



4 Focus.

Rotate the multi selector until the subject is in focus. Rotate the multi selector clockwise to increase the focus distance, counterclockwise to decrease; the faster you rotate the multi selector, the quicker the focus distance changes. The focus indicator shows the approximate focus distance. Press  when the subject is in focus.

Press , , , or  to view areas of the frame not currently visible in the display; the visible portion is shown by the navigation window.



Focus indicator

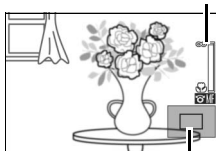

Navigation window

Movies

The multi selector can also be used to choose the focus distance if manual focus is selected prior to movie recording. Rotate the multi selector clockwise to increase the focus distance, counterclockwise to decrease; the faster you rotate the multi selector, the quicker the focus distance changes.

Focal Plane Position

To determine the distance between your subject and the camera, measure from the focal plane mark on the camera body. The distance between the lens mounting flange and the focal plane is approximately 17 mm (0.7 in.).

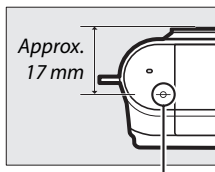









Focal plane mark

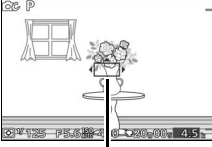

AF-Area Mode

Choose how the focus area for autofocus is selected.

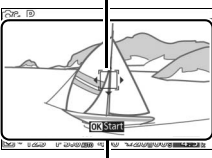
 Auto-area	The camera automatically detects the subject and selects the focus area.	
 Single-point	Press  to view the focus area selection display, then use the multi selector to position the focus area over your subject and press  ; the camera focuses on the subject in the selected focus area only. Use with stationary subjects.	 <p><i>Focus area</i></p>
 Subject tracking	Press  to view the focus area selection display, then use the multi selector to position the focus area over your subject and press  . The focus area will track the subject as it moves through the area shown at right. The camera will focus on the selected subject when the shutter-release button is pressed halfway. To end focus tracking when shooting is complete, press  .	 <p><i>Subject tracking area</i></p>

Subject Tracking

The camera may be unable to track subjects if they move quickly, leave the frame or are obscured by other objects, change visibly in size, color, or brightness, or are too small, too large, too bright, too dark, or similar in color or brightness to the background.



Focus Lock

When **Single AF** is selected for **Focus mode** (📖 128), focus lock can be used to change the composition after focusing on the subject in the center of the frame, allowing you to focus on a subject that will not be in the center of the final composition. If the camera is unable to focus using autofocus (📖 130), you can also focus on another subject at the same distance and then use focus lock to recompose the photograph. Focus lock is most effective when an option other than **Auto-area** is selected for **AF-area mode** (📖 133).

1 Lock focus.

Position the subject in the center of the frame and press the shutter-release button halfway to initiate focus. Check that the focus area is displayed in green. Focus will remain locked while the shutter-release button is pressed halfway.

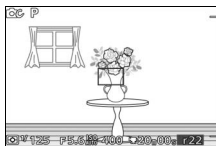

2 Recompose the photograph and shoot.

Focus will remain locked between shots.

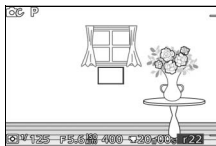

Do not change the distance between the camera and the subject while focus lock is in effect. If the subject moves, lift your finger from the shutter-release button to end focus lock and then focus again at the new distance.

Face-Priority

Choose **On** to enable face priority (📖 26).

Built-in AF Assist

When **On** is selected, the built-in AF-assist illuminator will light to illuminate poorly-lit subjects if:

- **AF-S** is selected for focus mode (📖 128) or single AF is selected in **AF-A**, and
- **Auto-area** or **Single-point** is selected for **AF-area mode** (📖 133).

AF-assist illuminator



The AF-assist illuminator will not light to assist the focus operation in advanced movie mode, during movie recording, or when **Off** is selected. If the AF-assist illuminator does not light, autofocus may not produce the desired results when lighting is poor.

The AF-Assist Illuminator







Larger lenses may prevent the illuminator lighting all or part of the subject. Remove lens hoods when using the illuminator. Information on the modes in which AF-assist is available may be found on page 174.



Flash Compensation

Flash compensation alters flash output from the level suggested by the camera, changing the brightness of the main subject relative to the background. Choose from values between -3 EV (darker) and $+1$ EV (brighter) in increments of $\frac{1}{3}$ EV; in general, positive values make the subject brighter while negative values make it darker.

A  icon is displayed when flash compensation is in effect. Normal flash output can be restored by setting flash compensation to ± 0 . Flash compensation is not reset when the camera is turned off.

Flash compensation	
	- 0.7
	- 1.0
	- 1.3
	- 1.7
	- 2.0
	- 2.3

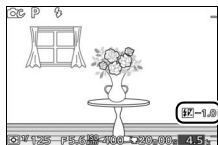

The Movie Menu

To display the movie menu, press MENU and select **Movies**.

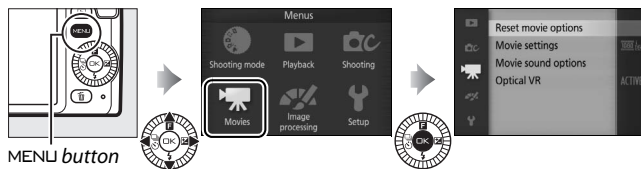

The movie menu contains the following options:

Option	Description	Default	
Reset movie options	Reset movie menu options to their default values.	—	138
Frame rate	Choose a frame rate for slow-motion movies (62).	400 fps	138
Movie settings	Choose HD movie frame size and frame rate (58).	1080/60i	139
Metering	Choose how the camera meters exposure.	Matrix	123
Movie sound options	Choose sound recording options.	Microphone: Auto sensitivity (A) Wind noise reduction: On	140
Optical VR	Adjust settings for 1 NIKKOR lenses with vibration reduction.	Active/On ¹	127
Focus mode	Choose how the camera focuses.	See page 129	128
AF-area mode	Choose how the focus area is selected.	Auto-area ²	133
Face-priority	Turn face priority on or off.	On ³	135

1 Varies with lens (127).

2 The camera focuses on the subject in the center of the frame when **Slow motion** is selected in advanced movie mode.

3 Face detection is not available when **Slow motion** is selected in advanced movie mode.



Reset Movie Options

Select **Yes** to reset the options in the movie menu to default values (📖 137).

Frame Rate

Choose a frame rate for slow-motion movies (📖 62). The faster the frame rate, the smaller the frame size.

Option	Frame size (pixels)	Bit rate (approx.)	Maximum length (shooting)	Maximum length (playback)*
400 fps	640 × 240	2 Mbps	2.5 seconds	33 seconds
1200 fps	320 × 120	1 Mbps	2.5 seconds	100 seconds

* All figures are approximate. Slow-motion movies will play back over a period of about 13.2 (400 fps) or 40 (1200 fps) times the recording time.





See Also

For information on the total length of movies that can be stored on the memory card, see page 180.



Movie Settings

Choose a frame size and frame rate for HD movies (📖 58).

Option	Frame size (pixels)	Recording rate	Bit rate (approx.)	Maximum length
 1080/60i	1920 × 1080	59.94 fields/s*	24 Mbps	20 minutes
 1080/30p		29.97 fps	24 Mbps	
 720/60p	1280 × 720	59.94 fps	16 Mbps	29 minutes
 720/30p		29.97 fps	12 Mbps	

* Sensor output is about 60 fps.

Photo Frame Size

Photographs recorded by pressing the shutter-release button all the way down during movie recording have an aspect ratio of 16 : 9. The frame size varies with the option selected for **Movie settings**:

- **1080/60i and 1080/30p**: 3840 × 2160 pixels
- **720/60p and 720/30p**: 1280 × 720 pixels

See Also

For information on the total length of movies that can be stored on the memory card, see page 180.



Movie Sound Options

Adjust movie sound recording settings for the built-in microphone.

■ Microphone

Select **Microphone off** to disable sound recording. Selecting any other option enables recording and sets the microphone to the selected sensitivity.

The Icon

Movies recorded with the microphone off are indicated by a  icon in full-frame and movie playback.

■ Wind Noise Reduction

Select **On** to enable the low-cut filter, reducing noise produced by wind blowing over the microphone (note that other sounds may also be affected).



The Image Processing Menu

To display the image processing menu, press **MENU** and select **Image processing**.

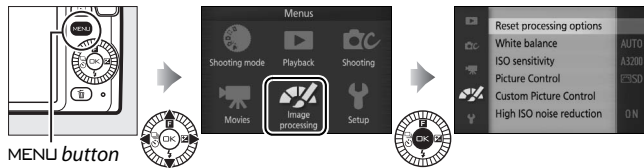

The image processing menu contains the following options:

Option	Description	Default	
Reset processing options	Reset image processing options to their default values.	—	142
White balance	Adjust settings for different types of lighting.	Auto	142
ISO sensitivity	Control the camera's sensitivity to light.	Auto (100–3200)	147
Picture Control	Choose how the camera processes pictures.	Standard	148
Custom Picture Control	Create custom Picture Controls.	—	152
High ISO noise reduction	Reduce noise at high ISO sensitivities.	On	154









Reset Processing Options

Select **Yes** to reset the options in the image processing menu to default values (☐ 141).

White Balance

White balance ensures that colors are unaffected by the color of the light source. Auto white balance is recommended for most light sources, but other values can be selected if necessary according to the type of source.

AUTO Auto	Automatic white balance adjustment. Recommended in most situations.
 Incandescent	Use under incandescent lighting.
 Fluorescent	Use with cool-white fluorescent lighting.
 Direct sunlight	Use with subjects lit by direct sunlight.
 Flash	Use with built-in flash.
 Cloudy	Use in daylight under overcast skies.
 Shade	Use in daylight with subjects in the shade.
 Underwater	Choose when taking pictures underwater using an optional WP-N2 waterproof case (☐ 163).
PRE Preset manual	Measure white balance (☐ 144).

White Balance and Shooting Mode

In auto and best moment capture modes and creative modes other than **P**, **S**, **A**, and **M**, and when  **Scene auto selector** (☐ 119) is chosen in Motion Snapshot mode, white balance is adjusted automatically according to the scene.



Fine-Tuning White Balance

Options other than **Preset manual** can be fine-tuned as follows:

1 Display fine-tuning options.

Highlight an option other than **Preset manual** and press **▶** to display the fine-tuning options shown at right.

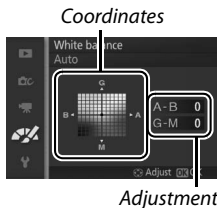

2 Fine-tune white balance.

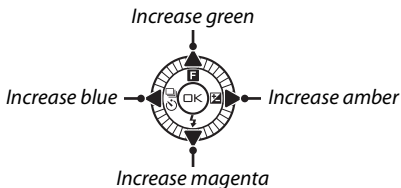

Use the multi selector to fine-tune white balance.



White Balance Fine Tuning

The colors on the fine-tuning axes are relative, not absolute. For example, moving the cursor to **B** (blue) when a “warm” setting such as  (incandescent) is selected will make photographs slightly “colder” but will not actually make them blue.

3 Save changes and exit.

Press **OK**. An asterisk will appear next to the white balance icon ( 4) in the detailed display ( 157) to show that white balance has been altered from default values.



Preset Manual

Preset manual is used to record and recall custom white balance settings for shooting under mixed lighting or to compensate for light sources with a strong color cast.

1 Light a reference object.

Place a neutral gray or white object under the lighting that will be used in the final photograph. A standard gray panel can be used for increased precision.

2 Select Preset manual.

Highlight **Preset manual** in the white balance menu and press **▶**. The dialog shown at right will be displayed; highlight **Yes** and press **OK** to overwrite the existing value for preset manual white balance.

The message shown at right will be displayed.

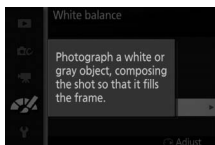
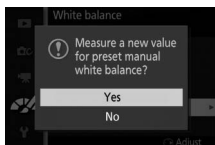

3 Measure white balance.

When the camera is ready to measure white balance, a flashing PRE will be displayed. Before the indicator stops flashing, frame the reference object so that it fills the display and press the shutter-release button all the way down. No photograph will be recorded; white balance can be measured accurately even when the camera is not in focus.

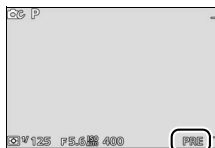

4 Check the results.

If the camera was able to measure a value for white balance, the message shown at right will be displayed. To return to shooting mode immediately, press the shutter-release button half-way.

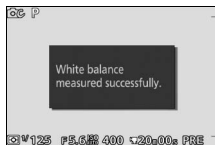

If lighting is too dark or too bright, the camera may be unable to measure white balance. The message at right will be displayed. Return to Step 3 and measure white balance again.

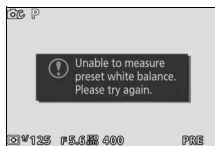

Auto Power Off





White balance measurement will end without a new value being acquired if no operations are performed for the time selected for **Auto power off** in the setup menu (☐ 158; the default is 1 minute).

Preset White Balance

The camera can store only one value for preset white balance at a time; the existing value will be replaced when a new value is measured. Note that exposure is automatically increased by 1 EV when measuring white balance; in mode **M**, adjust exposure so that the exposure indicator shows ± 0 (☐ 39).

Color Temperature

The perceived color of a light source varies with the viewer and other conditions. Color temperature is an objective measure of the color of a light source, defined with reference to the temperature to which an object would have to be heated to radiate light in the same wavelengths. While light sources with a color temperature in the neighborhood of 5000–5500 K appear white, light sources with a lower color temperature, such as incandescent light bulbs, appear slightly yellow or red. Light sources with a higher color temperature appear tinged with blue. The camera white balance options are adapted to the following color temperatures (all figures are approximate):

- | | |
|---|--|
| • Sodium-vapor lamps: 2700 K | •  (direct sunlight): 5200 K |
| •  (incandescent)/ | •  (flash): 5400 K |
| Warm-white fluorescent: 3000 K | •  (cloudy): 6000 K |
| • White fluorescent: 3700 K | • Daylight fluorescent: 6500 K |
| • Cool-white fluorescent: 4200 K | • Mercury-vapor lamps: 7200 K |
| • Day white fluorescent: 5000 K | •  (shade): 8000 K |



ISO Sensitivity

The higher the ISO sensitivity, the less light needed to make an exposure, allowing faster shutter speeds or smaller apertures, but the more likely the image is to be affected by “noise” in the form of randomly-spaced bright pixels, fog, or lines.

A6400 Auto (100–6400) A3200 Auto (100–3200) A800 Auto (100–800)	The camera adjusts ISO sensitivity in response to lighting conditions. ISO sensitivity is adjusted in the range given in brackets; choose larger ranges for increased sensitivity when lighting is poor, smaller ranges to reduce noise.
100, 200, 400, 800, 1600, 3200, 6400	ISO sensitivity is fixed at the selected value.





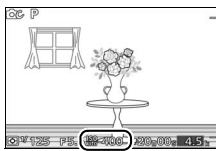

“Auto” ISO Sensitivity Options

When auto ISO sensitivity control is in effect, the display shows an **ISO AUTO** icon and the current ISO sensitivity.



Picture Control

Choose how the camera processes photographs.

 SD Standard	Standard processing for balanced results. Recommended in most situations.
 NL Neutral	Minimal processing for natural results. Choose for photographs that will later be extensively processed or retouched.
 VI Vivid	Pictures are enhanced for a vivid, photoprint effect. Choose for photographs that emphasize primary colors.
 MC Monochrome	Take monochrome photographs.
 PT Portrait	Process portraits for natural texture and a rounded feel.
 LS Landscape	Take vibrant photographs of landscapes and cityscapes.

Modifying Picture Controls

Existing preset and custom Picture Controls (📖 152) can be modified to suit the scene or your creative intent.

1 Display options.

Highlight an item in the Picture Control menu and press ► to display Picture Control settings (📖 150; the settings available with custom Picture Controls are the same as the preset controls on which they are based). To use an unmodified Picture Control, highlight it and press .

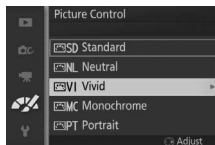

2 Adjust settings.

Press ▲ or ▼ to highlight the desired setting and press ◀ or ▶ to choose a value. Repeat this step until all settings have been adjusted, or select





Quick adjust to choose a preset combination of settings. Default settings can be restored by pressing the  button.



3 Save changes and exit.

Press .

Preset Picture Controls Versus Custom Picture Controls



The Picture Controls supplied with the camera are referred to as *preset Picture Controls*. *Custom Picture Controls* are created through modifications to existing Picture Controls using the **Custom Picture Control** option in the image processing menu ( 152). If desired, custom Picture Controls can be saved to a memory card and copied to other Nikon 1 S1 cameras or loaded into compatible software ( 153).

Modified Picture Controls

Picture Controls that have been modified from default settings are indicated by asterisks (“*”) next to the Picture Control name and icon in the Picture Control menu ( 148) and next to the Picture Control icon ( 4) in the detailed display ( 157).



Picture Control and Shooting Mode

In auto and best moment capture modes and creative modes other than **P**, **S**, **A**, and **M**, and when  **Scene auto selector** ( 119) is chosen in Motion Snapshot mode, the camera automatically chooses a Picture Control according to the scene.



Picture Control Settings

Quick adjust		Choose from options between -2 and +2 to reduce or exaggerate the effect of the selected Picture Control (note that this resets all manual adjustments). For example, choosing positive values for Vivid makes pictures more vivid. Not available with Neutral , Monochrome , or custom Picture Controls.
Manual adjustments (all Picture Controls)	Sharpening	Control the sharpness of outlines. Select A to adjust sharpening automatically according to the type of scene, or choose from values between 0 (no sharpening) and 9 (the higher the value, the greater the sharpening).
	Contrast	Select A to adjust contrast automatically according to the type of scene, or choose from values between -3 and +3 (lower values prevent highlights in portrait subjects from being “washed out” in direct sunlight, while higher values preserve detail in misty landscapes and other low-contrast subjects).
	Brightness	Choose -1 for reduced brightness, +1 for enhanced brightness. Does not affect exposure.
Manual adjustments (non-monochrome only)	Saturation	Control the vividness of colors. Select A to adjust saturation automatically according to the type of scene, or choose from values between -3 and +3 (lower values reduce saturation and higher values increase it).
	Hue	Choose negative values (to a minimum of -3) to make reds more purple, blues more green, and greens more yellow, positive values (up to +3) to make reds more orange, greens more blue, and blues more purple.
Manual adjustments (monochrome only)	Filter effects	Simulate the effect of color filters on monochrome photographs. Choose from Off , yellow, orange, red, and green (☞ 151).
	Toning	Choose the tint used in monochrome photographs from B&W (black-and-white), Sepia , Cyanotype (blue-tinted monochrome), Red , Yellow , Green , Blue Green , Blue , Purple Blue , and Red Purple (☞ 151).



✔ "A" (Auto)

Results for auto sharpening, contrast, and saturation vary with exposure and the position of the subject in the frame.

🔍 Previous Settings

The line under the value displayed in the Picture Control setting menu indicates the previous value for the setting. Use this as a reference when adjusting settings.



🔍 Filter Effects (Monochrome Only)

The options in this menu simulate the effect of color filters on monochrome photographs. The following filter effects are available:

Y (yellow)	Enhance contrast. Can be used to reduce the brightness
O (orange)	of the sky in landscape photographs. Orange produces
R (red)	more contrast than yellow, red more contrast than orange.
G (green)	Softens skin tones. Can be used for portraits.

Note that the effects achieved with **Filter effects** are more pronounced than those produced by physical glass filters.

🔍 Toning (Monochrome Only)

Pressing ▼ when **Toning** is highlighted displays saturation options. Press ◀ or ▶ to adjust saturation. Saturation control is not available when **B&W** (black-and-white) is selected.



Custom Picture Control

The Picture Controls supplied with the camera can be modified and saved as custom Picture Controls.

Edit/Save

To create a custom Picture Control, select **Edit/save** and follow the steps below.

1 Select a Picture Control.

Highlight an existing Picture Control and press **▶**, or press **OK** to proceed to Step 3 to save a copy of the highlighted Picture Control without further modification.

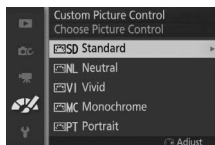

2 Edit the selected Picture Control.

See page 150 for more information. To abandon any changes and start over from default settings, press the **⌫** button. Press **OK** when settings are complete.

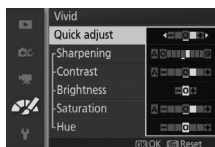

3 Save the Picture Control.

Highlight a destination (C-1 through C-9) and press **OK** to save the custom Picture Control and return to the image processing menu.

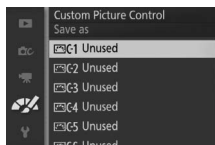

The new Picture Control will be listed in the **Picture Control** menu.

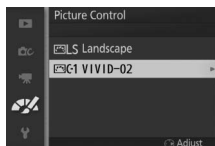

Load from/Save to Card

Custom Picture Controls created using the Picture Control Utility available with ViewNX 2 or optional software such as Capture NX 2 can be copied to a memory card and loaded into the camera, or custom Picture Controls created with the camera can be copied to the memory card to be used in other Nikon 1 S1 cameras and compatible software and then deleted when no longer needed.

To copy custom Picture Controls to or from the memory card, or to delete custom Picture Controls from the memory card, select **Load from/save to card** in the **Custom Picture Control** menu. The following options will be displayed:

Copy to camera	Copy custom Picture Controls from the memory card to custom Picture Controls C-1 through C-9.
Delete from card	Delete selected custom Picture Controls from the memory card. The confirmation dialog shown at right will be displayed before a Picture Control is deleted; to delete the selected Picture Control, highlight Yes and press OK .
Copy to card	Copy a custom Picture Control (C-1 through C-9) to a selected destination (1 through 99) on the memory card.

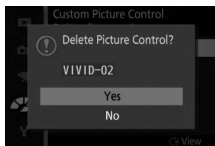

Copy to Card

Up to 99 custom Picture Controls can be stored on the memory card at any one time. The memory card can only be used to store user-created custom Picture Controls. The preset Picture Controls supplied with the camera can not be copied to the memory card or deleted.

Custom Picture Control > Delete

The **Delete** option in the **Custom Picture Control** menu can be used to delete selected custom Picture Controls from the camera when they are no longer needed.



High ISO Noise Reduction

Select **On** to reduce “noise” (randomly-spaced bright pixels, lines, or fog). If **Off** is selected, noise reduction will only be performed at high ISO sensitivities; the amount of noise reduction is less than that performed when **On** is selected.





The Setup Menu

To display the setup menu, press MENU and select **Setup**.

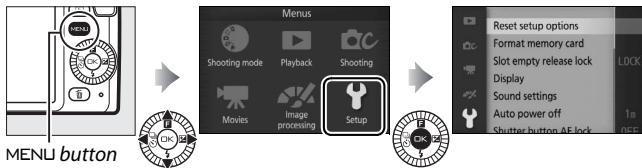

The setup menu contains the following options:

Option	Description	Default	
Reset setup options	Reset setup menu options to default values.	—	156
Format memory card	Format the memory card.	—	156
Slot empty release lock	Allow the shutter to be released when no memory card is inserted in the camera.	Release locked	157
Display	Adjust display brightness, view or hide a framing grid, and choose the information displayed in the monitor.	Display brightness: 0 Grid display: Off Shooting: Simple Playback: Basic info	157
Sound settings	Choose the sounds made during shooting.	Autofocus/self-timer: On Shutter: On	158
Auto power off	Choose the auto power off delay.	1 min	158
Shutter button AE lock	Choose whether exposure locks when the shutter-release button is pressed halfway.	Off	159
HDMI device control	Choose whether remote controls for HDMI-CEC devices to which the camera is connected can be used to operate the camera.	On	101



Option	Description	Default	
Flicker reduction	Reduce flicker or banding.	—	159
Reset file numbering	Reset file numbering.	—	159
Time zone and date	Set the camera clock.	Daylight saving time: Off	160
Language	Choose a language for the camera displays.	—	160
Auto image rotation	Record camera orientation with pictures.	On	161
Wireless mobile adapter	Enable or disable the wireless mobile adapter.	—	76
Pixel mapping	Check and optimize the camera image sensor and image processors.	—	162
Firmware version	Display the current firmware version.	—	162

Reset Setup Options

Select **Yes** to reset all setup menu options other than **Flicker reduction**, **Time zone and date**, and **Language** to default values.

Format Memory Card

Select **Yes** to format the memory card. *Note that this permanently deletes all data on the card, including protected images; before proceeding, be sure to copy important pictures and other data to a computer (📖 95).* To exit without formatting the memory card, highlight **No** and press .

The message shown at right is displayed while the card is formatted; *do not remove the memory card or remove or disconnect the power source until formatting is complete.*

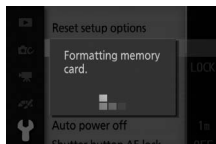

Slot Empty Release Lock

If **Enable release** is selected, the shutter can be released when no memory card is inserted. No pictures will be recorded, although they will be displayed in demo mode. Select **Release locked** to enable the shutter only when a card is inserted.

Display

Adjust the following display options.

Display Brightness

Press **▲** or **▼** to choose a value for monitor brightness. Choose higher values to brighten the display and lower values to make the display darker.

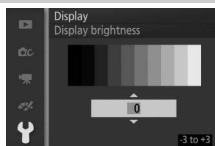

Grid Display

Select **On** to display a framing grid (📖 5).

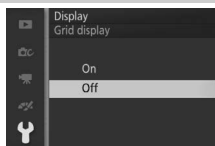

Shooting

Choose the information displayed during shooting (📖 4).

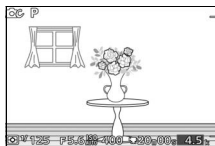

Simple

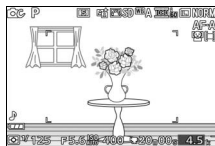

Detailed



Playback

Choose the information displayed during playback (📖 79).

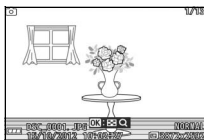

Basic info

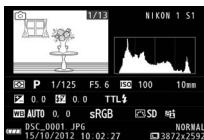

Detailed info

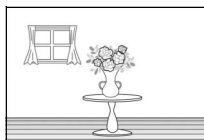
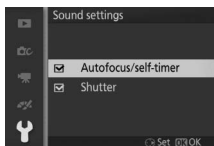

Image only

Sound Settings

Highlight items and press ► to select or deselect. If **Autofocus/self-timer** is selected, a beep will sound when the camera focuses and during self-timer photography; to mute the beep, remove the check from this item. Select **Shutter** to play a sound when the shutter is released, or remove the check from this item to mute the shutter. Press (OK) to exit when settings are complete.



Auto Power Off

Choose how long the display remains on when no operations are performed (📖 19). Choose shorter delays to reduce the drain on the battery. Once the display has turned off, it can be reactivated by pressing the shutter-release button.

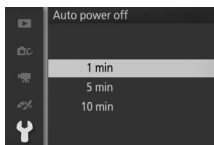

Shutter Button AE Lock

If **On** is selected, exposure will lock while the shutter-release button is pressed halfway.

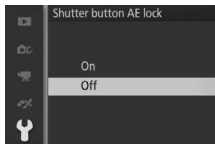

Flicker Reduction

Reduce flicker and banding in the display and in movies while shooting under fluorescent or mercury-vapor lighting. Choose a frequency which matches that of the local AC power supply.

Flicker Reduction

If you are unsure as to the frequency of the local power supply, test both options and choose the one that produces the best results. Flicker reduction may not produce the desired results if the subject is very bright, in which case you should select mode **A** or **M** and choose a smaller aperture (larger f-number).

Reset File Numbering

When a photograph is taken or a movie is recorded, the camera names the file by adding one to the number of the previous file (📄 121). If the current folder is numbered 999 and contains either 999 photographs or a photograph numbered 9999, the shutter-release button will be disabled and no further photographs can be taken. To reset file numbering to 0001, select **Yes** for **Reset file numbering** and then either format the current memory card or insert a new memory card.

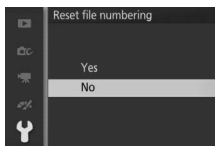

Time Zone and Date

Change time zones, set the camera clock, choose the date display order, or turn daylight saving time on or off (📖 20).

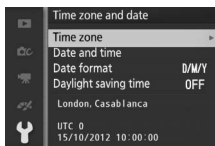

Time zone	Choose a time zone. The camera clock is automatically set to the time in the new time zone.
Date and time	Set the camera clock.
Date format	Choose the order in which the day, month, and year are displayed.
Daylight saving time	Turn daylight saving time on or off. The camera clock will automatically be advanced or set back one hour. The default setting is Off .

Language

Choose a language for camera messages and displays.



Auto Image Rotation

Photographs taken while **On** is selected contain information on camera orientation, allowing them to be rotated automatically during playback or when viewed in ViewNX 2 (supplied) or Capture NX 2 (available separately;  164). The following orientations are recorded:

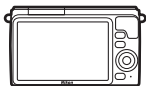

*Landscape (wide)
orientation*

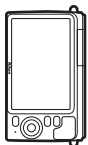

*Camera rotated 90°
clockwise*



*Camera rotated 90°
counterclockwise*

Camera orientation is not recorded when **Off** is selected. Choose this option when panning or taking photographs with the lens pointing up or down.

Auto Image Rotation

Image orientation is not recorded in movie or Motion Snapshot modes.

Rotate Tall

To automatically rotate "tall" (portrait-orientation) photographs for display during playback, select **On** for the **Rotate tall** option in the playback menu ( 110).



Pixel Mapping

Check and optimize the camera image sensor and image processors if you notice unexpected bright spots in your pictures (note that the camera comes with the sensor and processors already optimized). Before performing pixel mapping as described below, check that the battery is fully charged.

1 Attach a lens and lens cap.

Turn the camera off and attach a 1 NIKKOR lens. Do not remove the lens cap.

2 Select Pixel mapping.

Turn the camera on, press **MENU**, and select **Pixel mapping** in the setup menu.

3 Select Yes.

Pixel mapping begins immediately. Note that other operations can not be performed while pixel mapping is in progress. *Do not turn the camera off or remove or disconnect the power source until pixel mapping is complete.*

4 Turn the camera off.

Turn the camera off when pixel mapping is complete.

Firmware Version

View the current firmware version.



Technical Notes

Read this chapter for information on compatible accessories, cleaning and storing the camera, and what to do if an error message is displayed or you encounter problems using the camera.

Optional Accessories

At the time of writing, the following accessories were available for your camera.

Lenses	1 mount lenses
Mount adapters	Mount Adapter FT1: The FT1 allows NIKKOR F mount lenses to be used with Nikon 1 interchangeable lens format digital cameras. The angle of view of an F mount lens mounted on the FT1 is equivalent to that of a 35 mm format lens with a focal length about $2.7 \times$ longer. See page 198 for information on using the FT1. For information on attaching the FT1 and precautions for use, see the <i>FT1 Mount Adapter User's Manual</i> . For information on the lenses that can be used, see <i>Compatible NIKKOR F Mount Lenses</i> . The <i>FT1 Mount Adapter User's Manual</i> and <i>Compatible NIKKOR F Mount Lenses</i> are included with the FT1.
Power sources	<ul style="list-style-type: none">• Rechargeable Li-ion Battery EN-EL20 (☞ 13–15): Additional EN-EL20 batteries are available from local retailers and Nikon-authorized service representatives.• Battery Charger MH-27 (☞ 13): Recharge EN-EL20 batteries.• Power Connector EP-5C, AC Adapter EH-5b: These accessories can be used to power the camera for extended periods (EH-5a and EH-5 AC adapters can also be used). An EP-5C power connector is required to connect the camera to the EH-5b, EH-5a, or EH-5; see page 167 for details.
Waterproof cases	Waterproof Case WP-N2: In addition to protecting the camera from rain, snow, and spray, this waterproof case can be used to take photographs underwater.



Software	<p>Capture NX 2: A complete photo editing package offering such features as white balance adjustment and color control points.</p> <p>Note: Use the latest versions of Nikon software; see the web-sites listed on page xvii for the latest information on supported operating systems. At default settings, Nikon Message Center 2 will periodically check for updates to Capture NX 2 and other Nikon software and firmware while you are logged in to an account on the computer and the computer is connected to the Internet. A message is automatically displayed when an update is found.</p>
Body caps	<p>Body Cap BF-N1000: The body cap keeps the dust shield free of dust when a lens is not in place.</p>
Wireless mobile adapters	<p>Wireless Mobile Adapter WU-1b (☎ 76): Create a wireless connection that can be used by smart devices running the Wireless Mobile Utility to download pictures or control the camera remotely.</p>



Approved Memory Cards

The following cards have been tested and approved for use in the camera. Cards with class 6 or faster write speeds are recommended for movie recording. Recording may end unexpectedly when cards with slower write speeds are used.

	SD cards	SDHC cards ²	SDXC cards ³
SanDisk	2 GB ¹	4 GB, 8 GB, 16 GB, 32 GB	64 GB
Toshiba			
Panasonic			48 GB, 64 GB
Lexar Media	—	4 GB, 8 GB, 16 GB	—
Platinum II		4 GB, 8 GB, 16 GB, 32 GB	
Professional			
Full-HD Video			

- 1 Check that any card readers or other devices with which the card will be used support 2 GB cards.
- 2 Check that any card readers or other devices with which the card will be used are SDHC-compliant. The camera supports UHS-1.
- 3 Check that any card readers or other devices with which the card will be used are SDXC-compliant.  The camera supports UHS-1.





Other cards have not been tested. For more details on the above cards, please contact the manufacturer.



Approved Eye-Fi Cards

When inserted in the camera, Eye-Fi cards can be used to upload photographs to a preselected destination. As of October 2012, the camera supports 8 GB Pro X2 SDHC cards. Eye-Fi cards are for use only in the country of purchase in accordance with local regulations. Eye-Fi cards may not be available in some countries or regions; consult the manufacturer for more information. Be sure the Eye-Fi card firmware has been updated to the latest version.

Card status is indicated by an icon in the display:

-  (static): Eye-Fi upload enabled; waiting to begin upload.
-  (animated): Eye-Fi upload enabled; uploading data.
- : Eye-Fi upload enabled but no pictures available for upload.
- : Error.

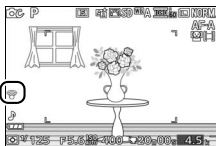

Eye-Fi Cards

Note that pictures will not be uploaded if signal strength is insufficient, and that Eye-Fi upload is disabled during movie recording. In locations in which wireless devices are prohibited, turn the camera off and remove the card. See the manual provided with the Eye-Fi card, and direct any inquiries to the manufacturer.



Attaching a Power Connector and AC Adapter

Turn the camera off before attaching an optional power connector and AC adapter.

1 Ready the camera.

Open the battery-chamber/memory card slot cover.

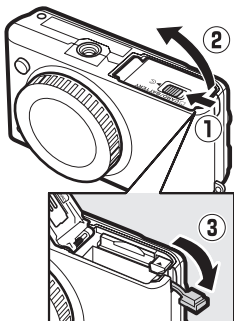

2 Insert the EP-5C power connector.

Be sure to insert the connector in the orientation shown, using the connector to keep the orange battery latch pressed to one side. The latch locks the connector in place when the connector is fully inserted.

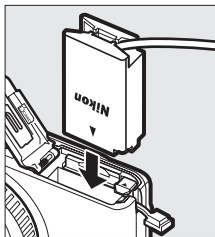

3 Close the battery-chamber/memory card slot cover.

Position the power connector cable so that it passes through the power connector slot and close the battery-chamber/memory card slot cover.

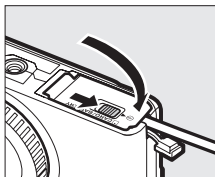

4 Connect the AC adapter.

Connect the AC adapter power cable to the AC socket on AC adapter (①) and the EP-5C power cable to the DC socket (②). A  icon is displayed in the monitor when the camera is powered by the AC adapter and power connector.

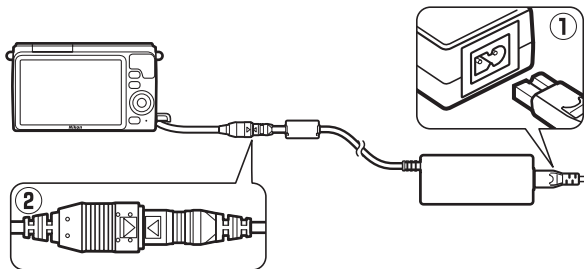

Storage and Cleaning

Storage

If the camera will not be used for an extended period, remove the battery and store it in a cool, dry area with the terminal cover in place. To prevent mold or mildew, store the camera in a dry, well-ventilated area. Do not store your camera with naphtha or camphor moth balls or in locations that:

- are poorly ventilated or subject to humidities of over 60%
- are next to equipment that produces strong electromagnetic fields, such as televisions or radios
- are exposed to temperatures above 50 °C (122 °F) or below -10 °C (14 °F)

Cleaning

Camera body	Use a blower to remove dust and lint, then wipe gently with a soft, dry cloth. After using the camera at the beach or sea-side, wipe off sand or salt with a cloth lightly dampened in distilled water and dry thoroughly. Important: <i>Dust or other foreign matter inside the camera may cause damage not covered under warranty.</i>
Lens	Lenses are easily damaged. Remove dust and lint with a blower. If using an aerosol blower, keep the can vertical to prevent the discharge of liquid. To remove fingerprints and other stains, apply a small amount of lens cleaner to a soft cloth and clean with care.
Monitor	Remove dust and lint with a blower. When removing fingerprints and other stains, wipe the surface lightly with a soft cloth or chamois leather. Do not apply pressure, as this could result in damage or malfunction.
Dust shield	The dust shield is easily damaged. Remove dust and lint with a blower.

Do not use alcohol, thinner, or other volatile chemicals.



Caring for the Camera and Battery: Cautions

Do not drop: The product may malfunction if subjected to strong shocks or vibration.

Keep dry: This product is not waterproof, and may malfunction if immersed in water or exposed to high levels of humidity. Rusting of the internal mechanism can cause irreparable damage.

Avoid sudden changes in temperature: Sudden changes in temperature, such as those that occur when entering or leaving a heated building on a cold day, can cause condensation inside the device. To prevent condensation, place the device in a carrying case or plastic bag before exposing it to sudden changes in temperature.

Keep away from strong magnetic fields: Do not use or store this device in the vicinity of equipment that generates strong electromagnetic radiation or magnetic fields. Strong static charges or the magnetic fields produced by equipment such as radio transmitters could interfere with the display, damage data stored on the memory card, or affect the product's internal circuitry.

Keep the lens mount covered: Be sure to attach the body cap if the camera is without a lens.

Do not touch the dust shield: The dust shield covering the image sensor is easily damaged. Under no circumstances should you exert pressure on the shield or poke it with cleaning tools. These actions could scratch or otherwise damage the shield.

Turn the product off before removing or disconnecting the power source: Do not unplug the product or remove the battery while the product is on or while images are being recorded or deleted. Forcibly cutting power in these circumstances could result in loss of data or in damage to product memory or internal circuitry. To prevent an accidental interruption of power, avoid carrying the product from one location to another while the AC adapter is connected.



Cleaning: When cleaning the camera body, use a blower to gently remove dust and lint, then wipe gently with a soft, dry cloth. After using the camera at the beach or seaside, wipe off any sand or salt using a cloth lightly dampened in pure water and then dry the camera thoroughly.

Lenses are easily damaged. Dust and lint should be gently removed with a blower. When using an aerosol blower, keep the can vertical to prevent discharge of liquid. To remove fingerprints and other stains from the lens, apply a small amount of lens cleaner to a clean, soft cloth and wipe the lens carefully.

Storage: To prevent mold or mildew, store the camera in a dry, well-ventilated area. If you are using an AC adapter, unplug the adapter to prevent fire. If the product will not be used for an extended period, remove the battery to prevent leakage and store the camera in a plastic bag containing a desiccant. Do not, however, store the camera case in a plastic bag, as this may cause the material to deteriorate. Note that desiccant gradually loses its capacity to absorb moisture and should be replaced at regular intervals.

To prevent mold or mildew, take the camera out of storage at least once a month. Turn the camera on and release the shutter a few times before putting it away.

Store the battery in a cool, dry place. Replace the terminal cover before putting the battery away.

Notes on the monitor: The monitor is constructed with extremely high precision; at least 99.99% of pixels are effective, with no more than 0.01% being missing or defective. Hence while these displays may contain pixels that are always lit (white, red, blue, or green) or always off (black), this is not a malfunction and has no effect on images recorded with the device.

Images in the monitor may be difficult to see in a bright light.

Do not apply pressure to the display, as this could cause damage or malfunction. Dust or lint on the display can be removed with a blower. Stains can be removed by wiping lightly with a soft cloth or chamois leather. Should the monitor break, care should be taken to avoid injury from broken glass and to prevent liquid crystal from the display touching the skin or entering the eyes and mouth.



Do not leave the lens pointed at the sun: Do not leave the lens pointed at the sun or other strong light source for an extended period. Intense light may cause the image sensor to deteriorate or produce a white blur effect in photographs.

Moiré: Moiré is an interference pattern created by the interaction of an image containing a regular, repeating grid, such as the pattern of weave in cloth or windows in a building, with the camera image sensor grid. In some cases, it may appear in the form of lines. If you notice moiré in your photographs, try changing the distance to the subject, zooming in and out, or changing the angle between the subject and the camera.

Lines: Noise in the form of lines may in rare cases appear in pictures of extremely bright or backlit subjects.

Batteries: Batteries may leak or explode if improperly handled. Observe the following precautions when handling batteries:

- Use only batteries approved for use in this equipment.
- Do not expose the battery to flame or excessive heat.
- Keep the battery terminals clean.
- Turn the product off before replacing the battery.
- Remove the battery from the camera or charger when not in use and replace the terminal cover. These devices draw minute amounts of charge even when off and could draw the battery down to the point that it will no longer function. If the battery will not be used for some time, insert it in the camera and run it flat before removing it and storing it in a location with an ambient temperature of 15 °C to 25 °C (59 °F to 77 °F; avoid hot or extremely cold locations). Repeat this process at least once every six months.
- Turning the camera on and off repeatedly when the battery is fully discharged will shorten battery life. Batteries that have been fully discharged must be charged before use.
- The internal temperature of the battery may rise while the battery is in use. Attempting to charge the battery while the internal temperature is elevated will impair battery performance, and the battery may not charge or charge only partially. Wait for the battery to cool before charging.
- Continuing to charge the battery after it is fully charged can impair battery performance.



- A marked drop in the time a fully charged battery retains its charge when used at room temperature indicates that it requires replacement. Purchase a new EN-EL20 battery.
- Charge the battery before use. When taking photographs on important occasions, ready a spare EN-EL20 battery and keep it fully charged. Depending on your location, it may be difficult to purchase replacement batteries on short notice. Note that on cold days, the capacity of batteries tends to decrease. Be sure the battery is fully charged before taking photographs outside in cold weather. Keep a spare battery in a warm place and exchange the two as necessary. Once warmed, a cold battery may recover some of its charge.
- Used batteries are a valuable resource; recycle in accord with local regulations.

Servicing the Camera and Accessories





The camera is a precision device and requires regular servicing. Nikon recommends that the camera be inspected by the original retailer or Nikon-authorized service representative once every one to two years, and that it be serviced once every three to five years (note that fees apply to these services). Frequent inspection and servicing are particularly recommended if the camera is used professionally. Any accessories regularly used with the camera, such as lenses, should be included when the camera is inspected or serviced.



Available Settings

The following table lists the settings that can be adjusted in each mode.

Auto, Best Moment Capture, Advanced Movie, and Motion Snapshot Modes

												
			P	S	A	M	<small>SCENE</small>	P	S	A	M	
Shooting, movie, and image processing menus	Exposure mode	—	—	—	—	—	—	✓	✓	✓	✓	✓
	Image quality	✓ ¹	✓	—	—	—	—	—	—	—	—	—
	Image size ²	✓ ¹	✓	—	—	—	—	—	—	—	—	—
	Number of shots saved	—	✓ ³	—	—	—	—	—	—	—	—	—
	Movie before/after	—	—	—	—	—	—	✓	✓	✓	✓	✓
	File format	—	—	—	—	—	—	✓	✓	✓	✓	✓
	Metering	—	—	✓ ⁴	✓ ⁴	✓ ⁴	✓ ⁴	—	✓	✓	✓	✓
	Auto distortion control	✓ ¹	✓	—	—	—	—	—	—	—	—	—
	Color space	✓ ¹	✓	—	—	—	—	—	—	—	—	—
	Active D-Lighting	—	—	—	—	—	—	—	—	—	—	—
	HDR	—	—	—	—	—	—	—	—	—	—	—
	Long exposure NR	✓	—	—	—	—	—	—	—	—	—	—
	Optical VR ⁵	✓	✓	✓	✓	✓	✓	✓	✓	✓	✓	✓
	Electronic VR	—	—	—	—	—	—	✓	✓	✓	✓	✓
	Focus mode	—	—	✓	✓	✓	✓	—	—	—	—	—
	AF-area mode	—	—	✓ ⁴	✓ ⁴	✓ ⁴	✓ ⁴	—	✓	✓	✓	✓
	Face-priority	—	—	✓ ⁴	✓ ⁴	✓ ⁴	✓ ⁴	—	✓	✓	✓	✓
	Built-in AF assist	✓	✓	—	—	—	—	✓	✓	✓	✓	✓
	Flash compensation	—	—	—	—	—	—	—	—	—	—	—
Frame rate ⁶	—	—	—	—	—	—	—	—	—	—	—	



				P	S	A	M		P	S	A	M
Image processing menus	Shooting, movie, and	✓	—	✓ ⁴	✓ ⁴	✓ ⁴	✓ ⁴	—	—	—	—	—
	Movie settings	✓	—	✓ ⁴	✓ ⁴	✓ ⁴	✓ ⁴	—	—	—	—	—
	Movie sound options	—	—	✓	✓	✓	✓	—	✓	✓	✓	✓
	White balance	—	—	✓	✓	✓	✓	—	✓	✓	✓	✓
	ISO sensitivity	—	—	✓	✓	✓	✓	—	✓	✓	✓	✓
	Picture Control	—	—	✓	✓	✓	✓	—	✓	✓	✓	✓
	Custom Picture Control	—	—	✓	✓	✓	✓	—	✓	✓	✓	✓
High ISO noise reduction	✓	✓	✓	✓	✓	✓	✓	✓	✓	✓	✓	
Other settings	Focus area selection	—	—	✓ ⁴	✓ ⁴	✓ ⁴	✓ ⁴	—	✓	✓	✓	✓
	Flexible program	—	—	—	—	—	—	—	—	—	—	—
	Autoexposure lock	—	—	✓	✓	✓	—	—	✓	✓	✓	—
	Focus lock	—	—	✓	✓	✓	✓	—	✓	✓	✓	✓
	Continuous ⁷	✓	—	—	—	—	—	—	—	—	—	—
	Self-timer ⁷	✓	—	✓	✓	✓	✓	—	—	—	—	—
	Exposure compensation	✓	—	✓	✓	✓	—	—	✓	✓	✓	—
	Flash mode	✓	—	—	—	—	—	—	—	—	—	—
	Advanced movie	—	—	✓	✓	✓	✓	—	—	—	—	—
Theme	—	—	—	—	—	—	✓	✓	✓	✓	✓	

1 Has no effect on movies recorded with movie-record button.

2 RAW images fixed at 3872 × 2592 pixels.

3 Smart Photo Selector mode only.

4 Not available when **Slow motion** is selected in advanced movie mode (□ 62).







5 VR lenses only.







6 **Slow motion** selected in advanced movie mode.

7 Continuous and self-timer can not be used together.









CC Creative Mode

In the table below, creative modes are represented by the following icons:  night landscape,  night portrait,  backlighting,  soft,  miniature effect, and  selective color.

	P	S	A	M						
Exposure mode	—	—	—	—	—	—	—	—	—	—
Image quality	✓ ¹	✓ ¹	✓ ¹	✓ ¹	✓ ^{1,2}	✓ ^{1,2}	✓ ^{1,2}	✓ ^{1,2}	✓ ^{1,2}	✓ ^{1,2}
Image size	✓ ^{1,3}	✓ ^{1,3}	✓ ^{1,3}	✓ ^{1,3}	✓ ¹	✓ ¹	✓ ¹	✓ ¹	✓ ¹	✓ ¹
Number of shots saved	—	—	—	—	—	—	—	—	—	—
Movie before/after	—	—	—	—	—	—	—	—	—	—
File format	—	—	—	—	—	—	—	—	—	—
Metering	✓ ¹	✓ ¹	✓ ¹	✓ ¹	—	—	—	—	—	—
Auto distortion control	✓ ¹	✓ ¹	✓ ¹	✓ ¹	✓ ¹	✓ ¹	✓ ¹	✓ ¹	✓ ¹	✓ ¹
Color space	✓ ¹	✓ ¹	✓ ¹	✓ ¹	✓ ¹	✓ ¹	✓ ¹	✓ ¹	✓ ¹	✓ ¹
Active D-Lighting	✓ ¹	✓ ¹	✓ ¹	✓ ¹	—	—	—	—	—	—
HDR	—	—	—	—	—	—	✓	—	—	—
Long exposure NR	✓ ⁴	✓ ⁴	✓ ⁴	✓ ⁴	—	—	—	—	—	—
Optical VR ⁵	✓	✓	✓	✓	✓	✓	✓	✓	✓	✓
Electronic VR	—	—	—	—	—	—	—	—	—	—
Focus mode	✓ ¹	✓ ¹	✓ ¹	✓ ¹	—	—	—	—	—	—
AF-area mode	✓ ¹	✓ ¹	✓ ¹	✓ ¹	—	—	—	—	—	—
Face-priority	✓	✓	✓	✓	—	—	—	—	—	—
Built-in AF assist	✓	✓	✓	✓	✓	✓	✓	✓	✓	✓
Flash compensation	✓ ⁴	✓ ⁴	✓ ⁴	✓ ⁴	—	✓	✓ ⁶	✓	✓	✓
Frame rate	—	—	—	—	—	—	—	—	—	—
Movie settings	✓	✓	✓	✓	✓	✓	✓	✓	✓	✓
Movie sound options	✓	✓	✓	✓	✓	✓	✓	✓	✓	✓
White balance	✓	✓	✓	✓	—	—	—	—	—	—
ISO sensitivity	✓ ¹	✓ ¹	✓ ¹	✓ ¹	—	—	—	—	—	—
Picture Control	✓	✓	✓	✓	—	—	—	—	—	—
Custom Picture Control	✓	✓	✓	✓	—	—	—	—	—	—
High ISO noise reduction	✓	✓	✓	✓	—	—	—	—	—	—

Shooting, movie, and image processing menus



		P	S	A	M						
Other settings	Focus area selection	✓	✓	✓	✓	—	—	—	—	—	—
	Flexible program	✓ ¹	—	—	—	—	—	—	—	—	—
	Autoexposure lock	✓	✓	✓	—	✓	✓	✓	✓	✓	✓
	Focus lock	✓	✓	✓	✓	✓	✓	✓	✓	✓	✓
	Continuous ⁷	✓	✓	✓	✓	—	—	—	—	—	—
	Self-timer ⁷	✓ ⁴	✓ ⁴	✓ ⁴	✓ ⁴	✓	✓	✓	✓	✓	✓
	Exposure compensation	✓	✓	✓	—	✓	✓	✓	✓	✓	✓
	Flash mode	✓ ⁴	✓ ⁴	✓ ⁴	✓ ⁴	—	✓	✓ ⁶	✓	✓	✓
	Advanced movie	—	—	—	—	—	—	—	—	—	—
	Theme	—	—	—	—	—	—	—	—	—	—

1 Has no effect on movies recorded with movie-record button.

2 NEF (RAW) not available.

3 RAW images fixed at 3872 × 2592 pixels.

4 Not available when 15, 30, or 60 fps is selected for self-timer/continuous.

5 VR lenses only.

6 Not available when **HDR** is on.

7 Continuous and self-timer can not be used together.



Defaults

Defaults for the options in the playback, shooting, movie, image processing, and setup menus may be found on pages 107, 117, 137, 141, and 155, respectively. Defaults for other settings are listed below.

Option	Default
Focus area (☐ 133)	Center*
Flexible program (☐ 36)	Off
Focus lock (☐ 134)	Off
Continuous/self-timer (☐ 67)	☑ (single frame)
Exposure compensation (☐ 71)	0.0
Flash mode (☐ 73)	Auto, Soft, Miniature effect, Selective color: Auto Night portrait: Red-eye reduction P Programmed auto, S Shutter-priority auto, A Aperture-priority auto, M Manual, Backlighting: Fill flash
Best moment capture (☐ 45)	Slow view
Advanced movie (☐ 57)	P Programmed auto
Theme (☐ 55)	Beauty
Picture Control settings (☐ 148)	Unmodified

*Not displayed when **Auto-area** is selected for **AF-area mode**.



Memory Card Capacity

The following table shows the number of pictures or amount of movie footage that can be stored on a 16 GB Toshiba SD-E016GUX UHS-I SDHC card at different image quality, size, or movie settings. All figures are approximate; file size varies with the scene recorded.

■ Auto, Creative, Slow View, and Smart Photo Selector¹

Image quality (□ 120)	Image size (□ 120)	File size	No. of images	Buffer capacity ²
NEF (RAW) ³	—	12.9 MB	1200	17
JPEG fine	3872×2592	6.8 MB	2200	18
	2896×1944	4.3 MB	3600	21
	1936×1296	2.5 MB	6200	25
JPEG normal	3872×2592	3.5 MB	4500	22
	2896×1944	2.2 MB	7000	26
	1936×1296	1.3 MB	11900	33
JPEG basic	3872×2592	1.8 MB	8800	30
	2896×1944	1.1 MB	13600	37
	1936×1296	0.7 MB	22800	45

1 Number of shots saved set to 1.

2 Maximum number of pictures that can be stored in memory buffer at ISO 100. Drops if long exposure noise reduction is on (□ 127) and at frame rates of 15, 30, and 60 fps (□ 67).

3 Available in P, S, A, M mode only.

■ Smart Photo Selector*

Image quality (□ 120)	Image size (□ 120)	File size	No. of shots
NEF (RAW)	—	64.3 MB	244
JPEG fine	3872×2592	34.2 MB	460
	2896×1944	21.5 MB	730
	1936×1296	12.6 MB	1200
JPEG normal	3872×2592	17.3 MB	910
	2896×1944	11.0 MB	1400
	1936×1296	6.5 MB	2400
JPEG basic	3872×2592	8.8 MB	1700
	2896×1944	5.7 MB	2700
	1936×1296	3.5 MB	4500

* Number of shots saved set to 5. File size is total for 5 images.



■ HD Movies

Movie settings (□ 139)	Maximum total length (approx.)*
1080/60i	1 hours 28 minutes
1080/30p	1 hours 28 minutes
720/60p	2 hours 12 minutes
720/30p	2 hours 56 minutes

*For information on the maximum length that can be recorded in a single clip, see page 139.

■ Slow-Motion Movies

Frame rate (□ 138)	Maximum total recorded length (approx.)*
400 fps	1 hours 4 minutes
1200 fps	2 hours 8 minutes

*Up to 2.5 s of slow-motion footage can be recorded in a single clip. Playback length is about 13.2 (**400 fps**) or 40 (**1200 fps**) times the recorded length.

■ Motion Snapshots

Image quality	Image size	Format (□ 123)	File size	No. of shots
—	—	NMS	13.7 MB *	1100
—	—	MOV	16.5 MB	951

* File size is the total for a single photograph and movie.



Troubleshooting

If the camera fails to function as expected, check this list of common problems before consulting your retailer or Nikon representative.

Battery/Display

The camera is on but does not respond: Wait for recording or any other processing to end. If the problem persists, turn the camera off. If the camera still does not respond, remove and replace the battery or disconnect and reconnect the AC adapter, but note that this will delete any data not yet saved. Data already saved to the memory card are unaffected.

The display is off:

- The camera is off (☐ 19) or the battery is exhausted (☐ 13, 22).
 - The display has turned off automatically to save power (☐ 158). The display can be reactivated by pressing the shutter-release button.
 - The camera is connected to a computer (☐ 95) or television (☐ 100).
-

The camera turns off without warning:

- The battery is low (☐ 13, 22).
 - The display has turned off automatically to save power (☐ 158). The display can be reactivated by pressing the shutter-release button.
 - The camera's internal temperature is high (☐ xvi, 187). Wait for the camera to cool before turning it on again.
-

Indicators are not displayed: Use the **Display > Shooting** and **Display > Playback** options in the setup menu to choose the information displayed (☐ 157).



Shooting (All Modes)

The camera takes time to turn on: Delete files or format the memory card.

The shutter-release is disabled:

- The battery is exhausted (☐ 13, 22).
- The memory card is locked (☐ 16) or full (☐ 22).
- The flash is charging (☐ 72).
- The camera is not in focus (☐ 24).
- You are currently filming a slow-motion movie (☐ 61).

Only one picture is taken each time the shutter-release button is pressed in continuous release mode: **5 fps** is selected for **Continuous/self-timer** and the built-in flash is raised.

The camera does not focus automatically:

- The subject is not suited to autofocus (☐ 130).
- The camera is in manual focus mode (☐ 128, 131).

Focus does not lock when the shutter-release button is pressed halfway: Set the focus mode to **AF-S** (☐ 128, 134).

Focus area selection is unavailable: Focus area selection is not available in auto-area AF (☐ 133) or face priority (☐ 26). In other AF-area modes, the focus area can be selected by pressing .

AF-area mode selection is unavailable: The camera is in auto or best moment capture mode (☐ 45), an option other than **P, S, A, M** is selected in creative mode (☐ 33), manual focus mode is selected (☐ 128), or the  **Scene auto selector** is used (☐ 119).

Image size selection is unavailable: **NEF (RAW)** is selected for image quality (☐ 120).

The camera is slow to record photos: Turn long exposure noise reduction off (☐ 127). In creative mode, additional time may be needed to record photos when **Night landscape** (☐ 34) or **Night portrait** (☐ 35) is selected or when **Backlighting** is selected and **HDR** is on (☐ 42).

Noise (bright spots, randomly-spaced bright pixels, fog, or lines) appears in photos:

- Lower ISO sensitivity or enable high ISO noise reduction (☐ 147).
- Use long exposure noise reduction at shutter speeds slower than 1 s (☐ 127).

Smudges appear in photographs: Clean the front and rear lens elements or the dust shield (☐ 169).



Flicker or banding appears in movies or in the display: Choose a **Flicker reduction** setting that matches the local AC power supply (□ 159).

No flash: See page 75. The flash will not fire when off (□ 73); in **P, S, A,** and **M** modes, the flash will not fire when lowered.

Menu items are unavailable: Some options are only available in particular shooting or exposure modes (□ 174) or when the built-in flash is raised (□ 72) or wireless mobile adapter is attached (□ 76).

Shooting (P, S, A, and M Modes)

The shutter release is disabled: You selected mode **S** after choosing a shutter speed of “Bulb” in mode **M** (□ 37).

Some shutter speeds are not available: You are using the flash.

Colors are unnatural:

- Adjust white balance to match the light source (□ 142).
- Adjust Picture Control settings (□ 148).

Cannot measure white balance: The subject is too dark or too bright (□ 145).

Picture Controls produce varying results: **A** (auto) is selected for sharpening, contrast, or saturation. For consistent results over a series of photos, choose another setting (□ 150, 151).

Noise (reddish areas and other artifacts) appears in long time-exposures: Enable long exposure noise reduction (□ 127).

Movies

Cannot record movies: The movie-record button can not be used to record movies in best moment capture or Motion Snapshot mode (□ 49, 55).

No sound is recorded for movies:

- **Microphone off** is selected for **Movie sound options > Microphone** (□ 140).
- Live audio is not recorded with slow-motion movies (□ 62) or Motion Snapshots (□ 53).



Playback

“Tall” (portrait) orientation photos are displayed in “wide” (landscape) orientation:

- Select **On** for **Rotate tall** (☐ 110).
- The photos were taken with **Auto image rotation** off (☐ 161).
- Camera was pointed up or down when the photo was taken (☐ 161).
- Photo is displayed in image review (☐ 110).

Cannot hear movie sound:

- Rotate the multi selector clockwise to raise the volume (☐ 65). If the camera is connected to a television (☐ 100), use the controls for the TV to adjust the volume.
- Live audio is not recorded with slow-motion movies (☐ 62) or Motion Snapshots (☐ 55).

Cannot delete images:

- Remove protection from the files before deletion (☐ 110).
- The memory card is locked (☐ 16).

Cannot select photos for printing: The memory card is full (☐ 22) or locked (☐ 16) or the photos are in NEF (RAW) format. To print NEF (RAW) photos, transfer the pictures to a computer and use the supplied software or Capture NX 2 (☐ 95).

Pictures are not displayed on TV: The camera is not correctly connected (☐ 100).

Pictures cannot be transferred to a computer: If your system does not meet the requirements on page 93, you may still be able to transfer pictures to the computer using a card reader.

Photos are not displayed in Capture NX 2: Update to the latest version (☐ 164).

Miscellaneous

The date of recording is not correct: Set the camera clock (☐ 20, 160).

Menu items are unavailable: Some options are only available at particular settings (☐ 174) or when a memory card is inserted (☐ 15).



Error Messages

This section lists the error messages that appear in the display.

Message	Solution	
(Shutter-speed or aperture display flashes)	If the subject is too bright, lower ISO sensitivity or choose a faster shutter speed or smaller aperture (higher f-number).	37, 38, 39, 147
	If the subject is too dark, raise ISO sensitivity, use the flash, or choose a slower shutter speed or larger aperture (lower f-number).	37, 38, 39, 72, 147
Keeping the zoom ring button pressed, rotate the zoom ring to extend the lens.	A lens with a retractable lens barrel button is attached with the lens barrel retracted. Press the retractable lens barrel button and rotate the zoom ring to extend the lens.	18, 195
Check lens. Pictures can only be taken when a lens is attached.	Attach a lens.	18
Cannot take pictures. Insert fully-charged battery.	Turn the camera off and recharge the battery or insert a fully charged spare battery.	13, 15
Start-up error. Turn the camera off and then on again.	Turn the camera off, remove and replace the battery, and then turn the camera on.	15, 19
The clock has been reset.	Set the camera clock.	20, 160
No memory card.	Turn the camera off and confirm that the card is correctly inserted.	15
This memory card is not formatted. Format the memory card?	Select Yes to format the card, or turn the camera off and insert another memory card.	15, 156



Message	Solution	
Memory card is locked (write protected).	Turn the camera off and slide the card write-protect switch to the "write" position.	16
Eye-Fi cards cannot be used with the write-protect switch in the "lock" position.		
Memory card is full.	<ul style="list-style-type: none"> You may be able to record additional images if you reduce image quality or size. 	120
	<ul style="list-style-type: none"> Delete unwanted images. Insert another memory card. 	85 15, 165
	<ul style="list-style-type: none"> Use an approved card. Format the card. If the problem persists, the card may be damaged. Contact a Nikon-authorized service representative. Insert a new memory card. 	165 156 15, 165
This memory card cannot be used. Card may be damaged; insert a different card.	<ul style="list-style-type: none"> Use an approved card. Format the card. If the problem persists, the card may be damaged. Contact a Nikon-authorized service representative. Insert a new memory card. 	15, 165
Cannot create additional folders on memory card.	If the current folder is numbered 999 and contains either 999 photographs or a photograph numbered 9999, the shutter-release button will be disabled and no further photographs can be taken. Choose Yes for Reset file numbering and then either format the current memory card or insert a new memory card.	159
The movie-record button cannot be used in this mode.	The movie-record button can not be used in best moment capture or Motion Snapshot modes.	49, 55
Photographs cannot be recorded in this mode.	The shutter-release button can not be used to take photographs while a slow-motion movie is being recorded.	61
Photographs cannot be taken in shutter-priority auto mode at a shutter speed of "Bulb".	Choose a different shutter speed, or select mode M .	37, 39



Message	Solution	
Failed to update lens firmware. Try again after turning the camera off and on.	Turn the camera off and then on again and reattempt the update. If the problem persists or reoccurs frequently, contact a Nikon-authorized service representative.	—
An error has occurred. Press the shutter-release button again.	Press the shutter-release button. Contact a Nikon-authorized service representative if the problem persists or reoccurs frequently.	—
An error has occurred in the internal circuitry. Try again after turning the camera off and on.	Turn the camera off and then on again. If the problem persists or reoccurs frequently, contact a Nikon-authorized service representative.	—
The camera's internal temperature is high. The camera will now turn off.	Wait for the camera to cool.	xvi
Memory card contains no images.	To view pictures, insert a memory card containing images.	15
Cannot display this file.	The file has been created or modified on a computer or different make of camera, or is corrupt.	—
Check printer.	Check the printer.	—*
Check paper.	Select Resume after loading paper of the correct size.	—*
Paper jam.	Clear the jam and select Resume .	—*
Out of paper.	Insert paper and select Resume .	—*
Check ink supply.	Select Resume after checking the ink.	—*
Out of ink.	Replace the ink and select Resume .	—*

* See the printer manual for more information.



Specifications

Nikon 1 S1 Digital Camera

Type		
Type	Digital camera with support for interchangeable lenses	
Lens mount	Nikon 1 mount	
Effective angle of view	Approx. 2.7× lens focal length (35 mm format equivalent)	
Effective pixels	10.1 million	
Image sensor		
Image sensor	13.2 mm × 8.8 mm CMOS sensor (Nikon CX format)	
Storage		
Image size (pixels)	Still images (aspect ratio 3 : 2)	
	• 3872 × 2592	• 2896 × 1944
	• 1936 × 1296	
	Still images (aspect ratio 16 : 9)	
	• 3840 × 2160 (Motion Snapshot mode or 1080/60i, 1080/30p selected in advanced movie mode)	
	• 1280 × 720 (720/60p, 720/30p selected in advanced movie mode)	
File format	• NEF (RAW): 12-bit, compressed • JPEG: JPEG-Baseline compliant with fine (approx. 1:4), normal (approx. 1:8), or basic (approx. 1:16) compression	
Picture Control system	Standard, Neutral, Vivid, Monochrome, Portrait, Landscape; selected Picture Control can be modified; storage for custom Picture Controls	
Media	SD (Secure Digital), SDHC, and SDXC memory cards	
File system	DCF (Design Rule for Camera File System) 2.0, DPOF (Digital Print Order Format), Exif (Exchangeable Image File Format for Digital Still Cameras) 2.3, PictBridge	



Shooting modes	auto; creative, with a choice of the following options: P , S , A , M , night landscape, night portrait, backlighting, soft, miniature effect, and selective color; best moment capture (slow view and Smart Photo Selector), advanced movie (HD— P , S , A , M only—and slow motion), Motion Snapshot
Shutter	
Type	Electronic shutter
Speed	1/16,000–30 s in steps of 1/3 EV; Bulb Note: Bulb ends automatically after approximately 2 minutes
Flash sync speed	Synchronizes with shutter at X=1/60 s or slower
Release	
Mode	<ul style="list-style-type: none"> • Single frame, continuous • Self-timer
Frame advance rate	Approx. 5, 15, 30, or 60 fps
Self-timer	2 s, 5 s, 10 s
Exposure	
Metering	TTL metering using image sensor
Metering method	<ul style="list-style-type: none"> • Matrix • Center-weighted: Meters 4.5 mm circle in center of frame • Spot: Meters 2 mm circle centered on selected focus area
Mode	P programmed auto with flexible program; S shutter-priority auto; A aperture-priority auto; M manual; scene auto selector
Exposure compensation	-3 – +3 EV in increments of 1/3 EV
Exposure lock	Luminosity locked at metered value when shutter-release button is pressed halfway
ISO sensitivity (Recommended Exposure Index)	ISO 100–6400 in steps of 1 EV; auto ISO sensitivity control (ISO 100–6400, 100–3200, 100–800) available (user controlled in P , S , A , and M modes)
Active D-Lighting	On, off



Focus	
Autofocus	Hybrid autofocus (phase-detection/contrast-detect AF); AF-assist illuminator
Lens servo	<ul style="list-style-type: none"> • Autofocus (AF): Single AF (AF-S); continuous AF (AF-C); auto AF-S/AF-C selection (AF-A); full-time AF (AF-F) • Manual focus (MF)
AF-area mode	Single-point, auto-area, subject tracking
Focus area	<ul style="list-style-type: none"> • Single-point AF: 135 focus areas; the center 73 areas support phase-detection AF • Auto-area AF: 41 focus areas
Focus lock	Focus can be locked by pressing shutter-release button halfway (single AF)
Face priority	On, off
Flash	
Built-in flash	<ul style="list-style-type: none"> • Auto; Soft, Miniature effect, Selective color (Creative mode): Flash pops up automatically and fires as required • Night portrait, Backlighting (Creative mode): Flash pops up automatically and fires with every shot • P programmed auto, S shutter-priority auto, A aperture-priority auto, M manual (Creative mode): Manual pop-up
Guide Number (GN)	Approx. 5/16 (m/ft, ISO 100, 20 °C/68 °F)
Control	i-TTL flash control using image sensor
Mode	Auto, auto + red-eye reduction, fill flash, fill flash + slow sync, red-eye reduction, red-eye reduction + slow sync, rear-curtain sync, rear curtain + slow sync, off
Flash compensation	-3 +1 EV in increments of 1/3 EV
Flash-ready indicator	Lights when built-in flash unit is fully charged
White balance	Auto, incandescent, fluorescent, direct sunlight, flash, cloudy, shade, underwater, preset manual, all except preset manual with fine tuning



Movie	
Metering	TTL metering using image sensor
Metering method	<ul style="list-style-type: none"> • Matrix • Center-weighted: Meters 4.5 mm circle in center of frame • Spot: Meters 2 mm circle centered on selected focus area
Frame size (pixels)/ recording rate	HD movies (aspect ratio 16 : 9)
	<ul style="list-style-type: none"> • 1920 × 1080/60i (59.94 fields/s[*]) • 1920 × 1080/30p (29.97 fps) • 1280 × 720/60p (59.94 fps) • 1280 × 720/30p (29.97 fps)
	Slow-motion movies (aspect ratio 8 : 3)
	<ul style="list-style-type: none"> • 640 × 240/400 fps (plays at 30p/29.97 fps) • 320 × 120/1200 fps (plays at 30p/29.97 fps)
	Motion Snapshot (aspect ratio 16 : 9)
	1280 × 720/60p (59.94 fps) (plays at 24p/23.976 fps)
File format	MOV
Video compression	H.264/MPEG-4 Advanced Video Coding
Audio recording format	AAC
Audio recording device	Built-in stereo microphone; sensitivity adjustable
* Sensor output is about 60 fps.	
Monitor	7.5 cm (3-in.), approx. 460k-dot, TFT LCD with brightness adjustment
Playback	Full-frame and thumbnail (4, 9, or 72 images or calendar) playback with playback zoom, movie playback, slide show, histogram display, auto image rotation, and rating option
Interface	
USB	Hi-Speed USB
HDMI output	Type C mini-pin HDMI connector



Supported languages	Arabic, Bengali, Chinese (Simplified and Traditional), Czech, Danish, Dutch, English, Finnish, French, German, Greek, Hindi, Hungarian, Indonesian, Italian, Japanese, Korean, Norwegian, Persian, Polish, Portuguese (European and Brazilian), Romanian, Russian, Spanish, Swedish, Tamil, Thai, Turkish, Ukrainian, Vietnamese
Power source	
Battery	One rechargeable Li-ion EN-EL20 battery
AC adapter	EH-5b AC adapter; requires EP-5C power connector (available separately)
Tripod socket	
	1/4-in. (ISO 1222)
Dimensions/weight	
Dimensions (W × H × D)	Approx. 102.0 × 60.5 × 29.7 mm (4.0 × 2.4 × 1.2 in.), excluding projections
Weight	Approx. 240 g (8.5 oz) with battery and memory card but without body cap; approx. 197 g (6.9 oz), camera body only
Operating environment	
Temperature	0 °C–40 °C (+32 °F–104 °F)
Humidity	85% or less (no condensation)

- Unless otherwise stated, all figures are for a camera with a fully-charged battery operating at the temperature specified by the Camera and Imaging Products Association (CIPA): 23 ±3 °C (73.4 ±5.4 °F).
- Nikon reserves the right to change the specifications of the hardware and software described in this manual at any time and without prior notice. Nikon will not be held liable for damages that may result from any mistakes that this manual may contain.



MH-27 battery charger	
Rated input	AC 100–240 V, 50–60 Hz, 0.2 A
Rated output	DC 8.4 V/0.6 A
Supported batteries	Nikon EN-EL20 rechargeable Li-ion batteries
Charging time	Approx. 2 hours at an ambient temperature of 25 °C (77 °F) when no charge remains
Operating temperature	0 °C–40 °C (+32 °F–104 °F)
Dimensions (W × H × D)	Approx. 67.0 × 28.0 × 94.0 mm (2.6 × 1.1 × 3.7 in.), excluding plug adapter
Weight	Approx. 83 g (2.9 oz), excluding plug adapter
EN-EL20 rechargeable Li-ion battery	
Type	Rechargeable lithium-ion battery
Rated capacity	7.2 V, 1020 mAh
Operating temperature	0 °C–40 °C (+32 °F–104 °F)
Dimensions (W × H × D)	Approx. 30.7 × 50.0 × 14.0 mm (1.2 × 2.0 × 0.6 in.)
Weight	Approx. 41 g (1.4 oz), excluding terminal cover
1 NIKKOR VR 10–30mm f/3.5–5.6	
Type	1 mount lens
Focal length	10–30 mm
Maximum aperture	f/3.5–5.6
Construction	12 elements in 9 groups (including 3 aspherical elements)
Angle of view	77°–29° 40'
Vibration reduction	Lens shift using voice coil motors (VCMs)
Minimum focus distance	0.2 m (0.7 ft) from focal plane at all zoom positions
Diaphragm blades	7 (rounded diaphragm opening)
Diaphragm	Fully automatic
Aperture range	<ul style="list-style-type: none"> • 10 mm focal length: f/3.5–16 • 30 mm focal length: f/5.6–16
Filter-attachment size	40.5 mm (P=0.5 mm)
Dimensions	Approx. 57.5 mm diameter × 42 mm (distance from camera lens mount flange when lens is retracted)
Weight	Approx. 115 g (4.1 oz)



1 NIKKOR 11–27.5mm f/3.5–5.6	
Type	1 mount lens
Focal length	11–27.5 mm
Maximum aperture	f/3.5–5.6
Construction	8 elements in 6 groups (including 1 ED lens element and 1 aspherical lens element), 1 protective glass element
Angle of view	72° – 32° 20'
Minimum focus distance	0.3 m (1.0 ft) from focal plane at all zoom positions
Diaphragm blades	7 (rounded diaphragm opening)
Diaphragm	Fully automatic
Aperture range	<ul style="list-style-type: none"> • 11 mm focal length: f/3.5– 16 • 27.5 mm focal length: f/5.6– 16
Filter-attachment size	40.5 mm (P=0.5 mm)
Dimensions	Approx. 57.5 mm diameter × 31 mm (distance from camera lens mount flange when lens is retracted)
Weight	Approx. 83 g (3.0 oz)

Specifications subject to change without notice. Nikon will not be held liable for damages that may result from any mistakes that this manual may contain.



■ 1 NIKKOR Lenses

1 NIKKOR VR 10–30mm f/3.5–5.6

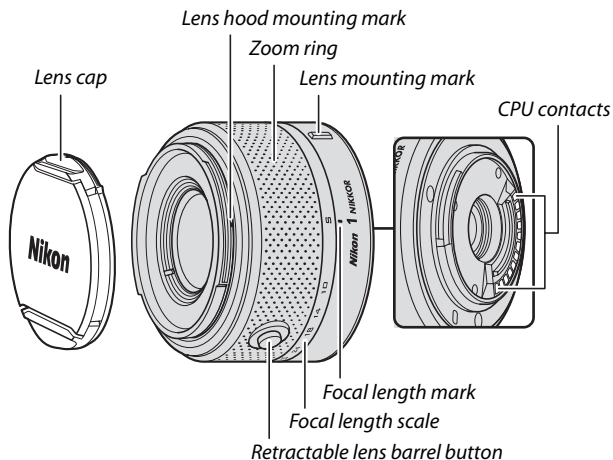

1 NIKKOR 11–27.5mm f/3.5–5.6

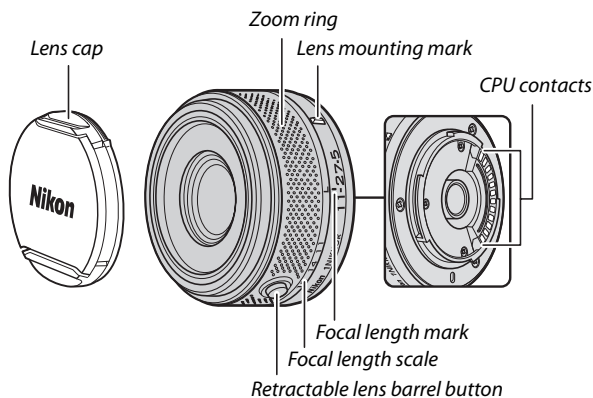

1 NIKKOR lenses are exclusively for Nikon 1 interchangeable lens format digital cameras. The angle of view is equivalent to a 35 mm format lens with a focal length about 2.7× longer. The 1 NIKKOR VR 10–30mm f/3.5–5.6 supports normal and active vibration reduction and vibration reduction off (☐ 127).

Use the zoom ring to zoom in and out.

Detaching the Lens

Before removing or exchanging lenses, retract the lens and turn the camera off (☐ 18). To remove the lens, press and hold the lens release button (①) while turning the lens clockwise (②). After removing the lens, replace the lens caps and camera body cap.

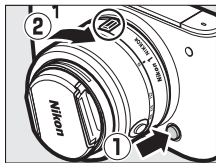

Lens Care

- When using an optional lens hood, do not pick up or hold the lens or camera using only the hood.
- Keep the CPU contacts clean.
- Use a blower to remove dust and lint from the lens surfaces. To remove smudges and fingerprints, apply a small amount of ethanol or lens cleaner to a soft, clean cotton cloth or lens-cleaning tissue and clean from the center outwards using a circular motion, taking care not to leave smears or touch the glass with your fingers.
- Never use organic solvents such as paint thinner or benzene to clean the lens.
- A lens hood or NC filter can be used to protect the front lens element.
- Attach the front and rear caps when the lens is not in use.
- If the lens will not be used for an extended period, store it in a cool, dry location to prevent mold and rust. Do not store in direct sunlight or with naphtha or camphor moth balls.
- Keep the lens dry. Rusting of the internal mechanism can cause irreparable damage.
- Leaving the lens in extremely hot locations could damage or warp parts made from reinforced plastic.



Supplied Accessories

- 40.5 mm snap-on Front Lens Cap LC-N40.5
- Rear Lens Cap LF-N1000

Optional Accessories

- 40.5 mm screw-on filters
- Bayonet Hood HB-N101 (for use with the 1 NIKKOR VR 10–30mm f/3.5–5.6; attaches as shown below).

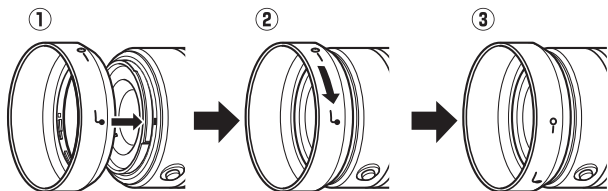

- 40.5 mm screw-on Hood HN-N102 (for use with the 1 NIKKOR 11–27.5mm f/3.5–5.6; attaches as shown below)

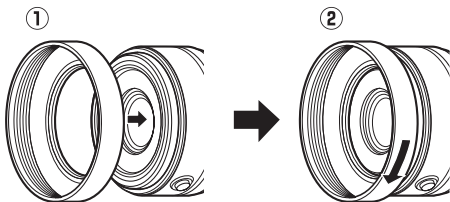

■ The Optional FT1 Mount Adapter

Read this section for information on using the optional FT1 mount adapter. Before proceeding, be sure that you have read and understood this manual and the documentation for the FT1 and lenses.

Autofocus

Autofocus is available only with AF-S lenses; other lenses support manual focus only. Set the camera focus mode to **AF-S** (the camera will not focus in other autofocus modes). The only AF-area mode available is **Single-point** and the camera focuses on the subject in the center focus area only. Face priority is not supported. In some cases, a beep may sound, the in-focus indicator may be displayed, and pictures can be taken when the camera is not in focus; if this occurs, focus manually.

Manual Focus

Follow the steps below to focus manually when using the FT1 with a NIKKOR F mount lens.

1 Select manual focus mode.

In the shooting menu, select **Focus mode**, highlight **Manual focus**, press **▶**, and choose the magnification for the manual focus display from 10×, 5×, and 2× (☐ 131).

2 Focus.

Rotate the lens focus ring until the subject is in focus.

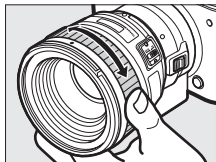

If the lens supports autofocus with manual override, after focusing using autofocus you can keep the shutter-release button pressed halfway and rotate the lens focus ring to fine-tune focus manually. To refocus using autofocus, press the shutter-release button halfway again.

To zoom in on the display for more precise focus, press  (note that this feature is not available during movie recording or in slow-motion movie mode). The display will be zoomed in to the magnification selected in Step 1 and a navigation window will appear in a gray frame at the bottom right of the display.

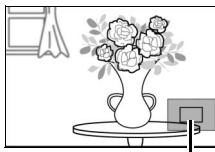

Navigation window

Use the multi selector to scroll to areas of the frame not visible in the display. Press  to exit zoom.



The Electronic Rangefinder

If a CPU lens is attached in manual focus mode, the focus indicator can be used to check whether the camera is focused on the subject in the center focus area.

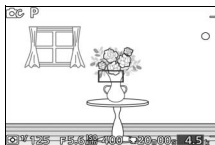

Focus indicator	Status
●	In focus.
▶	Camera focused in front of subject.
◀	Camera focused behind subject.
▶ ◀ (flashes)	Unable to determine focus.

Note that with some subjects, the in-focus indicator (●) may be displayed when the camera is not in focus. Check focus in the display before shooting.

Error Messages and Displays

The following warnings appear in the camera aperture display.

Display	Problem	Solution
FEE	Lens aperture ring is not locked at minimum aperture.	When using CPU lenses, lock aperture ring at minimum aperture (highest f-number).
F---	Non-CPU lens is attached, or no lens is attached.	When using non-CPU lens, rotate lens aperture ring to adjust aperture.

Restrictions

- Auto and best moment capture modes are not supported.
- Motion Snapshots can be recorded only when an AF-S lens is attached and **AF-S (Single AF)** is selected for focus mode and then only when the camera is in focus. Do not attempt to adjust focus using the focus ring.
- Shutter speeds of 1 s or slower are not available.
- The sound monitor switch and focus operation button (Focus Lock/MEMORY RECALL/AF Start) have no effect.



Precautions for Use

- Lenses over 380 g (13.4 oz) should be supported at all times. Do not hold the camera or carry the camera by the strap without supporting the lens. Failure to observe this precaution could damage the camera lens mount.
- Lines may appear in photographs taken with non-CPU lenses stopped down to minimum aperture.
- Select mode **A** or **M** to prevent sounds made by the lens being picked up by the microphone.
- During continuous shooting, focus is fixed at the position for the first shot in each burst. Frame rates will slow when **5 fps** is selected for **Continuous/self-timer**.
- Certain lenses will block the AF-assist illuminator and, at some distances, the flash.
- The tops and bottoms may be missing from circular *bokeh* shapes created at wide apertures using lenses with a maximum aperture of f/1.4.



■ Supported Standards

- **DCF Version 2.0:** The Design Rule for Camera File Systems (DCF) is a standard widely used in the digital camera industry to ensure compatibility among different makes of camera.
- **DPOF: Digital Print Order Format (DPOF)** is an industry-wide standard that allows pictures to be printed from print orders stored on the memory card.
- **Exif version 2.3:** The camera supports Exif (**Exchangeable Image File Format for Digital Still Cameras**) version 2.3, a standard in which information stored with photographs is used for optimal color reproduction when the images are output on Exif-compliant printers.
- **PictBridge:** A standard developed through cooperation with the digital camera and printer industries, allowing photographs to be output directly to a printer without first transferring them to a computer.
- **HDMI: High-Definition Multimedia Interface** is a standard for multimedia interfaces used in consumer electronics and AV devices capable of transmitting audiovisual data and control signals to HDMI-compliant devices via a single cable connection.



Trademark Information

Macintosh, Mac OS, and QuickTime are registered trademarks of Apple Inc. in the United States and/or other countries. Microsoft, Windows, and Windows Vista are either registered trademarks, or trademarks of Microsoft Corporation in the United States and/or other countries. The PictBridge logo is a trademark. Google Play is a trademark of Google Inc. The SD, SDHC, and SDXC logos are trademarks of SD-3C, LLC. HDMI, the HDMI logo and High-Definition Multimedia Interface are trademarks or registered trademarks of HDMI Licensing LLC.

HDMI

All other trade names mentioned in this manual or the other documentation provided with your Nikon product are trademarks or registered trademarks of their respective holders.

FreeType License (FreeType2)

Portions of this software are copyright © 2013 The FreeType Project (<http://www.freetype.org>). All rights reserved.

MIT License (HarfBuzz)

Portions of this software are copyright © 2013 The HarfBuzz Project (<http://www.freedesktop.org/wiki/Software/HarfBuzz>). All rights reserved.



Battery Life

The number of shots or movie footage that can be recorded with fully-charged batteries varies with the condition of the battery, temperature, the interval between shots, and the length of time menus are displayed. Sample figures for EN-EL20 (1020 mAh) batteries are given below.

- **Still images: Approximately 220 shots**
- **Movies: Approximately 50 minutes of HD footage at 1080/60i**

Measured according to CIPA standards at 23 ± 3 °C (73.4 ± 5.4 °F) with the camera at default settings, a fully-charged battery, a 1 NIKKOR VR 10–30mm f/3.5–5.6 lens, and a 16 GB Toshiba SD-E016GUX UHS-I SDHC card. Value for still images obtained under the following test conditions: photographs taken at intervals of 30 s with the built-in flash fired with every other shot and the camera turned off and then on after every ten shots. Value for movies obtained under the following test conditions: a series of 20 minute movies with a file size of up to 4 GB were recorded; recording was only interrupted when temperature warning was displayed.

The following can reduce battery life:

- Keeping the shutter-release button pressed halfway
- Repeated autofocus operations
- Taking NEF (RAW) photographs
- Slow shutter speeds
- Using a wireless mobile adapter or Eye-Fi cards
- Using vibration reduction mode with VR lenses
- Using zoom with power zoom lenses

To ensure that you get the most from rechargeable Nikon EN-EL20 batteries:

- Keep the battery contacts clean. Soiled contacts can reduce battery performance.
- Use batteries immediately after charging. Batteries will lose their charge if left unused.





Index

Symbols

 (Auto mode) 9, 23

 (Creative mode) 10, 33

 (Best moment capture mode) . 9, 45

 (Advanced movie mode) .. 10, 57

 (Motion Snapshot mode) 9, 53

 (Scene auto selector) 119

P (Programmed auto) 34, 36, 57, 119

S (Shutter-priority auto) ... 34, 37, 57, 119

A (Aperture-priority auto) 34, 38, 57, 119

M (Manual) 34, 39, 57, 119

 (Night landscape) 34

 (Night portrait) 35

 (Backlighting) 35, 42

 (Soft) 35

 (Miniature effect) 35

 (Selective color) 35

 (Slow motion) 62

 (Portrait) 25

 (Landscape) 25

 (Night portrait) 25

 (Close up) 25

 (Night landscape) 25

 (Auto) 25

 (flexible program) 36

MENU (menu) button 7, 107, 117, 137, 141, 155

 (playback) button 29, 50, 56

 (delete) button ... 30, 51, 56, 66, 85

 (OK) button 6

 (feature) 11, 27, 33, 47, 55, 58, 62, 86

 (continuous shooting/self-timer) . 67, 69

 (exposure compensation) 71

 (flash mode) 73

PRE (Preset manual) 144

 (matrix) 123

 (centerweighted) 123

 (spot) 123

 (auto-area) 133

 (single-point) 133

 (subject tracking) 133

 (Single frame) 67

 (red-eye reduction) 74

SLOW (slow sync) 74

REAR (rear-curtain sync) 74

 (flash-ready indicator) 72

A

AC adapter 163, 167

Accessories 163

Active D-Lighting 126

Adobe RGB 125

Advanced movie mode 10, 57, 58

AE lock 159

AF 128, 133

AF-A 128

AF-area mode 133

AF-assist illuminator 135

AF-C 128

AF-F 128

AF-S 128

Aperture 38, 39

Aperture-priority auto 34, 38, 57, 119

Attaching the lens 18

Auto distortion control 124

Auto image rotation 161

Auto mode 9, 23

Auto power off 19, 158

Auto-area (AF-area mode) 133

Autofocus 128, 133

Automatic scene selection 25

Auto-select AF 128

Available settings 174



B

Background track	56, 88, 98
Backlighting	35, 42
Basic info	79, 158
Battery	13, 15, 22, 193
Beep	24, 69, 158
Best moment capture mode	45
Best shot	47, 50
Body cap	2, 164
Border	105
Brightness	150
Buffering	48, 54
Built-in AF assist	135
Built-in flash	72
Bulb	40

C

Calendar	83, 87
Calendar playback	83
Capture NX 2	121, 153, 164
CEC	101
Center-weighted (Metering)	123
Change theme	115
Charging a battery	13
Clock	20, 21, 160
Clock battery	21
Close up	25
Color space	125
Color temperature	146
Compatible lens	163
Computer	91
Continuous AF	128
Contrast	126, 150
Creating short movies	97, 98
Creative mode	33
Crop	105, 113
Custom Picture Control	149, 152

D

Date and time	20, 160
Date format	20, 160
Daylight saving time	20, 160

DCF version 2.0	125, 202
Defaults	178
Delete	30, 51, 56, 66, 85
Delete all images	85
Delete selected images	85
Detailed display	4, 157
Detailed photo information	80, 158
Digital Print Order Format	202
Display	157
Display brightness	157
D-Lighting	111
DPOF	104, 106, 202
DPOF print order	104, 106
Dust shield	169, 170

E

Edit movie	114
Electronic VR	128
Exif version 2.3	125, 202
Exposure	71, 119, 123
Exposure compensation	71
Exposure indicator	40
Exposure mode	119
Eye-Fi	166

F

Face priority	26, 135
Face-priority zoom	114
File format	123
Fill flash	74
Filter effects	150, 151
Fine-tuning white balance	143
Firmware version	162
Flash	72, 136
Flash compensation	136
Flash mode	73
Flash range	75
Flash-ready indicator	72
Flexible program	36
Flicker reduction	159
Focal length	26, 80
Focal length scale	26, 195
Focal plane mark	2, 132



Focus 128, 133
Focus area 24, 133
Focus lock 134
Focus mode 128
Format 16, 156
Format memory card 16, 156
Frame rate 79, 138, 139
FT1 198
Full-frame playback 29, 79
Full-time AF 128

G

Grid display 5

H

H.264 191
HD movies 57, 58, 139
HDMI 100, 202
HDMI device control 101
HDMI-CEC 101
HDR 42
High definition 100, 202
High ISO noise reduction 154
Histogram 81
Hue 150

I

Image processing menu 141
Image quality 120
Image review 110
Image selection 109
Image size 120
Index print 104
ISO sensitivity 147

J

JPEG 120

L

Landscape 25, 148
Language 20, 160
Lens 18, 26, 127, 163, 193
Lens cap 196
Lens mount 132

Live image control 27
Load from/save to card 153
Long exposure NR 127

M

Manual 34, 39, 57, 119
Manual focus 131
Matrix (Metering) 123
Maximum aperture 193, 194
Memory card ... 15, 17, 156, 165, 179
Memory card access lamp 24
Memory card capacity 179
Metering 123
Microphone 59, 140
Miniature effect 35
Monitor 4, 157
Monochrome 148
Motion Snapshot mode 53
Mount adapter 163, 198
MOV 121, 123, 180
Movie before/after 122
Movie menu 137
Movie settings 139
Movie sound options 140
Movie-record button . 31, 43, 57, 59, 63
Movies 31, 43, 57, 139
Multi selector 6

N

NEF 120, 121
NEF (RAW) 120, 121
Neutral 148
Night landscape 25, 34
Night portrait 25, 35
Nikon Transfer 2 95
NMS 121, 123, 180
Number of shots saved 122

O

Optical VR 127



P

Photo information	79
PictBridge	102, 202
Picture Control	148, 152
Pixel mapping	162
Playback	29, 79
Playback menu	107
Playback zoom	84
Portrait	25, 148
Power connector	163, 167
Power drive zoom switch	26
Power switch	19
Preset manual	142, 144
Press the shutter-release button all the way down	24, 25
Press the shutter-release button halfway	24, 25
Print date	106
Print DPOF print order	104
Printing	102
Programmed auto	34, 36, 57, 119
Protect	110

Q

Quick adjust	150
--------------------	-----

R

Rating	86, 110
Rear-curtain sync	74
Red-eye reduction	74
Removing the lens from the camera 196	
Reset file numbering	159
Reset movie options	138
Reset processing options	142
Reset setup options	156
Reset shooting options	119
Resize	112
Retractable lens barrel button	18, 19, 195
Rotate tall	110

S

Saturation	150
Scene auto selector	119
Scene selection	34
SD card	165
Select images for printing	104
Selective color	35
Self-timer	67, 69
Sensitivity	147
Setup menu	155
Sharpening	150
Shooting menu	117
Short Movie Creator	91, 97, 98
Shutter button AE lock	159
Shutter speed	37, 39
Shutter-priority auto	34, 37, 57, 119
Shutter-release button	24, 25, 46, 48, 54, 159
Single AF	128
Single frame	67
Single-point	133
Size	112, 120, 139, 188, 191
Slide show	87
Slot empty release lock	157
Slow motion	62, 138
Slow sync	74
Slow view	45
Smart Photo Selector	47
Soft	35
Sound settings	158
Speaker	3
Spot (Metering)	123
sRGB	125
Standard	148
Strap	13
Subject tracking	133
System requirements	93

T

Television	100
Temperature warnings	xvi
Theme	55, 115



Thumbnail playback	82
Time	20, 160
Time stamp	105
Time zone	160
Time zone and date	160
Timer	67
Toning	150, 151
Trimming movies	114

U

USB	76, 95, 102
USB cable	95, 102

V

ViewNX 2	91
Vivid	148
Volume	65, 89
VR	127

W

Waterproof case	142, 163
White balance	142
Wind noise reduction	140
Wireless mobile adapter	76, 164

Z

Zoom guide	26
Zoom ring	26, 195



No reproduction in any form of this manual, in whole or in part (except for brief quotation in critical articles or reviews), may be made without written authorization from NIKON CORPORATION.

NIKON CORPORATION

© 2013 Nikon Corporation



SB2L01(11)
6MVA5011-01