



Canon

PowerShot SX150 IS

Camera User Guide

- Make sure you read this guide, including the “Safety Precautions” section, before using the camera.
- Reading this guide will help you learn to use the camera properly.
- Store this guide safely so that you can use it in the future.

ENGLISH

Checking the Package Contents

Check if the following items are included in your camera package.
If anything is missing, contact the retailer where you purchased the camera.



Camera



AA Alkaline Batteries (x2)



Wrist Strap
WS-800

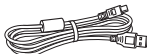

Interface Cable
IFC-400PCU



DIGITAL CAMERA
Solution Disk



Getting Started



Warranty Card

Using the PDF Manuals

The following PDF manuals are included in the Readme folder of the CD-ROM:

When the software is installed on your computer, the PDF manuals will be copied to the computer and you can refer to them by clicking the shortcuts on the desktop.

- **Camera User Guide (This Guide)**

Once you have mastered the basics, use the camera's many features to shoot more challenging photos.

- **Software Guide**

Read when you want to use the included software.



- A memory card is not included (p. 14).
- Adobe Reader is required to view the PDF manuals.

Read This First

- Take some initial test shots and play them back to make sure the images were recorded correctly. Please note that Canon Inc., its subsidiaries and affiliates, and its distributors are not liable for any consequential damages arising from any malfunction of a camera or accessory, including memory cards, that results in the failure of an image to be recorded or to be recorded in a way that is machine readable.
- The images recorded with this camera are intended for personal use. Do not record images that infringe upon copyright laws without the prior permission of the copyright holder. Please be advised that in certain cases the copying of images from performances, exhibitions, or commercial properties by means of a camera or other device may contravene copyright or other legal rights even if the image was shot for personal use.
- This camera's warranty is only effective in the country of sale. If there is a problem with the camera while abroad, please return it to the country of sale before proceeding with a warranty claim to a Canon Customer Support Help Desk. For Canon Customer Support contacts, please see the customer support list supplied with your camera.
- The LCD monitor is produced with extremely high-precision manufacturing techniques. More than 99.99% of the pixels operate to specification, but occasionally non-performing pixels may appear as bright or dark dots. This is not a malfunction and has no effect on the recorded image.
- The LCD monitor may be covered with a thin plastic film for protection against scratches during shipment. If covered, remove the film before using the camera.
- Please take care when operating the camera for an extended period as the camera body may become warm. This is not a malfunction.

What Do You Want to Do?



Shoot

- Shoot, leaving it to the camera to make settings (Auto mode) 23
- Just take pictures (Easy mode) 29

Take good people shots



Portraits
(p. 59)



Kids and Pets
(p. 59)



At the Beach
(p. 59)



Against Snow
(p. 60)

Shoot various other scenes



Landscape
(p. 59)



Low Light
(p. 59)



Foliage
(p. 60)



Fireworks
(p. 60)

Shoot with special effects



Vivid Colors
(p. 61)



Poster Effect
(p. 61)



Fish-eye Effect
(p. 62)



Miniature Effect
(p. 63)



Toy Camera Effect
(p. 64)



Monochrome
(p. 65)

- Shoot in Discreet mode 58
- Focus on faces 23, 59, 83
- Shoot in places where I cannot use the flash (turn off the flash).. 58
- Take pictures with me in them too (self-timer)..... 52, 71
- Insert the date and time into my shots..... 51

**View**

- Look at my pictures 27
- Easy playback (Easy Mode) 29
- Automatically play back pictures (slideshow) 115
- Look at my pictures on a TV 162
- Look at my pictures on a computer 33
- Quickly search pictures 112, 113
- Erase pictures..... 28, 123

**Shoot/View Movies**

- Shoot movies 30, 101
- View movies 32

**Print**

- Print pictures..... 136

**Save**

- Save images to a computer 33

**Other**

- Turn off sounds..... 44
- Use the camera abroad 155, 192
- Understand what is displayed on the screen 173

Table of Contents

Checking the Package Contents	2
Read This First	3
What Do You Want to Do?	4
Table of Contents	6
Safety Precautions.....	9
Conventions Used in This Guide	11

1 Getting Started 13

Compatible Memory Cards (Sold Separately).....	14
Inserting the Batteries and Memory Card.....	14
Setting the Date and Time	18
Setting the Display Language.....	20
Formatting Memory Cards	21
Pressing the Shutter Button.....	22
Taking Pictures (Smart Auto).....	23
Viewing Images	27
Erasing Images.....	28
Shooting or Viewing Images in Easy Mode.....	29
Shooting Movies	30
Viewing Movies.....	32
Transferring Images to a Computer for Viewing.....	33

2 Learning More 37

Components Guide.....	38
Screen Display.....	40
Indicator	41
FUNC. Menu – Basic Operations	42
MENU – Basic Operations	43
Changing the Sound Settings	44
Adjusting the Screen Brightness.....	46
Returning the Camera to Default Settings.....	47

Power Saving Function (Auto Power Down).....	48
Clock Function	48

3 Shooting with Commonly Used Functions 49

Zooming In More Closely on Subjects (Digital Zoom).....	50
Inserting the Date and Time.....	51
Using the Self-Timer	52
Changing the Recording Pixel Setting (Image Size)	54
Changing the Compression Ratio (Image Quality)	54

4 Adding Effects and Shooting in Various Conditions 57

Shooting in Discreet Mode.....	58
Shooting in Special Scenes	58
Adding Effects and Shooting (Creative Filters)	61
Detecting a Face and Shooting (Smart Shutter)	69

5 Choosing Settings Yourself..... 73

Shooting in Program AE.....	74
Turning the Flash On	74
Adjusting the Brightness (Exposure Compensation)	75
Changing the ISO Speed	75
Adjusting the White Balance	76
Continuous Shooting.....	77
Changing the Tone of an Image (My Colors)	78

Correcting the Brightness and Shooting (i-Contrast).....	79
Shooting Close-ups (Macro)	80
Digital Tele-Converter	81
Changing the AF Frame Mode.....	82
Choosing the Subject to Focus On (Tracking AF).....	84
Magnifying the Focal Point.....	85
Shooting in Manual Focus Mode	86
Shooting with Servo AF	87
Shooting with the AF Lock	88
Changing the Metering Method.....	88
Shooting with the AE Lock	89
Shooting with the FE Lock	89
Adjusting the Flash Exposure Compensation.....	90
Shooting with Slow Synchro	91
Red-Eye Correction	92
Checking for Shut Eyes	93
<hr/>	
6 Getting More Out of Your Camera	95
Setting the Shutter Speed.....	96
Setting the Aperture Value.....	97
Setting the Shutter Speed and Aperture Value.....	98
Adjusting the Flash Output.....	99
<hr/>	
7 Using Various Functions for Shooting Movies	101
Shooting Movies in  Mode	102
Changing the Movie Mode	102
Shooting Various Kinds of Movies	103
Shoot Movies That Look Like a Miniature Model (Miniature Effect).....	104
Changing the Image Quality	106
AE Lock/Exposure Shift.....	107
Using the Wind Filter	107
Other Shooting Functions.....	108
Editing	109
<hr/>	
8 Using Various Playback and Editing Functions.....	111
Quickly Searching Images.....	112
Viewing Images in Filtered Playback.....	113
Viewing Slideshows.....	115
Checking the Focus.....	116
Magnifying Images	117
Displaying Various Images (Smart Shuffle).....	117
Changing Image Transitions	118
Protecting Images	119
Erasing Images	123
Tagging Images as Favorites	125
Organizing Images by Category (My Category)	126
Rotating Images	128
Resizing Images.....	129
Trimming	130
Adding Effects with the My Colors Function	131
Correcting the Brightness (i-Contrast)	132
Correcting the Red-Eye Effect.....	133

9 Printing	135	11 Useful Information	161
Printing Images.....	136	Viewing Images on a TV	162
Choosing Images for Printing (DPOF)	143	Using Household Power.....	163
Choosing Images for a Photobook	147	Using an Eye-Fi Card.....	165
10 Customizing Camera Settings	149	Troubleshooting	167
Changing Camera Settings.....	150	List of Messages That Appear on the Screen.....	170
Changing Shooting Function Settings.....	156	Information Displayed on the Screen.....	173
Changing Playback Function Settings.....	160	Functions and Menu Lists	178
		Specifications	188
		Accessories.....	191
		Separately Sold Accessories	192
		Index	194
		Handling Precautions	197

Safety Precautions

- Before using the product, please ensure that you read the safety precautions described below. Always ensure that the product is used correctly.
- The safety precautions noted on the following pages are intended to prevent injuries to yourself and other persons, or damage to the equipment.
- Be sure to also check the guides included with any separately sold accessories you use.



Warning

Denotes the possibility of serious injury or death.

- **Do not trigger the flash in close proximity to people's eyes.**

Exposure to the intense light produced by the flash could damage eyesight. In particular, remain at least 1 meter (39 inches) away from infants when using the flash.

- **Store this equipment out of the reach of children and infants.**

Strap: Putting the strap around a child's neck could result in asphyxiation.

- **Use only recommended power sources.**
- **Do not attempt to disassemble, alter or apply heat to the product.**
- **Avoid dropping or subjecting the product to severe impacts.**
- **To avoid the risk of injury, do not touch the interior of the product if it has been dropped or otherwise damaged.**
- **Stop using the product immediately if it emits smoke, a strange smell, or otherwise behaves abnormally.**
- **Do not use organic solvents such as alcohol, benzine, or thinner to clean the product.**
- **Do not let the product come into contact with water (e.g. sea water) or other liquids.**
- **Do not allow liquids or foreign objects to enter the camera.**

This could result in electrical shock or fire.

If liquids or foreign objects come into contact with the camera interior, immediately turn the camera off and remove the batteries.

- **Use only the recommended batteries.**
- **Do not place the batteries near or in direct flame.**

The batteries may explode or leak, resulting in electrical shock or fire. This could cause injury and damage the surroundings. In the event that batteries leak and the battery electrolyte contacts eyes, mouth, skin or clothing, immediately flush with water.

- **Turn the camera off in places where camera use is prohibited.**

The electromagnetic waves emitted by the camera may interfere with the operation of electronic instruments and other devices. Exercise adequate caution when using the camera in places where use of electronic devices is restricted, such as inside airplanes and medical facilities.

- **Do not play the supplied CD-ROM(s) in any CD player that does not support data CD-ROMs.**

It is possible to suffer hearing loss from listening with headphones to the loud sounds of a CD-ROM played on an audio CD player (music player). Additionally, this could damage the speakers.



Caution

Denotes the possibility of injury.

- **When holding the camera by the strap, be careful not to bang it, subject it to strong impacts or shocks, or let it get caught on other objects.**
- **Be careful not to bump or push strongly on the lens.**

This could lead to injury or damage the camera.

- **When using the flash, be careful not to cover it with your fingers or clothing.**

This could result in burns or damage to the flash.

- **Avoid using, placing or storing the product in the following places:**

- Places subject to strong sunlight
- Places subject to temperatures above 40 °C (104 °F)
- Humid or dusty areas

These could cause leakage, overheating or an explosion of the batteries, resulting in electrical shock, fire, burns or other injuries.

- **The slideshow transition effects may cause discomfort when viewed for prolonged periods.**

Caution

Denotes the possibility of damage to the equipment.

- **Do not aim the camera at bright light sources (such as the sun on a clear day).**

Doing so may damage the image sensor.

- **When using the camera on a beach or at a windy location, be careful not to allow dust or sand to enter the camera.**

This may cause the product to malfunction.

- **In regular use, small amounts of smoke may be emitted from the flash.**

This is due to the high intensity of the flash burning dust and foreign materials stuck to the front of the unit. Please use a cotton swab to remove dirt, dust or other foreign matter from the flash to prevent heat build-up and damage to the unit.

- **Remove and store the batteries when you are not using the camera.**

If the batteries are left inside the camera, damage caused by leakage may occur.

- **Before you discard the batteries, cover the terminals with tape or other insulators.**

Contacting other metal materials may lead to fire or explosions.

- **Do not charge batteries of different types at the same time, or use older batteries together with newer batteries.**

- **Do not insert the batteries with the + and – terminals reversed.**

This may cause the product to malfunction.

- **Do not sit down with the camera in your pocket.**
Doing so may cause malfunctions or damage the screen.
- **When putting the camera in your bag, ensure that hard objects do not come into contact with the screen.**
- **Do not attach any hard objects to the camera.**
Doing so may cause malfunctions or damage the screen.



Conventions Used in This Guide

- Icons are used in the text to represent the camera buttons and dials.
- Language that displays on the screen appears inside [] (square brackets).
- The directional buttons, control dial and FUNC./SET button are represented by the following icons.

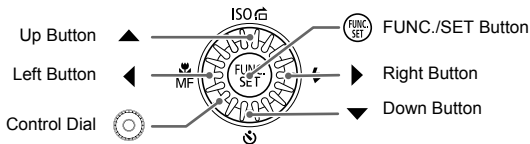

- : Things you should be careful about
- : Troubleshooting tips
- : Hints for getting more out of your camera
- : Supplemental information
- (p. xx): Reference pages (“xx” stands for a page number)
- This guide assumes all functions are at their default settings.
- The various types of memory cards that can be used in this camera are collectively referred to as memory cards in this guide.

Getting Started

This chapter explains preparations before shooting, how to shoot in **AUTO** mode, and then how to view and erase the images you take. The latter part of this chapter explains how to shoot and view images in Easy mode, how to shoot and view movies, and how to transfer images to a computer.

Attaching the Strap/Holding the Camera

- Attach the included strap and wrap it around your wrist to avoid dropping the camera during use.
- Keep your arms tight against your body while holding the camera firmly by the sides when shooting. Be sure that your fingers do not block the flash while it is raised.

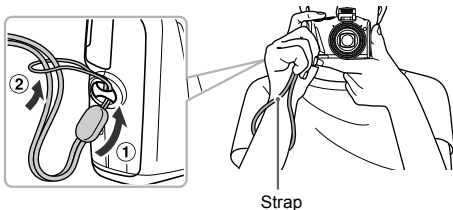

Compatible Memory Cards (Sold Separately)

The cards below can be used without restrictions on their capacities.

- SD memory cards*
- SDHC memory cards*
- SDXC memory cards* 
- Eye-Fi cards

* This memory card complies with SD standards. Some cards may not operate properly depending on the brand of card used.



Depending on your computer's OS version, SDXC memory cards may not be recognized even when using a commercially available card reader. Check to make sure that your OS supports SDXC memory cards beforehand.

About Eye-Fi Cards

This product is not guaranteed to support Eye-Fi card functions (including wireless transfer). In case of an issue with an Eye-Fi card, please check with the card manufacturer.

Also note that an approval is required to use Eye-Fi cards in many countries or regions. Without approval, use of the card is not permitted. If it is unclear whether the card has been approved for use in the area, please check with the card manufacturer.

Inserting the Batteries and Memory Card

Insert the included batteries and a memory card (sold separately).

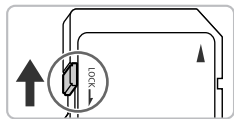

1 Check the card's write-protect tab.

- If the memory card has a write-protect tab, you will not be able to record images if the tab is in the locked position. Slide the tab up until you hear a click.

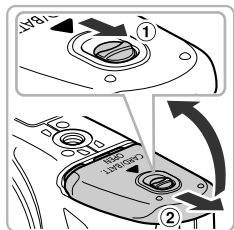

2 Open the cover.

- Slide and hold the cover lock (1), then slide and open the cover (2) as shown.

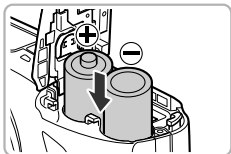

3 Insert the batteries.

- Insert the batteries as shown.

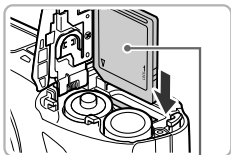

4 Insert the memory card.

- Insert the memory card as shown until it locks into place with a click.
- Be sure the memory card is oriented correctly. Inserting the memory card in the wrong direction could damage the camera.

Label

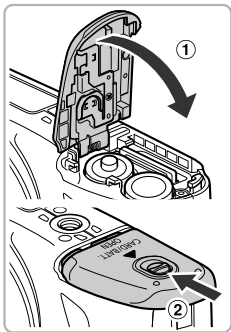

5 Close the cover.

- Close the cover (①), and press downward as you slide it until it clicks into place (②).



What if [Memory card locked] appears on the screen?

If the write-protect tab is in the locked position, [Memory card locked] will appear on the screen and you will not be able to take or erase images.

Removing the Memory Card

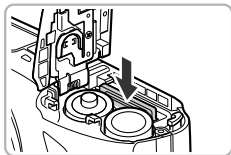

- Push the memory card in until you hear a click, then slowly release it.
- ▶ The memory card will pop up.

Number of Possible Shots/Shooting and Playback Times

Power Source	Alkaline Batteries (Supplied)	NiMH Batteries (Sold Separately)
Number of Shots*1	Approx. 110	Approx. 320
Movie Shooting Time*2	Approx. 20 min.	Approx. 1 hr. 20 min.
Continuous Shooting*3	Approx. 1 hr.	Approx. 2 hr. 20 min.
Playback Time	Approx. 7 hours	Approx. 9 hours

*1 The number of shots that can be taken is based on the Camera & Imaging Products Association (CIPA) measurement standard.

*2 Times are based on default settings, starting and stopping shooting, turning the camera on and off, and operations such as using the zoom.

*3 Times are based on repeatedly shooting until the maximum clip length is reached or recording stops automatically.

- Under some shooting conditions, the number of possible shots and shooting time may be less than mentioned above.
- Depending on the brand of alkaline batteries used, the number of possible shots and shooting time may vary widely.
- The values for NiMH batteries are based on fully charged batteries.

Compatible Batteries

AA alkaline batteries and Canon AA NiMH batteries (sold separately) (p. 192).

❓ Can any other batteries be used?

We cannot recommend the use of any other batteries than those listed above because performance varies widely.

💡 Why use NiMH batteries?

NiMH batteries last much longer than alkaline batteries, especially in cold weather.

Battery Charge Indicator

When battery charge is low, an icon and message will appear. If the batteries are charged, the icon and message will not appear.

Display	Summary
	Nearly depleted. Ready new batteries.
"Change the batteries"	Depleted. Change the batteries.

Number of Shots per Memory Card

Memory Card	4 GB	16 GB
Number of Shots	Approx. 1058	Approx. 4334

- Values are based on the default settings.
- The number of shots that can be taken will vary depending on camera settings, the subject and the memory card used.



Can you check the number of shots that can be taken?



You can check the number of shots that can be taken when the camera is in a Shooting mode (p. 23).

Setting the Date and Time

The Date/Time settings screen will appear the first time the camera is turned on. Since the dates and times recorded into your images are based on these settings, be sure to set them.



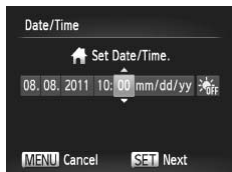

1 Turn on the camera.

- Press the power button.
- ▶ The Date/Time screen will appear.



2 Set the date and time.

- Press the ◀▶ buttons to choose an option.
- Press the ▲▼ buttons or turn the  dial to set a value.
- Once all settings are complete, press the  button.



3 Set the home time zone.

- Press the ◀▶ buttons or turn the  dial to choose your home time zone.

4 Complete the setting.

- Press the  button to complete the setting. After a confirmation screen appears, the shooting screen will reappear.
- Pressing the power button will turn off the camera.







? Reappearing Date/Time screen

Set the correct date and time. If you have not set the date and time and the home time zone, the Date/Time screen will appear each time you turn on the camera.



Daylight saving time settings

If you choose  in Step 2 on p. 18 and press the  buttons or turn the  dial to choose , you will set the time to daylight saving (1 hour ahead).

Changing the Date and Time

You can change the current date and time settings.





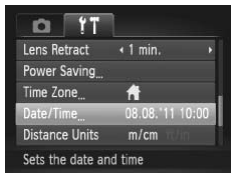

1 Display the menu.

- Press the **MENU** button.



2 Choose [Date/Time].

- Move the zoom lever to choose the  tab.
- Press the  buttons or turn the  dial to choose [Date/Time], then press the  button.

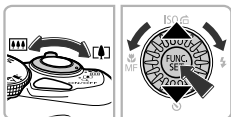

3 Change the date and time.

- Follow Step 2 on p. 18 to adjust the settings.
- Press the **MENU** button to close the menu.



The camera has a built-in date/time battery (backup battery). If the Date/Time menu appears every time you turn the camera on, even when the date/time have been correctly set, contact a Canon Customer support Help Desk.

Setting the Display Language

You can change the language that displays on the screen.



1 Enter Playback mode.

- Press the button.

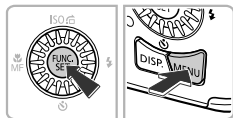

2 Display the settings screen.

- Press and hold the button, then immediately press the **MENU** button.



3 Set the display language.

- Press the buttons or turn the dial to choose a language, then press the button.
- ▶ Once the display language has been set, the settings screen will close.



? What if the clock appears when the button is pressed?

The clock will appear if too much time passes between pressing the button and the **MENU** button in Step 2. If the clock appears, press the button to remove the clock and repeat Step 2.



You can also change the display language by pressing the **MENU** button to choose [Language] in the tab.

Formatting Memory Cards

Before you use a new memory card or one that has been formatted in other devices, you should format the card with this camera.

Formatting (initializing) a memory card erases all data on the memory card. As you cannot retrieve the erased data, exercise adequate caution before formatting the memory card.

Before formatting an Eye-Fi card (p. 165), be sure to install the software contained on the card to a computer.

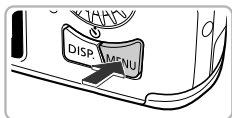





1 Display the menu.

- Press the MENU button.



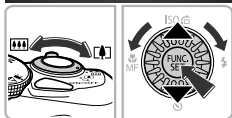

2 Choose [Format].

- Move the zoom lever to choose the  tab.
- Press the  buttons or turn the  dial to choose [Format], then press the  button.





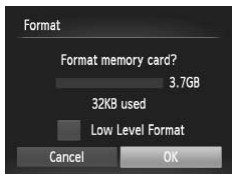

3 Choose [OK].

- Press the  buttons or turn the  dial to choose [OK], then press the  button.



4 Format the memory card.

- Press the  buttons or turn the  dial to choose [OK], then press the  button to start formatting.
- When formatting ends, [Memory card formatting complete] appears on the screen. Press the  button.

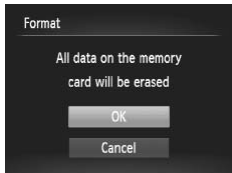



Formatting or erasing data on a memory card merely changes the file management information on the card and does not ensure its contents are completely erased. Be careful when transferring or disposing of a memory card. When disposing of a memory card, take precautions such as physically destroying the card to prevent personal information leaks.



- The total capacity of the memory card displayed in the formatting screen may be less than indicated on the memory card.
- Perform a low-level format (p. 151) of the memory card when the camera does not operate properly, the recording/reading speed of a memory card has dropped, when continuous shooting speed slows down, or when movie recording stops suddenly.

Pressing the Shutter Button

To take images that are in focus, be sure to first press the shutter button lightly (halfway) to focus, then press fully to shoot.



1 Press halfway (Press lightly to focus).

- Press lightly until the camera beeps twice and AF frames appear where the camera focused.



2 Press fully (Press fully to shoot).

- ▶ The camera plays the shutter sound and takes the shot.
- Since the shot is being taken while the shutter sound plays, be careful not to move the camera.



Does the length of the shutter sound change?

- Since the time required to shoot differs depending on the scene you want to take, the length of the shutter sound may change.
- If the camera or subject moves while the shutter sound is playing, the recorded image may be blurry.



If you shoot without pressing the shutter button halfway, the image may not be in focus.

Taking Pictures (Smart Auto)

Since the camera can determine the subject and shooting conditions, you can let it automatically select the best settings for the scene and just shoot.



1 Turn on the camera.

- Press the power button.
- ▶ The start-up screen will appear.

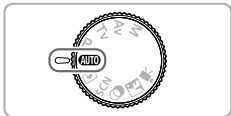

2 Enter **AUTO** mode.

- Set the mode dial to **AUTO**.
- When you point the camera toward the subject, the camera will make a slight noise as it determines the scene.
- ▶ The icon for the determined scene, and the IS mode icon will appear on the screen (pp. 174, 175).
- ▶ The camera will focus on detected subjects and display frames on them.



3 Compose the shot.

- Moving the zoom lever toward [🌲] (telephoto) will zoom in on your subject, making it appear larger. Moving the lever toward [|||] (wide angle) will zoom out from your subject, making it appear smaller. (The zoom bar showing the zoom position appears on the screen.)

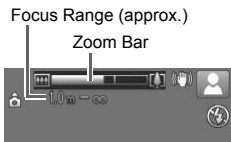



4 Focus.

- Press the shutter button halfway to focus.



AF Frame

- ▶ When the camera focuses, it will beep twice and AF frames will appear where the camera focused.

Several AF frames will appear when the camera focuses on more than 1 point.







- If [Raise the flash] appears on the screen, raise the flash manually to use it. If you manually lower the flash until it closes, it will not fire.



5 Shoot.

- Press the shutter button fully to shoot.
- ▶ The camera will play the shutter sound and shoot. The flash will automatically fire in low light conditions if it is raised.
- ▶ The image will appear on the screen for approximately 2 seconds.
- You can take a second picture even while an image is displayed by pressing the shutter button again.

What if...

- **What if the color and brightness of the images do not turn out as expected?**
The scene icon (p. 174) that appears on the screen may not match the actual scene, and you may not obtain the expected results. If this happens, try shooting in **P** mode (p. 73).
- **What if white and gray frames appear when you point the camera toward a subject?**
A white frame appears on the face or subject that the camera detected as the main subject, while gray frames appear on other detected faces. The frames will follow the subjects within a certain range.
If the subject moves, however, the gray frames will disappear, leaving only the white frame.
- **What if a frame does not appear on the subject you want to shoot?**
The subject may not be detected, and frames may appear on the background. If this happens, try shooting in **P** mode (p. 73).
- **What if a blue frame appears when you press the shutter button halfway?**
A blue frame appears when a moving subject is detected; the focus and exposure will continuously adjust (Servo AF).
- **What if a flashing  appears?**
Attach the camera to a tripod so that the camera does not move and blur the image.
- **What if the camera does not play any sounds?**
You may have been pressing the **DISP.** button while turning on the camera, which will turn off all sounds. To turn the sounds on, press the **MENU** button to choose [Mute] in the **f** tab, then press the **◀▶** buttons to choose [Off].
- **What if the image comes out dark even if the flash fired when shooting?**
The subject is too far away for the flash to reach. The effective flash range is approximately 50 cm – 3.0 m (1.6 – 9.8 ft.) at maximum wide angle () , and approximately 1.0 – 2.0 m (3.3 – 6.6 ft.) at maximum telephoto () .
- **What if the camera beeps once when the shutter button is pressed halfway?**
Your subject may be too close. When the camera is at maximum wide angle () , move about 1 cm (0.4 in.) or more away from your subject and shoot. Move about 1 m (3.3 ft.) or more away when the camera is at maximum telephoto () .
- **What if the lamp lights when the shutter button is pressed halfway?**
To reduce red-eye and to assist in focusing, the lamp may light when shooting in low light conditions.

- **What if [Charging the flash] appears on the screen, and the  icon blinks when you try to shoot?**

The flash is charging. You can shoot when recharging ends.





What if an icon appears on the screen?

The icon for the determined scene, and the IS mode icon will appear on the screen. For details on the icons that appear, see “Scene Icons” (p. 174) and “IS Mode Icons” (p. 175).



Choosing the subject to focus on (Tracking AF)

After pressing the  button and displaying , point the camera so that  is on the subject you want to focus on. Press and hold the shutter button halfway to display a blue frame where focus and exposure will be maintained (Servo AF). Press the shutter button fully to shoot.

Viewing Images

You can view the images you have taken on the screen.









1 Enter Playback mode.

- Press the  button.
- ▶ The last image you took will appear.



2 Choose an image.

- Pressing the  button or turning the  dial counter-clockwise will cycle through the images from newest to oldest.
- Pressing the  dial clockwise will cycle through the images from oldest to newest.
- The images change more quickly if you keep the   buttons pressed, but they will appear coarse.
- The lens will retract after approximately 1 minute elapses.
- Pressing the  button again while the lens is retracted will turn the camera off.

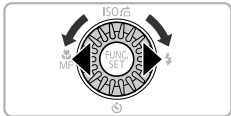

Switching to Shooting mode

Pressing the shutter button halfway, or turning the mode dial in Playback mode switches the camera to Shooting mode.

Erasing Images

You can choose and erase images one at a time. Please note that erased images cannot be recovered. Exercise adequate caution before erasing an image.





1 Enter Playback mode.

- Press the  button.
- ▶ The last image you took will appear.











2 Choose an image to erase.

- Press the   buttons or turn the  dial to display an image to erase.



3 Erase the image.

- Press the  button.
- When [Erase?] appears on the screen, press the   buttons or turn the  dial to choose [Erase], then press the  button.
- ▶ The displayed image will be erased.
- To exit instead of erasing, press the   buttons or turn the  dial to choose [Cancel], then press the  button.

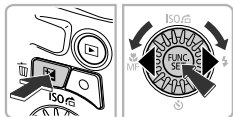

Shooting or Viewing Images in Easy Mode

In Easy mode, operational instructions are displayed on the screen, and the camera is set so that only the buttons, the zoom lever and the movie button (p. 30) explained on this page are functional. This prevents incorrect operation of the camera, allowing even beginners to take and view worry-free pictures.



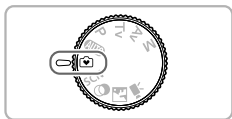



Shooting

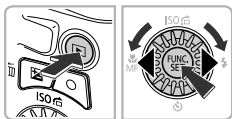

- Set the mode dial to .
- Follow Steps 3 – 5 on pp. 23 – 24 to shoot (no sound will play).

Viewing



- Press the  button, then press the  buttons or turn the  dial to switch images.
- Press the  button, then press the  button, and all the shots you have taken will display for about 3 seconds each. Press the  button again to stop the slideshow.
- To erase images, follow the steps on p. 28.

Shooting Movies

The camera will determine the subject and shooting conditions, and select the best settings for the scene. The audio will record in stereo.

Remaining Time



1 Set the camera to **AUTO** mode and compose the shot.

- Follow Steps 1 – 3 on p. 23 to compose the shot.
- You can check the remaining shooting time on the screen.

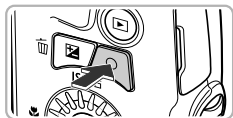

2 Shoot.

- Press the movie button.
- Black bars appear at the top and bottom of the screen. These areas cannot be recorded.

Elapsed Time



- ▶ The camera will beep once, recording will start, and [●Rec] and the elapsed time will appear on the screen.
- Once shooting begins, take your finger off the movie button.
- If you change the composition of your shot during shooting, the focus, brightness and tone will automatically adjust.
- Do not touch the microphones while shooting.
- Do not press any buttons other than the movie button while shooting. The sound the buttons make will be recorded in the movie.

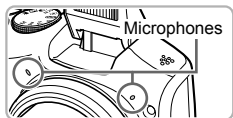

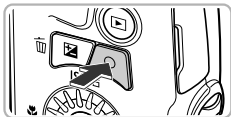

3 Stop shooting.

- Press the movie button again.
- ▶ The camera will beep twice and stop shooting the movie.
- ▶ Shooting will automatically stop when the memory card fills.



Zooming while shooting

Moving the zoom lever while shooting will zoom in on or out from the subject. However, operation sounds will be recorded.



- When the mode dial is set to **AUTO**, the icon for the determined scene will appear (p. 174). “When Moving” icons will not appear, however. Under certain conditions, the icon that appears may not match the actual scene.
- Movies can be shot by pressing the movie button even when the mode dial is in positions other than **AUTO** (p. 101).
- When the mode dial is set to **M**, you can adjust each setting for shooting movies (p. 101).

Shooting Time

Memory Card	4 GB	16 GB
Shooting Time	Approx. 20 min. 43 sec.	Approx. 1 hr. 24 min. 54 sec.

- Shooting times are based on default settings.
- Maximum clip length is approx. 29 min. 59 sec.
- Recording may stop even if the maximum clip length has not been reached on some memory cards. SD Speed Class 6 or higher memory cards are recommended.

Viewing Movies

You can view the movies you have shot on the screen.



1 Enter Playback mode.

- Press the button.
- ▶ The last image you took will appear.
- ▶ appears on movies.



2 Choose a movie.

- Press the buttons or turn the dial to choose a movie, then press the button.
- ▶ The movie control panel will appear.



3 Play the movie.

- Press the buttons or turn the dial to choose , then press the button.
- ▶ The movie will play.
- Press the buttons to adjust the volume.
- If you press the button, you can pause or resume playback.
- ▶ After the movie finishes, appears.



How can I play back movies on a computer?

Install the included software (p. 34).

- When watching a movie on a computer, frames may drop, it may not play smoothly, and the audio may stop suddenly depending on the computer's capabilities. Use the supplied software to copy the movie back onto the memory card, then play back the movie with the camera. If you connect the camera to a TV, you can view images on the larger screen.

Transferring Images to a Computer for Viewing

You can use the included software to transfer images you have shot with the camera to a computer for viewing. If you are already using software included with another Canon-brand compact digital camera, install the software from the included CD-ROM, overwriting your current installation.

System Requirements

Windows

OS	Windows 7 (Including Service Pack 1) Windows Vista SP2 Windows XP SP3
Computer Model	The above OS should be pre-installed on computers with built-in USB ports.
CPU	Pentium 1.3 GHz or higher (still images), Core 2 Duo 1.66 GHz or higher (movies)
RAM	Windows 7 (64bit): 2 GB or more Windows 7 (32bit), Windows Vista (64bit, 32bit) : 1 GB or more Windows XP: 512 MB or more (still images), 1 GB or more (movies)
Interface	USB
Free Hard Disk Space	420 MB or more*
Display	1,024 x 768 pixels or higher

* For Windows XP, Microsoft .NET Framework 3.0 or later (max. 500 MB) must be installed. Installation may take some time depending on your computer's capabilities.

Macintosh

OS	Mac OS X (v10.5 – v10.6)
Computer Model	The above OS should be pre-installed on computers with built-in USB ports.
CPU	Intel Processor (still images), Core Duo 1.66 GHz or higher (movies)
RAM	Mac OS X v10.6: 1 GB or more Mac OS X v10.5: 512 MB or more (still images), 1 GB or more (movies)
Interface	USB
Free Hard Disk Space	480 MB or more
Display	1,024 x 768 pixels or higher

Installing the Software

Windows Vista and Mac OS X (v10.5) are used for these explanations.

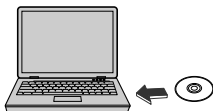

1 Place the CD-ROM in the computer's CD-ROM drive.

- Place the supplied CD-ROM (DIGITAL CAMERA Solution Disk) (p. 2) into the computer's CD-ROM drive.
- When the CD-ROM is placed in a Macintosh, a CD-ROM icon will appear on the desktop. Double-click the icon to open the CD-ROM, then double click  when it appears.



2 Install the software.

- For Windows, click [Easy Installation], and for Macintosh click [Install], then follow the on-screen instructions to proceed with the installation.
- If the [User Account Control] window appears in Windows, follow the on-screen instructions to proceed.



3 Complete the installation.

- For Windows, click [Restart] or [Finish], then remove the CD-ROM when your desktop screen appears.
- For Macintosh, click [Finish] in the screen that appears when the installation is complete, then remove the CD-ROM when your desktop screen appears.

Transferring and Viewing Images

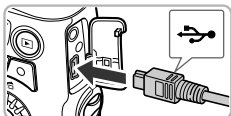

1 Connect the camera to the computer.

- Turn off the camera.
- Open the cover and insert the included interface cable's smaller plug (p. 2) firmly into the camera terminal in the direction shown.
- Insert the interface cable's larger plug into the computer's USB port. For details on the computer's USB port, refer to the user guide provided with the computer.

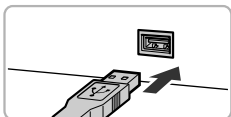

2 Turn on the camera to open CameraWindow.

- Press the  button to turn on the camera.
- For Windows, click [Downloads Images From Canon Camera using Canon CameraWindow] when it appears on the screen. CameraWindow will appear when a connection is established between the camera and computer.
- For Macintosh, CameraWindow will appear when a connection is established between the camera and computer.



CameraWindow

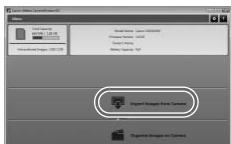



3 Transfer Images.

- Click [Import Images from Camera], and then click [Import Untransferred Images].
- ▶ Images will transfer to the computer. Images will be sorted by date and saved in separate folders in the Pictures folder.

- When image transfer is complete, close CameraWindow and press the  button to turn the camera off, then unplug the cable.
- For details on how to view images using a computer, refer to the *Software Guide*.



- If CameraWindow does not appear even after following Step 2 for Windows, click the [Start] menu and choose [All Programs], followed by [Canon Utilities], [CameraWindow] and [CameraWindow].
- If CameraWindow does not appear even after following Step 2 for Macintosh, click the CameraWindow icon on the Dock (the bar which appears at the bottom of the desktop).
- For Windows 7, use the following steps to display CameraWindow.
 - ① Click  on the task bar.
 - ② In the screen that appears, click the  link to modify the program.
 - ③ Choose [Downloads Images From Canon Camera using Canon CameraWindow] and click [OK].
 - ④ Double click .
- You can transfer images even without using the image transfer function in the included software by simply connecting your camera to a computer. There are, however, the following limitations.
 - It may take a few minutes from when you connect the camera to the computer until you can transfer images.
 - Images shot in the vertical orientation may be transferred in the horizontal orientation.
 - Protection settings for images may be lost when transferred to a computer.
 - There may be problems transferring images or image information correctly depending on the version of the operating system in use, the file size, or the software in use.
 - Some functions in the included software may not be available, such as editing movies, and transferring images to the camera.

2

Learning More

This chapter explains the parts of the camera and what appears on the screen, as well as the basic operating instructions.



Components Guide

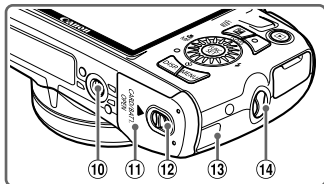
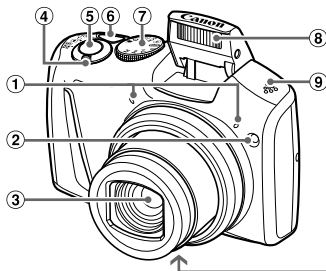

- ① Microphones (p. 30)
- ② Lamp (pp. 52, 69, 70, 71, 157)
- ③ Lens
- ④ Zoom Lever
Shooting: [T] (Telephoto) / [W] (Wide Angle) (pp. 23, 50)
Playback: Q (Magnify) / [I] (Index) (pp. 112, 117)
- ⑤ Shutter Button (p. 22)
- ⑥ Power Button (p. 18)
- ⑦ Mode Dial
- ⑧ Flash (p. 74)
- ⑨ Speaker
- ⑩ Tripod Socket
- ⑪ Memory Card / Battery Cover (p. 14)
- ⑫ Cover Lock (p. 14)
- ⑬ DC Coupler Cable Port (p. 163)
- ⑭ Strap Mount (p. 13)

Mode Dial

Use the mode dial to change the Shooting mode.

P, Tv, Av, M Mode

Choose settings yourself to take various types of pictures (p. 74).

Auto Mode

You can leave it to the camera to select settings for fully automatic shooting (pp. 23, 30).

Easy Mode

You can shoot just by pressing the shutter button (p. 29).

Special Scene Mode

You can shoot with the optimum settings for the scene (p. 58).

Movie Mode

For shooting movies (pp. 30, 102). Even if the mode dial is set to a position other than Movie mode, movies can be shot by pressing the movie button (p. 103).

Discreet Mode

You can shoot with the flash disabled and all camera sounds muted (p. 58).

Creative Filters Mode

You can add various effects to images when shooting (p. 61).



If you turn the mode dial while in Playback mode, the camera will switch to Shooting mode.

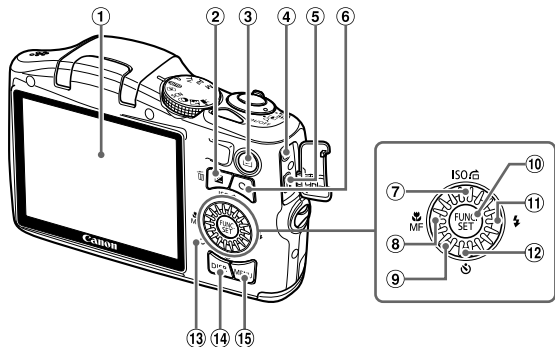

- ① Screen (LCD Monitor) (pp. 40, 173, 176)
- ② (Exposure Compensation) (p. 75) / (Single Image Erase) Button (p. 28)
- ③ (Playback) Button (pp. 27, 111)
- ④ A/V OUT (Audio/Video Output) Terminal (p. 162)
- ⑤ DIGITAL Terminal (pp. 35, 136)
- ⑥ Movie Button (pp. 30, 101)
- ⑦ ISO (p. 75) / (Jump) (p. 113) / Button
- ⑧ (Macro) (p. 80) / **MF** (Manual Focus) (p. 86) / Button
- ⑨ Control Dial
- ⑩ **FUNC./SET** Button (p. 42)
- ⑪ (Flash) (pp. 74, 91) / Button
- ⑫ (Self-Timer) (pp. 52, 53) / Button
- ⑬ Indicator (p. 41)
- ⑭ **DISP.** (Display) Button (pp. 25, 40)
- ⑮ **MENU** Button (p. 43)

Control Dial

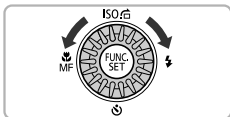

- Turning the control dial allows you to perform operations such as choosing items or switching images. Except for a few operations, the same operations are possible with the buttons.

Screen Display

Switching the Display

You can change the screen display using the **DISP.** button. Refer to p. 173 for details on information that appears on the screen.

Shooting



Information Display



No Information Display



Playback



No Information Display



Simple Information Display



Detailed Information Display



Focus Check Display (p. 116)



You can also switch the display by pressing the **DISP.** button while the image displays right after shooting. However, Simple Information Display is not available. You can change the display that appears first by pressing the **MENU** button, then choosing [Review Info] in the tab (p. 158).

Screen Display in Low Light Conditions

The display automatically brightens when shooting in low light conditions, allowing you to check the composition (Night Display function). However, the brightness of the image on the screen, and the brightness of the actual image recorded may be different. Screen noise may appear and the movement of the subject may appear somewhat rough on the screen. This has no effect on the recorded image.

Overexposure Warning during Playback

In Detailed Information Display (p. 40), overexposed areas of the image flash on the screen.

Histogram during Playback

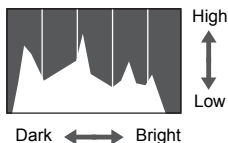

- The graph that appears in Detailed Information Display (p. 176) is called the histogram. The histogram shows the distribution of brightness in an image horizontally, and the amount of brightness vertically, and in this way you can judge the exposure.

Indicator

The indicator on the back of the camera (p. 39) will light or blink depending on the camera's status.

Color	Status	Operation Status
Green	Lights	When connected to a computer (p. 35), display off
	Blinks	During camera start-up, recording/reading/transmitting image data



When the indicator blinks green, do not turn the camera off, open the memory card slot/battery cover, shake or jolt the camera. These actions may corrupt the image data or cause the camera or memory card to malfunction.

FUNC. Menu – Basic Operations

You can set commonly used shooting functions using the FUNC. menu. The menu items and options differ depending on the Shooting mode (pp. 180 – 181).

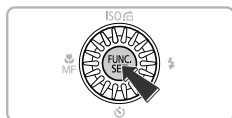



1 Display the FUNC. menu.





- Press the  button.



2 Choose a menu item.

- Press the   buttons to choose a menu item.
- ▶ The available options for the menu item appear in the lower part of the screen.

3 Choose an option.

- Press the   buttons or turn the  dial to choose an option.
- You can also choose settings by pressing the **DISP.** button on options that display .

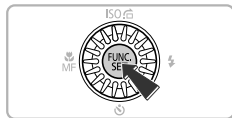

4 Complete the setting.

- Press the  button.
- ▶ The shooting screen will reappear and the setting you chose will display on the screen.

MENU – Basic Operations

Various functions can be set from the menus. The menu items are organized under tabs, such as for shooting (📷) and playback (▶). The options differ depending on the Shooting mode and the Playback mode (pp. 182 – 187).

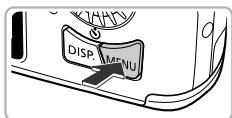

1 Display the menu.

- Press the **MENU** button.



2 Choose a tab.

- Move the zoom lever or press the ◀▶ buttons to choose a tab.

3 Choose an item.

- Press the ▲▼ buttons or turn the dial to choose an item.
- Some items require you to press the or ▶ button to display a submenu in which you change the setting.

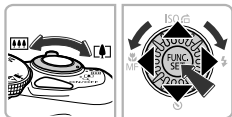

4 Choose an option.

- Press the ◀▶ buttons to choose an option.

5 Complete the setting.

- Press the **MENU** button to restore the normal screen.

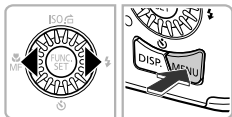

Changing the Sound Settings

You can silence or adjust the volume of camera sounds.

Muting Sounds

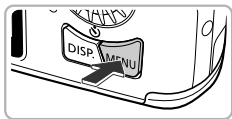

1 Display the menu.

- Press the **MENU** button.



2 Choose [Mute].

- Move the zoom lever to choose the **YT** tab.
- Press the **▲▼** buttons or turn the **○** dial to choose [Mute], then press the **◀▶** buttons to choose [On].
- Press the **MENU** button to restore the normal screen.

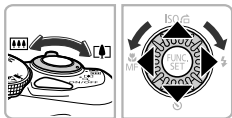

- You can also mute camera sounds by holding down the **DISP.** button and turning the camera on.
- If you mute camera sounds, the sound will also be muted when playing back movies (p. 32). If you press the **▲** button while playing back a movie, the sound will play back, and you can adjust the volume with the **▲▼** buttons.
- You cannot change the sound settings in **[L]** mode.

Adjusting the Volume





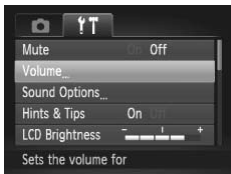

1 Display the menu.

- Press the **MENU** button.





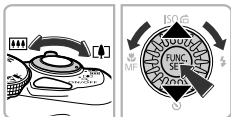

2 Choose [Volume].

- Move the zoom lever to choose the  tab.
- Press the   buttons or turn the  dial to choose [Volume], then press the  button.



3 Adjust the volume.

- Press the   buttons or turn the  dial to choose an item, then press the   buttons to adjust the volume.
- Press the **MENU** button twice to restore the normal screen.

Adjusting the Screen Brightness

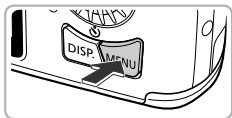

1 Display the menu.

- Press the **MENU** button.



2 Choose [LCD Brightness].

- Move the zoom lever to choose the **YT** tab.
- Press the **▲▼** buttons or turn the **⊙** dial to choose [LCD Brightness].

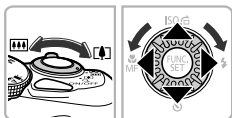

3 Adjust the brightness.

- Press the **◀▶** buttons to adjust the brightness.
- Press the **MENU** button twice to restore the normal screen.

Returning the Camera to Default Settings

When you have mistakenly changed a setting, you can reset the camera to the default settings.







1 Display the menu.

- Press the MENU button.



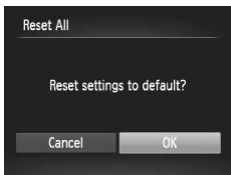
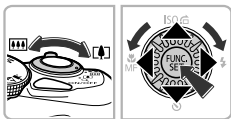

2 Choose [Reset All].

- Move the zoom lever to choose the  tab.
- Press the  buttons or turn the  dial to choose [Reset All], then press the  button.





3 Reset the settings.

- Press the  buttons or turn the  dial to choose [OK], then press the  button.
- ▶ The camera will reset to the default settings.



Are there functions that cannot be reset?

- The [Date/Time] (p. 19), [Language ] (p. 20), [Time Zone] (p. 155), [Video System] (p. 162) and the image registered in [Start-up Image] (p. 152) in the  tab.
- The recorded custom white balance data (p. 76).
- Colors that were chosen in Color Accent (p. 66) or Color Swap (p. 67).
- The Shooting mode chosen in **SCN** (p. 58) or  (p. 61).
- The Movie mode (p. 102).

Power Saving Function (Auto Power Down)

To save battery power, the screen turns off, and the camera turns off automatically when it is not operated for a certain time.

Power Saving during Shooting

The screen will turn off approximately 1 minute after you stop operating the camera. After about 2 more minutes, the lens will retract and the camera will turn off. When the screen has turned off but the lens has not yet retracted, pressing the shutter button halfway (p. 22) turns on the screen and shooting can continue.

Power Saving during Playback

The camera will turn off approximately 5 minutes after you stop operating the camera.







- You can turn off the power saving function (p. 154).
- You can adjust the time before the screen turns off (p. 155).

Clock Function

You can check the current time.



- Press and hold the  button.
- ▶ The current time appears.
- If you hold the camera vertically while using the clock function, it will switch to vertical display. Press the  buttons or turn the  dial to change the display color.
- Press the  button again to cancel the clock display.



- When the camera is off, press and hold the  button, then press the power button to display the clock.

3

Shooting with Commonly Used Functions

This chapter explains how to use common functions, such as the self-timer.

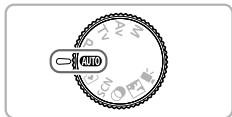

- This chapter assumes that the camera is set to **AUTO** mode. When shooting in another mode, check which functions are available in that mode (pp. 178 – 185).

Zooming In More Closely on Subjects (Digital Zoom)

You can use the digital zoom to zoom up to approximately 48x maximum, and capture subjects that are too far away for the optical zoom to enlarge.



1 Move the zoom lever toward .

- Hold the lever until zooming stops.
- ▶ Zooming stops at the largest possible zoom factor without image deterioration. The zoom factor will appear on the screen when you release the zoom lever.

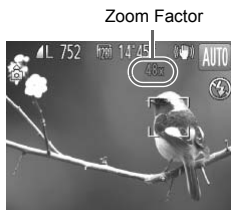

2 Move the zoom lever toward again.

- ▶ The digital zoom will zoom in even further on the subject.



Turning off the digital zoom

To turn off the digital zoom, press the **MENU** button to choose [Digital Zoom] in the  tab, then choose [Off].



- The focal lengths when using the optical zoom and digital zoom together are as follows (all focal lengths are 35mm film equivalent):
28 – 1344 mm (28 – 336 mm when using the optical zoom alone)
- Depending on the recording pixel setting (p. 54) and zoom factor, the images may appear coarse (the zoom factor will appear in blue).

Inserting the Date and Time

You can insert the shooting date and time in the lower right corner of an image. Once inserted, however, they cannot be deleted. Be sure to check beforehand that the date and time are correctly set (p. 18).

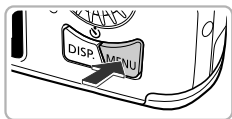



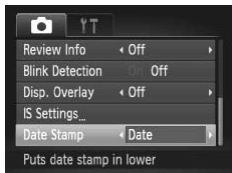

1 Display the menu.



- Press the **MENU** button.



2 Choose [Date Stamp].

- Move the zoom lever to choose the  tab.
- Press the   buttons or turn the  dial to choose [Date Stamp].

3 Choose the setting.

- Press the   buttons to choose [Date] or [Date & Time].
- Press the **MENU** button to complete the setting and restore the shooting screen.
- ▶ Once set, [DATE] will appear on the screen.

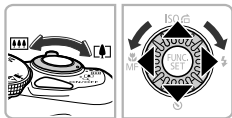

4 Shoot.

- ▶ The shooting date or time will be recorded in the image's lower right corner.
- To restore to the original setting, choose [Off] in Step 3.



You can insert and print the shooting date in images which do not have an embedded date and time as follows. However, if you do this for images with an embedded date and time, the date and time may be printed twice.





- **Use the DPOF print settings (p. 143) to print.**
- **Use the included software to print.**
Refer to the *Software Guide* for details.
- **Print using printer functions (p. 136).**

Using the Self-Timer

The self-timer can be used to shoot a group photo that includes the photographer. The camera will shoot approximately 10 seconds after the shutter button is pressed.



1 Choose .

- After pressing the ▼ button, press the ▲▼ buttons or turn the  dial to choose , then press the  button.
- ▶ Once set,  will appear on the screen.

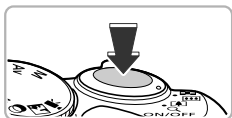

2 Shoot.

- Press the shutter button halfway to focus on the subject, then press it fully.
- ▶ When the self-timer starts, the lamp blinks and the self-timer sound plays.
- ▶ Two seconds before the shutter releases, the lamp and sound speed up (the lamp remains lit when the flash will fire).
- To cancel shooting with the self-timer after the countdown has started, press the **MENU** button.
- To restore the original setting, choose  in Step 1.





Using the Self-Timer to Prevent Camera Shake

The camera will shoot approximately 2 seconds after the shutter button is pressed, preventing any camera shake that occurs when pressing the shutter button.



Choose .

- Follow Step 1 on p. 52 to choose .
- ▶ Once set,  will appear on the screen.
- Follow Step 2 on p. 52 to shoot.

Customizing the Self-Timer

You can set the delay (0 – 30 seconds) and the number of shots (1 – 10 shots).

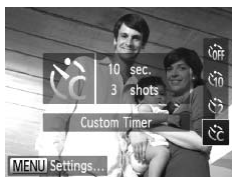





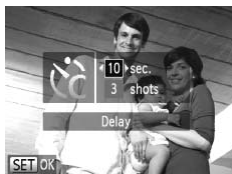

1 Choose .

- Follow Step 1 on p. 52 to choose , then press the **MENU** button immediately.



2 Choose the settings.

- Press the   buttons to choose [Delay] or [Shots].
- Press the   buttons or turn the  dial to choose a value, then press the  button.
- ▶ Once set,  will appear on the screen.
- Follow Step 2 on p. 52 to shoot.



- When 2 or more shots are set, the exposure and white balance settings are set with the first shot. If the flash fires or you set a high number of shots, the shooting interval may take longer than usual. Shooting will stop automatically if the memory card fills.
- When you set the delay for more than 2 seconds, the lamp and self-timer sound speed up 2 seconds before the shutter releases (the lamp remains lit when the flash will fire).

Changing the Recording Pixel Setting (Image Size)





You can choose from 5 recording pixel settings.



1 Choose the recording pixel setting.

- After pressing the  button, press the  buttons to choose .



2 Choose an option.

- Press the  buttons or turn the  dial to choose an option, then press the  button.
- ▶ The setting will appear on the screen.
- To restore to the original setting, choose  in Steps 1 – 2.



If you choose , you cannot use the digital zoom (p. 50) or digital teleconverter (p. 81).

Changing the Compression Ratio (Image Quality)



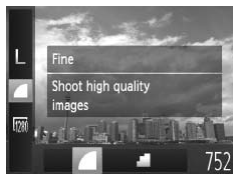

You can choose from the following 2 compression ratios (image quality):  (Fine),  (Normal).













1 Choose the compression ratio setting.

- After pressing the  button, press the  buttons to choose .

2 Choose an option.

- Press the  buttons or turn the  dial to choose an option, then press the  button.
- ▶ The setting will appear on the screen.
- To restore the original setting, choose  in Steps 1 – 2.

Approximate Values for Recording Pixels and Compression Ratio

Recording Pixels	Compression Ratio	Single Image Data Size (Approx. KB)	Number of Shots per Memory Card (Approx. shots)	
			4 GB	16 GB
L (Large) 14M/4320x3240		3597	1058	4334
		1719	2194	8985
M1 (Medium 1) 7M/3072x2304		1897	1978	8101
		902	4022	16473
M2 (Medium 2) 2M/1600x1200		558	6352	26010
		278	12069	49420
S (Small) 0.3M/640x480		150	20116	82367
		84	30174	123550
W (Widescreen) 3744x2104		2024	1856	7602
		968	3771	15443

* The values in the table are measured according to Canon standards and may change depending on the subject, memory card and camera settings.

Approximate Values for Paper Size

A2 (16.5 x 23.4 in.)	L
A3 – A5 (11.7 x 16.5 – 5.8 x 8.3 in.)	
5 x 7 in. Postcard size 3.5 x 5 in.	

- **S** For sending images as e-mail attachments.
- **W** For displaying on wide-screen HD TVs with an aspect ratio of 16:9.

4

Adding Effects and Shooting in Various Conditions

This chapter explains how to add effects and how to shoot in various conditions.

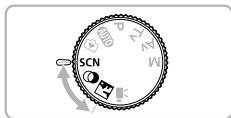

Shooting in Discreet Mode

You can shoot with camera sounds muted, and the flash and lamp deactivated. Use this mode in areas where camera sounds, lights and flash are not permitted.

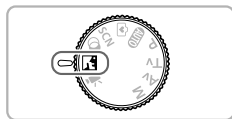

1 Enter mode.

- Set the mode dial to .

2 Shoot.



When the camera is set to  mode, sounds will remain muted even when in Playback mode. Operation sounds will be muted, and audio will not play back when viewing movies.

Shooting in Special Scenes

The camera will select the necessary settings for the conditions in which you wish to shoot when you choose the matching mode.







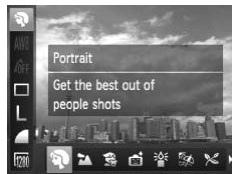

1 Enter **SCN** mode.

- Set the mode dial to **SCN**.



2 Choose a Shooting mode.

- After pressing the  button, press the  buttons to choose .
- Press the  buttons or turn the  dial to choose a Shooting mode, then press the  button.



3 Shoot.



Take portraits (Portrait)

- Produces a soft effect when photographing people.



Take landscapes (Landscape)

- Lets you shoot majestic landscapes with a real sense of depth.



Take shots of kids and pets (Kids&Pets)

- Lets you capture subjects that move around, such as children and pets, without missing photo opportunities.
- At maximum wide angle, move approximately 1 m (3.3 ft.) or more away from your subject. At maximum telephoto, move approximately 3 m (9.8 ft.) or more away from your subject and shoot.



Take shots in low light conditions (Low Light)

- Lets you take shots in dark places with reduced camera shake and subject blur.



At the beach (Beach)

- Lets you take shots of brightly lit people on sandy beaches where the reflected sunlight is strong.



Take shots of foliage (Foliage)

- Lets you shoot trees and leaves, such as new growth, autumn leaves or blossoms, in vivid colors.



Against snow (Snow)

- Lets you take bright, natural-colored shots of people against snowy backgrounds.





Take shots of fireworks (Fireworks)

- Lets you take shots of fireworks in vivid colors.



In  mode, attach the camera to a tripod to prevent the camera from moving and blurring the image. Additionally, you should set [IS Mode] to [Off] when shooting with a tripod (p. 159).



- In  mode, images may appear coarse because the ISO speed (p. 75) is increased to match the shooting conditions.
- In  mode, the recording pixel setting will be fixed at **M** (1600 x 1200 pixels).

Adding Effects and Shooting (Creative Filters)

You can add various effects to images when shooting.

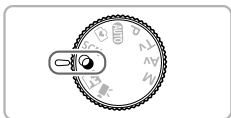





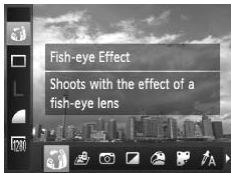

1 Enter mode.

- Set the mode dial to .







2 Choose a Shooting mode.

- After pressing the  button, press the  buttons to choose .
- Press the  buttons or turn the  dial to choose a Shooting mode, then press the  button.

3 Shoot.



Since you may not achieve the expected results with images shot in , , ,  and  modes, try taking some test shots first.



Shoot images with vivid colors (Super Vivid)

- Lets you take shots with vivid, intense colors.



Take posterized shots (Poster Effect)

- Lets you take shots that look like an old poster or illustration.

Shooting with the Effects of a Fish-Eye Lens (Fish-eye Effect)

Lets you shoot with the distorting effect of a fish-eye lens.



1 Choose .

- Follow Steps 1 – 2 on p. 61 to choose .

2 Choose an effect level.

- If you press the **DISP.** button, [Effect Level] will appear on the screen.
- Press the ◀▶ buttons or turn the  dial to choose an effect level, then press the **DISP.** button.
- ▶ You can check the effect on the screen.

3 Shoot.

Taking Shots That Look Like a Miniature Model (Miniature Effect)

Blurs chosen portions in the top and bottom of an image to produce the effect of a miniature model.

1 Choose .

- Follow Steps 1 – 2 on p. 61 to choose .
- ▶ A white frame (the area that will not be blurred) appears on the screen.





2 Choose the area to keep in focus.

- Press the DISP. button.
- Move the zoom lever to change the frame size, and press the ▲▼ buttons to change the frame position, then press the DISP. button.

3 Shoot.



- If you press the  button in Step 2, the horizontal/vertical orientation of the frame will switch, and you can press the ◀▶ buttons to change the frame position when it is displayed vertically.
- Holding the camera vertically will change the orientation of the frame.
- Be sure to set  (playback speed) before shooting a Miniature Effect movie (p. 104).

Shooting with the Effects of a Toy Camera (Toy Camera Effect)

This effect darkens and blurs the corners of the image, and changes the overall color so that it looks like an image shot with a toy camera.

1 Choose .

- Follow Steps 1 – 2 on p. 61 to choose .



2 Choose a color tone.

- Press the **DISP.** button.
- ▶ [Color Tone] will appear on the screen.
- Press the ◀▶ buttons or turn the  dial to choose a color tone, then press the **DISP.** button.
- ▶ You can check the color tone on the screen.

3 Shoot.

Standard	Images will look like they were shot with a toy camera.
Warm	Gives images a warmer tone than [Standard].
Cool	Gives images a cooler tone than [Standard].

Shooting in Monochrome

You can shoot images in black and white, sepia or blue and white.

1 Choose .

- Follow Steps 1 – 2 on p. 61 to choose .



2 Choose a color tone.

- Press the **DISP.** button.
- ▶ [Color Tone] will appear on the screen.
- Press the **◀▶** buttons or turn the  dial to choose a color tone, then press the **DISP.** button.
- ▶ You can check the color tone on the screen.

3 Shoot.

B/W	Lets you shoot black and white images.
Sepia	Lets you shoot sepia toned images.
Blue	Lets you shoot blue and white images.

Shooting with Color Accent

You can choose to retain a single color and change the rest to black and white in a composition.

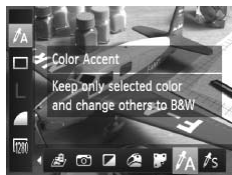

Recorded color

1 Choose .

- Follow Steps 1 – 2 on p. 61 to choose .

2 Press the **DISP.** button.

- ▶ The unchanged image and the Color Accent image will alternately display.
- ▶ The color for default settings is green.

3 Specify the color.

- Position the center frame so it is filled with the color you want and press the ◀ button.
- ▶ The specified color will be recorded.

4 Specify the range of colors.

- Press the ▲▼ buttons or turn the  dial to change the range of colors to be retained.
- Choose a negative value to limit the range of colors. Choose a positive value to extend the range of colors to similar colors.
- Press the **DISP.** button to complete the setting and restore the shooting screen.



- Using the flash may cause unexpected results in this mode.
- Depending on shooting conditions, the image may become coarse, or the colors may not come out as expected.

Shooting with Color Swap

You can swap one color in an image for another when recording it. You can only swap one color.

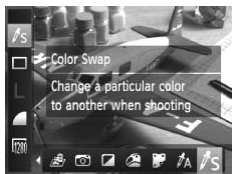

1 Choose \mathcal{I} s.

- Follow Steps 1 – 2 on p. 61 to choose \mathcal{I} s.



2 Press the DISP. button.

- ▶ The unchanged image and the Color Swap image will alternately display.
- ▶ The default setting is to change green to gray.



3 Specify the color to be swapped.

- Position the center frame so it is filled with the color you want and press the ◀ button.
- ▶ The specified color will be recorded.



4 Specify the target color.

- Position the center frame so it is filled with the color you want and press the ▶ button.
- ▶ The specified color will be recorded.

5 Specify the range of colors to be swapped.

- Press the ▲▼ buttons or turn the  dial to adjust the range of colors to be swapped.
- Choose a negative value to limit the range of colors. Choose a positive value to extend the range of colors to similar colors.
- Press the **DISP.** button to complete the setting and restore the shooting screen.



- Using the flash may cause unexpected results in this mode.
- Depending on shooting conditions, the image may become coarse, or the colors may not come out as expected.



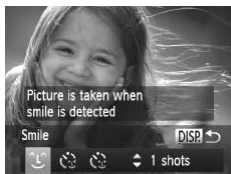

Detecting a Face and Shooting (Smart Shutter)

Detecting a Smile and Shooting

The camera will shoot, even without pressing the shutter button, when it detects a smile.





1 Choose ☺.

- Follow Steps 1 – 2 on p. 58 to choose , then press the **DISP.** button.
- Press the   buttons or turn the  dial to choose ☺, then press the **DISP.** button.
- ▶ The camera will enter shooting stand-by, and [Smile Detection on] will appear on the screen.



2 Point the camera at a person.

- Each time the camera detects a smile it will shoot after the lamp lights.
- Press the  button to pause smile detection. Press the  button again to resume smile detection.

? What if a smile is not detected?

Smiles are easier to detect if the subject faces the camera, and opens their mouth enough to show some teeth when smiling.

Changing the number of shots

After choosing ☺ in Step 1, press the   buttons.







- You should switch to another mode when you finish shooting, or the camera will continue taking shots each time the camera detects a smile.
- You can also shoot by pressing the shutter button.

Using the Wink Self-Timer

Point the camera at a person and press the shutter button fully. The camera will shoot approximately 2 seconds after it detects a wink.



1 Choose .

- Follow Steps 1 – 2 on p. 58 to choose , then press the **DISP.** button.
- Press the   buttons or turn the  dial to choose , then press the **DISP.** button.

2 Compose the shot and press the shutter button halfway.

- Confirm that a green frame appears around the face of the person who will wink.

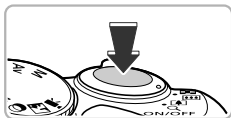

3 Press the shutter button fully.

- ▶ The camera will enter shooting stand-by, and [Wink to take picture] will appear on the screen.
- ▶ The lamp will blink and the self-timer sound will play.

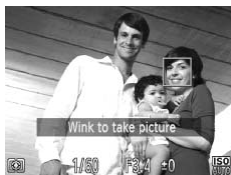

4 Face the camera and wink.

- ▶ The shutter will release approximately 2 seconds after a wink is detected from the person inside the frame.
- To cancel shooting with the self-timer after the countdown has started, press the **MENU** button.

What if a wink is not detected?

- Wink a bit slowly.
- A wink may not be detected if eyes are covered by hair or a hat, or when wearing glasses.



Changing the number of shots

After choosing  in Step 1, press the   buttons.







- Shutting both eyes will also be detected as a wink.
- If a wink is not detected, the shutter will release approximately 15 seconds later.
- If there are no people in the shot when the shutter button is pressed fully, the camera will shoot after a person enters the shot and winks.

Using the Face Self-Timer

The shutter will release approximately 2 seconds after the camera detects a new face (p. 83). You can use this when the photographer wants to be in the image, such as a group photo.



1 Choose .

- Follow Steps 1 – 2 on p. 58 to choose ,
- then press the DISP. button.
- Press the   buttons or turn the  dial to choose ,
- then press the DISP. button.

2 Compose the shot and press the shutter button halfway.

- Make sure a green frame appears on the face focused on and white frames appear on other faces.



3 Press the shutter button fully.

- ▶ The camera will enter shooting stand-by, and [Look straight at camera to start count down] will appear on the screen.
- ▶ The lamp will blink and the self-timer sound will play.



4 Join the subjects and look at the camera.

- ▶ When the camera detects a new face, the lamp and self-timer sound will speed up (the lamp remains lit when the flash will fire), and 2 seconds later the shutter will release.
- To cancel shooting with the timer after countdown has started, press the **MENU** button.



Changing the number of shots

After choosing  in Step 1, press the ▲▼ buttons.



Even if your face is not detected after joining the subjects, the shutter will release approximately 15 seconds later.

5

Choosing Settings Yourself

In this chapter you will learn how to use the various functions in **P** mode to progressively advance your shooting skills.

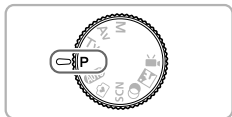

- This chapter assumes that you have set the mode dial to **P** mode.
- **P** stands for Program AE.
- Before attempting to shoot using a function explained in this chapter in modes other than **P** mode, check if the function is available in those modes (pp. 178 – 185).

Shooting in Program AE

You can choose the settings for various functions to suit your preferences. AE stands for Auto Exposure.

The focusing range is approximately 5 cm (2.0 in.) – infinity at maximum wide angle (📷), and approximately 1 m (3.3 ft.) – infinity at maximum telephoto (📷).



1 Enter **P** mode.

- Set the mode dial to **P**.

2 Adjust the settings according to your purposes (pp. 74 – 93).

3 Shoot.

? What if the shutter speed and aperture value appear in orange?

If a correct exposure cannot be obtained when pressing the shutter button halfway, the shutter speed and aperture value appear in orange. Try the following settings to obtain the correct exposure.

- Turn on the flash (see below)
- Choose a higher ISO speed (p. 75)

Turning the Flash On

You can make the flash fire every time you shoot. The effective flash range is approximately 50 cm – 3.0 m (1.6 – 9.8 ft.) at maximum wide angle (📷), and approximately 1.0 – 2.0 m (3.3 – 6.6 ft.) at maximum telephoto (📷).



1 Raise the flash.

2 Choose ⚡.

- After pressing the ▶ button, press the ◀▶ buttons or turn the 🔄 dial to choose ⚡, then press the **FUNC. SET** button.
- ▶ Once set, ⚡ will appear on the screen.

? What if the setting screen does not appear even when you press the ▶ button?

The flash is lowered. Raise the flash manually.

Adjusting the Brightness (Exposure Compensation)



You can adjust the standard exposure set by the camera in 1/3-stop increments in the range of -2 to +2.



1 Enter Exposure Compensation mode.

- Press the  button.





2 Adjust the brightness.

- While watching the screen, turn the  dial to adjust the brightness, then press the  button.
- ▶ The exposure compensation amount will appear on the screen.

Changing the ISO Speed



Choose the ISO speed.

- After pressing the  button, press the  buttons or turn the  dial to choose an option, then press the  button.
- ▶ The option you set will appear on the screen.

ISO
AUTO

Automatically adjusts the ISO speed to the Shooting mode and shooting conditions.

ISO 80 ISO 100 ISO 200

Low For shooting outdoors, in fine weather conditions.

ISO 400 ISO 800

↑
↓
For shooting in cloudy or twilight conditions.

ISO 1600

High For shooting nightscapes or in dark interiors.



Changing the ISO speed

- Lowering the ISO speed results in sharper images, but there may be an increased chance of image blurring in certain shooting conditions.
- Raising the ISO speed results in a faster shutter speed, reducing image blurring and letting the flash reach greater distances to the subject. The images, however, will appear coarse.



When the camera is set to , you can press the shutter button halfway to display the automatically set ISO speed.

Adjusting the White Balance



The white balance (WB) function sets the optimal white balance for natural looking colors to match the shooting conditions.









1 Choose the white balance function.

- After pressing the  button, press the  buttons to choose **AWB**.

2 Choose an option.

- Press the  buttons or turn the  dial to choose an option, then press the  button.
- ▶ The setting will appear on the screen.

 Auto	Automatically sets the optimal white balance for the shooting conditions.
 Day Light	For shooting outdoors, in fine weather conditions.
 Cloudy	For shooting in cloudy, shady or twilight conditions.
 Tungsten	For shooting under tungsten and bulb-type (3-wavelength) fluorescent lighting.
 Fluorescent	For shooting under warm-white fluorescent, cool-white fluorescent and warm-white-type (3-wavelength) fluorescent lighting.
 Fluorescent H	For shooting under daylight fluorescent and daylight-type (3-wavelength) fluorescent lighting.
 Custom	For manually setting a custom white balance (see below).

Custom White Balance

You can adjust the white balance to match the light source at the shooting location. Make sure that you set the white balance under the light source of the actual scene you will shoot.

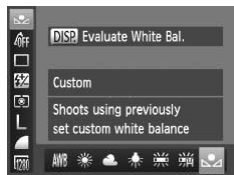

- In Step 2 above, choose .
- Make sure the entire screen is filled with a plain, white colored subject, then press the **DISP** button.
- ▶ The tint on the screen will change when white balance data is set.



If you change camera settings after recording white balance data, the tone may not turn out properly.

Continuous Shooting

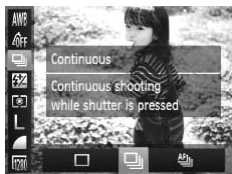

As long as you hold the shutter button down, the camera will shoot continuously.



1 Choose a Drive mode.





- After pressing the  button, press the  buttons to choose .



2 Choose an option.

- Press the  buttons or turn the  dial to choose an option, then press the  button.
 - ▶ The option you set will appear on the screen.

3 Shoot.

- ▶ As long as you hold the shutter button down, the camera will shoot successive images.

Mode	Maximum Speed (Approx. images/sec.)	Description
 Continuous	0.9	The camera shoots continuously with the focus and exposure set when the shutter button is pressed halfway.
 Continuous Shooting AF	0.6	The camera shoots continuously and focuses. The [AF Frame] is set to [Center].
 Continuous Shooting LV*	0.6	The camera shoots continuously with the focus fixed to the position set in manual focus. In  mode, the focus is locked on the first shot.

* When in  mode (p. 60), AF lock (p. 88) or manual focus modes (p. 86),  will change to .



- Cannot be used with the self-timer (p. 52).
- Continuous shooting speed increases in  mode (p. 59).
- Depending on the shooting conditions, camera settings and the zoom position, the camera may stop shooting momentarily, or the shooting speed may slow down.
 - As the number of images increases, the shooting speed may slow down.
 - If the flash fires, the shooting speed may slow down.

Changing the Tone of an Image (My Colors)

You can change the tone of an image, for example to sepia or black and white, when shooting.

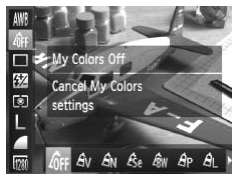

1 Choose My Colors.

- After pressing the button, press the buttons to choose .

2 Choose an option.

- Press the buttons or turn the dial to choose an option, then press the button.
- ▶ The setting will appear on the screen.

My Colors Off	—
Vivid	Emphasizes the contrast and color saturation for a vivid impression.
Neutral	Tones down the contrast and color saturation for neutral hues.
Sepia	Changes the image to sepia tones.
B/W	Changes the image to black and white.
Positive Film	Combines the effects of Vivid Red, Vivid Green and Vivid Blue to produce intense natural appearing colors like those obtained with positive film.
Lighter Skin Tone	Makes skin tones lighter.
Darker Skin Tone	Makes skin tones darker.
Vivid Blue	Emphasizes blue tints. Makes the sky, ocean and other blue subjects more vivid.
Vivid Green	Emphasizes green tints. Makes mountains, foliage and other green subjects more vivid.
Vivid Red	Emphasizes red tints. Makes red subjects more vivid.
Custom Color	You can adjust contrast, sharpness, and color saturation etc. to your preference (p. 79).



- The white balance cannot be set in and (p. 76).
- In and , colors other than people's skin color may change. You may not obtain the expected results with some skin colors.

Custom Color

The contrast, sharpness, color saturation, red, green, blue, and skin tones in an image can be chosen and set at 5 different levels.



- Follow Step 2 on p. 78 to choose \mathcal{C} , then press the DISP. button.
- Press the \blacktriangle / \blacktriangledown buttons to choose an option, then press the \blacktriangleleft / \blacktriangleright buttons or turn the \odot dial to choose a value.
- The more to the right, the stronger/darker (skin tone) the effect gets, the more to the left, the weaker/lighter (skin tone) the effect gets.
- Press the DISP. button to complete the setting.

Correcting the Brightness and Shooting (i-Contrast)

The camera can detect areas in the scene, such as faces or backgrounds, that are too bright or dark and automatically adjust them to the optimum brightness when shooting. Also, when the overall image is lacking in contrast, the camera will automatically correct the image for a sharper impression when shooting.





Choose [i-Contrast].

- Press the MENU button to choose [i-Contrast] in the \mathcal{C} tab, then press the \blacktriangleleft / \blacktriangleright buttons to choose [Auto].
- ▶ Once set, \mathcal{C}_i will appear on the screen.







- Under some conditions, the image may appear coarse or may not be corrected properly.
- You can correct recorded images (p. 132).

Shooting Close-ups (Macro)

If you set the camera to , it focuses on close subjects only. The focusing range is approximately 1 – 50 cm (0.4 in. – 1.6 ft.) from the end of the lens at maximum wide angle ().



Choose .

- After pressing the  button, press the  buttons or turn the  dial to choose , then press the  button.
- ▶ Once set,  will appear on the screen.



The edges of the image may darken if the flash fires.



How can I take better close-ups?

Try attaching the camera to a tripod and shooting in  to prevent the camera from moving and blurring the image (p. 53).



 will turn gray in the area that displays in the yellow bar underneath the zoom bar, and the camera will not focus.

Digital Tele-Converter

The focal length of the lens can be increased by 1.7x or 2.1x. This enables a faster shutter speed and less chance of camera shake than the zoom (including digital zoom) used by itself at the same zoom factor.



Choose [Digital Zoom].

- Press the **MENU** button to choose [Digital Zoom] in the tab, then press the buttons to choose an option.
- ▶ The view will be enlarged and the zoom factor will appear on the screen.



- The respective focal lengths when using [1.7x] and [2.1x] are 47.6 – 571.2 mm and 58.8 – 705.6 mm (35mm film equivalent).
- A recording pixel setting (p. 54) of **L** or **M1** will cause images to appear coarse (the zoom factor will appear in blue).
- The digital tele-converter cannot be used together with the digital zoom (p. 50).
- The shutter speeds may be the same when at maximum telephoto , and when zoomed in on the subject using Step 2 on p. 50.

Changing the AF Frame Mode

You can change the AF (Auto Focus) frame mode to match the scene you want to shoot.



Choose [AF Frame].

- Press the **MENU** button to choose [AF Frame] in the  tab, then press the **◀▶** buttons to choose an option.

Center

The AF frame is locked to the center. This is effective for focusing on a specific point.



You can reduce the AF frame size

- Press the **MENU** button to choose [AF Frame Size] in the  tab, then choose [Small].
- The AF frame is set to [Normal] when using the digital zoom (p. 50), digital teleconverter (p. 81), or manual focus (p. 86).



If the camera cannot focus when you press the shutter button halfway, the AF frame will turn yellow and  will appear.

Changing the Composition with the Focus Lock

While you keep the shutter button pressed halfway, the focus and exposure are locked. You can now recompose and shoot. This is called Focus Lock.



1 Focus.

- Center the subject you want in focus, and press the shutter button halfway.
- Confirm that the AF frame on the subject is green.



2 Recompose.

- Keep the shutter button pressed halfway and move the camera to recompose the scene.

3 Shoot.

- Press the shutter button fully.

Face Detect

- Detects people's faces and sets the focus, exposure (evaluative metering only) and white balance (AWB only).
- When the camera is pointed at subjects, a white frame appears on the face the camera judges to be the main subject, and gray frames (max. 2) will appear on other faces.
- A frame will follow a moving subject within a certain range.
- When the shutter button is pressed halfway, up to 9 green frames will appear on faces that the camera focuses on.



- If a face is not detected, or only gray frames (no white frame) appear, an AF frame will appear in the center of the screen when you press the shutter button halfway.
- If a face is not detected when Servo AF (p. 87) is set to [On], the AF frame will appear in the center of the screen when you press the shutter button halfway.
- Examples of faces that cannot be detected:
 - Subjects that are far away or extremely close
 - Subjects that are dark or light
 - Faces turned to the side or at an angle, or faces with a portion hidden
- The camera may mistakenly identify non-human subjects as a face.
- If the camera cannot focus when you press the shutter button halfway, the AF frame will not appear.

Tracking AF

You can choose the subject you want to focus on and shoot (p. 84).

Choosing the Subject to Focus On (Tracking AF)

You can choose the subject you want to focus on and shoot.



1 Choose [Tracking AF].

- Press the **MENU** button to choose [AF Frame] in the tab, then press the buttons to choose [Tracking AF].
- ▶ will appear in the center of the screen.



2 Choose the subject to focus on.

- Point the camera so that is on the subject you want to focus on and press the button.



- ▶ The camera will beep and will appear when a subject is detected. The camera will continue to track the subject within a certain range even if the subject moves.
- ▶ If the camera does not detect the subject, will appear on the screen.
- To cancel tracking, press the button again.

3 Shoot.

- Press the shutter button halfway. will change into a blue which will follow the subject while the camera continues to adjust the focus and exposure (Servo AF) (p. 87).
- Press the shutter button fully to shoot.
- ▶ Even after shooting completes, will appear, and the camera will continue to track the subject.



- The camera will detect a subject even if you press the shutter button halfway without pressing the ◀ button. When shooting completes, □ will appear in the center of the screen.
- Servo AF (p. 87) is fixed to [On].
- The camera may not be able to track the subject if the subject is too small, moves too quickly or if the contrast between the subject and the background is too low.
- When shooting in MF (p. 86), press the ◀ button for more than 1 second.
- Not available in 🌸.

Magnifying the Focal Point

If you press the shutter button halfway, the AF frame will magnify and you can check the focus.



1 Choose [AF-Point Zoom].

- Press the MENU button to choose [AF-Point Zoom] in the 📷 tab, then press the ◀▶ buttons to choose [On].



2 Check the focus.

- Press the shutter button halfway.
- ▶ In [Face Detect] (p. 83), the face detected as the main subject will appear magnified.
- ▶ In [Center] (p. 82), the contents of the center AF frame will appear magnified.



What if the display does not magnify?

The display will not appear magnified in [Face Detect] if a face cannot be detected or is too big in relation to the screen. In [Center], it will not appear magnified if the camera cannot focus.



The magnified display will not appear when using the digital zoom (p. 50), digital tele-converter (p. 81), Tracking AF (p. 84), Servo AF (p. 87) or when using a TV as a display (p. 162).

Shooting in Manual Focus Mode

You can use manual focus when auto focus is not possible. If you press the shutter button halfway after roughly focusing manually, you can fine tune the focus.



1 Choose MF.

- After pressing the button, press the buttons or turn the dial to choose **MF**, then press the button.
- ▶ **MF** and the MF indicator appear.



MF Indicator

2 Focusing roughly.

- The side bar shows your focal point and a distance display for the MF indicator. While looking at the magnified area, turn the dial to find an approximate focus.

3 Fine tuning the focus.

- If you press the shutter button halfway, you can fine tune the focus (Safety MF).



- You cannot change the AF frame mode or size while focusing manually (p. 82). If you want to change the AF frame mode or size, cancel manual focus mode first.
- In order to focus accurately, try attaching the camera to a tripod.
- When using the digital zoom (p. 50), digital tele-converter (p. 81), or when using a TV as a display (p. 162), you will be able to focus but the magnified area will not display.
- If you press the **MENU** button to display the tab and set [MF-Point Zoom] to [Off], the magnified display will not be available.
- If you press the **MENU** button to display the tab and set [Safety MF] to [Off], you will not be able to fine tune the focus even if you press the shutter button halfway.

Shooting with Servo AF

While the shutter button is pressed halfway, the focus and exposure will continue to adjust, allowing you to take pictures of moving subjects without missing a shot.



1 Choose [Servo AF].

- Press the **MENU** button to choose [Servo AF] in the  tab, then press the **◀▶** buttons to choose [On].

2 Focus.

- The focus and exposure will be maintained where the blue AF frame appears while you press the shutter button halfway.



- The camera may not be able to focus in some conditions.
- In low light conditions, AF frames may not turn blue even after pressing the shutter button halfway. In this case, you can set the focus and exposure with the AF frame setting.
- If a correct exposure cannot be obtained, the shutter speed and aperture value appear in orange. Release your finger from the shutter button, then press it again halfway.
- You cannot shoot with the AF lock in this mode.
- The [AF-Point Zoom] option in the  tab is not available in Servo AF mode.
- Not available when using the self-timer (p. 52).

Shooting with the AF Lock

The focus can be locked. After locking the focus, the focal distance will not change even when you release your finger from the shutter button.

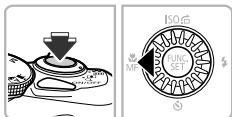

1 Lock the focus.

- Keep the shutter button pressed halfway and press the **▲** button.
- ▶ The focus locks, and **MF** and the MF indicator appear on the screen.
- After you release your finger from the shutter button, press the **▲** button again, then press the **◀▶** buttons or turn the **FUNC. SET** dial to choose **▲**. The focus will unlock.

2 Compose the scene and shoot.

Changing the Metering Method

You can change the metering method (brightness measuring function) to match the shooting conditions.



1 Choose the metering method.

- After pressing the **FUNC. SET** button, press the **▲▼** buttons to choose **☒**.

2 Choose an option.

- Press the **◀▶** buttons or turn the **FUNC. SET** dial to choose an option, then press the **FUNC. SET** button.
- ▶ The setting will appear on the screen.





<input checked="" type="checkbox"/> Evaluative	For standard shooting conditions, including back lit shots. Automatically adjusts the exposure to match the shooting conditions.
<input type="checkbox"/> Center Weighted Avg.	Averages the light metered from the entire frame, but gives greater weight to the center.
<input type="checkbox"/> Spot	Only meters within the [] (Spot AE Point frame) that appears at the center of the screen.

Shooting with the AE Lock

You can lock the exposure and shoot, or set the focus and exposure separately to shoot. AE stands for “Auto Exposure”.



1 Lock the exposure.

- Point the camera toward the subject and press the  button while pressing the shutter button halfway.
- ▶ When  appears, the exposure will be locked.
- If you release your finger from the shutter button and press the  button again,  will disappear and AE will unlock.

2 Compose the scene and shoot.

- When you shoot one image,  will disappear and AE will unlock.



Program Shift

If you lock the exposure and turn the  dial, you can change the shutter speed and aperture value combination.

Shooting with the FE Lock

Just as with the AE lock (see above), you can lock the exposure for shooting with the flash. FE stands for “Flash Exposure”.

1 Choose (p. 74).



2 Lock the flash exposure.

- Point the camera toward the subject and press the  button while pressing the shutter button halfway.

- ▶ The flash will fire and when ✱ appears, the flash output will be retained.
- If you release your finger from the shutter button and press the  button again, ✱ will disappear and FE will unlock.

3 Compose the scene and shoot.

- When you shoot one image, ✱ will disappear and FE will unlock.

Adjusting the Flash Exposure Compensation





Just as with exposure compensation (p. 75), you can adjust the exposure from -2 to +2 stops in 1/3-stop increments when using the flash.



1 Choose .

- After pressing the  button, press the   buttons to choose .

2 Choose the amount of flash exposure compensation.





- Press the   buttons or turn the  dial to choose the amount of flash exposure compensation, then press the .
- ▶ Once set,  will appear on the screen.



Safety FE

The camera automatically changes the shutter speed or aperture value when the flash fires to avoid overexposing and blowing out the highlights in the scene. However, if you press the **MENU** button to display the  tab and set [Safety FE] in [Flash Settings] to [Off], the shutter speed and aperture value will not automatically adjust.



- You can also set the flash exposure compensation by pressing the **MENU** button to choose [Flash Settings] (p. 92) in the  tab, then choose [Flash Exp. Comp] and press the   buttons to choose a setting.
- If you press the  button and immediately press the **MENU** button when the flash is raised, the settings screen will appear.

Shooting with Slow Synchro

You can make the main subject, such as people, appear bright by having the camera provide the appropriate illumination with the flash. At the same time, you can use a slow shutter speed to brighten the background that the light from the flash cannot reach.

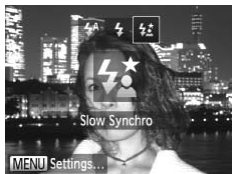

1 Raise the flash.

2 Choose .

- After pressing the  button, press the  buttons or turn the  dial to choose , then press the  button.
- ▶ Once set,  will appear on the screen.

3 Shoot.

- Even if the flash fires, ensure that the main subject does not move until the shutter sound ends.



Attach the camera to a tripod to prevent the camera from moving and blurring the image. Additionally, you should set [IS Mode] to [Off] when shooting with a tripod (p. 159).



What if the setting screen does not appear even when you press the  button?

The flash is lowered. Raise the flash manually.

Red-Eye Correction

You can automatically correct red-eye that occurs in images taken with the flash.

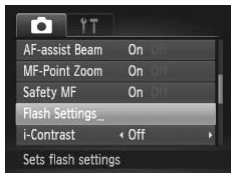

1 Choose [Flash Settings].

- Press the **MENU** button to choose [Flash Settings] in the tab, then press the button.

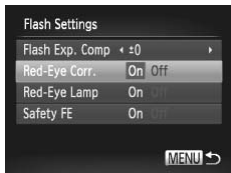

2 Choose the setting.

- Press the or turn the to choose [Red-Eye Corr.], then press the to choose [On].
- ▶ Once set, will appear on the screen.



Red-eye correction may be applied to areas other than red eyes. For example, when red make-up has been used around eyes.





- You can also correct recorded images (p. 133).
- If you press the then immediately press the **MENU** button when the flash is raised, the screen in Step 2 will appear.

Checking for Shut Eyes

When the camera detects the possibility that people have their eyes shut,  appears on the screen.







1 Choose [Blink Detection].

- Press the **MENU** button to choose [Blink Detection] in the  tab, then press the   buttons to choose [On].

2 Shoot.

- ▶ When a person with shut eyes is detected, a frame and  appear on the screen.



- This function is only available for the last image shot when you have set the camera to 2 or more shots in  or  mode.
- Not available in ,  or  mode.

6

Getting More Out of Your Camera

This chapter explains how to shoot in **Tv**, **Av** and **M** modes.

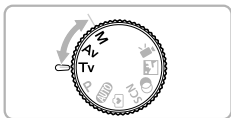

- This chapter assumes that the camera has been set to the corresponding mode.

Setting the Shutter Speed

You can set the shutter to the speed at which you want to shoot. The camera will set the appropriate aperture value for the shutter speed you set.

Tv stands for “Time value”.



- 1 **Set the mode dial to Tv.**
- 2 **Adjust the setting.**
 - Turn the  dial to set the shutter speed.
- 3 **Shoot.**

Available Shutter Speeds

15", 13", 10", 8", 6", 5", 4", 3"2, 2"5, 2", 1"6, 1"3, 1", 0"8, 0"6, 0"5, 0"4, 0"3, 1/4, 1/5, 1/6, 1/8, 1/10, 1/13, 1/15, 1/20, 1/25, 1/30, 1/40, 1/50, 1/60, 1/80, 1/100, 1/125, 1/160, 1/200, 1/250, 1/320, 1/400, 1/500, 1/640, 1/800, 1/1000, 1/1250, 1/1600, 1/2000, 1/2500

- 2" indicates 2 seconds, 0"3 indicates 0.3 second and 1/160 indicates 1/160 second.
- The fastest shutter speed when using the flash is 1/2000 second. The camera automatically resets the shutter speed to 1/2000 second if a faster shutter speed is chosen.
- Depending on the zoom position, some shutter speeds may not be available.



- When shutter speeds of 1.3 seconds or slower are used, images are processed to reduce noise after being taken. A certain amount of processing time may be needed before you can take the next shot.
- You should set [IS Mode] to [Off] when lowering the shutter speed and shooting with a tripod (p. 159).



What if the aperture value appears in orange?

If the aperture value appears in orange when the shutter button is pressed halfway, the scene has exceeded the correct exposure limits. Adjust the shutter speed until the aperture value appears in white (Safety shift can also be used (p. 97)).

Setting the Aperture Value

You can set the aperture to a value at which you want to shoot. The camera will set the appropriate shutter speed for the aperture value you set.

Av stands for “Aperture value”, which refers to the size of the aperture opening inside the lens.



- 1 Set the mode dial to **Av**.
- 2 Adjust the setting.
 - Turn the  dial to set the aperture value.
- 3 Shoot.

Available Aperture Values

F3.4, F3.5, F4.0, F4.5, F5.0, F5.6, F6.3, F7.1, F8.0

- Depending on the zoom position, some aperture values may not be available.

What if the shutter speed appears in orange?

If the shutter speed appears in orange when the shutter button is pressed halfway, the scene has exceeded the correct exposure limits. Adjust the aperture value until the shutter speed appears in white. Safety shift can also be used (see below).

Safety Shift

In **Tv** and **Av** modes, if you press the **MENU** button to display the  tab, and set [Safety Shift] to [On], the shutter speed or aperture value is automatically adjusted for the correct exposure when it cannot otherwise be obtained. Safety Shift is disabled when the flash is enabled.

Setting the Shutter Speed and Aperture Value

You can manually set the shutter speed and aperture to shoot images with the exposure you want.

M stands for “Manual”.

1 Set the mode dial to **M**.



Shutter Speed



Aperture Value

Standard Exposure Level



Exposure Level

Exposure Level Indicator

2 Choose a setting.

- Press the  button to choose the shutter speed or aperture value.
- Turn the  dial to set a value.
- ▶ The set exposure level appears on the indicator. You can check the difference against the standard exposure level.
- ▶ When the difference is more than ± 2 stops, the set exposure level appears in orange. When you press the shutter button halfway, “-2” or “+2” appears in orange.



- The standard exposure is calculated according to the metering method chosen (p. 88).
- If you use the zoom or change the composition after making settings, the exposure level may change.
- Depending on the shutter speed or aperture value set, the screen brightness may change. If the flash is raised and set to , the screen brightness will not change.
- If you press the  button while holding down the shutter button halfway, the shutter speed or aperture value (whichever is not chosen in Step 2), will automatically adjust to obtain the correct exposure (the correct exposure may not be obtained depending on the settings).

Adjusting the Flash Output

In **M** mode, you can choose 3 levels of flash output.







1 Set the mode dial to **M**.





2 Choose the flash output level.

- After pressing the  button, press the   buttons to choose .

3 Complete the setting.

- Press the   buttons or turn the  dial to choose the flash output level, then press the  button.
- ▶ Once set,  will appear on the screen.



- You can also set the flash output level by pressing the **MENU** button to choose [Flash Settings] (p. 92) in the  tab, then choose [Flash Output] and press the   buttons to choose a setting.
- In **Tv** and **Av** modes, you can set the flash output level if you press the **MENU** button to choose [Flash Settings] in the  tab, then set [Flash Mode] to [Manual].
- If you press the  button then immediately press the **MENU** button when the flash is raised, the settings screen will appear.

7

Using Various Functions for Shooting Movies

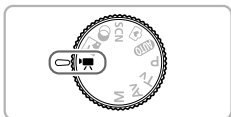

This chapter serves as a more advanced version of the “Shooting Movies” and “Viewing Movies” sections in Chapter 1, and explains how to use various functions for shooting and viewing movies.

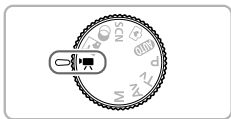

- This chapter assumes that you have set the mode dial to . However, even if the mode dial is set to a position other than , movies can be shot by pressing the movie button.
- The latter half of the chapter explaining movie playback and editing assumes that you have pressed the button to enter Playback mode.

Shooting Movies in Mode







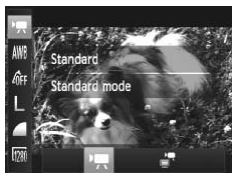

- 1 Enter  mode.**
 - Set the mode dial to .
- 2 Adjust the settings according to your purposes (pp. 102 – 108).**
- 3 Shoot.**
 - Press the movie button.
 - To stop shooting the movie, press the movie button again.



Changing the Movie Mode

You can choose among 2 different Movie modes.



Choose a Movie mode.



- After pressing the  button, press the  buttons to choose .
- Press the  buttons or turn the  dial to choose a Movie mode, then press the  button.

 Standard	Shoots standard movies.
 iFrame Movie	Shoots movies that can be edited with iFrame ^{*1} compatible software ^{*2} or devices. The recording pixel setting will be fixed at  (p. 106).

*1 Video type advocated by Apple.

*2 You can quickly edit and save iFrame movies if you use the included software.



Even in  and  modes, you can shoot still images when you press the shutter button. However, this is not possible while shooting a movie.

Shooting Various Kinds of Movies

Just as with still images, you can let the camera select the best settings for the scene or add various effects while shooting movies.















1 Choose a Shooting mode.

- Follow Steps 1 – 2 on p. 58, or Steps 1 – 2 on p. 61 to choose a Shooting mode.

2 Shoot.

- Press the movie button.
- ▶ Depending on the Shooting mode or movie image quality (p. 106) you choose, black bars may appear on the top and bottom of the screen. These areas will not be recorded.
- To stop shooting the movie, press the movie button again.

 Portrait	p. 59
 Landscape	p. 59
 Miniature Effect	p. 104
 Monochrome	p. 65
 Super Vivid	p. 61
 Poster Effect	p. 61

 Color Accent	p. 66
 Color Swap	p. 67
 Beach	p. 59
 Foliage	p. 60
 Snow	p. 60
 Fireworks	p. 60



- You can also record movies in other Shooting modes by pressing the movie button.
- Certain settings made in the FUNC. and Shooting menus may automatically change to match settings for shooting movies.

Shoot Movies That Look Like a Miniature Model (Miniature Effect)

You can shoot movies that look like moving miniature models. You create the miniature model effect by choosing the upper and lower portions of the scene that will be blurred, and the playback speed, which makes people and objects in the scene move quickly during playback. Audio will not be recorded.

1 Choose .

- Follow Steps 1 – 2 on p. 61 to choose .
- ▶ A white frame (the area that will not be blurred) appears on the screen.



2 Choose the area to keep in focus.

- Press the **DISP.** button.
- Move the zoom lever to change the frame size, and press the **▲▼** buttons to change the frame position.

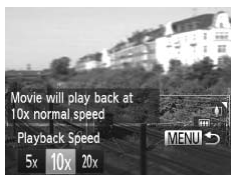

3 Choose a playback speed.

- Press the **MENU** button.
- Press the **◀▶** buttons or turn the  dial to choose a playback speed.
- Press the **MENU** button to complete the setting and restore the shooting screen.

4 Shoot.

- Press the movie button.
- To stop shooting the movie, press the movie button again.

Playback Speeds and Estimated Playback Times (for 1 Min. Clips)

Speed	Playback Time
5x	Approx. 12 sec.
10x	Approx. 6 sec.
20x	Approx. 3 sec.



- The image quality will be fixed at $\overline{640}$ when a recording pixel setting of \overline{L} is chosen, and $\overline{1280}$ when a recording pixel setting of \overline{W} is chosen (p. 54).
- If you press the  button in Step 2, the horizontal/vertical orientation of the frame will switch, and you can press the \blacktriangleleft buttons to change the frame position when it is displayed vertically.
- Holding the camera vertically will change the orientation of the frame.
- Since you may not achieve the expected results depending on the shooting conditions, try taking some test shots first.

Changing the Image Quality

You can choose among 2 different image quality settings.

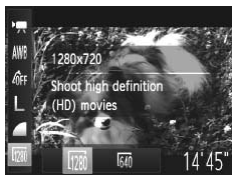

1 Choose the image quality setting.

- After pressing the  button, press the  buttons to choose .

2 Choose an option.





- Press the  buttons or turn the  dial to choose an option, then press the  button.
- ▶ The option you set will appear on the screen.



Image Quality and Shooting Time per Memory Card

Image Quality	Recording Pixels, Frame Rate	Content	Memory Card Capacity	
			4 GB	16 GB
	1280 x 720 pixels, 30 frames/sec.	For shooting high-definition (HD) movies.	Approx. 20 min. 43 sec.* ¹	Approx. 1 hr. 24 min. 54 sec.* ²
	640 x 480 pixels, 30 frames/sec.	For shooting standard definition (SD) movies.	Approx. 43 min. 43 sec.	Approx. 2 hr. 59 min. 3 sec.* ²

*¹ 13 min. 35 sec. for iFrame movies (p. 102).

*² 55 min. 38 sec. for iFrame movies (p. 102).

• Based on Canon's testing standards.

• Recording will automatically stop when the clip file size reaches 4 GB, or when the recording time reaches approximately 29 minutes and 59 seconds when shooting in , and approximately 1 hour when shooting in .

• Recording may stop even if the maximum clip length has not been reached on some memory cards. SD Speed Class 6 or higher memory cards are recommended.



In , black bars appear on the top and bottom of the screen. These areas cannot be recorded.

AE Lock/Exposure Shift

You can lock the exposure or change it in 1/3 steps within a range of -2 to +2 before shooting.



1 Lock the exposure.

- Press the **▲** button to lock the exposure. The exposure shift bar appears.
- Press the **▲** button again to release the lock.

2 Change the exposure.

- While watching the screen, turn the  dial to adjust the exposure.

3 Shoot.

- Press the movie button.
- To stop shooting the movie, press the movie button again.

Using the Wind Filter

Wind Filter suppresses noise when the wind is strong. However, unnatural sound may result when used to record in locations with no wind.



- Press the **MENU** button to choose [Wind Filter] in the  tab, then press the **◀▶** buttons to choose [On].

Other Shooting Functions

The following functions can be used in the same way as for still images. However, depending on the Shooting mode, settings may not be available or may not have any effect.

- **Zooming in More Closely On Subjects**
The sound of zoom operations will be recorded.
- **Using the Self-Timer (p. 52)**
The number of shots cannot be set.
- **Adjusting the White Balance (p. 76)**
White balance compensation is not available.
- **Changing the Tone of an Image (My Colors) (p. 78)**
- **Shooting Close-ups (Macro) (p. 80)**
- **Shooting in Manual Focus Mode (p. 86)**
- **Shooting with the AF Lock (p. 88)**
- **Turning Off the AF Assist Beam (p. 157)**
- **Displaying the Overlay (p. 158)**
[3:2 Guide] is not available.
- **Changing the IS-Mode Settings (p. 159)**
You can switch between [Continuous] and [Off].
- **Shooting Using a TV as the Display (p. 162)**

Editing

You can trim the beginnings and ends of recorded movies.



Movie Editing Panel



















Movie Editing Bar









1 Choose .

- Follow Steps 1 – 3 on p. 32 to choose , then press the  button.
- ▶ The movie editing panel and the movie editing bar will appear.

2 Set the editing range.



- Press the  buttons to choose  or .
- If you press the  buttons or turn the  dial to move ,  will appear at points where the movie can be edited. If you choose , you can trim the beginning of the movie from . If you choose , you can trim the end of the movie from .
- Even if you move  to a point other than a , only the portion from the nearest  to the left will be trimmed when  is chosen. Only the portion from the nearest  to the right will be trimmed when  is chosen.

3 Check the edited movie.

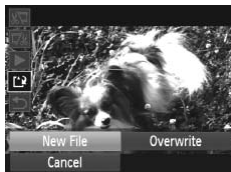
- Press the  buttons to choose , then press the button. The edited movie will play.
- To edit the movie again, repeat Step 2.
- To cancel editing, press the  buttons to choose . After pressing the  button, press the  buttons or turn the  dial to choose [OK], then press the  button again.



4 Save the edited movie.

- Press the ▲▼ buttons to choose [↵], then press the  button.
- Press the ▲▼◀▶ buttons or turn the  dial to choose [New File], then press the  button.
- ▶ The movie will be saved as a new file.



- When [Overwrite] is chosen in Step 4, the unedited movie is overwritten with the edited movie, erasing the original.
- When there is not enough space left on the memory card, only [Overwrite] can be chosen.
- If the batteries are depleted partway through saving, the edited movie clips may not be saved.
- When editing movies, you should use batteries with sufficient charge, fully charged NiMH AA batteries (p. 192) or an AC adapter kit and DC coupler (all sold separately) (p. 192).

8

Using Various Playback and Editing Functions

This chapter explains various ways to play back and edit images.

- Press the  button to enter Playback mode before operating the camera.



- It may not be possible to play back or edit images that have been edited on a computer, have had their file names changed, or have been taken on a different camera.
- The edit function (pp. 129 – 133) cannot be used if the memory card does not have enough free space available.



Quickly Searching Images

Searching Images Using Index Display

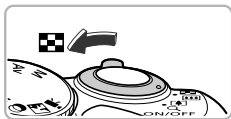
Displaying multiple images at the same time lets you quickly find the image you want.









1 Move the zoom lever toward .

- ▶ Images will display in an index.
- The number of images increases each time you move the lever toward .
- The number of images decreases each time you move the lever toward .



2 Choose an image.





- Turn the  dial to switch images.
- Press the     buttons to choose an image.
- ▶ An orange  frame appears on the chosen image.
- Press the  button to display the chosen image by itself.

Searching Images by Scrolling

Turning the  dial will display images in a line letting you quickly search them. You can also jump by the shooting date (Scroll Display).



Choose an image.





- If you set the camera to single image playback and turn the  dial quickly, the images will display as shown on the left. Turn the  dial to choose an image.
- Press the  button to restore single image playback.
- Press the   buttons during scroll display to search images by the shooting date.



To turn off this effect, press the **MENU** button to choose [Scroll Display] in the  tab, then choose [Off].

Viewing Images in Filtered Playback

When there are many images on the memory card, you can filter and display them by a specified filter. You can also protect (p. 119) or erase (p. 123) images at once while filtered.









 Jump to Favorites	Displays the images tagged as favorites (p. 125)
 Jump Shot Date	Displays the images shot on a specified date.
 Jump to My Category	Displays the images of a specified category (p. 126).
 Jump to Still/Movie	Displays either still images or movies.
 Jump 10 Images	Jumps over 10 images at a time.
 Jump 100 Images	Jumps over 100 images at a time.

Search by , , and









Target Filters

1 Choose a target filter.

- In single image playback, press the  button, then press the   buttons to choose a jump method.
- In , , or , press the   buttons to choose a filter. Turning the  dial will only display images that match the filter of the chosen target image.
- Press the **DISP.** button to switch between Information Display and No Information Display.
- Press the **MENU** button to restore single image playback.

2 View the filtered images.

- Press the  button to start filtered playback. The jump method and a yellow frame will appear.
- If you press the   buttons or turn the  dial, the chosen target images will display.
- If you press the  button, [Filtered playback settings cleared] appears on the screen. Press the  button to cancel filtered playback.



? What if you cannot choose a filter?

Filters that do not have any corresponding images cannot be chosen.

💡 Filtered playback

In filtered playback (Step 2), you can view filtered images with “Quickly Searching Images” (p. 112), “Viewing Slideshows” (p. 115), and “Magnifying Images” (p. 117). You can process all filtered images at once while performing operations in “Protecting Images” (p. 119), “Erasing Images” (p. 123), “Choosing Images for Printing (DPOF)” (p. 143), or “Choosing Images for a Photobook” (p. 147) by choosing all of the filtered images.

However, if you change the category (p. 126), or edit an image and save it as a new image (p. 129), a message will appear, and filtered playback will cancel.

Jump by 10 and 100 Images



- In single image playback, press the button, then press the buttons to choose a jump method.
- If you press the buttons, the display will advance to the image that is the chosen number of images away.
- Press the **MENU** button to restore single image playback.

Viewing Slideshows

You can automatically play back images recorded to a memory card.



1 Choose [Slideshow].

- Press the **MENU** button to choose [Slideshow] in the tab, then press the button.



2 Choose a setting.

- Press the or turn the dial to choose a menu item, then press the buttons to adjust the setting.

Repeat	Repeats playback of images
Play Time	Display time for each image
Effect	Transition effects when switching between images

3 Choose [Start].

- Press the or turn the dial to choose [Start], then press the button.
 - ▶ The slideshow will start a few seconds after [Loading image...] appears on the screen.
- You can pause/restart a slideshow by pressing the button again.
- Press the **MENU** button to stop the slideshow.



- If you press the or turn the dial during playback, the image will switch. If you keep the pressed, you can fast-forward through images.
- The power saving function (p. 48) does not work during slideshows.
- You cannot change [Play Time] if [Bubble] is chosen in [Effect].

Checking the Focus

You can magnify the area of a recorded image that was inside the AF Frame to check the focus.

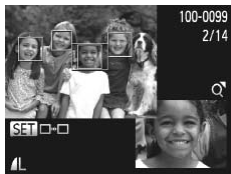

1 Press the **DISP.** button to switch to the focus check display (p. 40).

- ▶ A white frame will appear where the AF frame was when the focus was set.
- ▶ A gray frame will appear on a face detected during playback.
- ▶ The area within the orange frame appears magnified.



2 Switch frames.

- Move the zoom lever toward **Q** once.
- ▶ The screen shown on the left will appear.
- Press the **FUNC/SET** button to move to a different frame when multiple frames appear.

3 Change the magnification level or location.

- Use the zoom lever to change the display size, and the **▲▼◀▶** buttons to change the display position while checking the focus.
- Press the **MENU** button to reset the display to Step 1.









The focus check display is not available for movies.

Magnifying Images



Approximate Location of Displayed Area

Move the zoom lever toward .

- The display will zoom in on the image. If you continue to hold the zoom lever, it will zoom in up to a maximum factor of approximately 10x.
- If you press the     buttons, you can move the location of the displayed area.
- Move the zoom lever toward  to zoom out, or continue to hold it to return to single image playback.
- If you turn the  dial, you can switch images while zoomed.





- In magnified display, pressing the **MENU** button restores single image playback.
- Movies cannot be magnified.

Displaying Various Images (Smart Shuffle)

The camera will choose 4 images based on the displayed image. If you choose one of those images, the camera will select 4 more images letting you enjoy playing back images in an unexpected order. This will work best if you take many shots of various scenes.



1 Choose [Smart Shuffle].

- Press the **MENU** button to choose [Smart Shuffle] in the  tab, then press the  button.
- ▶ Four images will appear as possibilities.



2 Choose an image.

- Press the **▲▼◀▶** buttons to choose the image you want to view next.
- ▶ The chosen image will be displayed in the center, and the next 4 possibilities will appear.
- Press the **FUNC SET** button to display the center image at full size. Press the **FUNC SET** button again to restore the original display.
- Press the **MENU** button to restore single image playback.



- Only still images shot with this camera will play back in Smart Shuffle.
- [Smart Shuffle] is not available in the following situations:
 - If there are less than 50 images taken with this camera on the memory card
 - If you play back images not supported by Smart Shuffle
 - During filtered playback

Changing Image Transitions

You can choose from 3 transition effects when switching between images in single image playback.

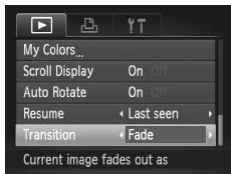

Choose [Transition].

- Press the **MENU** button to choose [Transition] in the **▶** tab, then press the **◀▶** buttons to choose a transition effect.



Protecting Images

You can protect important images so that they cannot be accidentally erased with the camera (pp. 28, 123).

Choosing a Selection Method



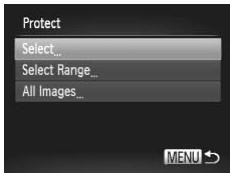

1 Choose [Protect].

- Press the **MENU** button to choose [Protect] in the  tab, then press the  button.



2 Choose a selection method.

- Press the  buttons or turn the  dial to choose a selection method, then press the  button.
- Press the **MENU** button to complete the setting and restore the menu screen.



If you format the memory card (pp. 21, 151), protected images will also be erased.



Protected images cannot be erased with the camera's erase function. To erase an image, cancel protection settings first.





Choosing Images Individually





1 Choose [Select].

- Follow Step 2 on p. 119 to choose [Select], then press the  button.

2 Choose images.

- Press the ◀▶ buttons or turn the  dial to choose an image, then press the  button.
- ▶  will appear on the screen.
- Press the  button again to deselect the image.  will disappear.
- To choose additional images, repeat the above procedure.

3 Protect the image.

- If you press the MENU button, a confirmation screen will appear.
- Press the ◀▶ buttons or turn the  dial to choose [OK], then press the  button.



If you switch to Shooting mode or turn off the camera before performing the operations in Step 3, images will not be protected.

Selecting a Range

1 Choose [Select Range].





- Follow Step 2 on p. 119 to choose [Select Range], then press the  button.



2 Choose a starting image.

- Press the  button.







- Press the   buttons or turn the  dial to choose an image, then press the  button.

3 Choose an ending image.

- Press the  button to choose [Last image], then press the  button.



- Press the   buttons or turn the  dial to choose an image, then press the  button.



- You cannot choose images before the first image.



4 Protect images.

- Press the ▼ button to choose [Protect], then press the  button.



Choosing images with the dial

You can also choose the first or last image by turning the  dial when the upper screen in Steps 2 and 3 is displayed.



Choosing All Images

1 Choose [All Images].

- Follow Step 2 on p. 119 to choose [All Images], then press the  button.



2 Protect images.

- Press the ▲▼ buttons or turn the  dial to choose [Protect], then press the  button.



You can unlock groups of protected images if you choose [Unlock] in Step 4 in “Selecting a Range”, or Step 2 in “Choosing All Images”.

Erasing Images

You can choose images and then erase them in groups. Since erased images cannot be recovered, exercise adequate caution before erasing. Protected images (p. 119) cannot be erased.

Choosing a Selection Method



1 Choose [Erase].

- Press the **MENU** button to choose [Erase] in the tab, then press the button.

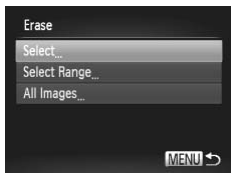

2 Choose a selection method.

- Press the buttons or turn the dial to choose a selection method, then press the .
- Press the **MENU** button to restore the menu screen.

Choosing Images Individually

1 Choose [Select].

- Follow Step 2 above to choose [Select], then press the .





2 Choose an image.

- If you follow Step 2 on p. 120 to choose images, will appear on the screen.
- Press the button again to deselect the image. will disappear.
- To choose additional images, repeat the above procedure.



3 Erase.

- If you press the **MENU** button, a confirmation screen will appear.
- Press the ◀▶ buttons or turn the  dial to choose [OK], then press the  button.

Selecting a Range

1 Choose [Select Range].

- Follow Step 2 on p. 123 to choose [Select Range], then press the  button.

2 Choose images.

- Follow Steps 2 and 3 on p. 121 to choose images.



3 Erase.

- Press the ▼ button to choose [Erase], then press the  button.



Choosing All Images

1 Choose [All Images].

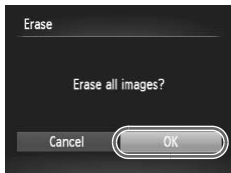
- Follow Step 2 on p. 123 to choose [All Images], then press the  button.



2 Erase.



- Press the ◀▶ buttons or turn the  dial to choose [OK], then press the  button.

Tagging Images as Favorites

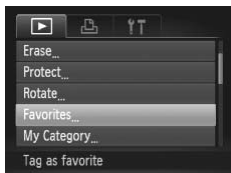
When you tag images as favorites, you can easily categorize just those images. You can also filter out just those images for viewing, protecting or erasing (p. 113).









1 Choose [Favorites].

- Press the **MENU** button to choose [Favorites] in the  tab, then press the  button.







2 Choose an image.

- Press the   buttons or turn the  dial to choose an image, then press the  button.
- ▶  will appear on the screen.
- Press the  button again to untag the image.  disappears.
- To choose additional images, repeat the above procedure.



3 Complete the setting.

- If you press the **MENU** button, a confirmation screen will appear.
- Press the   buttons or turn the  dial to choose [OK], then press the  button.



If you switch to Shooting mode or turn off the camera before completing the setting in Step 3, images will not be tagged as favorites.



If you use Windows 7 or Windows Vista and transfer tagged images to the computer, they will be given a star rating of 3 (★★★☆☆) (except for movies).

Organizing Images by Category (My Category)

You can organize images into categories. You can display the images in a category in filtered playback (p. 113) and process all images at once by using the functions below.

- “Viewing Slideshows” (p. 115), “Protecting Images” (p. 119), “Erasing Images” (p. 123), “Choosing Images for Printing (DPOF)” (p. 143), “Choosing Images for a Photobook” (p. 147)



Images are automatically categorized by shooting condition as they are shot.

: Images with detected faces, or images shot in or .

: Images detected as , or in **AUTO** or modes, or images shot in or .

: Images shot in , or .

Choosing a Selection Method

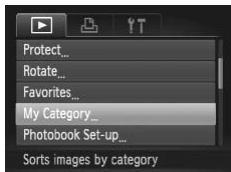

1 Choose [My Category].

- Press the **MENU** button to choose [My Category] in the tab, then press the button.

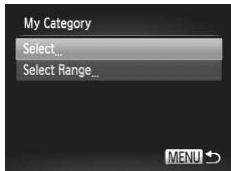

2 Choose a selection method.

- Press the buttons or turn the dial to choose a selection method, then press the .
- Press the **MENU** button to restore the menu screen.

Choosing Images Individually

1 Choose [Select].



- Follow Step 2 above to choose [Select], then press the .

2 Choose an image.

- Press the buttons or turn the dial to choose an image.





3 Choose a category.

- Press the ▲▼ buttons to choose a category, then press the  button.
- ▶ ✓ will appear on the screen.
- Press the  button again to deselect the image. ✓ will disappear.
- To choose additional images, repeat the above procedure.



4 Complete the setting.

- If you press the MENU button, a confirmation screen will appear.
- Press the ◀▶ buttons or turn the  dial to choose [OK], then press the  button.



If you switch to Shooting mode or turn off the camera before completing the setting in Step 4, images will not be tagged as My Category.

Selecting a Range

1 Choose [Select Range].

- Follow Step 2 on p. 126 to choose [Select Range], then press the  button.

2 Choose images.

- Follow Steps 2 and 3 on p. 121 to choose images.



3 Choose a category.

- Press the ▼ button to choose an item, then press the ◀▶ buttons or turn the  dial to choose a category.

4 Complete the setting.

- Press the ▼ button to choose [Select], then press the  button.



If you choose [Deselect] in Step 4, you can deselect all of the images in the [Select Range] category.

Rotating Images

You can change the orientation of an image and save it.

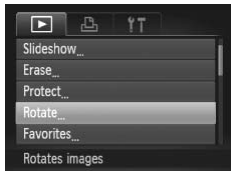

1 Choose [Rotate].

- Press the **MENU** button to choose [Rotate] in the tab, then press the button.



2 Rotate the image.

- Press the buttons or turn the dial to choose an image.
- The image will rotate 90° with each press of the button.
- Press the **MENU** button to restore the menu screen.



- Movies with an image quality setting of cannot be rotated.
- Images cannot be rotated (p. 160) if [Auto Rotate] is set to [Off].

Resizing Images

You can resize images to a lower pixel setting and save the resized image as a separate file.

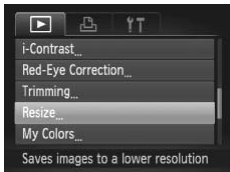

1 Choose [Resize].

- Press the **MENU** button to choose [Resize] in the tab, then press the button.

2 Choose an image.

- Press the buttons or turn the dial to choose an image, then press the button.

3 Choose an image size.

- Press the buttons or turn the dial to choose an option, then press the button.
- ▶ [Save new image?] will appear on the screen.



4 Save the new image.

- Press the buttons or turn the dial to choose [OK], then press the button.
- ▶ The image will be saved as a new file.



5 Display the new image.

- When you press the **MENU** button, [Display new image?] will appear on the screen.
- Press the buttons or turn the dial to choose [Yes], then press the button.
- ▶ The saved image will be displayed.

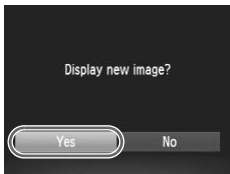

- You cannot resize an image to a larger size.
- Images recorded at a pixel setting of **W** (p. 54), or saved as **XS** in Step 3 cannot be edited.
- Movies cannot be edited.

Trimming

You can cut out a portion of a recorded image and save it as a new image file.



1 Choose [Trimming].

- Press the **MENU** button to choose [Trimming] in the tab, then press the button.

2 Choose an image.

- Press the buttons or turn the dial to choose an image, then press the button.

3 Adjust the trimming area.

- ▶ A frame will appear around the portion of the image to be trimmed.
- ▶ The original image will display in the upper left and the trimmed image will display in the lower right.
- Move the zoom lever to change the frame size.
- Press the buttons to move the frame.
- Press the **DISP.** button to change the frame orientation.
- In an image with detected faces, gray frames appear around the faces located in the upper left image. The frames can be used for trimming. You can switch between frames by turning the dial.
- Press the button.

Trimming Area

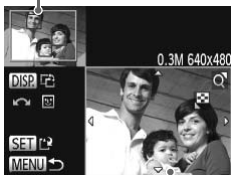

Trimming Area Display

Recorded pixels after trimming



4 Save as a new image and display.

- Follow Steps 4 and 5 on p. 129.



- Images recorded at a pixel setting of **S** or **W** (p. 55), or images resized to **XS** (p. 129) cannot be edited.
- The width and height ratio of an image that can be trimmed is fixed at 4:3.
- The number of recorded pixels in a trimmed image will be smaller than before trimming.
- Movies cannot be edited.

Adding Effects with the My Colors Function

You can change the color of an image and save it as a separate image. Refer to p. 78 for details on each menu item.

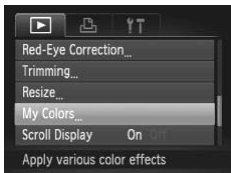

1 Choose [My Colors].

- Press the **MENU** button to choose [My Colors] in the tab, then press the button.

2 Choose an image.

- Press the buttons or turn the dial to choose an image, then press the button.

3 Choose an option.

- Press the buttons or turn the dial to choose an option, then press the button.



4 Save as a new image and display.

- Follow Steps 4 and 5 on p. 129.



If you repeatedly change the color of the same image, the quality will gradually deteriorate and you may not achieve the expected color.



- The color of images changed with this function may vary from those recorded with the My Colors function (p. 78).
- My Colors settings cannot be applied to movies.

Correcting the Brightness (i-Contrast)

The camera can detect areas in an image, such as faces or backgrounds, that are too dark and automatically adjust them to the optimum brightness. Also, when the overall image is lacking in contrast, the camera will automatically correct the image for a sharper impression. You can choose from 4 levels of correction, and save the image as a new file.

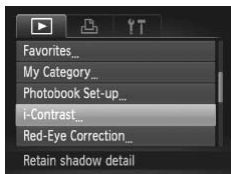

1 Choose [i-Contrast].

- Press the **MENU** button to choose [i-Contrast] in the tab, then press the button.

2 Choose an image.

- Press the buttons or turn the dial to choose an option, then press the .

3 Choose an option.

- Press the buttons or turn the dial to choose an option, then press the .

4 Save as a new image and display.

- Follow Steps 4 and 5 on p. 129.



- Under some conditions, the image may appear coarse or may not be corrected properly.
- Repeatedly adjusting the same image may cause it to appear coarse.



What if the image wasn't corrected by the [Auto] option as well as you would like?

Choose [Low], [Medium] or [High] and adjust the image.





Movies cannot be corrected.

Correcting the Red-Eye Effect

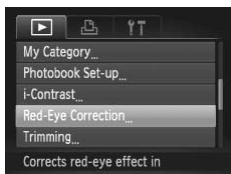

You can automatically correct red eyes in images and save them as new files.



1 Choose [Red-Eye Correction].

- Press the **MENU** button to choose [Red-Eye Correction] in the  tab, then press the  button.

2 Choose an image.





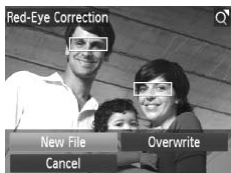

- Press the   buttons or turn the  dial to choose an image.

3 Correct the image.

- Press the  button.
 - ▶ Red-eye detected by the camera will be corrected and a frame will appear around the corrected portion.
- You can magnify or reduce the size of the image using the procedures in “Magnifying Images” (p. 117).



4 Save as a new image and display.

- Press the     buttons or turn the  dial to choose [New File], then press the  button.
 - ▶ The image will be saved as a new file.
- Follow Step 5 on p. 129.



- Some images may not be corrected properly.
- When [Overwrite] in Step 4 is chosen, the uncorrected image is overwritten with the corrected data, erasing the original image.
- Protected images cannot be overwritten.



Movies cannot be corrected.

Printing

This chapter explains how to choose images for printing, and print using a Canon-brand PictBridge compliant printer (sold separately).

Canon-Brand PictBridge Compliant Printers

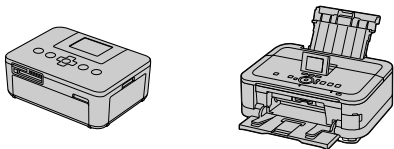

- This chapter uses Canon-brand SELPHY CP series printers in the explanations. The displayed screens and available functions will differ depending on the printer. Please also refer to the Printer User Guide.

Printing Images

Easy Print

You can easily print the pictures you take by connecting the camera to a PictBridge compliant printer (sold separately) using the supplied interface cable (p. 2).

1 Turn off the camera and printer.

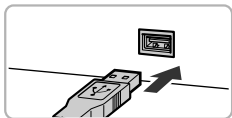
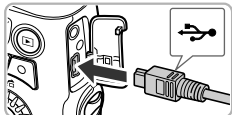



2 Connect the camera to the printer.

- Open the cover and insert the cable's small plug firmly into the camera terminal in the direction shown.
- Insert the cable's large plug into the printer. For connection details, refer to the user guide provided with the printer.





3 Turn on the printer.

4 Turn on the camera.

- Press the  button to turn on the camera.
- ▶  **SET** will appear on the screen.





5 Choose an image.

- Press the   buttons or turn the  dial to choose an image, then press the  button.

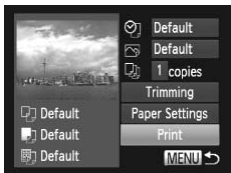



6 Print images.

- Press the ▲▼ buttons or turn the  dial to choose [Print], then press the  button.
- ▶ Printing will start.
- If you want to print additional images, repeat Steps 5 and 6 after printing has completed.
- After printing has completed, turn off the camera and printer, and unplug the interface cable.



- Refer to p. 193 for Canon-brand PictBridge compliant printers (sold separately).
- Index printing is not available on certain Canon-brand PictBridge compliant printers (sold separately).

Making Print Settings



1 Connect the camera to the printer.



- Follow Steps 1 – 5 on p. 136 to display the screen on the left.

2 Choose a menu option.

- Press the ▲▼ buttons or turn the  dial to choose an option.

3 Choose the option settings.

- Press the ◀▶ buttons to choose the option setting.

	Default	Follows the printer's settings.
	Date	Prints the date.
	File No.	Prints the file number.
	Both	Prints both the date and file number.
	Off	—
	Default	Follows the printer's settings.
	Off	—
	On	Uses shooting information to optimize print settings.
	Red-Eye1	Corrects red-eye.
	No. of Copies	Choose the number of copies (p. 139).
Trimming	—	Choose the area for printing (p. 140).
Paper Settings	—	Sets the paper size and layout.

Trimming and Printing (Trimming)

You can cut out a portion of an image for printing.



1 Choose [Trimming].

- Follow Steps 1 – 2 on p. 138 to choose [Trimming], then press the **FUNC SET** button.
- ▶ A frame will appear around the portion of the image to be trimmed.



2 Choose the trimming area.

- Move the zoom lever to change the frame size.
- Press the **▲▼◀▶** buttons to change the frame position.
- Press the **DISP.** button to rotate the frame.
- Press the **FUNC SET** button to complete the setting.

3 Print images.

- Follow Step 6 on p. 137 to print.



- You may not be able to trim images depending on the aspect ratio, or if they are too small.
- Trimming photos with embedded dates may not show the dates properly.

Choosing the Paper Size and Layout for Printing



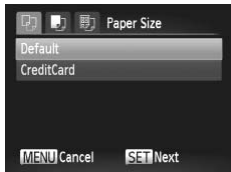

1 Choose [Paper Settings].

- Follow Steps 1 – 2 on p. 138 to choose [Paper Settings], then press the  button.



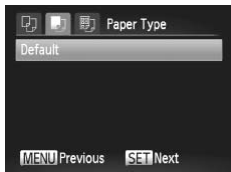

2 Choose a paper size.

- Press the ▲▼ buttons or turn the  dial to choose an option, then press the  button.



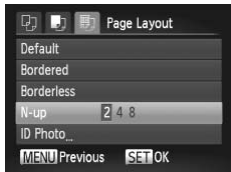

3 Choose the paper type.

- Press the ▲▼ buttons or turn the  dial to choose an option, then press the  button.



4 Choose the layout.

- Press the ▲▼ buttons or turn the  dial to choose an option, then press the  button.
- Press the ◀▶ buttons to set the number of prints when [N-up] is chosen.

5 Print images.

Available Layout Options



Default	Follows the printer's settings.
Bordered	Prints with a border.
Borderless	Prints without a border.
N-up	Selects how many copies of an image are printed on a sheet.
ID Photo	Prints ID photos. Only images with a recording pixel setting of L can be chosen.
Fixed Size	Choose the print size. Choose from 3.5 x 5 in., postcard and wide sized prints.

Printing ID Photos

1 Choose [ID Photo].

- Follow Steps 1 – 4 on p. 140 to choose [ID Photo], then press the  button.

2 Choose the length of the long side and short side.

- Press the ▲▼ buttons or turn the  dial to choose an option.
- Press the ◀▶ buttons to choose the length, then press the  button.

3 Choose the printing area.

- Follow Step 2 on p. 139 to choose the printing area.



4 Print images.



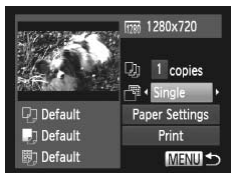

Printing Movies



1 Connect the camera to the printer.

- Follow Steps 1 – 5 on p. 136 to choose a movie.
- Press the ◀▶ buttons to choose , then press the  button to display the screen on the left.

2 Choose a printing method.

- Press the ▲▼ buttons or turn the  dial to choose , then press the ◀▶ buttons to choose a printing method.

3 Print images.

Printing Options for Movies

Single	Prints currently displayed scene as a still image.
Sequence	Prints a sequence of images from a specified scene on a single sheet of paper. If [Caption] is set to [On], you can print the folder number, file number, and the elapsed time for the frame at the same time.



- Pressing the  button during printing will cancel printing.
- [ID Photo] and [Sequence] cannot be chosen on Canon brand PictBridge compliant printers from CP720/CP730 and earlier models.

Choosing Images for Printing (DPOF)

You can choose up to 998 images on a memory card for printing and specify settings such as the number of copies so that they can be printed as a batch (p. 146) or processed at a photo developer service. These selection methods comply with the DPOF (Digital Print Order Format) standards.





Movies cannot be chosen.

Print Settings

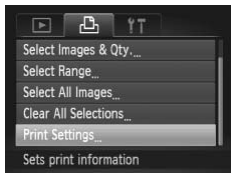



You can set the print type, date and file number. These settings apply to all images chosen for printing.



1 Choose [Print Settings].

- Press the **MENU** button to choose [Print Settings] in the  tab, then press the  button.

2 Choose a setting.

- Press the   buttons or turn the  dial to choose a menu item, then press the   buttons to choose an option.
- Press the **MENU** button to complete the setting and restore the menu screen.

Print Type	Standard	Prints 1 image per page.
	Index	Prints several reduced size images per page.
	Both	Prints both standard and index formats.
Date	On	Prints the shooting date.
	Off	—
File No.	On	Prints the file number.
	Off	—
Clear DPOF data	On	Removes all print settings after printing.
	Off	—



- Some printers or photo developer services may not be able to reflect all of the settings in the prints.
- may appear when using a memory card with print settings set by a different camera. If you change the settings using this camera, all the previous settings may be overwritten.
- If [Date] is set to [On], some printers may print the date twice.



- With [Index] chosen, the [Date] and [File No.] options cannot be set to [On] at the same time.
- The date will be printed in the style set in the [Date/Time] function in the tab, which can be chosen after you press the **MENU** button (p. 18).





Choosing the Number of Copies



1 Choose [Select Images & Qty.].

- Press the **MENU** button to choose [Select Images & Qty.] in the tab, then press the button.

2 Choose an image.

- Press the ◀▶ buttons or turn the  dial to choose an image, then press the  button.
- ▶ You will be able to set the number of print copies.
- If you choose images in [Index],  appears on the screen. Press the  button again to deselect the image.  will disappear.



3 Set the number of prints.

- Press the ▲▼ buttons or turn the  dial to set the number of prints (maximum 99).
- Repeat Steps 2 and 3 to choose other images and the number of prints for each.
- You cannot set the number of copies for index prints. You can only choose which images to print (as shown in Step 2).
- Press the **MENU** button to complete the setting and restore the menu screen.

Select Range

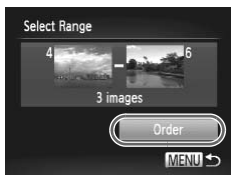

1 Choose [Select Range].

- Follow Step 1 on p. 144 to choose [Select Range], then press the  button.

2 Choose images.

- Follow Steps 2 – 3 on p. 121 to choose images.

3 Make print settings.

- Press the ▲▼ buttons to choose [Order], then press the  button.





Set All Images to Print Once



1 Choose [Select All Images].

- Follow Step 1 on p. 144 to choose [Select All Images], then press the  button.

2 Make print settings.

- Press the   buttons or turn the  dial to choose [OK], then press the  button.



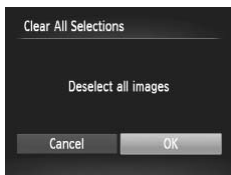

Clearing All Selections



1 Choose [Clear All Selections].

- Follow Step 1 on p. 144 to choose [Clear All Selections], then press the  button.



2 All selections will be cleared.

- Press the   buttons or turn the  dial to choose [OK], then press the  button.



Printing chosen images (DPOF)



- When there are images added to the print list (pp. 143 – 146), the screen on the left will appear when you connect the camera to a PictBridge compliant printer. Press the   buttons to choose [Print now], then press the  button to easily print images added to the print list.
- If you stop the printer during printing and start again, it will start from the next print.



Choosing Images for a Photobook

When you choose images on a memory card to use in Photobooks (max.998 images) and use the included software to transfer them to a computer, the chosen images will be copied into a dedicated folder. This function is useful for ordering Photobooks online and for printing Photobooks on a printer.





Choosing a Selection Method



1 Choose [Photobook Set-up].

- Press the **MENU** button to choose [Photobook Set-up] in the  tab, then press the  button.

2 Choose a selection method.

- Press the   buttons or turn the  to choose a selection method, then press the  button.
- Press the **MENU** button to complete the setting and restore the menu screen.



! may appear when using a memory card with print settings set by a different camera. If you change the settings using this camera, all the previous settings may be overwritten.



After transferring the images to a computer, refer to the *Software Guide* or the user guide included with your printer for further details.

Choosing Images Individually

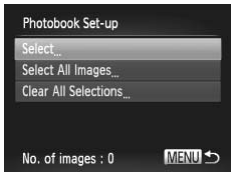



1 Choose [Select].

- Follow Step 2 above to choose [Select], then press the  button.



2 Choose an image.

- Press the ◀▶ buttons or turn the  dial to choose an image, then press the  button.
- ▶ ✓ will appear on the screen.
- Press the  button again to deselect the image. ✓ will disappear.
- To choose additional images, repeat the above procedure.
- Press the **MENU** button to complete the setting and restore the menu screen.

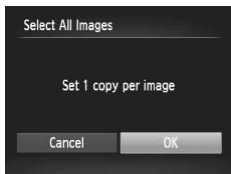

Choosing All Images



1 Choose [Select All Images].

- Follow Step 2 on p. 147 to choose [Select All Images], then press the  button.

2 Make print settings.

- Press the ◀▶ buttons or turn the  dial to choose [OK], then press the  button.

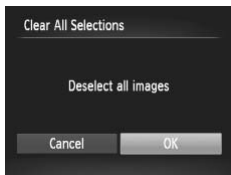

Clearing All Selections



1 Choose [Clear All Selections].

- Follow Step 2 on p. 147 to choose [Clear All Selections], then press the  button.

2 All selections will be cleared.

- Press the ◀▶ buttons or turn the  dial to choose [OK], then press the  button.

10

Customizing Camera Settings

You can customize various settings to suit your shooting preferences. The first part of this chapter explains convenient and commonly used functions. The latter part explains how to change shooting and playback settings to suit your purposes.



Changing Camera Settings

You can customize convenient and commonly used functions in the **F/T** tab (p. 43).

Changing Sounds

You can change each of the camera's operation sounds.

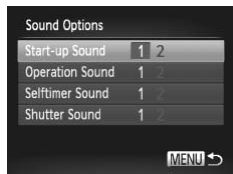

- Choose [Sound Options], then press the **FUNC. SET** button.
- Press the **▲▼** buttons or turn the **○** dial to choose a menu item.
- Press the **◀▶** buttons to choose an option.

1	Preset sounds (cannot be modified)
2	Preset sounds You can use the included software to change the sounds (p. 2).



You cannot change the sound settings in **F4**.

Turning Off Hints & Tips

When you choose an item in the **FUNC.** menu (p. 42) or **MENU** (p. 43), a description of the function (hints and tips) is displayed. You can turn off this function.









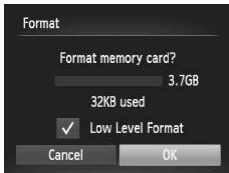

- Choose [Hints & Tips], then press the **◀▶** buttons to choose [Off].

Low Level Memory Card Formatting

Perform low level formatting when [Memory card error] appears, the camera does not operate properly, you think that the recording/reading speed of a memory card has dropped, the continuous shooting speed slows down, or recording suddenly stops while shooting a movie. As you cannot retrieve the erased data, exercise adequate caution before formatting the memory card.



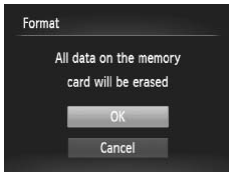

1 Choose [Low Level Format].

- Choose [Format], then press the  button.
- Press the  buttons or turn the  dial to choose [Low Level Format], then press the  buttons to display .
- Press the  buttons or turn the  dial to choose [OK], then press the  button.



2 Start the low level format.

- Press the  buttons or turn the  dial to choose [OK], then press the  button.
- ▶ Low level formatting starts.
- ▶ When low level formatting ends, [Memory card formatting complete] will appear on the screen.

3 Complete the low level format.

- Press the  button.







- Low level formatting may take longer than standard formatting (p. 21), since all recorded data is erased.
- You can stop a low level format of a memory card by choosing [Stop]. When stopping low level formatting, the data will be erased but the memory card can be used without problem.

Changing the Start-up Screen

You can change the start-up screen that appears when you turn on the camera.



- Choose [Start-up Image], then press the  button.
- Press the   buttons or turn the  dial to choose an option.

<input type="checkbox"/> x	No start-up image
1	Preset images (cannot be modified)
2	Preset images You can set recorded images, and use the included software to change the images.





Registering Recorded Images as the Start-up Screen

1 Enter Playback mode.

- Press the  button.











2 Choose [Start-up Image].

- Choose [Start-up Image], then press the  button.
- Press the   buttons or turn the  dial to choose [2], then press the  button.



3 Choose an image.

- Press the   buttons or turn the  dial to choose an image, then press the  button.
- Press the   buttons or turn the  dial to choose [OK], then press the  button to complete registration.



Any previously registered start-up image will be overwritten when registering a new start-up image.



Register the start-up image or sounds with the included software

The dedicated operation sounds and start-up images on the included software can be registered to the camera. Refer to the *Software Guide* for details.

Changing the File Number Assignment

Images you shoot are automatically assigned file numbers in the order they were taken, from 0001 – 9999, and saved to folders of up to 2,000 images. You can change the file number assignment.



- Choose [File Numbering], then press the ◀▶ buttons to choose an option.

Continuous	Even if you shoot using a new memory card, the file numbers are assigned consecutively until an image with the number 9999 is taken/saved.
Auto Reset	If you replace the memory card with a new one, or a new folder is created, file numbering begins with 0001 again.



- If you use a memory card already containing images, the newly assigned file numbers may continue the existing numbering for both [Continuous] and [Auto Reset]. If you want to start over with file number 0001, format the memory card before use (p. 21).
- Refer to the *Software Guide* for information regarding folder structure or image types.



Creating Folders by Shooting Date

Images are saved into folders created each month, however, you can also create folders by shooting date.



- Choose [Create Folder], then press the ◀▶ buttons to choose [Daily].
- Images will be saved into folders created on each shooting date.

Changing the Lens Retract Time

For safety reasons, the lens retracts about 1 minute after pressing the  button when in a Shooting mode (p. 27). If you want the lens to retract immediately when you press the  button, set the retract time to [0 sec.].

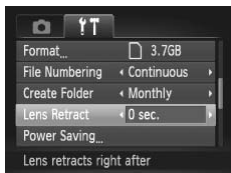



- Choose [Lens Retract], then press the ◀▶ buttons to choose [0 sec.].

Turning Off the Power Saving Function

You can set the power saving function (p. 48) to [Off]. Setting it to [On] is recommended to save battery power.





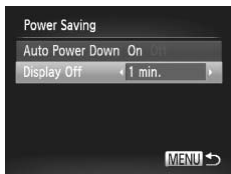

- Choose [Power Saving], then press the  button.
- Press the ▲▼ buttons or turn the  dial to choose [Auto Power Down], then press the ◀▶ buttons to choose [Off].
- If you set the power saving function to [Off], be sure to turn the camera off after use.

Setting the Screen Shut-Off Time

You can adjust the time the screen takes to shut off automatically (p. 48). This also works when [Auto Power Down] is set to [Off].









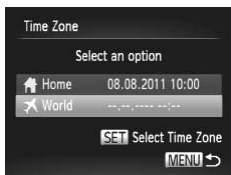



- Choose [Power Saving], then press the  button.
- Press the  buttons or turn the  dial to choose [Display Off], then press the  buttons to choose a time.
- In order to save battery power, you should choose less than [1 min.].

Using the World Clock





When traveling abroad, you can record images with local dates and times simply by switching the time zone setting. If you pre-register the destination time zones, you can enjoy the convenience of not having to switch the Date/Time settings. To use the world clock, be sure to set the date/time (p. 18) and your home time zone beforehand.



1 Set the world time zone.

- Choose [Time Zone], then press the  button.
- Press the  buttons or turn the  dial to choose [ World], then press the  button.
- Press the  buttons or turn the  dial to choose the world time zone.
- To set daylight saving time (adds 1 hour), press the  buttons to choose .
- Press the  button.

2 Choose the world time zone.

- Press the  buttons or turn the  dial to choose [ World], then press the **MENU** button.
- ▶  will appear on the shooting screen (p. 173).

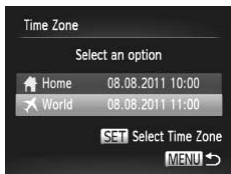



If you change the date or time in the setting (p. 19), your [Home] time and date will automatically change.

Changing the Displayed Units

You can change the units that display in the MF indicator (p. 86) and zoom bar (p. 23) from m/cm to ft/in.



- Choose [Distance Units], then press the buttons to choose [ft/in].

Changing Shooting Function Settings

If you set the mode dial to **P**, you can change the settings in the tab (p. 43).



Before attempting to shoot using a function explained in this section in modes other than **P**, check if the function is available in those modes (pp. 182 – 185).

Switching the Focus Setting

The camera focuses on whatever it is aimed at even when you do not press the shutter button. However, you can set it so that the camera only focuses when the shutter button is pressed halfway.



- Choose [Continuous AF], then press the buttons to choose [Off].

On	Since the camera focuses continuously until you press the shutter button halfway, it allows you to shoot without missing photo opportunities.
Off	The camera does not focus continuously, thereby conserving battery power.

Turning Off the AF Assist Beam

The lamp will automatically light to assist focusing in low light conditions when you press the shutter button halfway. You can turn off the lamp.





- Choose [AF-assist Beam], then press the ◀▶ buttons to choose [Off].

Turning Off the Red-Eye Reduction Function

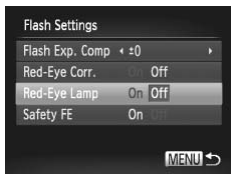
The red-eye reduction lamp lights in order to reduce the red-eye effect that occurs when shooting in dark conditions with the flash. You can turn off this function.



- Choose [Flash Settings], then press the  button.
- Press the ▲▼ buttons or turn the  dial to choose [Red-Eye Lamp], then press the ◀▶ buttons to choose [Off].

Changing the Image Display Time Right After Shooting

You can change the length of time the images display right after shooting.



- Choose [Review], then press the ◀▶ buttons to choose an option.

2 – 10 sec.	Displays images for the set time.
Hold	The image displays until you press the shutter button halfway.
Off	Images will not display.

Changing the Way the Image Displays Right After Shooting

You can change the way the image displays right after shooting.

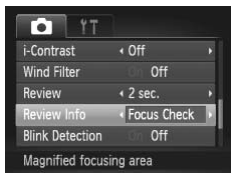

- Choose [Review Info], then press the ◀▶ buttons to choose an option.

Off	Displays the image only.
Detailed	Displays detailed information (p. 176).
Focus Check	The area inside the AF frame is magnified, allowing you to check the focus. The procedure is the same as in "Checking the Focus" (p. 116).

Displaying the Overlay

You can display grid lines for vertical and horizontal guidance, or a 3:2 guide to confirm the printable area for 3.5" x 5" and postcard size prints.

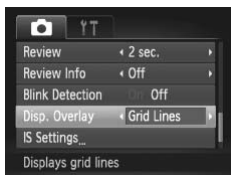

- Choose [Disp. Overlay], then press the ◀▶ buttons to choose an option.



Off	—
Grid Lines	A grid overlays the screen.
3:2 Guide	Gray bars appear on the top and bottom of the screen. This area will not print when printing on paper with a 3:2 aspect ratio.
Both	Both grid lines, and the 3:2 guide appear.

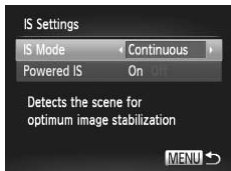

- In **W**, you cannot set [3:2 Guide] or [Both].
- Grid lines will not be recorded on the image.
- The gray areas displayed with [3:2 Guide] are the areas that will not be printed. The actual image recorded will include the portion in the gray areas.

Changing the IS-Mode Settings



- Choose [IS Settings], then press the  button.
- Press the  buttons to choose [IS Mode], then press the  buttons to choose an option.

Continuous	Automatically sets the optimal image stabilization for the scene (Intelligent IS) (p. 175).
Shooting*	Image stabilization is only active at the moment of shooting.
Off	Turns off image stabilization.

* Setting changes to [Continuous] when shooting movies.





If camera shake is too strong, attach the camera to a tripod. You should also set the IS Mode to [Off] when the camera is attached to a tripod.

Turning Off the Powered IS Function

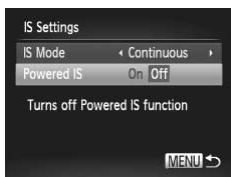
Powered IS reduces subtle camera shake when shooting movies at max. telephoto. However, when shooting while walking, or during long panning shots, you should set Powered IS to [Off], as it may cause unexpected results in these situations.



- Choose [IS Settings], then press the  button.
- Press the  buttons to choose [Powered IS], then press the  buttons to choose [Off].



[Powered IS] settings will be disabled if [IS Mode] is set to [Off].



Changing Playback Function Settings

You can adjust the settings in the  tab by pressing the  button (p. 43).

Turning Off the Auto Rotate Function

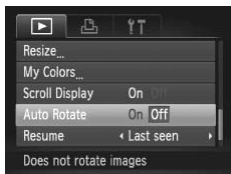
When you play back images on the camera, images shot in vertical orientation automatically rotate and display vertically. You can turn off this function.





- Select [Auto Rotate], then press the   buttons to choose [Off].

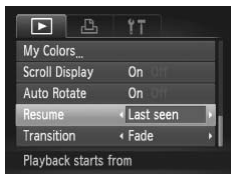

- Images cannot be rotated (p. 128) if you have set [Auto Rotate] to [Off]. Rotated images will also appear in their original orientation.
- In Smart Shuffle (p. 117), even if [Auto Rotate] is set to [Off], images taken vertically will be displayed vertically, while rotated images will appear in their rotated orientation.

Choosing the Image that First Displays in Playback



- Choose [Resume], then press the   buttons to choose an option.

Last seen	Resumes with the image last viewed.
Last shot	Resumes with the most recently shot image.

11

Useful Information

This chapter introduces how to use the accessories and Eye-Fi cards (both sold separately) (p. 192), troubleshooting tips, and contains lists of functions and items that appear on the screen.

Viewing Images on a TV

Using the separately sold Stereo Video Cable STV-250N (p. 193), you can connect the camera to a TV to view images you have shot.

1 Turn off the camera and TV.

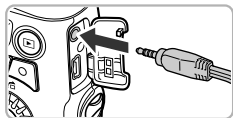

2 Connect the camera to the TV.

- Open the camera's terminal cover and fully insert the cable plug into the camera's terminal.
- Insert the cable plug fully into the video input terminals as shown in the illustration.

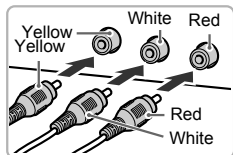

3 Turn on the TV and switch it to the input the cable is connected to.



4 Turn on the camera.

- Press the  button to turn on the camera.
- ▶ The image will appear on the TV (nothing will appear on the screen of the camera).
- After you finish, turn off the camera and TV, and unplug the cable.



What if the images don't display correctly on the TV?

Images will not display correctly if the camera's video output setting (NTSC/PAL) does not match the TV system. Press the **MENU** button and choose [Video System] in the **⏏** tab to switch to the correct video system.

Shooting Using a TV as the Display

You can use a TV to display the camera screen content while shooting.

- To connect the camera to a TV, follow the Steps above.
- Shooting procedures are the same as when using the camera screen.

Using Household Power

If you use AC Adapter Kit ACK800 and DC Coupler DR-DC10 (both sold separately), you can use the camera without worrying about how much charge is left in the batteries.

1 Turn off the camera.

2 Open the cover.

- Follow Step 2 on p. 14 to open the memory card/battery cover.
- Open the coupler cable port as shown.

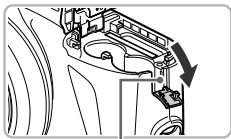

Coupler Cable Port

3 Insert the coupler.

- Insert the coupler as shown.

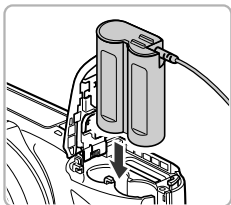

- Make sure the coupler cable passes through the port.

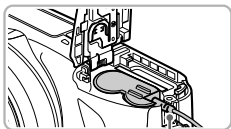

Cable

4 Close the cover.

- Close the cover (①), and press downward as you slide it until it clicks into place (②).

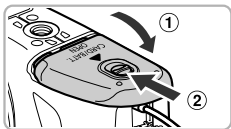

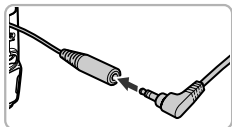

5 Connect the power cord.

- Insert the adapter plug into the coupler cable terminal.
- Connect the power cord to the compact power adapter, then plug the other end into a power outlet.
- Turn the camera on to use it.
- After you finish, turn off the camera and unplug the power cord from the power outlet.

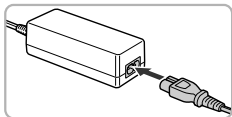

Do not unplug the plug or power cord with the camera turned on. This could erase images you have taken or damage the camera.

Using an Eye-Fi Card

Before using an Eye-Fi card, be sure to check whether Eye-Fi card use is authorized in the country or territory of use (p. 14).

When you put a prepared Eye-Fi card into the camera, you can automatically transfer your images wirelessly to a computer, or upload them to a web service.







Image transfer is a function of the Eye-Fi card. For details on how to setup and use the card, and concerning problems transferring images, please refer to the Eye-Fi card user guide, or contact the manufacturer.



Please keep the following things in mind when using an Eye-Fi card.

- Even if you set [Eye-Fi trans.] to [Disable] (p. 166), the Eye-Fi card may transmit radio waves. Be sure to remove the Eye-Fi card from the camera before entering areas that prevent unauthorized transmission of radio waves, such as hospitals and airplanes.
- If you have trouble transferring images, check the card or computer settings. For details, refer to the user guide supplied with the card.
- Depending on the connection status of the wireless network, it may take time to transfer images, or image transfer may be interrupted.
- Due to its transfer function, the Eye-Fi card may become hot.
- Battery consumption will be quicker than in normal use.
- Camera operations will be slower than in normal use. This may be resolved by setting [Eye-Fi trans.] to [Disable].

If you put an Eye-Fi card into the camera, the connection status can be checked in the shooting screen (information display) and playback screen (simple information display).

 (Gray)	Not connected
 (Flashing white)	Connecting
 (White)	Connected
 (Animated)	Transferring
	Interrupted
	Error retrieving Eye-Fi card info (Turn the camera off and on again. If this continues to appear, there may be a problem with the card.)

 will appear on transferred images.



The power saving function does not work while transferring images (p. 48).

Checking Connection Information

You can check the Eye-Fi card's access point SSID, or connection status.

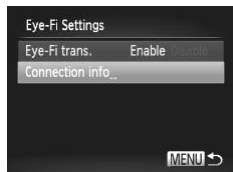

Choose [Connection info].

- Press the **MENU** button to choose [Eye-Fi Settings] in the **Y↑** tab, then press the **FUNC SET** button.
- Press the **▲▼** buttons or turn the **○** dial to choose [Connection info], then press the **FUNC SET** button.
- ▶ The connection info screen will appear.

Disabling Eye-Fi Transfer

You can set the card to disable Eye-Fi transfer.

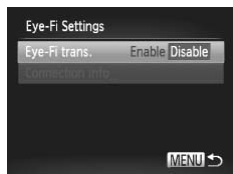

Choose [Disable] in [Eye-Fi trans.].

- Press the **MENU** button to choose [Eye-Fi Settings] in the **Y↑** tab, then press the **FUNC SET** button.
- Press the **▲▼** buttons or turn the **○** dial to choose [Eye-Fi trans.], then press the **◀▶** buttons to choose [Disable].

? What if [Eye-Fi Settings] does not appear?

[Eye-Fi Settings] will not appear when an Eye-Fi card is not inserted in the camera, and when an Eye-Fi card's write-protect tab is in the locked position. For this reason, settings cannot be changed for Eye-Fi cards equipped with a write-protect tab when the tab is in the locked position.

Troubleshooting

If you think there is a problem with the camera, first check the following. If the items below do not solve your problem, contact a Canon Customer Support Help Desk.

Power

You pressed the power button, but nothing happened.

- Confirm that the batteries are the correct type, and are not depleted (p. 17).
- Confirm that the batteries are properly inserted (p. 14).
- Confirm that the memory card/battery cover is securely closed (p. 15).
- If the battery terminals are dirty, battery performance will decrease. Clean the terminals with a cotton swab and re-insert the batteries several times.

Batteries are consumed quickly.

- Battery performance decreases at low temperatures. Warm the batteries, for example, by placing them in your pocket, taking care that the terminals do not come into contact with any metal objects.

Lens will not retract.

- Do not open the memory card/battery cover while the power is on. After closing the memory card/battery cover, turn the power on then back off (p. 15).

TV output

Image is distorted or not showing on TV (p. 162).

Shooting

Cannot shoot.

- Set the mode dial to a Shooting mode (p. 38).
- When in Playback mode (p. 20), press the shutter button halfway (p. 22).

Screen does not display properly in dark places (p. 41).

Screen does not display properly while shooting.

Please note, the following will not be recorded in still images, but will be recorded in movies.

- When the camera is subjected to powerful light sources, the display may darken.
- When shooting under fluorescent or LED lighting, the screen may flicker.
- When shooting bright light sources, a bar of light (purplish red) may appear on the screen.

The screen turns off and you cannot shoot when you press the shutter button (p. 26).

appears when the shutter button is pressed halfway (p. 25).

- Set [IS mode] to [Continuous] (p. 159).
- Raise the flash and set it to  (p. 74).
- Increase the ISO speed (p. 75).
- Attach the camera to a tripod. Additionally, you should set [IS Mode] to [Off] when shooting with a tripod (p. 159).

Image is blurred.

- Press the shutter button halfway to focus on the subject, then press fully to shoot (p. 22).
- Shoot the subject within the focusing distance (p. 188).
- Set the [AF-assist Beam] to [On] (p. 157).
- Confirm that functions which you do not intend to use (macro, etc.) are not set.
- Shoot using the focus lock or AF lock (pp. 82, 88).

Even when you press the shutter button halfway, the AF frame does not appear, and the camera does not focus.

- If you center on the light and dark contrasting area of the subject and push the shutter button halfway, or repeatedly push the shutter button halfway, the AF frame will appear and the camera will focus.

Subject is too dark.

- Raise the flash and set it to  (p. 74).
- Correct the brightness with exposure compensation (p. 75).
- Adjust the image with i-Contrast (pp. 79, 132).
- Use spot metering or AE Lock to shoot (pp. 88, 89).

Subject is too bright (overexposed).



- Lower the flash and set it to  (p. 24).
- Correct the brightness with exposure compensation (p. 75).
- Use spot metering or AE Lock to shoot (pp. 88, 89).
- Reduce the light illuminating the subject.

Image is dark even though the flash fired (p. 25).

- Shoot within an appropriate distance for flash photography (p. 74).
- Correct the flash exposure compensation amount or flash output (pp. 90, 99).
- Increase the ISO speed (p. 75).

Image taken using the flash is too bright (overexposed).

- Shoot within an appropriate distance for flash photography (p. 74).
- Lower the flash and set it to  (p. 24).
- Correct the flash exposure compensation amount or flash output (pp. 90, 99).

White dots appear on the image when shooting with the flash.

- Light from the flash has reflected off dust particles or other objects in the air.

Image appears rough or grainy.

- Shoot with the ISO speed on a lower setting (p. 75).
- Depending on the Shooting mode, when shooting in a high ISO speed the image may appear rough or grainy (p. 60).

Eyes appear red (p. 92).

- Set the [Red-Eye Lamp] to [On] (p. 157). When shooting with the flash, the lamp lights (p. 38), and for approximately 1 second while the camera is reducing red-eye, it is not possible to shoot. It is more effective if the subject is looking directly at the lamp. Even better results can be obtained by increasing the lighting in indoor settings or approaching closer to the subject.
- Correct images with red-eye correction (p. 133).

Recording images to the memory card takes a long time, or continuous shooting slows down.

- Perform a low-level format of the memory card in the camera (p. 151).

Cannot make settings for shooting functions or FUNC. menu.

- The items in which settings can be made differ depending on the shooting mode. Refer to “Functions Available in Each Shooting Mode” and “Shooting Menu” (pp. 178 – 185).

Cannot operate buttons.

- When the mode dial is set to , some buttons cannot be used (p. 29).

Shooting movies

Correct shooting time does not display, or stops.

- Format the memory card in the camera, or use a memory card capable of recording at high speeds. Even when the shooting time does not display properly, the recorded video will be the length that it was actually shot (pp. 21, 31).

appeared on the screen and shooting ended automatically.

The camera’s internal memory was insufficient. Try one of the following:

- Perform a low-level format of the memory card in the camera (p. 151).
- Change the image quality setting (p. 106).
- Use a memory card capable of recording at high speeds (p. 106).

Playback

Cannot play back images or movies.

- If the file name or folder structure is changed on a computer, you may not be able to play back images or movies. Refer to the *Software Guide* for information regarding folder structure or file names.

Playback stops, or audio cuts out.

- Use a memory card that has had a low-level format performed on it with this camera (p. 151).
- If you copy a movie to a memory card that reads slowly, playback may interrupt momentarily.
- Depending on its capabilities, when playing movies on a computer, frames may drop or the audio may cut out.





Cannot operate buttons.

- When the mode dial is set to , some buttons cannot be used (p. 29).

Computer

Cannot transfer images to a computer.

It may be possible to solve the problem when the camera is connected to a computer via cable by reducing the transfer speed.

- After pressing the  button to enter Playback mode, press and hold the MENU button and the  and  buttons together. In the screen that appears, press the  buttons to choose [B], then press the  button.

Eye-Fi Card

Cannot transfer images (p. 165).

List of Messages That Appear on the Screen

If error messages appear on the screen, try one of the following solutions.

No memory card

- The memory card is not installed in the correct direction. Install the memory card in the correct direction (p. 15).

Memory card locked

- The SD memory card, SDHC memory card, SDXC memory card or Eye-Fi card's write protect tab is set to "LOCK". Unlock the write protect tab (pp. 14, 15).

Cannot record!

- You attempted to shoot an image without a memory card. Insert the memory card in the correct direction to shoot (p. 15).

Memory card error (p. 151)

- If the same message appears even when a formatted memory card is inserted in the correct direction, contact a Canon Customer Support Help Desk (p. 15).

Insufficient space on card, cannot select some images

- There is not enough free space on the memory card to shoot (pp. 23, 29, 30, 49, 57, 73, 95, 101) or edit images (pp. 129 – 133). Erase the images (pp. 28, 123) to open space for new images, or insert an empty memory card (p. 14).

Change the batteries (p. 14)

No Image.

- There are no images recorded on the memory card that can be displayed.

Protected! (p. 119)

Unidentified Image/Incompatible JPEG/Image too large./Cannot play back AVI/RAW

- Unsupported images, or images with corrupted data cannot be displayed.
- Images manipulated on a computer, that have had their file name changed, or have been taken with a different camera may not display.

Cannot magnify!/Cannot play back this content in Smart Shuffle/Cannot rotate/Cannot modify image/Cannot register this image!/Cannot modify/ Cannot assign to category/Unselectable image.

- Incompatible images cannot be magnified (p. 117), played back in Smart Shuffle (p. 117), tagged as favorites (p. 125), rotated (p. 128), edited (pp. 129 – 133), registered to the start-up screen (p. 152), categorized (p. 126), or added to a print list (p. 143).
- Images manipulated on a computer, that have had their file name changed, or have been taken with a different camera may not be magnified, played back in Smart Shuffle, tagged as favorites, rotated, edited, registered to the start-up screen, categorized, or added to a print list.
- Movies cannot be magnified (p. 117), played back in Smart Shuffle (p. 117), edited (pp. 129 – 133), added to a print list (p. 143), Choosing Images for a Photobook (p. 147), or registered to the start-up screen (p. 152).

Invalid selection range

- When choosing the selection range (pp. 121, 124, 127, 145), you tried to choose a starting image that was after the last image or you tried to choose an ending image that was before the starting image.

Exceeded selection limit

- You chose more than 998 images in print settings. Choose 998 or less images (p. 143).
- Print settings could not be saved correctly. Reduce the number of selected images and try again (p. 143).
- You chose 501 or more images in Protect (p. 119), Erase (p. 123), Favorites (p. 125), My Category (p. 126) or Print Settings (p. 143).

Communication error

- Images could not be transferred to the computer or printed due to the large amount of images (approx. 1000) stored on the memory card. Use a commercially available USB card reader to transfer the images. Insert the memory card into the printer's card slot to print.

Naming error!

- The folder or image could not be created because there is an image with the same file name as the folder or image that the camera is attempting to create, or the highest possible file number has already been reached. In the **ff** menu, change [File Numbering] to [Auto Reset] (p. 153) or format the memory card (p. 21).

Lens Error

- This error can occur if you hold the lens while it is in motion or when using it in a location with excessive dust or sand in the air.
- If this error message continues to appear, contact a Canon Customer Support Help Desk as there may be a problem with the lens.

A camera error was detected (Error number)

- If an error code appears directly after taking a picture, the shot may not have been recorded. Check the image in Playback mode.
 - If this error code reappears, note the Error number (Exx) and contact a Canon Customer Support Help Desk as there may be a problem with the camera.
-

File Error

- Photos from other cameras or images that have been altered using computer software may not be printable.
-

Print error

- Check the paper size settings. If this message appears when the settings are correct, turn the printer off and back on, then make the settings again.
-

Ink absorber full

- Contact a Canon Customer Support Help Desk for an ink absorber replacement.

Information Displayed on the Screen

Shooting (Information Display)

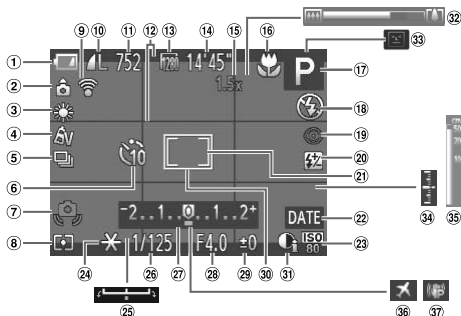

- | | | |
|---|---|--|
| ① Battery Charge Indicator (p. 17) | ⑭ Remaining Time (p. 106) | ⑳ AE Lock (p. 89), FE Lock (p. 89) |
| ② Camera Orientation* | ⑮ Digital Zoom | ㉑ Exposure Shift Bar |
| ③ White Balance (p. 76) | ⑯ Magnification (p. 50) / Digital Tele-converter (p. 81) | ㉒ Shutter Speed (pp. 96, 98) |
| ④ My Colors (p. 78) | ⑰ Focusing Range (pp. 80, 86), AF Lock (p. 88), IS Mode Icon (p. 175) | ㉓ Exposure Compensation Bar (p. 75) |
| ⑤ Drive Mode (p. 77) | ⑱ Shooting Mode (p. 178), Scene Icon (p. 174) | ㉔ Aperture Value (pp. 97, 98) |
| ⑥ Self-Timer (pp. 52, 53) | ⑲ Flash Mode (pp. 74, 91) | ㉕ Exposure Compensation Amount (p. 75) |
| ⑦ Camera Shake Warning (p. 25) | ⑳ Red-Eye Correction (p. 92) | ㉖ AF Frame (p. 82) |
| ⑧ Metering Method (p. 88) | ㉑ Flash Exposure Compensation / Flash Output (pp. 90, 99) | ㉗ i-Contrast (p. 79) |
| ⑨ Eye-Fi Connection Status (p. 165) | ㉒ Spot AE Point Frame (p. 88) | ㉘ Zoom Bar (p. 23) |
| ⑩ Still Image Compression (p. 54), Recording Pixels (p. 54) | ㉓ Date Stamp (p. 51) | ㉙ Blink Detection (p. 93) |
| ⑪ Recordable Shots (p. 55) | ㉔ ISO Speed (p. 75) | ㉚ Exposure Level (p. 98) |
| ⑫ Disp. Overlay (p. 158) | | ㉛ MF Indicator (p. 86) |
| ⑬ Movie Recording Pixels (p. 106) | | ㉜ Time Zone (p. 155) |
| | | ㉝ Image Stabilization (p. 159) |

* : Standard, : Held vertically

When shooting, the camera detects if it is held vertically or horizontally, and adjusts settings accordingly for the best shot. It also detects orientation during playback, so you can hold the camera in either orientation and it will automatically rotate images for correct viewing.

This function may not operate correctly when the camera is pointed straight up or down.

Scene Icons







In **AUTO** mode, the camera displays an icon for the scene it has determined and then automatically focuses and selects the optimum settings for subject brightness and color.

Subject Background	People			Non-Human Subjects			Icon Background Color
	When Moving	With Strong Facial Shadows		When Moving	When Close		
Bright				AUTO			Gray
Backlit			—				
Including Blue Skies				AUTO			Light Blue
Backlit			—				
Sunsets	—				—		Orange
Spotlights							Dark Blue
Dark				AUTO			
When Using Tripod	*	—		*	—		

* Appears when the scene is dark and the camera is attached to a tripod.

IS Mode Icons

Automatically sets the optimal image stabilization for the scene (Intelligent IS) and displays the following icons when in **AUTO** mode.

	Reduces camera shake when shooting still images.		Reduces camera shake when shooting movies, including strong camera shake that occurs when shooting movies while walking (Dynamic Mode).
	Reduces camera shake when panning while shooting*.		Reduces subtle camera shake when shooting movies at max. telephoto (Powered IS).
	Reduces camera shake for macro photography.		Disables image stabilization for shooting when the camera is attached to a tripod and image stabilization is unnecessary.

* Appears on the screen when following the motion of a subject while shooting (panning). While following a subject moving horizontally, only vertical camera shake will be reduced (horizontal image stabilization will be disabled). Additionally, when shooting subjects moving vertically, only horizontal camera shake will be reduced.



If [IS Mode] is set to [Off] (p. 159), image stabilization will be disabled, and icons will not appear on the screen.

Playback (Detailed Information Display)

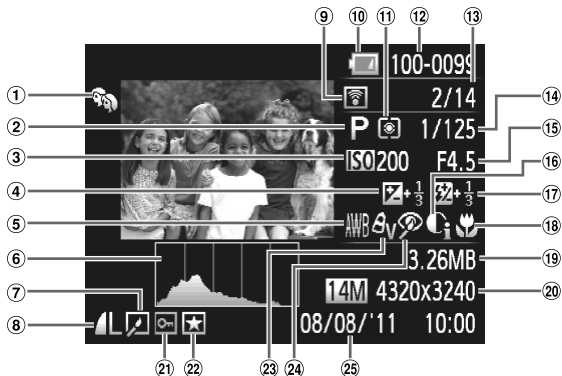















- | | | |
|--|--|--|
| ① My Category (p. 126) | ⑩ Battery Charge Indicator (p. 17) | ⑱ Focusing Range (pp. 80, 86) |
| ② Shooting Mode (p. 178) | ⑪ Metering Method (p. 88) | ⑲ File Size (pp. 55, 106) |
| ③ ISO Speed (p. 75), Playback Speed (p. 105) | ⑫ Folder Number – File Number (p. 153) | ⑳ Still Images: Recording Pixels (p. 55) |
| ④ Exposure Compensation Amount (p. 75), Exposure Shift Amount (p. 107) | ⑬ Displayed Image Number / Total Number of Images | ㉑ Movies: Movie Length (p. 106) |
| ⑤ White Balance (p. 76) | ⑭ Shutter Speed (Still Images) (p. 96), Image Quality / Frame Rate (Movies) (p. 106) | ㉒ Protect (p. 119) |
| ⑥ Histogram (p. 41) | ⑮ Aperture Value (pp. 97, 98), Image Quality (Movies) (p. 106) | ㉓ Favorites (p. 125) |
| ⑦ Image Editing (pp. 129 – 133) | ⑯ i-Contrast (pp. 79, 132) | ㉔ My Colors (pp. 78, 131) |
| ⑧ Compression (Image Quality) (p. 54) / Recording Pixels (pp. 54, 106), MOV (Movies) | ⑰ Flash (pp. 74, 91), Flash Exposure Compensation Amount (p. 90) | ㉕ Red-Eye Correction (pp. 92, 133) |
| ⑨ Eye-Fi Transfer Complete (p. 165) | | ㉖ Shooting Date and Time (p. 18) |



Some information may not display when viewing images on a TV (p. 162).

Summary of Movie Control Panel in “Viewing Movies” (p. 32)

	Exit
	Play
	Slow Motion (You can use the ◀▶ buttons or turn the  dial to adjust the speed. Sound will not play back.)
	Skip Backward* (Continues to skip backward if you hold down the  button.)
	Previous Frame (Rewind if you hold down the  button.)
	Next Frame (Fast forward if you hold down the  button.)
	Skip Forward* (Continues to skip forward if you hold down the  button.)
	Edit (p. 109)
	Appears when connected to a PictBridge compliant printer (p. 136).

* Displays the frame of approx. 4 sec. before or after the current frame.



You can skip forward and skip backward during movie playback by pressing the ◀▶ buttons.

Functions and Menu Lists

Functions Available in Each Shooting Mode

Function	Shooting Modes					
	M	Av	Tv	P	AUTO	☑
Exposure Compensation (p. 75)	—	○	○	○	—	—
ISO Speed (p. 75)	ISO AUTO	—	○	○	○	○
	ISO 80 100 200 400 800 1600	○	○	○	○	—
Focusing Range (p. 80)		○	○	○	○	○
		○	○	○	○	—
	MF (p. 86)/AF Lock (p. 88)	○	○	○	○	—
Flash (pp. 74, 91)		—	—	—	○	○
		○	○	○	○	—
		—	○	—	○	*1 *1
		—	—	—	—	—
Self-Timer (p. 52)		○	○	○	○	○
		○	○	○	○	—
Self-Timer Settings (p. 53)	Delay*3	○	○	○	○	—
	Shots*4	○	○	○	○	—
Av/Tv Settings (pp. 96, 97)	Av	○	○	—	—	—
	Tv	○	—	○	—	—
Tracking AF (p. 83)	○	○	○	○	○	—
AE/FE Lock (p. 89)*5	—	○	○	○	—	—
AE Lock (Movie)/Exposure Shift (p. 107)	—	—	—	—	—	—
Program Shift (p. 89)	—	○	○	○	—	—
Screen Display (p. 40)	No Information Display	○	○	○	○	—
	Information Display	○	○	○	○	○

*1 Cannot be set, but switches to depending on the circumstances. *2 Cannot be set, but switches to when the flash fires. *3 Cannot be set to 0 seconds in modes where the number of shots cannot be set. *4 Fixed to 1 shot in modes where the number of shots cannot be set.

SCN																					
○	○	○	○	○	○	○	○	○	○	○	○	○	○	○	○	○	○	○	○	○	
○	○	○	○	○	○	○	○	○	○	○	○	○	○	○	○	○	○	○	○	○	
—	—	—	—	—	—	—	—	—	—	—	—	—	—	—	—	—	—	—	—	—	
○	○	○	○	○	○	○	○	○	○	○	○	○	○	○	○	○	○	○	○	○	
○	○	—	—	—	—	○	○	○	○	—	○	○	○	○	○	○	○	○	○	○	
○	○	—	—	—	—	○	○	○	○	—	○	○	○	○	○	○	○	○	○	○	
○	○	○	○	○	○	○	○	○	○	—	○	○	○	○	○	○	○	○	○	○	
○	○	○	○	○	○	—	○	○	○	—	○	○	○	○	○	○	○	○	○	○	
—	*2	—	—	—	—	—	—	—	—	—	—	—	—	—	—	—	—	—	—	—	
—	—	—	—	—	—	—	—	—	○	—	—	—	—	—	—	—	—	○	—	—	
○	○	○	○	○	○	○	○	○	○	○	○	○	○	○	○	○	○	○	○	○	
○	○	○	—	—	—	○	○	○	○	○	○	○	○	○	○	○	○	○	—	○	○
○	○	○	—	—	—	○	○	○	○	○	○	○	○	○	○	○	○	○	—	○	○
○	○	○	—	—	—	○	○	○	○	○	○	○	○	○	○	○	○	○	—	—	—
—	—	—	—	—	—	—	—	—	—	—	—	—	—	—	—	—	—	—	—	—	—
—	—	—	—	—	—	—	—	—	—	—	—	—	—	—	—	—	—	—	—	—	—
○	○	○	—	—	—	○	○	○	○	—	—	—	○	○	○	○	○	○	○	—	—
—	—	—	—	—	—	—	—	—	—	—	—	—	—	—	—	—	—	—	—	—	—
—	—	—	—	—	—	—	—	—	—	—	—	—	—	—	—	—	—	—	○	○	○
○	○	○	—	—	—	○	○	○	○	○	—	—	—	○	○	○	○	○	○	○	○
○	○	○	○	○	○	○	○	○	○	○	○	○	○	○	○	○	○	○	○	○	○

*5 FE Lock not available when set to

○ Selectable, or set automatically. — Not selectable.

FUNC. Menu

Function		Shooting Modes					
		M	Av	Tv	P	AUTO	☑
White Balance (p. 76)	AWB	○	○	○	○	○	○
		○	○	○	○	—	—
My Colors (p. 78)	OFF	○	○	○	○	○	○
	AW AN AS ^{*1} AW ^{*1} AP AL AD	○	○	○	○	—	—
	AB AG AR AC ^{*2}	○	○	○	○	—	—
Drive Mode (p. 77)		○	○	○	○	○	○
		○	○	○	○	—	—
	RF ^{*3}	○	○	○	○	—	—
Flash Exposure Compensation (p. 90)		—	○	○	○	—	—
Flash Output Settings (p. 99)		○	○	○	—	—	—
Metering Method (p. 88)		○	○	○	○	○	○
		○	○	○	○	—	—
Recording Pixels (p. 54)	L	○	○	○	○	○	○
	M1 M2	○	○	○	○	○	—
	M	—	—	—	—	—	—
	S	○	○	○	○	○	—
		○	○	○	○	○	—
Compression Ratio (p. 54)		○	○	○	○	○	○
		○	○	○	○	○	—
Movie Quality (p. 106)	1280	○	○	○	○	○	○
	640	○	○	○	○	○	—

*1 White balance is not selectable. *2 Contrast, sharpness, color saturation, red, green, blue, and skin tone can be set in 5 levels. *3 is set when in , AF Lock, or . *4 Synchronizes with the recording pixel setting and is automatically set (p. 105).

SCN																				
○	○	○	○	○	○	○	○	○	○	○	○	○	○	○	○	○	○	○	○	○
—	—	—	○	○	○	○	—	—	—	—	—	—	—	—	—	—	—	○	○	○
○	○	○	○	○	○	○	○	○	○	○	○	○	○	○	○	○	○	○	○	○
—	—	—	○	○	○	—	—	—	—	—	—	—	—	—	—	—	—	○	○	○
○	○	○	○	○	○	○	○	○	○	○	○	○	○	○	○	○	○	○	○	○
○	○	○	—	—	—	○	○	○	○	○	○	○	○	○	○	○	○	○	○	—
○	○	○	—	—	—	○	○	○	○	○	○	○	○	○	○	○	○	○	○	—
—	—	—	—	—	—	—	—	—	—	—	—	—	—	—	—	—	—	—	—	—
—	—	—	—	—	—	—	—	—	—	—	—	—	—	—	—	—	—	—	—	—
○	○	○	○	○	○	○	○	○	○	○	○	○	○	○	○	○	○	○	○	○
—	—	—	—	—	—	—	—	—	—	—	—	—	—	—	—	—	—	—	—	—
○	○	○	○	○	○	—	○	○	○	○	○	○	○	○	○	○	○	○	○	○
○	○	○	○	○	○	—	○	○	○	○	—	—	—	—	—	—	—	○	○	○
○	○	○	○	○	○	—	○	○	○	○	—	○	—	—	—	—	—	○	—	—
○	○	○	○	○	○	○	○	○	○	○	○	○	○	○	○	○	○	○	○	○
○	○	○	○	○	○	○	○	○	○	○	○	○	○	○	○	○	○	○	○	○
○	○	○	○	○	○	○	○	○	○	○	*4	○	○	○	○	○	○	○	○	○
○	○	○	○	○	○	○	○	○	○	○	*4	○	○	○	○	○	○	○	○	—

○ Selectable, or set automatically. — Not selectable.

Shooting Menu

Function		Shooting Modes					
		M	Av	Tv	P	AUTO	☑
AF Frame (p. 82)	Center	○	○	○	○	—	—
	Face Detect*1	○	○	○	○	○	○
	Tracking AF	○	○	○	○	*2	—
AF Frame Size (p. 82)*3	Normal	○	○	○	○	—	—
	Small	○	○	○	○	—	—
Digital Zoom (p. 50)	Standard	○	○	○	○	○	○
	Off	○	○	○	○	○	—
	Digital Tele-converter (1.7x/2.1x)	○	○	○	○	—	—
AF-Point Zoom (p. 85)	On	○	○	○	○	○	—
	Off	○	○	○	○	○	○
Servo AF (p. 87)	On	○	○	○	○	—	—
	Off*4	○	○	○	○	○	○
Continuous AF (p. 156)	On	○	○	○	○	○	○
	Off	○	○	○	○	—	—
AF-assist Beam (p. 157)	On	○	○	○	○	○	*5
	Off	○	○	○	○	○	—
MF-Point Zoom (p. 86)	On	○	○	○	○	—	—
	Off	○	○	○	○	○	○
Safety MF (p. 86)	On	○	○	○	○	—	—
	Off	○	○	○	○	○	○
Flash Settings (pp. 90, 92, 99, 157)	Flash Mode	Auto	—	○	○	○	○
		Manual	○	○	○	—	—
	Flash Exp. Comp		—	○	○	○	—
	Flash Output		○	○	○	—	—
	Red-Eye Corr.	On	○	○	○	○	○
		Off	○	○	○	○	○
	Red-Eye Lamp	On	○	○	○	○	○
		Off	○	○	○	○	—
Safety FE	On	—	○	○	○	○	
	Off	○	○	○	○	—	
i-Contrast (p. 79)	Auto	○	○	○	○	○	○
	Off	○	○	○	○	—	—
Safety Shift (p. 97)	On	—	○	○	—	—	—
	Off	○	○	○	○	○	○
Wind Filter (p. 107)	On/Off	○	○	○	○	○	—

*1 [Center] when faces are not detected. *2 Only available by pressing the ▲ button (p. 26).

*3 Available when the AF frame is set to [Center]. *4 [On] when moving people are detected in **AUTO** mode.

Function		Shooting Modes						
		M	Av	Tv	P	AUTO		
Review (p. 157)	Off	○	○	○	○	○	—	
	2 sec.	○	○	○	○	○	○	
	3 – 10 sec./Hold	○	○	○	○	○	—	
Review Info (p. 158)	Off	○	○	○	○	○	○	
	Detailed/Focus Check	○	○	○	○	○	—	
Blink Detection (p. 93)	On	○	○	○	○	○	—	
	Off	○	○	○	○	○	○	
Disp. Overlay (p. 158)	Off	○	○	○	○	○	○	
	Grid Lines	○	○	○	○	○	—	
	3:2 Guide/Both	○	○	○	○	○	—	
IS Settings (p. 159)	IS Mode	Off	○	○	○	○	—	
		Continuous	○	○	○	○	○	
		Shoot Only	○	○	○	○	—	—
	Powered IS	On	○	○	○	○	○	○
		Off	○	○	○	○	○	—
Date Stamp (p. 51)	Off	○	○	○	○	○	○	
	Date/Date & Time	○	○	○	○	○	—	

↑↑ Set up Menu

Item	Content	Ref. Page
Mute	On/Off*	p. 44
Volume	Set all operation sounds (5 levels).	p. 45
Sound Options	Set the sounds for each camera operation.	p. 150
Hints & Tips	On*/Off	p. 150
LCD Brightness	Sets screen brightness (5 levels).	p. 46
Start-up Image	Add an image as a start-up image.	p. 152
Format	Formats memory card, erasing all data	pp. 21, 151
File Numbering	Continuous*/Auto Reset	p. 153
Create Folder	Monthly*/Daily	p. 154
Lens Retract	1 min.*/0 sec.	p. 154
Power Saving	Auto Power Down: On*/Off Display Off: 10, 20 or 30 sec./1*, 2 or 3 min.	pp. 48, 154, 155
Time Zone	Home*/World	p. 155
Date/Time	Date and time settings.	p. 19
Distance Units	m/cm*/ft/in	p. 156
Video System	NTSC/PAL	p. 162
Eye-Fi Settings	Eye-Fi connection settings (only appears when Eye-Fi card is inserted)	p. 165
Language 	Choose display language.	p. 20
Reset All	Returns camera to default settings.	p. 47

* Default setting

Playback Menu

Item	Content	Ref. Page
Smart Shuffle	Starts Smart Shuffle.	p. 117
Slideshow	Plays back images automatically.	p. 115
Erase	Erases images (Select, Select Range, All Images).	p. 123
Protect	Protects images (Select, Select Range, All Images).	p. 119
Rotate	Rotates images.	p. 128
Favorites	Tags or untags images as favorites.	p. 125
My Category	Categorizes images (Select, Select Range).	p. 126
Photobook Set-up	Chooses or clears photobook settings for images.	p. 147
i-Contrast	Corrects dark portions and contrast in still images.	p. 132
Red-Eye Correction	Corrects red eyes in still images.	p. 133
Trimming	Trims portions of still images.	p. 130
Resize	Resizes and saves still images.	p. 129
My Colors	Adjusts colors in still images.	p. 131
Scroll Display	On*/Off	p. 112
Auto Rotate	On*/Off	p. 160
Resume	Last seen*/Last shot	p. 160
Transition	Fade*/Scroll/Slide/Off	p. 118

* Default setting

Print Menu

Item	Content	Ref. Page
Print	Displays printing screen (When connected to a printer).	—
Select Images & Qty.	Chooses individual images for printing.	p. 144
Select Range	Chooses starting and ending images for printing.	p. 145
Select All Images	Chooses all images for printing.	p. 146
Clear All Selections	Cancel all settings for printing.	p. 146
Print Settings	Sets the printing style.	p. 143

Specifications

Image Sensor

Camera Effective Pixels Approx. 14.1 million pixels

Lens

Focal Length 5.0 (W) – 60.0 (T) mm
(35mm film equivalent: 28 (W) – 336 (T) mm)

Zoom Magnification 12x

Focusing Range 1 cm (0.4 in.) – infinity (W), 1 m (3.3 ft.) – infinity (T)
• Macro: 1 – 50 cm (W) (0.4 in. – 1.6 ft. (W))

Image Stabilizer (IS) System Lens-shift type

Imaging Processor DIGIC 4

LCD Monitor

Type TFT color (wide viewing angle type)

Size 3.0 type

Effective Pixels Approx. 230,000 dots

Aspect Ratio 4:3

Features Brightness adjustment (5 levels)

Focus

Control System Autofocus: Single (Continuous in Auto and Easy modes),
Servo AF/Servo AE
Manual Focus

AF Frame Face Detect, Tracking AF, Center

Metering System Evaluative, Center-weighted average, Spot

Exposure Compensation

(Still Images) /

Exposure Shift (Movies) ±2 stops in 1/3-stop increments

ISO Speed (Standard Output Sensitivity,

Recommended Exposure Index) Auto, ISO 80/100/200/400/800/1600

White Balance Auto, Day Light, Cloudy, Tungsten, Fluorescent,
Fluorescent H, Custom

Shutter Speeds 1 – 1/2500 sec.
15 – 1/2500 sec. (Total shutter speed range)

Aperture

Type Iris

f/number f/3.4 – f/8.0 (W), f/5.6 – f/8.0 (T)

Flash

Modes Auto, on, Slow Synchro, off

Range 50 cm – 3.0 m (W), 1.0 – 2.0 m (T)
(1.6 – 9.8 ft. (W), 3.3 – 6.6 ft. (T))

Shooting Modes.....	M, Av, Tv, P, Auto* ¹ , Easy, SCN* ² , Creative Filters* ³ , Discreet, Movie* ⁴ <ul style="list-style-type: none"> • Shooting movies is possible with the movie button *¹ Smart Auto also available for movies *² Portrait, Landscape, Kids&Pets, Smart Shutter*⁵, Low Light, Beach, Foliage, Snow, Fireworks *³ Fish-eye Effect, Miniature Effect, Toy Camera Effect, Monochrome, Super Vivid, Poster Effect, Color Accent, Color Swap *⁴ Standard, iFrame Movie *⁵ Smile, Wink Self-timer, Face Self-timer
Digital Zoom	Still images/Movies: Approx. 4x (up to approx. 48x in combination with the optical zoom) Safety Zoom, Digital tele-converter
Continuous Shooting	
Mode Selection	Continuous shooting, continuous shooting AF, continuous shooting LV
Speed	Approx. 0.9 shots/sec. (In P mode) Approx. 3.2 shots/sec. (In Low Light mode)
Number of Shots (CIPA compliant)	Alkaline: Approx. 110 images NiMH: Approx. 320 images
Recording Media	SD memory card, SDHC memory card, SDXC memory card
File Format	Design rule for Camera File system, DPOF (Version 1.1) compliant
Data Type	
Still Images.....	Exif 2.3 (JPEG)
Movies.....	MOV (Image data: H.264; Audio data: Linear PCM (stereo))
Recording Pixels	
Still Images.....	Large: 4320 x 3240, Medium 1: 3072 x 2304, Medium 2: 1600 x 1200, Small: 640 x 480, Widescreen: 3744 x 2104
Movies.....	Miniature Effect: 1280 x 720* ¹ / 640 x 480* ¹ iFrame Movie: 1280 x 720 (30 fps* ²) Other than the above: 1280 x 720 (30 fps* ²) / 640 x 480 (30 fps* ²) * ¹ Shooting: 6 fps, 3 fps, 1.5 fps Playback: 30 fps* ² * ² Actual frame rate is 29.97 fps.
Interface.....	Hi-Speed USB Analog audio output (stereo) Analog video output (NTSC/PAL)

Specifications

Direct Print Standard	PictBridge
Power Source	AA alkaline batteries (AA NiMH batteries NB-3AH) x 2 Compact Power Adapter CA-PS800 (included with AC Adapter Kit ACK800) • However, the separately sold DC coupler, DR-DC10 is necessary.
Dimensions (CIPA compliant)	113.3 x 73.2 x 45.8 mm (4.46 x 2.88 x 1.80 in.)
Weight (CIPA compliant)	Approx. 306 g (10.8 oz.) (Including the battery and memory card) Approx. 258 g (9.10 oz.) (camera body only)

- All data is based on tests by Canon.
- Camera specifications or appearance are subject to change without notice.

Accessories

Supplied with Camera



Wrist Strap WS-800



DIGITAL CAMERA
Solution Disk

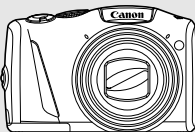

AA Alkaline Batteries
(x2)

Interface Cable
IFC-400PCU*

*Also available for purchase separately.

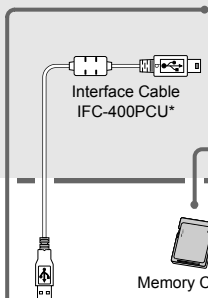

Memory Card



USB Card Reader



Windows/Macintosh

Canon-Brand PictBridge Compliant Printers

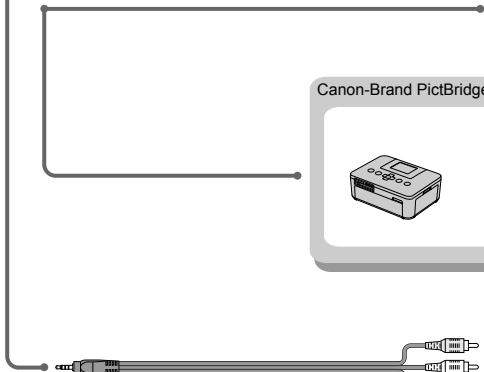

Stereo Video Cable
STV-250N



TV

Separately Sold Accessories

The following camera accessories are sold separately. Some accessories are not sold in some regions, or may no longer be available.

Power Supplies

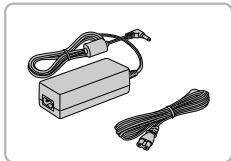

AC Adapter Kit ACK800

- This kit lets you power the camera using household power. Recommended for powering the camera for an extended period of time or when connecting to a computer or printer. Cannot be used to charge the camera batteries. DC Coupler DR-DC10 is required to connect the AC adapter kit to the camera.

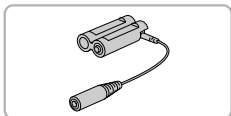

DC Coupler DR-DC10

- For use with the AC adapter kit.

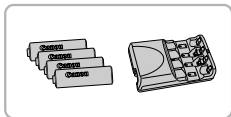

Battery and Charger Kit CBK4-300

- This dedicated battery charger kit includes both Battery Charger CB-5AH and 4 NB-3AH rechargeable AA NiMH (nickel metal hydride) batteries. Recommended for powering the camera for an extended period of time.



- You can also purchase NiMH Battery NB4-300, a set of 4 rechargeable AA NiMH batteries separately.
- Battery and Charger Kit CBK4-200 can also be used.



Using accessories abroad

The battery and charger kit and AC adapter kit can be used in regions that have 100 – 240 V (50/60 Hz) AC power.

If the plug does not fit the outlet, use a commercially available plug adapter. Do not use electrical transformers for foreign travel as they will cause damage.

Flash

High-Power Flash HF-DC2

- This externally mounted flash can be used to capture photographic subjects that are too distant for the built-in flash to illuminate. High-Power Flash HF-DC1 can also be used.

Other Accessories

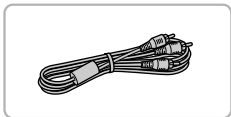

Stereo Video Cable STV-250N

- Use this cable to connect to a TV for shooting and viewing images.

Printers

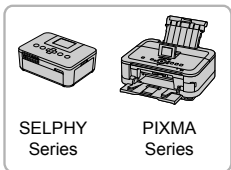

SELPHY
Series

PIXMA
Series

Canon-Brand PictBridge Compliant Printers

- By connecting your camera to a Canon-brand PictBridge compliant printer, you can print your images without having to use a computer.
For more information, visit your nearest Canon retailer.

Use of genuine Canon accessories is recommended.

This product is designed to achieve excellent performance when used with genuine Canon accessories. Canon shall not be liable for any damage to this product and/or accidents such as fire, etc., caused by the malfunction of non-genuine Canon accessories (e.g., a leakage and/or explosion of a battery pack). Please note that this warranty does not apply to repairs arising out of the malfunction of non-genuine Canon accessories, although you may request such repairs on a chargeable basis.

Numerics

3:2 Guide 158

A

AC Adapter Kit 163, 192
Accessories 192
AE Lock 89, 107
AF Frames 24, 82
AF → Focus
AF Lock 88
AF-Point Zoom 85
AUTO Mode (Shooting Mode) 23, 38
Av (Shooting Mode) 97

B

Batteries 14, 192
 Battery and Charger Kit 192
 Charge Indicator 17
 Power Saving 48, 154, 155
Battery and Charger Kit 192
Beach (Shooting Mode) 59
Black and White Images 78
Blink Detection 93

C

Camera
 Default Settings 47
 Holding the Camera 13
Camera Shake 25, 159
Center (AF Frame Mode) 82
Clock Function 48
Color Accent (Shooting Mode) 66
Color Swap (Shooting Mode) 67
Components Guide 38
Compression Ratio (Image Quality) 54
Continuous Shooting 77
Creative Filters (Shooting Mode) 61
Custom White Balance 76

D

Date/Time
 Adding to Image 51
 Changing 19
 Setting 18
 World Clock 155

Date and Time → Date/Time

DC Coupler 163, 192
Default Settings 47
DIGITAL CAMERA Solution Disk 2
Digital Tele-Converter 81
Digital Zoom 50
Discreet (Shooting Mode) 58
Display Language 20
DPOF 143
Drive Mode 77

E

Easy (Shooting/Playback Mode) 29
Editing
 i-Contrast 132
 My Colors 131
 Red-Eye Correction 133
 Resizing (Making Images Smaller) ... 129
 Trimming 130
Erasing Images 28, 123
Error Messages 170
Exposure
 AE Lock 89, 107
 Correction 75
 FE Lock 89
 Shift 107
Eye-Fi Card 14, 165

F

Face Detect (AF Frame Mode) 83
Face Self-Timer (Shooting Mode) 71
Factory Settings → Default Settings
FE Lock 89
File Numbering 153
Fireworks (Shooting Mode) 60
Fish-eye Effect (Shooting Mode) 62
Flash
 Flash Exposure Compensation 90
 On 74
 Slow Synchro 91
Focus
 AF Frames 24, 82
 AF Lock 88
 AF-Point Zoom 85
 Servo AF 87

- Focus Check..... 116
 - Focusing Range
 - Macro..... 80
 - Manual Focus 86
 - Focus Lock..... 82
 - Foliage (Shooting Mode) 60
 - Format → Memory Cards, Formatting
 - Formatting (Memory Card) 21, 151
 - FUNC. Menu
 - Basic Operations 42
 - List..... 180
- G**
- Grid Lines 158
- H**
- Household Power 163
- I**
- i-Contrast..... 79, 132
 - iFrame Movie (Movie Mode)..... 102
 - Image Quality → Compression Ratio
 - Images
 - Display Time 157
 - Editing → Editing
 - Erasing Images..... 28, 123
 - Playback → Viewing
 - Protecting..... 119
 - Included Items → Accessories
 - Indicator..... 39, 41
 - Interface Cable 2, 35, 136
 - ISO Speed..... 75
- K**
- Kids&Pets (Shooting Mode) 59
- L**
- Lamp..... 38, 157
 - Landscape (Shooting Mode) 59
 - LCD Monitor → Screen
 - Low Light (Shooting Mode)..... 59
- M**
- M (Shooting Mode)..... 98
 - Macro (Focus Mode) 80
 - Magnified Display 117
 - Manual Focus (Focus Mode)..... 86
 - Memory Cards 14
 - Available Shots 17, 55
 - Formatting..... 21, 151
 - Shooting Time..... 31, 106
 - Menu
 - Basic Operations 43
 - List 178
 - Metering Method..... 88
 - Miniature Effect (Shooting Mode)..... 63, 104
 - Monochrome (Shooting Mode) 65
 - Movies
 - Editing..... 109
 - Image Quality (Recording Pixels/
Frame Rate)..... 106
 - Modes 102
 - Shooting Time..... 31, 106
 - Viewing (Playback) 32
 - My Category 126
 - My Colors (Playback) 131
 - My Colors (Shooting)..... 78
- P**
- P (Shooting mode)..... 74
 - Photobooks..... 147
 - PictBridge 136, 193
 - Playback → Viewing
 - Playback With Transition Effects 118
 - Portrait (Shooting Mode) 59
 - Poster Effect (Shooting Mode) 61
 - Powered IS 159
 - Power → Batteries, Battery and Charger Kit,
AC Adapter Kit
 - Power Saving 48, 154, 155
 - Printing 136
 - Program AE 74
 - Protect 119
- R**
- Recording Pixels (Image Size) 54
 - Red-Eye Correction 92, 133
 - Resizing (Making Images Smaller)..... 129
 - Rotate..... 128

S

SCN (Shooting Mode)	58
Screen	
Display Language	20
Information Display	173, 176
Menu → FUNC. Menu, Menu	
Switching the Display	40
SD/SDHC/SDXC Memory Card → Memory Cards	
Self-Timer	52
Changing Delay and Number of Shots	53
Face Self-Timer (Shooting Mode)	71
Two Second Self-Timer	53
Wink Self-Timer (Shooting Mode)	70
Sepia Tones	78
Servo AF	87
Shooting	
Display Overlay	158
Number of Shots	17, 55
Shooting Date and Time → Date/Time	
Shooting Info	173
Shooting Time	31
Shooting Using a TV	162
Slideshow	115
Smart Shuffle (Shooting Mode)	117
Smart Shutter (Shooting Mode)	69
Smile (Shooting Mode)	69
Snow (Shooting Mode)	60
Software	
DIGITAL CAMERA Solution Disk	2
Installation	34
Software Guide	2
Transferring Images to a Computer for Viewing	33
Sound Settings	44
Stereo Video Cable	162
Strap	2, 13
Super Vivid (Shooting Mode)	61

T

Tag Images as Favorites	125
Terminal	35, 136, 162, 164
Toy Camera Effect (Shooting Mode)	64
Tracking AF	84

Travel Abroad	155, 192
Trimming	130
Troubleshooting	167
Tv (Shooting Mode)	96

V

Video → Movies	
Viewing	
Filtered Playback	113
Images on a TV	162
Index Display	112
Magnified Display	117
Scroll Display	112
Single Image Playback	27
Slideshow	115
Smart Shuffle	117
Viewing Images on a TV	162

W

White Balance	76
Wide (Recording Pixels)	54, 55
Wink Self-Timer (Shooting Mode)	70
World Clock	155
Wrist Strap → Strap	

Z

Zoom	23, 50
------------	--------

Handling Precautions

- This camera is a high-precision electronic device. Do not drop it or subject it to strong impacts.
- Never place the camera close to magnets, motors or other devices that generate strong electromagnetic fields. Exposure to strong magnetic fields may cause malfunctions or corrupt image data.
- If water droplets or dirt become stuck on the camera or screen, wipe with a dry soft cloth or eyeglass wiper. Do not rub or apply force.
- Never use cleaners containing organic solvents to wipe the camera or screen.
- Use a commercially available blower brush to remove dust from the lens. For stubborn dirt contact a Canon Customer Support Help Desk.
- When you move the camera rapidly from cold to hot temperatures, condensation may form on the internal or external surfaces of the camera. To avoid condensation, put the camera in an airtight, resealable plastic bag and let it adjust to temperature changes slowly before removing it from the bag.
- If condensation has formed on the camera, stop using it immediately, as continued use may damage the camera. Remove the batteries and memory card, and wait until the moisture has completely evaporated before resuming use.

FCC Notice

(Digital Camera, Model PC1677 systems)

This device complies with Part 15 of the FCC Rules. Operation is subject to the following two conditions;

- (1) this device may not cause harmful interference, and
- (2) this device must accept any interference received, including interference that may cause undesired operation.

Note: This equipment has been tested and found to comply with the limits for Class B digital devices, pursuant to Part 15 of the FCC rules. These limits are designed to provide reasonable protection against harmful interference in a residential installation. This equipment generates, uses and can radiate radio frequency energy and, if not installed and used in accordance with the instructions, may cause harmful interference to radio communications. However, there is no guarantee that interference will not occur in a particular installation. If this equipment does cause harmful interference to radio or television reception, which can be determined by turning the equipment off and on, the user is encouraged to try to correct the interference by one or more of the following measures:

- Reorient or relocate the receiving antenna.
- Increase the separation between the equipment and receiver.
- Connect the equipment into an outlet on a circuit different from that to which the receiver is connected.
- Consult the dealer or an experienced radio/TV technician for help.

The cable with the ferrite core provided with the digital camera must be used with this equipment in order to comply with Class B limits in Subpart B of Part 15 of the FCC rules.

Do not make any changes or modifications to the equipment unless otherwise specified in the manual. If such changes or modifications should be made, you could be required to stop operation of the equipment.

Canon U.S.A., Inc.

One Canon Plaza, Lake Success, NY 11042, U.S.A.

Tel No. (516) 328-5600

Canadian Radio Interference Regulations

This Class B digital apparatus complies with Canadian ICES-003.

To ensure proper operation of this product, use of genuine Canon accessories is recommended.



USA and Canada only:

The Nickel-Metal Hydride battery is recyclable. Please call 1-800-8-BATTERY for information on how to recycle this battery.

For CA, USA only

Included lithium battery contains Perchlorate Material - special handling may apply.

See www.dtsc.ca.gov/hazardouswaste/perchlorate/ for details.

Trademark Acknowledgments

- The SDXC logo is a trademark of SD-3C, LLC.
- This device incorporates exFAT technology licensed from Microsoft.
- The iFrame logo and the iFrame symbol are trademarks of Apple Inc.

About MPEG-4 Licensing

This product is licensed under AT&T patents for the MPEG-4 standard and may be used for encoding MPEG-4 compliant video and/or decoding MPEG-4 compliant video that was encoded only (1) for a personal and non-commercial purpose or (2) by a video provider licensed under the AT&T patents to provide MPEG-4 compliant video.

No license is granted or implied for any other use for MPEG-4 standard.

* Notice displayed in English as required.

Disclaimer

- Reprinting, transmitting, or storing in a retrieval system any part of this guide without the permission of Canon is prohibited.
- Canon reserves the right to change the contents of this guide at any time without prior notice.
- Illustrations and screenshots in this guide may differ slightly from the actual equipment.
- The above items notwithstanding, Canon accepts no liability for damages due to mistaken operation of the products.