

Canon

Canon

EOS-1 Ds
Mark III

EOS-1 Ds

Mark III



INSTRUCTION MANUAL III

Exif Print

DPOF

PictBridge

HI-SPEED
CERTIFIED USB

E

INSTRUCTION
MANUAL

Thank you for purchasing a Canon product.

The EOS-1Ds Mark III is a top-of-the-line, high-performance digital SLR camera with a large, fine-detail, 21.10-megapixel CMOS sensor (approx. 36 x 24 mm) and Dual "DIGIC III." It also features high-precision and high-speed 45-point Area AF (19 cross-type points and 26 Assist AF points) and approx. 5 fps continuous shooting.

The camera is highly responsive to any shooting situation, provides many features for demanding shoots, highly reliable even in harsh environments, and compatible with a wide range of accessories. It also incorporates a Self Cleaning Sensor Unit called the EOS Integrated Cleaning System to remove dust on the sensor.

Take a Few Test Shots to Familiarize Yourself with the Camera

With a digital camera, you can immediately view the image you have captured. While reading this manual, take a few test shots and see how they come out. You can then better understand the camera.

To avoid botched pictures and accidents, read the Safety Warnings (p.10,11) and Handling Precautions (p.12,13).

Test the Camera Before Using

After shooting, playback and check the image whether it has been properly recorded.

If the camera or memory card is faulty and the images cannot be recorded or downloaded to the personal computer, Canon cannot be held liable for any loss or inconvenience caused.

Copyrights

Copyright laws in your country may prohibit the use of your recorded images of people and certain subjects for anything but private enjoyment. Also be aware that certain public performances, exhibitions, etc., may prohibit photography even for private enjoyment.

Item Check List

Before starting, check that all the following items have been included with your camera. If anything is missing, contact your dealer. **The accessories included can also be checked in the System Map (p.194).**

-
- Camera: EOS-1Ds Mark III**
(includes eyecup, body cap, battery compartment cap, and installed battery for the date/time clock)
 - Battery: Battery Pack LP-E4** (with protective cover)
 - Charger: Battery Charger LC-E4** (with two protective covers)
 - Power cord**
 - AC Adapter Kit ACK-E4**
 - AC Adapter AC-E4**
 - DC Coupler DR-E4** (with protective cover)
 - Power cord**
 - 3 cables**
 - Interface Cable IFC-200U** (1.9 m / 6.2 ft.)
 - Interface Cable IFC-500U** (4.7 m / 15.4 ft.)
 - Video Cable VC-100**
 - USB cable protector** (with attaching screw)
 - Wide Strap L6**
-
- CD-ROMs**
 - EOS DIGITAL Solution Disk** (bundled software)
 - Software Instruction Manual** (PDF)
-
- Pocket Guide**
Quick start guide to shooting.
 - EOS-1Ds Mark III Instruction Manual** (this booklet)
 - CD-ROM Guide**
Guide to the bundled software and Software Instruction Manual.
-
- Camera Warranty Card**
-

* Be careful not to lose any of the above items.







* The two power cords are identical.

* **No memory card (for recording images) is included.** Please purchase it separately.



* To attach the USB cable protector, see page 24 or the Software Instruction Manual in the CD-ROM.

Conventions Used in this Manual

Icons in this Manual

-  indicates the Main Dial.
-  indicates the Quick Control Dial.
-  indicates the Multi-controller.
-  indicates the SET button.
-  or  indicates that the respective function remains active for 6 sec. or 16 sec. respectively after you let go of the button.
- In this manual, the icons and markings indicating the camera's buttons, dials, and settings correspond to the icons and markings on the camera and on the LCD monitor.
- The **<MENU>** icon indicates a function which can be changed by pressing the **<MENU>** button and changing the setting.
- For more information, reference page numbers are provided in parentheses (p. **).
- In this manual, “camera is ready to shoot” (shooting-ready) refers to the condition where the camera is turned on and no menu or image is displayed on the LCD monitor. The camera can thereby shoot immediately.

About the Symbols

-  : Warning to prevent shooting problems.
-  : Supplemental information.

Basic Assumptions

- All operations explained in this manual assume that the power switch is already set to **<ON>** or **<J>**. (p.36)
-  operations explained in this manual assume that the power switch is already set to **<J>**.
- It is assumed that all the menu settings and Custom Functions are set to the default.
- It is assumed that a memory card (CF card **<I>** or SD card **<Q>**) is being used. In this manual, “CF card” refers to a CompactFlash card, and “SD card” refers to a SD memory card.
- For explanatory purposes, the instructions show the camera attached with an EF50mm f/1.4 USM lens.

Contents

Introduction

Item Check List	3
Conventions Used in this Manual.....	4
Index to Features	8
Handling Precautions	12
Quick Start Guide.....	14
Nomenclature.....	16

1 Getting Started 25

Recharging the Battery	26
Installing and Removing the Battery	29
Using a Household Power Outlet.....	31
Installing and Removing the Memory Card	32
Mounting and Detaching a Lens	35
Basic Operation.....	36
Menu Operations.....	41
Menu Settings	43
Before You Start.....	46
Setting the Interface Language	46
Setting the Date and Time	46
Set the Power-off Time/Auto Power Off	47
Formatting the Memory Card	47
Reverting Camera Settings to the Default	49

2 Image Settings 51

Setting the Image-recording Quality.....	52
Selecting the Image Size	52
Setting the JPEG Quality (Compression Rate)	55
Setting the ISO Speed	56
Selecting a Picture Style	57
Customizing the Picture Style	59
Registering the Picture Style.....	61
Selecting the White Balance	63
Custom White Balance.....	64
Setting the Color Temperature.....	69
White Balance Correction	70
Setting the Color Space	72
Selecting the Media, Folder, and Recording Method	73
Changing the File Name	77
File Numbering Methods	79

3	Setting the AF and Drive Modes	81
	Selecting the AF Mode	82
	Selecting the AF Point	84
	When Autofocus Fails	86
	Manual Focusing	86
	Selecting the Drive Mode	87
	Self-timer Operation	88
4	Exposure Control	89
	Metering Modes	90
	Program AE	92
	Shutter-Priority AE	94
	Aperture-Priority AE	96
	Depth-of-Field Preview	97
	Manual Exposure	98
	Exposure Compensation	99
	Auto Exposure Bracketing (AEB)	100
	AE Lock	101
	Bulb Exposures	102
	Mirror Lockup	104
	Flash Photography	105
5	Live View Shooting	109
	Live View Shooting	110
6	Image Playback	115
	Image Playback	116
	Shooting Information Display	117
	Index Display, Jump Display	119
	Magnified View	120
	Rotating an Image	121
	Viewing the Images on TV	122
	Protecting Images	123
	Sound Recording	124
	Copying Images	125
	Erasing Images	128
	Changing Image Playback Settings	129
	Setting the LCD Monitor Brightness	129
	Setting the Image Review Time	129
	Auto Rotate of Vertical Images	130

7	Sensor Cleaning	131	
	Automatic Sensor Cleaning.....	132	
	Appending Dust Delete Data.....	133	1
	Manual Sensor Cleaning.....	135	
8	Direct Printing from the Camera/Digital Print Order Format	137	
	Preparing to Print.....	138	2
	Printing.....	140	
	Trimming the Image.....	145	
	Digital Print Order Format (DPOF).....	147	3
	Direct Printing with DPOF.....	150	
9	Transferring Images to a Personal Computer	151	
	Transferring Images to a Personal Computer.....	152	4
10	Customizing the Camera and Saving Camera Settings	155	
	Setting Custom Functions.....	156	5
	Custom Functions.....	157	
	Custom Function Settings.....	158	
	C.Fn I: Exposure.....	158	6
	C.Fn II: Image/Flash exposure/Display.....	163	
	C.Fn III: Auto focus/Drive.....	166	
	C.Fn IV: Operation/Others.....	173	
	Registering and Applying Custom Function Settings.....	179	7
	Registering My Menu.....	181	
	Saving and Loading Camera Settings.....	182	
	Registering Basic Camera Settings.....	184	
11	Reference	185	8
	Camera Settings & Battery Information.....	186	
	Replacing the Date/Time Battery.....	188	9
	Program Line.....	189	
	Troubleshooting Guide.....	190	
	Error Codes.....	193	
	System Map.....	194	10
	Specifications.....	196	
	Index.....	206	11

Index to Features

Power

- **Battery**
 - Charging → p.26
 - Calibration → p.28
 - Battery check → p.29
 - Battery information → p.187
- **Power outlet** → p.31
- **Auto power off** → p.47

Menus & Basic Settings

- **Menus** → p.43
- **Camera setting display** → p.186
- **LCD brightness adjustment** → p.129
- **Language** → p.46
- **Date/Time** → p.46
- **Beeper** → p.43
- **Shoot w/o card** → p.43

Recording Images

- **Memory card formatting** → p.47
- **Selecting the memory card** → p.73
- **Create/select a folder** → p.75
- **File name** → p.77
- **Recording methods**
 - Automatic card switching → p.74
 - Separate recording → p.74
 - Recording identical images → p.74
- **File No.** → p.79
- **Copying images** → p.125

Image Quality

- **Image size** → p.52
- **JPEG quality (Compression rate)** → p.55
- **ISO speed** → p.56
 - ISO speed extension → p.158
 - ISO speed increments → p.158

- **Picture Style** → p.57
- **Color space** → p.72
- **Custom Functions for image quality**
 - Noise reduction for long exposures → p.163
 - Noise reduction for high ISO → p.163
 - Highlight tone priority → p.164
 - ISO safety shift → p.160

White balance

- **White balance selection** → p.63
- **Custom WB** → p.64
- **Color temperature setting** → p.69
- **White balance correction** → p.70
- **WB bracketing** → p.71

AF

- **AF mode** → p.82
- **AF point selection** → p.84
- **AF Custom Functions**
 - 19 points/9 points → p.170
 - AF point expansion → p.170
 - AI Servo tracking sensitivity → p.166
 - AI Servo AF tracking method → p.167
 - AF Servo operation → p.166
 - AF fine adjustment → p.169
- **Manual focusing** → p.86

Metering

- **Metering mode** → p.90
- **Multi-spot metering** → p.91

Drive

- **Drive modes** → p.87
- **Maximum burst** → p.53

- **Mirror lockup** → p.104
- **Self-timer** → p.88

Shooting

- **Program AE** → p.92
- **Shutter-priority AE** → p.94
 - Safety shift → p.160
- **Aperture-priority AE** → p.96
- **Manual exposure** → p.98
- **Bulb** → p.102

Exposure adjustment

- **Exposure compensation** → p.99
- **AEB** → p.100
- **AE lock** → p.101
- **Exposure level increments** → p.158

Flash

- **External flash** → p.105
- **External flash control**
 - Flash settings → p.106
 - Flash Custom Functions → p.106

Live View shooting

- **Live View shooting** → p.110
 - Grid → p.114
 - Aspect ratio → p.178
 - Exposure simulation → p.178

Image playback

- **Image review time** → p.129
- **Single image playback** → p.116
 - Shooting information display → p.117
 - Highlight alert → p.118
 - AF point display → p.118
- **Index display** → p.119

- **Magnified view** → p.120
- **Image browsing (Jump display)** → p.119
- **Image Rotate** → p.121
- **Auto rotate of vertical images** → p.130
- **Image protect** → p.123
- **Sound recording** → p.124
- **Image erase** → p.128
- **Video OUT** → p.122

Camera Direct Printing/DPOF

- **PictBridge** → p.137
- **Print Order (DPOF)** → p.147
- **Image transfer** → p.152
 - Transfer order → p.154

Customization

- **Custom Functions (C.Fn)** → p.155
 - Registering settings → p.179
- **My Menu** → p.181
- **Saving camera settings** → p.182
- **Registering basic camera settings** → p.184

Sensor cleaning/Dust reduction

- **Sensor cleaning**
 - Clean now → p.132
 - Disable auto cleaning → p.132
 - Manual cleaning → p.135
- **Add Dust Delete Data** → p.133

Viewfinder

- **Dioptric adjustment** → p.39
- **Eyepiece shutter** → p.103
- **Changing the focusing screen** → p.176

Safety Warnings

Follow these safeguards and use the equipment properly to prevent injury, death, and material damage.

Preventing Serious Injury or Death

- To prevent fire, excessive heat, chemical leakage, and explosions, follow the safeguards below:
 - Do not use any batteries, power sources, and accessories not specified in this booklet. Do not use any home-made or modified batteries.
 - Do not short-circuit, disassemble, or modify the battery pack or back-up battery. Do not apply heat or apply solder to the battery pack or back-up battery. Do not expose the battery pack or back-up battery to fire or water. And do not subject the battery pack or back-up battery to strong physical shock.
 - Do not install the battery pack or back-up battery in reversed polarity (+ -). Do not mix new and old or different types of batteries.
 - Do not recharge the battery pack outside the allowable ambient temperature range of 0°C - 40°C (32°F - 104°F). Also, do not exceed the recharging time.
 - Do not insert any foreign metallic objects into the electrical contacts of the camera, accessories, connecting cables, etc.
- Keep the back-up battery away from children. If a child swallows the battery, consult a physician immediately. (Battery chemicals may harm the stomach and intestines.)
- When disposing of a battery pack or back-up battery, insulate the electrical contacts with tape to prevent contact with other metallic objects or batteries. This is to prevent fire or an explosion.
- If excessive heat, smoke, or fumes are emitted during battery pack recharging, immediately unplug the battery charger from the power outlet to stop the recharging and prevent a fire.
- If the battery pack or back-up battery leaks, changes color, deforms, or emits smoke or fumes, remove it immediately. Be careful not to get burned in the process.
- Prevent any battery leakage from contacting your eyes, skin, and clothing. It can cause blindness or skin problems. If the battery leakage contacts your eyes, skin, or clothing, flush the affected area with lots of clean water without rubbing it. See a physician immediately.
- During the recharging, keep the equipment away from the reach of children. The cord can accidentally choke the child or give an electrical shock.
- Do not leave any cords near a heat source. It can deform the cord or melt the insulation and cause a fire or electrical shock.
- Do not fire the flash at someone driving a car. It may cause an accident.
- Do not fire the flash near a person's eyes. It may impair the person's vision. When using flash to photograph an infant, keep at least 1 meter away.
- Before storing the camera or accessory when not in use, remove the battery pack and disconnect the power plug. This is to prevent electrical shock, heat generation, and fire.
- Do not use the equipment where there is flammable gas. This is to prevent an explosion or fire.

-
- If you drop the equipment and the casing breaks open to expose the internal parts, do not touch the internal parts due to the possibility of electrical shock.
 - Do not disassemble or modify the equipment. High-voltage internal parts can cause electrical shock.
 - Do not look at the sun or an extremely bright light source through the camera or lens. Doing so may damage your vision.
 - Keep the camera from the reach of small children. The neck strap can accidentally choke the child.
 - Do not store the equipment in dusty or humid places. This is to prevent fire and electrical shock.
 - Before using the camera inside an airplane or hospital, check if it is allowed. Electromagnetic waves emitted by the camera may interfere with the plane's instruments or the hospital's medical equipment.
 - To prevent fire and electrical shock, follow the safeguards below:
 - Always insert the power plug all the way in.
 - Do not handle a power plug with wet hands.
 - When unplugging a power plug, grasp and pull the plug instead of the cord.
 - Do not scratch, cut, or excessively bend the cord or put a heavy object on the cord. Also do not twist or tie the cords.
 - Do not connect too many power plugs to the same power outlet.
 - Do not use a cord whose insulation has been damaged.
 - Occasionally unplug the power plug and use a dry cloth to clean off the dust around the power outlet. If the surrounding is dusty, humid, or oily, the dust on the power outlet may become moist and short-circuit the outlet to cause a fire.
-

Preventing Injury or Equipment Damage

- Do not leave equipment inside a car under the hot sun or near a heat source. The equipment may become hot and cause skin burns.
- Do not carry the camera around while it is attached to a tripod. Doing so may cause injury. Also make sure the tripod is sturdy enough to support the camera and lens.
- Do not leave a lens or lens-attached camera under the sun without the lens cap attached. Otherwise, the lens may concentrate the sun's rays and cause a fire.
- Do not cover or wrap the battery-recharging apparatus with a cloth. Doing so may trap heat within and cause the casing to deform or catch fire.
- If you drop the camera in water or if water or metal fragments enter inside the camera, promptly remove the battery pack and back-up battery. This is to prevent fire and electrical shock.
- Do not use or leave the battery pack or back-up battery in a hot environment. Doing so may cause battery leakage or a shorter battery life. The battery pack or back-up battery can also become hot and cause skin burns.
- Do not use paint thinner, benzene, or other organic solvents to clean the equipment. Doing so may cause fire or a health hazard.

If the product does not work properly or requires repair, contact your dealer or your nearest Canon Service Center.

Handling Precautions

Camera Care

- This camera is a precision instrument. Do not drop it or subject it to physical shock.
- The camera is not waterproof and cannot be used underwater. If you accidentally drop the camera into water, promptly consult your nearest Canon Service Center. Wipe off any water droplets with a dry cloth. If the camera has been exposed to salty air, wipe with a well-wrung wet cloth.
- Never leave the camera near anything having a strong magnetic field such as a magnet or electric motor. Also avoid using or leaving the camera near anything emitting strong radio waves such as a large antenna. Strong magnetic fields can cause camera misoperation or destroy image data.
- Do not leave the camera in excessive heat such as in a car in direct sunlight. High temperatures can cause the camera to malfunction.
- The camera contains precision electronic circuitry. Never attempt to disassemble the camera yourself.
- Use a blower to blow away dust on the lens, viewfinder, reflex mirror, and focusing screen. Do not use cleaners that contain organic solvents to clean the camera body or lens. For stubborn dirt, take the camera to the nearest Canon Service Center.
- Do not touch the camera's electrical contacts with your fingers. This is to prevent the contacts from corroding. Corroded contacts can cause camera misoperation.
- If the camera is suddenly brought in from the cold into a warm room, condensation may form on the camera and internal parts. To prevent condensation, first put the camera in a sealed plastic bag and let it adjust to the warmer temperature before taking it out of the bag.
- If condensation forms on the camera, do not use the camera. This is to avoid damaging the camera. If there is condensation, remove the lens, memory card and battery from the camera, and wait until the condensation has evaporated before using the camera.
- If the camera will not be used for an extended period, remove the battery and store the camera in a cool, dry, well-ventilated location. Even while the camera is in storage, press the shutter button a few times once in a while to check that the camera is still working.
- Avoid storing the camera where there are corrosive chemicals such as a darkroom or chemical lab.
- If the camera has not been used for an extended period, test all its functions before using the camera. If you have not used the camera for some time or if there is an important shoot coming up, have the camera checked by your Canon dealer or check the camera yourself and make sure it is working properly.

LCD Panel and LCD Monitor

- Although the LCD monitor is manufactured with very high precision technology with over 99.99% effective pixels, there might be a few dead pixels among the remaining 0.01% or less pixels. Dead pixels displaying only black or red, etc., are not a malfunction. They do not affect the images recorded.
- If the LCD monitor is left on for a prolonged period, screen burn-in may occur where you see remnants of what was displayed. However, this is only temporarily and will disappear when the camera is left unused for a few days.

Memory Cards

- Memory cards are precision devices. Do not drop the memory card or subject it to vibration. Doing so could damage the images recorded on them.
- Do not store or use the memory card near anything having a strong magnetic field such as a TV set, speakers, or magnet. Also avoid places prone to having static electricity. Otherwise, the images recorded on the memory card might be lost.
- Do not leave the memory card in direct sunlight or near a heat source. Doing so can warp the cards and make them unusable.
- Do not spill any liquid onto the memory card.
- Always store your memory cards in a case to protect the data stored on them.
- Do not bend the card or subject it to any excessive force or physical shock.
- Do not store the memory card in hot, dusty, or humid locations.

Lens Electrical Contacts

After detaching the lens from the camera, attach the lens caps or put down the lens with the rear end up to avoid scratching the lens surface and electrical contacts.

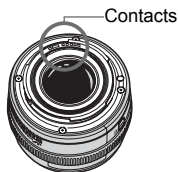

Cautions for Prolonged Use

When you shoot continuously for a prolonged period or use Live View shooting for a long period, the camera may become hot. Although this is not a malfunction, holding the hot camera for a long period can cause slight skin burns.

Quick Start Guide

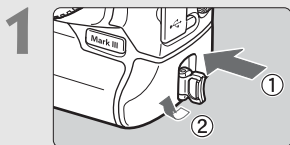

Insert the battery. (p.29)

Take off the cap and insert a fully-charged battery.

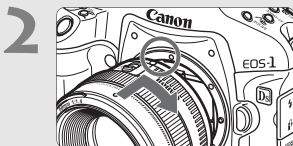

Attach the lens. (p.35)

Align the red dot.

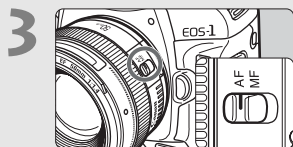

Set the lens focus mode switch to <AF>. (p.35)

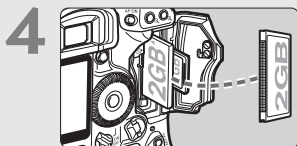

Insert a memory card. (p.32)

The left slot is for the CF card, and the right slot is for the SD card.

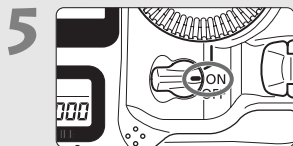

Set the power switch to <ON>. (p.36)



Set the camera to the default settings. (p.49)

On the menu screen under the [M:] tab, select [Clear all camera settings].

- Press the <MENU> button and turn the < [Gears] > < [Sun] > dial to select it, then press < [SET] >.
- The <P> Program AE mode will take effect.

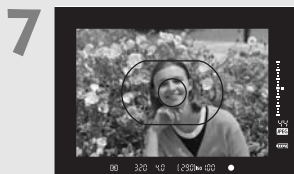

Focus the subject. (p.36)

Aim the Area AF over the subject. Press the shutter button halfway, and the camera will focus the subject.

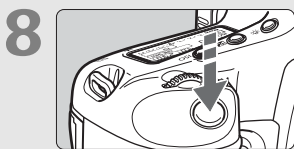

Take the picture. (p.36)

Press the shutter button completely to take the picture.



View the image. (p.129)

The captured image will be displayed for about 2 sec. on the LCD monitor.

- Shooting will be possible with either a CF card or SD card is in the camera.
- To view the images captured so far, see "Image Playback" (p.116).
- To delete an image, see "Erasing Images" (p.128).

Nomenclature

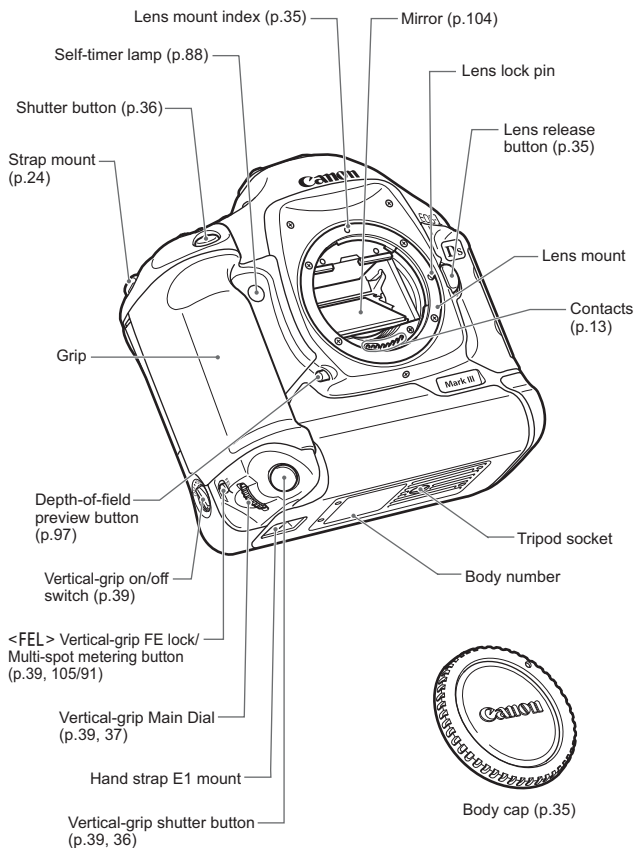

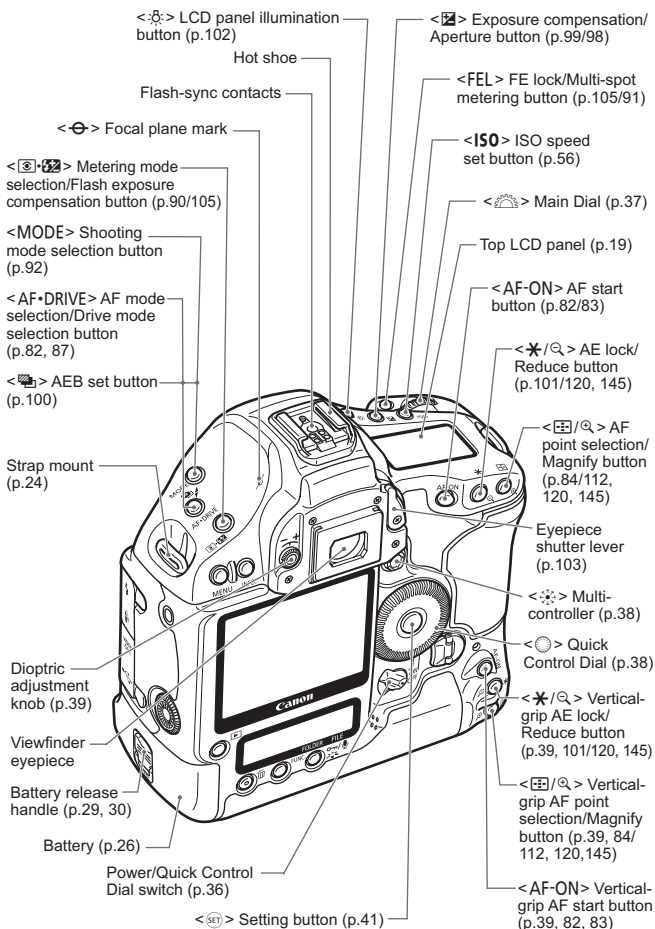

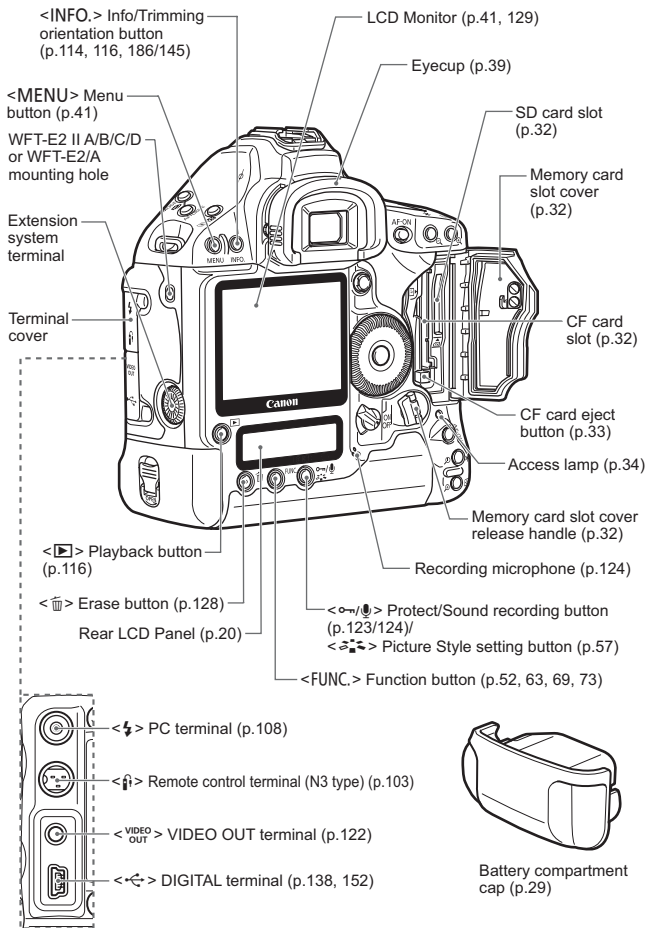

Top LCD Panel

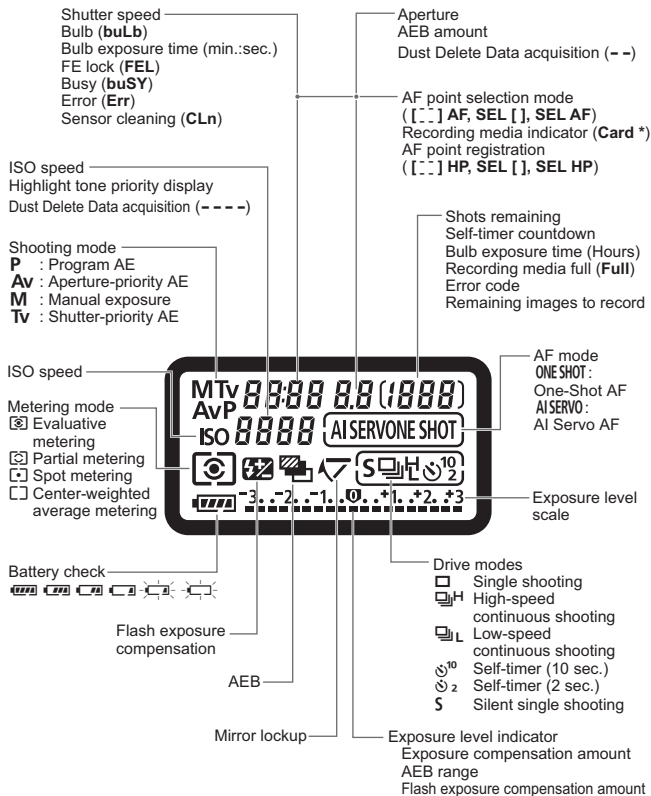

The display will show only the settings currently applicable.

Rear LCD Panel

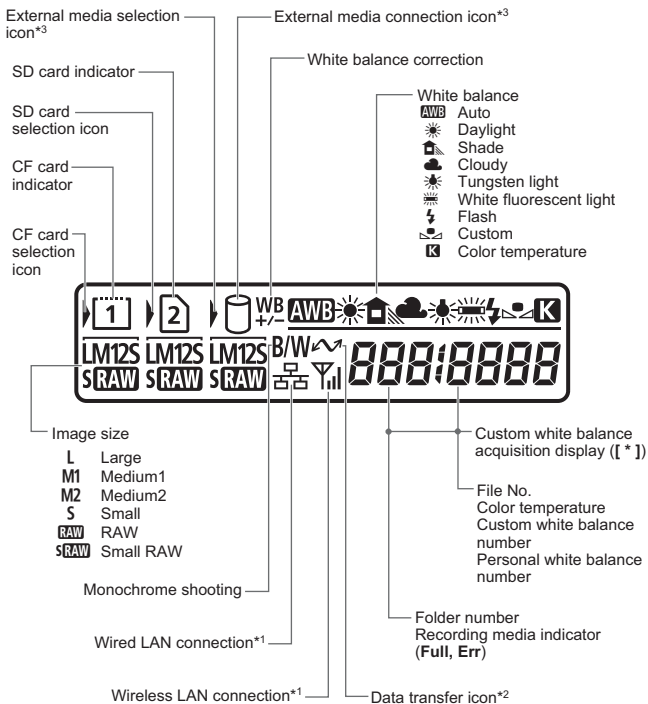

*¹ : Displayed when Wireless File Transmitter WFT-E2 II A/B/C/D or WFT-E2/A is used.

*² : Displayed when the camera is connected to a personal computer.

*³ : Displayed when the WFT-E2 II A/B/C/D or WFT-E2/A and external media are used.

The display will show only the settings currently applicable.

Viewfinder Information

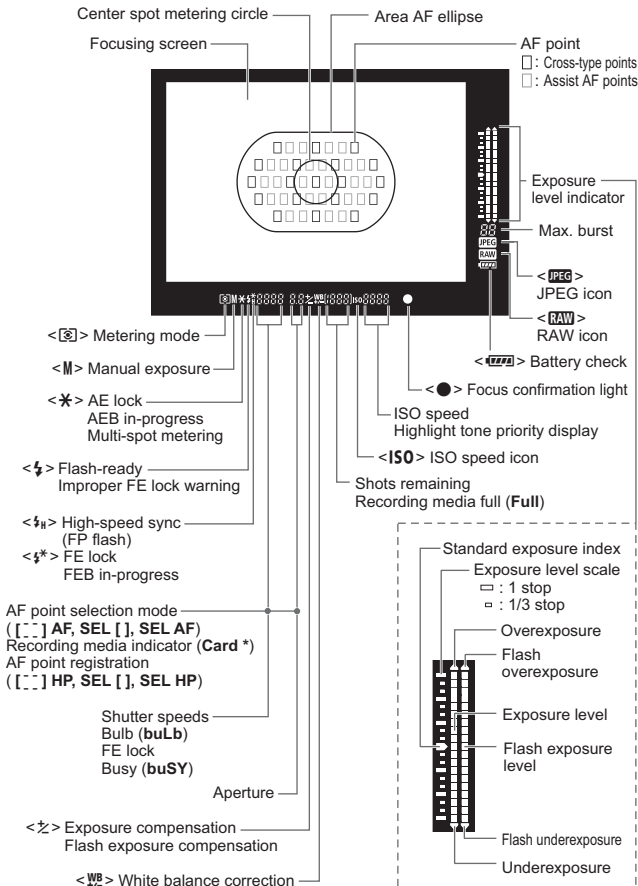

The display will show only the settings currently applicable.

Battery Pack LP-E4

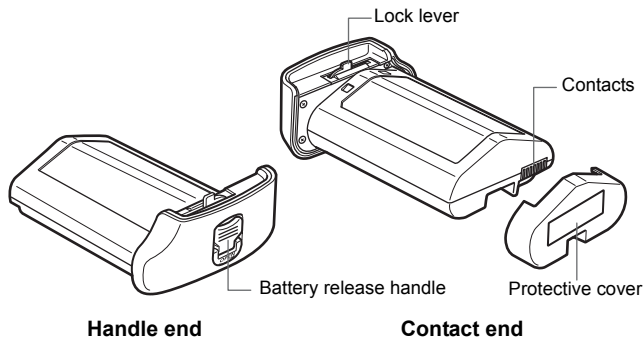

Battery Charger LC-E4

Charger for Battery Pack LP-E4. (p.26)

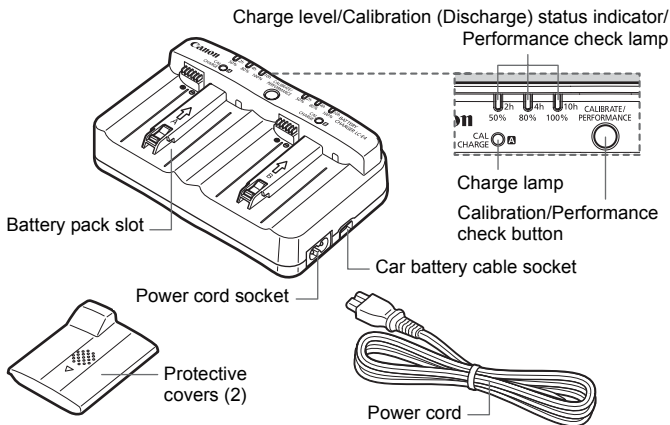

AC Adapter Kit ACK-E4

Powers the camera from a household power outlet. (p.31)

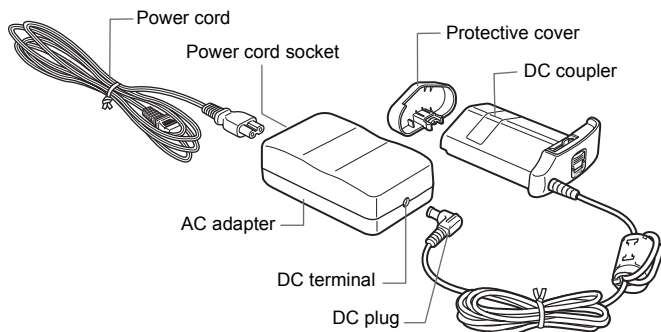

Attaching the Neck Strap and Hand Strap E1

Using the USB Cable Protector

Strap

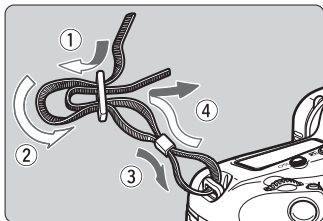

USB cable protector

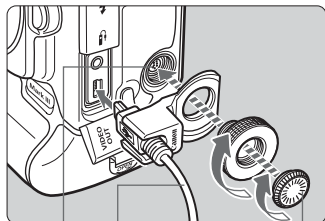

Terminal cap
Interface cable
Extension system terminal

Hand strap E1 (sold separately)

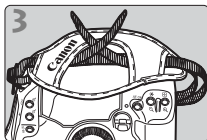
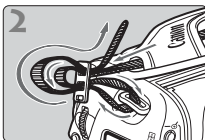
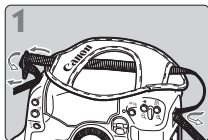

Attach the strap

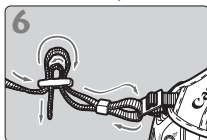
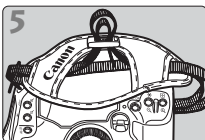
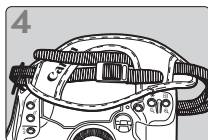

- After attaching the strap, pull it at the buckle to take up the slack and to make sure it does not loosen.
- Attach the extension system terminal cap securely, making sure it is not loose. Be careful not to lose it.

1

Getting Started

This chapter explains preliminary steps and basic camera operations.

Recharging the Battery

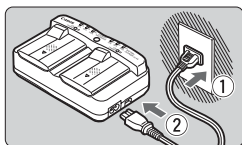

1 Connect the charger to a power outlet.

- Connect the power plug to a power outlet, and connect the power cord to the charger.
- When no battery is attached, all the indicator lamps will be off.

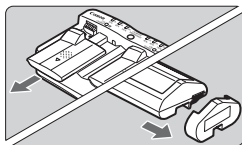

2 Remove the protective covers from the charger and battery.

- Remove the protective cover on the charger by sliding it out.

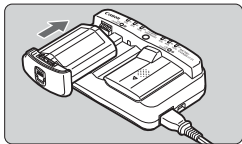

3 Recharge the battery.

- Slide in the battery into the charger's slot as shown by the arrow, and make sure it is securely attached. You can attach the battery to slot A or B.
- ▶ The Charge level indicator will light in green and charging will start.
- ▶ When the battery is fully charged, all three Charge level indicators will light (50%/80%/100%).
- It takes about 2 hours to fully recharge a completely exhausted battery. The time required to recharge the battery depends on the ambient temperature and battery's charge level.

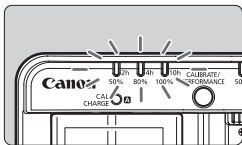

- The charger cannot charge any battery other than Battery Pack LP-E4.
- Battery Pack LP-E4 is dedicated to Canon only. Using it with a non-Canon battery charger or product may result in malfunction or accidents for which Canon cannot be held liable.
- For battery calibration (p.28), it is best to do it after the battery is nearly exhausted. If you do the calibration with a fully charged battery, it will take about 12 hours to complete the calibration (power discharge) and the battery recharging (approx. 10 hours to discharge, and approx. 2 hours to fully recharge).



When two battery packs are attached to the charger, the battery attached first will be charged first, then the other battery will be charged. Although one battery can be recharged and another calibrated (p.28) at the same time, two batteries cannot be recharged or calibrated at the same time.

Tips for Using the Battery and Charger

- **Recharge the battery on the day before or on the day it is to be used.**

Even during non-use or storage, a charged battery will gradually discharge and lose its power.

- **After recharging the battery, detach it and unplug the power cord from the power outlet.**

When not using the battery and charger, attach the protective covers.

- **Use the battery in an ambient temperature range of 0°C - 45°C / 32°F - 113°F.**

To attain best battery performance, an ambient temperature of 10°C - 30°C / 50°F - 86°F is recommended. In cold locations such as snowy areas, battery performance and operation time may temporarily decrease.

- **When not using the camera, remove the battery.**

If the battery is left in the camera for a prolonged period, a small amount of power current is released, resulting in excess discharge and shorter battery life. Take out the battery from the camera and attach the protective cover before storing. Storing the battery after it is fully charged can lower the battery's performance.

- **The battery charger can also be used in foreign countries.**

The battery charger is compatible with a 100 V AC to 240 V AC 50/60 Hz power source. If necessary, attach a commercially-available plug adapter for the respective country. Do not attach any portable voltage transformer to the battery charger. Doing so can damage the battery charger.

- **Check the battery performance.**

While the battery is recharging, press the **<PERFORMANCE>** button to check the battery's performance level indicated by the Charge level indicator.

■ ■ ■ (Green): Battery performance is fine.

■ ■ □ (Green): Battery performance is slightly degraded.

■ □ □ (Red): Purchasing a new battery is recommended.

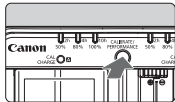



The <CAL/CHARGE> lamp blinks in red.

This indicates that you should calibrate the battery so that the correct battery level is detected and the camera's battery level indicator can display the correct battery level. Calibration is not a required operation. If you want to just recharge the battery, you can let the battery start recharging automatically after about 10 sec. If you want to do the calibration, press the <CALIBRATE> button while the <CAL/CHARGE> lamp is blinking in red. The Charge level indicator will blink in red and the calibration (power discharge) will start.

After the calibration is completed, the battery will start recharging automatically. Note that the less depleted the battery, the longer the calibration will take. The <2h>, <4h>, and <10h> figures on the side of the Charge level indicator respectively indicate the approximate number of hours it will take to complete the calibration (power discharge). If the <10h> indicator blinks in red, it will take approx. 10 hours. After the calibration is completed and the battery is totally drained, it will take a further 2 hours to recharge the battery fully. If you want to stop the calibration before it is completed and start recharging the battery, remove the battery from the charger and attach it to the charger again.

All three Charge level indicators blink.

If all three Charge level indicators blink in green, it means that the battery's internal temperature is not within 0°C - 40°C / 32°F - 104°F. The battery will start recharging when the internal temperature is within 0°C - 40°C / 32°F - 104°F.

If all the Calibration (discharge) status indicators blink in red or if all the lamps blink between green and red (including the <CAL/CHARGE> lamp), remove the battery from the charger and take it to your dealer or to nearest Canon Service Center.

Also, if a battery other than the LP-E4 is attached to the charger, the lamps will blink between red and green (including the <CAL/CHARGE> lamp) and the battery cannot be recharged.



Use the car's cigarette lighter socket to recharge the battery.

With Car Battery Cable CB-570 (sold separately), you can connect the charger's car battery cable socket (<DC IN> terminal) to your car's cigarette lighter socket.

- When recharging the battery this way, be sure that the car's engine is on. If the car engine is off, disconnect the car battery cable from the cigarette lighter socket. If you leave the car battery cable connected to the cigarette lighter socket, it may drain the car battery.
- Do not use a transformer with the battery charger.
- Battery charging from a car battery is possible only with a 12 V DC or 24 V DC car battery in a minus-grounded car. The shape or dimensions of the cigarette lighter socket in certain cars might not be compatible with the car battery cable.

Installing and Removing the Battery

Installing the Battery

Load a fully charged LP-E4 battery pack into the camera.

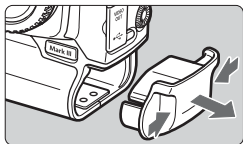

1 Remove the battery compartment cap.

- Grasp both sides of the cap and pull it out.

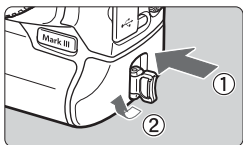

2 Insert the battery.

- Insert the battery firmly all the way, and turn the release handle as shown by the arrow.

Checking the Battery Level

When the power switch is set to <ON> (p.36), the battery level will be indicated in one of six levels:



Icon	Level (%)	Indication
	100 - 70	Sufficient battery level
	69 - 50	Battery level exceeds 50%
	49 - 20	Battery level below 50%
	19 - 10	Battery level is low
	9 - 1	Battery will be exhausted soon
	0	Recharge the battery

Select the [**Battery info.**] menu to see the detailed battery information. (p.187)

Battery Life

Temperature	At 23°C / 73°F	At 0°C / 32°F
Possible Shots	Approx. 1800	Approx. 1400

- The figures above are based on a fully-charged LP-E4, no Live View shooting, and CIPA (Camera & Imaging Products Association) testing standards.



- The actual number of shots may be fewer than indicated above depending on the shooting conditions.
- Pressing the shutter button halfway for long periods or operating only the autofocus can also reduce the number of possible shots.
- The number of possible shots will decrease with more frequent use of the LCD monitor.
- For battery life when Live View shooting is used, see page 114.

Removing the Battery

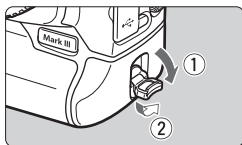

- 1 Flip out the battery release handle and turn it as shown by the arrow.**

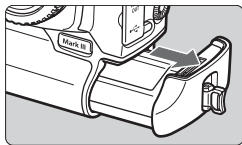

- 2 Pull out the battery.**
 - To prevent shorting, be sure to attach the protective cover (p.22) to the battery.
 - When not using the camera, attach the battery compartment cap.



If the battery's rubber lining (to repel water) is not clean, use a moist cotton swab to wipe it clean.

Rubber lining



Using a Household Power Outlet

With AC Adapter Kit ACK-E4, you can connect the camera to a household power outlet and not worry about the battery level.

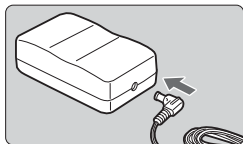

1 Connect the DC plug.

- Connect the DC Coupler's plug to the AC adapter's DC terminal.

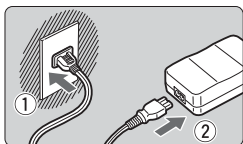

2 Connect the power cord.

- Connect the power plug to the power outlet, then connect the power cord to the AC adapter.

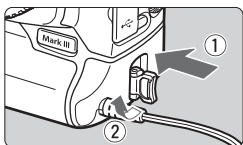

3 Insert the DC Coupler.

- Insert the coupler firmly all the way, and turn the release handle as shown by the arrow.
- Set the camera's power switch to <ON>.
- After using the camera, unplug the power plug from the power outlet.



- The DC Coupler is not water-resistant, so do not get it wet when using it outdoors.
- Do not connect or disconnect the power cord or DC Coupler while the camera's power switch is set to <ON>.

Installing and Removing the Memory Card

The camera can use a CF card and SD card. Images can be recorded with at least one memory card installed in the camera.

If both card slots have a card, you can select which card to record images with or record the same images simultaneously on both cards. (p.73)

! If you use an SD card, be sure the write protect switch is set upward to enable writing/erasing.

Installing a Card

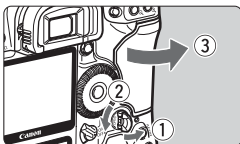

1 Open the cover.

- Flip out and turn the cover release handle as shown by the arrow.

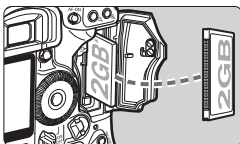

2 Insert the memory card.

- The left slot is for the CF card, and the right slot is for the SD card.
- **With the CF card, face the label side toward you as shown in the illustration and insert the end with the small holes into the camera.**
If the CF card is inserted in the wrong way, it may damage the camera.

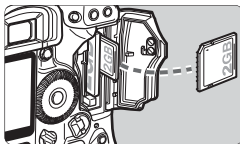

- ▶ The CF card eject button will stick out.
- With the SD card's label facing you, push in the card until it clicks in place.

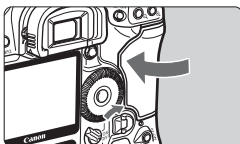

3 Close the cover.

- Press the cover until it snaps shut.



- The camera can also use SDHC memory cards.
- Ultra DMA (UDMA) CF cards enable faster data writing.



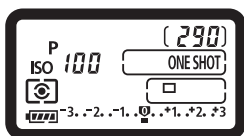

Memory card selection icon

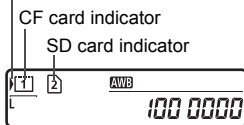

4 Set the power switch to <ON>.

- ▶ The number of possible shots will be displayed on the top LCD panel and in the viewfinder.
- ▶ The rear LCD panel will indicate which memory card(s) has been installed. **The images will be recorded to the memory card with the <▶> arrow next to the respective card's indicator.**



- The camera is compatible with both Type I and Type II CF cards which differ in thickness. High-capacity (2GB or higher) CF cards, SD cards, and hard disk-type cards can also be used.
- The number of possible shots varies depending on the memory card's capacity, image-recording quality, ISO speed, etc.
- The [☑ Shoot w/o card] menu option set to [Off] will prevent you from forgetting to install a memory card.

Removing the Card

1 Open the cover.

- Set the power switch to <OFF>.
- **Make sure the access lamp is off, then open the cover.**

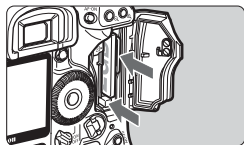

2 Take out the memory card.

- To remove the CF card, push the eject button.
- To remove the SD card, push it in and release it.
- Close the cover.

-  ● **The access lamp lights during any of the following operations: The image is being exposed, being written to or read by the memory card, being erased, or data is being transferred. While the access lamp is lit, never do any of the following. Doing so may damage the image data. It may also damage the memory card or camera.**
 - **Opening the card slot cover.**
 - **Removing the battery.**
 - **Shaking or banging the camera around.**
- If the memory card already contains recorded images, the image number might not start from 0001. (p.79)
- Compared to other memory cards, hard disk-type cards are more vulnerable to vibration and physical shock. If you use a such a card, be careful not to subject the camera to vibration or physical shock especially while recording or playing images.
- When holding a hard disk-type card, always hold its sides. You may damage the card by holding its flat surfaces.
- Do not touch the SD card's contacts with your fingers or metal objects.

-  ● Even with the power switch set to <OFF>, when you insert or remove a memory card, the access lamp might blink.
- If a memory card-related error is displayed, see page 48.

Mounting and Detaching a Lens

Mounting a Lens

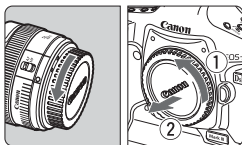

1 Remove the caps.

- Remove the rear lens cap and the body cap by turning them as shown by the arrow.



2 Attach the lens.

- Align the red dots on the lens and camera and turn the lens as shown by the arrow until it snaps in place.

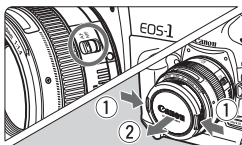

3 On the lens, set the focus mode switch to <AF>.

- If it is set to <MF>, autofocus will not be possible.

4 Remove the front lens cap.

Detaching the Lens

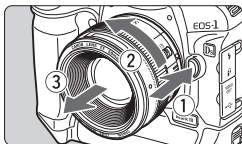

While pressing the lens release button, turn the lens as shown by the arrow.

- Turn the lens until it stops, then detach it.



When attaching or detaching the lens, take care to prevent dust from entering the camera through the lens mount.



Not compatible with EF-S lenses.

Basic Operation

Power/Quick Control Dial Switch

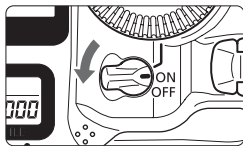

<OFF> : The camera is turned off and does not operate. Position for when you do not use the camera.

<ON> : The camera operates.

<J> : The camera and <☉> dial operate. (p.38)

- Whenever you set the power switch to <ON/ J> or <OFF>, the sensor cleaning will be executed automatically. During the sensor cleaning, the LCD monitor will display <☐>.
- To save battery power, the camera turns off automatically after about 1 minute of non-operation. To turn on the camera again, just press the shutter button.
- You can change the auto power-off time with the menu's [**Y** Auto power off] setting. (p.47)
- If you set the power switch to <OFF> while the image is being recorded to the memory card, [**Recording ...**] will be displayed and the power will turn off after the card finishes recording the image.

Shutter Button

The shutter button has two steps. You can press the shutter button halfway. Then you can further press the shutter button completely.

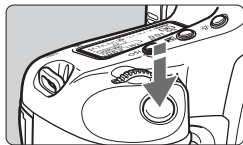

Pressing halfway (☉6)

This activates autofocus and automatic exposure that sets the shutter speed and aperture.

The exposure setting will be displayed on the top LCD panel and in the viewfinder.

- Pressing the <AF-ON> button will result in the same operation as pressing the shutter button halfway.

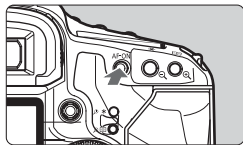

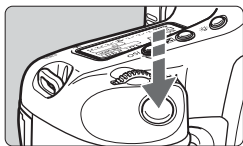

Pressing completely

This releases the shutter and takes the picture.



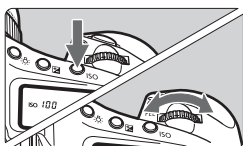

- If you press the shutter button completely without pressing it halfway first or if you press the shutter button halfway and then press it completely immediately, the camera will take a moment before it takes the picture.
- Even during the menu display, image playback, and image recording, you can instantly go back to shooting-ready by pressing the shutter button halfway.

< > Using the Main Dial for Selecting



(1) After pressing a button, turn the < > dial.

When you press a button, its function remains selected for 6 seconds (⌚6). During this time, you can turn the <  > dial to set the desired setting. When the function turns off or if you press the shutter button halfway, the camera will be ready to shoot.

- Use the dial to select or set the shooting mode, AF mode, metering mode, AF point, ISO speed, exposure compensation when the <  > button is pressed, or memory card.



(2) Turn the < > dial only.

While looking at the viewfinder or top LCD panel, turn the <  > dial to set the desired setting.

- In this way, you can set the shutter speed, aperture, etc.

< > Using the Quick Control Dial for Selecting

Before using the <  > dial, set the power switch to < J >.

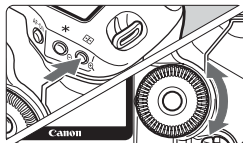

(1) After pressing a button, turn the < > dial.

When you press a button, its function remains selected for 6 seconds ().

During this time, you can turn the <  > dial to set the desired setting. When the function turns off or if you press the shutter button halfway, the camera will be ready to shoot.

- Use the dial to select or set the shooting mode, drive mode, flash exposure compensation, AF point, ISO speed, exposure compensation when the <  > button is pressed, white balance, or image recording size.

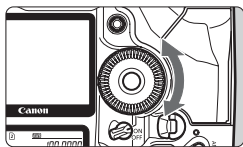

(2) Turn the < > dial only.

While looking at the viewfinder or top LCD panel, turn the <  > dial to set the desired setting.

- Use this dial to set the exposure compensation amount and the aperture setting for manual exposures.

 You can also do step (1) when the power switch is set to < ON >.

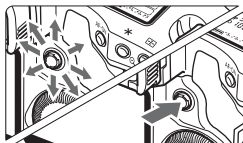

< > Operating the Multi-controller



The <  > consists of eight direction keys and a button at the center.

- Use it to select the center AF point, correct white balance, select focusing frame during Live View shooting, or scroll the image during magnified view.

Vertical Shooting

The bottom of the camera provides a shutter button, <  > Main Dial, <  > AF point selection button, < * > AE Lock button, < AF-ON > AF Start button, and < FEL > FE lock/Multi-spot metering button all for vertical shooting.

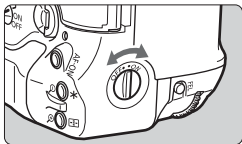

- Before using the vertical shooting controls, set the vertical operation on/off switch to <ON>.
- When not using the vertical shooting controls, set the switch to <OFF> to prevent accidental operation.

Adjusting the Viewfinder Clarity

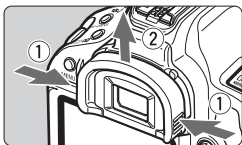

1 Remove the eyecup.

- While grasping both sides of the eyecup, slide it upward to remove.

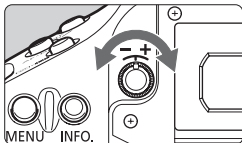

2 Turn the dioptic adjustment knob.

- Turn the knob to the right or left until the AF points or the center spot metering circle looks sharp in the viewfinder.
- Attach the eyecup.



If the camera's dioptic adjustment still cannot provide a sharp viewfinder image, using Dioptic Adjustment Lens Eg (sold separately) is recommended.

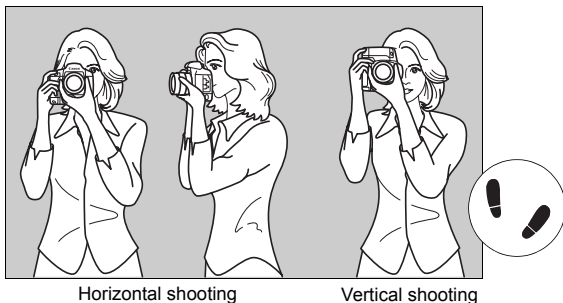

Holding the Camera

To obtain sharp images, hold the camera still to minimize camera shake.





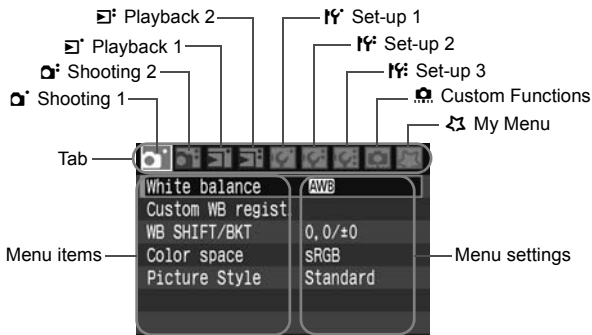
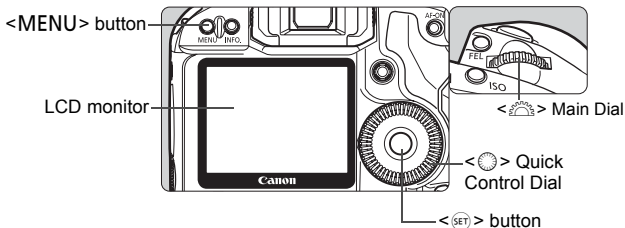

1. Wrap your right hand around the camera grip firmly.
2. Hold the lens bottom with your left hand.
3. Press the shutter button lightly with your right hand's index finger.
4. Press your arms and elbows lightly against the front of your body.
5. Press the camera against your face and look through the viewfinder.
6. To maintain a stable stance, place one foot in front of the other.

Menu Operations

By setting various optional settings with the menus, you can set the Picture Style, date/time, Custom Functions, etc. While looking at the LCD monitor, you use the <MENU> button on the camera back and the <  > <  > dials.



Icon	Color	Category	Description
	Red	Shooting menu	Shooting-related items
	Blue	Playback menus	Image playback-related items
	Yellow	Set-up menus	Camera's function settings
	Orange	Camera's Custom Functions	
	Green	Register frequently-used menu items and Custom Functions	

Menu Setting Procedure

1 Display the menu.

- Press the <MENU> button to display the menu.

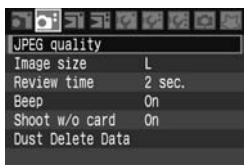

2 Select a tab.

- Turn the <☀> dial to select a tab.

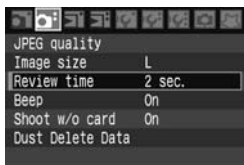

3 Select a menu item.

- Turn the <⦿> dial to select the menu item, then press <SET>.

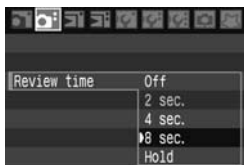

4 Select the setting.

- Turn the <⦿> dial to select the desired setting.



5 Set the desired setting.

- Press <SET> to set it.

6 Exit the menu.

- Press the <MENU> button to exit the menu and return to camera shooting.

 You can also use <⦿> to select the tab and menu item. (Works only with the menu's top layer items.)

Menu Settings

☑ Shooting 1 (Red)

Page

White balance	AWB / / / / / / / (1 - 5) / (2500 - 10000) / PC-1 - 5	63
Custom WB regist.	Manual registration of white balance data	64
WB SHIFT/BKT	WB correction: B/A/M/G bias, 9 levels each	70
	WB-BKT: B/A and M/G bias, single-level increments, ±3 levels	71
Color space	sRGB / Adobe RGB	72
Picture Style	Standard / Portrait / Landscape / Neutral / Faithful / Monochrome / User Def. 1, 2, 3	57-62

☑ Shooting 2 (Red)

JPEG quality	Compression rate for L, M1, M2, S	55
Image size	L / M1 / M2 / S / RAW / RAW+L / RAW+M1 / RAW+M2 / RAW+S / sRAW / sRAW+L / sRAW+M1 / sRAW+M2 / sRAW+S (→p.45)	52
Review time	Off / 2 sec. / 4 sec. / 8 sec. / Hold	129
Beep	On / Off	-
Shoot w/o card	On / Off	33
Dust Delete Data	Obtain dust-mapping data to eliminate dust spots with bundled software	133

☑ Playback 1 (Blue)







Protect images	Erase-protect image	123
Rotate	Rotate vertical image	121
Erase images	Erase image	128
Print order	Specifies images to be printed (DPOF)	147
Transfer order	Select images to be transferred to a personal computer	154
Image copy	Copy images between memory cards	125
External media backup	Displayed when external media is used via WFT-E2 II A/B/C/D or WFT-E2/A (sold separately)	-

☑ Playback 2 (Blue)

Page

Highlight alert	Disabled / Enabled	118
AF point disp.	Disabled / Enabled	118
Histogram	Brightness / RGB	118
Enlarge display	Enlarge from image center / Enlarge from selected AF point	120
Image jump w/ 	1 image / 10 images / 100 images / Screen / Date / Folder	119

☑ Set-up 1 (Yellow)

Auto power off	1min. / 2 min. / 4 min. / 8 min. / 15 min. / 30 min. / Off	47
Record func+media/ folder sel.	[Record func.] Standard / Auto switch media / Rec. separately / Rec. to multiple [Record/play]  /  /  [Folder] Creating and selecting a folder	74 73 75
File numbering	Continuous / Auto reset / Manual reset	79
File name setting	File name (unique setting) / User setting 1 / User setting 2	77
Auto rotate	On   / On  / Off	130
Format	Initialize and erase data in the card	47

☑ Set-up 2 (Yellow)

LCD brightness	Seven brightness levels provided	129
Date/Time	Set the date (year, month, day) and time (hour, min., sec.)	46
Language	18 languages provided (English, German, French, Dutch, Danish, Portuguese, Finnish, Italian, Norwegian, Swedish, Spanish, Greek, Russian, Polish, Simplified Chinese, Traditional Chinese, Korean, and Japanese)	46
Video system	NTSC / PAL	122
Battery info.	Detailed battery information	187
Live View function settings	[Live View shoot.] Disable / Enable [Grid display] Off / On	110 114
External Speedlite control	Flash function settings / Flash C.Fn settings / Clear all Speedlite C.Fn's	106

Y: Set-up 3 (Yellow)

Page

Save/load settings on media	Save / Load	182
Regist/apply basic settings	Register / Apply	184
Clear all camera settings	Resets the camera to the default settings	49
Sensor cleaning	Auto cleaning / Clean now / Clean manually	131
Firmware Ver.	For updating the firmware	-
WFT settings	Displayed when WFT-E2 II A/B/C/D or WFT-E2/A (sold separately) is attached	-

Custom Functions (Orange)

C.Fn I: Exposure	Customize the camera as desired	158
C.Fn II: Image/Flash exp/Disp		163
C.Fn III: Auto focus/Drive		166
C.Fn IV: Operation/Others		173
Clear all Custom Func. (C.Fn)	Clears all Custom Function settings	156
C.Fn setting register/apply	Custom Function settings are registered in and applied to the camera	179

My Menu (Green)

My Menu settings	Register frequently-used menu items and Custom Functions	181
-------------------------	--	-----



- What is displayed by [Image size] depends on the [Record func.] setting under [Y Record func+media/folder sel.]. If [Record func.] is set to [Rec. separately], select the image size for the respective memory card. (RAW + JPEG and sRAW + JPEG cannot be displayed.)
- Even while the menu is displayed, you can instantly go back to shooting by pressing the shutter button halfway.
- The explanation of menu functions hereinafter assumes that you have pressed the <MENU> button to display the menu screen.
- You can register frequently-used menu items under My Menu <My Menu>. (p.181)

Before You Start

MENU Setting the Interface Language

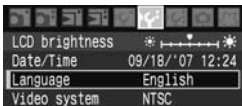

1 Select [Language].

- Under the [**MF**] tab, select [**Language**] (the third item from the top), then press <SET>.



2 Set the desired language.

- Turn the <⊙> dial to select the language, then press <SET>.
- ▶ The language will change.

MENU Setting the Date and Time

Check if the camera's date and time are set correctly. If necessary, set the correct date and time.





1 Select [Date/Time].

- Under the [**MF**] tab, select [**Date/Time**], then press <SET>.



2 Set the date, time and date display format.

- Turn the <⊙> dial to select the number.
- Press <SET> so  is displayed.
- Turn the <⊙> dial to select the desired setting, then press <SET>.
(Returns to .)

3 Exit the menu.

- Turn the <⊙> dial to select [**OK**], then press <SET>.
- ▶ The date/time will be set and the menu will reappear.

 It is important to set the correct date/time because it will be recorded together with each captured image.

MENU Set the Power-off Time/Auto Power Off

To save battery power, the camera turns off automatically after a certain time of non-operation.

You can change this auto power-off time.

If you do not want the camera to turn off automatically, set this to **[Off]**. After the power turns off, you can turn on the camera again by pressing the shutter button or other button.



1 Select **[Auto power off]**.

- Under the **[IY]** tab, select **[Auto power off]**, then press **<SET>**.

2 Set the desired time.

- Turn the **<DIAL>** to select the item, then press **<SET>**.



Even if **[Off]** has been set, the LCD monitor will turn off automatically after 30 min. to save power. Also, during Live View shooting, the Live View screen will turn off automatically after 30 min. (The camera's power will not turn off.)

MENU Formatting the Memory Card

If the memory card is new or was previously formatted by another camera or personal computer, format the card with the camera.

- !** **When the memory card is formatted, all images and data in the card will be erased. Even protected images will be erased, so make sure there is nothing you need to keep. If necessary, transfer the images to a personal computer, etc., before formatting the card.**

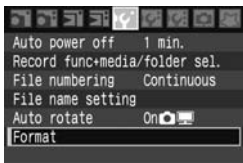

1 Select **[Format]**.

- Under the **[IY]** tab, select **[Format]**, then press **<SET>**.



2 Select the memory card.

- [1] is the CF card, and [2] is the SD card.
- Turn the <⊙> dial to select the card, then press <SET>.

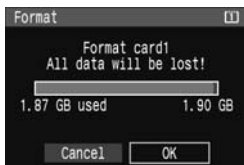

3 Select [OK].

- When [2] is selected, low-level formatting is possible. (p.49)
- Turn the <⊙> dial to select [OK], then press <SET>.
- ▶ The memory card will be formatted.
- ▶ When the formatting is completed, the menu will reappear.

- When the memory card is formatted or erased, only the file management information is changed. The actual data is not completely erased. Be aware of this when selling or discarding the card.
- When discarding the memory card, destroy the card physically to prevent personal data from being leaked.
- If a memory card-related error message is displayed on the LCD monitor, remove and reinstall the card. If the error persists, use a different card. If you can transfer all the images in the card to a personal computer, transfer all the images and then format the card. The card may then return to normal.

 The memory card capacity displayed on the card format screen might be smaller than the capacity indicated on the card.

About Low-level Formatting

When [2] SD card is selected, low-level formatting is possible. If the writing speed to the SD card is slower than usual or if you want to completely erase the data in the SD card, checkmark [Low level format] and format the card.

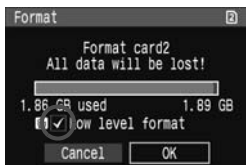

Press the <🗑> button.

- In step 3 on the preceding page, press the <🗑> button.
- ▶ The [Low level format] option will be checkmarked <✓>.
- With <✓> displayed, select [OK] to start the low-level formatting.



- Since low-level formatting will erase all recordable sectors in the SD card, the formatting will take slightly longer than normal formatting.
- You can stop the low-level formatting by selecting [Cancel]. Even in this case, normal formatting will have been completed and you can use the SD card as usual.

MENU Reverting Camera Settings to the Default

The camera's shooting settings and menu settings can be reverted to the default.

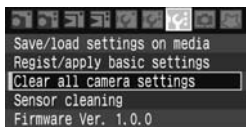

1 Select [Clear all camera settings].

- Under the [M:] tab, select [Clear all camera settings], then press <SET>.

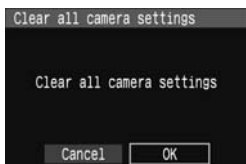

2 Select [OK].

- Turn the <🌀> dial to select [OK], then press <SET>.
- ▶ The camera's default settings will be as shown on the next page.

- Setting **[Clear all camera settings]** will reset the camera to the following default settings:

Shooting Settings

Shooting mode	P (Program AE)
AF mode	One-Shot AF
AF point selection	Automatic selection
Metering mode	Evaluative metering
Drive mode	Single shooting
Exposure compensation	0 (Zero)
AEB	Canceled
Flash exposure compensation	0 (Zero)
Live View shoot.	Disable
Grid display	Off
Custom Functions	No changes









Image-Recording Settings

Record func.	Standard
Image size	L (Large)
JPEG quality	8
ISO speed	100
Picture Style	Standard
Color space	sRGB
White balance	AWB (Auto)
WB correction	Canceled
WB-BKT	Canceled
File numbering	Continuous
File name setting	Preset code
Auto cleaning	Enable
Dust Delete Data	Erased

Camera Settings

Auto power off	1 min.
Beep	On
Shoot w/o card	On
Review time	2 sec.
Highlight alert	Disable
AF point disp.	Disable
Registered AF point	Canceled (Center)
Histogram	Brightness
Enlarge display	Center

Camera Settings

Image jump w/ 	10 images
Auto rotate	On  
LCD brightness	    
Date/Time	No changes
Language	No changes
Video system	No changes
My Menu settings	No changes

2

Image Settings

This chapter explains the settings for shooting digital images: Image-recording quality, ISO speed, Picture Styles, white balance, and color space.



When the camera is ready to shoot, you can press the <INFO.> button to see the image settings. (p.186)

Setting the Image-recording Quality

You can set the image size (recorded pixels), image type (JPEG, RAW, sRAW), and JPEG quality (compression rate).

Selecting the Image Size

L/M1/M2/S will record the image in the JPEG. In the **RAW/sRAW** mode, the image will require processing with the software provided. **sRAW** is a small RAW image which is one-fourth (approx. 5.2 megapixels) the size of a normal RAW image.

Also, RAW/sRAW and JPEG images can be recorded at the same time on the memory card.

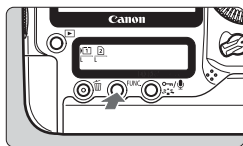

1 Press the <FUNC.> button. (6)

- Press the <FUNC.> button once or twice to display the card and image size on the rear LCD panel.

Image size/Card ↔ WB





2 Select the image size.

- Turn the <mode> dial to select the image size.
- If **RAW** or **sRAW** and L/M1/M2/S are displayed at the same time, the RAW or sRAW and JPEG image will be recorded simultaneously on the card.
- Turn the <card> dial to select the card to record or playback images. (p.73)



Image Size Guide

Image size		Pixels	Print Size
L (Large)	JPEG	Approx. 21.0 megapixels (5616x3744)	A2 or larger
M1 (Medium1)		Approx. 16.6 megapixels (4992x3328)	Around A2
M2 (Medium2)		Approx. 11.0 megapixels (4080x2720)	Around A3
S (Small)		Approx. 5.2 megapixels (2784x1856)	Around A4
RAW (RAW)		Approx. 21.0 megapixels (5616x3744)	A2 or larger
sRAW (Small RAW)		Approx. 5.2 megapixels (2784x1856)	Around A4



- You can also use the [ Image size] menu to set the image size.
- For simultaneous image recording, the RAW or sRAW image and the JPEG image will be recorded with the same file number in the same folder.
- If the [ Record func+media/folder sel.] menu's [Record func.] is set to [Rec. separately], you can set the image size (except for RAW+JPEG and sRAW+JPEG) for the respective card.
- In accordance with the selected image size, the <JPEG> or <RAW> icon will be displayed on the right side in the viewfinder. If sRAW has been selected, <RAW> will be displayed.

File Size and Memory Card Capacity

Image size	File Size (Approx. MB/Shot)	Possible Shots (Approx.)	Maximum Burst (Approx.)	
			 High-speed	 Low-speed
L	6.4	290	56 (63)	83 (180)
M1	5.2	350	73 (96)	140 (370)
M2	3.9	470	110 (160)	300 (500)
S	2.2	840	160 (470)	890 (890)
RAW	25.0	75	12 (12)	14 (16)
RAW + L	25.0 + 6.4	54	10 (10)	10 (10)
RAW + M1	25.0 + 5.2	57	10 (10)	10 (10)
RAW + M2	25.0 + 3.9	60	12 (12)	12 (12)
RAW + S	25.0 + 2.2	64	12 (12)	12 (12)
sRAW	14.5	130	18 (18)	24 (28)
sRAW + L	14.5 + 6.4	82	12 (12)	14 (16)
sRAW + M1	14.5 + 5.2	90	12 (12)	14 (16)
sRAW + M2	14.5 + 3.9	97	12 (12)	18 (18)
sRAW + S	14.5 + 2.2	100	18 (20)	20 (24)

- The number of possible shots and maximum burst apply to a 2GB CF card based on Canon's testing standards. Figures in parentheses apply to an Ultra DMA (UDMA) 2GB CF card based on Canon's testing standards.
- The file size, number of possible shots, and maximum burst during continuous shooting are based on Canon's testing standards (JPEG quality: 8, ISO 100, Picture Style: Standard).
- Check the viewfinder or top LCD panel for the current number of possible shots.
- **The file size, number of possible shots, and maximum burst during continuous shooting will vary depending on the subject, memory card brand, ISO speed, Picture Style, etc.**
- In the case of monochrome images, the file size will be smaller so the number of possible shots will be higher.

About RAW

The RAW image is the data output by the image sensor and converted to digital data which is recorded on the memory card as is. The RAW image is transferred to a personal computer where software (provided) is used to adjust the image as needed. From the RAW image, the software can develop and generate the adjusted image in the desired type such as JPEG or TIFF.

About sRAW

This is a small RAW image which is one-fourth (approx. 5.2 megapixels) the size of a normal RAW image. As with RAW images, sRAW images can be developed and adjusted with the provided software. This image type is handy when you do not need a very high resolution as a normal RAW image.

Maximum Burst During Continuous Shooting



The maximum burst shown on the preceding page indicates the number of continuous shots that can be taken with a formatted 2GB CF card based on Canon's testing standards.

The actual maximum burst will vary depending on the subject, memory card brand, image-recording quality (image size and JPEG quality), ISO speed, drive mode, Picture Style, Custom Functions, etc. The maximum burst shown are only estimated figures. In the viewfinder, the approximate maximum burst is indicated on the right side.

- If C.Fn II -2 [**High ISO speed noise reduction**] is set to [**1: On**], the maximum burst will be greatly reduced. (p.163)
- If C.Fn I -8 [**Safety shift**] is set to [**2: Enable (ISO speed)**], the maximum burst displayed in the viewfinder will decrease. (p.160)
- The maximum burst is displayed even when a memory card is not in the camera. Make sure that a memory card is loaded before taking a picture.
- The maximum burst for <[H]> is displayed regardless of the drive mode.



If the viewfinder displays “99” for the maximum burst, it means the maximum burst is 99 or higher. If 98 or lower is displayed, the maximum burst is 98 or lower. If you stop the continuous shooting, the maximum burst will increase. After all the captured images are written to the memory card, the maximum burst will be as listed on page 53.

MENU Setting the JPEG Quality (Compression Rate)

The image-recording quality (compression rate) can be set for each image size L/M1/M2/S.

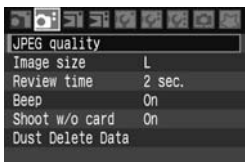

1

Select [JPEG quality].

- Under the [] tab, select [JPEG quality], then press <SET>.



2

Select the image size.

- Turn the <> dial to select the image size, then press <SET>.



3

Set the desired quality (compression rate).

- Turn the <> dial to select setting, then press <SET>.
- The higher the number, the higher the quality will be (lower compression).
- For 6 - 10, < > is displayed. For 1 - 5, < > is displayed.



The higher the image-recording quality, the fewer the number of possible shots will be. On the other hand, the lower the image-recording quality, the higher the number of possible shots will be.

ISO: Setting the ISO Speed

The ISO speed is a numeric indication of the sensitivity to light. A higher ISO speed number indicates a higher sensitivity to light. Therefore, a high ISO speed is suited for low light and moving subjects. However, the image may look more coarse with noise, etc. On the other hand, a low ISO speed is not suited for low light or action shots, but the image will look finer.

The camera can be set between ISO 100 and 1600 in 1/3-stop increments.

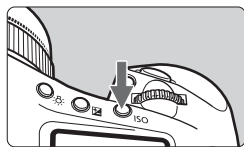

1 Press the <ISO> button. (ⓘ6)

- ▶ The current ISO speed will be displayed on the top LCD panel and in the viewfinder.



2 Set the ISO speed.

- Turn the <ⓘ6>/<ⓘ6> dial to set the ISO speed.



- Using a high ISO speed or shooting in high-temperature conditions may result in more grainy images.
- High temperatures, high ISO speeds, or long exposures may cause irregular colors in the image.
- If C.Fn II -3 [**Highlight tone priority**] is set to [1: **Enable**], "L" (equivalent to ISO 50), ISO 100/125/160 and "H" (equivalent to ISO 3200) settings cannot be set. (p.164)

With C.Fn I -3 [**Set ISO speed range**], the ISO speed range can be extended to ISO 50 (L) to 3200 (H). (p.158)

Selecting a Picture Style

By selecting a Picture Style, you can obtain the desired image effects matching your photographic expression or the subject.

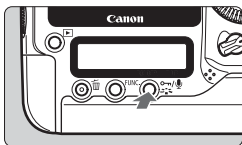

1 Press the $\langle \text{Picture Style} \rangle$ button.

- When the camera is ready to shoot, press the $\langle \text{Picture Style} \rangle$ button.
- ▶ The Picture Style screen will appear.



2 Select a Picture Style.

- Turn the $\langle \text{Dial} \rangle$ dial to select a Picture Style, then press $\langle \text{SET} \rangle$.
- ▶ The Picture Style will take effect and the camera will be ready to shoot.



You can also use the [Picture Style] menu to select the Picture Style.

Picture Style Effects

● Standard

The image looks vivid and sharp.

● Portrait

For nice skin tones. The image looks slightly sharp.

● Landscape

For vivid blues and greens, and very sharp images.

● Neutral

For natural colors and subdued images. This Picture Style assumes that you will do post-processing with a personal computer.

● Faithful

The image is dull and subdued. When the subject is captured under a color temperature of 5200K, the color is adjusted colorimetrically to match the subject's color. This Picture Style assumes that you will do post-processing with a personal computer.

● Monochrome

For black-and-white images.



- To obtain natural-looking, black-and-white images, set a suitable white balance.
- With JPEG **L/M1/M2/S** images, color cannot be restored to the black-and-white image. Do not use this Picture Style if you want color JPEG images. When **[Monochrome]** is selected, **<B/W>** will appear on the rear LCD panel.

● User Def. 1-3

You can select a base Picture Style such as **[Portrait]** or **[Landscape]**, adjust its parameters as desired and register it under **[User Def. 1]** to **[User Def. 3]**. Any User Defined Picture Style which has not been set will have the same settings as the Standard Picture Style.

About the Symbols

The symbols on the upper right of the Picture Style selection screen refer to parameters such as **[Sharpness]** and **[Contrast]**. The numerals indicate the parameters settings, such as **[Sharpness]** and **[Contrast]**, for each Picture Style.



Symbols

	Sharpness
	Contrast
	Saturation
	Color tone
	Filter effect (Monochrome)
	Toning effect (Monochrome)

Customizing the Picture Style

You can customize the Picture Style by adjusting the individual parameters like [Sharpness] and [Contrast]. To customize [Monochrome], see the next page.



1 Press the <INFO> button.

2 Select a Picture Style.

- Turn the <DIAL> dial to select a Picture Style, then press the <INFO> button.



3 Select a parameter.

- Turn the <DIAL> dial to select a parameter, then press <SET>.



4 Set the parameter.

- Turn the <DIAL> dial to set the parameter as desired, then press <SET>.
- Press the <MENU> button to save the adjusted parameter. The Picture Style selection screen will reappear.
- ▶ Any settings different from the default will be displayed in blue.



Parameter Settings and Effects

Sharpness	[0] : Less sharp outline	[+7] : Sharp outline
Contrast	[-4] : Low contrast	[+4] : High contrast
Saturation	[-4] : Low saturation	[+4] : High saturation
Color tone	[-4] : Reddish skin tone	[+4] : Yellowish skin tone

- By selecting [**Default set.**] in step 3, you can revert the respective Picture Style to its default parameters.
- To shoot with the Picture Style you modified, follow step 2 on the preceding page to select the Picture Style and then shoot.

Monochrome Adjustment

For Monochrome, you can also set [**Filter effect**] and [**Toning effect**] in addition to [**Sharpness**] and [**Contrast**].

[Filter effect]

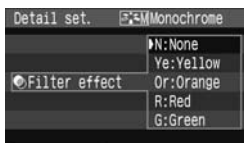

With a Filter effect applied to a monochrome image, you can make white clouds or green trees stand out more.

Filter	Sample effects
N: None	Normal black-and-white image with no filter effects.
Ye: Yellow	The blue sky will look more natural, and the white clouds will look crisper.
Or: Orange	The blue sky will look slightly darker. The sunset will look more brilliant.
R: Red	The blue sky will look quite dark. Fall leaves will look crisper and brighter.
G: Green	Skin tones and lips will look fine. Tree leaves will look crisper and brighter.

- Setting the [**Contrast**] to the plus side will make the filter effect more pronounced.

[Toning effect]

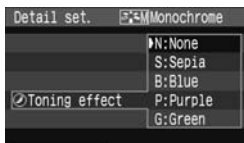

By applying a toning effect, you can create a monochrome image in that color. It can make the image look more impressive.

The following can be selected: [**N:None**] [**S:Sepia**] [**B:Blue**] [**P:Purple**] [**G:Green**].

Registering the Picture Style

You can select a base Picture Style such as [Portrait] or [Landscape], adjust its parameters as desired and register it under [User Def. 1], [User Def. 2], or [User Def. 3]. You can create Picture Styles whose parameters such as sharpness and contrast are different. You can also select a Picture Style already set with the provided software.

1 Press the button.

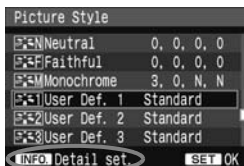

2 Select [User Def.].

- Turn the  dial to select [User Def. *], then press the <INFO.> button.



3 Press <SET>.

- With [Picture Style] selected, press <SET>.



4 Select the base Picture Style.

- Turn the  dial to select the base Picture Style, then press <SET>.
- If you already have a Picture Style set with the provided software, select it here.



5 Select a parameter.

- Turn the  dial to select a parameter, then press <SET>.

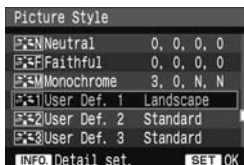
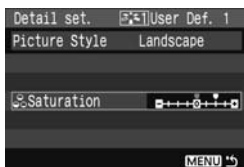

6 Set the parameter.

- Turn the <⦿> dial to set the parameter as desired, then press <SET>.
- Press the <MENU> button to register the new Picture Style. The Picture Style selection screen will then reappear.
 - ▶ The base Picture Style will be displayed on the right of [**User Def. ***].
 - ▶ The name of the Picture Style having any modified settings (different from the default) registered under [**User Def. ***] will be displayed in blue.

⚠ If a Picture Style has already been registered under [**User Def. ***], changing the base Picture Style in step 4 will nullify the parameters of the registered contents of the Picture Style.

📄 To shoot with the registered Picture Style, follow step 2 for selecting [**User Def. ***] on the preceding page.

Selecting the White Balance

White balance (WB) is for making the white areas look white. Normally, the **<AWB>** (Auto) setting will obtain the correct white balance. If natural-looking colors cannot be obtained with **<AWB>**, you can set the white balance manually to suit the respective light source.

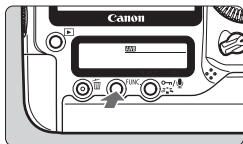

1 Press the **<FUNC.>** button. (ⓘ6)

- Press the **<FUNC.>** button once or twice to display the white balance on the rear LCD panel's upper right.

WB ↔ Card/Image size



2 Select the white balance.

- Turn the **<ⓘ>** dial to select the white balance.

Icon	Mode	Color temperature (Approx. K: Kelvin)
	Auto	3000 - 7000
	Daylight	5200
	Shade	7000
	Cloudy, twilight, sunset	6000
	Tungsten light	3200
	White fluorescent light	4000
	Flash	6000
	Custom (p.64)	2000 - 10000
	Color temperature (p.69)	2500 - 10000

About White Balance

To the human eye, a white object looks white regardless of the type of lighting. With a digital camera, the color temperature is adjusted with software to make the white areas look white. This adjustment serves as the basis for the color correction. The result is natural-looking colors in the pictures.



- You can also use the [**White balance**] menu to set the white balance.
- To set Personal white balance, go to the [**White balance**] menu and select [**PC ***]. To save the Personal WB to the camera, use the provided software. If no Personal WB has been registered, the menu will not be displayed.

Custom White Balance

Custom white balance enables you to manually set the white balance for a specific light source for better accuracy. Up to five Custom white balance data can be registered to the camera. You can also append a name (caption) to the registered Custom white balance data.

MENU Registering Custom WB

There are two ways to register Custom white balance data. You can either take a picture and register it, or register an image already saved in the memory card.

[Record and register image]

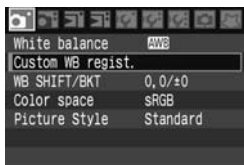

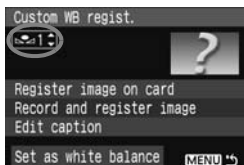

1 Select [Custom WB regist.].

- Under the [] tab, select [Custom WB regist.], then press <SET>.



2 Select the Custom WB No. to be registered.

- Press <SET>.
- Turn the < > dial to select 1 to 5 for <* >, then press <SET>. The Custom WB data will be registered under the selected No.

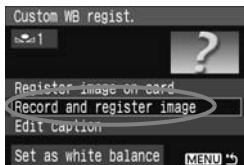

3 Select [Record and register image].

- Turn the < > dial to select [Record and register image], then press <SET>.
- ▶ The LCD monitor will turn off, and the selected No. [*] will blink on the rear LCD panel.

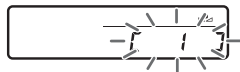

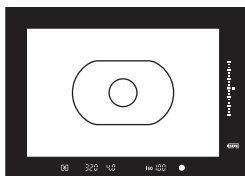

4 Photograph a solid-white object.

- The plain, white object should fill the center spot metering circle.
- Set the lens focus mode switch to <MF>, then focus manually. (p.86)
- Shoot the white object so that a standard exposure (gray) is obtained. If it is underexposed or overexposed, a correct white balance setting might not be obtained.
- ▶ The Custom WB data will be registered in the camera. When it is completed, a message will appear on the screen.
- To use the Custom WB, see “Selecting and Shooting with the Custom WB data” (p.67).



- A Custom WB data can also be registered as follows:
 1. Press the <FUNC.> button and turn the <DIAL> dial to select <WB>. (p.63)
 2. Then turn the <DIAL> dial to select the No. under which the Custom WB is to be registered.
 3. Press the <WB> button.
→ [*] will blink on the rear LCD panel.
 4. Follow step 4 above to photograph a solid-white object.
→ The Custom WB will be registered under the selected No. and a completion message will appear on the screen.

When a picture is taken, the registered Custom white balance will be applied. (This registration method does not require the “Selecting and Shooting with the Custom WB data” step on page 67.)

- If [Correct WB may not be obtained with the selected image] is displayed in step 4, go back to step 1 and try again.
- The captured image will not be recorded to the memory card.

[Register image on card]

First follow step 4 under [Record and register image] to take a picture of a plain, white object. This image saved in the memory card can then be registered for Custom WB. The procedure up to step 2 is the same as with [Record and register image].

1 Select [Custom WB regist.].

2 Select the Custom WB No. to be registered.



3 Select [Register image on card].

- Turn the <◉> dial to select [Register image on card], then press <SET>.
- ▶ The images saved in the memory card will be displayed.

4 Select the image to be used for registering the Custom WB data.

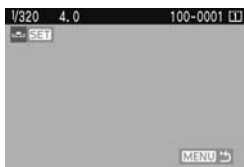

- You can also display a four- or nine-image index by pressing the <Q> button.
- Turn the <◉> dial to select the image to be registered for the Custom WB data, then press <SET>.

5 Select [OK].

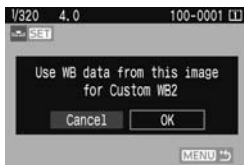

- Turn the <◉> dial to select [OK], then press <SET>.
- ▶ The Custom WB data will be registered, and a message will be displayed. Press <SET> to return to step 3.
- To use the registered Custom WB data, see “Selecting and Shooting with the Custom WB data” (p.67).

MENU Selecting and Shooting with the Custom WB data

You can shoot with the registered Custom WB data.

- Registered images
- 



1 Select the registered Custom WB No.

 - On the Custom WB registration screen, select the No. of the registered Custom WB.
 - 

2 Select [Set as white balance].

 - Turn the  dial to select **[Set as white balance]**, then press **<SET>**.
 - The WB will be set to the registered **<WB>***.
 - 3 Take the picture.**

 - The picture will be taken with the **<WB>*** setting.

 You can also select the Custom WB No. while looking at the rear LCD panel. Press the **<FUNC.>** button and turn the  dial to select **<WB>**. Then turn the  dial to select the registered Custom WB No.

MENU Naming the Custom WB data

You can append a name (caption) to up to five Custom WB data registered with **[Record and register image]** or **[Register image on card]**.

- 

1 Select the Custom WB No.

 - On the Custom WB data registration screen, select the Custom WB No. to be appended with a name.

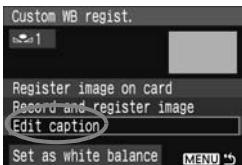

2 Select [Edit caption].

- Turn the <◀▶> dial to select [Edit caption], then press <SET>.

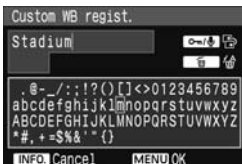

3 Enter any name.

- Press the <ON/OFF> button, and the text palette will be highlighted in a color frame and text can be entered.
- Operate the <◀▶> dial or <⬇️⬆️⬇️> to move the cursor and select the desired character. Then press <SET> to enter it. You can enter up to 20 characters.
- To change the name, first delete the unnecessary characters. Operate the <◀▶> dial or <⬆️⬆️⬆️> to move the cursor to the right of the character to be deleted. Then press the <🗑️> button to delete one character.
- After entering the name, press the <MENU> button.
- ▶ The name will be saved and the screen will return to step 2. The entered name will be displayed below <📷*>.

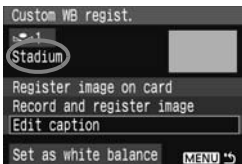

Entering a name which indicates the Custom WB's place or light source type makes it convenient.

Setting the Color Temperature

You can numerically set the white balance's color temperature.

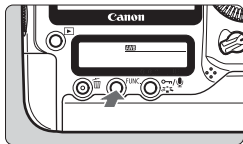

1 Press the <FUNC.> button. (ⓘ6)

- Press the <FUNC.> button once or twice to display the white balance on the rear LCD panel's upper right.

WB ↔ Card/Image size

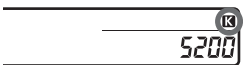

2 Select <K>.

- Turn the <◉> dial to select <K>.



3 Set the desired value.

- Turn the <☀> dial to set the color temperature.
- You can set it within 2500K to 10000K in 100K increments.



- When setting the color temperature for an artificial light source, set white balance correction (magenta or green) as necessary.
- If you want to set <K> to the reading taken with a commercially-available color temperature meter, take test shots and adjust the setting to compensate for the difference between the color temperature meter's reading and the camera's color temperature reading.



You can also use the [☑ White balance] menu to set the white balance.

MENU White Balance Correction

You can correct the white balance that has been set. This adjustment will have the same effect as using a commercially-available color temperature conversion filter or color compensating filter. Each color can be corrected to one of nine levels.

Users familiar with using color temperature conversion or color compensating filters will find this feature handy.

White Balance Correction



1 Select [WB SHIFT/BKT].

- Under the [WB] tab, select [WB SHIFT/BKT], then press <SET>.

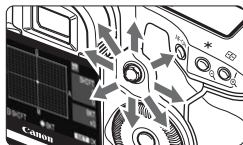

2 Set the white balance correction.

- Use <DIAL> to move the "■" mark to the desired position.
- B is for blue, A is amber, M is magenta, and G is green. The color in the respective direction will be corrected.
- On the upper right, "SHIFT" indicates the direction and correction amount.
- To cancel the white balance correction, move the "■" to the center so that the "SHIFT" is "0, 0".
- Press <SET> to exit and return to the menu.

Sample setting : A2, G1

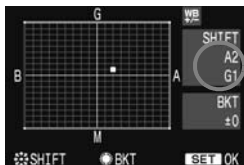

- During the white balance correction, <WB> will be displayed in the viewfinder and on the rear LCD panel.
- One level of the blue/amber correction is equivalent to 5 mireds of a color temperature conversion filter. (Mired: A measurement unit indicating the density of a color temperature conversion filter.)

White Balance Auto Bracketing

With just one shot, three images having a different color tone can be recorded simultaneously. Based on the color temperature of the current white balance setting, the image will be bracketed with a blue/amber bias or magenta/green bias. This is called white balance bracketing (WB-BKT). White balance bracketing is possible up to ± 3 levels in single-level increments.

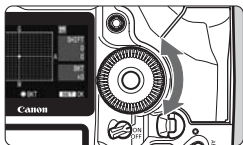

B/A bias ± 3 levels

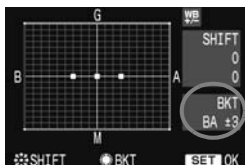

Set the white balance bracketing amount.

- In step 2 for white balance correction, when you turn the $\langle \odot \rangle$ dial, the “■” mark on the screen will change to “■■■” (3 points). Turning the dial to the right sets the B/A bracketing, and turning it to the left sets the M/G bracketing.
- ▶ On the right side of the screen, “BKT” indicates the bracketing direction and the bracketing amount is also displayed.
- Press $\langle \text{SET} \rangle$ to exit and return to the menu.
- To cancel the bracketing, set “BKT” to “ ± 0 ” (“■■■” becomes “■” (1 point)).

Bracketing Sequence

Correct white balance, blue (B) bias, and amber (A) bias. Or, correct white balance, magenta (M) bias, and green (G) bias.



- During WB bracketing, the maximum burst for continuous shooting will be lower and the number of possible shots will also decrease to one-third the normal number. Also, the white balance icon will blink on the rear LCD panel.
- You can also set white balance correction and AEB together with white balance bracketing. If you set AEB in combination with white balance bracketing, a total of nine images will be recorded for a single shot.
- Since three images are recorded for one shot, the memory card will take longer to record the shot.
- “BKT” stands for Bracketing.

MENU Setting the Color Space

The color space refers to the range of reproducible colors. With this camera, you can set the color space for captured images to sRGB or Adobe RGB. For normal images, sRGB is recommended.

1 Select [Color space].

- Under the [M] tab, select [Color space], then press <SET>.

2 Set the desired color space.

- Select [sRGB] or [Adobe RGB], then press <SET>.

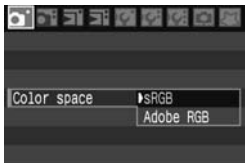





About Adobe RGB



This is mainly used for commercial printing and other industrial uses. This setting is not recommended if you do not know about image processing, Adobe RGB, and Design rule for Camera File System 2.0 (Exif 2.21). Since the image will look very subdued with sRGB personal computer environment and printers not compatible with Design rule for Camera File System 2.0 (Exif 2.21), post-processing of the image with software will be required.

- If the captured image was shot in the Adobe RGB color space, the first character in the file name will be an underscore “_”.
- The ICC profile is not appended. The ICC profile is explained in the Software Instruction Manual in the CD-ROM.

Selecting the Media, Folder, and Recording Method

-  This Instruction Manual assumes that a CF card or SD card is in the camera. When an external media is used via the **Wireless File Transmitter WFT-E2 II A/B/C/D** or **WFT-E2/A** (sold separately), the  icon will appear as the third recording media. It can be selected in the same way as with the CF card  and SD card .

Selecting a Memory Card

If only the CF card  or SD card  is in the camera, the memory card for recording will be selected automatically. If both the CF and SD cards are in the camera, you can select the card for recording images as follows:

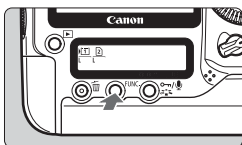





1 Press the <FUNC.> button. (06)

- Press the <FUNC.> button once or twice to display the memory card and image size on the rear LCD panel's left.

Card/Image size ↔ WB



2 Select the memory card.

- Turn the  dial to select the memory card for recording images.
 -  : Record to CF card
 -  : Record to SD card
- Turn the  dial to select the image size. (p.52)



- If the recording method (p.74) has been set to **[Rec. separately]** **[Rec. to multiple]**, the image will be recorded to both the CF and SD cards. The selection will then specify which card to playback the images.
- You can also use the **[If Record func+media/folder sel.]** menu's **[Record/play]** (**[Playback]**) option to select the memory card used for image recording and playback.

MENU Setting the Recording Method

You can set how the image is recorded to the memory card.

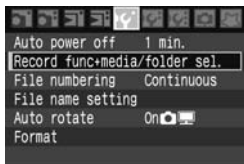

1 Select [Record func+media/folder sel.].

- Under the [**M**] tab, select [**Record func+media/folder sel.**], then press <SET>.

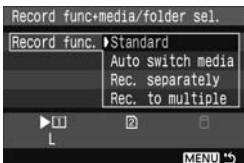

2 Select [Record func.].

- Turn the <DISP> dial to select [**Record func.**], then press <SET>.

3 Select the recording method.

- Turn the <DISP> dial to select the recording method, then press <SET>.

● **Standard**

When both memory cards are in the camera, the selected card will record the images.

● **Auto switch media**

When both memory cards are in the camera, the selected card will record the images. Then when the card becomes full, the camera will automatically switch to the other card to record images.

● **Rec. separately**

Each image is recorded to both the CF and SD cards. The image size (**L/M1/M2/S/RAW/sRAW**) to be recorded can be set individually for each card. (p.52) For example, you can record a JPEG image to both cards or a RAW image to one card and sRAW to the other card.

● **Rec. to multiple**

Each image is recorded to both the CF and SD cards simultaneously. **RAW**+JPEG or **sRAW**+JPEG can also be selected. (p.52)



- When [**Auto switch media**] is set, the card for recording will switch from ① to ②.
- When [**Rec. separately**] or [**Rec. to multiple**] is set, the image will be recorded under the same file number in both the CF and SD cards. The number of shots remaining displayed on the top LCD panel and in the viewfinder is based on the card with fewer remaining shots than the other card. If one of the cards becomes full, [**Card* full**] will be displayed and shooting will be disabled. If this happens, either replace the card or set the recording method to [**Standard**] or [**Auto switch media**] and select the card with remaining space, and then shooting can continue.

MENU Creating a Folder

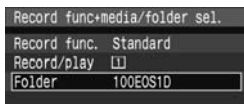

1 Select [Folder].

- In step 2 for “Setting the Recording Method,” select [**Folder**], then press <SET>.

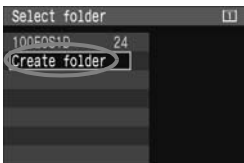

2 Select [Create folder].

- Turn the <◉> dial to select [**Create folder**], then press <SET>.

3 Select [OK].

- ▶ A new folder with a higher one-up folder number is created.

MENU Selecting a Folder

Lowest file number
Quantity of images in folder



Folder name

Highest file number

- Turn the <◉> dial to select the folder, then press <SET>.
- Look at the images on the right to help you select the folder you want.
- Subsequent captured images will be recorded into the selected folder.

About Folders

As with “100EOS1D” for example, the folder name starts with three digits (folder number) followed by five characters. A folder can contain up to 9999 images (file No. 0001 - 9999). When a folder becomes full, a new folder with a higher one-up folder number is created automatically. Also, if manual reset (p.80) is executed, a new folder will be created automatically. Folders numbered from 100 to 999 can be created.

Creating Folders with a Personal Computer

With the memory card open on the screen, create a new folder named “DCIM”. Open the DCIM folder and create as many folders as necessary to save and organize your images. The folder name must follow the “100ABC_D” format where the first three digits is 100 - 999 followed by five alphanumeric characters. The five characters can be a combination of upper- or lower-case letters from A to Z, numerals, and an underscore “_”. There can be no spaces in the folder name. Also, folder names cannot have the same three-digit number such as “100ABC_D” and “100W_XYZ” even if the letters are different.

MENU Changing the File Name

The file name has four alphanumeric characters followed by a four-digit image number (p.79) and extension. The first four alphanumeric characters are set upon factory shipment and unique to the camera. However, you can change it. (Ex.) **7E3B0001.JPG**

With “User setting1,” you can change and register the four characters as desired. With “User setting2,” if you register three characters, the fourth character from the left will be appended automatically to indicate the image size.

Registering the File Name (first 4 characters)

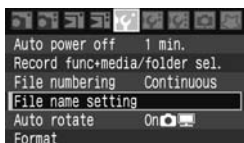

1 Select [File name setting].

- Under the [IY] tab, select [File name setting], then press <SET>.

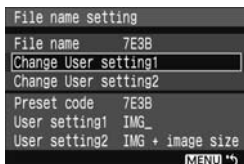

2 Select [Change User setting].

- Turn the <DIAL> dial to select [Change User setting*], then press <SET>.

3 Enter any alphanumeric characters.

- With User setting1, enter 4 characters. With User setting2, enter 3 characters.
- Operate the <DIAL> dial or <DIRECTIONAL> to move the cursor to the right of the character to be deleted. Then press the <DELETE> button to delete the character.
- Press the <ENTER/OK> button, and the text palette will be highlighted in a color frame and text can be entered.

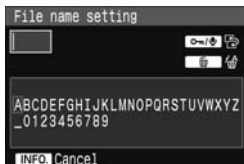

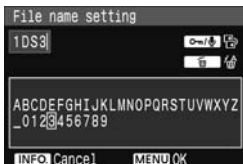

- Operate the <⊙> dial or <⊙> to move the and select the desired character. Then press <SET> to enter it.
- Enter the required number of alphanumeric characters, then press the <MENU> button.
- ▶ The new file name will be registered and the screen in step 2 will reappear.

4 Select the registered file name.

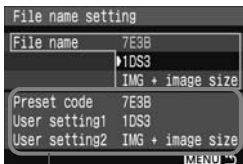

Settings

- Turn the <⊙> dial to select **[File name]**, then press <SET>.
- Turn the <⊙> dial to select the registered file name.
- If User setting2 has been registered, select “*** (the 3 characters registered) + image size.”

About User setting2

When you select the “*** + image size” registered with User setting2 and take pictures, the image size character will be automatically appended as the file name’s fourth character from the left. The meaning of the file name characters is as follows:

“*** L” = L (JPEG Large), **RAW** “*** M” = M1 (JPEG Medium1)
 “*** N” = M2 (JPEG Medium2) “*** S” = S (JPEG Small), **sRAW**

When the image is transferred to a personal computer, the automatically appended fourth character will be included. You can then see the image size without having to open the image. The image type (RAW, sRAW, JPEG) can be distinguished with the extension.

- The first character cannot be an underscore “_”.
- The extension will be “.JPG” for JPEG images and “.CR2” for RAW and sRAW images.

MENU File Numbering Methods

The 4-digit file number is like the frame number on a roll of film. The captured images are assigned a sequential file number from 0001 to 9999 and saved to one folder. You can also change how the file number is assigned. (Ex.) **7E3B0001.JPG**

- 1 Select [File numbering].**
 - Under the [F] tab, select [File numbering], then press <SET>.
- 2 Select the file numbering method.**
 - Turn the <DIAL> dial to select the desired method, then press <SET>.

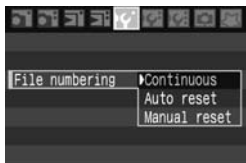

Continuous

Continues the file numbering sequence even after the memory card is replaced or a new folder is created.

Even after you replace the memory card or create a new folder, the file numbering continues in sequence up to 9999. This is convenient when you want to save the images numbered anywhere between 0001 to 9999 in multiple cards or folders into one folder in your personal computer.

If the replacement memory card or existing folder already contains images recorded previously, the file numbering of the new images might continue from the file numbering of the existing images in the card or folder. If you want to save images with continuous file numbering, use a newly formatted memory card each time.

File numbering after replacing the memory card

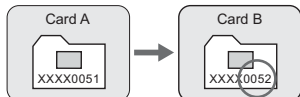

File numbering after changing the folder

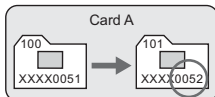

Auto Reset

The file numbering restarts from 0001 each time the memory card is replaced or a new folder is created.

Whenever the memory card is replaced or a new folder created, the file numbering starts from 0001. This is convenient if you want to organize images according to memory cards or folders.

If the replacement memory card or existing folder already contains images recorded previously, the file numbering of the new images might continue from the file numbering of the existing images in the card or folder. If you want to save images with the file numbering starting from 0001, use a newly formatted memory card each time.

File numbering after replacing the memory card

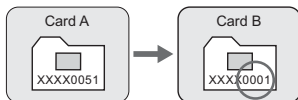

File numbering after changing the folder

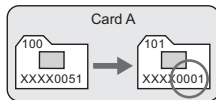

Manual Reset

The file numbering starts from 0001 in the new folder.

When you reset the file numbering manually, a new folder is created automatically and the file numbering of images saved to that folder starts from 0001. This is convenient when you want to use different folders for the images taken yesterday and the ones taken today, for example. After the manual reset, the file numbering returns to continuous or auto reset.

! If the folder number is 999 and the file number reaches 9999, you will not be able to take any more pictures even if the memory card is not full. A message asking you to replace the memory card will appear on the LCD monitor. Either replace the memory card or switch to the other memory card in the camera.

3

Setting the AF and Drive Modes

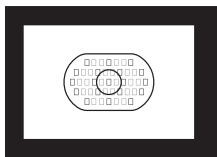

The Area AF has 45 AF points (19 high-precision cross-type points and 26 Assist AF points). You can select any one of the 19 cross-type points to match your composition.

You can also select the AF mode to match the shooting conditions and subject and select the best drive mode.



<AF> stands for auto focus. <MF> stands for manual focus.

AF: Selecting the AF Mode

Select the AF mode suiting the shooting conditions or subject.

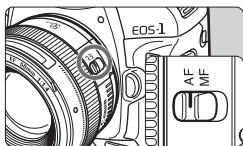

- 1 On the lens, set the focus mode switch to <AF>.

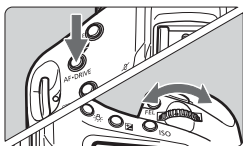

- 2 Press the <AF•DRIVE> button. (ⓘ6)

- 3 Select the AF mode.

- Turn the <ⓘ6> dial to select the AF mode.

AI SERVO ↔ ONE SHOT

One-Shot AF for Still Subjects

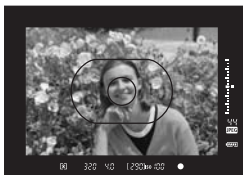
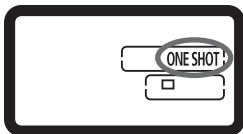

Suited for still subjects. When you press the shutter button halfway, the camera will focus only once.

- When focus is achieved, the AF point which achieved focus will flash in red, and the focus confirmation light <●> in the viewfinder will also light.
- With evaluative metering, the exposure setting will be set at the same time focus is achieved.
- While you hold down the shutter button halfway, the focus will be locked. You can then recompose the shot if desired.
- AF is also possible by pressing the <AF-ON> button.

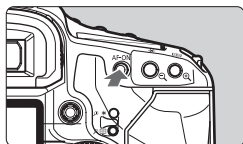



- If focus cannot be achieved, the focus confirmation light <●> in the viewfinder will blink. If this occurs, a picture cannot be taken even if the shutter button is pressed completely. Recompose the picture and try and focus again. Or see “When Autofocus Fails” (p.86).
- If the [D: Beep] menu is set to [Off], the beeper will not sound when focus is achieved.



Focus Lock

After achieving focus with One-Shot AF, you can lock the focus on a subject and recompose the shot. This is called “focus lock.” This is convenient when you want to focus a subject not covered by the Area AF.

AI Servo AF for Moving Subjects



This AF mode is for moving subjects when the focusing distance keeps changing. While you hold down the shutter button halfway, the subject will be focused continuously.

- The exposure is set at the moment the picture is taken.
- AF is also possible by pressing the <AF-ON> button.

Focus Tracking with AI Servo AF

If the subject approaches or retreats from the camera at a constant rate, the camera tracks the subject and predicts the focusing distance immediately before the picture is taken. This is for obtaining correct focus at the moment of exposure.

- When the AF point selection is automatic (p.84), the camera first uses the center AF point to focus. During autofocusing, if the subject moves away from the center AF point, focus tracking continues as long as the subject is covered by the Area AF.
- With a manually selected AF point, the selected AF point will focus track the subject.



With AI Servo AF, the beeper will not sound even when focus is achieved. Also, the focus confirmation light <●> in the viewfinder will not light.

Selecting the AF Point

Automatic AF Point Selection

From among the 45 AF points, the camera selects the AF point automatically to suit the shooting conditions.

Manual AF Point Selection

You can manually select any of the 19 cross-type AF points. This is best when you want to focus the target subject at will, or autofocus quickly while composing the shot.

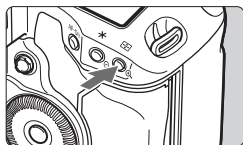

Automatic AF point selection:

 AF

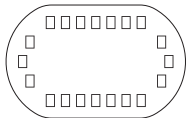

Manual AF point selection:



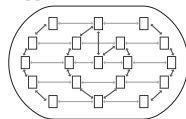

SEL []/SEL AF



1 Press the button. (p.6)

- ▶ The current AF point will light in the viewfinder.

2 Select the AF point.

- To select a horizontal AF point, turn the  dial. If all the peripheral AF points light up, automatic AF point selection will take effect.
- The AF point selection will follow the periphery as you turn the  dial. If the current AF point is near the center, the AF point selection will follow an oval path. If the current AF point is along the periphery, the AF point selection will follow the periphery and stop at the top or bottom.
- By pressing , you can select the center AF point  automatic selection.
- When you press the shutter button halfway, the camera will be ready to shoot.



- The 26 Assist AF points are not user selectable.
- The  cannot be used to manually select any AF point other than the center AF point.
- With C.Fn III -9 [Selectable AF point], the selectable AF points can be limited to the inner or outer 9 AF points. (p.170)
- With C.Fn III -8 [AF expansion w/selected pt], the manually-selected AF point's adjacent left and right AF points or the surrounding AF points can also be made active. (p.170)
- By registering the AF point you use frequently, you can switch to it instantly by setting C.Fn III -10-1 or C.Fn III -6-6 (p.171, 168).

Lens' Maximum Aperture and AF Sensitivity

The EOS-1Ds Mark III can execute high-precision AF with lenses whose maximum aperture is f/2.8 or larger.

With f/2.8 and faster lenses*

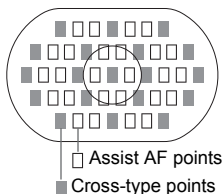

With the 19 AF points indicated by ■, high-precision, cross-type AF (both horizontal- and vertical-line sensitive) is possible. With cross-type AF, vertical-line detection is about 2 times as sensitive as horizontal-line detection. The remaining 26 Assist AF points are horizontal-line sensitive only.

* Excluding the EF24mm f/2.8 and EF28mm f/2.8.

With lenses whose maximum aperture is f/4 or larger

If the maximum aperture of the lens or Extender and lens combination is faster than f/4, the center AF point will work as a high-precision, cross-type point sensitive to both horizontal and vertical lines. The remaining 18 AF points and the 26 Assist AF points work as horizontal-line sensitive AF points.

With lenses whose maximum aperture is f/5.6 or larger

With lenses whose maximum aperture is larger than f/5.6, all the AF points, including the Assist AF points, will be horizontal-line sensitive only.

With lenses whose maximum aperture is f/8 or larger

With lenses whose maximum aperture is larger than f/8, AF will be possible with the center AF point which will be horizontal-line sensitive. AF will not work with the other AF points.



When the EF70-200mm f/2.8L USM is used with an Extender, use the center AF point only. The other AF points may cause a focusing error.



When using the EF24mm f/2.8 or EF28mm f/2.8 lens, the 13 AF points shown on the right can be used as cross-type points. The remaining 6 AF points will be horizontal-line sensitive.

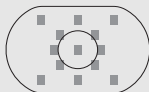

When Autofocus Fails

Autofocus can fail to achieve focus (the focus confirmation light <●> blinks) with certain subjects such as the following:

Subjects difficult to focus

- Low-contrast subjects
Example: Blue sky, solid-color walls, etc.
- Subjects in low light
- Extremely backlit and reflective subjects
Example: Car with a reflective body, etc.
- Overlapping near and far objects
Example: Animal in a cage, etc.
- Repetitive patterns
Example: Skyscraper windows, computer keyboards, etc.

In such cases, do one of the following:

- (1) With One-Shot AF, focus an object at the same distance as the subject and lock the focus before recomposing. (p.83)
- (2) Set the lens focus mode switch to <MF> and focus manually.

Manual Focusing

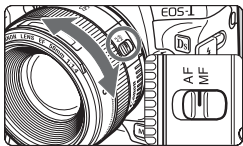

- 1 Set the lens focus mode switch to <MF>.**
- 2 Focus the subject.**
 - Focus by turning the lens focusing ring until the subject looks sharp in the viewfinder.

 If you press the shutter button halfway during manual focusing, the active AF point and the focus confirmation light <●> in the viewfinder will light when focus is achieved.

DRIVE: Selecting the Drive Mode

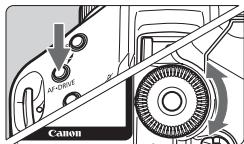

1 Press the <AF•DRIVE> button. (ⓘ6)

2 Select the drive mode.

- While looking at the top LCD panel, turn the <◁> dial.

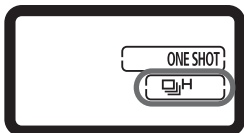

 : **Single shooting**



When you press the shutter button completely, one shot will be taken.

H : **High-speed continuous**

shooting (Max. 5 shots per sec.)

L : **Low-speed continuous**

shooting (Max. 3 shots per sec.)

In the H and L modes, the camera will shoot continuously while you hold down the shutter button completely.

10 : **Self-timer** (10-sec. delay)

2 : **Self-timer** (2-sec. delay)

See the next page for the self-timer operation procedure.

S : **Silent single shooting**

The shooting sound for single shooting is quieter than <□>.





- When the internal buffer memory becomes full during continuous shooting, “buSY” will be displayed on the top LCD panel and in the viewfinder and shooting will be disabled temporarily. As the captured images are recorded to the memory card, you will be able to shoot more images. Press the shutter button halfway to check in the viewfinder’s right for the current maximum burst. This is the maximum number of shots that can be taken continuously.
- If “Card * Full” is displayed in the viewfinder and on the top LCD panel, make sure to wait until the access lamp stops blinking, then replace the memory card.



Maximum burst



If the battery level drops to about 10% (p.29), the drive mode icon (, , ) will blink.

☺ Self-timer Operation

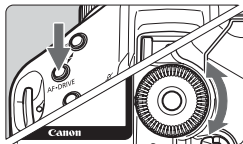

1 Press the <AF•DRIVE> button.
(☺6)

2 Select either <☺¹⁰> or <☺₂>.

- Look at the top LCD panel and turn the <☺> dial to select <☺¹⁰> or <☺₂>.

☺¹⁰ : 10-sec. self-timer

☺₂ : 2-sec. self-timer

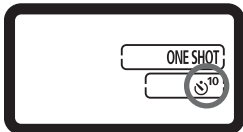

3 Take the picture.

- Focus the subject and press the shutter button completely.
- ▶ The self-timer lamp will blink, and 10 sec. or 2 sec. later, the picture will be taken.
- ▶ During the self-timer operation, the top LCD panel counts down the seconds until the picture is taken.
- ▶ The lamp's blinking will become faster two seconds before the picture is taken.

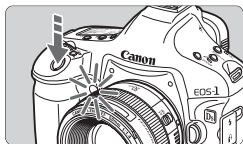

! Do not stand in front of the camera when you press the shutter button to start the self-timer. Doing so prevents the camera from focusing the subject.

- Use a tripod when using the self-timer.
- Before starting the self-timer, look through the viewfinder or cover it with the eyepiece shutter (p.103).
- To cancel the self-timer after it starts, set the power switch to <OFF>.
- When using the self-timer to shoot only yourself, use focus lock (p.83) for an object at about the same distance as where you will be.
- The 2-second self-timer is effective for close-ups or photo duplicating work to prevent camera shake (camera movement while the shutter button is pressed).

4

Exposure Control

Select the shooting mode to suit the subject or shooting objective. You can set the shutter speed and/or aperture to obtain the exposure you want.

Also, with an EX-series Speedlite, you can take flash pictures as easily as normal shooting without flash.



First set the power switch to <J>.

Metering Modes

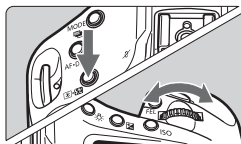

1 Press the   button. ( 6)

2 Select the metering mode.

- While looking at the top LCD panel, turn the  dial.

: **Evaluative metering**

: **Partial metering**

: **Spot metering**

: **Center-weighted average metering**

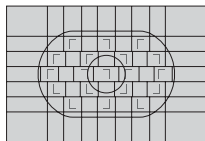
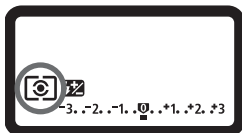

Evaluative metering

This is the camera's standard metering mode suited for most subjects even under backlit conditions. After detecting the subject's position in the viewfinder, the brightness, background, front and back lighting conditions, and other complex lighting elements, the camera sets the proper exposure for the main subject.

Partial metering

Effective when the background is much brighter than the subject due to backlighting, etc. The metering is weighted at the center covering about 8.5% of the viewfinder area.

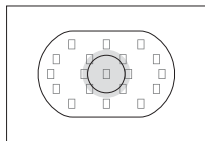

Spot metering

This is for metering a specific part of the subject or scene. The metering is weighted at the center covering about 2.4% of the viewfinder area.

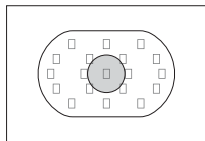

 When C.Fn I -7 [**Spot meter. link to AF point**] is set to [1:Enable (use active AF point)], spot metering can be linked to the 19 (or 9 outer or inner points) AF points. (p.160)

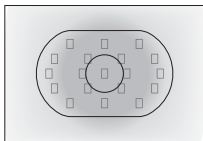

☑ Center-weighted average metering

The metering is weighted at the center and then averaged for the entire scene.

Multi-Spot Metering

With multiple spot meter readings, you can see the relative exposure levels of multiple areas in the picture and set the exposure to obtain the desired result.

1 Set the metering mode to ☑ spot metering.

2 Press the <FEL> button. (Ⓢ16)

- Aim the spot metering circle over the area where you want a relative exposure reading, then press the <FEL> button.
- ▶ On the right of the viewfinder, the relative exposure level will be displayed for the spot meter reading taken. For the exposure, the average of the spot meter readings will be set.

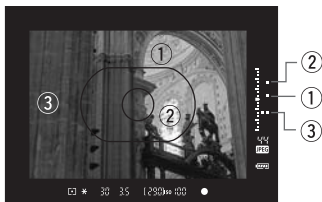

- While referring to the exposure level indicator's three spot metering marks, you can set the exposure compensation to set the final exposure and obtain the desired result.



- You can take up to eight spot meter readings for one picture.
- The exposure setting obtained with multi-spot meter readings will be canceled in the following cases:
 - After taking the last spot meter reading, 16 seconds elapse.
 - You pressed the <MODE>, <AF-DRIVE>, <☑+Z>, <ISO>, <☑>, or <☑> button.
 - After taking the picture, you let go of the shutter button.
- Multi-spot metering is possible even with AF point-linked spot metering (C.Fn I-7-1).

P: Program AE

The camera automatically sets the shutter speed and aperture to suit the subject's brightness. This is called Program AE.

* <P> stands for Program.

* AE stands for Auto Exposure.

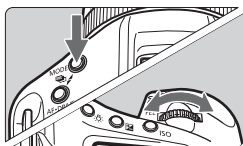

1 Press the <MODE> button. (ⓘ6)

2 Select <P>.

- Turn the <mode dial> to select <P>.



3 Focus the subject.

- Look through the viewfinder and aim the selected AF point over the subject. Then press the shutter button halfway.
- ▶ The AF point which achieves focus flashes in red, and the focus confirmation light <●> in the viewfinder's bottom right lights. (In the One-Shot AF + automatic AF point selection mode)
- ▶ The shutter speed and aperture will be set automatically and displayed in the viewfinder and on the top LCD panel.



4 Check the shutter speed and aperture display.

- A correct exposure will be obtained as long as the shutter speed and aperture display do not blink.

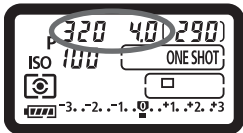

5 Take the picture.

- Compose the shot and press the shutter button completely.



- If “30” shutter speed and the maximum aperture blink, it indicates underexposure. Increase the ISO speed or use flash.



- If the “8000” shutter speed and the minimum aperture blink, it indicates overexposure. Lower the ISO speed or use an ND filter (sold separately) to reduce the amount of light entering the lens.



- If the focus confirmation light <●> blinks, the shutter will lock and a picture cannot be taken. (p.86)
- When automatic AF point selection is used (p.84), multiple AF points may flash simultaneously when focus is achieved.



About Program Shift

- In Program AE mode, you can freely change the shutter speed and aperture combination (Program) set by the camera while maintaining the same exposure. This is called Program Shift.
- To do this, press the shutter button down halfway, then turn the <☀> dial until the desired shutter speed or aperture value is displayed.
- Program Shift is canceled automatically after the picture is taken.
- Program Shift cannot be used with flash.

Tv: Shutter-Priority AE

In this mode, you set the shutter speed and the camera automatically sets the aperture to obtain the correct exposure matching the brightness of the subject. This is called shutter-priority AE.

A faster shutter speed can freeze the action or moving subject. Or a slower shutter speed can create a blurred effect, giving the impression of motion.

* <Tv> stands for Time value.





Fast shutter speed



Slow shutter speed



1 Select <Tv>.

- Press the <MODE> button and turn the <  /  > dial to select <Tv>.

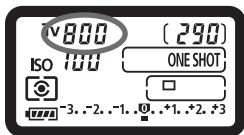

2 Set the desired shutter speed.

- While looking at the top LCD panel, turn the <  > dial.

3 Focus the subject.

- Press the shutter button halfway.
- ▶ The aperture is set automatically.

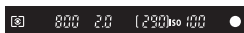

4 Check the viewfinder display and shoot.

- As long as the aperture is not blinking, the exposure will be correct.



- If the maximum aperture blinks, it indicates underexposure.

Turn the <  > dial to set a slower shutter speed until the aperture stops blinking or set a higher ISO speed.



- If the minimum aperture blinks, it indicates overexposure.

Turn the <  > dial to set a faster shutter speed until the aperture stops blinking or set a lower ISO speed.



Shutter Speed Display

The shutter speeds from “8000” to “4” indicate the denominator of the fractional shutter speed. For example, “125” indicates 1/125 sec. Also, “0”5” indicates 0.5 sec. and “15”” is 15 sec.

Av: Aperture-Priority AE

In this mode, you set the desired aperture and the camera sets the shutter speed automatically to obtain the correct exposure suiting the subject brightness. This is called aperture-priority AE.

A higher f/number (smaller aperture hole) will make more of the foreground and background fall within acceptable focus. On the other hand, a lower f/number (larger aperture hole) will make less of the foreground and background fall within acceptable focus.

* <Av> stands for Aperture value (aperture opening).



With a large aperture opening



With a small aperture opening



1 Select <Av>.

- Press the <MODE> button and turn the <gears>/<sun> dial to select <Av>.

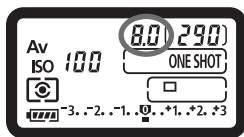

2 Set the desired aperture.

- While looking at the top LCD panel, turn the <gears> dial.

3 Focus the subject.

- Press the shutter button halfway.
- ▶ The shutter speed is set automatically.

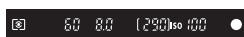

4 Check the viewfinder display and shoot.

- As long as the shutter speed is not blinking, the exposure will be correct.



- If the “30” shutter speed blinks, it indicates underexposure. Turn the dial to set a larger aperture (smaller f/number) until the blinking stops or set a higher ISO speed.



- If the “8000” shutter speed blinks, it indicates overexposure. Turn the dial to set a smaller aperture (larger f/number) until the blinking stops or set a lower ISO speed.



Aperture Display

The larger the f/number, the smaller the aperture opening will be. The aperture values displayed will differ depending on the lens. If no lens is attached to the camera, “00” will be displayed for the aperture value.

Depth-of-Field Preview

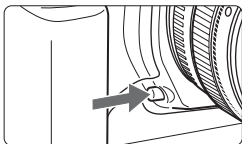

Press the depth-of-field preview button to stop down to the current aperture setting. You can check the depth of field (range of acceptable focus) through the viewfinder.



- A higher f/number will make more of the foreground and background fall within acceptable focus. However, the viewfinder will look darker.
- If the depth of field is difficult to discern, hold down the depth-of-field preview button while turning the dial.
- The exposure will be locked (AE lock) while the depth-of-field preview button is pressed.

M: Manual Exposure

In this mode, you set both the shutter speed and aperture as desired. To determine the exposure, refer to the exposure level indicator in the viewfinder or use a commercially-available handheld exposure meter. This method is called manual exposure.

* <M> stands for Manual.



1 Select <M>.

- Press the <MODE> button and turn the <☀/☀> dial to select <M>.

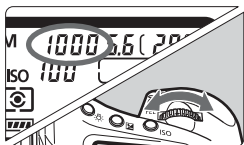

2 Set the desired shutter speed.

- While looking at the top LCD panel, turn the <☀> dial.

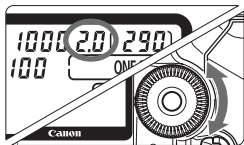

3 Set the desired aperture.

- Make sure the power switch is set to <J>.
- While looking at the top LCD panel, turn the <☀> dial.
- You can also set it with the <☒> button and <☀/☀> dial.



4 Focus the subject.

- Press the shutter button halfway.
 - ▶ The exposure setting will be displayed.
- On the right of the viewfinder, the exposure level indicator <■> indicates the current exposure level relative to the standard exposure index <■>.



5 Set the exposure and take the picture.

- Check the exposure level and set the desired shutter speed and aperture.

Exposure Compensation

Exposure compensation is used to alter the standard exposure set by the camera. You can make the image look brighter (increased exposure) or darker (decreased exposure). You can set the exposure compensation up to ± 3 stops in $1/3$ -stop increments.

1 Check the exposure level indicator.

- Press the shutter button halfway and check the exposure level indicator.

2 Set the exposure compensation amount.

- Make sure the power switch is set to $\langle J \rangle$.
- While looking at the viewfinder or top LCD panel, turn the $\langle \odot \rangle$ dial.
- Turn the $\langle \odot \rangle$ dial while pressing the shutter button halfway or within ($\odot 6$) after pressing the shutter button halfway.
- ▶ When exposure compensation has been set, the $\langle \blacktriangle \rangle$ icon will be displayed in the viewfinder.
- To cancel exposure compensation, set the exposure level indicator $\langle \blacktriangle \rangle$ to the standard exposure index ($\langle \blacktriangleright \rangle$ or $\langle \odot \rangle$).

3 Take the picture.

Increased exposure



Decreased exposure



- The exposure compensation amount will remain in effect even after you set the power switch to $\langle \text{OFF} \rangle$.
- Take care not to turn the $\langle \odot \rangle$ dial and change the exposure compensation inadvertently. To prevent this, set the power switch to $\langle \text{ON} \rangle$.
- You can also set it with the $\langle \text{Ex} \rangle$ button and $\langle \text{Ex} / \odot \rangle$ dial.

Auto Exposure Bracketing (AEB)

By changing the shutter speed or aperture automatically, the camera brackets the exposure up to ± 3 stops in 1/3-stop increments for three successive shots. This is called AEB.

* AEB stands for Auto Exposure Bracketing.



1 Hold down the <MODE> and <AF•DRIVE> buttons simultaneously. (⊙6)

- ▶ The <AEB icon> and “0.0” will appear on the top LCD panel.

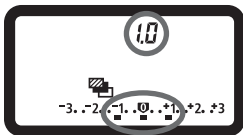

2 Set the AEB amount.

- Turn the <gear/sun> dial to set the AEB amount.
- “1.0” is the AEB increment, and <AEB icon> is the AEB amount.

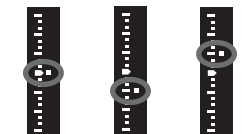

Standard exposure Decreased exposure Increased exposure

3 Take the picture.

- In the current drive mode, the pictures will be taken in this sequence: Standard exposure, decreased exposure, and increased exposure.
- After the three bracketed shots are taken, AEB will not be canceled. To cancel AEB, set the AEB increment to “0.0”.

- During AEB shooting, the <AEB icon> in the viewfinder and the <AEB icon> on the top LCD panel will blink.
- The AEB setting will be canceled automatically if the power switch is set to <OFF> or if the flash is ready.
- When the shooting mode is bulb or you use flash, AEB cannot be used.
- If the drive mode is set to single shooting <S> or <S>, you must press the shutter button three times. When <H> or <L> is set and you hold down the shutter button completely, the three bracketed shots will be taken continuously. Then the camera will stop shooting. When <10> or <2> is set, the three bracketed shots will be taken after a 10-sec. or 2-sec. delay.
- AEB can also be combined with exposure compensation.

* AE Lock

Use AE lock when the area of focus is to be different from the exposure metering area or when you want to take multiple shots at the same exposure setting. Press the < * > button to lock the exposure, then recompose and take the shot. This is called AE lock. It is effective for backlit subjects.

1 Focus the subject.

- Press the shutter button halfway.
- ▶ The exposure setting will be displayed.

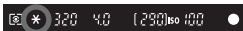

2 Press the < * > button. (ⓘ6)

- ▶ The < * > icon will light in the viewfinder and the exposure setting will be locked (AE lock).
- Each time you press the < * > button, it locks the current exposure setting.



3 Recompose and take the picture.

- The exposure level indicator will show the AE lock exposure level and the current exposure level in real-time.
- If you want to maintain the AE lock while taking more shots, hold down the < * > button and press the shutter button to take another shot.

AE Lock Effects

Metering Mode	AF Point Selection Method	
	Automatic Selection	Manual Selection
Evaluative metering*	AE lock is applied at the AF point that achieved focus.	AE lock is applied at the selected AF point.
Partial metering	AE lock is applied at the center AF point.	
Spot metering		
Center-weighted average metering		

* When the lens' focus mode switch is set to < **MF** >, AE lock is applied at the center AF point.

Bulb Exposures

When bulb is set, the shutter stays open while you hold down the shutter button completely, and closes when you let go of the shutter button. This is called bulb exposure. Use bulb exposures for night scenes, fireworks, the heavens, and other subjects requiring long exposures.



1 Select "buLb".

- Press the <MODE> button and turn the <☀/☾> dial to select "buLb".



2 Set the desired aperture.

- While looking at the top LCD panel, turn the <☀/☾> dial.

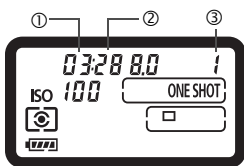

3 Take the picture.

- Press the shutter button completely.
- ▶ The elapsed exposure time will be displayed on the top LCD panel.
1: min. 2: sec. 3: hour

- Since bulb exposures produce more noise than usual, the image might look rough or grainy.
- For bulb exposures, using Remote Switch RS-80N3 or Timer Remote Controller TC-80N3 (both sold separately) is recommended.
- When C.Fn II -1 [**Long exp. noise reduction**] is set to [1:Auto] or [2:On], noise generated by the bulb exposure can be reduced. (p.163)

☀ LCD Panel Illumination

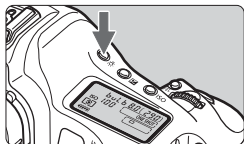

Each time you press the <☀> button, the illumination of the top and rear LCD panels will turn on or off (☀6). During a bulb exposure, pressing the shutter button completely will turn off the LCD panel illumination.

Eyepiece Shutter

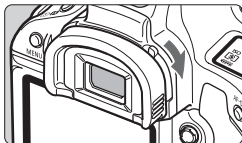

If your eye is not looking at the viewfinder, stray light entering the eyepiece can adversely affect the exposure. To prevent this, slide the eyepiece shutter lever as shown by the arrow to shutter the eyepiece.

Connecting the Remote Switch

You can connect Remote Switch RS-80N3 or Timer Remote Controller TC-80N3 (both sold separately) or any EOS accessory equipped with an N3-type terminal to the camera and shoot with it.

To operate the accessory, refer to its instruction manual.

1 Open the terminal cover.

- Open the upper cover.

2 Connect the plug to the remote control terminal.

- Connect the plug as shown in the illustration.
- To disconnect the plug, grasp the plug's silver part and pull out.

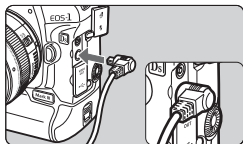

Mirror Lockup

Although using the self-timer or Remote Switch can prevent camera shake, using mirror lockup to prevent camera vibrations can also help when you use a super telephoto lens or shoot close ups.

When C.Fn III -15 [Mirror lockup] is set to [1:Enable] or [2:Enable: Down with SET] (p.172), shooting with mirror lockup is possible.



1 Focus the subject, press the shutter button completely and release it.

- ▶ The mirror will lockup and  will blink on the top LCD panel.

2 Press the shutter button completely again.

- ▶ The picture will be taken.
- With [1] set, the mirror will go back down when the picture is taken.
- With [2] set, the mirror lockup will remain even after the picture is taken. To cancel the mirror lockup, press .

- In very bright light such as at the beach or ski slope on a sunny day, take the picture promptly after mirror lockup.
- During mirror lockup, do not point the camera lens at the sun. The sun's heat can scorch and damage the shutter curtains.
- If you use bulb exposures, the self-timer, and mirror lockup in combination, keep pressing the shutter button completely (self-timer delay time + bulb exposure time). If you let go of the shutter button during the 10-sec./2-sec. self-timer countdown, there will be a shutter-release sound. This is not the actual shutter release (no picture is taken).

- When [1:Enable] is set, single shooting will take effect even if the drive mode is continuous. When [2:Enable: Down with SET] is set, the current drive mode will take effect for the shooting.
- When the self-timer is set to  or , the picture will be taken after 10 sec. or 2 sec. respectively.
- The mirror locks up, and after 30 seconds, it will go back down automatically.
- For mirror lockup shots, using Remote Switch RS-80N3 or Timer Remote Controller TC-80N3 (both sold separately) is recommended.

Flash Photography

Using an EX-series Speedlite

An EX-series Speedlite (sold separately) makes flash photography as easy as normal shooting without flash. You can easily do the flash operations below. For detailed instructions, see the EX-series Speedlite's instruction manual.

● E-TTL II Autoflash

E-TTL II is an autoflash exposure system incorporating improved flash exposure control and lens focusing distance information, making it more precise than the previous E-TTL system (evaluative flash metering with preflash). The camera can execute E-TTL II autoflash with any EX-series Speedlite.

● High-Speed Sync (FP flash)

With high-speed sync, you can set a flash sync speed faster than 1/250 sec.

● FE (Flash Exposure) Lock

Press the camera's <FEL> button to lock the flash exposure at the desired part of the subject.

● Flash Exposure Compensation

In the same way as normal exposure compensation, you can set exposure compensation for flash. You can set the flash exposure compensation up to ± 3 stops in 1/3-stop increments.

With the camera, set it by pressing <Ⓢ•> and turning the <⦿> dial.

● FEB (Flash Exposure Bracketing)

The flash output is changed automatically for three successive shots (only with FEB-compatible Speedlites). Set flash exposure bracketing up to ± 3 stops in 1/3-stop increments. During FEB shooting, the <⚡*> icon will blink in the viewfinder.

● E-TTL II Wireless Autoflash with Multiple Speedlites

As with wired, multiple Speedlites, wireless E-TTL II autoflash with multiple Speedlites (those compatible with wireless flash) provides all the above features. Sophisticated lighting effects can be obtained since connection cables are unnecessary.

MENU Flash Function Settings and Flash Custom Functions

When an EX-series Speedlite (such as the 580EX II) controllable by the camera is attached, you can use the camera's menu screen to set the Speedlite's flash function settings such as the flash mode, FEB, and 1st or 2nd curtain sync, and wireless flash. Flash Custom Functions can also be enabled or disabled.

Turn on the Speedlite before setting its functions.

For details on which Speedlite settings the camera can set, see the EX-series Speedlite's instruction manual.

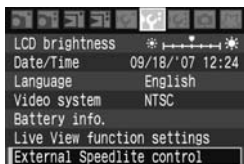

1 Select [External Speedlite control].

- Under the [**IF**] tab, select [External Speedlite control], then press <SET>.

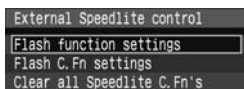

2 Select either [Flash function settings] or [Flash C.Fn settings].

- Turn the <DISP> dial to select the menu item, then press <SET>.

Flash function settings

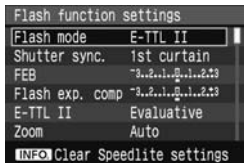

3 Set the flash function settings.

- Select a flash function and set it as desired. The procedure is the same as setting a menu function.
- On the flash function settings screen, the settable items, current settings, flash mode setting, and flash Custom Function settings might look different on your camera.
- To reset the flash settings to the default, press the <INFO.> button while the flash function setting screen is displayed.

Flash C.Fn settings

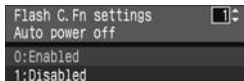



Metered Manual Flash Exposure

This is for close-up flash photography when you want to set the flash level manually. Use an 18% gray card and an EX-series Speedlite which has manual flash mode. Follow the instructions below:

1. Set the camera and Speedlite settings.
 - Set the camera's shooting mode <M> or <Av>.
 - Set the Speedlite to manual flash mode.
2. Focus the subject.
 - Focus manually.
3. Set up the 18% gray card.
 - Place the gray card at the subject's position.
 - In the viewfinder, the entire spot metering circle at the center should cover the gray card.
4. Press the <FEL> button. (☺16)
5. Set the flash exposure level.
 - Adjust the Speedlite's manual flash level and the camera aperture so that the flash exposure level aligns with the standard exposure index.
6. Take the picture.
 - Remove the gray card and take the picture.

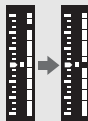

- If flash exposure compensation has already been set with the Speedlite, you cannot use the camera's <☺-1/2> button or Flash function settings menu to set flash exposure compensation. If it is set with both the camera and Speedlite, the Speedlite's setting overrides the camera's.
- If autofocus cannot be achieved, the external, EOS-dedicated Speedlite's AF-assist beam (if the Speedlite has it) will be emitted automatically.
- If focus cannot be achieved with the external Speedlite's AF-assist beam, select the center AF point. With some external Speedlites, autofocus with AF-assist beam works only with the center AF point.
- This camera is a Type-A camera that can use all the features of EX-series Speedlites.
- The flash function's [E-TTL II] setting will work together with C.Fn II -4 (p.164). And [Flash firing] will work with C.Fn II -6 (p.165).
- Only [E-TTL II] and [Flash exp. comp] can be settable for flash function settings with an EX-series Speedlite not controllable by the camera. (For some EX-series Speedlites, [Shutter sync.] can also be settable.)

Using Non-EX-series Canon Speedlites

- With an EZ/E/EG/ML/TL-series Speedlite set in the TTL or A-TTL autoflash mode, the flash can be fired at full output only. Set the camera's shooting mode to manual or aperture-priority AE and shoot.
- When using a Speedlite which has manual flash mode, shoot in the manual flash mode.
- With an EX-series Speedlite set to TTL autoflash with the flash's Custom Function, the flash will fire at full output only.

Using Non-Canon Flash Units

Sync Speed

The camera can synchronize with non-Canon compact flash units at 1/250 sec. and slower speeds. With large studio flash units, since the flash duration is longer, set the sync speed within 1/30 sec. to 1/125 sec. Be sure to test the flash synchronization before shooting.

PC Terminal

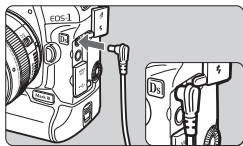

- The camera's PC terminal is provided for flash units having a sync cord. The PC terminal is threaded to prevent inadvertent disconnection.
- The camera's PC terminal has no polarity. You can connect any sync cord regardless of its polarity.



- ⚠ If the camera is used with a flash unit or flash accessory dedicated to another camera brand, the camera may not operate properly and malfunction may result.
- Also, do not connect to the camera's PC terminal any flash unit requiring 250 V or more.
- Do not attach a high-voltage flash unit on the camera's hot shoe. It might not work.

 A flash unit attached to the camera's hot shoe and a flash unit connected to the PC terminal can both be used at the same time.

5

Live View Shooting

You can shoot while viewing a real-time image on the camera's LCD monitor or on a personal computer screen. This is called "Live View shooting."

- Using a hard disk-type card is not recommended. Use a memory card.
- When you use Live View shooting for a long period, the camera's internal temperature may increase and it can degrade image quality. Terminate Live View shooting when not shooting images.
- For a long exposure, stop Live View shooting temporarily and wait several minutes before shooting.
- If the <  > (warning for high temperature in the camera) icon is displayed, terminate Live View shooting.
- With a hard-disk type card in the camera, if Live View shooting continues while the <  > icon is displayed, the Live View might stop automatically. Live View shooting will be disabled until the camera's internal temperature decreases.

Live View Shooting

Instead of looking through the viewfinder, you can look at a real-time image on the camera's LCD monitor while shooting. You can also magnify the real-time image on the LCD monitor by 5x or 10x so you can focus more precisely. Convenient when the camera is mounted on a tripod for shooting still lifes, for example.

Preparing for Live View Shooting

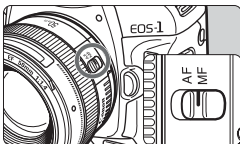

1 Set the lens focus mode switch to <MF>.

- During Live View shooting, **autofocusing is not possible**.

2 Select [Live View function settings].

- Under the [If.] tab, select [Live View function settings], then press <SET>.

3 Select [Live View shoot.].

- Turn the <Q> dial to select [Live View shoot.], then press <SET>.

4 Select [Enable].

- Turn the <Q> dial to select [Enable], then press <SET>.

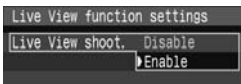
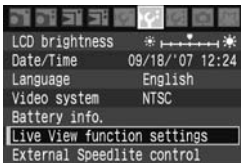

⚠ During Live View shooting, do not point the camera toward the sun. The sun's heat can damage the camera's internal components.

📌 If you handhold the camera like a compact digital camera and shoot while viewing the LCD monitor, camera shake can cause blurred images. For Live View shooting, **mounting the camera on a tripod is recommended**.

About Remote Live View Shooting

With the provided software installed in the personal computer, you can connect the camera to the personal computer and shoot remotely while viewing the computer screen instead of the camera's viewfinder. For details, see the Software Instruction Manual in the CD-ROM.

Displaying Live View Image on the LCD Monitor

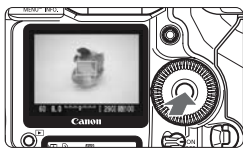

With the camera ready to shoot, press <SET>.

- ▶ The Live View image will appear on the LCD monitor in real-time with 100% field of view.
- With the video cable (provided) connecting the camera to a TV set, you can view images on the TV. (p.122)

ⓘ During Live View image display, if you point the camera in a different direction, it might throw off the correct brightness momentarily and the image might not look right. Wait until the image stabilizes at the correct brightness before shooting. If you shoot while the image brightness is not yet stable, the resulting image might be overexposed or underexposed.

ⓘ If the light source within the image changes, the screen might flicker. If this happens, press <SET> to end the shooting, then with the new light source in place, press <SET> again to resume shooting.

Setting the Shooting Functions

In the same way as during shooting through the viewfinder, you can set the shooting functions (shooting mode, drive mode, memory card selection, image size, ISO speed, Picture Style, white balance, exposure compensation, AEB, AE lock, flash exposure compensation, etc.) while looking at the top/rear LCD panel or LCD monitor.

- ⓘ**
- Only the metering mode cannot be changed. Focusing frame-linked evaluative metering with the image sensor will take effect.
 - Continuous shooting is possible.
 - The metering and AE lock activated with the <★> button will remain active for 16 sec.
 - To set the white balance, memory card selection, or image size, press the <FUNC.> button and set it with the <⊙> or <⚙> dial.
 - The focus preset feature on super telephoto lenses cannot be used.

Magnifying the Image for Manual Focusing



1 Move the focusing frame to the position where you want to focus.

- Use <⊕> to select the focusing frame in full view. If you press <⊕> at the center, the focusing frame will return to the center.

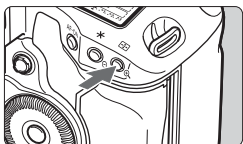

2 Press the <Q> button.

- ▶ The area within the focusing frame will be magnified.
- ▶ The shutter speed and aperture settings will be displayed in orange.
- Each time you press the <Q> button, the display format will change as follows:

→ Full view → Approx. 5x → Approx. 10x →

Magnification: Approx. 10x

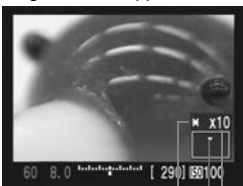

3 Focus manually.

- While looking at the Live View image on the LCD monitor, turn the lens' focusing ring to focus manually.

AE lock
Magnified area
Magnification

- High temperatures, high ISO speeds, or long exposures may cause noise or irregular colors in the captured image shot with Live View shooting.
- During continuous shooting, the exposure set for the first shot will also be applied to subsequent shots. If you recompose during continuous shooting, the exposure might not match the latter shots.
- If the camera is not operated for a prolonged period, the power will turn off automatically as set with [P] Auto power off. (p.47)

- While the image is magnified, pressing the <✳> button will not renew the exposure setting.
- During the 5x or 10x magnified view, the image sharpness may be applied to a higher degree than what was set. This is to make it easier to focus manually.

Taking the Picture

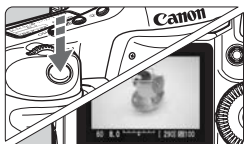
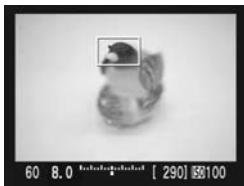

- 1 **Check the composition.**
 - Press the $\langle \text{Q} \rangle$ to check the image composition in full view.
- 2 **Check the display.**
- 3 **Take the picture.**
 - Press the shutter button completely.
 - ▶ The picture will be taken and the captured image is displayed on the LCD monitor.
 - ▶ After the image review ends, the camera will return to Live View shooting automatically.
 - To terminate shooting, press $\langle \text{SET} \rangle$ while Live View image is displayed.



- To check the exposure simulation and depth of field, press the depth-of-field preview button.
- Flash photography is also possible. However, FE lock, modeling flash, and test firing are not possible. The Speedlite's Custom Functions also cannot be set with the Speedlite.
- With the 580EX II, the wireless setting cannot be changed.
- Under low light or bright light conditions, the Live View image might not display the proper brightness. And if you press the depth-of-field preview button, the image might not show the brightness corresponding to the exposure setting ($\langle \text{ExpSim} \rangle$ icon blinks). However, the captured image will reflect the exposure setting.
- If there is a very bright light source in the picture, such as the sun, the bright area might be covered in black on the LCD monitor. However, the actual captured image will correctly show the bright area.
- The time it takes to actually take the picture after you press the shutter button completely is slightly longer than with shooting through the viewfinder.
- When you press the shutter button completely, the shutter will make two shutter-release sounds (with flash, the reflex mirror and shutter operation make multiple sounds). However, only one shot is taken.

About the Information Display

- Each time you press the <INFO.> button, the information display will change.

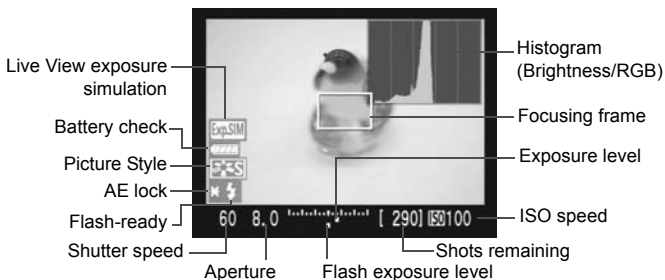

- When the [LIVE VIEW] menu's [Grid display] is set to [On], a grid will appear to make it easier to align the horizontal or vertical shot.
- By setting C.Fn IV -14 [Add aspect ratio information], you can shoot with the same framing as with a medium-format film camera such as 6x6cm, 6x4.5cm, and 4x5 inch. Vertical lines matching the set aspect ratio will be displayed. (p.178)
- When C.Fn IV -16 [Live View exposure simulation] is set to [1:Enable(simulates exposure)], the Live View image will be displayed with the brightness level simulating the exposure setting. This enables you to see how the exposure looks before taking the picture. (p.178)
- The histogram (p.118) will be displayed only when C.Fn IV -16-1 has been set.** If flash is used or bulb is set, the histogram will be grayed out. The histogram might not be properly displayed in low light or bright light conditions.
- When you press the depth-of-field preview button or set C.Fn IV -16-1, the <Exp.SIM> icon will appear to indicate that exposure simulation is in effect.
- During Live View shooting, if the <TEMP> warning icon (temperature increase warning) is displayed, see page 109.

Possible Shots During Live View Shooting

Temperature	At 23°C / 73°F	At 0°C / 32°F
Possible Shots	Approx. 300	Approx. 230

* The figures above are based on a fully-charged LP-E4 battery and CIPA (Camera & Imaging Products Association) testing standards.

6

Image Playback

Learn how to view or erase images, and copy images between the CF card and SD card.

For images taken with another camera:

The camera might not be able to properly display images captured with a different camera or edited with a personal computer or whose file name was changed.

Image Playback

Single image display

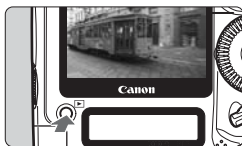

1 Playback the image.

- Press the <▶> button.
- ▶ The last captured image or last image viewed will appear.



2 Select the image.

- To playback images starting with the last image, turn the <◀> dial counterclockwise. To playback images starting with the first captured image, turn the dial clockwise.
- Press the <INFO.> button to change the display format.



Single image display



Single image display + Image size

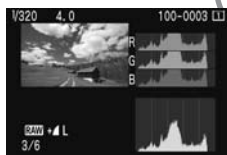

Histogram display



Shooting information display

3 Exit the image playback.

- Press the <▶> button to exit the image playback and return the camera to shooting ready.

Shooting Information Display

Single image display + Image size

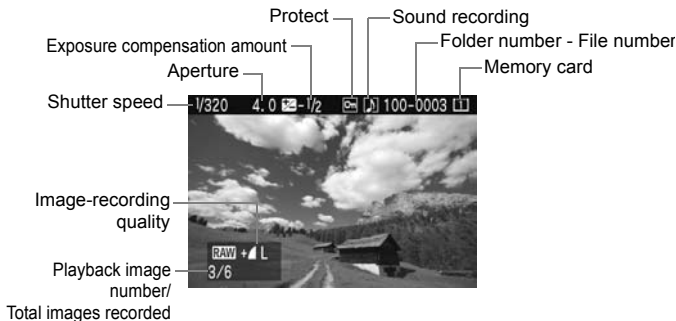

Shooting Information Display

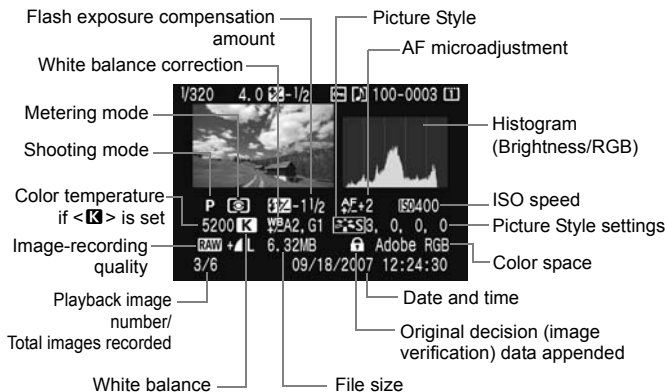

When you shoot in the RAW+JPEG or sRAW+JPEG mode, the JPEG image file size will be displayed.

- **About the Highlight Alert**

When the [ **Highlight alert**] menu is set to [**Enable**], overexposed highlight areas will blink. To obtain more image detail in the overexposed areas, set the exposure compensation to a negative amount and shoot again.

- **About the AF Point Display**

When the [ **AF point disp.**] menu is set to [**Enable**], the AF point which achieved focus will be displayed in red in the shooting information display and histogram display. If automatic AF point selection was used, multiple AF points might be displayed in red.

- **About the Histogram**

The brightness histogram display shows the exposure level distribution, overall brightness, and gradation. And the RGB histogram display is for checking the color saturation and gradation. The display can be switched with the [ **Histogram**] menu.

[Brightness] Display

This histogram is a graph showing the distribution of the image's brightness level. The horizontal axis indicates the brightness level (darker on the left and brighter on the right), while the vertical axis indicates how many pixels exist for each brightness level. The more pixels there are toward the left, the darker the image. And the more pixels there are toward the right, the brighter the image. If there are too many pixels on the left, the shadow detail will be lost. And if there are too many pixels on the right, the highlight detail will be lost. The gradation in-between will be reproduced. By checking the image and its brightness histogram, you can see the exposure level inclination and the overall tone reproduction condition.

Sample Histograms

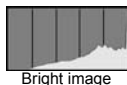
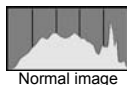

[RGB] Display

This histogram is a graph showing the distribution of the image's brightness level of each primary color (RGB or red, blue, and green). The horizontal axis indicates the color's brightness level (darker on the left and brighter on the right), while the vertical axis indicates how many pixels exist for each color brightness level. The more pixels there are toward the left, the darker and less prominent the color. And the more pixels there are toward the right, the brighter and denser the color. If there are too many pixels on the left, the respective color information will be lacking. And if there are too many pixels on the right, the color will be too saturated with no detail. By checking the image's RGB histogram, you can see the color's saturation and gradation condition and white balance inclination.

Index Display



1 Turn on the index display.

- During image playback, press the <Q> button.
- ▶ The 4-image index display will appear. The currently-selected image will be highlighted in a blue frame.
- Press the <Q> button again to switch to the 9-image index display.



2 Select an image.

- Turn the <◀▶> dial to move the blue frame.
- To display an image, press the <Q> button.

Jump Display

With the single image display, index display, and magnified view, you can turn the <◀▶> dial to jump through the images.

Browsing Through Images

With the [Image jump w/] menu's [1 image/10 images/100 images/Screen/Date/Folder] option, you can set the desired jump method. With the index display, you can jump by a single screen by selecting [1 image]. If you want to jump by date, select [Date]. To jump by folder, select [Folder].



Jump method
Image location

- During image playback, turn the <◀▶> dial.
- ▶ The jump display will proceed according to the selected jump method.
- ▶ On the bottom right, the jump method and current image location are indicated.

🔍/🔍 Magnified View

You can magnify the image by 1.5x to 10x on the LCD monitor.



Magnified area

1 Magnify the image.

- During image playback, press the <🔍> button.
- ▶ The image will be magnified.
- To increase the magnification, hold down the <🔍> button. The image will continue to be magnified until it reaches the maximum magnification.
- To reduce the magnification, press the <🔍> button. If you hold down the button, the image will continue to reduce to the single image display.



2 Scroll around the image.

- Use <🔍> to scroll around the magnified image.
- To exit the magnified display, press the <▶> button and the single image display will return.

Magnified View's Starting Position

Normally, the magnified view starts at the image center. When the [▶] **Enlarge display** menu is set to [**Enlarge from selected AF point**], the magnified view starts at the selected AF point. This is convenient for quickly checking the focus.

- During the magnified view, you can turn the <🔍> or <🔍> dial to view another image at the same magnification and position (the display jumps according to the selected jump method).
- In the case of images shot with automatic AF point selection or with manual focus <MF>, the magnification will start at the image center.
- Magnified view is not possible during the image review immediately after the image is taken.
- With [**Enlarge from selected AF point**]:
 - The starting magnification varies depending on the image size that was set.
 - When C.Fn III -8-1/2 is set, the focusing point area will be expanded so the AF point which actually achieved focus might not fall within the initial magnified view screen.

Rotating an Image

You can rotate the image to the desired orientation.



1 Select [Rotate].

- Under the [] tab, select [Rotate], then press <SET>.



2 Select the image.





- Turn the < > dial to select the image to be rotated.
- You can also select an image on the index display.



3 Rotate the image.

- Each time you press <SET>, the image will rotate clockwise as follows:
90° → 270° → 0°
- To rotate other images, repeat steps 2 and 3.
- To exit the image rotate and return to the menu screen, press the <MENU> button.



- If you have set [**IF** Auto rotate] to [On  ] (p.130) before taking the vertical shots, you need not rotate the image as described above.
- If the rotated image is not displayed in the rotated orientation during image playback, set the [**IF** Auto rotate] menu to [On  ].

Viewing the Images on TV

By connecting the camera to a TV set with the video cable (provided), you can view the captured images on a TV set. Turn off the camera and the television before connecting them.

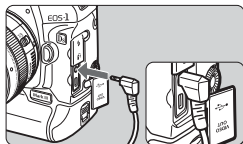

1 Connect the camera to the TV.

- Open the camera's terminal cover.
- Use the video cable (provided) to connect the camera's <VIDEO OUT> video terminal to the TV monitor's VIDEO IN terminal.
- Insert the video cable plugs firmly all the way.

2 Turn on the TV and switch the TV's line input to VIDEO IN.

3 Set the camera's power switch to <ON>.

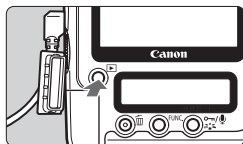

4 Press the <▶> button.

- ▶ The image will appear on the TV screen. (Nothing will be displayed on the camera's LCD monitor.)
- After you finish, set the camera's power switch to <OFF>, turn off the TV, then disconnect the video cable.

- ⚠ If the video system format does not match the TV's, the image will not be displayed properly. Set the proper video system format with [**IF**: Video system].
- Do not use any video cable other than the one provided. Images might not be displayed if you use a different video cable.

⚠ Depending on the TV monitor, part of the image might be cut off.

Protecting Images

Protecting the image prevents it from being erased accidentally.

Protecting a Single Image

1 Playback the image to be protected.

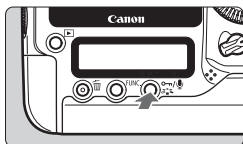

2 Protect the image.

- During image playback, press the **< [Play] / [Lock] >** button.
- ▶ When an image is protected, the **< [Lock] >** icon will appear above the image.
- To cancel the image protection, press the **< [Play] / [Lock] >** button again. The **< [Lock] >** icon will disappear.
- To protect another image, repeat steps 1 and 2.
- To exit the image protection, press the **< [MENU] >** button. The menu will reappear.



MENU Protecting All Images in a Folder or Card

You can protect all the images in the folder or memory card at one time. When the **[Protect images]** menu is set to **[All images in folder]** or **[All images on card]**, all the images in the folder or card will be protected.

To cancel the image protection, select **[Clear all images in folder]** or **[Clear all images on card]**.

- **When you format the memory card, the protected images will also be erased.**
- To protect the image, press and let go of the **< [Play] / [Lock] >** button. Hold down the button for about 2 sec. and the sound recording will start.

- Images can also be protected individually when the [] **Protect images** menu is set to **[Select images]**. Press <SET> to protect or unprotect the image.
- Once an image is protected, it cannot be erased by the camera's erase function. To erase a protected image, you must first cancel the protection.
- If you erase all the images (p.128), only the protected images will remain. This is convenient when you want to erase unnecessary images all at once.

Sound Recording

You can add a sound clip to an image. The sound clip will be saved as a sound file (WAV format) having the same file number as the image. The sound can be played back with the provided software.

1 Playback the image to which you want to add the sound clip.

2 Record the sound.

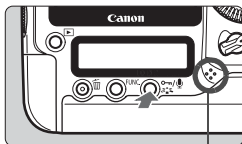

Microphone



- While the image is displayed, press the <MIC/> button for about 2 sec.
- When **[Sound recording]** appears, keep pressing the button and speak into the built-in microphone. The maximum recording time for a sound clip is 30 sec.
- To end the sound clip, let go of the button.
- ▶ The sound will be recorded, and the <[]> icon will appear on the screen.

- The camera cannot playback the sound clip.
- Sound recording is not possible with a protected image.
- To record a sound clip longer than 30 sec., repeat step 2.
- You can also record sound once, right after image capture during the image review by following step 2.



Copying Images

The images in a memory card can be copied to the other memory card.

MENU Copying Individual Images



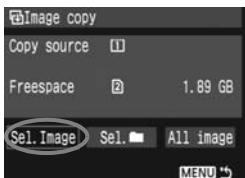

1 Select [Image copy].

- Under the [] tab, select [Image copy], then press < >.



2 Select [Sel. Image].

- Turn the < > dial to select [Sel. Image], then press < >.





Lowest file number

Quantity of images in folder

Folder name

Highest file number

3 Select the folder.

- Turn the < > dial to select the folder containing the image to be copied, then press < >.
- Refer to the images on the right to help you select the folder you want.
- ▶ The images in the selected folder will be displayed.

Total images selected



4 Select the image.

- Turn the $\langle \odot \rangle$ dial to select the image to be copied, then press $\langle \text{SET} \rangle$.
- ▶ The $\langle \checkmark \rangle$ icon will appear on the upper left of the screen.
- Press the $\langle \text{Q} \rangle$ button to display the three-image view. To return to the single-image display, press the $\langle \text{Q} \rangle$ button.
- To select another image to be copied, repeat step 4.

5 Press the $\langle \text{ON/OFF} \rangle$ button.

- After selecting all the images to be copied, press the $\langle \text{ON/OFF} \rangle$ button.

6 Select [OK].

- Check the target memory card and press $\langle \text{SET} \rangle$.

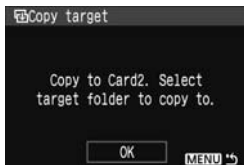

7 Select the target folder.

- Turn the $\langle \odot \rangle$ dial to select the target folder where the images are to be copied to, then press $\langle \text{SET} \rangle$.
- To create a new folder, select [Create folder].



8 Select [OK].

- Check the copy source and copy target's information.
- Turn the $\langle \odot \rangle$ dial to select [OK], then press $\langle \text{SET} \rangle$.

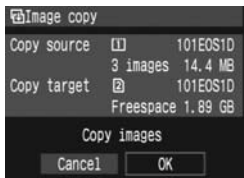

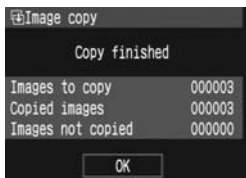

- ▶ The copying will start and the progress will be displayed. When the copying is completed, the result will be displayed. Select **[OK]** to return to the screen in step 2.

MENU Copying All Images in a Folder

In step 2, select **[Sel.]**. Select the source folder to be copied, then the target folder.

MENU Copying All Images in a Memory Card

In step 2, select **[All image]**. All the folders and images in the source memory card will be copied to the target card. (The folder numbers and file names will remain the same in the target folder.)



- The copy source is the memory card selected by the **[Y Record func+media/folder sel.]** menu's **[Record/play]** (**[Playback]**) option.
- The file name of the copied image will be the same as the source image's file name.
- If **[Sel.Image]** has been set, you cannot checkmark <√> images in multiple folders at one time and copy them. Select images in each folder to copy them folder by folder.
- If an image is being copied to a target folder having the same folder number as the source folder and the target folder already has an image with the same file number, the following will be displayed: **[Skip image and continue]** **[Replace existing image]** **[Cancel copy]**. Select the copying method, then press <SET> >.
 - **[Skip image and continue]**: Any images in the target folder having the same file number as the source images will be skipped and not copied.
 - **[Replace existing image]**: Any images in the target folder having the same file number as the source images (including protected images) will be overwritten. If an image with a print order (p.147) or transfer order (p.154) is overwritten, you will have to set the print order or transfer order again.
- The image's print order or transfer order information will not be retained when the image is copied.
- Shooting is not possible during the copying operation. Select **[Cancel]** before trying to shoot.

Erasing Images

You can either select and erase images one by one or erase them in one batch. Protected images (p.123) will not be erased.

-  **Once an image is erased, it cannot be recovered. Make sure you no longer need the image before erasing it. To prevent important images from being erased accidentally, protect them.**

Erasing a Single Image

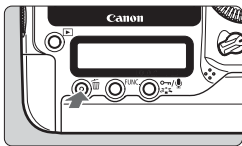

1 Playback the image to be erased.

2 Press the  button.





- The erase menu will appear at the bottom of the screen.



3 Erase the image.

- ▶ Select [Erase], then press . The image displayed will be erased.

MENU Checkmarking Images to be Erased in a Batch

By checkmarking the images to be erased, you can erase multiple images at one time. On the [ Erase images] menu, select [Select and erase images]. With , checkmark  the images to be erased. Then press the  button.

MENU Erasing All Images in a Folder or Card

You can erase all the images in a folder or card at one time. When the [ Erase images] menu is set to [All images in folder] or [All images on card], all the images in the folder or card will be erased.

Changing Image Playback Settings

MENU Setting the LCD Monitor Brightness

You can adjust the brightness of the LCD monitor to make it easier to read.

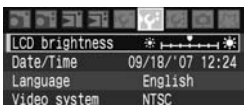

1 Select [LCD brightness].

- Under the [**Y**] tab, select [**LCD brightness**], then press <SET>.



2 Adjust the brightness.

- While referring to the gray chart, turn the <DIAL> dial, then press <SET>.

 To check the image's exposure, you should look at the histogram (p.118).

MENU Setting the Image Review Time

How long the image is displayed on the LCD monitor immediately after capture can be set. To keep the image displayed, set [**Hold**]. To not have the image displayed, set [**Off**].

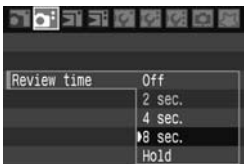

1 Select [Review time].

- Under the [**Q**] tab, select [**Review time**], then press <SET>.

2 Set the desired review time.

- Turn the <DIAL> dial to select the time, then press <SET>.

 If [**Hold**] is set, the image will be displayed until the auto power off time elapses.

MENU Auto Rotate of Vertical Images



Vertical images are rotated automatically so they are displayed vertically on the camera's LCD monitor and personal computer instead of horizontally. The setting of this feature can be changed.



- 1 **Select [Auto rotate].**
 - Under the [IF] tab, select **[Auto rotate]**, then press <SET>.
- 2 **Set the auto rotate display.**
 - Turn the <DISP> dial to select the setting, then press <SET>.

[On

The vertical image is automatically rotated on both the camera's LCD monitor and on the personal computer.

[On

The vertical image is automatically rotated only on the personal computer.

[Off]

The vertical image is not rotated.

 Auto rotate will not work with vertical images captured while Auto rotate was [Off]. They will not rotate even if you later switch it to [On] for playback.

- The vertical image will not be automatically rotated for the image review immediately after image capture.
- If the vertical image is taken while the camera is pointed up or down, the image might not rotate automatically for playback.
- If the vertical image is not automatically rotated on the personal computer screen, it means the software you are using is unable to rotate the image. Using the provided software is recommended.

7

Sensor Cleaning

The camera has a Self Cleaning Sensor Unit attached to the sensor's front layer (low-pass filter) to shake off dust automatically.

The Dust Delete Data can also be appended to the image so that any remaining dust spots can be removed automatically by the Digital Photo Professional (provided software).

About smear adhering to the front of the sensor

Besides dust entering the camera from outside, in rare cases lubricant from the camera's internal parts may adhere to the front of the sensor. In case visible spots still remain after the automatic sensor cleaning, having the sensor cleaned by a Canon Service Center is recommended.

 Even while the Self Cleaning Sensor Unit is operating, you can press the shutter button halfway to interrupt the cleaning and start shooting immediately.

MENU Automatic Sensor Cleaning

Whenever you set the power switch to <ON/ J> or <OFF>, the Self Cleaning Sensor Unit operates (approx. 3.5 sec.) to automatically shake off any dust on the front of the sensor. Normally, you need not be aware of this operation. However, you can execute the sensor cleaning at anytime as well as disable it.

Cleaning the Sensor Now



1 Select [Sensor cleaning].

- Under the [M:] tab, select [Sensor cleaning], then press <SET>.

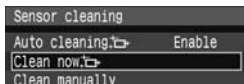

2 Select [Clean now ↗].

- Turn the <◉> dial to select [Clean now ↗], then press <SET>.



3 Select [OK].

- Turn the <◉> dial to select [OK], then press <SET>.
- ▶ During the sensor cleaning, the <↗> icon will be displayed on the LCD monitor. When the cleaning ends, the screen will return to step 2.



- The user-executed cleaning takes about 4 sec. to complete. During the sensor cleaning, the shutter will make 3 shutter-release sounds. The camera is not taking pictures.
- For best results, do the sensor cleaning while the camera bottom is placed on a table or other surface at a perpendicular angle.
- Even if you repeat the sensor cleaning multiple times, the result will not improve that much. Right after the sensor cleaning is finished, the [Cleaning now ↗] option will remain disabled temporarily.

Disabling Automatic Sensor Cleaning

- In step 2, select [Auto cleaning ↗] and set it to [Disable].
- ▶ Whenever you set the power switch to <ON/ J> or <OFF>, the sensor cleaning will not be executed.

MENU Appending Dust Delete Data

Normally, the Self Cleaning Sensor Unit will eliminate most of the dust visible on captured images. However, in case visible dust still remains, you can append the Dust Delete Data to the image to later erase the dust spots. The Dust Delete Data is used by the Digital Photo Professional (provided software) to erase the dust spots automatically.

Preparation

- Get a solid-white object (paper, etc.).
- Set the lens focal length to 50mm or longer.
- Set the lens focus mode switch to **<MF>** and set the focus to infinity (∞). If the lens has no distance scale, look at the front of the lens and turn the focusing ring clockwise all the way.

Obtain the Dust Delete Data

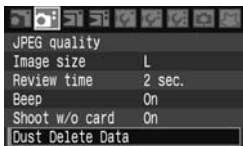

1 Select [Dust Delete Data].

- Under the [D] tab, select [Dust Delete Data], then press **<SET>**.

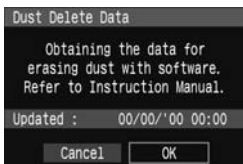

2 Select [OK].

- Turn the **<DIAL>** to select [OK], then press **<SET>**. After the automatic sensor cleaning ends, a message will appear.

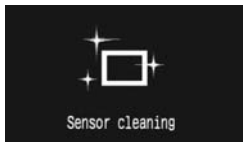
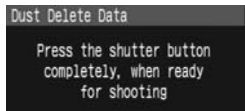

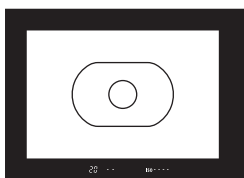

3 Photograph a solid-white object.

- At a distance of 20 - 30 cm / 0.7 - 1.0 feet, fill the viewfinder with a patternless, solid-white object and take a picture.
- ▶ The picture will be taken in the aperture-priority AE mode with an aperture of f/22.
- Since the image will not be saved, the data can still be obtained even if there is no memory card in the camera.
- ▶ When the picture is taken, the data will be obtained. When the data is obtained, a message will appear. Select **[OK]**, and the menu will reappear.
- If the data was not obtained successfully, a message to that effect will appear. Follow the “Preparation” procedure on the preceding page, then select **[OK]**. Take the picture again.

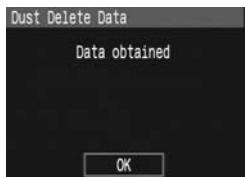

About the Dust Delete Data

After the Dust Delete Data is obtained, it is appended to all the JPEG, RAW, and sRAW images captured thereafter. Before an important shoot, you should update the Dust Delete Data by obtaining it again. For erasing dust spots automatically with the bundled software, see the Software Instruction Manual in the CD-ROM.

The Dust Delete Data appended to the image is so small that it hardly affects the image file size.

! Be sure to use a solid-white object such as a white piece of paper. If the paper has any pattern or design, it may be recognized as dust data and affect the accuracy of the dust deletion with the software.

MENU Manual Sensor Cleaning

Dust which could not be removed by the automatic sensor cleaning can be removed manually with a blower, etc.

The surface of the image sensor is extremely delicate. If the sensor needs to be cleaned directly, having it done by a Canon Service Center is recommended.

Before cleaning the sensor, detach the lens from the camera.

1 Select [Sensor cleaning].

- Under the [M:] tab, select [Sensor cleaning], then press <SET>.

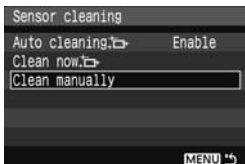

2 Select [Clean manually].

- Turn the <Q> dial to select [Clean manually], then press <SET>.

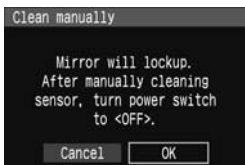

3 Select [OK].

- Turn the <Q> dial to select [OK], then press <SET>.
- ▶ In a moment, the mirror will lockup and the shutter will open.
- "CLn" will blink on the top LCD panel.



4 End the cleaning.

- Set the power switch to <OFF>.



- For the power source, using the AC Adapter Kit ACK-E4 is recommended.
- If you use a battery, make sure it is fully recharged.



- **While cleaning the sensor, never do any of the following. If the power is cut off, the shutter will close and the shutter curtains and image sensor might get damaged.**
 - **Set the power switch to <OFF>.**
 - **Remove/insert the battery.**
- The surface of the image sensor is extremely delicate. Clean the sensor with care.
- Use a plain blower without any brush attached. A brush can scratch the sensor.
- Do not insert the blower tip inside the camera beyond the lens mount. If the power is turned off, the shutter will close and the shutter curtains or reflex mirror might get damaged.
- Never use canned air or gas to clean the sensor. The blowing force can damage the sensor or the spray gas can freeze on the sensor.
- If smear that cannot be removed with a blower remains, having the sensor cleaned by a Canon Service Center is recommended.

8

Direct Printing from the Camera/ Digital Print Order Format

You can connect the camera directly to a printer and print out the images in the memory card. The camera is compatible with “PictBridge” which is the standard for direct printing.

You can also specify any images in the memory card to be printed. (p.147)

About DPOF

DPOF (Digital Print Order Format) is a standard for recording printing instructions (image selections, quantity to print, etc.) in the memory card. In this way, you can print multiple pictures in one batch or give the print order to a photofinisher.

Canon's PictBridge Web Site

The Web site below gives more information on using your Canon camera with various printers, such as which paper types to use.

<http://canon.com/pictbridge/>

Preparing to Print

You do the direct printing procedure entirely with your camera while you look at the LCD monitor.

Connecting the Camera to a Printer

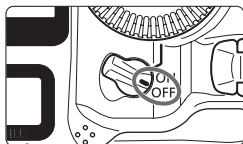

1 Set the camera's power switch to <OFF>.

2 Set up the printer.

- For details, see the printer's instruction manual.

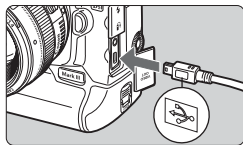

3 Connect the camera to the printer.

- Use the interface cable that came with the camera.
- When connecting the cable plug to the camera's <↔> terminal, the cable plug's <↔> icon must face the front side of the camera.
- To connect to the printer, refer to the printer's instruction manual.

4 Turn on the printer.

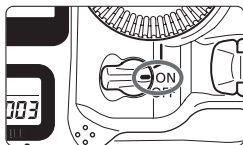

5 Set the camera's power switch to <ON>.

- ▶ Some printers may make a beeping sound.



6 Playback the image.

- Press the <▶> button.
- ▶ The image will appear, and the <📷> icon will appear on the upper left to indicate that the camera is connected to a printer.



- The camera cannot be used with printers compatible only with CP Direct or Bubble Jet Direct.
- When connecting the camera to the printer, do not use any cable other than the interface cable provided.
- If there is a long beeping sound in step 5, it indicates a problem with the PictBridge printer. To find out what's wrong, do the following:
Press the <▶> button to playback the image and follow the steps below.
 1. Press <SET>.
 2. On the print setting screen, select **[Print]**.
 The error message will be displayed on the LCD monitor (p.146).



- If you use a battery to power the camera, make sure it is fully charged. With a fully charged battery, printing up to about 7 hours is possible.
- Before disconnecting the cable, turn off the camera and printer first. Pull out the cable while holding the plug, not the cord.
- For direct printing, using AC Adapter Kit ACK-E4 to power the camera is recommended.

Printing

The screen display and setting options will differ depending on the printer. Some settings might not be available. For details, see the printer's instruction manual.

Printer-connected icon



1 Select the image to be printed.

- Check that the <☞> icon is displayed on the upper left of the LCD monitor.
- Turn the <⊙> dial to select the image to be printed.

2 Press <SET>.

- ▶ The print setting screen will appear.

Print setting screen

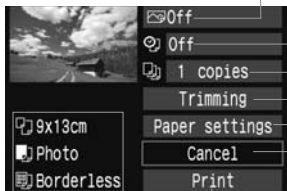

Sets the printing effects.

Sets the date or file number imprinting to on or off.

Sets the quantity to be printed.

Sets the trimming area.

Sets the paper size, type, and layout.

Returns to step 1.

Starts the printing.

The paper size, type, and layout you have set will be displayed.

* Depending on the type of printer, the date and file number imprinting, trimming, and other settings might not be available.

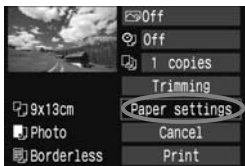

3 Select [Paper settings].

- Turn the <⊙> dial to select [Paper settings], then press <SET>.
- ▶ The paper settings screen will appear.

Setting the Paper Size

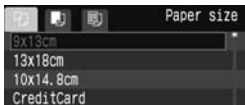

- Turn the <⊙> dial to select the size of the paper loaded in the printer, then press <SET>.
- ▶ The paper type screen will appear.

Setting the Paper Type

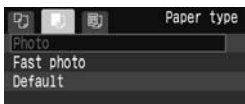





- Turn the <⊙> dial to select the type of the paper loaded in the printer, then press <SET>.
- When using a Canon printer and Canon paper, read the printer's instruction manual to check what paper types can be used.
- ▶ The page layout screen will appear.

Setting the Page Layout



- Turn the <⊙> dial to select the page layout, then press <SET>.
- ▶ The print setting screen will reappear.

Bordered	The print will have a white border along the edges.
Borderless	The print will have no white borders. If your printer cannot print borderless prints, the print will have borders.
Bordered 	The shooting information* will be imprinted on the border on 9x13cm and larger prints.
xx-up	Option to print 2, 4, 8, 9, 16, or 20 images on one sheet.
20-up  35-up 	On A4 / Letter size paper, 20 or 35 thumbnails of the images ordered through DPOF will be printed. <ul style="list-style-type: none"> • [20-up ] will have the shooting information* printed on the side of each thumbnail and the file number and date** printed on the bottom of each thumbnail image. • [35-up ] will have the file number and date** printed on the bottom of the thumbnail images.
Default	The page layout will vary depending on the printer type or its settings.

* From the Exif data, the camera name, lens name, shooting mode, shutter speed, aperture, exposure compensation amount, ISO speed, white balance, etc., will be imprinted.

** This depends on the <⊙> date/file number imprinting option set in step 5 (p.143).



4 Set the printing effects.

- Set as necessary. If you need not set any printing effects, go to step 5.
- Turn the < > dial to select the item on the upper right, then press < >.
- If the < >, the printing effects can also be adjusted. (p.144)
- Next, turn the < > dial to select the desired printing effect, then press < >.

Item	Description
Off	Same as the printing characteristics turned "On". No automatic correction will be performed.
On	The image will be printed according to the printer's standard colors. The image's Exif data is used to make automatic corrections.
Vivid	The image will be printed with higher saturation to produce more vivid blues and greens.
NR	The image noise is reduced before printing.
B/W B/W	Prints in black-and-white with true blacks.
B/W Cool tone	Prints in black-and-white with cool, bluish blacks.
B/W Warm tone	Prints in black-and-white with warm, yellowish blacks.
Natural	Prints the image in the actual colors and contrast. No automatic color adjustments will be applied.
Natural M	The printing characteristics are the same as the "Natural" setting. However, this setting enables finer printing adjustments than with "Natural."
Default	The printing will differ depending on the printer. For details, see the printer's instruction manual.

* The screen display may differ depending on the printer.

* When you change the printing effects, it is reflected in the image displayed on the upper left. Note that the printed image might look slightly different from the displayed image which is only an approximation.



5 Set the date and file number imprinting.

- Set as necessary.
- Turn the <⊙> dial to select <Ⓞ>, then press <SET>.
- Turn the <⊙> dial to select the desired setting, then press <SET>.



6 Set the number of copies.

- Set as necessary.
- Turn the <⊙> dial to select <Ⓞ>, then press <SET>.
- Turn the <⊙> dial to select the number of copies, then press <SET>.



7 Start printing.

- Turn the <⊙> dial to select [**Print**], then press <SET>.
- ▶ The printing will start.



- You can also print RAW and sRAW images taken by the camera.
- With RAW+JPEG images, the RAW image will be printed. And with sRAW+JPEG images, the JPEG image will be printed.
- For details on trimming, see page 145.
- The [**Default**] setting for printing effects and other options are the printer's own default settings as set by the printer's manufacturer. See the printer's instruction manual to find out what the [**Default**] settings are.
- Depending on the image's file size and recording quality, it may take some time for the printing to start after you select [**Print**].
- If image tilt correction (p.145) has been applied, it will take longer to print the image.
- After the [**Do not disconnect cable**] message disappears, you can disconnect the cable even during printing.
- To stop the printing, press <SET> while [**Stop**] is displayed, then select [**OK**].

Adjustment of Printing Effects

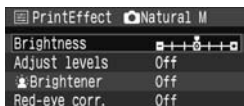
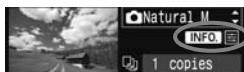

In step 4 on page 142, select the printing effect. When the icon is displayed next to **<INFO.>**, press the **<INFO.>** button. You can then adjust the printing effect. What can be adjusted or what is displayed will depend on the selection made in step 4.

● Brightness

The image brightness can be adjusted.

● Adjust levels

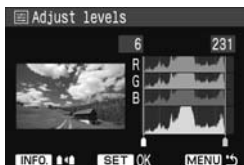

When you select **[Manual]**, you can change the histogram's distribution and adjust the image's brightness and contrast. With the adjust levels screen displayed, press the **<INFO.>** button to change the position of the . Turn the dial to freely adjust the shadow level (0 - 127) or highlight level (128 - 255).

● Brightener

Effective in backlit conditions which can make the subject's face look dark. When **[On]** is set, the face will be brightened for printing.

● Red-eye corr.

Effective in flash images where the subject has red eye. When **[On]** is set, the red eye will be corrected for printing.

- The **[Brightener]** and **[Red-eye corr.]** effects will not show up on the screen.
- When **[Detail set.]** is selected, you can adjust the **[Contrast]**, **[Saturation]**, **[Color tone]**, and **[Color balance]**. To adjust the **[Color balance]**, use . B is for blue, A is amber, M is magenta, and G is green. The color will shift in the respective direction.
- When you select **[Clear all]**, all the printing effect settings will be reverted to the default.

Trimming the Image



You can crop the image and print only the trimmed portion as if the image was recomposed. **Do the trimming right before printing.** If you set the trimming and then set the print settings, you may have to set the trimming again.

1 On the print setting screen, select [Trimming].

2 Set the trimming frame size, position, and proportion.

- The image area within the trimming frame will be printed. The trimming frame's vertical-to-horizontal proportion can be changed with [Paper settings].

Changing the trimming frame size

When you press the $\langle \text{Q} \rangle$ or $\langle \text{Q} \rangle$ button, the size of the trimming frame will change. The smaller the trimming frame, the larger the image magnification will be for the printing.

Moving the trimming frame

Use $\langle \text{D} \rangle$ to move the frame over the image vertically or horizontally. Move the trimming frame until it shows the desired image area or composition.

Rotating the frame

Each time you press the $\langle \text{INFO} \rangle$ button, the trimming frame will toggle between the vertical and horizontal orientations. This enables you to create a vertical-oriented print from a horizontal image.

Image tilt correction

By turning the $\langle \text{DIAL} \rangle$ dial, you can adjust the angle of the image rotation by ± 10 degrees in 0.5-degree increments. When you do image tilt correction, the $\langle \text{Q} \rangle$ icon on the screen will turn blue.

3 Press $\langle \text{SET} \rangle$ to exit the trimming.

- ▶ The print setting screen will reappear.
- You can check the trimmed image area on the upper left of the print setting screen.

- Depending on the printer, the trimmed image area might not be printed as you specified.
- The smaller you make the trimming frame, the grainier the picture will look on the print.
- While trimming the image, look at the camera's LCD monitor. If you look at the image on a TV screen, the trimming frame might not be displayed accurately.



Handling Printer Errors

If you resolve a printer error (no ink, no paper, etc.) and select [**Continue**] to resume printing but it does not resume, operate the buttons on the printer to resume printing. For details, see the printer's instruction manual.

Error Messages

If a problem occurs during printing, an error message will appear on the camera's LCD monitor. Press <  > to stop printing. After resolving the problem, resume printing. For details on how to resolve a printing problem, refer to the printer's instruction manual.

Paper error:

Check whether the paper is properly loaded in the printer.

Ink error:

Check the printer's ink level, and check the waste ink tank.

Hardware error:

Check for any printer problems other than paper and ink problems.

File error:

The selected image cannot be printed via PictBridge. Images taken with a different camera or images edited with a computer might not be printable.

Digital Print Order Format (DPOF)

Set the print type, date imprinting, and file No. imprinting. The print settings will be applied to all print-ordered images. (They cannot be set individually for each image.)

Set the Printing Options



1 Select [Print order].

- ▶ Under the [] tab, select [Print order], then press <SET>.

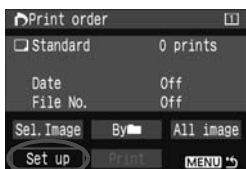

2 Select [Set up].

- Turn the <DIAL> dial to select [Set up], then press <SET>.

3 Set the options as desired.

- Set the [Print type], [Date], and [File No.].
- Turn the <DIAL> dial to select the option, then press <SET>.
- Turn the <DIAL> dial to select the desired setting, then press <SET>.

[Print type]

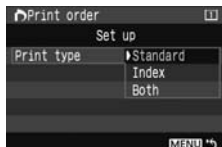



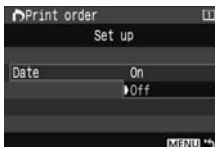

[Date]

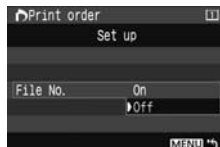

[File No.]



Print type		Standard	Prints one image on one sheet.
		Index	Multiple, thumbnail images are printed on one sheet.
	 	Both	Prints both the standard and index prints.
Date	On	[On] imprints the recorded date on the print.	
	Off		
File No.	On	[On] imprints the file No. on the print.	
	Off		

4 Exit the menu.

- Press the <MENU> button.
- ▶ The Print order screen will reappear.
- Next, select [**Sel.Image**], [**By■**], or [**All image**] to order the images to be printed.

- 
- Even if [**Date**] and [**File No.**] are set to [**On**], the date or file No. might not be imprinted depending on the print type setting and printer model.
 - When printing with DPOF, you must use the memory card whose print order specifications have been set. It will not work if you just extract images from the memory card and try to print them.
 - Certain DPOF-compatible printers and photofinishers might not be able to print the photos as you specified. If this happens with your printer, refer to the printer's instruction manual. Or check with your photofinisher about compatibility when ordering prints.
 - Do not insert into the camera a memory card whose print order was set by a different camera and then try to specify a print order. The print order may not work or may be overwritten. Also, depending on the image type, the print order may not be possible.

- 
- RAW and sRAW images cannot be selected for print orders.
 - With [**Index**] prints, both the [**Date**] and [**File No.**] cannot be set to [**On**] at the same time.

Print Ordering

● Sel.Image

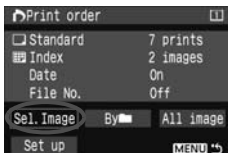

Select and order images one by one. Press the <Q> button to display the three-image view. To return to the single-image display, press the <Q> button. After completing the print order, press the <MENU> button to save the print order to the memory card.



[Standard] [Both]

Press <SET> and a print order for 1 copy of the displayed image will be placed. Then turn the <DIAL> dial to set the number of copies (up to 99) to be printed for that image.

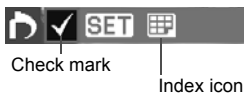

[Index]

Press <SET>, and the displayed image will be included in the index print. The <V> icon will also appear on the upper left.

● By

Select Mark all and select the folder. A print order for 1 copy of all the images in the folder will be placed. If you select Clear all and a folder, the print order for all the images in the folder will be canceled.

● All image

If you select Mark all, a print order for 1 copy of all the images in the memory card will be placed. If you select Clear all, the print order for all the images in the card will be canceled.



- Note that RAW and sRAW images will not be included in the print order even when you set "All image."
- When using a PictBridge printer, print no more than 400 images for one print order. If you specify more than this, all the images might not be printed.

Direct Printing with DPOF

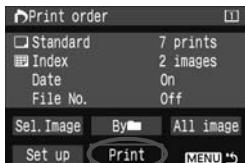

With a PictBridge printer, you can easily print images with DPOF.

1 Preparing to print.

- See page 138.

Follow the “Connecting the Camera to a Printer” procedure up to step 5.

2 Under the [] tab, select [Print order].

3 Select [Print].

- [Print] will be displayed only if the camera is connected to the printer and printing is possible.

4 Set the [Paper settings]. (p.140)

- Set the printing effects (p.142) as necessary.

5 Select [OK].

- Before printing, be sure to set the paper size.
- Certain printers cannot imprint the file No.
- If [Bordered] is set, the date might be imprinted on the border, depending on the printer.
- Depending on the printer, the date might look light if it is imprinted on a bright background or on the border.

- Under [Adjust levels], [Manual] cannot be selected.
- If you stopped the printing and want to resume printing the remaining images, select [Resume]. Note that printing will not resume if you stop the printing and any of the following occurs:
 - Before resuming, you changed the print order or erased any images selected for the print order. For index printing, you changed the paper settings before resuming the printing. Or the memory card's remaining space was small when the printing was stopped.
- If a problem occurs during printing, see page 146.

9

Transferring Images to a Personal Computer

You can use the camera to select images in the memory card and transfer them directly to a personal computer. If the computer software (EOS DIGITAL Solution Disk CD-ROM) provided with the camera has been installed in your personal computer, you can easily transfer the images without operating the personal computer.

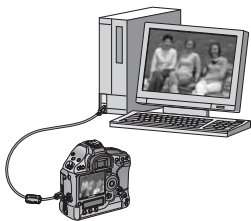

- For instructions to install the provided software, see the separate sheet, CD-ROM Guide.
- If you want to operate the personal computer to transfer the images from the camera, see the Software Instruction Manual in the CD-ROM.

Transferring Images to a Personal Computer ■

-  Before connecting the camera to the personal computer, be sure to first install the EOS DIGITAL Solution Disk software (in the CD-ROM provided with the camera) in the personal computer.

Preparation for Image Transfer

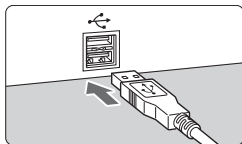
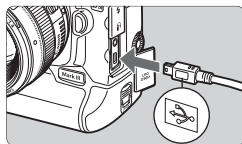

- 1 Connect the camera to the personal computer.**
 - Set the camera's power switch to <OFF>.
 - Use the interface cable that came with the camera.
 - When connecting the cable plug to the camera's <↔> terminal, the cable plug's <↔> icon must face the front side of the camera.
 - To the personal computer's USB port, connect the plug on other end of the cable.
- 2 Set the camera's power switch to <ON>.**

- When the program selection screen appears on the personal computer, select **[EOS Utility]**.
When the camera model selection screen appears, select your camera's model.
- ▶ The **[EOS Utility]** screen will appear on the computer, and the direct transfer screen will appear on the camera's LCD monitor.

-  Shooting will be disabled while the direct transfer screen is displayed.

-  ● If the **[EOS Utility]** screen does not appear, see Software Instruction Manual in the CD-ROM.
- Before disconnecting the cable, turn off the camera first and pull out the cable by grasping the plug (instead of the cord).

Transferring Images to a Personal Computer

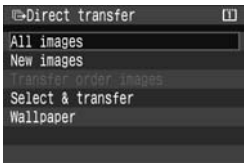

The images transferred to the personal computer will be organized according to the shooting date and saved in the [My Pictures] folder for Windows or the [Pictures] folder in the Macintosh.

- **All images**

All the images in the memory card will be transferred.

- **New images**

Images which have not yet been transferred to the personal computer will be selected by the camera automatically and transferred.

- **Transfer order images**

You select the images and they are transferred to the personal computer in a batch. (p.154)

- **Select & transfer**



You select the images individually to be transferred. Press <SET> and the displayed image will be transferred. To exit, press the <MENU> button.

- **Wallpaper**

Select an image and press <SET>. The displayed image will then be transferred and appear as wallpaper on the computer's desktop screen.

To exit, press the <MENU> button.



- During the image transfer, do not disconnect the interface cable.
- RAW and sRAW images cannot be transferred as wallpaper.

MENU Selecting the Images to be Transferred

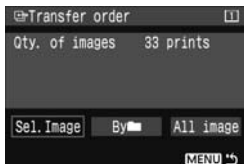

Under the [] tab, you can use [Transfer order] to select the images to be transferred to a personal computer.

When you select [Transfer order images] on the preceding page, you can transfer the images set by the transfer order.

● Sel. Image



Select and order images one by one.

Press <SET> to include the displayed image in the transfer order. The <✓> icon will also appear on the upper left.

After completing the transfer order, press the <MENU> button to save the transfer order to the memory card.

● By

Select Mark all and select the folder. All the images in the folder will then be included in the transfer order. If you select Clear all and a folder, the transfer order for all the images in the folder will be canceled.

● All image

When you select Mark all, all the images in the memory card will be included in the transfer order. If you select Clear all, the transfer order for all the images in the card will be canceled.

⚠ Do not put into the camera any images whose transfer order was set by a different camera and then try to specify another transfer order. The images in the transfer order might all be overwritten. Also, depending on the image type, the transfer order may not be possible.

- For the transfer order, if you select an image captured in the RAW+JPEG or sRAW+JPEG, it will be counted as one image. During the direct image transfer, both the RAW/sRAW and JPEG images will be transferred to the personal computer.
- If you want to transfer more than 999 images in one batch, select [All image] on the direct transfer screen.

10

Customizing the Camera and Saving Camera Settings

To suit your shooting preferences, you can change the camera's functions and also save the camera settings to a memory card. The saved settings can also be registered to the camera.

MENU Setting Custom Functions

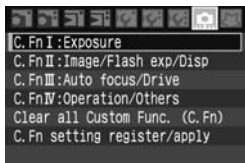

1 Select [Fn].

- Turn the <Fn> dial to select the [Fn] tab.

2 Select the group.

- Turn the <Group> dial to select C.Fn I - IV, then press <SET>.

Custom Function No.

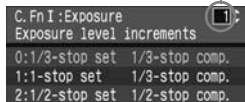

3 Select the Custom Function No.

- Turn the <Custom Function No.> dial to select the Custom Function No., then press <SET>.

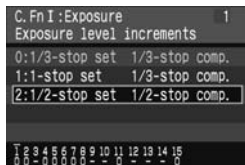

4 Change the setting as desired.

- Turn the <Setting> dial to select the setting (number), then press <SET>.
- Repeat steps 2 to 4 if you want to set other Custom Functions.
- At the bottom of the screen, the current Custom Function settings are indicated below the respective numbers.

5 Exit the setting.

- Press the <MENU> button.
- ▶ The screen for step 2 will reappear.

Clearing All Custom Functions

In step 2, select [Clear all Custom Func. (C.Fn)] to clear all the Custom Function settings.

Even after all the Custom Functions are cleared, the setting for C.Fn IV -11 [Focusing Screen] will remain intact.

Custom Functions

C.Fn I: Exposure

1	Exposure level increments
2	ISO speed setting increments
3	Set ISO speed range
4	Bracketing auto cancel
5	Bracketing sequence
6	Number of bracketed shots
7	Spot metering link to AF point
8	Safety shift
9	Select usable shooting modes
10	Select usable metering modes
11	Exposure mode in manual exposure
12	Set shutter speed range
13	Set aperture value range
14	Apply shooting/metering mode
15	Flash sync. speed in Av mode

C.Fn II: Image/Flash exposure/Display

1	Long exposure noise reduction
2	High ISO speed noise reduction
3	Highlight tone priority
4	E-TTL II flash metering
5	Shutter curtain sync.
6	Flash firing
7	Viewfinder info. during exposure
8	LCD panel illumination during Bulb
9	INFO button when shooting



The Custom Functions whose numbers are shaded do not function during Live View shooting. (Settings are disabled.)

C.Fn III: Auto focus/Drive

1	USM lens electronic MF
2	AI Servo tracking sensitivity
3	AI Servo 1st/2nd image priority
4	AI Servo AF tracking method
5	Lens drive when AF impossible
6	Lens AF stop button function
7	AF Microadjustment
8	AF expansion with selected point
9	Selectable AF point
10	Switch to registered AF point
11	AF point auto selection
12	AF point display during focus
13	AF point brightness
14	AF-assist beam firing
15	Mirror lockup
16	Continuous shooting speed
17	Limit continuous shot count

C.Fn IV: Operation/Others

1	Shutter button/AF-ON button
2	AF-ON/AE lock button switch
3	Quick Control Dial in metering
4	SET button when shooting
5	Tv/Av setting for Manual exposure
6	Dial direction during Tv/Av
7	Av setting without lens
8	WB + media/image size setting
9	button function
10	Button function when <OFF>
11	Focusing Screen
12	Timer length for timer
13	Shortened release time lag
14	Add aspect ratio information
15	Add original decision data
16	Live View exposure simulation

MENU Custom Function Settings

The Custom Functions are organized in four groups based on the function type: C.Fn I: Exposure, C.Fn II: Image/Flash exp (exposure)/Disp (Display), C.Fn III: Auto focus/Drive, C.Fn IV: Operation/Others.

 **Note that the Custom Function numbers differ from previous EOS-1Ds-series cameras.**

C.Fn I: Exposure

C.Fn I -1 Exposure level increments

0: 1/3-stop set 1/3-stop compensation

1: 1-stop set 1/3-stop compensation

Sets full-stop increments for the shutter speed and aperture.

2: 1/2-stop set 1/2-stop compensation

Sets 1/2-stop increments for the shutter speed, aperture, and exposure compensation.

C.Fn I -2 ISO speed setting increments

0: 1/3 stop

1: 1-stop

C.Fn I -3 Set ISO speed range

Disable: The settable ISO speed range will be 100 - 1600.

Enable: The settable ISO speed will range from the highest ISO speed to the lowest ISO speed set with **[Register]**.

Register: The highest ISO speed can be registered within 100 to H (3200), and the lowest ISO speed can be registered within L (50) to 1600. After entering the settings, select **[Apply]**.

 If the highest ISO speed H (3200) and the lowest ISO speed L (50) are registered, it will be the same as "ISO speed expansion."

C.Fn I -4 Bracketing auto cancel**0: On**

The AEB and WB-BKT settings will be canceled when the power switch is set to <OFF> or the camera settings are cleared. AEB will also be canceled when bulb exposure is set or the flash is ready to fire.

1: Off

The AEB and WB-BKT settings will be retained even when the power switch is set to <OFF>. (When the flash is ready, AEB will be canceled. However, the AEB amount will be retained in memory.)

C.Fn I -5 Bracketing sequence

The AEB shooting sequence and white balance bracketing sequence can be changed.

0: 0, -, +

1: -, 0, +

2: +, 0, -

AEB	WB bracketing	
	B/A Direction	M/G Direction
0 : Standard exposure	0 : Standard white balance	0 : Standard white balance
- : Decreased exposure	- : More blue	- : More magenta
+ : Increased exposure	+ : More amber	+ : More green

C.Fn I -6 Number of bracketed shots

The number of shots taken with AEB and white balance bracketing can be changed from the usual 3 shots to 2, 5, or 7 shots. When C.Fn I -5-0 is set, the bracketed shots will be taken as shown in the table below.

0: 3 shots

1: 2 shots

2: 5 shots

3: 7 shots

(1-stop increments)

	1st shot	2nd shot	3rd shot	4th shot	5th shot	6th shot	7th shot
0: 3 shots	Standard (0)	-1	+1				
1: 2 shots	Standard (0)	-1					
2: 5 shots	Standard (0)	-2	-1	+1	+2		
3: 7 shots	Standard (0)	-3	-2	-1	+1	+2	+3

C.Fn I -7 Spot metering link to AF point**0: Disable (use center AF point)****1: Enable (use active AF point)**

Enables spot metering linked to the selected AF point. With automatic AF point selection, spot metering will be at the viewfinder center.

C.Fn I -8 Safety shift**0: Disable****1: Enable (Tv/Av)**

This works in the shutter-priority AE (Tv) and aperture-priority AE (Av) modes. When the subject's brightness changes erratically and the correct autoexposure cannot be obtained, the camera will change the exposure setting automatically to obtain a correct exposure.

2: Enable (ISO speed)

This works in the Program AE, shutter-priority AE, and aperture-priority AE modes. When the subject's brightness changes erratically and the correct autoexposure cannot be obtained, the camera will change the ISO speed within 100 - 1600 automatically to obtain a correct exposure.

 If 2 is set, the maximum burst during continuous shooting (p.54) will decrease. However, depending on the ISO speed during shooting, the actual maximum burst might be higher than indicated in the viewfinder.

-  ● Even if the settable ISO speed range has been changed with C.Fn I - 3,12/13, the safety shift will override it when necessary to obtain the correct exposure.
- With settings 1 and 2, safety shift also works with flash.

C.Fn I -9 Select usable shooting modes**Disable:** All the shooting modes (**M**, **Tv**, **Av**, **P**, **Bulb**) will be selectable.**Enable:** Only the shooting modes set with [**Register**] will be selectable.**Register:** To make a shooting mode unselectable, uncheck the checkmark <✓>. After entering the settings, select [**Apply**].

C.Fn I -10 Select usable metering modes

Disable: All the metering modes (☉: Evaluative, ☒: Partial, ☐: Spot, ☐: Center-weighted average) will be selectable.

Enable: Only the metering modes set with [Register] will be selectable.

Register: To make a metering mode unselectable, uncheck the checkmark <✓>. After entering the settings, select [Apply].

C.Fn I -11 Exposure mode in manual exposure

You can set the metering mode to be used in the manual exposure mode.

0: Specified metering mode

1: Evaluative metering

2: Partial metering

3: Spot metering

4: Center-weighted average



With settings 1 to 4, you cannot change the metering mode by pressing the <☉☒> button during shooting.

C.Fn I -12 Set shutter speed range

Disable: The settable shutter speed range will be 1/8000 sec. to 30 sec.

Enable: The settable shutter speed will range from the highest shutter speed to the lowest shutter speed set with [Register].

Register: The highest shutter speed can be registered within 1/8000 sec. to 1/250 sec., and the lowest shutter speed can be registered within 30 sec. to 1/60 sec. After entering the settings, select [Apply].

C.Fn I -13 Set aperture value range

Disable: The settable aperture will range from the camera-attached lens' maximum aperture to minimum aperture.

Enable: The settable aperture will range from the smallest to largest aperture set with [Register].

Register: The smallest aperture can be registered within f/1.4 to f/91, and the largest aperture can be registered within f/1.0 to f/64. After entering the settings, select [Apply].

C.Fn I -14 Apply shooting/metering mode

While holding down the <✳> (AE lock) button, you can switch to the registered setting (shooting mode, metering mode, shutter speed, aperture, or exposure compensation).

Disable: Pressing the <✳> button will lock the exposure (AE lock).

Enable: By holding down the <✳> button, you can instantly switch to the registered setting.

Register: Set the desired setting for the AE lock button: shooting mode, metering mode, shutter speed, aperture, or exposure compensation.

When you select [**Register**], [**With AE lock button (AF on/AF off)**] will be displayed where you can set the AE lock button to also execute AF or not. Select [**AF on/AF off**] to register the setting to the camera.

C.Fn I -15 Flash sync. speed in Av mode

0: Auto

1: 1/250 sec. (fixed)

Sets the flash sync speed to 1/250 sec. in the aperture-priority AE (Av) mode. (Against dark backgrounds such as the night sky, the subject's background will look dark.)

C.Fn II: Image/Flash exposure/Display

C.Fn II -1 Long exposure noise reduction

0: Off

1: Auto

For 1 sec. or longer exposures, noise reduction is performed automatically if noise typical of long exposures is detected. This [**Auto**] setting is effective in most cases.

2: On

Noise reduction is performed for all exposures 1 sec. or longer. The [**On**] setting may be effective for noise that cannot be detected or reduced with the [**Auto**] setting.



With setting 2, if a long exposure is made during Live View shooting, the LCD monitor will not display anything (no Live View image display) while noise reduction is applied after the picture is taken. During the noise reduction process, shooting is possible. However, you will not be able to see anything on the LCD monitor and in the viewfinder. Since you cannot check the focus and picture composition, shooting is not recommended during the noise reduction process.



With setting 1 and 2, after the picture is taken, the noise reduction process may take the same amount of time as the exposure. During the noise reduction, shooting is still possible as long as the maximum burst indicator in the viewfinder shows "1" or higher.

C.Fn II -2 High ISO speed noise reduction

0: Off

1: On

Reduces the noise generated in the image. Although noise reduction is applied at all ISO speeds, it is particularly effective at high ISO speeds. At low ISO speeds, the noise in the shadow areas is further reduced.



With setting 1, the maximum burst for continuous shooting will greatly decrease.

C.Fn II -3 Highlight tone priority

0: Disable

1: Enable

Improves the highlight detail. The dynamic range is expanded from the standard 18% gray to bright highlights. The gradation between the grays and highlights becomes smoother.

 With setting 1, noise in the shadow areas may be slightly more than usual.

 With setting 1, the settable ISO speed range will be 200 - 1600. Also, the ISO speed displayed on the top LCD panel and in the viewfinder, will have the "0" displayed as a smaller character such as "200". When the image's shooting info (p.117) is displayed, the ISO speed's "0" will also be displayed as a smaller character.

C.Fn II -4 E-TTL II flash metering

0: Evaluative flash metering

Fully automatic flash photography for all conditions, from low light to daylight fill-flash.

1: Average flash metering

The flash is averaged for the entire area covered by the flash. Since automatic flash exposure compensation will not be executed, you may have to set it yourself depending on the scene. This also applies if you use FE lock.

C.Fn II -5 Shutter curtain sync.

0: 1st-curtain synchronization

1: 2nd-curtain synchronization

The flash fires right before the shutter closes. When a slow shutter speed is set, you can capture a light trail following the subject.

This Custom Function can be used to obtain 2nd-curtain sync effects even with EX-series Speedlites which do not have this feature. If the EX-series Speedlite has this feature, it will override this Custom Function's setting.

 With setting 1, a preflash will be fired for flash metering control right after you press the shutter button completely. Remember that the main flash will then fire right before the shutter closes.

C.Fn II -6 Flash firing

Enables or disables the firing of an external flash or non-Canon flash connected to the PC terminal.

0: Enable

1: Disable

Convenient when you want to use the external flash's AF-assist beam only. Note that whether or not the AF-assist beam is emitted is dependent on the C.Fn III -14 setting.

C.Fn II -7 Viewfinder info. during exposure

0: Disable

1: Enable

The viewfinder information will be displayed even during an exposure. Displays the exposure setting, number of remaining shots, etc., during continuous shooting.

C.Fn II -8 LCD panel illumination during Bulb

0: Off

1: On during Bulb

If the LCD panel's illumination is on (p.102) and you take a bulb exposure, the illumination will continue until the bulb exposure ends. This is convenient when you are taking a bulb exposure in low light and want to check the exposure time.

C.Fn II -9 INFO button when shooting

What is displayed on the LCD monitor when you press the <INFO.> button when the camera is ready to shoot can be changed.

0: Displays camera settings

Displays the camera settings. (p.186)

1: Displays shooting functions

Displays shooting functions as found on the top LCD panel and in the viewfinder. When the display is on, you can still press the <INFO.> button and select the AF point on the LCD monitor.

This is convenient when it is difficult to set the camera settings while viewing the top LCD panel, when you are shooting straight up, or when the camera position or point of focus is fixed and you only want to change the camera settings during shooting.



C.Fn III: Auto focus/Drive

C.Fn III -1 USM lens electronic MF

USM lens electronic MF can be enabled or disabled for when you use any of the following lenses.

EF50mm f/1.0L USM, EF85mm f/1.2L USM, EF85mm f/1.2L II USM, EF200mm f/1.8L USM, EF300mm f/2.8L USM, EF400mm f/2.8L USM, EF400mm f/2.8L II USM, EF500mm f/4.5L USM, EF600mm f/4L USM, EF1200mm f/5.6L USM, or EF28-80mm f/2.8-4L USM

0: Enable after One-Shot AF

After focus is achieved in One-Shot AF, electronic MF is enabled. If C.Fn IV -1-2, 3 is set, it is also enabled before focus is achieved.

1: Disable after One-Shot AF

After focus is achieved in One-Shot AF, electronic MF is disabled. If C.Fn IV -1-2, 3 is set, it is possible before focus is achieved.

2: Disable in AF mode

Electronic MF is disabled in the AF mode.

C.Fn III -2 AI Servo tracking sensitivity

During focusing in the AI Servo AF mode, the AF sensitivity for tracking subjects (or obstacles) moving into AF points can be set to one of five levels.

If it is set toward **[Slow]**, interruptions by any obstacles will be less disruptive. It makes it easier to keep tracking the target subject.

If it is set toward **[Fast]**, it will be easier to focus any subjects which suddenly enter the picture from the side. Convenient when you want to successively photograph multiple subjects located at random distances.

C.Fn III -3 AI Servo 1st/2nd image priority

For the AI Servo AF and continuous shooting modes, you can change the Servo's operation characteristics and shutter-release timing.

0: AF priority/Tracking priority

For the first shot, focusing the subject is given priority. For the 2nd and following shots during continuous shooting, focus-tracking of the subject is given priority.

1: AF priority/Drive speed priority

For the first shot, focusing the subject is given priority. During continuous shooting, the continuous shooting speed is given priority over the focus-tracking of the subject.

2: Release/Drive speed priority

For the first shot, shutter release is given priority over focusing the subject. During continuous shooting, the continuous shooting speed is given priority more than with setting 1.

C.Fn III -4 AI Servo AF tracking method

In the AI Servo AF mode while you are focus-tracking a subject, the camera can either continue focusing the target subject even if a closer subject (closer than at the main focus point) suddenly appears in the picture, or the camera can switch to focus the closer subject.

*Main focus point = With automatic AF point selection: Center AF point
 With manual AF point selection + AF point expansion
 (C.Fn III -8-1/2): Manually-selected AF point

0: Main focus point priority

The active AF point will switch to the main AF point and start focusing the closer subject. Convenient when you always want to focus the closest subject.

1: Continuous AF track priority

Any closer subject appearing in the picture will be ignored as an obstruction. The main focus point does not take priority, so the tracking of the target subject can continue and switch to an adjacent AF point based on the preceding focusing result. Convenient when obstacles such as telephone poles go in front of the target subject.

C.Fn III -5 Lens drive when AF impossible

If autofocus is executed, but focus cannot be achieved, the camera can either keep trying to focus or stop.

0: Focus search on**1: Focus search off**

Prevents the camera from becoming grossly out of focus as it attempts to focus again. Especially convenient with super telephoto lenses which can become extremely out of focus.

C.Fn III -6 Lens AF stop button function**0: AF stop****1: AF start**

AF operates only while the button is pressed. While the button is pressed, AF operation with the camera is disabled.

2: AE lock

When the button is pressed, AE lock is applied. Convenient when you want to focus and meter at different parts of the picture.

3: AF point: M → Auto/Auto → ctr

In the manual AF point selection mode, the button instantly switches to automatic AF point selection (among 45 AF points) while you hold it down. Convenient when you are no longer able to focus track a moving subject with a manually-selected AF point in the AI Servo AF mode. You can instantly switch from manual to automatic AF point selection mode. In the automatic AF point selection mode, the button selects the center AF point only while you hold it down.

4: ONE SHOT ↔ AI SERVO

In the One-Shot AF mode, the camera switches to AI Servo AF mode only while you hold down the button. And in the AI Servo AF mode, the camera switches to One-Shot AF mode only while you hold down the button.

Convenient when you need to keep switching between One-Shot AF and AI Servo AF for a subject which keeps moving and stopping.

5: IS start

With the lens' IS switch already <ON>, the Image Stabilizer operates when you press the button.

6: Switch to registered AF point

While holding down the AF Stop button, press the <FEL> button to switch to the registered AF point. Press it again to switch to the previous AF point.



- The AF stop button is provided only on super telephoto IS lenses.
- With setting 5, the Image Stabilizer will not operate when you press the shutter button halfway.
- To register the AF point, see page 171.

C.Fn III -7 AF Microadjustment

- Normally, this adjustment is not required. Do this adjustment only if necessary. Note that doing this adjustment may prevent correct focusing from being achieved.**

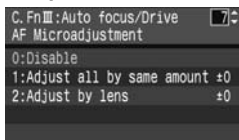

You can make fine adjustments of the AF's point of focus. It can be adjusted in ± 20 steps (-: Forward / +: Backward).

The adjustment amount of one step varies depending on the maximum aperture of the lens. **Adjust, shoot, and check the focus.**

Repeat to adjust the AF's point of focus.

With setting 1 or 2 selected, press the <INFO.> button to view the register screen. To cancel all the registered adjustments, press the <[]> button.

0: Disable

1: Adjust all by same amount

The same adjustment amount is applied to all lenses.

2: Adjust by lens

An adjustment can be set individually for any particular lens. Adjustments for up to 20 lenses can be registered in the camera. When a lens whose focus adjustment has been registered is attached to the camera, its point of focus will be shifted accordingly. If adjustments for 20 lenses have already been registered and you want to register an adjustment for another lens, select a lens whose adjustment can be overwritten or deleted.

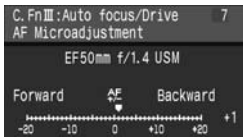
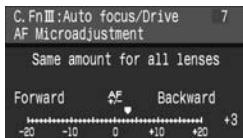

- When you adjust, shoot, and check the focus to make the adjustment, set the image size to JPEG Large and the JPEG quality (compression) to 8 or higher.
- It is best to make the adjustment at the actual place to be photographed. This will make the adjustment more precise.
- With setting 2, if an extender is used, the adjustment will be registered for the lens and extender combination.
- With settings 1 and 2, you can check the adjustment amount on the camera settings screen (p.186). Also, when you display the image's shooting information (p.117), you can see the adjustment amount.
- The registered AF microadjustments will be retained even if you use the Custom Function to clear all settings (p.156). However, the setting itself will be [0: Disable].

C.Fn III -8 AF expansion with selected point

In the AI Servo AF or One-Shot AF mode with manual AF point selection, you can increase the number of AF points by using the Assist AF points. Effective when it is difficult to track a moving subject with just one AF point.

0: Disable

1: Enable (left/right Assist AF points)

The points on the immediate left and right (or top and bottom for a vertical shot) of the user-selected AF point become active.

2: Enable (surrounding Assist AF points)

The points immediately surrounding the user-selected AF point become active.



- The AF point expansion centers on the selected AF point. Therefore, if a peripheral AF point is selected, the AF point expansion will be smaller as shown below.

Assist AF point expanded by 1 point on left and right



Assist AF point expanded by 1 point all around



■ Selected AF point □ Expansion points

- Even when C.Fn III -9-1/2 is set, the expansion will take effect.

C.Fn III -9 Selectable AF point

0: 19 points

1: Inner 9 points

The user-selectable AF points will be limited to the inner 9 points.

2: Outer 9 points

The user-selectable AF points will be limited to the outer 9 points.



With settings 1 and 2, the selectable AF points and the selection pattern will be as shown below:

Inner 9 points

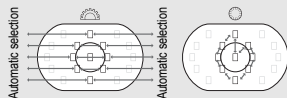

Outer 9 points

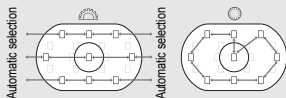

C.Fn III -10 Switch to registered AF point

You can instantly switch to the registered AF point with  while the metering timer is active. (AF is activated at the moment when AF point is switched.)

0: Disable



1: Enable

By pressing , you can switch to the registered AF point. Press it again to switch to the previous AF point.



Registering the AF point (Multiple AF points cannot be registered.)



You can register an AF point you use frequently.

1. Select the AF point to be registered. (p.84)
2. While holding down the  button, press the  button.

-  **HP** : Automatic selection, **SEL []** : Center AF point,
SEL HP : Off-center AF point

If you change the C.Fn III -9 setting, the registered AF point will be canceled. The camera will switch to the center AF point.

C.Fn III -11 AF point auto selection

For AF point selection, you can enable or disable automatic selection. The setting before the slash (/) applies to the  dial's function with C.Fn IV -3-1 set. And the setting after the slash applies to the  dial's function when the  button is pressed.



0:  **direct:disable** /  **:enable**

When metering is active, the  dial cannot select automatic selection. You can select automatic selection with .

1:  **direct:disable** /  **:disable**

Automatic selection cannot be selected.

2:  **direct:enable** /  **:enable**

When metering is active, the  dial can select automatic selection. You can select automatic selection with .

C.Fn III -12 AF point display during focus

0: On

1: Off

The AF point will not light in red other than during AF point selection.

2: On (when focus achieved)

The manually selected AF point will not dimly light during autofocusing. (The AF point will light only when AF is started or focus is achieved.)

C.Fn III -13 AF point brightness

0: Normal

1: Brighter

C.Fn III -14 AF-assist beam firing

Enables or disables the EOS-dedicated Speedlite's AF-assist beam.

0: Enable

The external Speedlite will emit the AF-assist beam when necessary.

1: Disable

 The external Speedlite's Custom Function [**AF-assist beam firing**] set to [**Disable**] will override this Custom Function's 0 setting.

C.Fn III -15 Mirror lockup

See page 104 for the mirror lockup procedure.

0: Disable

1: Enable

2: Enable: Down with SET (button)

 With setting 1 and 2, the icon will appear on the top LCD panel.

C.Fn III -16 Continuous shooting speed

Disable: Continuous shooting will be enabled: : Approx. 5 fps,
: Approx. 3 fps

Enable: The continuous shooting speed set with [**Register**] will be enabled.

Register: can be set within 2 fps to 5 fps, and can be set within 1 fps to 4 fps. After entering the settings, select [**Apply**].

C.Fn III -17 Limit continuous shot count

Disable: No limit is set on the continuous shot count. (Continuous shooting will be possible up to the maximum burst indicated.)

Enable: The continuous shooting will be limited to the number set with [**Register**] after which the shooting will stop automatically.

Register: The continuous shot count can be limited to 2 to 99. After entering the settings, select [**Apply**].

C.Fn IV: Operation/Others

C.Fn IV -1 Shutter button/AF-ON button

0: Metering + AF start

1: Metering + AF start/AF stop

During autofocusing, you can press the <AF-ON> button to stop the autofocusing.

2: Metering start/Meter + AF start

This is useful for subjects which keep moving and stopping repeatedly. In the AI Servo AF mode, you can press the <AF-ON> button to repeatedly start or stop the AI Servo AF operation. The exposure is set at the moment the picture is taken. Thus, the optimum focusing and exposure will always be achieved as you wait for the decisive moment.

3: AE lock/Metering + AF start

Convenient when you want to focus and meter at different parts of the picture. Press the <AF-ON> button to meter and autofocus, and press the shutter button halfway to attain AE lock.

4: Metering + AF start / disable

The <AF-ON> button will not function.

C.Fn IV -2 AF-ON/AE lock button switch

0: Disable

1: Enable

The functions of the <AF-ON> and <*/Q> buttons will be switched with each other's function.

C.Fn IV -3 Quick Control Dial in metering

The Quick Control Dial's function while the metering is active can be changed.

0: Exposure compensation/Aperture

1: AF point selection

You can select the AF point directly with the <Q> dial without first pressing the <AF-ON> button. While metering is active, turning the <Q> dial will select a horizontal AF point. Automatic selection cannot be selected. However, if C.Fn III -11-2 has also been set, automatic selection can be selected. Press the <Q> button and turn the <Q> dial to set the aperture for exposure compensation or manual exposure.

2: ISO speed

While metering is active, you can turn the <Q> dial to change the ISO speed in real-time.

C.Fn IV -4 SET button when shooting

You can assign a frequently-used function to <SET>. When the camera is ready to shoot, you can press <SET>.

0: Normal (disabled)

1: White balance

While looking at the rear LCD panel, you can change the WB.

2: Image size

While looking at the rear LCD panel, you can change the memory card and image size.

3: ISO speed

While looking at the top LCD panel or in the viewfinder, you can change the ISO speed.

4: Picture Style

The [ Picture Style] menu will appear.

5: Record func. + media/folder

The [ Record func+media/folder sel.] menu will appear.

6: Menu display

Gives the same function as the <MENU> button.

7: Image playback

Gives the same function as the <> button.



 If the [Live View shoot.] menu has been set to [Enable], the Live View shooting will override any setting from 1 to 7 above. Pressing <SET> will show the Live View image instead.

C.Fn IV -5 Tv/Av setting for Manual exposure

0: Tv=/Av=



1: Tv=/Av=

Convenient when you use studio flash and frequently change the aperture.

Also, when you use AEB in the manual exposure mode, the shutter speed can stay fixed while only the aperture is shifted for AEB. The shutter speed can also be set by pressing the <> button and turning the </Aperture icon" data-bbox="200 845 235 865"/>> dial.

C.Fn IV -6 Dial direction during Tv/Av**0: Normal****1: Reverse direction**

The dial's turning direction for setting the shutter speed and aperture can be reversed.

In the manual exposure mode, the direction of the  and  dials will be reversed. In other shooting modes, the  dial will be reversed.

The direction of the  dial will be the same in the manual exposure mode and for setting exposure compensation.

C.Fn IV -7 Av setting without lens**0: Disable****1: Enable**

You can set the aperture setting with the camera even when a lens is not attached. Convenient especially if you use a super telephoto lens with more than one EOS-1Ds Mark III camera body.

C.Fn IV -8 WB + media/image size setting

When you press the <FUNC.> button to set the white balance, memory card, or image size, you can choose to do it with the rear LCD panel or with the menu screen.

0: Rear LCD panel**1: LCD monitor**

When you press the <FUNC.> button, the menu screen will appear. Each time you press the button, the screen will change for the White balance, Image size, and Record func+media/folder sel.





Even with setting 1, if you press the <FUNC.> button during Live View shooting, you can set the settings above while looking at the rear LCD panel.

C.Fn IV -9  button function**0: Protect (holding:sound rec.)**

Press the  button for 2 sec. and the sound recording will start.



1: Sound rec. (protect:disable)





To start the sound recording, press the  button. To protect an image, use the [ Protect images] menu.

C.Fn IV -10 Button function when  <OFF>

0: Normal (enable)

1: Disable , , Multi-controller

When the power switch is set to <ON>, the < >, < >, and < > will be disabled from setting anything. The shutter button can still be used to shoot. This prevents any settings to be changed inadvertently, so it is convenient when you keep shooting with the same settings.

 Even with setting 1, if the power switch is set to <J>, you can use < >, < >, and < > to change settings.

C.Fn IV -11 Focusing Screen

If you change the focusing screen, change this setting to match the focusing screen type. This is to obtain the correct exposures.

0:  Ec-C IV

Standard focusing screen (Laser-matte).

1:  Ec-A, B, C, C II, C III, D, H, I, L



For Laser-matte screens.

2:  Ec-S

For Super Precision Matte screens.

3:  Ec-N,R

For New Laser-matte screens.

 The  Ec-S focusing screen is optimized for lenses whose maximum aperture is f/1.8 to f/2.8. If the lens maximum aperture is brighter than f/1.8, the center spot metering circle and Area AF ellipse might become difficult to see. Also, if the lens maximum aperture is slower than f/2.8, the viewfinder will look darker.

- 
- Even if all the Custom Functions are cleared, this setting will be retained.
 - Since the Ec-A, Ec-B, Ec-I, and Ec-L focusing screens have a prism at the center, correct exposures cannot be obtained with evaluative metering and center spot metering. Use either center-weighted average metering or AF point-linked spot metering (except the center AF point).
 - To change the focusing screen, refer to the instructions that came with the focusing screen.

C.Fn IV -12 Timer length for timer

You can change how long the function settings remain in effect after you let go of the respective button.

Disable: The timer length is set to the default.

Enable: The timer length is set to the time set with **[Register]**.

Register: You can set the 6-sec. and 16-sec. timer length and the timer length for after the shutter release. The timer length can be set to 0 sec. to 59 sec. or 1 min. to 60 min. After entering the settings, select **[Apply]**.

- 6-sec. timer: Works with the metering while you shoot through the viewfinder. Also works when you press the <★> button for AE lock.
- 16-sec. timer: Works when you press the <FEL> button for multi-spot metering and FE lock. Also works during Live View shooting for metering and pressing the <★> button for AE lock.
- Timer after release: Normally, the timer is 2 sec. after the picture is taken. A longer timer length will make it easier to use AE lock at the same exposure.

C.Fn IV -13 Shortened release time lag

Normally, stabilization control is executed for the shutter-release time lag. This stabilization control can be omitted to make the shutter-release time lag shorter.

0: Disable

1: Enable

When the aperture is stopped down to no more than 3 stops from the maximum aperture, the shutter-release time lag will be as much as about 20% shorter than normal.

C.Fn IV -14 Add aspect ratio information

During Live View shooting, vertical lines corresponding to the aspect ratio will be displayed. You can thereby simulate framing for medium- and large-format film sizes such as 6x6 cm, 6x4.5 cm, and 4x5 in. This aspect ratio information will be appended automatically to the captured image. (The image will not actually be saved to the memory card as a cropped image.) When the image is transferred to a personal computer and the Digital Photo Professional (provided software) is used, the image will be displayed in the aspect ratio you specified.

0: Off**4: Aspect ratio 6:7****1: Aspect ratio 6:6****5: Aspect ratio 10:12****2: Aspect ratio 3:4****6: Aspect ratio 5:7****3: Aspect ratio 4:5**

-  ● Aspect ratio information will also be appended if you shoot through the viewfinder.
- During image playback on the camera, vertical lines for the respective ratio will be displayed.

C.Fn IV -15 Add original decision data**0: Off****1: On**

Data for verifying whether the image is original or not is appended to the image automatically. When the shooting info of an image appended with the verification data is displayed (p.117), the  icon will appear. To verify whether the image is original, the Original Data Security Kit OSK-E3 (sold separately) is required.

C.Fn IV -16 Live View exposure simulation**0: Disable (LCD auto adjust)****1: Enable (simulates exposure)**

During Live View shooting, the real-time picture shows the brightness corresponding to the exposure setting. This enables you to check the image's exposure right before you take the picture.

-  ● When you press the depth-of-field preview button, the simulated exposure is displayed regardless of the C.Fn IV -16 setting.
- Even if 1 is set, the exposure simulation will not be displayed when an external flash is used nor during bulb exposures.

MENU Registering and Applying Custom Function Settings ■

You can register up to three sets of Custom Function settings. You can register a different set of Custom Function settings for different shooting situations such as sports, snapshots, and landscapes. You can then instantly apply a registered set of Custom Function settings.

Registering Custom Function Settings

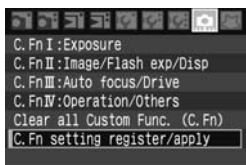

1 Select [C.Fn setting register/apply].

- Under the [MENU] tab, select [C.Fn setting register/apply], then press <SET>.

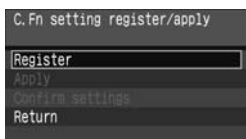

2 Select [Register].

- ▶ Turn the <DISP> dial to select [Register], then press <SET>.

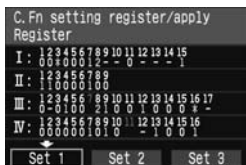

3 Select [Set].

- Turn the <DISP> dial to select [Set *], then press <SET>.

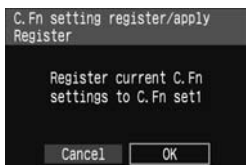

4 Select [OK].

- Turn the <DISP> dial to select [OK], then press <SET>.
- ▶ The Custom Function settings will be registered under [Set *], and the Custom Function settings will be displayed in a list. To return to the screen in step 2, press <SET>.

 The settings for C.Fn III -7 [**AF Microadjustment**] and C.Fn IV -11 [**Focusing Screen**] will not be included in the registered Custom Function settings.

 To view the registered Custom Function settings, select [**Confirm settings**]. The numbers of options changed from the default setting are displayed in blue. If the option's settings include [**Disable/Enable/Register**] and it is set to [**Enable**], a blue [*] will be displayed. (A blue [*] will also be displayed if the C.Fn III -2 setting has been changed.)

Applying Custom Function Settings

In step 2, select [**Apply**] and select the [**Set ***] of the Custom Function settings to be applied. Select [**OK**], and the Custom Function settings will switch to those registered under Set *.

MENU Registering My Menu

Sample

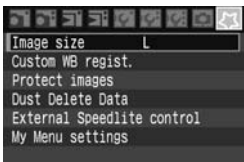

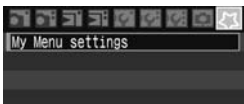

By registering the menu items and Custom Functions which you change frequently, you can access and change them quickly with My Menu. You can register the top layer of items under each menu tab and any Custom Function. You can register up to six items in My Menu.

Registering My Menu Items

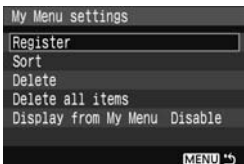

- 1 **Select [My Menu settings].**
 - Under the [] tab, select [**My Menu settings**], then press <SET>.



- 2 **Select [Register].**
 - Turn the </> dial to select [**Register**], then press <SET>.



- 3 **Select an item.**
 - Turn the </> dial to select the item, then press <SET>.



- 4 **Select [OK].**
 - Turn the </> dial to select [**OK**], then press <SET>.
 - ▶ The selected item will be registered in My Menu.
 - To register more items, repeat steps 3 and 4.
 - To return to the screen in step 2, press the <MENU> button.

Deleting My Menu Items

In step 2, select [**Delete**], then select the item to be deleted. To delete all the My Menu items, select [**Delete all items**].

Start Display with My Menu

In step 2, select [**Display from My Menu**], and set [**Enable**]. With the camera ready for shooting, pressing the <MENU> button will display the [**My**] tab first.

Sorting My Menu Items

In step 2, select [**Sort**]. Select the item to be sorted and press <SET>. With the [**Up/Down**] icon displayed on the right of the item, turn the <DIAL> dial to shift the item up or down on the menu. Then press <SET>.



You can also register My Menu items from the provided software.

MENU Saving and Loading Camera Settings

The camera's shooting modes, Custom Functions, and other camera settings can be saved in the memory card as a camera settings file. When this file is loaded by the camera, the saved camera settings will be applied. Convenient when you want to load the camera settings from a different EOS-1Ds Mark III body and set the camera in the same way. Or you can save and load different camera settings for different shooting situations.

Saving Camera Settings

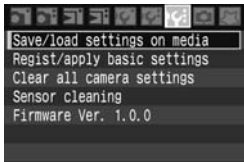



1

Select [**Save/load settings on media**].

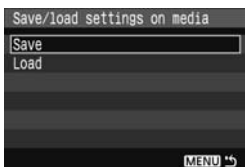
- Under the [**My**] tab, select [**Save/load settings on media**], then press <SET>.



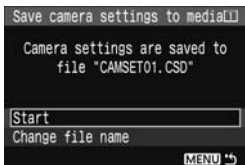

2 Select [Save].

- Turn the <  > dial to select [Save], then press <  >.



3 Select [Start].

- Turn the <  > dial to select [Start], then press <  >.
- ▶ The camera settings will be saved to the memory card, and the screen in step 2 will reappear.
- If you select [Change file name], you can change the file name (8 characters) and save the file. (For the procedure, see "Changing the File Name" on page 77. The number of characters which can be entered will be different, but the procedure for entering the file name is the same.)

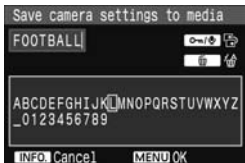

Loading camera settings

In step 2, select [Load]. Up to 10 camera settings files saved in the memory card will be displayed. When you select the desired file, it will be loaded and the settings will be applied to the camera.



- Settings for the date/time, language, video system, C.Fn III -7 and C.Fn IV -11 will not be saved in the file.
- Up to 10 camera settings files can be saved in a memory card. If the memory card already has 10 camera settings files, you can either overwrite the existing file or use another card.
- The camera settings files saved with the camera other than the EOS-1Ds Mark III cannot be loaded to the EOS-1Ds Mark III.

MENU Registering Basic Camera Settings

You can set the basic settings for major functions such as the shooting mode, AF mode, metering mode, and drive mode and register them in the camera.

This is convenient when you want to instantly switch to frequently-used shooting settings.

Registering Basic Settings

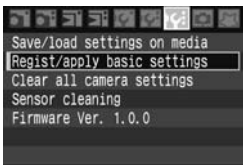

- 1 **Select [Regist/apply basic settings].**
 - Under the [Fn:] tab, select **[Regist/apply basic settings]**, then press <SET>.

- 2 **Select [Register].**
 - Turn the <DISP> dial to select **[Register]**, then press <SET>.

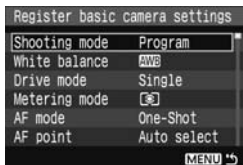

- 3 **Select a function.**
 - Turn the <DISP> dial to select the function, then press <SET>.
 - Up to nine settings such as the shooting mode, white balance, and drive mode can be set.

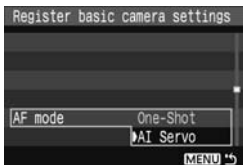

- 4 **Set the function as desired.**
 - Turn the <DISP> dial to select the desired setting, then press <SET>.
- 5 **Exit the setting.**
 - To exit the setting and return to the screen in step 2, press the <MENU> button.

Applying Basic Settings

In step 2, select **[Apply]**. The camera settings will switch to the registered settings. **[Record func.]** will also be set to **[Standard]**, and the exposure compensation, AEB, flash exposure compensation, and WB-BKT will all be canceled.

11

Reference

This chapter provides reference information for camera features, system accessories, etc. The back of this chapter also has an index to make it easier to look up things.

Camera Settings & Battery Information

INFO. Camera Settings

When the camera is ready to shoot, you can press the <INFO.> button to view the function settings on the LCD monitor.



Display the camera settings.

- Press the <INFO.> button.



If C.Fn II -9-1 is set, the shooting functions will be displayed. (p.165)

MENU Battery Info.

You can check the battery's condition on a menu screen.

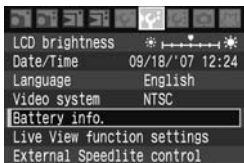
**Select [Battery info.].**

- Under the **[P]** tab, select **[Battery info.]**, then press **<SET>**.

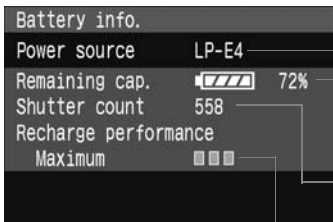

Designation of the battery being used or household power source.

Remaining battery level displayed by the battery check display (p.29) in 1% increments.

Shots taken with the current battery. The number is reset when the battery is recharged.

Battery's performance level is displayed in one of three levels. (p.27)

■■■■ (Green): Battery performance is fine.

■■■ (Green): Battery performance is slightly degraded.

■■ (Red): Purchasing a new battery is recommended.



- If "Calibration is recommended when charging battery next time" is displayed at the bottom of the LCD monitor, see page 28.
- If for some reason, communication with the battery is not successful, the battery check display will show **<[Error Icon]>** on the top LCD panel and the viewfinder. When you check the battery info, **[Cannot communicate with battery]** will be displayed. However, shooting will still be possible.
- If you use any battery other than Battery Pack LP-E4, the camera might not attain its full performance. It may also cause camera malfunction. Using Battery Pack LP-E4 is recommended.

Replacing the Date/Time Battery

The date/time (back-up) battery maintains the camera's date and time. Its service life is about 5 years. If the date/time is reset when the battery is replaced, replace the back-up battery with a new CR2025 lithium battery as described below.

The date/time setting will also be reset, so be sure to set the correct date/time.

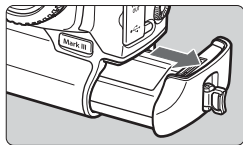

1 Set the power switch to <OFF> and remove the battery pack.

- The back-up battery is on the ceiling of the battery compartment.

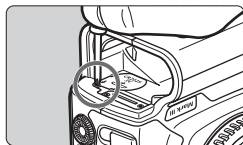

2 Remove the back-up battery cover.

- Use a small screwdriver to loosen the screw and remove the cover.
- Be careful not to lose the cover and screw.

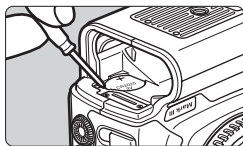

3 Remove the battery.



4 Install a new back-up battery.

- The plus side of the battery must face up.

5 Attach the cover.

 For the date/time battery, be sure to use a CR2025 lithium battery.

Program Line

The following program line applies when the camera is in Program AE <P> mode.

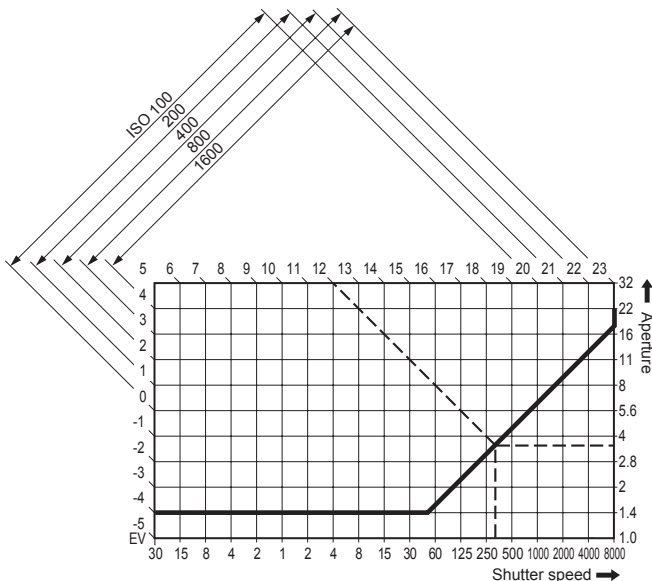

Understanding the Program Line

The lower horizontal axis represents the shutter speed, and the right-hand vertical axis represents the aperture.

The combinations of shutter speed and aperture automatically determined by Program AE are shown as lines with respect to the subject brightness (Exposure Value) levels on the left and top edges of the graph.

Using an EF50mm f/1.4 USM lens with a subject brightness of EV12, the point where the diagonal line from EV12 (on the top edge) intersects the Program AE line represents the corresponding shutter speed (1/320 sec.) and aperture (f/3.5) that the program sets automatically. The diagonal arrowed lines at the upper left indicate the metering range for each ISO speeds.

Troubleshooting Guide

If there is a problem, first refer to this Troubleshooting Guide. If this Troubleshooting Guide does not resolve the problem, contact your dealer or nearest Canon Service Center.

Power

The battery cannot be recharged with the battery charger provided.

- To prevent mishaps, the battery charger cannot recharge any battery other than Battery Pack LP-E4.

The camera does not operate even when the power switch is set to <ON>.

- The battery is not properly installed in the camera. (p.29)
- Make sure the memory card slot cover is closed. (p.32)
- If the top LCD panel does not display the camera settings, recharge the battery. (p.26)

The access lamp remains on even when the power switch is set to <OFF>.

- The images are still being recorded to the memory card. After all the images are recorded to the memory card, the access lamp turns off and the camera turns off automatically.

The battery becomes exhausted quickly.

- Use a fully-charged battery. (p.26)
- The battery performance might have degraded. See the [**ⓘ** Battery info.] menu to check the battery's performance level (p.187). If the battery performance is poor, replace the battery with a new one.

The camera turns off by itself.

- Auto power off is in effect. If you do not want auto power off to take effect, set the [**ⓘ** Auto power off] menu to [**Off**].

Shooting

No images can be shot or recorded.

- The memory card is not properly inserted. (p.32)
- If the memory card is full, replace the card or delete unnecessary images to make room.
Or if a not-full memory card is inserted in the other card slot, switch the recording to that card. (p.32, 73, 128)
- If you try to focus in the One-Shot AF mode while the focus confirmation light <●> in the viewfinder blinks, a picture cannot be taken. Press the shutter button halfway again to focus, or focus manually. (p.36, 86)

The LCD monitor does not display a clear image.

- If dust is adhering to the LCD monitor, wipe with a lens cloth or soft cloth.
- In low or high temperatures, the LCD monitor display may seem slow or it might look black. It will return to normal at room temperature.

The image is out of focus.

- On the lens, set the focus mode switch to <AF>. (p.35)
- To prevent camera shake, hold the camera still and press the shutter button gently. (p.36, 40)

The memory card is unusable.

- If a memory card error message is displayed, see page 48 or 193.

Live View shooting is not possible.

- When using Live View shooting, use a memory card (a hard disk-type card such as MicroDrive is not recommended). A hard disk-type card requires a lower temperature range for operation than with normal memory cards. If the temperature gets too high, the Live View shooting may stop temporarily to prevent damage to the card's hard disk. When the camera's internal temperature decreases, the Live View shooting will be able to resume. (p.109)

Image Review & Operation

The image cannot be erased.

- If the image has been erase-protected, it cannot be erased. (p.123)

The shooting date and time displayed is incorrect.

- The correct date and time has not been set. (p.46)

No image appears on the TV screen.

- Make sure the video cable plug is connected all the way in. (p.122)
- Set the video OUT format (NTSC/PAL) to the same video format as the TV. (p.44)
- Use the video cable that came with the camera. (p.122)

Error Codes



If there is a problem with the camera, an error message appears. Follow the instructions displayed.

To recover from the error, press the shutter button halfway, turn the power switch <OFF> and <ON>, or remove and reinstall the battery.

If error 02 (memory card problem) is displayed, remove and reinstall the memory card or format the card. This may resolve the problem.

If the same error keeps appearing, there may be a problem. Write down the error code and consult your nearest Canon Service Center.

System Map

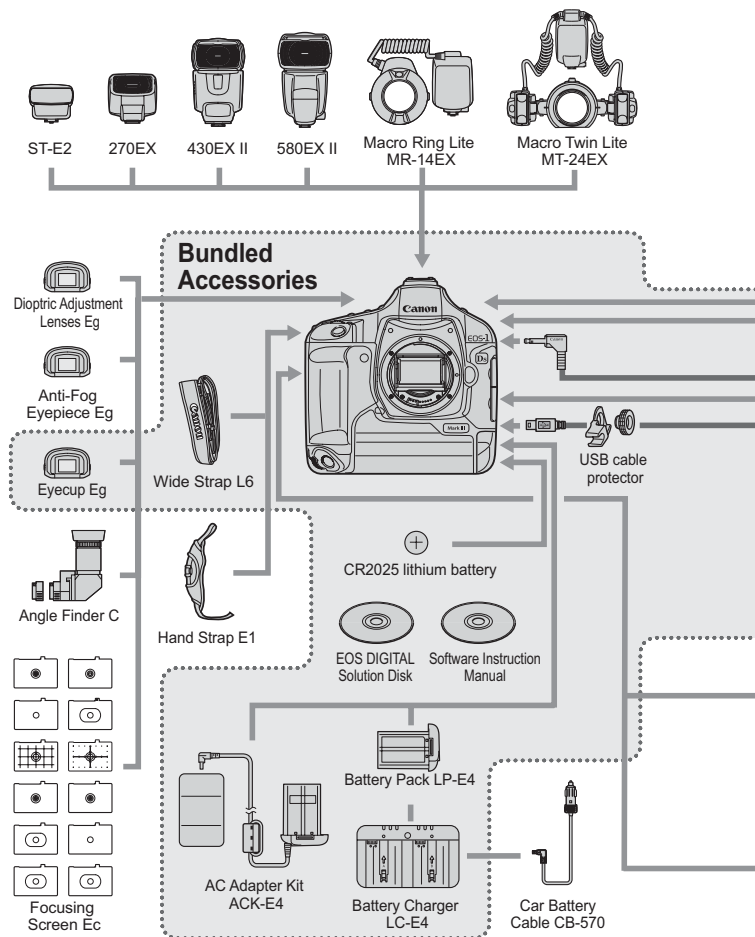

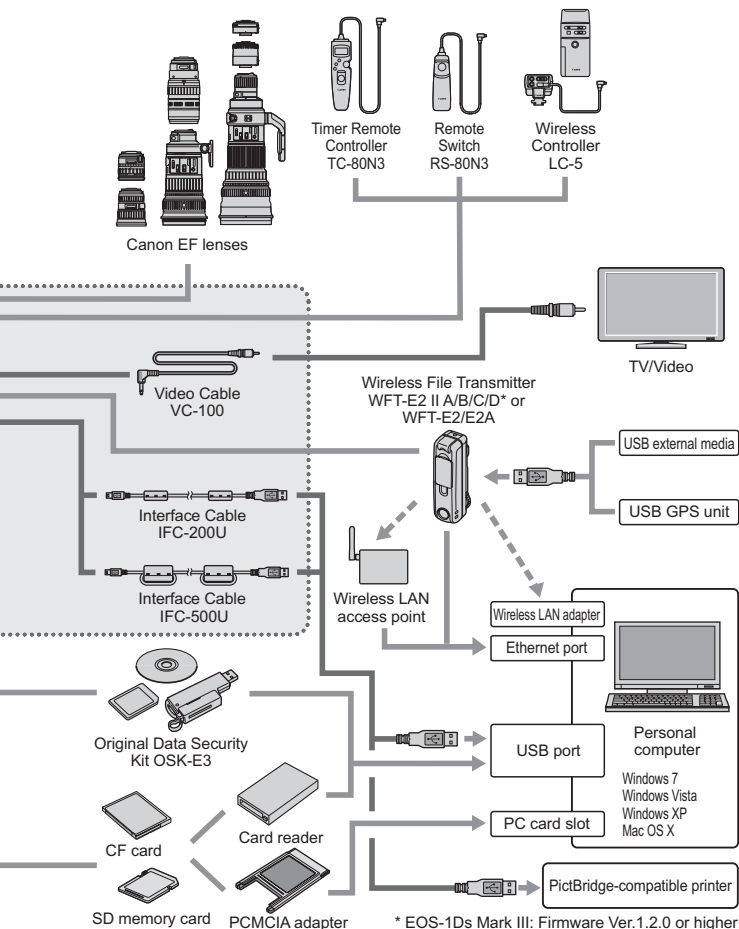

Specifications

• Type

Type:	Digital, single-lens reflex, AF/AE camera
Recording media:	Type I or II CF card, SD/SDHC memory card * CF cards, and Microdrive cards with a 2GB or larger capacity can be used * High-speed data writing enabled with UDMA CF cards * With Wireless File Transmitter WFT-E2 II A/B/C/D or WFT-E2/ A attached, recording possible with USB external media
Image sensor size:	Approx. 36 x 24 mm
Compatible lenses:	Canon EF lenses (except EF-S lenses) (The effective lens focal length is the same as indicated on the lens)
Lens mount:	Canon EF mount

• Image Sensor

Type:	High-sensitivity, high-resolution, large single-plate CMOS sensor
Pixels:	Effective pixels: Approx. 21.10 megapixels Total pixels: Approx. 21.90 megapixels
Aspect ratio:	3:2
Color filter system:	RGB primary color filter
Low-pass filter:	Located in front of the image sensor, non-removable
Dust deletion feature:	(1) Automatic sensor cleaning (2) User-activated sensor cleaning (3) Dust Delete Data appended to the captured image

• Recording System

Recording format:	Design rule for Camera File System 2.0
Image type:	JPEG, RAW (14bit, Canon original)
RAW+JPEG simultaneous recording:	Provided (sRAW+JPEG also possible)
File size:	(1) L (Large) : Approx. 6.4 MB (5616 x 3744 pixels) (2) M1 (Medium1): Approx. 5.2 MB (4992 x 3328 pixels) (3) M2 (Medium2): Approx. 3.9 MB (4080 x 2720 pixels) (4) S (Small) : Approx. 2.2 MB (2784 x 1856 pixels) (5) RAW : Approx. 25.0 MB (5616 x 3744 pixels) (6) sRAW : Approx. 14.5 MB (2784 x 1856 pixels) * JPEG quality: 8, ISO 100, Picture Style: Standard * Exact file sizes depend on the subject, JPEG quality, ISO speed, Picture Style, etc.
Folder setting:	Folder creation/selection enabled

File name:	Preset code, User setting1 (4 characters), User setting2 (3 characters + 1 image size character)
File numbering:	Consecutive numbering, auto reset, manual reset
Color space:	sRGB, Adobe RGB
Picture Style:	Standard, Portrait, Landscape, Neutral, Faithful, Monochrome, User Def. 1 - 3
Recording methods:	(1) Standard (2) Auto switch media (recording media switched automatically) (3) Rec. separately (specified image size for each recording media) (4) Rec. to multiple (same image recorded to all recording media)
Image copy:	Image copying between recording media enabled (Images with checkmarks or all images in folder or card)
Backup:	With WFT-E2 II A/B/C/D or WFT-E2/A attached, all images and folders in the CF card and SD card can be backed up to USB external media

• White Balance

Settings:	Auto, daylight, shade, cloudy, tungsten light, white fluorescent light, flash, custom (total 5 settings), color temperature setting, personal white balance (total 5 settings)
Auto white balance:	Auto white balance with the image sensor
Color temperature compensation:	White balance correction: ± 9 stops in full-stop increments White balance bracketing: ± 3 stops in full-stop increments * Blue/amber direction or magenta/green direction possible

Color temperature information transmission: Provided

• Viewfinder

Type:	Eye-level pentaprism
Coverage:	Approx. 100 percent vertically and horizontally with respect to the effective pixels
Magnification:	Approx. 0.76x (-1 m^{-1} with 50mm lens at infinity)
Eyepoint:	Approx. 20mm (from eyepiece lens center)
Built-in dioptic adjustment:	$-3.0 - +1.0 \text{ m}^{-1}$ (diopter)
Focusing screen:	Interchangeable (11 types, sold separately), Standard focusing screen: Ec-C IV
Mirror:	Quick-return half mirror (transmission:reflection ratio of 37:63, no mirror cut-off with EF1200mm f/5.6L USM or shorter lens)

- Viewfinder information:** AF information (AF points, focus confirmation light), metering and exposure information (metering mode, spot metering circle, shutter speed, aperture, manual exposure, AE lock, ISO speed, exposure level, exposure warning), flash information (flash ready, FP flash, FE lock, flash exposure level), white balance correction, JPEG/RAW recording, maximum burst, number of shots remaining, battery check, recording media information
- Depth-of-field preview:** Enabled with depth-of-field preview button
- Eyepiece shutter:** Built-in
- **Autofocus**
- Type:** TTL-AREA-SIR with a CMOS sensor
- AF points:** 19 AF points (cross-type) and 26 Assist AF points (total 45 points)
- Metering range:** EV -1 - 18 (at 23°C/73°F, ISO 100)
- Focus modes:** One-Shot AF (ONE SHOT), AI Servo AF (AI SERVO), Manual focusing (MF)
- AF point selection:** Automatic selection (45 points), manual selection (19 points, 9 inner points, 9 outer points)
- Selected AF point display:** Superimposed in viewfinder and indicated on top LCD panel
- AF-assist beam:** Emitted by the dedicated external Speedlite
- **Exposure Control**
- Metering modes:** 63-zone TTL full-aperture metering
- (1) Evaluative metering (linkable to any AF point)
 - (2) Partial metering (approx. 8.5% of viewfinder at center)
 - (3) Spot metering
 - Center spot metering (approx. 2.4% of viewfinder at center)
 - AF point-linked spot metering (approx. 2.4% of viewfinder)
 - Multi-spot metering (Max. 8 spot metering entries)
 - (4) Center-weighted average metering
- Metering range:** EV 0 - 20 (at 23°C/73°F with EF50mm f/1.4 USM lens, ISO 100)
- Exposure control:** Program AE (shiftable), shutter-priority AE, aperture-priority AE, manual exposure, E-TTL II autoflash, flash metered manual
- ISO speed**
(Recommended Exposure Index): 100 - 1600 (1/3- or 1-stop increments), expandable to ISO 50 (L) and 3200 (H)
- Exposure compensation:** Manual: ±3 stops in 1/3- or 1/2-stop increments (can be combined with AEB)
AEB: ±3 stops in 1/3- or 1/2-stop increments

AE lock: Auto: Applied in One-Shot AF mode with evaluative metering when focus is achieved
Manual: By AE lock button in all metering modes

• Shutter

Type: Electronically-controlled, focal-plane shutter
Shutter speeds: 1/8000 to 30 sec., bulb (Total shutter speed range. Available range varies by shooting mode.)
X-sync at 1/250 sec.
Shutter release: Soft-touch electromagnetic release
Self-timer: 10-sec. or 2-sec. delay
Remote control: Remote control with N3 type terminal

• Drive System

Drive modes: Single, High-speed continuous, Low-speed continuous, Self-timer (10 sec. and 2 sec), and Silent single shooting

Continuous shooting speed (Approx.):

High-speed continuous: Max. 5 shots/sec.

Low-speed continuous: Max. 3 shots/sec.

Max. burst:

JPEG (Large): Approx. 56, RAW: Approx. 12,

RAW+JPEG (Large): Approx. 10

* Based on Canon's testing conditions with a 2GB CF card for high-speed continuous shooting with JPEG quality 8, ISO 100, Standard Picture Style.

* Varies depending on the subject, memory card brand, image-recording quality, ISO speed, drive mode, Picture Style, Custom Functions, etc.

• External Speedlite

Compatible flash: EX-series Speedlites
Flash metering: E-TTL II autoflash
Flash exposure compensation: ± 3 stops in 1/3- or 1/2-stop increments
FE lock: Provided
External flash settings: Flash function settings, Flash C.Fn settings
PC terminal: Provided
Zooming to match lens focal length: Provided

• Live View Functions

Shooting modes: (1) Remote Live View shooting
(with a personal computer installed with EOS Utility)
(2) Live View shooting
Focusing: Manual focus

Metering modes:	Evaluative metering with the image sensor
Metering range:	EV 0 - 20 (at 23°C/73°F with EF50mm f/1.4 USM lens, ISO 100)
Magnified view:	Magnifiable by 5x or 10x at AF point
Grid display:	Provided
Exposure simulation:	Provided

• LCD Monitor

Type:	TFT color liquid-crystal monitor
Monitor size:	3.0 in.
Dots:	Approx. 230,000
Coverage:	Approx. 100%
Brightness adjustment:	7 levels provided
Interface languages:	18

• Image Playback

Display format:	Single image, single image + image size, shooting info, histogram, 4-image or 9-image index, magnified zoom (approx. 1.5x - 10x), rotated image, jump (by 1/10/100 images, 1 screen, shooting date, or folder)
Highlight alert:	Provided (Overexposed highlights blink)

• Image Protection and Erase

Protect:	Erase protection of one image, all images in a folder, or all images in the memory card can be applied or canceled at one time
Erase:	One image, all images with checkmarks in a folder, or all images in the memory card can be erased (except protected images) at one time

• Sound Recording

Recording method:	The sound clip recorded with the built-in microphone is attached to the image
File type:	WAV
Recording time:	Max. 30 sec. per sound clip

• Direct Printing

Compatible printers:	PictBridge-compatible printers
Printable images:	JPEG images compliant to Design rule for Camera File System (DPOF printing possible) and RAW/sRAW images captured with the EOS-1Ds Mark III

• Digital Print Order Format

DPOF:	Version 1.1 compatible
-------	------------------------

• Direct Image Transfer

Compatible images: JPEG and RAW/sRAW images
 * Only JPEG images can be transferred as wallpaper on the personal computer screen

• Customization

Custom Functions: Total 57
 C.Fn setting registration: Provided
 My Menu registration: Provided
 Save camera settings: Provided
 Register basic camera settings: Provided

• Interface

USB terminal: For personal computer communication and direct printing (Hi-Speed USB)
 Video OUT terminal: NTSC/PAL selectable
 Extension system terminal: For connection to WFT-E2 II A/B/C/D or WFT-E2/A

• Power Source

Battery: Battery Pack LP-E4 (Quantity 1)
 * AC power can be supplied via AC Adapter Kit ACK-E4
 Battery life: At 23°C / 73°F: Approx. 1800 shots
 At 0°C / 32°F: Approx. 1400 shots
 * With fully-charged Battery Pack LP-E4
 * Without Live View shooting
 * The figures above are based on CIPA (Camera & Imaging Products Association) testing standards
 Battery check: Automatic (Displayed in 6 levels)
 * Detailed battery information provided
 Power saving: Provided. Power turns off after 1, 2, 4, 8, 15, or 30 min.
 Date/Time battery: One CR2025 lithium battery
 Startup time: Approx. 0.2 sec.

• Dimensions and Weight

Dimensions (W x H x D): 156 x 159.6 x 79.9 mm / 6.1 x 6.3 x 3.1 in.
 Weight (Approx.): 1210 g / 42.7 oz. (Body only)

• Operating Environment

Working temperature range: 0°C - 45°C / 32°F - 113°F
 Working humidity: 85% or less

• **Battery Pack LP-E4**

Type:	Rechargeable lithium ion battery
Rated voltage:	11.1 V DC
Battery capacity:	2300mAh
Dimensions (W x H x D):	68.4 x 34.2 x 92.8 mm / 2.7 x 1.3 x 3.7 in.
Weight (Approx.):	180 g / 6.3 oz. (excluding protective cover)

• **Battery Charger LC-E4**

Type:	Charger dedicated to the Battery Pack LP-E4
Recharging time:	Approx. 120 min. (for 1 pack)
Rated input:	100 - 240 V AC (50/60 Hz) 12 V / 24 V DC
Rated output:	12.6 V DC, 1.55 A
Power cord length:	Approx. 2 m / 6.6 ft.
Working temperature:	0°C - 40°C / 32°F - 104°F
Working humidity:	85% or less
Dimensions (W x H x D):	155 x 52.3 x 95 mm / 6.1 x 2.1 x 3.7 in.
Weight (Approx.):	340 g / 12.0 oz. (excluding power cord and protective covers)

• **AC Adapter Kit ACK-E4**

[DC Coupler]

Rated input:	12.6 V DC
Rated output:	11.1 V DC
Cord length:	Approx. 2.3 m / 7.5 ft.
Working temperature:	0°C - 45°C / 32°F - 113°F
Working humidity:	85% or less
Dimensions (W x H x D):	68.4 x 34.2 x 92.8 mm / 2.7 x 1.3 x 3.7 in.
Weight (Approx.):	165 g / 5.8 oz. (excluding protective cover)

[AC Adapter]

Rated input:	100 - 240 V AC (50/60 Hz)
Rated output:	12.6 V DC, 2 A
Power cord length:	Approx. 2 m / 6.6 ft.
Working temperature:	0°C - 45°C / 32°F - 113°F
Working humidity:	85% or less
Dimensions (W x H x D):	64.5 x 32.6 x 106 mm / 2.5 x 1.3 x 4.2 in.
Weight (Approx.):	185 g / 6.5 oz. (excluding power cord)

- All specifications above are based on Canon's testing standards.
- The camera's specifications and exterior are subject to change without notice.
- If a problem occurs with a non-Canon lens attached to the camera, consult the respective lens maker.

Trademarks

- Adobe is a trademark of Adobe Systems Incorporated.
 - Windows is a trademark or registered trademark of Microsoft Corporation in the United States and other countries.
 - Macintosh and Mac OS is a trademark or registered trademark of Apple Inc. in the United States and other countries.
 - CompactFlash is a trademark of SanDisk Corporation.
 - The SDHC logo is a trademark.
 - All other corporate and product names and trademarks mentioned in this manual are the property of their respective owners.
- * This digital camera supports Design rule for Camera File System 2.0 and Exif 2.21 (also called “Exif Print”). Exif Print is a standard that enhances compatibility between digital cameras and printers. By connecting to an Exif Print-compliant printer, the shooting information is incorporated to optimize the print output.

Use of genuine Canon accessories is recommended.

This product is designed to achieve excellent performance when used with genuine Canon accessories. Canon shall not be liable for any damage to this product and/or accidents such as fire, etc., caused by the malfunction of non-genuine Canon accessories (e.g., a leakage and/or explosion of a battery pack). Please note that this warranty does not apply to repairs arising out of the malfunction of non-genuine Canon accessories, although you may request such repairs on a chargeable basis.

Digital Camera Model DS126161 Systems

This device complies with Part 15 of the FCC Rules. Operation is subject to the following two conditions: (1) This device may not cause harmful interference, and (2) this device must accept any interference received, including interference that may cause undesired operation.

Note: This equipment has been tested and found to comply with the limits for class B digital devices, pursuant to Part 15 of the FCC Rules. These limits are designed to provide reasonable protection against harmful interference in a residential installation. This equipment generates, uses and can radiate radio frequency energy and, if not installed and used in accordance with the instructions, may cause harmful interference to radio communications. However, there is no guarantee that interference will not occur in a particular installation. If this equipment does cause harmful interference to radio or television reception, which can be determined by turning the equipment off and on, the user is encouraged to try to correct the interference by one or more of the following measures:

- Reorient or relocate the receiving antenna.
- Increase the separation between the equipment and receiver.
- Connect the equipment into an outlet on a circuit different from that to which the receiver is connected.
- Consult the dealer or an experienced radio/TV technician for help.

The cable with the ferrite core provided with the digital camera must be used with this equipment in order to comply with Class B limits in Subpart B of Part 15 of the FCC rules.

Do not make any changes or modifications to the equipment unless otherwise specified in the manual. If such changes or modifications should be made, you could be required to stop operation of the equipment.

Canon U.S.A. Inc.
One Canon Plaza, Lake Success, NY 11042, U.S.A.
Tel No. (516)328-5600

This Class B digital apparatus complies with Canadian ICES-003.



When connecting to and using a household power outlet, use only AC Adapter Kit ACK-E4 (rated input: 100-240 V AC 50/60 Hz, rated output: 12.6 V DC). Using anything else can cause fire, overheating, or electrical shock.

IMPORTANT SAFETY INSTRUCTIONS

1. **SAVE THESE INSTRUCTIONS** — This manual contains important safety and operating instructions for Battery Charger LC-E4.
2. Before using the charger, read all instructions and cautionary remarks on (1) the charger, (2) the battery pack, and (3) the product using the battery pack.
3. **CAUTION** — To reduce risk of injury, charge only the Battery Pack LP-E4. Other types of batteries may burst, causing personal injury and other damage.
4. Do not expose the charger to rain or snow.
5. Use of an attachment not recommended or sold by Canon may result in fire, electric shock, or personal injury.
6. To reduce risk of damage to electric plug and cord, pull by plug rather than by cord when disconnecting charger.
7. Make sure cord is located so that it will not be stepped on, tripped over, or otherwise subjected to damage or stress.
8. Do not operate the charger with damaged cord or plug - replace them immediately.
9. Do not operate the charger if it has received a sharp blow, been dropped, or otherwise damaged in any way; take it to a qualified serviceman.
10. Do not disassemble the charger; take it to a qualified serviceman when service or repair is required. Incorrect reassembly may result in a risk of electric shock or fire.
11. To reduce risk of electric shock, unplug charger from outlet before attempting any maintenance or cleaning.

MAINTENANCE INSTRUCTION

Unless otherwise stated in this manual, there are no user serviceable parts inside. Refer servicing to qualified serviceman.



USA and Canada only:

The Lithium ion/polymer battery that powers the product is recyclable. Please call 1-800-8-BATTERY for information on how to recycle this battery.

For CA, USA only

Included lithium battery contains Perchlorate Material – special handling may apply. See www.dtsc.ca.gov/hazardouswaste/perchlorate/ for details.

CAUTION

RISK OF EXPLOSION IF BATTERY IS REPLACED BY AN INCORRECT TYPE.
DISPOSE OF USED BATTERIES ACCORDING TO LOCAL REGULATION.

Index

A

AC adapter.....	23, 31
Access lamp	18, 34
Adjust levels.....	144
Adobe RGB.....	72
AE	92
AE lock.....	101
AEB.....	100
AF	85, 167
AF microadjustment.....	169
AF mode	82
AF point	84
AF point activation area	170
AF point brightness.....	172
AF point display	118
AF point expansion	170
AF point linked	160
AF start (AF-ON).....	36, 82
AF stop button	173
AF-assist beam.....	107, 172
AI Servo AF	83
AI Servo AF tracking method.....	167
AI Servo characteristics	166
Amber (A)	70, 144
Aperture	96
Aperture value range	161
Aperture-priority AE (Av).....	96
Apply shooting/metering mode	162
Area AF.....	81
Aspect ratio.....	178
Assist AF points	85
Auto cleaning	132
Auto image rotation.....	130
Auto power off.....	47
Auto reset	80
Auto switch media.....	74
Auto white balance	63

Automatic AF point selection.....	84
Automatic AF point selection disabled.....	171
Av	96
AWB	63

B

B/W	142
B/W image.....	58
Backup	43
Battery.....	22, 26, 29
Battery charger.....	22, 26
Battery check	29, 187
Battery compartment cap	29
Battery info	187
Beeper	43, 83
Blue (B)	70, 144
Borders.....	141
Both	148
Bracketed shots	159
Bracketing auto cancel.....	159
Bracketing sequence.....	159
Brightness	144
Brightness display	118
Bulb	102
Bulb exposure	102
Bundled items	3
Bundled software	CD-ROM

C

C.Fn	158
Calibration	28
Camera direct printing.....	137, 150
Camera setting display.....	186
Camera shooting-ready.....	4
Camera-assigned name.....	77
Caption (name)	67
Car battery cable	28, 194

- Center-weighted average
metering 91
- CF card 13, 32, 47, 73
- CF card slot 32
- Clean manually 135
- Clean now 132
- Clear all camera settings 49
- Clear all Custom Functions 156
- Close-up (macro) photography 104
- Cloudy 63
- Color balance 144
- Color saturation 59, 144
- Color space 72
- Color temperature 69
- Color tone 59, 144
- Compensation for damages 2
- Compression rate 55
- Continuous numbering 79
- Continuous shooting 87, 172
- Continuous shooting limit 172
- Contrast 58, 144
- Cool tone 142
- Copying images 125
- Copyrights 2
- Cross-type points 85
- Custom Function list 157
- Custom Function setting
registration 179
- Custom Functions 158
- Custom WB (white balance) 64
- Customization 155
- D**
- Date/File number imprinting 143
- Date/time setting 46
- Daylight 63
- DC coupler 23, 31
- Default 141
- Depth-of-field preview 97
- Design rule for Camera File
System 203
- Difficult-to-focus subjects 86
- DIGITAL terminal 138, 152
- Direct printing 137, 150
- Direct transfer 151
- Discharging 28
- Display entire image 112
- Display formats 116
- DPOF 137
- DPP 133
- Drive mode 87
- Dust Delete Data 133
- E**
- EF lenses 35
- Electronic MF 166
- EOS Utility 152
- Erase 128
- Erasing all images 128
- Erasing all images in a card 128
- Erasing all images in a folder 128
- Error codes 193
- E-TTL II autoflash 105
- E-TTL II flash metering 164
- Evaluative metering 90
- Exif 203
- Exposure compensation 99
- Exposure level increments 158
- Exposure level indicator 21
- Exposure simulation 178
- EX-series Speedlite 105
- Extension system terminal 18
- External media 20, 43
- External Speedlite 105
- External Speedlite control 106
- Eyecup 39

Eyepiece 17
 Eyepiece shutter 103

F

Face brightener 144
 Faithful 57
 FE lock 105
 FEB 105
 File extension 78
 File name 77
 File number 79
 File size 53
 Filter effect 60
 Firmware 45
 Flash 105
 Flash Custom Functions 106
 Flash exposure compensation 105
 Flash function settings 106
 Flash off 165
 Flash sync speed 162
 Flash use 63
 Flash-sync contacts 17
 Focal plane mark 17
 Focus adjustment 169
 Focus confirmation light 21
 Focus lock 83
 Focus mode switch 35, 86, 110
 Focus tracking 83
 Focusing frame 112, 114
 Focusing screen 176
 Folder (Create/Select) 75
 Format 47, 49
 4- or 9-image index display 119
 FP flash 105

G

Green (G) 70, 144
 Grid display 114

H

Hand strap E1 24
 Handling precautions 12
 Hard disk-type card 33, 34, 109
 High ISO speed noise reduction .. 163
 Highlight alert 118
 Highlight tone priority 164
 High-speed continuous shooting 87
 High-speed sync 105
 Histogram 114, 118
 Hold 129
 Holding the camera 40
 Horizontal-line sensitive 85
 Hot shoe 17
 Household power outlet 23, 31

I

ICC profile 72
 Image browsing (Jump display) ... 119
 Image processing 54
 Image protect 123
 Image-recording quality 52
 Image review time 129
 Image size 52
 Image size automatic appending ... 78
 Image transfer 151
 Index 148
 Index display 119
 INFO 114, 117, 186
 Interface cable 138, 152
 ISO speed 56
 ISO speed increments 158
 ISO speed range (extension) 158

J

JPEG 52
 JPEG quality 55
 Jump by 1 screen 119

- Jump by 1/10/100 images..... 119
 Jump by date 119
 Jump by folder 119
 Jump display 119
- L**
- Landscape 57
 Language 46
 Large 52
 LCD brightness 129
 LCD monitor 13
 LCD panel 13, 19, 20
 LCD panel illumination 102
 Lens 13, 35
 Live View shooting 110
 Long exp. noise reduction 163
 Low level format 49
 Low-speed continuous shooting 87
- M**
- M (Manual) 98
 Macro photography 104
 Magenta (M) 70, 144
 Magnified view 112, 120
 Magnified view starting position 120
 Main Dial 4, 37
 Malfunction 190
 Manual AF point selection 84
 Manual exposure (M) 98
 Manual focusing 86
 Manual reset 80
 Maximum burst 53, 54
 Medium 52
 Memory card (CF/SD) ... 13, 32, 47, 73
 Memory card slot cover 32
 Menu settings 43
 Menus 41, 43
 Metering mode 90
- MF 86
 Mirror lockup 104, 172
 Monochrome 58
 Multi-controller 4, 38
 Multi-spot metering 91
 My Menu 181
- N**
- Name (Caption) 67
 Natural 142
 Neutral 57
 New images 153
 19 points/9 points (inner/outer) 170
 Noise reduction 163
 Nomenclature 16
 Non-Canon flash 108
 NR 142
 NTSC 44, 122
- O**
- One-Shot AF 82
 Original decision
 (image verification) data 178
 Overwrite 127
- P**
- P (Program) 92
 Page layout 141
 PAL 44, 122
 Paper settings 140
 Partial metering 90
 PC terminal 108
 Personal white balance 63
 PictBridge 137
 Picture Style 57 - 62
 Playback 116
 Playback menu 41, 43
 Portrait 57
 Possible shots 30, 53, 114

Power cord..... 22, 26, 31
 Power source..... 26, 31, 47
 Power Switch..... 36
 Pressing completely..... 37
 Pressing halfway..... 36
 Print copies..... 143, 149
 Print order (DPOF)..... 137
 Print settings..... 140
 Printer errors..... 146
 Printing effects..... 142, 144
 Program AE (P)..... 92
 Program Line..... 189
 Program shift..... 93
 Protect..... 123
 Protect all images..... 123
 Protecting all images in a card..... 123
 Protecting all images in a folder..... 123
 Protective cover..... 26

Q

Quick Control Dial..... 4, 17, 38

R

RAW..... 52, 54
 RAW(sRAW)+JPEG..... 52
 Rear LCD panel..... 13, 20
 Rec. separately..... 74
 Rec. to multiple..... 74
 Recharge..... 26
 Recording func..... 74
 Recording media
 (CF/SD cards)..... 13, 32, 47, 73
 Red-eye corr..... 144
 Reduction..... 120
 Registering basic camera
 settings..... 184
 Release time lag..... 177
 Remote control terminal..... 103

Remote Live View shooting..... 110
 Remote switch..... 103
 Replacing the date/time battery ... 188
 RGB display..... 118
 Rotate..... 121, 130

S

Safety shift..... 160
 Safety warnings..... 10
 Saving camera settings..... 182
 SD card..... 13, 32, 47, 73
 SD card slot..... 32
 Select all images..... 149, 154
 Select card..... 73
 Select usable metering modes..... 161
 Select usable shooting modes..... 160
 Self Cleaning Sensor Unit..... 131
 Self-timer..... 88
 Sensor cleaning..... 131, 132, 135
 Sepia..... 60
 Set..... 179
 SET button..... 4, 41
 SET button when shooting..... 174
 Set-up menu..... 41, 44
 Shade..... 63
 Sharpness..... 58
 Shoot w/o card..... 43
 Shooting information display..... 117
 Shooting menus..... 41, 43
 Shooting mode..... 19
 Shutter button..... 36
 Shutter curtain sync..... 164
 Shutter speed..... 94
 Shutter speed range..... 161
 Shutter-priority AE (Tv)..... 94
 Silent single shooting..... 87
 Single image..... 149, 154

Single image display	116
Single image erase	128
Single image playback	116
Single image protection	123
Single shooting	87
Skip	127
Small	52
Software instruction manual	CD-ROM
Sound clip	124
Sound recording	124
Specifications	196
Speedlite	105
Spot metering	90
sRAW	52, 54
sRGB	72
Standard	57, 74, 148
Strap	24
Style	57
Subject tracking sensitivity	166
Superimposed display	172
System map	194

T

Temperature increase	109
Timer	4
Timer length	177
Toning effect	60
Top LCD panel	13, 19
Trademarks	203
Transfer all images	153
Transfer order	154
Transfer order images	153
Trimming	145
Tungsten light	63
Tv	94
Type I/II	33

U

Ultra DMA (UDMA)	53
Underscore	72, 76
User Defined	58, 61

V

Vertical	39
Vertical- and horizontal-line sensitive	85
Vertical Shooting	39
Vertical-line sensitive	85
Video cable	122, 195
Video OUT	44, 122
Viewfinder	21
Vivid	142

W

Wallpaper	153
Warm tone	142
WAV	124
WB (white balance)	63
WB-BKT	71
Web site	137
WFT	20, 43, 45
White balance	63
White balance bracketing	71
White balance correction	70
Wireless, Multiple-Speedlite System	105

X

xx-up	141
-------------	-----



CANON INC. 30-2, Shimomaruko 3-chome, Ohta-ku, Tokyo 146-8501, Japan

U.S.A. ————— CANON U.S.A. INC.

One Canon Plaza, Lake Success, NY 11042-1198, U.S.A.
For all inquiries concerning this product, call toll free in the U.S.
1-800-OK-CANON

CANADA ————— CANON CANADA INC. HEADQUARTERS

6390 Dixie Road, Mississauga, Ontario L5T 1P7, Canada
CANON CANADA INC. MONTREAL BRANCH
5990, Côte-de-Liesse, Montréal Québec H4T 1V7, Canada

CANON CANADA INC. CALGARY OFFICE

2828, 16th Street, N.E. Calgary, Alberta T2E 7K7, Canada
For all inquiries concerning this product, call toll free in Canada
1-800-OK-CANON

EUROPE, ————— CANON EUROPA N.V.

AFRICA & Bovenkerkerweg 59-61, 1185 XB Amstelveen, The Netherlands

MIDDLE EAST

CANON FRANCE S.A.S.

17, Quai du Président Paul Doumer, 92414 Courbevoie Cedex, France

CANON UK LTD.

Woodhatch Reigate, Surrey RH2 8BF, United Kingdom

CANON DEUTSCHLAND GmbH

Europark Fichtenhain A10, 47807 Krefeld, Germany

CANON ITALIA S.p.A.

Via Milano 8, 20097 San Donato Milanese, (MI), Italy

CANON Schweiz A.G.

Industriestrasse 12, 8305 Dietlikon, Switzerland

Canon GmbH

Zetschegasse 11, A-1230 Vienna, Austria

CANON España, S.A.

Av. De Europa, 6 Alcobendas 28108 Madrid, Spain

CANON Portugal S.A.

Rua Alfredo da Silva, 14 Alfragide 2610-016 Amadora, Portugal

CENTRAL & ————— CANON LATIN AMERICA, INC.

SOUTH AMERICA 703 Waterford Way, Suite 400 Miami, FL 33126, U.S.A.

ASIA ————— CANON (China) Co., LTD.

15F Jinbao Building No.89 Jinbao Street, Dongcheng District, Beijing 100005, China

CANON HONGKONG CO., LTD.

19/F., The Metropolis Tower, 10 Metropolis Drive, Hunghom, Kowloon, Hong Kong

CANON SINGAPORE PTE. LTD.

1 HarbourFront Avenue, #04-01 Keppel Bay Tower, Singapore 098632

CANON KOREA CONSUMER IMAGING INC.

Gangnam Finance Center 17F, 737, Yeoksam-Dong, Gangnam-Gu, Seoul, 135-984, Korea

OCEANIA ————— CANON AUSTRALIA PTY. LTD.

1 Thomas Holt Drive, North Ryde, Sydney N.S.W. 2113, Australia

CANON NEW ZEALAND LTD.

Akoranga Business Park, Akoranga Drive, Northcote, Auckland, New Zealand

JAPAN ————— CANON MARKETING JAPAN INC.

16-6, Kohnan 2-chome, Minato-ku, Tokyo 108-8011, Japan

This Instruction Manual booklet is current as of August 2007. For information on the camera's compatibility with any accessories and lenses introduced after this date, contact any Canon Service Center.