

Panasonic[®]

Basic Owner's Manual

Digital Camera/
Body

Model No. **DMC-GH4**



LUMIX

Please read these instructions carefully before using this product, and save this manual for future use.

More detailed instructions on the operation of this camera are contained in "Owner's Manual for advanced features (PDF format)" in the supplied DVD. Install it on your PC to read it.



Register online at www.panasonic.com/register (U.S. customers only)

If you have any questions, visit:
USA : www.panasonic.com/support
Canada : www.panasonic.ca/english/support



VQT5H68
F0314WT0

Dear Customer,
Thank you for choosing Panasonic!

You have purchased one of the most sophisticated and reliable products on the market today. Used properly, we're sure it will bring you and your family years of enjoyment. Please take time to fill in the information below. The serial number is on the tag located on the underside of your camera. Be sure to **retain this manual** as your convenient camera information source.

Date of Purchase	Dealer Phone No.
Dealer Purchased From	Model No.
Dealer Address	Serial No.

Please note that the actual controls and components, menu items, etc. of your Digital Camera may look somewhat different from those shown in the illustrations in this Owner's Manual.

Carefully observe copyright laws.

- Recording of pre-recorded tapes or discs or other published or broadcast material for purposes other than your own private use may infringe copyright laws. Even for the purpose of private use, recording of certain material may be restricted.



A lithium ion battery that is recyclable powers the product you have purchased. Please call 1-800-8-BATTERY for information on how to recycle this battery.

Information for Your Safety

WARNING:

To reduce the risk of fire, electric shock or product damage,

- Do not expose this unit to rain, moisture, dripping or splashing.
- Use only the recommended accessories.
- Do not remove covers.
- Do not repair this unit by yourself. Refer servicing to qualified service personnel.

The socket outlet shall be installed near the equipment and shall be easily accessible.

■ Product identification marking

Product	Location
Digital Camera	Bottom
Battery charger	Bottom

THE FOLLOWING APPLIES ONLY IN THE U.S.A.

FCC Note:

This equipment has been tested and found to comply with the limits for a Class B digital device, pursuant to Part 15 of the FCC Rules. These limits are designed to provide reasonable protection against harmful interference in a residential installation. This equipment generates, uses, and can radiate radio frequency energy and, if not installed and used in accordance with the instructions, may cause harmful interference to radio communications. However, there is no guarantee that interference will not occur in a particular installation. If this equipment does cause harmful interference to radio or television reception, which can be determined by turning the equipment off and on, the user is encouraged to try to correct the interference by one or more of the following measures:

- Reorient or relocate the receiving antenna.
- Increase the separation between the equipment and receiver.
- Connect the equipment into an outlet on a circuit different from that to which the receiver is connected.
- Consult the dealer or an experienced radio/TV technician for help.

FCC Caution: To assure continued compliance, follow the attached installation instructions and use only shielded interface cables with ferrite core when connecting to computer or peripheral devices.

Any changes or modifications not expressly approved by the party responsible for compliance could void the user's authority to operate this equipment.

Declaration of Conformity

Trade Name: Panasonic

Model No.: DMC-GH4

Responsible Party: Panasonic Corporation of North America

Two Riverfront Plaza, Newark, NJ 07102-5490

Support Contact: <http://www.panasonic.com/contactinfo>

This device complies with Part 15 of the FCC Rules. Operation is subject to the following two conditions: (1) This device may not cause harmful interference, and (2) this device must accept any interference received, including interference that may cause undesired operation.



THE FOLLOWING APPLIES ONLY IN THE U.S.A.

Certification and Compliance

See Camera for the certification and compliance mark specific to that device.

- 1 Select [Wi-Fi] in the [Setup] menu.**
- 2 Select [Wi-Fi Setup] in the [Wi-Fi] menu.**
- 3 Press ▲/▼ to select [Approved Regulations], and then press [MENU/SET].**

Contains FCC ID: VPYLBXN604

This transmitter must not be co-located or operated in conjunction with any other antenna or transmitter.

This equipment complies with FCC radiation exposure limits set forth for an uncontrolled environment and meets the FCC radio frequency (RF) Exposure Guidelines in Supplement C to OET65.

This equipment has very low levels of RF energy that are deemed to comply without testing of specific absorption ratio (SAR).

THE FOLLOWING APPLIES ONLY IN CANADA.

CAN ICES-3(B)/NMB-3(B)

This device complies with RSS-210 of the IC Rules.

Operation is subject to the following two conditions:

- (1) This device may not cause harmful interference,
- (2) This device must accept any interference received, including interference that may cause undesired operation of the device.

This equipment complies with IC radiation exposure limits set forth for an uncontrolled environment and meets RSS-102 of the IC radio frequency (RF) Exposure rules.

This equipment has very low levels of RF energy that are deemed to comply without testing of specific absorption ratio (SAR).

■ About the battery pack

CAUTION

Battery pack (Lithium ion battery pack)

- Use the specified unit to recharge the battery pack.
- Do not use the battery pack with equipment other than the specified unit.
- Do not get dirt, sand, liquids, or other foreign matter on the terminals.
- Do not touch the plug terminals (+ and –) with metal objects.
- Do not disassemble, remodel, heat or throw into fire.

If any electrolyte should come into contact with your hands or clothes, wash it off thoroughly with water.

If any electrolyte should come into contact with your eyes, never rub the eyes. Rinse eyes thoroughly with water, and then consult a doctor.

CAUTION

- Danger of explosion if battery is incorrectly replaced. Replace only with the type recommended by the manufacturer.
- When disposing of the batteries, please contact your local authorities or dealer and ask for the correct method of disposal.

- Do not heat or expose to flame.
- Do not leave the battery(ies) in a car exposed to direct sunlight for a long period of time with doors and windows closed.

Warning

Risk of fire, explosion and burns. Do not disassemble, heat above 60 °C (140 °F) or incinerate.

■ About the battery charger

CAUTION!

To reduce the risk of fire, electric shock or product damage,

- **Do not install or place this unit in a bookcase, built-in cabinet or in another confined space. Ensure this unit is well ventilated.**

Battery charger

This battery charger operates on AC between 110 V and 240 V.

But

- In the U.S.A. and Canada, the battery charger must be connected to a 120 V AC power supply only.
- When connecting to an AC supply outside of the U.S.A. or Canada, use a plug adaptor to suit the AC outlet configuration.
- When connecting to a supply of greater than AC 125 V, ensure the cord you use is suited to the voltage of the AC supply and the rated current of the battery charger.
- Contact an electrical parts distributor for assistance in selecting a suitable AC plug adaptor or AC cord set.

Cautions for Use

- Do not use any other USB connection cables except the supplied one or a genuine Panasonic USB connection cable (DMW-USBC1: optional).
- Use a "High Speed HDMI micro cable" with the HDMI logo.
Cables that do not comply with the HDMI standards will not work.
"High Speed HDMI micro cable" (Type D–Type A plug, up to 2 m (6.6 feet) long)
- Always use a genuine Panasonic AV cable (DMW-AVC1: optional).
- Always use a genuine Panasonic remote shutter (DMW-RSL1: optional).
- Do not use the synchro cables with the length of 3 m (9.8 feet) or more.

Keep this unit as far away as possible from electromagnetic equipment (such as microwave ovens, TVs, video games etc.).

- If you use this unit on top of or near a TV, the pictures and/or sound on this unit may be disrupted by electromagnetic wave radiation.
- Do not use this unit near cell phones because doing so may result in noise adversely affecting the pictures and/or sound.
- Recorded data may be damaged, or pictures may be distorted, by strong magnetic fields created by speakers or large motors.
- Electromagnetic wave radiation may adversely affect this unit, disturbing the pictures and/or sound.
- If this unit is adversely affected by electromagnetic equipment and stops functioning properly, turn this unit off and remove the battery or disconnect AC adaptor (DMW-AC10PP: optional). Then reinsert the battery or reconnect AC adaptor and turn this unit on.

Do not use this unit near radio transmitters or high-voltage lines.

- If you record near radio transmitters or high-voltage lines, the recorded pictures and/or sound may be adversely affected.

-
- Before cleaning the camera, remove the battery or the DC coupler (DMW-DCC12: optional), or disconnect the power plug from the outlet.
 - Do not press the monitor with excessive force.
 - Do not press the lens with excessive force.
 - Do not spray the camera with insecticides or volatile chemicals.
 - Do not keep rubber or plastic products in contact with the camera for a long period of time.
 - Do not use solvents such as benzine, thinner, alcohol, kitchen detergents, etc., to clean the camera, since it may deteriorate the external case or the coating may peel off.
 - Do not leave the camera with the lens facing the sun, as rays of light from the sun may cause it to malfunction.
 - Always use the supplied cords and cables.
 - Do not extend the cords or the cables.
 - During access (image writing, reading and deleting, formatting etc.), do not turn this unit off, remove the battery, card or disconnect the AC adaptor (DMW-AC10PP: optional). Furthermore, do not subject the camera to vibration, impact or static electricity.
 - The data on the card may be damaged or lost due to electromagnetic waves, static electricity or breakdown of the camera or the card. We recommend storing important data on a PC etc.
 - Do not format the card on your PC or other equipment. Format it on the camera only to ensure proper operation.
-

- The battery is not charged when the camera is shipped. Charge the battery before use.
 - The battery is a rechargeable lithium ion battery. If the temperature is too high or too low, the operating time of the battery will become shorter.
 - The battery becomes warm after using and during and after charging. The camera also becomes warm during use. This is not a malfunction.
 - Do not leave any metal items (such as clips) near the contact areas of the power plug or near the batteries.
 - Store the battery in a cool and dry place with a relatively stable temperature: [Recommended temperature: 15 °C to 25 °C (59 °F to 77 °F), Recommended humidity: 40%RH to 60%RH]
 - Do not store the battery for a long time while fully charged. When storing the battery for a long period of time, we recommend charging it once a year. Remove the battery from the camera and store it again after it has completely discharged.
-

-If you see this symbol-

Information on Disposal in other Countries outside the European Union

This symbol is only valid in the European Union.

If you wish to discard this product, please contact your local authorities or dealer and ask for the correct method of disposal.



Contents

Information for Your Safety	2
• Cautions for Use	6

Preparation

Care of this Camera	10
Standard Accessories	11
Names and Functions of Components	12
About the Lens	14
Cards Compatible with this unit	15
Preparation	16

- Attaching the Shoulder Strap 16
- Charging the Battery 16
- Inserting/Removing the Battery 17
- Inserting/Removing the Card (Optional) 17
- Changing the Lens 18
- Opening the Monitor 18
- Setting Date/Time (Clock Set) 19
- Diopter adjustment 19

Basic Operations

• Tips for taking good pictures	20
• Zoom operations	20
• Shutter button (Taking pictures)	21
• Motion picture button (Recording motion pictures)	21
• Mode dial (Selecting a Recording Mode)	22
• Rear Dial/Front Dial	23
• Control Dial	23
• Cursor buttons/[MENU/SET] button	23
• [DISP.] button (Switching the displayed information)	24
• [LVF] button (Switching the Monitor/Viewfinder)	25
• Touch panel (Touch operations)	26

Optical Image Stabilizer

Calling frequently-used menus instantly (Quick Menu)	27
Setting menu items	28
Configuring basic settings of this unit (Setup Menu)	29
• Formatting the card (initialization)	29
• Restoring the default settings ([Reset])	29
• Conserving the battery life ([Economy])	29

Easy Recording

Taking Pictures using the Automatic Function (Intelligent Auto Mode)	30
• Recording night scenes ([iHandheld Night Shot])	31
• Combining pictures into a single picture	

- with rich gradation ([iHDR]) 32
- Taking a picture with a blurred background (Defocus Control) 32
- Recording images by changing the brightness or color tone 32

Taking Pictures with different image effects (Creative Control Mode)

Taking Pictures Using the Touch Function	34
• Taking pictures using the Touch Shutter function	34
• Easily Optimizing the Brightness for a Specified Area (Touch AE)	35

Recording

Taking Pictures with Auto Focus

- Selecting the Focus Mode (AFS/AFF/AFC) 36
- Selecting the Auto Focus Mode 37
- Setting up position of the AF area/ changing size of the AF area 38
- Setting the AF area position with the Touch Pad 39

Taking Pictures with

Manual Focus	40
Select a Drive Mode	41
Taking Pictures using Burst Mode ...	41
Taking Pictures using Auto Bracket	42
Taking Pictures with the Self-timer	42
Taking Pictures Automatically at Set Intervals ([Time Lapse Shot])	43
Creating Stop Motion Pictures ([Stop Motion Animation])	45
Setting the Picture Quality and Size	47

- Setting the aspect ratio of pictures 47
- Setting the number of pixels 47
- Setting the compression rate of pictures ([Quality]) 48

Setting the Light Sensitivity

Adjusting the White Balance

Taking Pictures with Your Favorite Settings (Program AE Mode)

Taking Pictures by Specifying the Aperture/Shutter Speed

- Aperture-Priority AE Mode 52
- Shutter-Priority AE Mode 52
- Manual Exposure Mode 52
- Confirm the Effects of Aperture and Shutter Speed (Preview Mode) 53

Compensating the Exposure

Selecting the Method for Measuring Brightness ([Metering Mode])

Fixing the Focus and the Exposure (AF/AE Lock)

Disabling Operational Sounds and the Output of Light at once ([Silent Mode])

Taking Pictures with No Shutter Sound ([Electronic Shutter])	56
Taking pictures by using the flash ...	57
• Changing Flash Mode	57

Motion Picture

Recording Motion Picture	58
• Recording motion pictures in 4K ...	59
• Setting the format, size and recording frame rate	59
• How to set focus when recording a motion picture ([Continuous AF])	62

Recording motion pictures with manually set aperture value/shutter speed (Creative Video Mode)	62
• Minimizing operational sounds during motion picture recording	63

Using Advanced Settings and Recording Functions for Motion Pictures	64
• [Luminance Level]	64
• Checking areas that may be white saturated ([Zebra Pattern])	64
• Recording while monitoring camera images	65
• Reducing flickering and horizontal stripes on images ([Synchro Scan])	66
• Recording in Slow or Fast Motion ([Variable Frame Rate])	66
• Changing the system frequency	67

Playback/Editing

Playing Back Pictures	68
Playing Back Motion Pictures	68
Switching the Playback Method	69
• Using the Playback Zoom	69
• Displaying multiple screens (Multi Playback)	69
• Displaying Pictures by Recording Date (Calendar Playback)	69
Deleting Pictures	70
Using the [Playback] Menu	71
• [RAW Processing]	71
• [Video Divide]	72

Wi-Fi/NFC

Wi-Fi® function/NFC function	73
What you can do with the Wi-Fi function	75
Controlling with a Smartphone/Tablet	76
• Installing the smartphone/tablet app “Image App”	76

• Connecting to a smartphone/tablet	76
• Taking images via a smartphone/ tablet (remote recording)	80
• Playing back images in the camera	80
• Saving images stored in the camera	80
• Sending images in the camera to an SNS	81
• Adding location information to images stored in the camera from a smartphone/tablet	82

Setting up a connection to a PC via a wireless access point	83
--	-----------

Customization

Change the Quick Menu to your preferred item	85
Assigning frequently used functions to the buttons (function buttons)	85
Registering your preferred settings (Custom Mode)	86
• Registering Personal Menu Settings (Registering custom settings)	86
• Recording using registered custom set	86

Others

Playing Back Pictures on a TV Screen	87
Saving still pictures and motion pictures on your PC	88
• About the supplied software	88
Monitor Display/Viewfinder Display	92
Message Display	97
Menu list	99
• [Rec]	99
• [Motion Picture]	101
• [Custom]	102
• [Setup]	104
• [Playback]	106
Troubleshooting	107
Cautions for Use	113
Specifications	116
Digital Camera Accessory System	123
Reading the Owner’s Manual (PDF format)	124
Digital Camera Accessory Order Form (For USA Customers)	125
Limited Warranty (ONLY FOR U.S.A.)	126
Limited Warranty (ONLY FOR CANADA)	129

Care of this Camera

To avoid damaging your camera and to experience the maximum enjoyment you should exercise the following precautions.

- The lens, monitor and the camera body can sustain damage if the camera body is dropped or subjected to excessive temperature, moisture, water or dust.
- The monitor can be damaged if excessive pressure is applied to the screen surface, during actual use or while cleaning.

■ Splash Proof

Splash Proof is a term used to describe an extra level of protection this camera offers against exposure to a minimal amount of moisture, water or dust. Splash Proof does not guarantee that damage will not occur if this camera is subjected to direct contact with water.

In order to minimize the possibility of damage please be sure the following precautions are taken:

- The Splash Proof feature works in conjunction with the H-HS12035 and H-HS35100 lenses that were specifically designed to support this feature.
- Make sure the built-in flash is closed.
- Make sure that all doors, socket caps and terminal covers are securely closed.
- Make sure that you are in a dry and secure place when changing the battery, lens or memory card. After changing, make sure their protective doors are securely closed.
- If this camera is exposed to water, sand or any other foreign material clean it as soon as possible, taking the necessary precautions that the foreign substance does not get inside the camera.
- Under no circumstances should you touch or place any foreign objects within the camera or in close proximity of the camera's image sensor.

■ Condensation

- Condensation may occur on the lens, monitor or in the viewfinder when the room temperature or humidity changes rapidly. This may cause the image to temporarily become hazy. If this occurs, turn the camera off and allow the camera to sit in a temperature stable environment for several minutes. It will clear by itself.
- If you know that you will be moving between areas where there will be a large change in temperature or humidity, you can help prevent condensation forming on the camera by placing the camera in a large plastic zipper bag, so condensation will form on the bag, not the camera. Allow the temperature to stabilize before removing the camera from the bag.

Standard Accessories

Check that all the accessories are supplied before using the camera.
Product numbers correct as of March 2014. These may be subject to change.

Digital Camera Body

(This is referred to as **camera body** in this Owner's Manual.)



- 1 Battery Pack
(Indicated as **battery pack** or **battery** in the text)
Charge the battery before use.
- 2 Battery Charger
(Indicated as **battery charger** or **charger** in the text)
- 3 AC Cable
- 4 USB Connection Cable
- 5 DVD
 - Software:
Use it to install the software to your PC.
 - Owner's Manual for advanced features:
Use it to install to your PC.
- 6 Shoulder Strap
- 7 Body Cap*
- 8 Hot shoe cover*
- 9 Eye Cup*
- 10 Flash synchro socket cap*
- 11 Cover for the battery grip connector*
- 12 Cover for the interface unit connector*

* This is attached to the camera body at the time of purchase.

• SD Memory Card, SDHC Memory Card and SDXC Memory Card are indicated as **card** in the text.

• **The card is optional.**









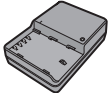

• Description in this Owner's Manual is based on the interchangeable lens (H-HS12035).

(For U.S.A. only)

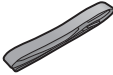
• If accessories are lost, customers can visit us at www.panasonic.com/support for further information about obtaining replacement parts.

(For Canada only)





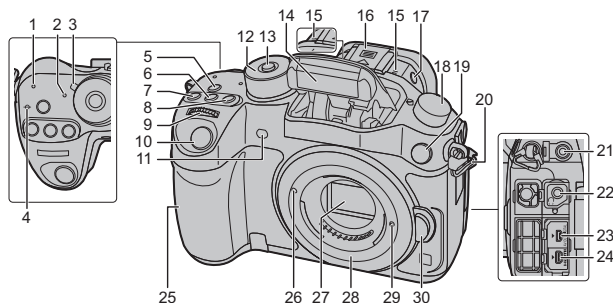

• If any accessories are lost, customers in Canada should visit our support page at www.panasonic.ca/english/support for further information about obtaining replacement parts.

1  DMW-BLF19PP	2  DMW-BTC10PP
3  K2CA2CA00025	4  K1HY08YY0031
5  VFW0106	6  VFC5122
7  VKF4971	8  VYF3522
9  VYK6T25	10  VKF5108
11  VKF5104	12  VKF5289



Names and Functions of Components

■ Camera body

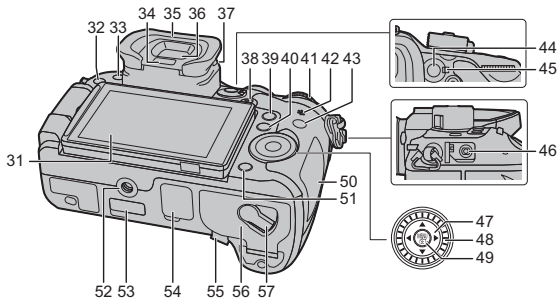

1	Wi-Fi® connection lamp	17	Flash open button (P57) • The flash opens, and recording with the flash becomes possible.
2	Status indicator (P19)	18	Drive mode dial Single (P41): <input type="checkbox"/> Burst (P41):  Auto Bracket (P42):  Self-timer (P42):  Time Lapse/Animation (P43, 45): 
3	Camera ON/OFF switch (P19)	19	Flash synchro socket (Flash synchro socket cap)
4	Focus distance reference mark	20	Shoulder strap eyelet (P16)
5	[Wi-Fi] button (P74)/[Fn1] button (P85)	21	[MIC] socket
6	[ISO] (ISO sensitivity) button (P49)	22	Headphone socket (P102, 105)
7	[] (Exposure Compensation) button (P54)	23	[AV OUT/DIGITAL] socket (P87, 90)
8	[WB] (White Balance) button (P50)	24	[HDMI] socket (P87)
9	Front dial (P23)	25	NFC antenna [] (P81)
10	Shutter button (P21)	26	Lens fitting mark (P18)
11	Self-timer indicator (P42)/ AF Assist Lamp (P103)	27	Sensor
12	Mode dial (P22)	28	Mount
13	Mode dial lock button (P22)	29	Lens lock pin
14	Flash (P57)	30	Lens release button (P18)
15	Stereo microphone (P102) • Be careful not to cover the microphone with your finger. Doing so may make sound difficult to record.		
16	Hot shoe (Hot shoe cover) • Keep the Hot Shoe Cover out of reach of children to prevent swallowing.		



31	Touch screen/monitor (P26)	51	 (Delete/Cancel) button (P70)/ [Fn4] button (P85)
32	[▶] (Playback) button (P68)	52	Tripod mount • A tripod with a screw length of 5.5 mm (0.22 inch) or more may damage this unit if attached.
33	[LVF] button (P25)/[Fn5] button (P85)	53	Cover for the interface unit connector • Keep the cover for the interface unit connector out of reach of children to prevent swallowing. • This connector cover is for a professional motion picture device (U.S.A.: DMW-YAGH (P123), Canada: AG-YAGH). For details on AG-YAGH, refer to the site below. http://pro-av.panasonic.net
34	Eye sensor (P26) Eye Cup (P114)	54	Cover for the battery grip connector • Keep the cover for the battery grip connector out of reach of children to prevent swallowing.
35	• Keep the eye cup out of reach of children to prevent swallowing.	55	DC coupler cover • When using an AC adaptor, ensure that the Panasonic DC coupler (DMW-DCC12: optional) and AC adaptor (DMW-AC10PP: optional) are used. • Always use a genuine Panasonic AC adaptor (DMW-AC10PP: optional). • It is recommended to use a fully charged battery or AC adaptor when recording motion pictures. • If while recording motion pictures using the AC adaptor and the power supply is cut off due to a power outage or if the AC adaptor is disconnected etc., the motion picture will not be recorded.
36	Viewfinder (P25)	56	Battery door (P17)
37	Diopter adjustment dial (P19)	57	Release lever (P17)
38	Motion picture button (P58)		
39	[Q.MENU] button (P27)/[Fn2] button (P85)		
40	[] (Auto Focus Mode) button (P36)/ [Fn3] button (P85)		
41	Rear dial (P23) Speaker (P104)		
42	• Be careful not to cover the speaker with your finger. Doing so may make sound difficult to hear.		
43	[DISP.] button (P24) • Each time this is pressed, the display on the monitor is switched.		
44	[AF/AE LOCK] button (P55)		
45	Focus mode lever (P36, 40)		
46	[REMOTE] socket		
47	Cursor buttons (P23)		
48	Control dial (P23)		
49	[MENU/SET] button (P23, 28)		
50	Card door (P17)		

About the Lens

■ Micro Four Thirds™ mount specification lens

This unit can use the dedicated lenses compatible with the Micro Four Thirds System lens mount specification (Micro Four Thirds mount).

■ Four Thirds™ mount specification lens

Lens with the Four Thirds mount specification can be used by using the mount adaptor (DMW-MA1: optional).

■ Leica mount specification lens

When you use the M mount adaptor or R mount adaptor (DMW-MA2M, DMW-MA3R: optional), you can use Leica M Mount or Leica R Mount interchangeable lenses.

- For certain lenses, the actual distance at which the subject is in focus may differ slightly from the rated distance.
- When using a Leica lens mount adaptor, set [Shoot w/o Lens] (P104) to [ON].

For details on the lens used, refer to the website.

Refer to catalogs/Web pages for most current information regarding compatible lenses.

<http://panasonic.jp/support/global/cs/dsc/>

(This Site is English only.)

- The available flash range etc. differs depending on the aperture value of the lens you are using.
- The focal length noted on the lens in use is equivalent to double when converted to the 35 mm film camera.

(It will be equivalent to 100 mm lens when a 50 mm lens is used.)

Refer to the website for details about the 3D interchangeable lens.

Cards Compatible with this unit









The following cards which conform to the SD standard can be used with this unit. (These cards are indicated as **card** in the text.)

SD Memory Card (8 MB to 2 GB)	<ul style="list-style-type: none"> •SDHC Memory Cards and SDXC Memory Cards can be used only with their compatible devices. •Check that the PC and other equipment are compatible when using the SDXC Memory Cards. http://panasonic.net/avc/sdcard/information/SDXC.html •This unit is compatible with UHS-I UHS Speed Class 3 standard SDHC/SDXC memory cards. •Only the cards with capacity listed left can be used.
SDHC Memory Card (4 GB to 32 GB)	
SDXC Memory Card (48 GB, 64 GB)	

■ About the motion picture recording and speed class

According to the [Rec Format] (P59) and [Rec Quality] (P59) of a motion picture, the required card differs. Use a card that meets the following ratings of the SD Speed Class or UHS Speed Class.

- SD Speed Class and UHS Speed Class are the speed standards regarding continuous writing. To check the class, see the labelled side, etc. of the card.

[Rec Format]	Bit rate in [Rec Quality]*	Speed class	Label example
[AVCHD]	All	Class 4 or higher	CLASS  
[MP4]	100 Mbps	UHS Speed Class 3	
	28 Mbps or lower	Class 4 or higher	CLASS  
[MP4 (LPCM)]/ [MOV]	100 Mbps or higher	UHS Speed Class 3	
	50 Mbps	UHS Speed Class 1 or higher	
		Class 10	CLASS  

* Bit rates vary depending on the item selected in [Rec Quality] in the [Motion Picture] menu. For details, refer to P59.

- Please confirm the latest information on the following website.

<http://panasonic.jp/support/global/cs/dsc/>

(This Site is English only.)

Preparation

- Check that the camera is turned off.

Attaching the Shoulder Strap

- We recommend attaching the shoulder strap when using the camera to prevent it from dropping.

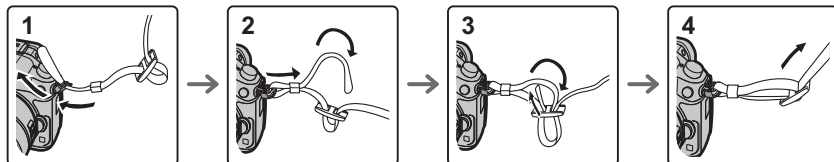

- Perform steps 1 to 4 and then attach the other side of the shoulder strap.

- Use the shoulder strap around your shoulder.
 - Do not wrap the strap around your neck.
 - It may result in injury or accident.
- Do not leave the shoulder strap where an infant can reach it.
 - It may result in an accident by mistakenly wrapping around the neck.

Charging the Battery

The battery that can be used with this unit is DMW-BLF19PP.

- 1 Connect the AC cable.
- 2 Attach the battery paying attention to the direction of the battery.
 - The [CHARGE] indicator (A) lights up and charging begins.



■ About the [CHARGE] indicator

The [CHARGE] indicator turns on:

The [CHARGE] indicator is turned on during charging.

The [CHARGE] indicator turns off:

The [CHARGE] indicator will turn off once the charging has completed without any problem.

(Disconnect the charger from the electrical socket and detach the battery after charging is completed.)

■ Charging time

Charging time

Approx. 220 min

- The indicated charging time is for when the battery has been discharged completely. The charging time may vary depending on how the battery has been used. The charging time for the battery in hot/cold environments or a battery that has not been used for a long time may be longer than normal.

Inserting/Removing the Battery

- Always use genuine Panasonic batteries (DMW-BLF19PP).
- If you use other batteries, we cannot guarantee the quality of this product.

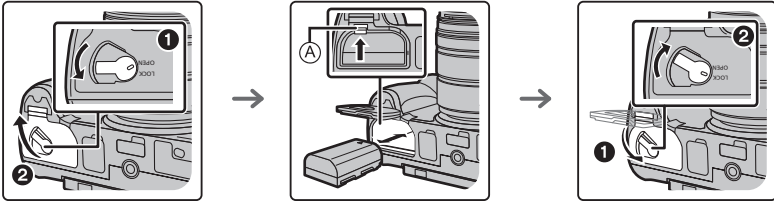

- Being careful about the battery orientation, insert all the way until you hear a locking sound and then check that it is locked by lever (A).
- Pull the lever (A) in the direction of the arrow to remove the battery.

Inserting/Removing the Card (Optional)

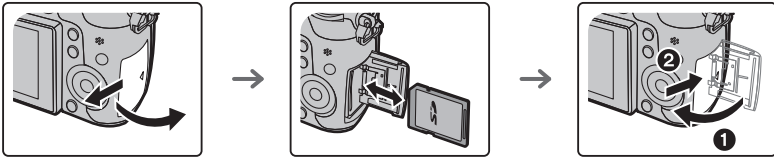

- Push it securely all the way until you hear a "click" while being careful about the direction in which you insert it.
 - To remove the card, push the card until it clicks, then pull the card out upright.
- Keep the Memory Card out of reach of children to prevent swallowing.

Changing the Lens

- Change lenses where there is not a lot of dirt or dust.

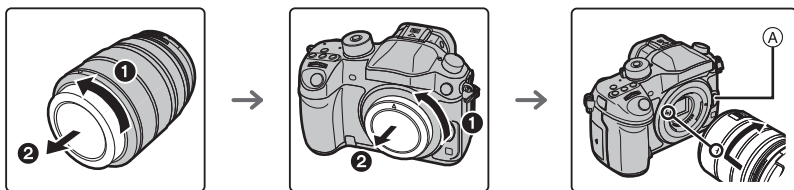

- Do not press the lens release button (A) when you attach a lens.

■ Detaching the lens

- 1 Attach the lens cap.
- 2 While pressing on the lens release button (B), rotate the lens toward the arrow until it stops and then remove.

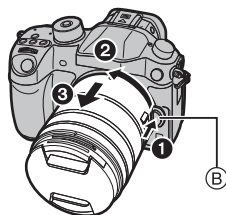

Opening the Monitor

At the time when this camera is purchased, the monitor is stowed in the camera body. Bring out the monitor as shown below.

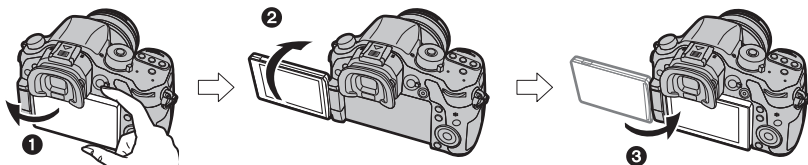

- 1 Open the monitor. (Maximum 180°)
 - 2 It can be rotated 180° forward.
 - 3 Return the monitor to its original position.
- Only rotate the monitor after opening it wide enough, and be careful not to use excessive force as it may be damaged.

Setting Date/Time (Clock Set)

• The clock is not set when the camera is shipped.

- 1 Turn the camera on.
 - The status indicator ❶ lights when you turn this unit on.
- 2 Press [MENU/SET].
- 3 Press ◀/▶ to select the items (year, month, day, hour, minute), and press ▲/▼ to set.
- 4 Press [MENU/SET].
 - Confirmation screen is displayed. Press [MENU/SET].
 - A message prompting you to set [Home] in [World Time] will be displayed. Press [MENU/SET].
- 5 Press ◀/▶ to select the home area, and then press [MENU/SET].

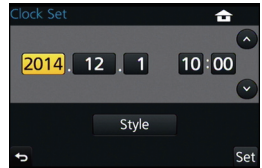
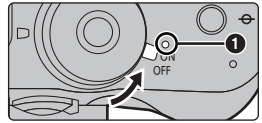

Diopter adjustment

Adjust the diopter to suit your vision so that you can see the characters displayed in the viewfinder clearly.

- Ⓐ Diopter adjustment dial

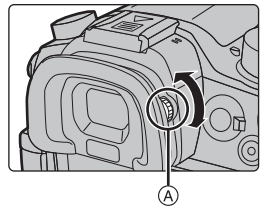

Basic Operations

Tips for taking good pictures

Hold the camera gently with both hands, keep your arms still at your side and stand with your feet slightly apart.

- Do not cover the flash, the AF assist lamp (A), the microphone (B) (P12) or Speaker with your fingers or other objects.
- Be careful not to move the camera when you press the shutter button.
- Be sure to remove the lens cap when recording.

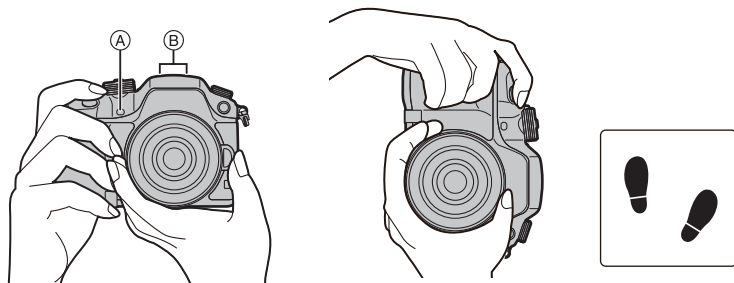

Free angle shooting

The monitor can be rotated to suit your needs. This is convenient as it allows you to take pictures from various angles by adjusting the monitor.

Taking pictures at a high angle

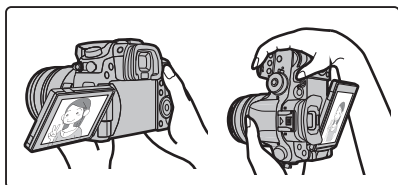

Taking pictures at a low angle

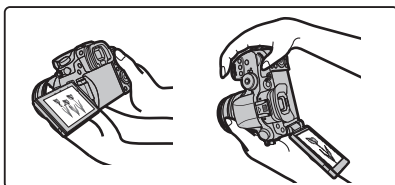

Zoom operations

When using the interchangeable lens (H-HS12035)

Rotate the zoom ring of the lens.

- (A) Tele
- (B) Wide

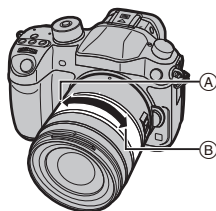

Shutter button (Taking pictures)

The shutter button works in two steps. To take a picture, press it.

Press the shutter button halfway to focus.

- (A) Aperture value
- (B) Shutter speed
- (C) Focus indication
- Aperture value and shutter speed are displayed.
(It will flash in red if the correct exposure is not achieved, except when set to flash.)
- Once the subject is in focus, the focus indication is displayed.
(When the subject is not in focus, the indication flashes)

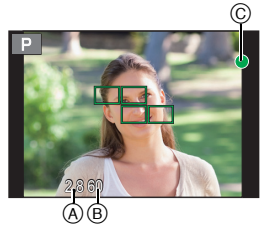
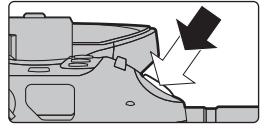

Press the shutter button fully (push it in further), and take the picture.

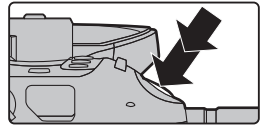

- When the image is correctly focused, the picture will be taken, since the [Focus/Release Priority] (P103) is set initially to [FOCUS].
- The focus range is different depending on the lens used.

When the interchangeable lens (H-HS12035) is used	0.25 m (0.82 feet) to ∞ (from the focus distance reference line)
--	--

- Even during menu operation or image playback, if you press the shutter button halfway, you can instantly set the camera ready for recording.

Motion picture button (Recording motion pictures)

Press the motion picture button to start and stop recording a motion picture.

Start recording by pressing the motion picture button.

- Release the motion picture button right after you press it.

Stop the recording by pressing the motion picture button again.

- Since motion picture recording stops only after you press the motion picture button, the sound of the operation may be noticeable. (P58)

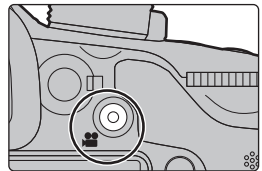

Mode dial (Selecting a Recording Mode)

Rotate the mode dial to switch the Recording Mode.



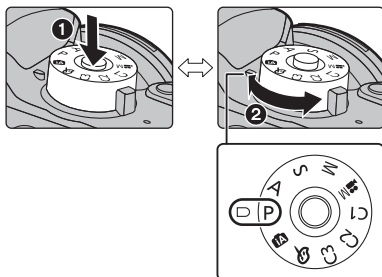

Press the mode dial lock button ❶ to release the lock.

- The dial is locked if the mode dial lock button is depressed. Each press locks/unlocks the dial.



Rotate the mode dial ❷ and adjust the recording mode.

- After adjusting the recording mode, press the mode dial lock button to lock the dial.

	Intelligent Auto Mode (P30) The subjects are recorded using settings automatically selected by the camera.
	Intelligent Auto Plus Mode (P31) Allows you to adjust the brightness and color hue when in Intelligent Auto Mode.
P	Program AE Mode (P51) Records at the aperture value and shutter speed set by the camera.
A	Aperture-Priority AE Mode (P52) The shutter speed is automatically determined by the aperture value you set.
S	Shutter-Priority AE Mode (P52) The aperture value is automatically determined by the shutter speed you set.
M	Manual Exposure Mode (P52) The exposure is adjusted by the aperture value and the shutter speed which are manually adjusted.
	Creative Video Mode (P62) Records a motion picture with the aperture value and the shutter speed you specify. In this recording mode, all the motion picture functions become available. For example, you can record motion pictures in 4K (motion pictures with their size set to [4K] or [C4K] in [Rec Quality]). * You cannot take still pictures.
C1 C2 C3	Custom Mode (P86) Use this mode to take pictures with previously registered settings.
	Creative Control Mode (P33) Record while checking the image effect.

Rear Dial/Front Dial



Rotating:

Selection of items or setting of values is performed during the various settings.

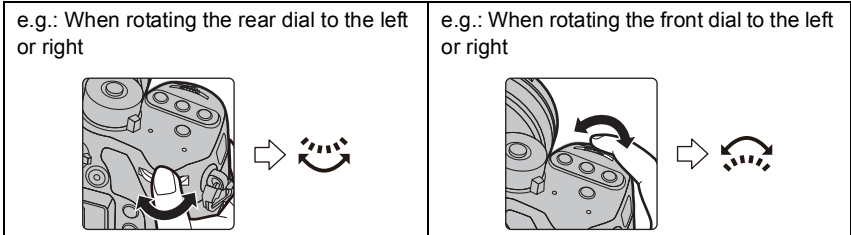
- This Owner's Manual describe operations of the rear dial/front dial as follows:



Allows you to set the aperture, shutter speed, and other settings when in **P / A / S / M** modes.

Mode dial	 Rear Dial	 Front dial
P (P51)	Program Shift	Program Shift
A (P52)	Aperture value	Aperture value
S (P52)	Shutter speed	Shutter speed
M (P52)	Shutter speed	Aperture value

- In [Dial Set.] in the [Custom] menu, you can change the operation methods of the front dial and rear dial. (P104)

Control Dial

Rotating the control dial:

Selection of items or setting of values etc., is performed.

- The operation of rotating the control dial is illustrated as below in This Owner's Manual.

Example: When rotating the control dial to the left or right: 

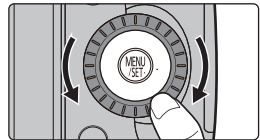

Cursor buttons/[MENU/SET] button

Pressing the cursor button:

Selection of items or setting of values etc., is performed.

Pressing [MENU/SET]:

Confirmation of setting contents, etc., is performed.

- This Owner's Manual express the up, down, left, and right of the cursor button as ▲/▼/◀/▶.

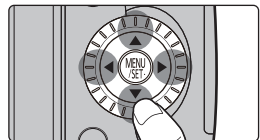

Even when the camera is operated using the touch screen, it is possible to operate with the cursor button and [MENU/SET] button if a guide like the one shown on the right is displayed.



Even on menu screens etc. on which the guide is not displayed, you can make settings and selections by operating the buttons.

- By assigning [Cursor Button Lock] to a function button, you can disable the cursor buttons, the [MENU/SET] button, and the control dial. (P85)

[DISP.] button (Switching the displayed information)

Press [DISP.] to switch the information displayed on the screen.

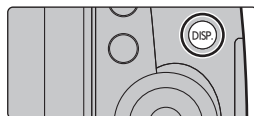

In Recording Mode

- Screen will switch as follows:
(Example of monitor display)

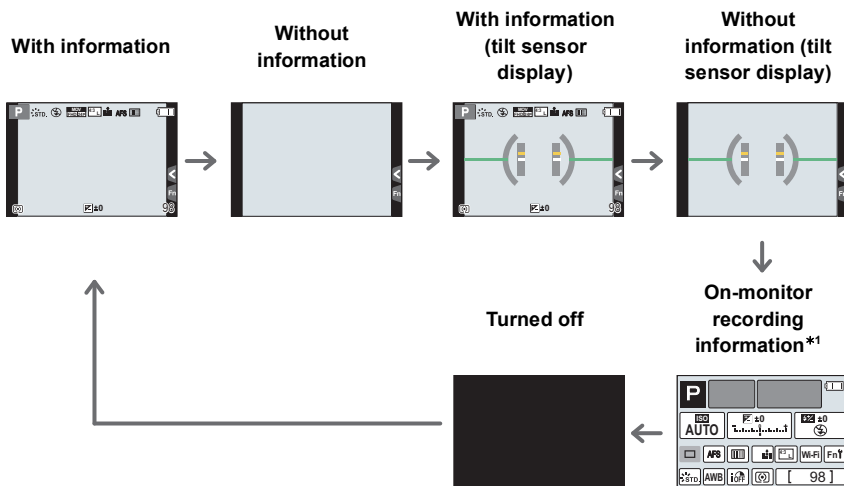

- ※ 1 It is displayed when the [Monitor Info. Disp.] of the [Custom] menu is set to [ON]. (P103)
Settings can be adjusted directly by touching each of the items displayed on the screen.

- If you set [Guide Line] in the [Custom] menu, the guide lines are displayed. (P103)
- If no operation is performed, part of the information on the screen will gradually become darker after approximately 10 seconds has passed, and will no longer be displayed after approximately 1 minute has passed. Pressing the [DISP.] button or touching the monitor will make the display reappear. This operation is to prevent screen burn-in and is not a malfunction.

In Playback Mode

- Screen will switch as follows:

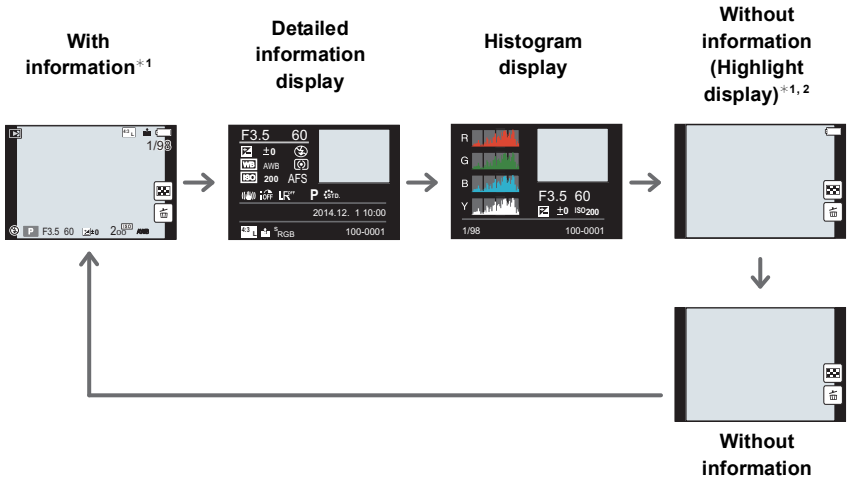

- *1 If no operation is performed, part of the information on the screen will gradually become darker after approximately 10 seconds has passed, and will no longer be displayed after approximately 1 minute has passed. Pressing the [DISP.] button or touching the monitor will make the display reappear. This operation is to prevent screen burn-in and is not a malfunction.
- *2 This is displayed if [Highlight] (P103) in the [Custom] menu is set to [ON].

[LVF] button (Switching the Monitor/Viewfinder)

Press [LVF] to switch between the Monitor and Viewfinder.

Ⓐ Eye sensor

Press [LVF].

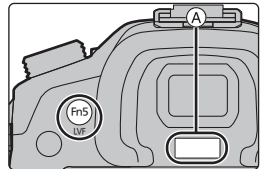

- The monitor/viewfinder will switch as follows:

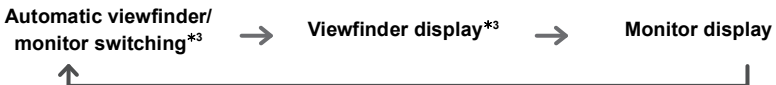

- *3 If [Eye Sensor AF] in the [Custom] menu is set to [ON], the camera automatically adjusts the focus as the eye sensor is activated. (P102)

■ Using the eye sensor to switch between the Monitor and Viewfinder

Automatic viewfinder/monitor switching enables the eye sensor to switch the display to the viewfinder automatically when you bring your eye or an object near it.

- When the viewfinder surface becomes dirty, remove the eyecup, blow away the dust with a blower (commercially available), and wipe the surface lightly with a dry, soft cloth.

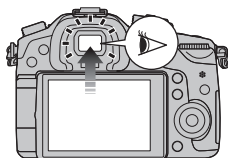

Touch panel (Touch operations)

Touch panel of this unit is capacitive. Touch the panel directly with your bare finger.

■ Touch

To touch and release the touch screen.

- When selecting features using the touch screen, be sure to touch the center of the desired icon.



■ Drag

A movement without releasing the touch screen.

This can also be used to move to the next image during playback, etc.

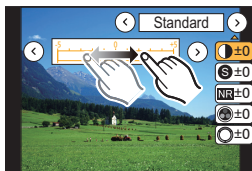

■ Pinch (enlarge/reduce)

Pinch the touch panel apart (enlarge) or together (reduce) with two fingers.

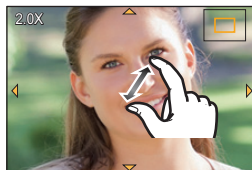

Optical Image Stabilizer

The camera detects jitter during recording and automatically corrects it, so you can record images with reduced jitter.

A lens which supports the stabilizer function is required.

– The interchangeable lens (H-HS12035) supports the stabilizer function.



• When using an interchangeable lens with O.I.S. switch (such as H-HS12035), stabilizer function is activated if the O.I.S. switch of the lens is set to [ON]. ([) is set at the time of purchase)

■ Setting the Stabilizer in the [Rec] menu

1 Select the menu. (P28)

MENU →  [Rec] → [Stabilizer]

2 Press to select the item and then press [MENU/SET].

 ([Normal])	Vertical and horizontal shake are compensated for.
 ([Panning])	Camera shake is corrected for up/down movements. This mode is ideal for panning (a method of taking pictures which involves turning the camera to track the movements of a subject which continues to move in a fixed direction).
[OFF]	[Stabilizer] does not work.

• Exit the menu after it is set.

Calling frequently-used menus instantly

(Quick Menu)

By using the Quick Menu, some of the menu settings can be easily found.

• The features that can be adjusted using Quick Menu are determined by the mode or a display style the camera is in.

1 Press [Q.MENU] to display the Quick Menu.

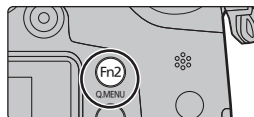

2 Rotate the front dial to select the menu item.

3 Rotate the rear dial to select the setting.

4 Press [Q.MENU] to exit the menu once the setting is complete.

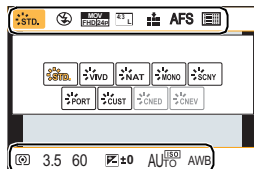

Setting menu items

1 Press [MENU/SET].

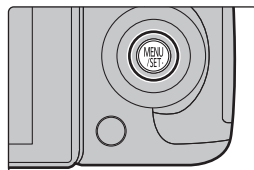

[Rec] (P99)	This menu lets you set the aspect ratio, number of pixels and other aspects of the pictures you are recording.
[Motion Picture] (P101)	This menu lets you set the [Rec Format], [Rec Quality], and other aspects for motion picture recording.
[Custom] (P102)	Operation of the unit, such as displaying of the screen and button operations, can be set up according to your preferences. Also, it is possible to register the modified settings.
[Setup] (P104)	This menu lets you perform the clock settings, select the operating beep tone settings and set other settings which make it easier for you to operate the camera. You can also configure the settings of Wi-Fi related functions.
[Playback] (P106)	This menu lets you set the Protection, Cropping or Print Settings, etc. of recorded pictures.

2 Press ▲/▼ of the cursor button to select the menu item and press [MENU/SET].

3 Press ▲/▼ of the cursor button to select the setting and press [MENU/SET].

- Depending on the menu item, its setting may not appear or it may be displayed in a different way.



■ Close the menu

Press [⏪/⏩] or press the shutter button halfway.

■ Switching to other menus

e.g.: Switching to the [Setup] menu from [Rec] menu.

1 Press ◀.

2 Press ▲/▼ to select [⚙️] or another of the menu toggle icons.

- You can also select the menu toggle icons by rotating the front dial.

3 Press [MENU/SET].

- Select a menu item next and set it.



Configuring basic settings of this unit (Setup Menu)

The [Setup] menu contains some important settings relating to the camera's clock and power. Check the settings of this menu before proceeding to use the camera. (P104)

Formatting the card (initialization)

Format the card before recording a picture with this unit.

Since data cannot be recovered after formatting, make sure to back up necessary data in advance.

Select the menu. (P28)

MENU →  **[Setup]** → **[Format]**

- Confirmation screen is displayed. It is executed when [Yes] is selected.

Restoring the default settings ([Reset])

The recording or setup/custom settings are reset to the default.

Select the menu. (P28)

MENU →  **[Setup]** → **[Reset]**

- Confirmation screens are displayed in the sequence of the [Rec] settings and the [Setup]/[Custom] settings. It is executed when [Yes] is selected.
- The folder number and the clock setting are not changed.

Conserving the battery life ([Economy])

The unit can be set up to prevent unnecessary battery consumption.

Select the menu. (P28)

MENU →  **[Setup]** → **[Economy]**

[Sleep Mode]	The camera is automatically turned off if the camera has not been used for the time selected on the setting. [10MIN.]/[5MIN.]/[2MIN.]/[1MIN.]/[OFF]
[Auto LVF/Monitor Off]	The monitor/viewfinder is automatically turned off if the camera has not been used for the time selected on the setting. [5MIN.]/[2MIN.]/[1MIN.]

- Press the shutter button halfway or turn the camera off and on to cancel [Sleep Mode].
- To turn the monitor/viewfinder on again, press any button or touch the monitor.

Taking Pictures using the Automatic Function (Intelligent Auto Mode)

Recording Mode:  



In this mode, the camera makes the optimal settings for the subject and scene, so we recommend it when you wish to leave the settings to the camera and record without thinking about them.

The camera detects scenes automatically (Scene Detection) ( : When taking pictures,  : When recording motion pictures)



[i-Portrait]



[i-Scenery]



[i-Macro]

[i-Night Portrait]*¹

[i-Night Scenery]

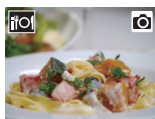
[iHandheld Night Shot]*²

[i-Food]

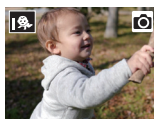
[i-Baby]*³

[i-Sunset]



[i-Low Light]



iA

*1 Only displayed when the built-in flash is open.

*2 Only displayed when [iHandheld Night Shot] is set to [ON]. (P31)

*3 When [Face Recog.] is set to [ON],  will be displayed for birthdays of registered faces already set only when the Face/Eye of a person 3 years old or younger is detected.

•  is set if none of the scenes are applicable, and the standard settings are set.

1 Set the mode dial to .

- The camera will switch to either the most recently used of Intelligent Auto Mode or Intelligent Auto Plus Mode. At the time of purchase, the mode is set to Intelligent Auto Plus Mode. (P31)

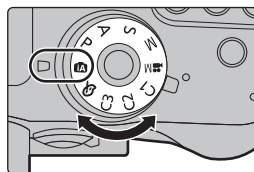

2 Align the screen with the subject.

- When the camera identifies the optimum scene, the icon of the scene concerned is displayed in blue for 2 seconds, after which its color changes to the usual red. (Automatic scene detection)

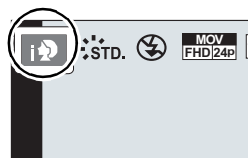

■ Functions that work automatically

• The following functions are performed automatically to allow the camera to make the optimal settings.

– Scene Detection	– [i.Resolution]
– Backlight Compensation	– [i.Dynamic]
– [Face/Eye Detection]	– [Long Shtr NR]
– Auto White Balance	– [Shading Comp.]
– Intelligent ISO sensitivity control	– [Quick AF]
– [Red-Eye Removal]	– [AF Assist Lamp]

■ Auto Focus, Face/Eye Detection, and Face Recognition

The Auto Focus Mode is automatically set to [i.AF]. If you touch the subject, the AF tracking function will work. The AF tracking function will also work if you press [i.AF] and then press the shutter button halfway.

• When [i.D], [i.F], or [i.A] is set, an eye closer to the camera will be in focus, while the exposure will be optimized for the face. In Intelligent Auto Plus Mode or Intelligent Auto Mode, you cannot change the eye in focus. ([Face/Eye Detection])

■ About the flash

Flash mode is set to [i.FL] when the flash is closed, and [i.A] (AUTO) when it is open.

When the flash is open, the camera automatically sets [i.A], [i.FL] (AUTO/Red-Eye Reduction), [i.FL] or [i.FL] to match the type of subject and brightness.

• Open the flash when the flash is to be used. (P57)

■ Switching between Intelligent Auto Plus Mode and Intelligent Auto Mode

The Intelligent Auto Mode adjusts the settings of the main functions automatically, allowing you to record images without having to make advanced settings. When you want to record images easily, use Intelligent Auto Mode.

- 1 Press [MENU/SET].
- 2 Press ◀.
- 3 Press ▲/▼ to select the [i.A+] or [i.A] tab.
- 4 Press ◀/▶ to select [i.A+] or [i.A] and then press [MENU/SET].
 - If [DISP.] is pressed, the description of the selected mode will be displayed.



Recording night scenes ([iHandheld Night Shot])

When [iHandheld Night Shot] is set to [ON] and [i.A] is detected while taking handheld night shots, pictures of the night scenery will be taken at a high burst speed and composed into a single picture.

This mode is useful if you want to take stunning night shots with minimal jitter and noise, without using a tripod.

MENU → [Rec] → [iHandheld Night Shot] → [ON]/[OFF]

Combining pictures into a single picture with rich gradation ([iHDR])

When [iHDR] is set to [ON] and there is, for example, strong contrast between the background and the subject, multiple still pictures are recorded with differing exposures and combined to create a single still picture rich in gradation.

[iHDR] works automatically as needed. When it does, [HDR] is displayed on the screen.

MENU →  **[Rec]** → **[iHDR]** → **[ON]/[OFF]**

Taking a picture with a blurred background (Defocus Control)

Recording Mode:  



You can easily set the blurriness of the background while checking the screen.

- 1 Press **[Fn4]** to display the setting screen.
- 2 Set the blurriness by rotating the rear dial.
 - If you press **[MENU/SET]**, you can return to the recording screen.
 - Pressing **[Fn4]** on the blurriness setting screen will cancel the setting.

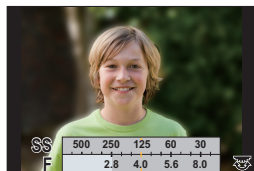

Recording images by changing the brightness or color tone

Recording Mode: 



This mode enables you to change the brightness and color tone to your preferred settings from the ones set by the camera.

Setting brightness

- 1 Press **[]**.
- 2 Rotate the rear dial to adjust brightness.
 - Press **[]** again to return to the recording screen.



Setting color

- 1 Press **[WB]**.
- 2 Rotate the rear dial to adjust color.
 - This will adjust the color of the image from a reddish color to a bluish color.
 - Press **[WB]** again to return to the recording screen.



Taking Pictures with different image effects

(Creative Control Mode)

Recording Mode: 



This mode records with additional image effects.

You can set the effects to add by selecting example images and checking them on the screen.

1 Set the mode dial to .

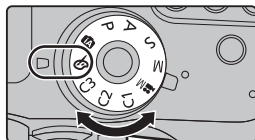

2 Press $\blacktriangle/\blacktriangledown$ to select the image effects (filters).

[Expressive]	[High Dynamic]
[Retro]	[Cross Process]
[Old Days]	[Toy Effect]
[High Key]	[Toy Pop]
[Low Key]	[Bleach Bypass]
[Sepia]	[Miniature Effect]
[Monochrome]	[Soft Focus]
[Dynamic Monochrome]	[Fantasy]
[Rough Monochrome]	[Star Filter]
[Silky Monochrome]	[One Point Color]
[Impressive Art]	[Sunshine]

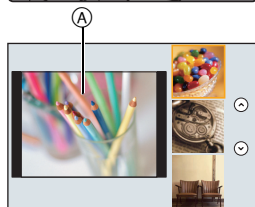

- The image effect of the selected example image will be applied in a preview display (A).
- You can also select the image effects (filters) by touching the example images.

3 Press [MENU/SET] to set.

■ Switching the image effect (filter) selection screen display

Press [DISP.] to switch the monitor screen.

- When the image effect selection screen display is set to the guide display, description of the selected image effect is displayed.

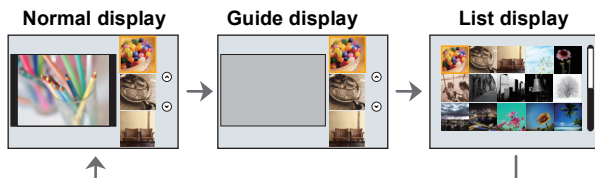

- To change Creative Control Mode, select the  tab on the menu screen, select [Filter Switch], and then press [MENU/SET]. You can return to step 2.

Taking Pictures Using the Touch Function

Taking pictures using the Touch Shutter function

Applicable modes:



Just by touching the subject you want as your point of focus, the camera will focus on the subject and take the picture automatically.

1 Touch [].



2 Touch [].

- Icon will change to [], and taking a picture with the Touch Shutter function becomes possible.



3 Touch the subject you wish to focus on, and then take a picture.

- The picture is taken when the focus is achieved.

■ To cancel the Touch Shutter function

Touch [].

Easily Optimizing the Brightness for a Specified Area (Touch AE)

Applicable modes:   P A S M  C1 C2 C3 



You can easily optimize the brightness for a touched position. When the face of the subject appears dark, you can brighten the screen according to the brightness of the face.

1 Touch [].

2 Touch [].

- The setting screen for the brightness optimization position is displayed.



3 Touch the subject you want to optimize the brightness for.

- Touching [Reset] will bring the brightness optimization position back to the center.



4 Touch [Set].

■ Canceling the Touch AE function

Touch [].

Taking Pictures with Auto Focus

Applicable modes:

By setting the optimum Focus Mode or Auto Focus Mode for the subject or recording condition, you can let the camera automatically adjust focus in various scenes.



Selecting the Focus Mode (AFS/AFF/AFC)

Applicable modes:

The method for achieving focus when the shutter button is pressed halfway is set.

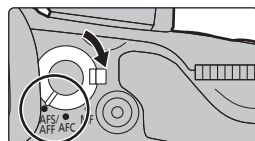
Set the focus mode lever to **[AFS/AFF]** or **[AFC]**.



Item		The movement of the subject and the scene (recommended)/Description of settings
[AFS/AFF]	[AFS] (Auto Focus Single)	Subject is still (Scenery, anniversary photograph, etc.) Focus is set automatically when the shutter button is pressed halfway. Focus will be fixed while it is pressed halfway. 
	[AFF] (Auto Focus Flexible)	Movement cannot be predicted (Children, pets, etc.) In this mode, focusing is performed automatically when the shutter button is pressed halfway. If the subject moves while the shutter button is pressed halfway, the focus is corrected to match the movement automatically. 
[AFC] (Auto Focus Continuous)	Subject is moving (Sport, trains, etc.) In this mode, while the shutter button is pressed halfway, focusing is constantly performed to match the movement of the subject. When the subject is moving, the focusing is performed by predicting the subject position at the time of recording. (Movement prediction) 	
[MF]		Set the focus manually. (P40)

■ About [AFS/AFF] of the focus mode lever

In [AFS/AFF] in the [Rec] menu or the [Motion Picture] menu, you can assign [AFS] or [AFF] to [AFS/AFF] of the focus mode lever.

Selecting the Auto Focus Mode

Applicable modes:

This allows the focusing method that suits the positions and number of the subjects to be selected.

1 Press [].

2 Press to select AF Mode and then press [MENU/SET].

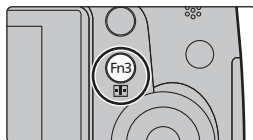

<p>([Face/Eye Detection])</p>	<p>The camera automatically detects the person's face and eyes.</p> <p>An eye closer to the camera will be in focus, while the exposure will be optimized for the face. (When [Metering Mode] is set to [])</p> <ul style="list-style-type: none"> • Up to 15 faces can be detected. Eyes that can be detected are only those of the face that is in focus. • You can change the eye to be in focus. (P38) • Position and size of the AF area can be changed. (P38) 	
<p>([Tracking])</p>	<p>The camera focuses on the subject you specify. The exposure will be optimized for the subject. (When [Metering Mode] is set to [].)</p> <p>Focus and exposure will keep on following the subject even if it moves. (Dynamic tracking) (P38)</p>	
<p>([49-Area])</p>	<p>Up to 49 AF areas can be focused.</p> <p>This is effective when a subject is not in the center of the screen.</p> <ul style="list-style-type: none"> • You can select areas to be in focus. (P39) 	
<p>([Custom Multi])</p>	<p>From among 49 AF areas, you can freely set the optimum shape of the AF area for the subject.</p> <p>Please also refer to the "Owner's Manual for advanced features (PDF format)", which describes more detailed information.</p>	
<p>([1-Area])</p>	<p>The camera focuses on the subject in the AF area on the center of the screen.</p> <ul style="list-style-type: none"> • Position and size of the AF area can be changed. (P38) 	
<p>([Pinpoint])</p>	<p>You can achieve a more precise focus on a point that is smaller than [].</p> <p>If you press the shutter button halfway, the screen that lets you check the focus will be enlarged.</p> <ul style="list-style-type: none"> • The focus position can be set on an enlarged screen. <p>Please also refer to the "Owner's Manual for advanced features (PDF format)", which describes more detailed information.</p>	

■ Changing the eye to be in focus Touch the eye to be in focus.

- Touch the eye in the yellow frame. If you touch any other location, the AF area setting screen will be displayed. (P38)
- If you touch [AF] or press [MENU/SET], the eye focus setting will be canceled.



■ Locking the subject to be tracked (Tracking) Aim the AF tracking frame over the subject, and press the shutter button halfway.

Ⓐ AF tracking frame

- AF area will turn green when the camera detects the subject.
- The AF area turns yellow when the shutter button is released.
- Lock is canceled when [MENU/SET] is pressed.

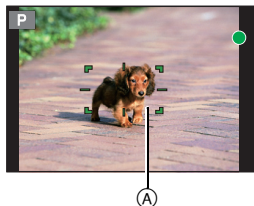

Setting up position of the AF area/changing size of the AF area

Applicable modes: P A S M



When [face], [eye], [square], or [plus] in Auto Focus Mode is selected, you can change the position and size of the AF area.

Please also refer to the "Owner's Manual for advanced features (PDF format)", which describes more detailed information.

When selecting [face], [square]

Position and size of the AF area can be changed.



- 1 Press [AF].
- 2 Select [face] or [square] and press ∇ .
 - AF area setting screen is displayed.
 - You can also display the AF area setting screen by touching the screen.
- 3 Change the position and size of the AF area.



Button operation	Touch operation	Description of operation
	Touching	Moves the AF area.
	Pinching in/out	Enlarges/reduces the AF area in small steps.
	—	Enlarges/reduces the AF area in large steps.
[DISP.]	[Reset]	Resets the AF area back to the center. • If you press the button again, the frame size will be reset to the default setting.

- If you set the AF area over an eye in the yellow frame when [face] is selected, the eye to be in focus will be changed. (P38)

4 Press [MENU/SET] to set.

- AF area with the same function as  is displayed in the touched position, when the  is selected. Setting of the AF area is cleared when [MENU/SET] is pressed or  is touched.

When selecting 

The 49 AF areas are divided into groups, each consisting of 9 areas (on the edge of the screen, 6 or 4 areas).

1 Press .**2 Select  and press \blacktriangledown .**

- AF area setting screen is displayed.

3 Press $\blacktriangle/\blacktriangledown/\blacktriangleleft/\blacktriangleright$ to select an AF area group.

- You can also select a group by touching the screen.

4 Press [MENU/SET] to set.

- Only [+] display (center point of selected group) will remain on the screen.
- Setting of the AF area frame is cleared when [MENU/SET] is pressed or  is touched.

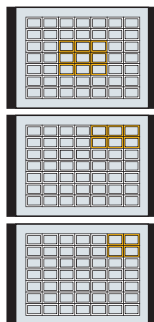
Examples of group**Setting the AF area position with the Touch Pad**

Applicable modes:          





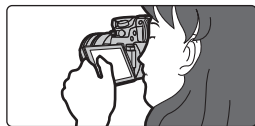

By setting [Touch Pad AF] in [Touch Settings] (P104) in the [Custom] menu, you can move the AF area displayed on the viewfinder by touching the monitor.

- If you touch the monitor when the Auto Focus Mode is set to [Custom Multi] such as , the AF area setting screen will be displayed.

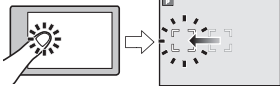
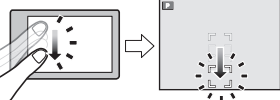

MENU →  [Custom] → [Touch Settings] → [Touch Pad AF]

[EXACT]	Moves the AF area of the Viewfinder by touching a desired position on the Touch Pad.	
[OFFSET]	Moves the AF area of the viewfinder according to the distance you drag the touch pad (P26).	
[OFF]	—	

- Press the shutter button halfway to determine the focus position. If you press [DISP.] before determining the focus position, the AF area frame returns to the center position.
- To cancel the AF area frame when the Auto Focus Mode (P36) is set to  ([Face/Eye Detection]),  ([Tracking]) or  ([49-Area]), press [MENU/SET].

Taking Pictures with Manual Focus

Applicable modes:



Use this function when you want to fix the focus or when the distance between the lens and the subject is determined and you do not want to activate Auto Focus.

When using the interchangeable lens (H-HS12035) having a focus ring

Rotate to **A** side:

Focuses on nearby subject

Rotate to **B** side:

Focuses on faraway subject

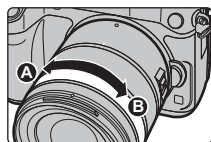

1 Set the focus mode lever to [MF].

2 Press [].

3 Press /// to determine the area to be enlarged, and press [MENU/SET].

- The assist screen is displayed, enlarging the area. (MF Assist) (P103)
- If you press [DISP.], the area to be enlarged will be reset to the center.

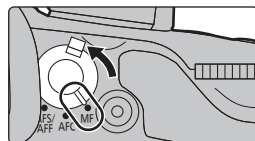

4 Adjust the focus.

- (A) Indicator for ∞ (infinity)
- (B) MF Assist (enlarged screen)
- (C) Peaking
- (D) MF Guide

- The in-focus portions will be highlighted. (Peaking) (P103)
- You can check whether the point of focus is to the near side or to the far side. (MF Guide) (P103)

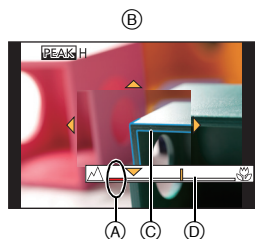

You can perform the following operations:

Button operation	Touch operation	Description of operation
	Dragging	Moves the enlarged area
	Pinching in/out	Enlarges/reduces the screen (by steps of 0.1×)
	—	Enlarges/reduces the screen (by steps of 1.0×)
		Switches the enlarged display (windowed/full screen)
[DISP.]	[Reset]	Resets the area to be enlarged back to the center.

5 Press the shutter button halfway.

- The assist screen will close. The recording screen will be displayed.
- You can also close the assist screen by pressing [MENU/SET].

Select a Drive Mode

Applicable modes:



You can change what the camera will do when you press the shutter button.

Rotating the drive mode dial.

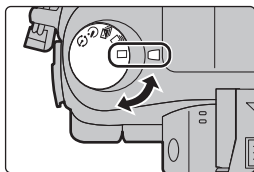

[Single]	When the shutter button is pressed, only one picture is recorded.
[Burst] (P41)	Recordings are made in succession while the shutter button is pressed.
[Auto Bracket] (P42)	Each time the shutter button is pressed, recordings are made with different exposure settings according to the Exposure Compensation range.
[Self Timer] (P42)	When the shutter button is pressed, recording takes place after the set time has elapsed.
[Time Lapse/ Animation] (P43, 45)	Pictures are recorded with Time Lapse Shot or Stop Motion Animation.

Taking Pictures using Burst Mode

Applicable modes:



• Pictures taken with a burst speed of [SH] will be recorded as a single burst group.

1 Set the drive mode dial to .

2 Focus on the subject and take a picture.

• Hold down the shutter button fully to activate the Burst Mode.



■ Changing the burst speed

1 Select the menu. (P28)

MENU → [Rec] → [Burst Rate]

2 Press / to select the burst speed and then press **[MENU/SET]**.

	[SH] [*] (Super high speed)	[H] (High speed)	[M] (Middle speed)	[L] (Low speed)
Burst speed (pictures/second)	40	12 (AFS) 7 (AFC)	7	2
Live View during Burst Mode	None	None	Available	Available

* The electronic shutter will operate.

Taking Pictures using Auto Bracket

Applicable modes: **P** **A** **S** **M** **C1** **C2** **C3**



1 Set the drive mode dial to [].

2 Focus on the subject and take a picture.

- If you press and hold the shutter button, the number of pictures that you set is taken.
- The Auto Bracket indication blinks until the number of pictures that you set is taken.



■ Changing the settings for [Single/Burst Settings], [Step] and [Sequence] in Auto Bracket

1 Select the menu. (P28)

MENU → [Rec] → [Auto Bracket]

2 Press **▲/▼** to select [Single/Burst Settings], [Step] or [Sequence] and then press **[MENU/SET]**.

3 Press **▲/▼** to select the setting and then press **[MENU/SET]**.

- Exit the menu after it is set.

Taking Pictures with the Self-timer

Applicable modes: **iA** **iAF** **P** **A** **S** **M** **C1** **C2** **C3**



1 Set the drive mode dial to [].

2 Press the shutter button halfway to focus and then press it fully to take the picture.

- Focus and exposure will be set when the shutter button is pressed halfway.
- After the self-timer indicator flashes, recording starts.

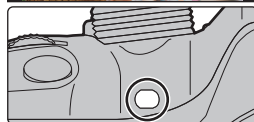

■ Changing the time setting for the self-timer

1 Select the menu. (P28)

MENU → [Rec] → [Self Timer]

2 Press **▲/▼** to select the mode and then press **[MENU/SET]**.

	Picture is taken 10 seconds after shutter is pressed.
	After 10 seconds the camera takes 3 pictures at about 2 seconds intervals.
	Picture is taken 2 seconds after shutter is pressed.
	• When using a tripod, etc., this setting is a convenient way to avoid the jitter caused by pressing the shutter button.

- Exit the menu after it is set.

Taking Pictures Automatically at Set Intervals

([Time Lapse Shot])

Applicable modes:



If you set the start time of recording, the recording interval and the number of pictures, the camera can automatically take pictures of subjects such as animals or plants as time elapses and create a motion picture.

• **Set the date and time settings in advance. (P19)**

• Pictures taken with Time Lapse Shot are displayed as a set of group pictures.

1 Set the drive mode dial to [].

2 Press [MENU/SET].

- The screen selected with [Time Lapse/Animation] in the recording menu will be displayed. (The screen will be displayed only when you press [MENU/SET] for the first time after switching the drive mode dial to []. In other cases, the camera operates as usual, displaying the menu screen.)

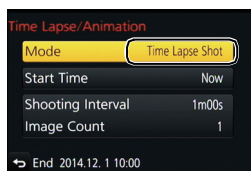

3 Press [MENU/SET].

4 Select [Mode] with $\blacktriangle/\blacktriangledown$, and then press [MENU/SET].

5 Select [Time Lapse Shot] with $\blacktriangle/\blacktriangledown$, and then press [MENU/SET].

6 Press $\blacktriangle/\blacktriangledown$ to select the item and then press [MENU/SET].

	[Now]	Starts the recording by fully-pressing the shutter button.
[Start Time]	[StartTime Set]	You can set the time to start recording. Any time up to 23 hours 59 minutes ahead can be set. Select the item (hour or minute) by pressing $\blacktriangle/\blacktriangleright$, set the start time by pressing $\blacktriangle/\blacktriangledown$, and then press [MENU/SET].
[Shooting Interval]/ [Image Count]		The recording interval and the number of pictures can be set. $\blacktriangle/\blacktriangleright$: Select the item (minute/second/number of pictures) $\blacktriangle/\blacktriangledown$: Setting [MENU/SET]: Set

7 Press the shutter button halfway.

- The recording screen will be displayed. You can also perform the same operation by pressing and holding [/] until the recording screen is displayed.



8 Press the shutter button fully.

- The recording starts automatically.
- During recording standby, the power will turn off automatically if no operation is performed for a certain period. The Time Lapse Shot is continued even with the power turned off. When the recording start time arrives, the power turns on automatically.
To turn on the power manually, press the shutter button halfway.
- If [Fn1] is pressed or [⏏] is touched while this unit is turned on, a selection screen asking you to pause or end will be displayed. Operate in accordance with the screen. Also, if [Fn1] is pressed or [⏏] is touched during the pause, a selection screen asking you to resume or end will be displayed. Pressing the shutter button fully will also enable you to resume from the pause.
- Confirmation screen for creating a motion picture is displayed next, so select [Yes].

9 Select the methods for creating a motion picture.

- The recording format is set to [MP4].

[Rec Quality]	Sets the quality of a motion picture.
[Frame Rate]	Sets the number of frames per second. The larger the number is, the smoother the motion picture will be.
[Sequence]	[NORMAL]: Splices pictures together in recording order. [REVERSE]: Splices pictures together in reverse recording order.

10 Select [OK] with ▲/▼, and then press [MENU/SET].

- Confirmation screen is displayed. It is executed when [Yes] is selected.

■ Changing the Time Lapse Shot settings

You can change the settings in [Time Lapse/Animation] in the [Rec] menu.

Creating Stop Motion Pictures ([Stop Motion Animation])

Applicable modes: P A S M C1 C2 C3



A stop motion picture is created by splicing pictures together.

• **Set the date and time settings in advance. (P19)**

• Pictures taken with [Stop Motion Animation] are displayed as a set of group pictures.

1 Set the drive mode dial to [].

2 Press [MENU/SET].

- The screen selected with [Time Lapse/Animation] in the recording menu will be displayed. (The screen will be displayed only when you press [MENU/SET] for the first time after switching the drive mode dial to []. In other cases, the camera operates as usual, displaying the menu screen.)

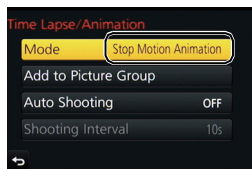

3 Press [MENU/SET].

4 Select [Mode] with $\blacktriangle/\blacktriangledown$, and then press [MENU/SET].

5 Select [Stop Motion Animation] with $\blacktriangle/\blacktriangledown$, and then press [MENU/SET].

6 Press $\blacktriangle/\blacktriangledown$ to select the recording method, and then press [MENU/SET].

[Auto Shooting]	[ON]	Takes pictures automatically at a set recording interval. When the shutter button is pressed fully, recording starts.
	[OFF]	This is for taking pictures manually, frame by frame.
[Shooting Interval]	<p>(Only when [Auto Shooting] is set to [ON]) Sets the interval for automatic recording. A value between 1 and 60 seconds can be set in 1 second intervals. Press $\blacktriangle/\blacktriangledown$ to select the recording interval (seconds), press $\blacktriangle/\blacktriangledown$ to set it, and press [MENU/SET].</p>	

7 Press the shutter button halfway.

- The recording screen will be displayed. You can also perform the same operation by pressing and holding until the recording screen is displayed.



8 Press the shutter button fully.

9 Move the subject to decide on the composition.

- Repeat recording in the same way.
- If the camera is turned off during recording, a message for resuming the recording is displayed when the camera is turned on. Selecting [Yes] allows you to resume the recording from the interruption point.

10 Touch [] to end the recording.

- It can also be ended by selecting [Time Lapse/Animation] from the [Rec] menu and then pressing [MENU/SET].
- When [Auto Shooting] is set to [ON], select [End] on the confirmation screen.
(If [Pause] has been selected, press the shutter button fully to resume the recording.)
- Confirmation screen is displayed. It is ended when [Yes] is selected.
- Confirmation screen for creating a motion picture is displayed next, so select [Yes].

**11 Select the methods for creating a motion picture.**

- The recording format is set to [MP4].

[Rec Quality]	Sets the quality of a motion picture.
[Frame Rate]	Sets the number of frames per second. The larger the number is, the smoother the motion picture will be.
[Sequence]	[NORMAL]: Splices pictures together in recording order. [REVERSE]: Splices pictures together in reverse recording order.

12 Press ▲/▼ to select [OK] and then press [MENU/SET].

- Confirmation screen is displayed. It is executed when [Yes] is selected.

■ Changing the settings of Stop Motion Animation

You can change the settings in [Time Lapse/Animation] in the [Rec] menu.

■ Adding pictures to the Stop Motion Animation group

Selecting [Add to Picture Group] in step 6 will display group pictures recorded with [Stop Motion Animation].

Select a set of group pictures, press [MENU/SET], and then select [Yes] on the confirmation screen.

Setting the Picture Quality and Size

Setting the aspect ratio of pictures

Applicable modes: **P** **A** **S** **M** **C1** **C2** **C3**



This allows you to select the aspect ratio of the pictures to suit printing or the playback method.

MENU → **[Rec]** → **[Aspect Ratio]**

[4:3]	[Aspect Ratio] of a 4:3 TV
[3:2]	[Aspect Ratio] of a 35 mm film camera
[16:9]	[Aspect Ratio] of a high-definition TV, etc.
[1:1]	Square aspect ratio

- The ends of the recorded pictures may be cut at printing so check before printing.

Setting the number of pixels

Applicable modes: **P** **A** **S** **M** **C1** **C2** **C3**



Set the number of pixels. The higher the numbers of pixels, the finer the detail of the pictures will appear even when they are printed onto large sheets.

MENU → **[Rec]** → **[Picture Size]**

When the aspect ratio is [4:3].

Settings	Image size
[L] (16M)	4608×3456
[EXM] (8M)	3264×2448
[EXS] (4M)	2336×1752

When the aspect ratio is [3:2].

Settings	Image size
[L] (14M)	4608×3072
[EXM] (7M)	3264×2176
[EXS] (3.5M)	2336×1560

When the aspect ratio is [16:9].

Settings	Image size
[L] (12M)	4608×2592
[EXM] (8M)	3840×2160
[EXS] (2M)	1920×1080

When the aspect ratio is [1:1].

Settings	Image size
[L] (12M)	3456×3456
[EXM] (6M)	2448×2448
[EXS] (3M)	1744×1744

- When [Ex. Tele Conv.] (P100) is set, **[EX]** is displayed on the picture sizes of each aspect ratio except for [L].
- The picture size will be fixed to [S] when [Burst Rate] is set to [SH].

Setting the compression rate of pictures ([Quality])

Applicable modes: **P** **A** **S** **M** **C1** **C2** **C3**



Set the compression rate at which the pictures are to be stored.

MENU → **[Rec]** → **[Quality]**

Settings	File format	Description of settings
	JPEG	A JPEG image in which image quality was given priority.
		A standard image quality JPEG image. This is useful for increasing the number of shots without changing the number of pixels.
	RAW+JPEG	You can record a RAW image and a JPEG image (or) simultaneously.* ¹
[RAW]	RAW	You can only record RAW images.* ² [RAW] images are recorded with a smaller data volume than [RAW] or [RAW].

*1 If you delete a RAW file from the camera, the corresponding JPEG image will also be deleted.

*2 It is fixed to maximum recordable pixels ([L]) for each image aspect ratio.

Setting the Light Sensitivity

Applicable modes:   **P** **A** **S** **M**  **C1** **C2** **C3** 



This allows the sensitivity to light (ISO sensitivity) to be set. Setting to a higher figure enables pictures to be taken even in dark places without the resulting pictures coming out dark.

1 Press [ISO].



2 Select the ISO sensitivity by rotating the rear dial or the front dial.

3 Press [ISO] to set.

- You can also press the shutter button halfway to set.

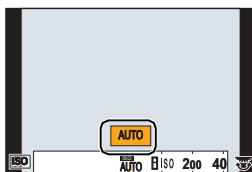

AUTO	The ISO sensitivity is automatically adjusted according to the brightness.
 ISO (Intelligent)	The camera detects movement of the subject and then automatically sets the optimum ISO sensitivity and shutter speed to suit the movement of the subject and brightness of the scene to minimize the jitter of the subject.
100*/200/400/800/1600/ 3200/6400/12800/25600	The ISO sensitivity is fixed to various settings.

- * Only available when [Extended ISO] is set.
- Setting items below will be selectable in Creative Video Mode.
 - [AUTO]/[200] to [6400]
- When [Electronic Shutter] is set to [ON], the ISO sensitivity can be set up to [ISO3200].

Adjusting the White Balance

Applicable modes:   **P** **A** **S** **M**  **C1** **C2** **C3** 



In sunlight, under incandescent lights or in other such conditions where the color of white takes on a reddish or bluish tinge, this item adjusts to the color of white which is closest to what is seen by the eye in accordance with the light source.

1 Press **[WB]**.

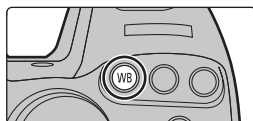

2 Rotate the rear dial or front dial to select the White Balance.



3 Press **[WB]** to set.

- You can also press the shutter button halfway to set.

[AWB]	Automatic adjustment
[☀]	When taking pictures outdoors under a clear sky
[☁]	When taking pictures outdoors under a cloudy sky
[🏠]	When taking pictures outdoors in the shade
[💡]	When taking pictures under incandescent lights
[🔆]	When taking pictures with the flash only
[🔆]/[☀]/[☁]/[🏠]	The manually set value is used
[🔆]	When using the preset color temperature setting

* It will operate as [AWB] during motion picture recording.

Taking Pictures with Your Favorite Settings

(Program AE Mode)

Recording Mode: **P**



The camera automatically sets the shutter speed and the aperture value according to the brightness of the subject.

You can take pictures with greater freedom by changing various settings in the [Rec] menu.

1 Set the mode dial to **[P]**.

2 Press the shutter button halfway and display the aperture value and shutter speed value on the screen.

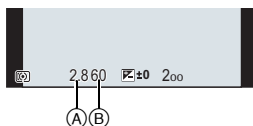

(A) Aperture value

(B) Shutter speed

- If the exposure is not adequate when the shutter button is pressed halfway, the aperture value and shutter speed turn red and blink.

Program Shift

In Program AE Mode, you can change the preset aperture value and shutter speed without changing the exposure. This is called Program Shift.

1 Press the shutter button halfway and display the aperture value and shutter speed value on the screen.

2 While the values are displayed (about 10 seconds), perform Program Shift by rotating the rear dial or front dial.

(C) Program Shift indication

- To cancel Program Shift, turn off this unit or rotate the front/rear dial until the Program Shift indication disappears.

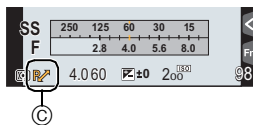

Taking Pictures by Specifying the Aperture/ Shutter Speed

Recording Mode: **A** **S** **M**



- The effects of the set aperture value and shutter speed will not be visible on the recording screen. To check on the recording screen, please use [Preview]. (P53)
- Rotate the front/rear dial to display the Exposure Meter. Unsuitable areas of the range are displayed in red.
- If the exposure is not adequate, the aperture value and the shutter speed turn red and blink when the shutter button is pressed halfway.

Aperture-Priority AE Mode

When you set the aperture value, the camera automatically optimizes the shutter speed for the brightness of the subject.

- 1 Set the mode dial to [A].
- 2 Set the aperture value by rotating the rear dial or the front dial.

(A) Aperture value

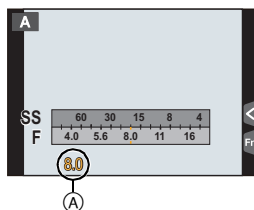

Shutter-Priority AE Mode

When you set the shutter speed, the camera automatically optimizes the aperture value for the brightness of the subject.

- 1 Set the mode dial to [S].
- 2 Set the shutter speed by rotating the rear dial or the front dial.

(B) Shutter speed

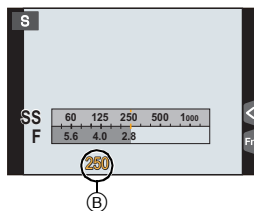

Manual Exposure Mode

Determine the exposure by manually setting the aperture value and the shutter speed. The Manual Exposure Assistance appears on the lower portion of the screen to indicate the exposure.

- 1 Set the mode dial to [M].
- 2 Rotate the rear dial to set the shutter speed, and rotate the front dial to set the aperture value.

(A) Aperture value

(B) Shutter speed

(C) Manual Exposure Assistance

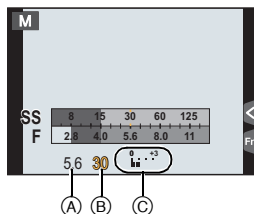

**Optimizing the ISO sensitivity for the shutter speed and aperture value**

When the ISO sensitivity is set to [AUTO], the camera sets the ISO sensitivity automatically so that the exposure will be appropriate for the shutter speed and aperture value.

**Manual Exposure Assistance**

	The exposure is adequate.
	Set to faster shutter speed or larger aperture value.
	Set to slower shutter speed or smaller aperture value.

About [B] (Bulb)

If you set the shutter speed to [B], the shutter stays open while the shutter button is pressed fully (up to about 60 minutes).

The shutter closes if you release the shutter button.

Use this when you want to keep the shutter open for a long time to take pictures of fireworks, a night scene etc.

- If you set the shutter speed to [B], [B] is displayed on the screen.
- The Manual Exposure Assistance does not appear.
- This cannot be used when [Electronic Shutter] is set to [ON].
- It can only be used with Manual Exposure Mode.

**Checking/not checking the effects of aperture and shutter speed on the recording screen**

MENU → **fC [Custom]** → **[Constant Preview]** → **[ON]/[OFF]**

- Close the flash.
- It can only be used with Manual Exposure Mode.

Confirm the Effects of Aperture and Shutter Speed (Preview Mode)

Applicable modes:

**1 Set a function button to [Preview]. (P85)**

- The following step is an example in which [Preview] is assigned to [Fn4].

2 Switch to confirmation screen by pressing [Fn4].

- Screen is switched every time [Fn4] is pressed.

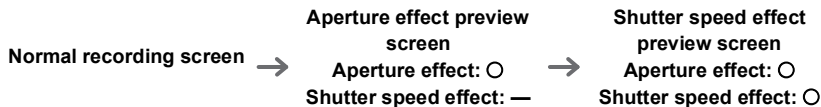

Compensating the Exposure

Applicable modes:         



Use this function when you cannot achieve appropriate exposure due to the difference in brightness between the subject and the background.

1 Press [].

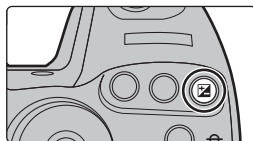

2 Rotate the rear dial or the front dial to compensate the exposure.

- When not adjusting the setting, select [± 0]

3 Press [] to set.

- You can also press the shutter button halfway to set.

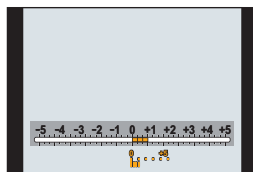

Selecting the Method for Measuring Brightness





([Metering Mode])

Applicable modes:         



Type of optical measurement to measure brightness can be changed.

MENU →  [Rec] → [Metering Mode]

<p>[] (Multiple)</p>	<p>This is the method in which the camera measures the most suitable exposure by judging the allocation of brightness on the whole screen automatically. Usually, we recommend using this method.</p>
<p>[] (Center weighted)</p>	<p>This is the method used to focus on the subject on the center of the screen and measure the whole screen evenly.</p>
<p>[] (Spot)</p>	<p>This is the method to measure the subject in the spot metering target .</p>

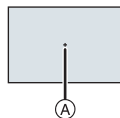

Fixing the Focus and the Exposure (AF/AE Lock)

Applicable modes:         



This is useful when you want to take a picture of a subject outside the AF area or the contrast is too strong and you cannot achieve appropriate exposure.

- 1 Align the screen with the subject.
- 2 Press and hold [AF/AE LOCK] to fix the focus or exposure.
 - If you release [AF/AE LOCK], AF/AE Lock is canceled.
 - Only the exposure is locked in the default setting.
- 3 While pressing [AF/AE LOCK], move the camera as you compose the picture and then press shutter button fully.

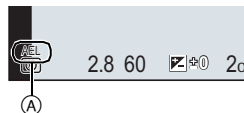
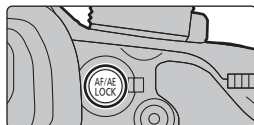

(A) AE Lock indication

- When [AE LOCK] is set, after pressing the shutter button halfway to focus, press the shutter button fully.

Setting the functions of [AF/AE LOCK]

MENU →  [Custom] → [AF/AE Lock]

[AE LOCK]	Only the exposure is locked. • When the exposure is set, [AEL], the aperture value, and the shutter speed are displayed.
[AF LOCK]	Only the focus is locked. • When the subject is focused, [AFL], the focus indication, the aperture value, and the shutter speed are displayed.
[AF/AE LOCK]	Both focus and exposure are locked. • [AFL], [AEL], the focus indication, aperture value and shutter speed are displayed when the focus and the exposure are optimized.
[AF-ON]	Auto Focus is performed.

Maintaining/not maintaining the lock when [AF/AE LOCK] is released

MENU →  [Custom] → [AF/AE Lock Hold] → [ON]/[OFF]

Disabling Operational Sounds and the Output of Light at once ([Silent Mode])

Applicable modes: P A S M C1 C2 C3



This function is useful for recording images in a quiet environment, public facility, etc. or recording images of subjects such as babies or animals.

Select the menu. (P28)

MENU → [Custom] → [Silent Mode]

Settings: [ON]/[OFF]

- Operational sounds are muted, and the flash and the AF Assist lamp are forced off. The following settings are fixed.
 - [Electronic Shutter]: [ON]
 - [Flash Mode]: (forced flash off)
 - [AF Assist Lamp]: [OFF]
 - [Beep Volume]: (OFF)
 - [E-Shutter Vol]: (OFF)
 - [Speaker Volume]: 0

- Even when [ON] is set, the following functions light up/flash.
 - Status indicator
 - Self-timer indicator
 - Wi-Fi connection lamp
- Sounds that are produced by the camera regardless of your operations, such as the lens aperture sound, cannot be muted.
- Be sure to pay special attention to the privacy, the likeness rights, etc. of the subject when you use this function. Use at your own risk.**

Taking Pictures with No Shutter Sound ([Electronic Shutter])

Applicable modes: P A S M C1 C2 C3



The shutter sound can be turned off for recording in a quiet environment. The mechanical shutter is disabled, making it easier to take pictures with minimized blur.

We recommended making a trial recording in advance because distorted subjects and horizontal stripes may be recorded depending on the recording conditions.

Select the menu. (P28)

MENU → [Rec] → [Electronic Shutter]

Settings: [ON]/[OFF]

- Flash is fixed to (forced flash off).
- Under fluorescent or LED lighting, etc., horizontal stripes may appear on recorded pictures. In such cases, lowering the shutter speed may reduce the effect of the horizontal stripes.
- If a subject is moving, the subject may appear distorted on the picture taken.

Taking pictures by using the flash

Applicable modes:

Taking a picture using the flash becomes possible by opening the built-in flash.

(A) To open the flash

Turn the camera on, and press the flash open button.

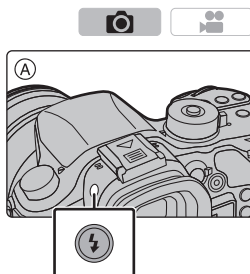

(B) To close the flash

Push the top part of the built-in flash from directly above.

- Forcibly closing the flash can damage the camera.
- Make sure to close the built-in flash when it is not in use.
- The flash setting is fixed to while the flash is closed.
- Be careful not to catch a finger when closing a flash bulb.

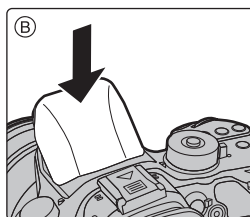

• In the following cases, the flash is fixed to (forced flash off).

- When recording motion pictures
- When [Electronic Shutter] is set to [ON]
- When [HDR] is set to [ON]
- When [Silent Mode] is set to [ON]

Changing Flash Mode

Applicable modes:

Set the built-in flash to match the recording.

1 Select the menu. (P28)

MENU → [Rec] → [Flash] → [Flash Mode]

2 Press / to select the item and then press [MENU/SET].

((Forced Flash On)) ((Forced On/Red-Eye))	The flash is activated every time regardless of the recording conditions. • Use this when your subject is back-lit or under fluorescent light.
((Slow Sync.)) ((Slow Sync./Red-Eye))	When taking pictures against a dark background landscape, this feature will slow the shutter speed when the flash is activated. Dark background landscape will appear brighter. • Use this when you take pictures of people in front of a dark background. • Using a slower speed can cause motion blur. Using a tripod can enhance your photos.

Recording Motion Picture

Applicable modes:



This can record full high definition motion pictures compatible with the AVCHD format or motion pictures recorded in MP4, MOV.

The functions available when recording motion pictures differ according to the lens you are using, and the operational sound of the lens may be recorded.

1 Start recording by pressing the motion picture button.

- (A) Elapsed recording time
- (B) Available recording time

- Recording of motion picture appropriate for each mode is possible.
- The recording state indicator (red) (C) will flash while recording motion pictures.
- If no operation is performed, part of the information on the screen will gradually become darker after approximately 10 seconds has passed, and will no longer be displayed after approximately 1 minute has passed. Pressing the [DISP.] button or touching the monitor will make the display reappear. This operation is to prevent screen burn-in and is not a malfunction.
- Release the motion picture button right after you press it.

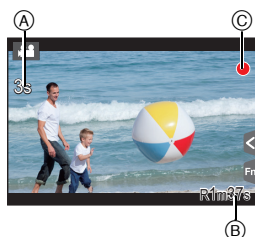
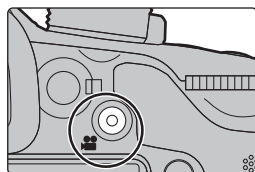

2 Stop the recording by pressing the motion picture button again.

- Still picture recording is also possible during the motion picture recording by fully pressing the shutter button.



About the operation sound that is produced when you stop recording

Since motion picture recording stops only after you press the motion picture button, the sound of the operation may be noticeable. If the sound bothers you, try the following:

- Divide the last part of the motion picture using [Video Divide] (P72) in the [Playback] menu.

The motion picture may not be divided near the very end of it. To avoid this, record approximately 3 seconds longer.

- Set the camera to Creative Video Mode, and use a shutter remote control (optional) to record motion pictures.

- When the motion picture size is set to [FHD], [HD] or [VGA] in [MP4], you can continuously record a motion picture up to 29 minutes 59 seconds or until the file size reaches 4 GB. You can check the recordable time on the screen.
 - Since the file size becomes larger with [FHD], recording with [FHD] will stop before 29 minutes 59 seconds.
- You can continuously record a motion picture with its size set to [4K] in [MP4] without a pause even if the motion picture exceeds 4 GB. However, the recorded content has to be played back as multiple files.
- Though a [MP4 (LPCM)]/[MOV] motion picture can be recorded continuously without a pause even when its file size exceeds 4 GB, the recorded content is played back with multiple files.

Recording motion pictures in 4K

Applicable modes:



You can create finely-detailed motion pictures in 4K by recording motion pictures with their size set to [4K] or [C4K] in [Rec Quality].

- You can record motion pictures in 4K only in Creative Video Mode.
- The angle of view of motion pictures in 4K is narrower than those of motion pictures in other sizes.
- When recording motion pictures in 4K, use a card rated as UHS Speed Class 3. (P15)

To record motion pictures in 4K:

- 1 Set the mode dial to . (P22)
- 2 Set [Rec Format] in the [Motion Picture] menu to [MP4], [MP4 (LPCM)] or [MOV].
- 3 Set the motion picture size to [4K] or [C4K] in [Rec Quality] in the [Motion Picture] menu.

Setting the format, size and recording frame rate

Applicable modes:



1 Select the menu. (P28)

MENU → [Motion Picture] → [Rec Format]

2 Press **▲/▼** to select the item and then press **[MENU/SET]**.

[AVCHD]	This data format is suitable for when playing back on a high-definition TV, etc.
[MP4]	The MP4 data format is suitable for playback on a PC, etc.
[MP4 (LPCM)]	The MP4 data format for image editing.
[MOV]	Data format for image editing.

- When [MP4 (LPCM)] or [MOV] is selected, confirmation screen is displayed. Select [Yes] to execute.

3 Press **▲/▼** to select **[Rec Quality]** and then press **[MENU/SET]**.

4 Press **▲/▼** to select the item and then press **[MENU/SET]**.

- Available items differ depending on [Rec Format] and [System Frequency] (P67).
- Exit the menu after it is set.

■ Indication of the icon

- (A) Size
- (B) ALL-Intra
- (C) Bit rate
- (D) Recording frame rate (Sensor output)

- "ALL-Intra" refers to a data compression method in which each frame is compressed. The file size of motion pictures recorded in this method becomes larger, but this method can prevent the loss of image quality because editing does not require re-encoding.
- What is bit rate
This is the volume of data for a definite period of time, and the quality becomes higher when the number gets bigger.
- Depending on the [Rec Format] and [Rec Quality] of a motion picture, the speed class rating required for the card differs. Use a card that meets the rating. For details, refer to "About the motion picture recording and speed class" on P15.

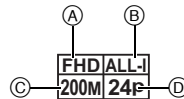

When [AVCHD] is selected

(○: Available, —: Not available)

Item	System frequency			Size	Recording frame rate	Sensor output ^{*2}	Bit rate
	59.94Hz (NTSC)	50.00Hz (PAL)	24.00Hz (CINEMA)				
[FHD/28M/60p] ^{*1}	○	—	—	1920×1080	59.94p	59.94	28 Mbps
[FHD/28M/50p] ^{*1}	—	○	—	1920×1080	50.00p	50.00	28 Mbps
[FHD/17M/60i]	○	—	—	1920×1080	59.94i	59.94	17 Mbps
[FHD/17M/50i]	—	○	—	1920×1080	50.00i	50.00	17 Mbps
[FHD/24M/30p]	○	—	—	1920×1080	59.94i	29.97	24 Mbps
[FHD/24M/25p]	—	○	—	1920×1080	50.00i	25.00	24 Mbps
[FHD/24M/24p]	○	—	—	1920×1080	23.98p	23.98	24 Mbps

*1 AVCHD Progressive

*2 Frames/second

When [MP4] is selected

(○: Available, —: Not available)

Item	System frequency			Size	Recording frame rate	Sensor output ^{*4}	Bit rate
	59.94Hz (NTSC)	50.00Hz (PAL)	24.00Hz (CINEMA)				
[4K/100M/30p] ^{*3}	○	—	—	3840×2160	29.97p	29.97	100 Mbps
[4K/100M/25p] ^{*3}	—	○	—	3840×2160	25.00p	25.00	100 Mbps
[FHD/28M/60p]	○	—	—	1920×1080	59.94p	59.94	28 Mbps
[FHD/28M/50p]	—	○	—	1920×1080	50.00p	50.00	28 Mbps
[FHD/20M/30p]	○	—	—	1920×1080	29.97p	29.97	20 Mbps
[FHD/20M/25p]	—	○	—	1920×1080	25.00p	25.00	20 Mbps
[HD/10M/30p]	○	—	—	1280×720	29.97p	29.97	10 Mbps
[HD/10M/25p]	—	○	—	1280×720	25.00p	25.00	10 Mbps
[VGA/4M/30p] ^{*5}	○	—	—	640×480	29.97p	29.97	4 Mbps
[VGA/4M/25p] ^{*5}	—	○	—	640×480	25.00p	25.00	4 Mbps

*3 These can be set only in Creative Video Mode.

*4 Frames/second

*5 If you use the HDMI output during recording, these items are not available.

• When the motion picture size is set to [FHD], [HD] or [VGA] in [MP4], you can continuously record a motion picture up to 29 minutes 59 seconds or until the file size reaches 4 GB. You can check the recordable time on the screen.

– Since the file size becomes larger with [FHD], recording with [FHD] will stop before 29 minutes 59 seconds.

• You can continuously record a motion picture with its size set to [4K] in [MP4] without a pause even if the motion picture exceeds 4 GB. However, the recorded content has to be played back as multiple files.

When [MP4 (LPCM)], [MOV] is selected

(○: Available, —: Not available)

Item	System frequency			Size	Recording frame rate	Sensor output*3	Bit rate
	59.94Hz (NTSC)	50.00Hz (PAL)	24.00Hz (CINEMA)				
[C4K/100M/24p]*1	—	—	○	4096×2160	24.00p	24.00	100 Mbps
[4K/100M/30p]*1	○	—	—	3840×2160	29.97p	29.97	100 Mbps
[4K/100M/25p]*1	—	○	—	3840×2160	25.00p	25.00	100 Mbps
[4K/100M/24p]*1	—	—	○	3840×2160	24.00p	24.00	100 Mbps
	○	—	—	3840×2160	23.98p	23.98	100 Mbps
[FHD/ALL-1*2/ 200M/60p]	○	—	—	1920×1080	59.94p	59.94	200 Mbps
[FHD/100M/60p]	○	—	—	1920×1080	59.94p	59.94	100 Mbps
[FHD/50M/60p]	○	—	—	1920×1080	59.94p	59.94	50 Mbps
[FHD/ALL-1*2/ 200M/50p]	—	○	—	1920×1080	50.00p	50.00	200 Mbps
[FHD/100M/50p]	—	○	—	1920×1080	50.00p	50.00	100 Mbps
[FHD/50M/50p]	—	○	—	1920×1080	50.00p	50.00	50 Mbps
[FHD/ALL-1*2/ 200M/30p]	○	—	—	1920×1080	29.97p	29.97	200 Mbps
[FHD/100M/30p]	○	—	—	1920×1080	29.97p	29.97	100 Mbps
[FHD/50M/30p]	○	—	—	1920×1080	29.97p	29.97	50 Mbps
[FHD/ALL-1*2/ 200M/25p]	—	○	—	1920×1080	25.00p	25.00	200 Mbps
[FHD/100M/25p]	—	○	—	1920×1080	25.00p	25.00	100 Mbps
[FHD/50M/25p]	—	○	—	1920×1080	25.00p	25.00	50 Mbps
[FHD/ALL-1*2/ 200M/24p]	—	—	○	1920×1080	24.00p	24.00	200 Mbps
	○	—	—	1920×1080	23.98p	23.98	200 Mbps
[FHD/100M/24p]	—	—	○	1920×1080	24.00p	24.00	100 Mbps
	○	—	—	1920×1080	23.98p	23.98	100 Mbps
[FHD/50M/24p]	—	—	○	1920×1080	24.00p	24.00	50 Mbps
	○	—	—	1920×1080	23.98p	23.98	50 Mbps

*1 These can be set only in Creative Video Mode.

*2 ALL-Intra

*3 Frames/second

• Though a [MP4 (LPCM)]/[MOV] motion picture can be recorded continuously without a pause even when its file size exceeds 4 GB, the recorded content is played back with multiple files.

How to set focus when recording a motion picture ([Continuous AF])

Applicable modes: **P** **A** **S** **M** **C1** **C2** **C3**



Focusing changes depending on the Focus Mode setting (P36) and the [Continuous AF] setting in the [Motion Picture] menu.

[Focus Mode]	[Continuous AF]	Description of settings
[AFS]/[AFF]/ [AFC]	[ON]	The camera automatically keeps focusing on subjects during recording. (P36)
	[OFF]	The camera maintains the focus position at the start of recording.
[MF]	[ON]/[OFF]	You can focus manually. (P40)

- When the focus mode is set to [AFS], [AFF] or [AFC], if you press the shutter button halfway while recording a motion picture, the camera will re-adjust the focus.

Recording motion pictures with manually set aperture value/shutter speed (Creative Video Mode)

Recording Mode:



It is possible to manually change the aperture and shutter speed and record motion pictures.

- 1 Set the mode dial to .
- 2 Select the menu. (P28)

MENU → [Motion Picture] → [Exposure Mode]

- 3 Press **▲/▼** to select [P], [A], [S] or [M], and then press [MENU/SET].
 - The operation for changing the aperture value or shutter speed is the same as the operation for setting the mode dial to **P**, **A**, **S** or **M**.
- 4 Start recording.
 - Press the motion picture button or the shutter button to start recording a motion picture. (Still pictures cannot be taken.)
- 5 Stop recording.
 - Press the motion picture button or the shutter button to stop recording a motion picture.

Minimizing operational sounds during motion picture recording

The operational sound of the zoom or button operation may be recorded when it is operated during the recording of a motion picture.







Using touch icons allows silent operation while recording motion pictures.

- Set [Silent Operation] in the [Motion Picture] menu to [ON].

1 Start recording.



2 Touch [].

3 Touch icon.

	Zoom (When an interchangeable lens compatible with power zoom is used)
	Aperture value
	Shutter speed
	Exposure Compensation
	ISO sensitivity/Gain (dB) (P102)
	Mic level adjustment

4 Drag the slide bar to set.

- The speed of the operation varies depending on the position you touch.

	changes the setting slowly
	changes the setting quickly

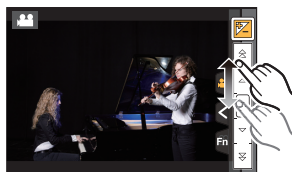

5 Stop recording.

Using Advanced Settings and Recording Functions for Motion Pictures

[Luminance Level]

Applicable modes: P A S M C1 C2 C3



You can set the luminance range for motion pictures. When you combine multiple materials into a single motion picture, set a range that covers all materials.

MENU → **[Motion Picture]** → **[Luminance Level]**

Settings: **[0–255]/[16–235]/[16–255]**

- This function works only for motion pictures. Still pictures (including those you take during motion picture recording) will be taken with [0–255].
- When [Rec Format] is set to [AVCHD] or [MP4], [0–255] in [Luminance Level] will switch to [16–255].



Checking areas that may be white saturated ([Zebra Pattern])

Applicable modes: P A S M C1 C2 C3



You can check areas that may be white saturated by displaying areas above a certain luminance level in a zebra pattern. You can also set the minimum luminance level (brightness) to be processed as a zebra pattern.

MENU → **[Custom]** → **[Zebra Pattern]**

[ZEBRA1]	Displays areas above a certain luminance level by a right-leaning zebra pattern.	
[ZEBRA2]	Displays areas above a certain luminance level by a left-leaning zebra pattern.	
[OFF]	—	
[SET]	Sets the minimum brightness level for each zebra pattern. [Zebra 1]/[Zebra 2] Press ▲/▼ to select the brightness, and press [MENU/SET]. • You can select a brightness value between [50%] and [105%]. In [Zebra 2], you can select [OFF]. If you select [100%] or [105%], only the areas that are already white saturated are displayed in a zebra pattern. The smaller the value is, the wider the brightness range to be processed as a zebra pattern will be.	

- If there are any white saturated areas, we recommend compensating the exposure towards negative (P54) referring to the histogram (P103) and then taking the picture.
- Displayed zebra patterns will not be recorded.

Recording while monitoring camera images

Applicable modes: 

During HDMI output, you can record while monitoring motion pictures on the TV, etc.

- Refer to P87 on how to connect with TV by using HDMI micro cable.
- The [Rec Quality] setting in the motion picture recording menu will be applied to screens that are output through the HDMI connection during recording.



■ Setting the output method of the HDMI connection

MENU →  **[Motion Picture]** → **[HDMI Rec Output]**

[Bit Mode]	<p>Sets the picture quality for the HDMI output.</p> <p>[4:2:2 8bit]: Allows you to record the image being output through the HDMI connection as a motion picture. This option is ideal for monitoring the image on the external monitor while recording it.</p> <p>[4:2:2 10bit]: Allows you to output the image through the HDMI connection in high picture quality. This option is ideal for saving the image on the external device.</p> <ul style="list-style-type: none"> • You can select [4:2:2 10bit] only in Creative Video Mode. • If you output the image through the HDMI connection when [Bit Mode] is set to [4:2:2 10bit], motion pictures cannot be recorded.
[Info Display]	<p>Shows or hides the displays of information.</p> <p>[ON]: Outputs the displays on the camera as they are.</p> <p>[OFF]: Outputs only the image.</p> <ul style="list-style-type: none"> • If you output the image through the HDMI connection when [Bit Mode] is set to [4:2:2 10bit], this setting is fixed to [OFF].
[4K Down Convert]	<p>Switches the picture quality according to the connected device.</p> <p>[AUTO]: When the motion picture size is set to [4K] or [C4K] in [Rec Quality] and the connected device is not responding, the HDMI output picture quality automatically switches to [1080p].</p> <p>[1080p]: When the motion picture size is set to [4K] or [C4K] in [Rec Quality], the HDMI output picture quality switches to [1080p].</p> <p>[OFF]: Outputs the image through the HDMI connection with the picture quality set in [Rec Quality].</p>

- Do not use the headphone cables with the length of 3 m (9.8 feet) or more.
- Excessive sound pressure from earphones and headphones can cause hearing loss.
- Listening at excessive volume for long periods may damage the user's ears.
- When you use HDMI output during recording, the image may be displayed with a time lag.

Reducing flickering and horizontal stripes on images ([Synchro Scan])

Applicable modes: P A S M



• This function is available when [Exposure Mode] is set to either [S] or [M] in Creative Video Mode.

1 Select the menu. (P28)

MENU → [Motion Picture] → [Synchro Scan]

2 Select [ON] with ▲/▼, and then press [MENU/SET].

3 Select Shutter Speed with ◀/▶, and then press [MENU/SET].

- You can fine-adjust the shutter speed.
- Adjust the shutter speed while looking at the screen so that flickering and horizontal stripes will be minimized.
- If you press and hold ◀/▶, the shutter speed will be adjusted faster.
- You can also adjust the shutter speed setting on the recording screen in increments finer than the normal adjustment method.

■ Canceling [Synchro Scan]

Select the [OFF] setting in step 2.

Recording in Slow or Fast Motion ([Variable Frame Rate])

Applicable modes: P A S M



• This function is available only when the camera is set to Creative Video Mode.

• Recording with a variable frame rate is possible with the following settings in [Rec Format] and [Rec Quality].

[AVCHD]	<p>When [System Frequency] is set to [59.94 Hz (NTSC)]</p> <ul style="list-style-type: none"> • [FHD/24M/30p]/[FHD/24M/24p] <p>When [System Frequency] is set to [50.00 Hz (PAL)]</p> <ul style="list-style-type: none"> • [FHD/24M/25p]
[MP4 (LPCM)]/ [MOV]	<p>When [System Frequency] is set to [59.94 Hz (NTSC)]</p> <ul style="list-style-type: none"> • [FHD/100M/30p]/[FHD/100M/24p] <p>When [System Frequency] is set to [50.00 Hz (PAL)]</p> <ul style="list-style-type: none"> • [FHD/100M/25p] <p>When [System Frequency] is set to [24.00 Hz (CINEMA)]</p> <ul style="list-style-type: none"> • [FHD/100M/24p]

* When [Rec Format] is set to [MP4], recording with a variable frame rate is not possible.

• Auto Focus does not work.

• Audio is not recorded.

1 Select the menu. (P28)

MENU → [Motion Picture] → [Rec Quality]

2 Press ▲/▼ to select an item and then press [MENU/SET].

- Items available for recording with a variable frame rate are indicated as [VFR available] on the screen.

3 Select [Variable Frame Rate] with ▲/▼, and then press [MENU/SET].

4 Select [ON] with ▲/▼, and then press [MENU/SET].

5 Press ◀/▶ to select the frame rate you will record the item with.

- You can select a value between [2 fps] and [96 fps].

6 Press [MENU/SET].

- Exit the menu after it is set.

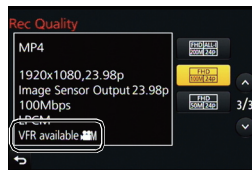

■ To cancel [Variable Frame Rate]

Select the [OFF] setting in step 4.

■ To change the frame rate

Select the [SET] setting in step 4.

- When [Rec Format] is set to [AVCHD], you cannot set a frame rate with a number of frames greater than 60fps.
- When you play back a motion picture recorded with [Variable Frame Rate], the recording time display for motion pictures on the top right of the screen will look different from the one that appears during normal motion picture playback.

[▶ XXmXXs]: Actual playback time

[🕒 XXmXXs]: Actual elapse of time during which you recorded the motion picture

Changing the system frequency

Applicable modes: 



You can change the system frequency of the motion pictures you record and play back. When creating a motion picture that has a broadcasting system different from your region or when recording a motion picture for a film, change the system frequency.

1 Select the menu. (P28)

MENU →  [Setup] → [System Frequency]

2 Press ▲/▼ to select an item and then press [MENU/SET].

[59.94 Hz (NTSC)]	For regions where the TV broadcasting system is NTSC
[50.00 Hz (PAL)]	For regions where the TV broadcasting system is PAL
[24.00 Hz (CINEMA)]	This system frequency is for creating films

- A message prompting you to restart the camera will be displayed. Turn off and on the camera.

- By default, the system frequency is set to the broadcasting system of your purchase region, [59.94 Hz (NTSC)] or [50.00 Hz (PAL)].
- **When [System Frequency] is set to a broadcasting system different from that of your region, images may not be played back correctly on the TV.**
- **If you are not familiar with broadcasting systems or will not be creating any motion pictures for films, we recommend that you use the default setting.**
- If you changed the setting but are not sure about the system frequency for the broadcasting system of your region, perform [Reset] in the [Setup] menu (P29).

■ Once you change the system frequency

After changing the [System Frequency] setting, motion pictures may not be recorded or played back if you continue to use the card that was inserted in the camera. We recommend that you replace the card with another one and format (P29) it on the camera.

- If you continue to use the card that was inserted in the camera before you changed the setting, the camera will operate as follows:

[Rec Format]	[Rec]	[Playback]
[AVCHD]	Recording is not possible	You cannot play back motion pictures recorded before you changed the setting.
[MP4]/[MP4 (LPCM)]/[MOV]	Recording is possible	• Motion pictures recorded with a different [System Frequency] setting cannot be played back.

Playing Back Pictures

1 Press [▶].

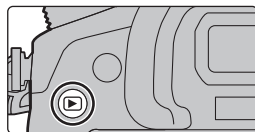

2 Press ◀▶.

- ◀: Play back the previous picture
- ▶: Play back the next picture
- If you press and hold ◀▶, you can play back the pictures in succession.



■ To finish playback

Press [▶] again, press the shutter button halfway or press the motion picture button.

Playing Back Motion Pictures

This unit was designed to play motion pictures using the AVCHD, MP4 and MOV formats.

- Motion pictures are displayed with the motion picture icon ((▶)).

Press ▲ to play back.

(A) Motion picture recording time



■ Operations during Motion Picture Playback

Button operation	Touch operation	Description of operation	Button operation	Touch operation	Description of operation
▲	▶/	Play/Pause	▼	■	Stop
◀	◀◀	Fast rewind*	▶	▶▶	Fast forward*
	◀	Frame-by-frame rewind (while pausing)		▶	Frame-by-frame forward (while pausing)
(🔊)	-	Reduce volume level	(🔊)	+	Increase volume level

* The fast forward/rewind speed increases if you press ▶/◀ again.

• If you press [MENU/SET] during a pause, you can create a picture from a motion picture.

Switching the Playback Method

Using the Playback Zoom

Rotate the rear dial right.

1× → 2× → 4× → 8× → 16×

- If the rear dial is rotated to the left after the image is enlarged, the magnification will be reduced.
- You can move the enlarged part by pressing ▲/▼/◀/▶ of the cursor button or dragging the screen. (P26)
- You can also enlarge (2×) the image by double-touching the part you want to enlarge. If you double-touch the enlarged image, the magnification is reset to 1×.
- You can forward or rewind the image while maintaining the same zoom magnification and zoom position for the Playback Zoom by rotating the control dial during Playback Zoom.

Ⓐ Zoom position indication



Displaying multiple screens (Multi Playback)

Rotate the rear dial left.

1 screen → 12 screens → 30 screens → Calendar screen display

- If the rear dial is rotated to the right, the previous playback screen will be displayed.
- It is possible to switch the playback screen by touching the following icons.
 - [■]: 1 screen
 - [■□]: 12 screens
 - [■□□]: 30 screens
 - [CAL]: Calendar screen display
- The screen can be switched gradually by dragging the screen up or down.

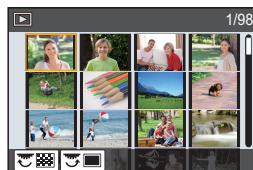

■ To return to Normal Playback

Press ▲/▼/◀/▶ to select a picture and then press [MENU/SET].

Displaying Pictures by Recording Date (Calendar Playback)

- 1 Rotate the rear dial left to display the Calendar screen.
- 2 Press ▲/▼/◀/▶ to select the date to be played back.
- 3 Press [MENU/SET] to display the images that are recorded in selected date.
- 4 Press ▲/▼/◀/▶ to select a picture and then press [MENU/SET].

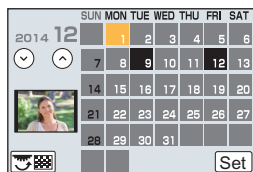

Deleting Pictures

Once deleted, pictures cannot be recovered.

To delete a single picture

1 In Playback Mode, select the picture to delete and then press [🗑️/↵].

- The same operation can be performed by touching [🗑️].

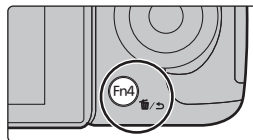

2 Press ▲ to select [Delete Single] and then press [MENU/SET].

- Confirmation screen is displayed.
Picture is deleted by selecting [Yes].



To delete multiple pictures (up to 100*) or all the pictures

- * Picture groups are treated as a single picture.
(All the pictures in the selected picture group will be deleted.)

1 In Playback Mode, press [🗑️/↵].

2 Press ▲/▼ to select [Delete Multi] or [Delete All] and then press [MENU/SET].

- [Delete All] → Confirmation screen is displayed.
Pictures are deleted by selecting [Yes].
- It is possible to delete all pictures except the ones set as favorite when [All Delete Except Favorite] is selected with the [Delete All] set.

3 (When [Delete Multi] is selected)

Press ▲/▼/◀/▶ to select the picture, and then press [MENU/SET] to set. (Repeat this step.)

- [🗑️] appears on the selected pictures.
If [MENU/SET] is pressed again, the setting is canceled.



4 (When [Delete Multi] is selected)

Press ◀ to select [OK], and then press [MENU/SET] to execute.

- Confirmation screen is displayed.
Pictures are deleted by selecting [Yes].

Using the [Playback] Menu

[RAW Processing]

You can process the pictures taken in RAW format. The processed pictures will be saved in JPEG format.

1 Select the menu. (P28)

MENU → **[Playback]** → **[RAW Processing]**

2 Select RAW images with ◀/▶, and then press **[MENU/SET]**.

3 Press ▲/▼ to select an item.

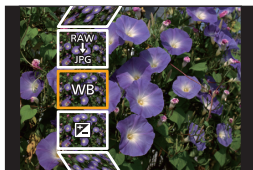

[White Balance]	[Contrast]	[Hue]/[Filter Effect]	[Setup] ([Reinstate Adjustments]/ [Color Space]/ [Picture Size])
[Exposure Comp.]	[Highlight]	[Noise Reduction]	
[Photo Style]	[Shadow]	[i.Resolution]	
[i.Dynamic]	[Saturation]/ [Color Tone]	[Sharpness]	

4 Press **[MENU/SET]** and set.

- The setting method differs according to the item.

5 Press **[MENU/SET]**.

- This operation returns you to the screen in step 3. To set other items, repeat steps 3 through 5.

6 Select **[Begin Processing]** with ▲/▼, and then press **[MENU/SET]**.

- A confirmation screen will be displayed. Selecting [Yes] will execute the operation. After the operation, exit the menu.

■ How to set each item

When you select an item, the setting screen will be displayed.

Button operation	Touch operation	Description of operation
	Dragging	Selects a setting.
▲	[WB K Set]	Displays the screen that lets you set the color temperature. (Only when [White Balance] is set to [K])
▼	[Adjust.]	Displays the screen that lets you fine-adjust the White Balance. (only when [White Balance] is set)
[DISP.]	[DISP.]	Displays the comparison screen.
[MENU/SET]	[Set]	Sets the adjusted level and returns you to the item selection screen.

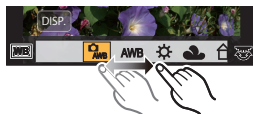
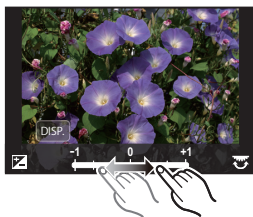



- When [Noise Reduction], [i.Resolution] or [Sharpness] is selected, the comparison screen cannot be displayed.
- If you touch the picture twice, the picture will be enlarged. If you touch the picture twice when it is enlarged, it will be reduced to the original size.

On the comparison screen, you can use the following operations to make adjustments:

Ⓐ Current setting

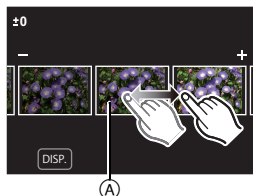
Button operation	Touch operation	Description of operation
	Dragging	Selects a setting.
[DISP.]	[DISP.]	Returns you to the setting screen.
[MENU/SET]	[Set]	Sets the adjusted level and returns you to the item selection screen.



- If you touch the picture at the center, it will be enlarged. If you touch , the picture will be reduced to the original size.

[Setup] setting

When you select an item, the screen that asks you to select [Reinstate Adjustments], [Color Space], or [Picture Size] will be displayed.

- 1 Press **▲/▼** to select an item, and press **[MENU/SET]**.
 - If you select [Reinstate Adjustments], a confirmation screen will be displayed. Selecting [Yes] will execute the operation and return you to the item selection screen.
- 2 Press **▲/▼** to select a setting, and press **[MENU/SET]**.
 - This operation will apply the setting and return you to the item selection screen.

[Video Divide]

Recorded motion picture can be divided in two. It is recommended for when you want to divide a part you need with a part you do not need.

Dividing a motion picture is permanent. Decide before you divide!

1 Select the menu. (P28)

MENU →  **[Playback]** → **[Video Divide]**

2 Press **◀/▶** to select the motion picture to divide, and then press **[MENU/SET]**.

3 Press **▲** at the location to divide.

- You can finely adjust the location for division by pressing **◀/▶** while the motion picture is paused.



4 Press **▼**.

- Confirmation screen is displayed. It is executed when [Yes] is selected. Exit the menu after it is executed.
- Avoid trying to divide motion picture near the very beginning or end of the motion picture.
- You cannot use [Video Divide] for the following pictures.
 - Motion pictures with a short recording time

Wi-Fi[®] function/NFC function

■ Use the camera as a wireless LAN device

When using equipment or computer systems that require more reliable security than wireless LAN devices, ensure that the appropriate measures are taken for safety designs and defects for the systems used. Panasonic will not take any responsibility for any damage that arises when using the camera for any purpose other than as a wireless LAN device.

■ Use of the Wi-Fi function of this camera is presumed to be in countries where this camera is sold

There is the risk that the camera violates the radiowave regulations if used in countries other than those where this camera is sold, and Panasonic takes no responsibility for any violations.

■ There is the risk that data sent and received via radio waves may be intercepted

Please note that there is the risk that data sent and received via radio waves may be intercepted by a third party.

■ Do not use the camera in areas with magnetic fields, static electricity or interference

- Do not use the camera in areas with magnetic fields, static electricity or interference, such as near microwave ovens. These may cause the interruption of the radio waves.
- Using the camera near devices such as microwave ovens or cordless telephones that use the 2.4 GHz radio wave band may cause a decrease in performance in both devices.

■ Do not connect to the wireless network you are not authorized to use

When the camera utilizes its Wi-Fi function, wireless networks will be searched automatically. When this happens, wireless networks that you are not authorized to use (SSID*) may be displayed, however do not attempt to connect to the network as it may be considered as unauthorized access.

- * SSID refers to the name that is used to identify a network over a wireless LAN connection. If the SSID matches for both devices, transmission is possible.

■ Before Use

To use the Wi-Fi function on this unit, a wireless access point or a destination device equipped with the wireless LAN function is required.

■ This unit is compatible with NFC

Using the NFC "Near Field Communication" function, you can easily transfer data necessary for a Wi-Fi connection between this camera and the smartphone/tablet.



■ About the Wi-Fi connection lamp

- Lit blue: The Wi-Fi connection is on standby
- Blinking blue: Sending/receiving data through the Wi-Fi connection

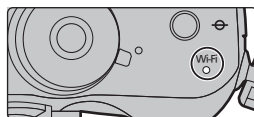

- The camera cannot be used to connect to a public wireless LAN connection.
- Use a IEEE802.11b, IEEE802.11g or IEEE802.11n compatible device when using a wireless access point.
- It is recommended to use a fully charged battery when sending images.
- When sending images on a mobile network, high packet communication fees may be incurred depending on the details of your contract.
- **Do not remove the memory card or battery or move to an area without any reception while sending images.**
- The monitor display may become distorted for an instant while connected to the service, however this will not affect the image being sent.
- If you use the HDMI output during recording with [Bit Mode] in [HDMI Rec Output] set to [4:2:2 10bit], the Wi-Fi function will be disabled.

■ About the [Wi-Fi] button

Pressing and holding [Wi-Fi] before connecting to Wi-Fi (When connecting to a smartphone/tablet)

- The information required for connecting the smartphone/tablet to this unit (QR code, SSID and password) is displayed. (P76)

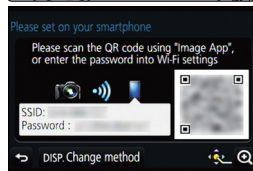

Pressing [Wi-Fi] before connecting to Wi-Fi

- Following items can be selected.

[New Connection]	—
[Select a destination from History]	Connects with the same settings as the previous ones. Registering records as favorites ① Select the item you want to register to favorites, and then press ►. ② Enter a registration name.
[Select a destination from Favorite]	Connects with settings registered as favorites.

What you can do with the [Wi-Fi] button when connected to Wi-Fi

- Following items can be selected.

[Terminate the Connection]

[Change the Destination]

[Change Settings for Sending Images]

[Register the Current Destination to Favorite]

[Network Address]

What you can do with the Wi-Fi function

Controlling with a Smartphone/Tablet (P76)

- Recording with a smartphone (P80)
- Playing back pictures in the camera (P80)
- Saving images stored in the camera (P80)
- Sending images to an SNS (P81)
- Writing location information on images stored in the camera (P82)



Displaying pictures on a TV

Printing Wirelessly

When sending images to AV device

When sending images to PC (P83)

Using Web services



- This Owner's Manual refer to both smartphones and tablets as "smartphones" from this point on unless noted otherwise.
- Please also refer to the "Owner's Manual for advanced features (PDF format)", which describes more detailed information.

Controlling with a Smartphone/Tablet

Installing the smartphone/tablet app “Image App”

The “Image App” is an application provided by Panasonic.

• **OS (As of March 2014)**

App for Android™: Android 2.3.3 or higher*

App for iOS: iOS 5.0 or higher

* Connecting to this unit with [Wi-Fi Direct] requires Android OS 4.0 or higher and Wi-Fi Direct™ support.

- 1 Connect the smartphone to a network.**
- 2 (Android) Select “Google Play™ Store”.**
(iOS) Select “App Store™”.
- 3 Enter “Panasonic Image App” into the search box.**
- 4 Select “Panasonic Image App”  and install it.**

- Use the latest version.
- Read the [Help] in the “Image App” menu for further details on how to operate.
- The screen differs depending on the OS.
- The screens and procedures described from this point on are those at the time when the model first became available for purchase. The screens and procedures may change with version updates.
- The service may not be able to be used properly depending on the type of smartphone being used. For information on the “Image App”, refer to the support site below.
<http://panasonic.jp/support/global/cs/dsc/>
(This Site is English only.)
- When downloading the app on a mobile network, high packet communication fees may be incurred depending on the details of your contract.

Connecting to a smartphone/tablet

If you are using an iOS device
[iPhone/iPod touch/iPad]



Using the QR code to set up a connection



If you are using an Android device



Is your device compatible with the NFC function?

Yes

No



Setting up a connection using the NFC function



Using the QR code to set up a connection



- You can also set up a connection by entering a password directly. For details, refer to P79.
- When terminating the connection, refer to P79.

If you are using an iOS device [iPhone/iPod touch/iPad]

Using the QR code to set up a connection

1 Press and hold [Wi-Fi] on the camera.



2 Start "Image App" on your smartphone/tablet.

3 Select [QR code], and then select [OK].



4 Using "Image App", scan the QR code displayed on the screen of the camera.

(A) QR code

- If you press [MENU/SET] on the camera, the QR code will be enlarged. When it is difficult to scan the QR code, try enlarging it.



5 Install the profile of "IMAGE APP".

- A message will be displayed on the browser.
- If the smartphone/tablet is locked with a passcode, enter the passcode to unlock the smartphone/tablet.



6 Press the home button to close the browser.

7 Turn on the Wi-Fi function in the setting menu of the smartphone/tablet.

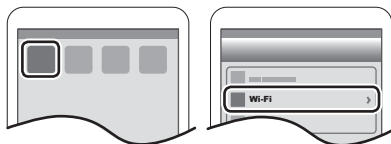

8 Select the SSID displayed on the screen of the camera.

9 Return to the home screen, and then start "Image App".

- Steps 2 through 6 are not required from the second time on.

When using an Android device

Setting up a connection using the NFC function

- If [NFC] is not displayed on the smartphone, the NFC function of the smartphone is disabled. Read the operating instructions of your smartphone and enable it.
- This function can be used with the NFC compatible device with Android (OS version 2.3.3 or higher). (excluding some models)

1 Launch “Image App” on your smartphone/ tablet.

2 While [NFC] is displayed on the screen of the smartphone, touch the smartphone to [NFC] of the camera.

3 When the connection confirmation screen is displayed on the camera, select [Yes].

4 Touch the smartphone to [NFC] of the camera again.

• Steps **3** through **4** are not required from the second time on.

• For information on the operation and settings of NFC-compatible smartphones, refer to the operating instructions of your device.

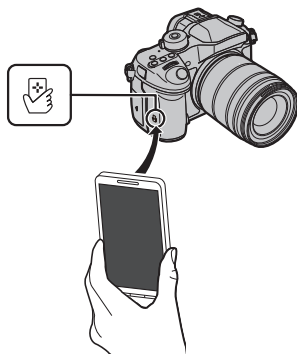

When using an Android device

Using the QR code to set up a connection

1 Press and hold [Wi-Fi] on the camera.

2 Start “Image App” on your smartphone/tablet.

3 Select [QR code].

4 Scan the QR code displayed on the screen of the camera.

Ⓐ QR code

- If you press [MENU/SET] on the camera, the QR code will be enlarged. When it is difficult to scan the QR code, try enlarging it.

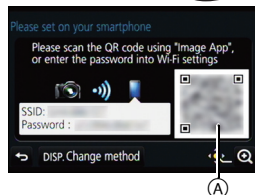

For both iOS devices (iPhone/iPod touch/iPad) and Android devices

Entering a password to set up a connection

- 1 Press and hold [Wi-Fi] on the camera.
- 2 Turn on the Wi-Fi function in the setting menu of the smartphone/tablet.
- 3 Select the SSID displayed on the screen of the camera.
 - (A) SSID and password
- 4 Enter the password displayed on the screen of the camera.
 - If you are using an Android device, marking the box for password display will allow the device to display the password as you enter it.
- 5 On the smartphone/tablet, start "Image App".

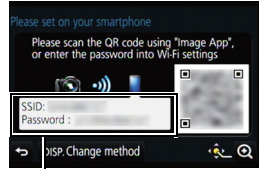
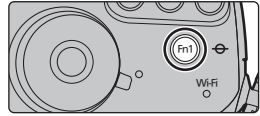

For both iOS devices (iPhone/iPod touch/iPad) and Android devices

Terminating the connection

After use, terminate the connection to the smartphone.

- 1 Press [Wi-Fi] on the camera. (P75)
- 2 On the smartphone, close "Image App".
 - If you are using an iOS device
On the screen of "Image App", press the home button to close the app.
 - If you are using an Android device
On the screen of "Image App", press the return button twice to close the app.

Taking images via a smartphone/tablet (remote recording)

1 Connect to a smartphone. (P76)

2 Operate the smartphone.

- 1 Select [].
- 2 Record an image.
 - The recorded images are saved in the camera.
 - Some settings are not available.



Playing back images in the camera

1 Connect to a smartphone. (P76)

2 Operate the smartphone.

- 1 Select [].
 - You can switch the images to be displayed by selecting the icon (A) on the top left of the screen. To display images stored in the camera, select [LUMIX].
- 2 Touch the image to enlarge it.

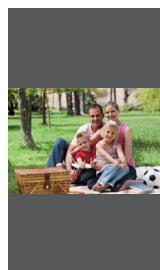
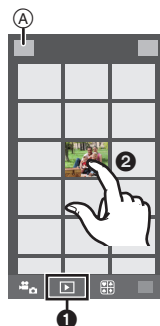

Saving images stored in the camera

1 Connect to a smartphone. (P76)

2 Operate the smartphone.

- 1 Select [].
 - You can switch the images to be displayed by selecting the icon (A) on the top left of the screen. To display images stored in the camera, select [LUMIX].
- 2 Touch and hold an image, and drag it to save it.

- The function can be assigned to the top, bottom, left or right according to your preference.
- Pictures in RAW format and motion pictures of [AVCHD], [MP4] (only when the motion picture size is set to [4K] in [Rec Quality]), [MP4 (LPCM)] and [MOV] cannot be saved.
- 3D pictures (MPO format) will be saved as 2D pictures (JPEG format).

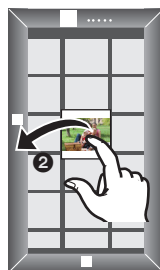
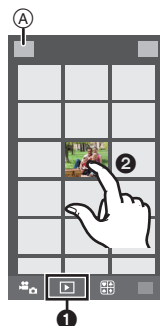

Saving images in the camera using the NFC function

The NFC function is not available for iOS devices (iPhone/iPod touch/iPad).

- 1 Play back the picture in the camera.
- 2 Launch “Image App” on the smartphone.
- 3 While [📱] is displayed on the connection screen of the “Image App”, touch the smartphone to [📱] of the camera.
 - If a connection attempt by touching fails, restart the “Image App”, and then display the screen in step 2 again.
 - To transfer more than one image, repeat steps 1 and 3.
(They cannot be transferred as a batch.)

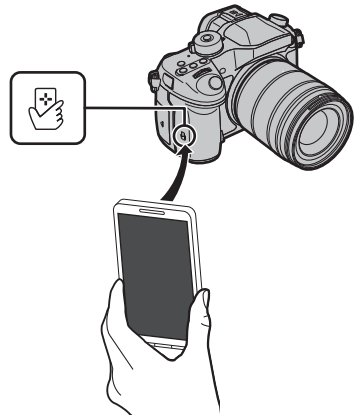

- After you set up a connection with the smartphone using the NFC function, the image will be saved via the Wi-Fi connection.

Sending images in the camera to an SNS

- 1 Connect to a smartphone. (P76)
 - 2 Operate the smartphone.
 - 1 Select [📺].
 - You can switch the images to be displayed by selecting the icon (A) on the top left of the screen. To display images stored in the camera, select [LUMIX].
 - 2 Touch and hold an image, and drag it to send it to an SNS, etc.
 - The image is sent to a web service such as an SNS.
- The function can be assigned to the top, bottom, left or right according to your preference.

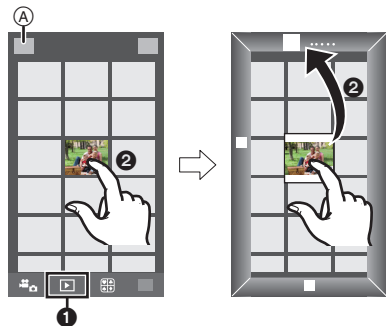

Adding location information to images stored in the camera from a smartphone/tablet

You can send location information acquired with a smartphone to the camera. After sending the information, you can also write it on images stored in the camera.

- 1 Start recording location information
- 2 Start recording images
- 3 Finish recording the location information
- 4 Sending and writing location information

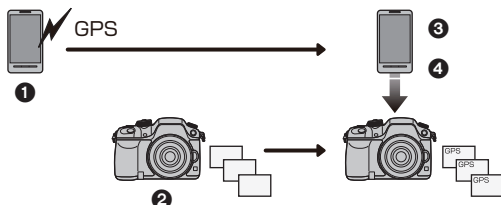

- Location information different from that at the time of recording may be written.

Keep the following points in mind:

- Set the camera's [Home] setting in [World Time] to your region.
- Once you start recording location information with your smartphone, do not change the camera's [Home] setting in [World Time].
- Location information cannot be written on images that were recorded when the clock was not set.

Start recording location information

Operate the smartphone.

- 1 Select [].
- 2 Select [Geotagging].
- 3 Select [].



Finish recording the location information

Operate the smartphone.

- 1 Select [].
- 2 Select [Geotagging].
- 3 Select [].



Sending and writing location information

1 Connect to a smartphone. (P76)

2 Operate the smartphone.

- 1 Select [].
- 2 Select [Geotagging].
- 3 Select [].



- Follow the on-screen messages to operate the smartphone.
- Location information is not written onto the images recorded when [Rec Format] is set to [AVCHD].
- When the card in the camera lacks sufficient free space, writing location information may not be possible.

• Cautions for Use:

Be sure to pay special attention to the privacy, the likeness rights, etc. of the subject when you use this function. Use at your own risk.

• (When using "Image App" for iOS)

If you press the Home or On/Off button of a smartphone while [Rec. loc. Info] is working, location information recording is stopped.

Setting up a connection to a PC via a wireless access point

To create a folder that receives images

Prepare folders for receiving images on the PC before sending a picture to the PC.

- Create a PC user account [account name (up to 254 characters) and password (up to 32 characters)] consisting of alphanumeric characters. An attempt to create a receive folder may fail if the account includes non-alphanumeric characters.

■ When using “PHOTOfunSTUDIO”

1 Install “PHOTOfunSTUDIO” to the PC.

- For details on hardware requirements and installation, read “About the supplied software” (P88).

2 Create a folder that receives images with “PHOTOfunSTUDIO”.

- To create the folder automatically, select [Auto-create]. To specify a folder, create a new folder, or set a password to the folder, select [Create manually].
- For details, refer to the operating instructions of “PHOTOfunSTUDIO” (PDF).

■ When not using “PHOTOfunSTUDIO”

(For Windows)

Supported OS: Windows XP/Windows Vista/Windows 7/Windows 8/Windows 8.1

Example: Windows 7

1 Select a folder you intend to use for receiving, then right-click.

2 Select [Properties], then enable sharing of the folder.

- For details, refer to the operating instructions of your PC or Help on the OS.

(For Mac)

Supported OS: OS X v10.5 to v10.9

Example: OS X v10.8

1 Select a folder you intend to use for receiving, then click on the items in the following order.

[File] → [Get Info]

2 Enable sharing of the folder.

- For details, refer to the operating instructions of your PC or Help on the OS.

When sending images to PC

You can send pictures and motion pictures recorded with this unit to a PC.

The connection methods described in this manual are examples. For details on other connection methods, refer to “Owner’s Manual for advanced features (PDF format)”.

Preparations:

- If the workgroup of the destination PC has been changed from the standard setting, you also need to change the setting of this unit in [PC Connection].

- 1 Press [Wi-Fi].
- 2 Select [New Connection].
- 3 Select the connection method.



**Sending an image each time a recording is made
([Send Images While Recording])**

Available file format: JPEG/RAW/MPO

**Select and send the images
([Send Images Stored in the Camera])**

Available file format: ALL format

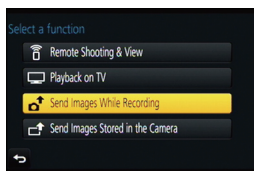

- 4 Select [PC].
 - 5 Select the connection method.
- Example: Selecting [WPS (Push-Button)] to set up a connection**

- 1 Select [Via Network].
- 2 Select [WPS (Push-Button)].
- 3 Press the wireless access point WPS button until it switches to WPS mode.

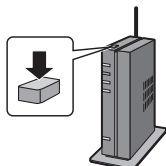

- 6 On the camera, perform the operation that matches your purpose.

**Sending an image each time a recording is made
([Send Images While Recording])**

- 1 Select the PC you want to connect to and the destination folder.*
- 2 Take a picture with the camera.

**Select and send the images
([Send Images Stored in the Camera])**

- 1 Select the PC you want to connect to and the destination folder.*
- 2 Select [Single Select] or [Multi Select], and then select the images you want to send.



- * When the PC you want to connect to is not displayed, select [Manual Input], and enter the computer name of the PC (NetBIOS name for Apple Mac computers).
- To change the setting or disconnect, press [Wi-Fi]. (P75)

- Folders sorted by the sent date are created in the specified folder, and pictures are saved in those folders.
- If the screen for a user account and password entry appears, enter the one you set on your PC.
- When the computer name (NetBIOS name for Apple Mac computers) contains a space (blank character), etc., it may not be recognized correctly.
If a connection attempt fails, we recommend that you change the computer name (or NetBIOS name) to the one consisting of only alphanumeric characters, with a maximum of 15 characters.

Change the Quick Menu to your preferred item

When [Q.MENU] (P104) in the [Custom] menu is set to [CUSTOM], the Quick Menu can be changed as desired.

Up to 15 items can be set to the Quick Menu.

- 1 Press [Q.MENU] to display the Quick Menu.
- 2 Press \blacktriangledown to select [**Q.M**] and then press [MENU/SET].

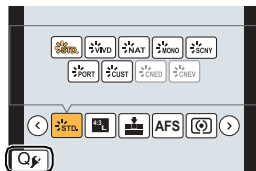

- 3 Press $\blacktriangle/\blacktriangledown/\blacktriangleleft/\blacktriangleright$ to select the menu item in the top row and then press [MENU/SET].
- 4 Press $\blacktriangleleft/\blacktriangleright$ to select the empty space in the bottom row and then press [MENU/SET].

(A) Items that can be setup as Quick Menus.

(B) Items that can be displayed in the Quick Menu screen.

- You can also set the menu item by dragging it from the top row to the bottom row.

- If there is no empty space in the bottom row, you can replace an existing item with a new select item by selecting the existing item.

- To cancel the setting, move to the bottom row by pressing \blacktriangledown and select an item to cancel, and then press [MENU/SET].

- 5 Press [$\blacktriangleleft/\blacktriangleright$].

- It will return to screen of step 1.

Press [MENU/SET] to switch to the recording screen.

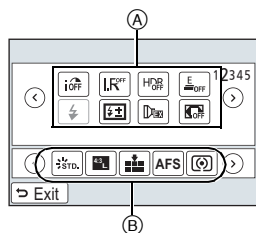

Assigning frequently used functions to the buttons (function buttons)

You can assign frequently-used functions to particular buttons or icons.

- 1 Select the menu. (P28)

MENU → f_c [Custom] → [Fn Button Set]

- 2 Press $\blacktriangle/\blacktriangledown$ to select [Setting in REC mode] or [Setting in PLAY mode] and then press [MENU/SET].
- 3 Press $\blacktriangle/\blacktriangledown$ to select the function button you want to assign a function to and then press [MENU/SET].
- 4 Press $\blacktriangle/\blacktriangledown$ to select the function you want to assign and then press [MENU/SET].

- Some functions cannot be assigned depending on the function button.

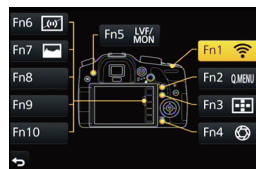

Registering your preferred settings (Custom Mode)

You can register the current camera settings as custom settings.

If you then record in Custom Mode, you can use the registered settings.

- Initial setting of the Program AE Mode is registered as the custom settings initially.

Registering Personal Menu Settings (Registering custom settings)

To allow recording using the same settings, up to 5 sets of current camera settings can be registered using [Cust.Set Mem.]. (C1, C2, C3-1, C3-2, C3-3)

Preparations: Set in advance the Recording Mode you wish to save and select the desired menu settings on the camera.

1 Select the menu. (P28)

MENU → f_C [Custom] → [Cust.Set Mem.]

2 Press $\blacktriangle/\blacktriangledown$ to select the custom set to register and then press [MENU/SET].

- Confirmation screen is displayed. It is executed when [Yes] is selected.
Exit the menu after it is executed.

Recording using registered custom set

You can easily call up the settings you have registered using [Cust.Set Mem.].

Set the mode dial to [C1], [C2] or [C3]

- The custom set will be called up. If you set the mode dial to [C3], the custom set you used last time ([C3-1], [C3-2], or [C3-3]) will be called up.

■ To change a custom set in [C3]

1 Set the mode dial to [C3].

2 Press [MENU/SET] to display the menu.

3 Press $\blacktriangleleft/\blacktriangleright$ to select the custom setting you want to use, and then press [MENU/SET].

■ Changing the settings

Registered contents do not change when the menu setting is changed temporarily with the mode dial set to C1, C2 or C3. To change the registered settings, overwrite the registered content using [Cust.Set Mem.] on the custom settings menu.

Playing Back Pictures on a TV Screen

Preparations: Turn this unit and the TV off.

1 Connect the camera and a TV.

- Check the direction of the terminals and plug in/out straight holding onto the plug. (It may result in malfunction by the deforming of the terminal if it is plugged in obliquely or in wrong direction.)
Do not connect devices to incorrect terminals. Doing so may cause malfunction.

To connect with an HDMI micro cable

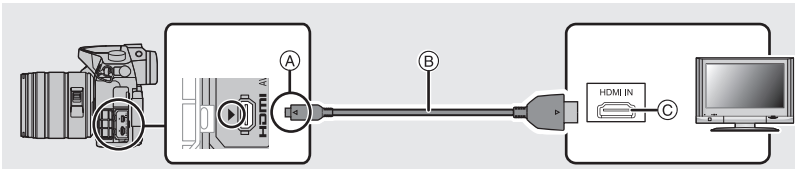

- Use a "High Speed HDMI micro cable" with the HDMI logo. Cables that do not comply with the HDMI standards will not work.
"High Speed HDMI micro cable" (Type D–Type A plug, up to 2 m (6.6 feet) long)

- (A) Align the marks, and insert. (C) HDMI socket
(B) HDMI micro cable

To connect with an AV cable (optional)

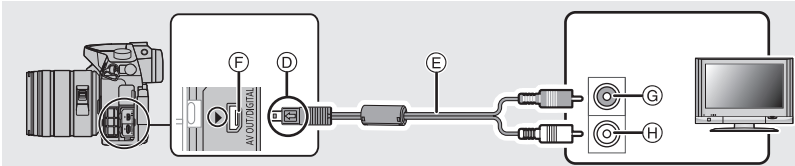

- Always use a genuine Panasonic AV cable (DMW-AVC1: optional).
- When [System Frequency] is set to [24.00 Hz (CINEMA)], you cannot play back images on a TV connected with an AV cable.

- (D) Align the marks, and insert. (G) Yellow: to the video input socket
(E) AV cable (optional) (H) White: to the audio input socket
(F) [AV OUT/DIGITAL] terminal
• The color of the terminal is gold.

2 Turn on the TV and select the input to match the connector in use.

3 Turn the camera on and then press [▶].

- Input of the TV will switch automatically and playback screen is displayed when connected to a VIERA Link compatible TV using an HDMI micro cable with the [VIERA Link] set to [ON].

- When [System Frequency] is set to a broadcasting system different from that of your region, images may not be played back correctly.
- Read the operating instructions for the TV.

Saving still pictures and motion pictures on your PC

■ PC that can be used

The unit can be connected to any PC capable of recognizing a mass storage device.

- Windows support: Windows XP/Windows Vista/Windows 7/Windows 8/Windows 8.1
- Mac support: OS X v10.5 to v10.9



AVCHD motion pictures may not be imported correctly when copied as files or folder

- With Windows, always import AVCHD motion pictures using "PHOTOfunSTUDIO", one of the programs on the DVD (supplied).
- With a Mac, AVCHD motion pictures can be imported using "iMovie". Please note that importing is not possible depending on the picture quality. (For details about iMovie, please contact Apple Inc.)

About the supplied software

The supplied DVD includes the following software.
Install the software on to your computer before use.

• PHOTOfunSTUDIO 9.5 PE (Windows XP/Windows Vista/Windows 7/Windows 8/Windows 8.1)

This software allows you to manage images. For example, you can send pictures and motion pictures to a PC and sort them by recording date or model name. You can also perform operations such as writing images to a DVD, processing and correcting images, and editing motion pictures.

• SILKYPIX Developer Studio 4.1 SE

(Windows XP/Windows Vista/Windows 7/Windows 8/Windows 8.1, Mac OS X v10.5/v10.6/v10.7/v10.8/v10.9)

This is software to edit RAW format images.

Edited images can be saved in a format (JPEG, TIFF, etc.) that can be displayed on a personal computer.

For details on how to use the SILKYPIX Developer Studio, refer to the "Help" or the Ichikawa Soft Laboratory's support website:
<http://www.isl.co.jp/SILKYPIX/english/p/support/>

• LoiLoScope 30 day full trial version (Windows XP/Windows Vista/Windows 7/Windows 8/Windows 8.1)

LoiLoScope is a video editing software where that draws out the full power of your PC. Creating videos is as easy as organizing cards on top of a desk. Use your music, picture and video files to create videos to share with your friends and family by burning it to a DVD, uploading it to websites, or simply share your videos with your friends via e-mail.

– This will only install a shortcut to the trial version download site.

For more information on how to use LoiLoScope, read the LoiLoScope manual available for download at the link below.
Manual URL: <http://loilo.tv/product/20>

■ Installing supplied software

- Before inserting the DVD, close all running applications.

1 Check the environment of your PC.

• Operating environment of “PHOTOfunSTUDIO”

– OS:

- Windows® XP (32bit) SP3,
- Windows Vista® (32bit) SP2,
- Windows® 7 (32bit/64bit) or SP1,
- Windows® 8 (32bit/64bit),
- Windows® 8.1 (32bit/64bit)

– CPU:

- Pentium® III 500 MHz or higher (Windows® XP),
- Pentium® III 800 MHz or higher (Windows Vista®),
- Pentium® III 1 GHz or higher (Windows® 7/Windows® 8/Windows® 8.1)

– Display:

- 1024×768 pixels or more (1920×1080 pixels or more recommended)

– RAM:

- 512 MB or more (Windows® XP/Windows Vista®),
- 1 GB or more (Windows® 7 32bit/Windows® 8 32bit/Windows® 8.1 32bit),
- 2 GB or more (Windows® 7 64bit/Windows® 8 64bit/Windows® 8.1 64bit)

– Free hard disk space:

- 450 MB or more for installing software

- Refer to the operating instructions of “PHOTOfunSTUDIO” (PDF) for further operating environment.
- For details on “SILKYPIX Developer Studio”, please read the support site given on P88.

2 Insert the DVD with the supplied software.

3 Click on the [Applications] on the install menu.

- If the automatic playback screen is displayed, you can display the menu by selecting and executing [InstMenu.exe].
- In Windows 8/Windows 8.1, you can display the menu by clicking a message that is displayed after inserting the DVD and then selecting and executing [InstMenu.exe].
- You can also display the menu by double-clicking [VFFXXXX] in [Computer] (XXXX differs depending on the model).

4 Click on the [Recommended Installation].

- Proceed with installation according to messages appearing on the screen.

- The software compatible with your PC will be installed.
- On the Mac, SILKYPIX can be installed manually.

- 1 Insert the DVD with the supplied software.
- 2 Double-click the application folder on the DVD.
- 3 Double-click on the automatically displayed folder.
- 4 Double-click the icon in the application folder.



Not available in these cases:

- “PHOTOfunSTUDIO” and “LoiLoScope” are not compatible with Mac.

■ Transferring pictures to a PC

Preparations: Install "PHOTOfunSTUDIO" to the PC.

1 Connect the computer and camera with the USB connection cable (supplied).

- Please turn this unit on and your PC before connecting.
- Check the direction of the terminals and plug in/out straight holding onto the plug.
- Do not use any other USB connection cables except the supplied one or a genuine Panasonic USB connection cable (DMW-USBC1: optional).

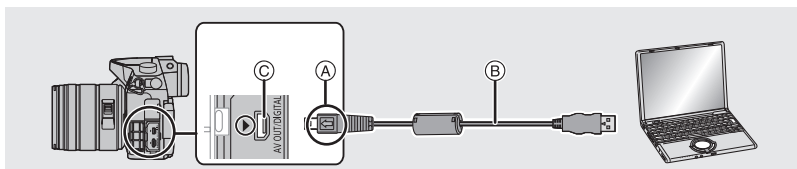

- (A) Align the marks, and insert.
- (B) USB connection cable (supplied)
- (C) [AV OUT/DIGITAL] terminal
 - The color of the terminal is gold.

2 Press ▲/▼ to select [PC], and then press [MENU/SET].

- If [USB Mode] (P105) is set to [PC] in the [Setup] menu in advance, the camera will be automatically connected to the PC without displaying the [USB Mode] selection screen.

3 Copy the images to a PC using "PHOTOfunSTUDIO".

- Do not delete or move copied files or folders in Windows Explorer. When viewing in "PHOTOfunSTUDIO", you will not be able to play back or edit.

■ Copying to a PC without using “PHOTOfunSTUDIO”

If you are not able to install “PHOTOfunSTUDIO”, you can copy files and folders to your PC by dragging and dropping files from this unit.

• The content (folder structure) on the card of this unit is as follows.

For Windows: A drive ([LUMIX]) is displayed in [Computer]

For Mac: A drive ([LUMIX]) is displayed on the desktop

• Card

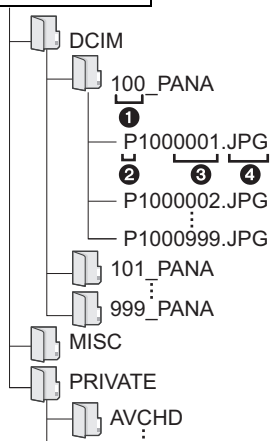

DCIM:

- ❶ Folder number
- ❷ Color space
- ❸ File number
- ❹ JPG:

MP4:
MOV:
RW2:
MPO:

MISC:

AVCHD:

Images

P: sRGB
_: AdobeRGB

Still pictures
[MP4] Motion pictures
[MOV] Motion pictures
Pictures in RAW files
3D pictures
DPOF print
Favorite
[AVCHD] Motion pictures





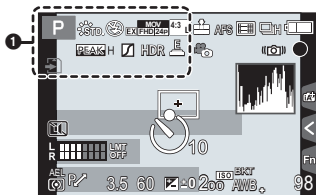

Monitor Display/Viewfinder Display











- The following images are examples of when the display screen is set to  (monitor style) in the monitor.
- Please also refer to the “Owner’s Manual for advanced features (PDF format)”, which describes more detailed information.

In recording



1

	Recording Mode (P22)
C 1	Custom settings (P86)
	Photo Style (P99)
	Creative control adjustment display
	Flash Mode (P57)
	Flash
	Extended Tele Conversion (when recording motion pictures) (P100)
	Recording quality (P59)

	Recording format/ Recording quality* ¹ (P59)/ Variable Frame Rate* ¹ (P66)
	Picture size/Aspect Ratio (P47)
	Extended Tele Conversion (when taking still pictures) (P100)
	Card (displayed only during recording)
8m30s	Elapsed recording time* ² (P58)
	Simultaneous recording indicator
	Automatic viewfinder/ monitor switching (P25)
	Peaking (P103)
	Highlight Shadow (P99)
HDR	HDR (P99)/iHDR (P32)
	Multi exposure (P100)
	Digital Zoom (P100)
	Electronic shutter (P100)
100%	Variable Frame Rate (P66)

In recording

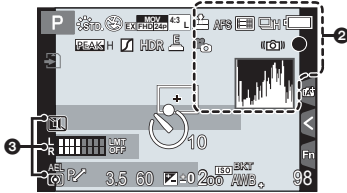

2

	RAW	Quality (P99)
	AFS AFF AFC MF	Focus Mode (P37, 40)
	AF Mode (P36)	
	Face Recognition (P100)	
	AFL	AF Lock (P55)
	Burst (P41)	
	Auto Bracket (P42)	
	Self-timer (P42)	
	Time Lapse Shot (P43)	
	Stop Motion Animation (P45)	
	Battery indication	

	Battery Grip
	Picture Mode (Still picture priorities) (P101)
	Optical Image Stabilizer* ³ (P27)
	Jitter alert
	Recording state (Flashes red.) (P58)/ Focus (Lights green.) (P21)
	Focus (Under low illumination)
	Connected to Wi-Fi
	Histogram (P103)
3	
	Name* ⁴ (P100)
	Number of days that have passed since the departure date* ⁵ (P104)
	Age* ⁴ (P100)
	Location* ⁵ (P104)
	Current date and time/Travel destination setting* ⁵ : (P104)

In recording

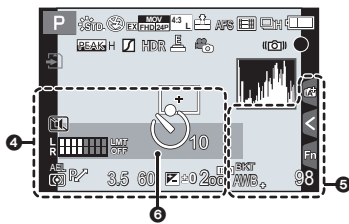

	AF area (P38)
	Spot metering target (P54)
	Self-timer ^{*6} (P42)
	Silent Mode (P102)
	External Microphone
	Mic level display (P102)
	Mic Level Limiter (OFF) (P102)
TC 00:00:00:00	Time Code (P101)
	AE Lock (P55)
	Metering Mode (P54)
	Program Shift (P51)
3.5	Aperture value (P21)
60	Shutter speed (P21)
11d	Shutter speed (angle) (P102)

	Exposure compensation value (P54)
	Brightness (P32)
	Manual Exposure Assistance (P53)
200	ISO sensitivity (P49)
0dB	Gain (dB) (P102)

	White Balance Bracket
	White Balance Fine Adjustment
	White Balance (P50)
	Color (P32)
98	Number of recordable pictures
r20	Maximum number of pictures that can be taken continuously
R8m30s	Available recording time ^{*1, 2}
	Touch tab ^{*7}
	Touch tab ^{*7} (P85)
	Touch tab ^{*7}
	Touch tab ^{*7}
	Touch tab ^{*7} (P62)

	Exposure meter (P103)
	Focal distance display
	Step zoom

- *1 This is displayed only when [Video-Priority Display] (P104) in the [Custom] menu is set to [ON].
- *2 h: hour, m: minute, s: second
- *3 Only available when a lens that supports the Stabilizer function is attached.
- *4 This is displayed for about 5 seconds when the camera is turned on if the [Profile Setup] setting is set.
- *5 This is displayed for about 5 seconds when the camera is turned on, after setting the clock and after switching from Playback Mode to Recording Mode.
- *6 This is displayed during countdown.
- *7 Only displayed in the monitor.

In recording

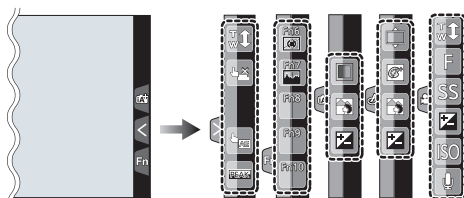

• Only displayed in the monitor.

	Touch zoom		Defocus control function (P32)
	Touch Shutter (P34)		Brightness (P32)
	Touch AE (P35)		Type of defocus ([Miniature Effect])
	Peaking (P103)		One point color
	Fn6 (Function button) (P85)		Position of the light source
	Fn7 (Function button) (P85)		Creative control adjustment
	Fn8 (Function button) (P85)		Aperture value (P21)
	Fn9 (Function button) (P85)		Shutter speed (P21)
	Fn10 (Function button) (P85)		ISO sensitivity (P49)
	Color (P32)		Gain (dB) (P102)
			Microphone level adjustment (P102)

In recording

On-monitor recording information

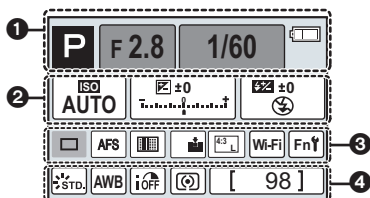

1

IA IA* P A S	Recording Mode (P22)
M P P EXP	
F2.8	Aperture value (P21)
1/60	Shutter speed (P21)
11d	Shutter speed (angle) (P102)
	Battery indication

2

ISO AUTO	ISO sensitivity (P49)
0dB	Gain (dB) (P102)
	Exposure compensation value (P54)
	Brightness (P32)
	Manual Exposure Assistance (P53)
	Flash Mode (P57)
	Flash

3

	Single (P41)
	Burst (P41)
	Auto Bracket (P42)
	Self-timer (P42)
	Time Lapse Shot (P43)
	Stop Motion Animation (P45)
	Focus Mode (P36, 40)
	AF Mode (P36)
	Quality (P99)
	Picture size/Aspect Ratio (P47)
	Wi-Fi (P74)
	Function button setting (P85)

4

	Photo Style (P99)
	White Balance (P50)
	Intelligent Dynamic Range Control (P99)
	Metering Mode (P54)
98	Number of recordable pictures
r20	Maximum number of pictures that can be taken continuously
R8m30s	Available recording time

Message Display

Confirmation messages or error messages will be displayed on the screen in some cases. The major messages are described below as examples.

- Please also refer to the “Owner’s Manual for advanced features (PDF format)”, which describes more detailed information.

[Some pictures cannot be deleted]/[This picture cannot be deleted]

- This feature can only be used with pictures that comply with the DCF standard. Perform formatting (P29) on this unit after saving necessary data on a PC, etc.

[Memory Card Error Format this card?]

- It is a format that cannot be used with this unit.
 - Insert a different card.
 - Format the card again with the camera after saving necessary data on a PC etc. (P29)
Data will be deleted.

[The lens is not attached properly. Do not push lens release button while lens is attached.]

- Detach the lens once, and then attach it again without pressing the lens release button. (P18)
Turn this unit on again, and if it is still displaying, contact the dealer.

[Memory Card Error]/[This memory card cannot be used]

- Use a card compatible with this unit. (P15)

[Insert SD card again]/[Try another card]

- An error has occurred accessing the card.
Insert the card again.
- Insert a different card.

[Read Error/Write Error Please check the card]

- It has failed to read or write data.
Remove the card after turning this unit off. Insert the card again, turn this unit on, and try to read or write the data again.
- The card may be broken.
- Insert a different card.

[Motion recording was cancelled due to the limitation of the writing speed of the card]

- Depending on the [Rec Format] and [Rec Quality] of a motion picture, the speed class rating required for the card differs. Use a card that meets the rating. For details, refer to “About the motion picture recording and speed class” on P15.
- If the recording stops even when you are using a card that meets the speed class rating, the data writing speed is too slow. We recommend making a backup and then format the card (P29).
Depending on the type of the card, motion picture recording may stop in the middle.

[This battery cannot be used]

- Use a genuine Panasonic battery. If this message is displayed even when a genuine Panasonic battery is used, contact the dealer or Panasonic.
- If the battery terminal is dirty, clean it and remove any objects.

[Failed to connect wireless access point]/[Connection failed]/[No destination found]

- Check following regarding the wireless access point.
 - The wireless access point information set on this unit is wrong.
Check the authentication type, encryption type, and encryption key.
 - Power of the wireless access point is not turned on.
 - Setting of the wireless access point is not supported by this unit.
- Check the network setting of the destination.
- Radio waves from other devices may block the connection to a wireless access point.
Check other devices that are connected to the wireless access point and devices that use the 2.4 GHz band.

[No picture to send]

- This is displayed when there is no image to transmit due to the restriction of the destination.
Check the file format of the image to send.

[Connection failed. Please retry in a few minutes.]/[Network disconnected. Transfer stopped.]

- Radio waves from the wireless access point are getting weak.
Perform the connection closer to the wireless access point.
- There is no reply from the server or it has exceeded the communication processing time.
Try again after a while.
- Depending on the wireless access point, connection may be automatically disconnected after specific time has passed.
Reconnect the connection again.

[Connection failed]

- Check following regarding the smartphones/tablet you intend to connect.
 - The smartphone/tablet does not operate.
 - Change the access point to connect to in the smartphone/tablet Wi-Fi settings to this camera.
 - There is no free storage space on the smartphone/tablet.

Menu list

- [Photo Style], [AFS/AFF], [Metering Mode], [Highlight Shadow], [i.Dynamic], [i.Resolution] and [Digital Zoom] are common to both the [Rec] menu and [Motion Picture] menu. Changing these settings in one of these menus is reflected in other menu.

[Rec]

[Photo Style]	You can select effects to match the type of image you wish to record. You can adjust the color and image quality of the effects.
[Aspect Ratio]	Sets the aspect ratio of the image.
[Picture Size]	Set the number of pixels.
[Quality]	Set the compression rate at which the pictures are to be stored.
[AFS/AFF]	Assigns [AFS] or [AFF] to [AFS/AFF] of the focus mode lever.
[Metering Mode]	Sets the light metering method for measuring brightness.
[Burst Rate]	Sets the burst speed for burst recording.
[Auto Bracket]	Sets single/burst recording, compensation range and recording sequence for Auto Bracket recording.
[Self Timer]	Sets the manner in which the self-timer works.
[Time Lapse/Animation]	Makes the recording settings for Time Lapse Shot and Stop Motion Animation.
[Highlight Shadow]	You can adjust the brightness of bright and dark portions on an image while checking the brightness on the screen.
[i.Dynamic] (Intelligent dynamic range control)	Adjusts the contrast and exposure.
[i.Resolution]	Records pictures with more defined outlines and sense of clarity.
[iHandheld Night Shot]	Pictures of the night scenery will be taken at a high burst speed and composed into a single picture.
[iHDR]	There is, for example, strong contrast between the background and the subject, multiple still pictures are recorded with differing exposures and combined to create a single still picture rich in gradation.
[HDR]	You can combine 3 pictures with different levels of exposure into a single picture with rich gradation.

[Multi Exp.]	Gives an effect like multi exposure. (up to 4 times equivalent per a single image)
[Electronic Shutter]	The shutter sound can be turned off for recording in a quiet environment.
[Shutter Delay]	To reduce the influence of hand shake, the shutter is released when a specified time period has elapsed since the shutter button was pressed.
[Flash]	Sets the manner in which the flash works.
[Red-Eye Removal]	Automatically detects red-eye caused by the flash and corrects the image data accordingly.
[ISO Limit Set]	When the ISO sensitivity is set to [AUTO] or [ISO], an optimal ISO sensitivity is set with the selected value as an upper limit.
[ISO Increments]	The ISO sensitivity settings values changes in steps of 1/3 EV or 1 EV.
[Extended ISO]	ISO sensitivity can be set up to minimum [ISO100].
[Long Shtr NR]	You can eliminate the noise caused by recording with a slower shutter speed.
[Shading Comp.]	If the screen periphery darkens as a result of lens characteristics, the brightness in this region will be corrected.
[Ex. Tele Conv.]	When the number of pixels is set to anything other than [L], the Tele effect is increased without degradation in image quality.
[Digital Zoom]	Increases the Tele effect. The higher the level of magnification, the greater the degradation in image quality.
[Color Space]	Set this when you want to correct the color reproduction of the recorded pictures on a PC, printer etc.
[Stabilizer]	When camera shake is sensed during recording, the camera corrects it automatically.
[Face Recog.]	Sets the focus and exposure automatically prioritizing registered faces.
[Profile Setup]	If you set the name and birthday of your baby or pet in advance, you can record their name and age in months and years in the images.

[Motion Picture]

[Photo Style]	You can select effects to match the type of image you wish to record. You can adjust the color and image quality of the effects.
[Rec Format]	Sets the file format for the motion pictures you record.
[Rec Quality]	This sets up the picture quality of motion pictures.
[Exposure Mode]	Select the method for setting the aperture value and shutter speed in Creative Video Mode.
[Variable Frame Rate]	You can record slow motion or fast motion pictures in Creative Video Mode.
[AFS/AFF]	Assigns [AFS] or [AFF] to [AFS/AFF] of the focus mode lever.
[Picture Mode]	Sets the recording method for still pictures during motion picture recording.
[Continuous AF]	Continues to focus on the subject for which focus has been achieved.
[Metering Mode]	Sets the light metering method for measuring brightness.
[Highlight Shadow]	You can adjust the brightness of bright and dark portions on an image while checking the brightness on the screen.
[i.Dynamic] (Intelligent dynamic range control)	Adjusts the contrast and exposure.
[i.Resolution]	Records pictures with more defined outlines and sense of clarity.
[Master Pedestal Level]	You can adjust black, which serves as the reference for images in Creative Video Mode, in 31 steps.
[Luminance Level]	Sets the luminance range for motion pictures.
[Synchro Scan]	You can reduce flickering and stripes on images in Creative Video Mode.
[Ex. Tele Conv.]	Increases the Tele effect.
[Digital Zoom]	Increases the Tele effect. The higher the level of magnification, the greater the degradation in image quality.
[Time Code]	Sets the time code.
[HDMI Rec Output]	Sets the HDMI output method to be used during recording.

[Sound Output]	Sets the sound output method for the connected headphone set (commercially available). The setting also applies to the sound to be displayed as a mic level.
[Silent Operation]	Enables touch operations to allow silent use while recording motion pictures.
[Mic Level Disp.]	Set whether or not the mic levels are displayed on the recording screen.
[Mic Level Adj.]	Adjust the sound input level to 19 different levels.
[Special Mic.]	Sets the sound recording method when a stereo shotgun microphone (optional) is connected.
[Mic Level Limiter]	Adjusts the sound input level automatically.
[Wind Cut]	This prevents the recording of wind-noise automatically.
[Lens Noise Cut]	You can reduce the zoom sound of an interchangeable lens compatible with power zoom that is produced during motion picture recording.
[SS/Gain Operation]	You can switch the units of shutter speed values and gain (sensitivity) values.
[Color Bars]	Displays color bars, which are convenient for adjusting the picture quality of the external monitor and some other settings.

[Custom]

[Cust.Set Mem.]	Registers the current camera settings as custom set.
[Silent Mode]	Disables operational sounds and output of light at once.
[AF/AE Lock]	Sets the fixed content for focusing and exposure when the AF/AE lock is on.
[AF/AE Lock Hold]	This will set the operation of [AF/AE LOCK] button when taking a picture with fixed focus or exposure.
[Shutter AF]	Set whether or not the focus is adjusted automatically when the shutter button is pressed halfway.
[Half Press Release]	The shutter will immediately fire when the shutter button is pressed halfway.
[Quick AF]	Speeds up the focusing that takes place when you press the shutter button.
[Eye Sensor AF]	The camera automatically adjusts the focus when the eye sensor is active.

[Pinpoint AF Time]	Sets the time for which the screen is enlarged when the shutter button is pressed halfway with Auto Focus Mode set to [+] .
[AF Assist Lamp]	AF assist lamp will illuminate the subject when the shutter button is pressed half-way making it easier for the camera to focus when recording in low light conditions.
[Direct Focus Area]	Moves the AF area or MF assist using the cursor button when recording.
[Focus/Release Priority]	It will set so no picture can be taken when it is out of focus.
[AF+MF]	You can set the focus manually after the automatic focus has finished.
[MF Assist]	Sets the display method of MF Assist (enlarged screen).
[MF Guide]	When you set the focus manually, an MF guide that allows you to check the direction to achieve focus is displayed.
[Peaking]	In-focus portions are highlighted when focus is being adjusted manually.
[Histogram]	This allows you to set either to display or not display the histogram.
[Guide Line]	This will set the pattern of guide lines displayed when taking a picture.
[Center Marker]	Displays [+] , which indicates the center of the recording screen.
[Highlight]	When the Auto Review function is activated or when playing back, white saturated areas appear blinking in black and white.
[Zebra Pattern]	Indicates parts that may be whited out through overexposure in a zebra pattern.
[Monochrome Live View]	You can display the recording screen in black and white.
[Constant Preview]	You can check the effects of the chosen aperture and shutter speed on the recording screen in Manual Exposure Mode.
[Expo.Meter]	Set whether or not to display the exposure meter.
[LVF Disp.Style]	This will set the display style of the viewfinder.
[Monitor Disp. Style]	This will set the display style of the monitor.
[Monitor Info. Disp.]	Display the recording information screen.
[Rec Area]	This changes the angle of view during motion picture recording and still picture recording.

[Video-Priority Display]	Switches screens to those suitable for motion picture recording.
[Auto Review]	Displays a picture immediately after it is taken.
[Fn Button Set]	You can assign frequently-used functions to particular buttons or icons.
[Q.MENU]	Switch the setting method of Quick Menu.
[Dial Set.]	Changes the operation methods of the front dial and rear dial.
[Video Button]	Enables/disables the motion picture button.
[Power Zoom Lens]	Sets the screen display and lens operations when using an interchangeable lens that is compatible with power zoom (electrically operated zoom).
[Lens w/o Focus Ring]	Sets the control dial operation for MF Assist.
[Eye Sensor]	Setting the eye sensor sensitivity and the method for switching between the monitor and viewfinder.
[Touch Settings]	Enables/disables the Touch operation.
[Touch Scroll]	This allows you to set the speed of continuously forwarding or rewinding pictures using touch operation.
[Menu Guide]	Set the screen that is displayed when the mode dial is set to  .
[Shoot w/o Lens]	Sets whether or not the shutter can be released when no lens is attached to the main body.

[Setup]

[Clock Set]	Setting Date/Time.
[World Time]	Sets the times for the region where you live and your holiday destination.
[Travel Date]	Departure date and return date of the trip as well as the name of the travel destination can be set.
[Wi-Fi]	Configure the each setting for Wi-Fi functions.
[Beep]	Set the volume for electronic noises and the electronic shutter noise.
[Speaker Volume]	Adjust the volume of the speaker to any of 7 levels.

[Headphone Volume]	Adjust the volume of the connected headphone set (commercially available) in 16 steps.
[Live View Mode]	Set the frame rate of the recording screen (Live View screen).
[Monitor Display]/ [Viewfinder]	Brightness, color, or red or blue tint of the Monitor/viewfinder is adjusted.
[Monitor Luminance]	Set the monitor brightness to suit the amount of surrounding light.
[Economy]	Suppresses the unit's power consumption to prevent the battery from being run down.
[Battery Use Priority]	When batteries are inserted to both this unit and the battery grip, you can set that which battery should be used first.
[USB Mode]	Sets the communication method when connecting using the USB connection cable (supplied).
[TV Connection]	This sets how the unit connects to a television etc.
[Menu Resume]	Stores the location of the last-used menu item for each menu.
[Menu Background]	Set the background color for the menu screen.
[Menu Information]	Descriptions of menu items or their settings are displayed on the menu screen.
[Language]	Set the language displayed on the screen.
[Version Disp.]	This enables the firmware versions of the camera and lens to be checked.
[Exposure Comp. Reset]	An exposure value can be reset when the Recording Mode is changed or the camera is turned off.
[No.Reset]	Returns the image file number to 0001.
[Reset]	The recording or setup/custom settings are reset to the default.
[Reset Wi-Fi Settings]	Reset all settings in the [Wi-Fi] menu to factory default settings. (Excluding [LUMIX CLUB])
[System Frequency]	Changes the system frequency of motion pictures you record with and play back on the camera.
[Pixel Refresh]	It will perform optimization of imaging device and image processing.
[Sensor Cleaning]	Dust reduction to blow off the debris and dust that have affixed to the front of the imaging device is performed.
[Format]	The card is formatted.

[Playback]

[2D/3D Settings]	Switches the playback method for 3D images.
[Slide Show]	Selects the type etc. of the images and plays back in order.
[Playback Mode]	Selects the type etc. of the images and plays back only particular images.
[Location Logging]	You can write location information (longitude/latitude) on images sent from the smartphone/tablet.
[RAW Processing]	You can convert the pictures taken in the RAW format into the JPEG format on the camera.
[Clear Retouch]	You can erase unnecessary parts recorded on the pictures taken.
[Title Edit]	Input texts (comments) on the recorded pictures.
[Text Stamp]	Stamps the recorded pictures with recording date and time, names, travel destination, travel date, etc.
[Video Divide]	Splits the recorded motion picture in two.
[Time Lapse Video]	Creates a motion picture from a set of group pictures recorded with the [Time Lapse Shot].
[Stop Motion Video]	Creates a motion picture from the Stop Motion Animation group.
[Resize]	Reduces the image size (number of pixels).
[Cropping]	Crops the recorded image.
[Rotate]	Rotate pictures manually in 90° steps.
[Rotate Disp.]	This mode allows you to display pictures vertically if they were recorded holding the camera vertically.
[Favorite]	Marks can be added to images, and images can be set as favorites.
[Print Set]	Sets the images for printing and the number of prints.
[Protect]	Protects images to prevent deletion by mistake.
[Face Rec Edit]	Removes or changes information relating to personal identity.
[Picture Sort]	Sets the display order of the images you play back on the camera.
[Delete Confirmation]	This sets which option, [Yes] or [No], will be highlighted first when the confirmation screen for deleting a picture is displayed.

Troubleshooting

First, try out the following procedures (P107–P112).

If the problem is not resolved, it may be improved by selecting [Reset] (P29) on the [Setup] menu.

- Please also refer to the “Owner’s Manual for advanced features (PDF format)”, which describes more detailed information.

**The camera cannot be operated even when it is turned on.
The camera turns off immediately after it is turned on.**

- The battery is exhausted.
 - Charge the battery.
- If you leave the camera on, the battery will be exhausted.
 - Turn the camera off frequently by using the [Economy] etc. (P29)

The subject is not focused properly.

- The subject is beyond the focus range of the camera. (P21)
- There is camera shake (jitter) or the subject is moving slightly. (P27)
- Is [Focus/Release Priority] in the [Custom] menu set to [RELEASE]? (P103)
- Is [Shutter AF] in the [Custom] menu set to [OFF]? (P102)
- Is the AF Lock (P55) applied incorrectly?

**The recorded picture is blurred.
The Optical Image Stabilizer is not effective.**

- The shutter speed will become slower and the Optical Image Stabilizer function may not work properly when taking pictures especially in dark places.
 - We recommend holding the camera firmly with both hands when taking pictures. (P20)
 - We recommend using a tripod and the self-timer (P42) when taking pictures with a slow shutter speed.

Striping or flicker may appear under lighting such as fluorescent lighting and LED lighting fixture.

- This is characteristic of MOS sensors which serve as the camera’s pickup sensors.
 - This is not a malfunction.
- Is [Electronic Shutter] set to [ON]? (P56)
 - If you set [Electronic Shutter] to [ON] and slow down the shutter speed, the stripes may appear less intense.



Recording motion pictures is not possible.

- If you continue to use the same card after changing [System Frequency] (P105), motion pictures may not be recorded. To record with the same card, reset [System Frequency] to the original setting. To record motion pictures with the current setting, try the following:
 - Perform formatting (P29) on this unit after saving necessary data on a PC, etc.
 - Insert a different card.
- You may not be able to record for a short while after turning this unit on when using a large capacity card.

The screen may be blacked out momentarily, or the unit may record noise.

- Depending on the environment at the time of motion picture recording, the screen may be blacked out momentarily or the unit may record noise due to static electricity or powerful electromagnetic waves (radio towers, high voltage power lines, etc.).

The flash is not activated.

- Is the flash closed?
 - Open the flash. (P57)
- When the electronic shutter is used, the flash is not activated. (P56)
 - Set [Electronic Shutter] to [OFF].
- When [Silent Mode] is set to [ON], the flash is not activated. (P102)
 - Set [Silent Mode] to [OFF].

Monitor and viewfinder do not switch when [LVF] is pressed.

- It is only displayed on the monitor when the camera is connected to a PC or printer.

**The picture is not played back.
There are no recorded pictures.**

- Is the card inserted?
- Is there a picture on the card?
- Is this a folder or picture which was processed in the PC?
If it is, it cannot be played back by this unit.
→ It is recommended to use the "PHOTOfunSTUDIO" software in the DVD (supplied) to write pictures from PC to card.
- Has [Playback Mode] been set for playback?
→ Change to [Normal Play].

Cannot play back motion pictures.

- Motion pictures recorded with a different [System Frequency] setting cannot be played back. (P67)
→ Return the [System Frequency] setting to the one you used during the recording.

The folder number and the file number are displayed as [—] and the screen turns black.

- Is this a non-standard picture, a picture which has been edited using a PC or a picture which was taken by another make of digital camera?
- Did you remove the battery immediately after picture-taking or did you take the picture using a battery with a low remaining charge?
→ To delete such pictures, make a backup of the data and format the card (P29).

[Thumbnail is displayed] appears on the screen.

- Is it a picture that has been recorded with other equipment?
In such cases, these pictures may be displayed with a deteriorated picture quality.

Motion pictures recorded with this model cannot be played back on other equipment.

- The picture quality or sound quality of recorded motion pictures may be deteriorated even when these are played back with the compatible devices. Also, recording information may not be displayed correctly.

**A Wi-Fi connection cannot be established.
Radio waves get disconnected.
Wireless access point is not displayed.**

■ General tips for using a Wi-Fi connection

- Use within the communication range of the device to be connected.
- Is any device, such as microwave oven, cordless phone, etc., that uses 2.4 GHz frequency operated nearby?
→ Radio waves may get interrupted when used simultaneously. Use them sufficiently away from the device.
- When the battery indicator is flashing red, the connection with other equipment may not start or the connection may be disrupted.
(A message such as [Communication error] is displayed.)
- If you place the camera on a metal table or shelf, the radio waves may be adversely affected. In such cases, you may not be able to establish a connection. Move the camera away from the metal surface.

■ About a wireless access point

- Check if the wireless access point to connect is in operating state.
- The camera may not display or connect to a wireless access point depending on the radio wave condition.
→ Move this unit closer to the wireless access point.
→ Remove the obstacles between this unit and the wireless access point.
→ Change the direction of this unit.
→ Change the location and orientation of the wireless access point.
→ Perform the [Manual Input].
- It may not display even if the radio waves exist depending on the setting of the wireless access point.
→ Check the settings of the wireless access point.
→ When the network SSID of the wireless access point is set not to broadcast, the wireless access point may not be detected. Enter the network SSID to start the connection or enable the SSID broadcast of the wireless access point.
- Connection types and security setting methods are different depending on the wireless access point. (Refer to the operating instructions of the wireless access point.)
- Is the 5 GHz/2.4 GHz switchable wireless access point connected to other equipment using the 5 GHz band?
→ The use of a wireless access point that can use 5 GHz/2.4 GHz simultaneously is recommended. It cannot be used simultaneously with this camera if it is not compatible.

Images cannot be transmitted to a PC.

- When the firewall of the OS, security software, etc. is enabled, connecting to the PC may not be possible.

The PC is not recognized when I use a Wi-Fi connection. The camera cannot be connected to PC via Wi-Fi connection.

- The default workgroup name is set to "WORKGROUP". If you changed the workgroup name, the PC will not be recognized.
In [Change Workgroup Name] in [PC Connection] of the [Wi-Fi Setup] menu, change the workgroup name to that of the PC you are connecting to.
- Please confirm login name and password are correctly typed.
- When the system time of Mac computer or Windows PC connected to a camera differs severely from that of the camera, the camera cannot be connected to the computer or PC in some OSs.
→ Please confirm [Clock Set] and [World Time] of the camera matches with time, date and time zone in Windows PC or Mac computer. When both settings do not match severely, please match them.

When I try to set up a Wi-Fi connection with a Windows 8 PC, my user name and password are not recognized, so I cannot connect to the PC.

- Some OS versions, including Windows 8, use two types of accounts: a local account and a Microsoft account.
→ Be sure to use the user name and password for the local account.
If you haven't set up a local account, please create one.

Transmission of the image fails midway. Some images cannot be transmitted.

- Is the size of the image too large?
→ Reduce the image size at [Size], and then send.
→ Transmit after dividing the motion picture with [Video Divide] (P72).
- File format of the motion picture that can be sent differs depending on the destination.
- Capacity or number of images in the web service is full.
→ Login to "LUMIX CLUB", and check the status of the destination on the web service link settings.

Cannot be connected using NFC.

- Is your smartphone compatible with NFC?
→ This unit can be used with NFC-compatible terminals via Android (OS version 2.3.3 or higher).
- Make sure the NFC function of your smartphone is ON.
- Some smartphones cannot be easily checked simply by touching.
→ If the camera is not recognized even after touching, change positions and try again by touching slowly.

The motion pictures cannot be played back on a TV.

- Are you trying to play back the motion pictures by directly inserting the card in the card slot of the TV?
 - Connect the camera to the TV with the AV cable (optional), or with the HDMI micro cable, and then play back the motion pictures on the camera. (P87)
- When [System Frequency] is set to a broadcasting system different from that of your region, images may not be played back correctly.
- When [System Frequency] is set to [24.00 Hz (CINEMA)], you cannot play back images on a TV connected with an AV cable.



VIERA Link does not work.

- Is it connected properly with the HDMI micro cable? (P87)
- Is the [VIERA Link] on this unit set to [ON]?
 - If the input channel does not switch automatically, use the remote control for the TV to switch it.
 - Check the VIERA Link setting on the connected device.
 - Turn this unit off and on.
 - Set [HDAVI Control] to [Off] on the TV and then turn it back to [On]. (Refer to the operating instructions of the TV for details.)
 - Check [System Frequency] setting. (P67)

There is a sound from lens unit.

- It is a sound of lens movement or aperture operation when this unit is turned on or off, and it is not a malfunction.
- The sound, which is caused by the automatic adjustment of the aperture, is heard when the brightness has changed due to, for example, zooming or the movement of the camera. This is not a malfunction.

An unreadable language was selected by mistake.

- Press [MENU/SET], select the [Setup] menu icon [, and then select the [] icon to set the desired language.

The camera becomes warm.

- The surface of the camera and the reverse side of the monitor may become warm during use. This does not affect the performance or quality of the camera.

The clock is reset.

- If you do not use the camera for a long time, the clock may be reset.
 - [Please set the clock] message will be displayed; please reset the clock. (P19)

Cautions for Use

- Please also refer to the "Owner's Manual for advanced features (PDF format)", which describes more detailed information.

Optimal use of the camera

Keep this unit as far away as possible from electromagnetic equipment (such as microwave ovens, TVs, video games etc.).

Do not use this unit near radio transmitters or high-voltage lines.

- If you record near radio transmitters or high-voltage lines, the recorded pictures and/or sound may be adversely affected.

Always use the supplied cords and cables.

If you use optional accessories, use the cords and the cables supplied with them.

Do not extend the cords or the cables.

Do not spray the camera with insecticides or volatile chemicals.

- If the camera is sprayed with such chemicals, the body of the camera may be damaged and the surface finish may peel off.

Do not keep rubber or plastic products in contact with the camera for a long period of time.

Cleaning

Before cleaning the camera, remove the battery or the DC coupler (DMW-DCC12: optional), or disconnect the power plug from the outlet. Then wipe the camera with a dry, soft cloth.

- When the camera is soiled badly, it can be cleaned by wiping the dirt off with a wrung wet cloth, and then with a dry cloth.
- Wipe off any dirt or dust on the zoom ring and the focus ring with a dry, dustless cloth.
- Do not use solvents such as benzine, thinner, alcohol, kitchen detergents, etc., to clean the camera, since it may deteriorate the external case or the coating may peel off.
- When using a chemical cloth, be sure to follow the accompanying instructions.

■ About dirt on the image sensor

This camera features an interchangeable lens system so dirt may get inside the camera body when changing lenses. Depending on the recording conditions, dirt on the image sensor may appear on the recorded picture.

To prevent debris or dust adhering to internal parts of the body, avoid changing the lens in a dusty environment and always fit the body cap or a lens when storing the camera. Remove any dirt on the body cap before attaching it.

Dust reduction function

This unit has a dust reduction function that will blow off the debris and dust that have affixed to the front of the imaging device.

This function will function automatically when the camera is turned on, but if you see dust, perform the [Sensor Cleaning] in the [Setup] menu.

Removing dirt on the image sensor

The image sensor is very precise and delicate, so be sure to observe the following when you do have to clean it yourself.

- Blow off the dust on the surface of the image sensor with a commercially available blower brush. Be careful not to blow too strongly.
- Do not put the blower brush further inside than the lens mount.
- Do not let the blower brush touch the image sensor as the image sensor may get scratched.
- Do not use any objects except a blower brush to clean the image sensor.
- If you cannot remove the dirt or dust with the blower, consult the dealer or Panasonic.

■ For care of the viewfinder/eye cup

- Before you remove stains on the viewfinder and eyecup or start other types of cleaning, remove the eyecup (1). Blow away the dust on the viewfinder surface with a blower (commercially available), and wipe the surface lightly with a dry, soft cloth. Attach the eye cup after the cleaning (2).
- Be careful not to lose the eye cup.
- Keep the eye cup out of reach of children to prevent swallowing.

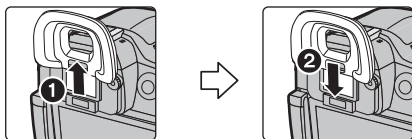

About the Lens

- Do not press the lens with excessive force.
- Do not leave the camera with the lens facing the sun as rays of light from the sun may cause it to malfunction. Also, be careful when placing the camera outside or near a window.
- When there is dirt (water, oil, and fingerprints, etc.) on the surface of the lens, the picture may be affected. Lightly wipe the surface of the lens with a soft, dry cloth before and after taking pictures.
- Do not place the lens mount facing downwards. Do not allow the lens mount contacts (A) to become dirty.

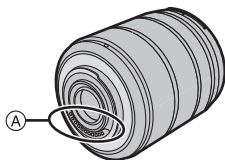

Battery

Always remove the battery after use.

- Place the removed battery in a plastic bag, and store or keep away from metallic objects (clips, etc.).

If you drop the battery accidentally, check to see if the body of the battery and the terminals are damaged.

- Inserting a damaged battery in the camera will damage the camera.

Bring charged spare batteries when going out.

- Be aware that the operating time of the battery becomes shorter in low temperature conditions such as at a ski resort.
- When you travel, do not forget to bring the battery charger (supplied) and the AC cable (supplied) so that you can charge the battery in the country that you are traveling in.

Dispose of unusable battery.

- The battery has a limited life.
- Do not throw the battery into fire because it may cause an explosion.
- The unusable battery should be discarded in accordance with battery recycling laws. Call the RBRC hotline at 1-800-822-8837 for information.

Do not allow battery terminals to come into contact with metal objects (such as necklaces, hairpins, etc.).

- This can cause short-circuiting or heat generation and you may be badly burned if you touch a battery.

Specifications

Specifications are subject to change without notice.

Digital Camera Body (DMC-GH4):

Information for your safety

Power Source:	DC 8.4 V
Power Consumption:	2.7 W (When recording with Monitor) [When the Interchangeable lens (H-HS12035) is used] 1.6 W (When playing back with Monitor) [When the Interchangeable lens (H-HS12035) is used]
Camera effective pixels	16,050,000 pixels
Image sensor	4/3" Live MOS sensor, total pixel number 17,200,000 pixels, Primary color filter
Digital Zoom	Max. 4×
Extended Tele Conversion	When taking still pictures: Max. 2× (When a picture size of [S] (4 M), aspect ratio of [4:3] is selected.) When recording motion pictures: 2.4×/3.6×/4.8×
Focus	Auto Focus/Manual Focus, Face/Eye Detection/Tracking/49-area-focusing/Custom Multi/ 1-area-focusing/Pinpoint (Touch focus area selection possible)
Shutter system	Focal-plane shutter

Burst recording	
Burst speed	40 pictures/second (Super high speed), 12 pictures/second (High speed, AFS), 7 pictures/second (High speed, AFC), 7 pictures/second (Middle speed), 2 pictures/second (Low speed)
Number of recordable pictures	When there are RAW files: 40 pictures When there are no RAW files: 100 or higher pictures * Recording conditions are based on CIPA standards and an SDHC card manufactured by Panasonic is used.
ISO sensitivity (Standard Output Sensitivity)	AUTO/[ISO/100*/200/400/800/1600/3200/6400/12800/25600 (1/3 EV step change possible) *Only available when [Extended ISO] is set.
Minimum Illumination	Approx. 6 lx [when i-Low light is used, the shutter speed is 1/30th of a second (When [System Frequency] is set to [59.94 Hz (NTSC)]) or 1/25th (When [System Frequency] is set to [50.00 Hz (PAL)])] [When the Interchangeable lens (H-HS12035) is used]
Shutter speed	Still picture: B (Bulb) (Max. approx. 60 minutes), 60 seconds to 1/8000th of a second Motion picture: 1/30th of a second to 1/16000th of a second (When [System Frequency] is set to [59.94 Hz (NTSC)])/ 1/25th of a second to 1/16000th of a second (When [System Frequency] is set to [50.00 Hz (PAL)])/ 1/24th of a second to 1/16000th of a second (When [System Frequency] is set to [24.00 Hz (CINEMA)])
Metering range	EV 0 to EV 18
White Balance	Auto White Balance/Daylight/Cloudy/Shade/Incandescent lights/Flash/White set1/White set2/White set3/White set4/ White Balance K set
Exposure (AE)	Program AE (P)/Aperture-priority AE (A)/Shutter-priority AE (S)/Manual exposure (M)/AUTO Exposure Compensation (1/3 EV Step, -5 EV to +5 EV)
Light metering system, Light metering mode	1728-zone multi-pattern sensing system, Multiple/Center weighted/Spot
Monitor	3.0" OLED Monitor (3:2) (Approx. 1,040,000 dots) (field of view ratio about 100%) Touch screen
Viewfinder	OLED Live Viewfinder (4:3) (Approx. 2,360,000 dots) (field of view ratio about 100%) (with diopter adjustment -4 to +4 diopter)

Flash	<p>Built-in pop up flash GN 17.0 equivalent (ISO200·m) [GN 12.0 equivalent (ISO100·m)] Flash range: Approx. 30 cm (0.98 feet) to 17.1 m (56 feet) [When the Interchangeable lens (H-HS12035) is mounted, WIDE, [ISO AUTO] is set] AUTO, AUTO/Red-Eye Reduction, Forced ON, Forced ON/ Red-Eye Reduction, Slow Sync., Slow Sync./Red-Eye Reduction, Forced OFF</p>
Flash synchronization speed	Equal to or smaller than 1/250th of a second
Microphone	Stereo
Speaker	Monaural
Recording media	SD Memory Card/SDHC Memory Card*/SDXC Memory Card* (* UHS-I UHS Speed Class 3)
Picture size	
Still picture	<p>When the aspect ratio setting is [4:3] 4608×3456 pixels, 3264×2448 pixels, 2336×1752 pixels When the aspect ratio setting is [3:2] 4608×3072 pixels, 3264×2176 pixels, 2336×1560 pixels When the aspect ratio setting is [16:9] 4608×2592 pixels, 3840×2160 pixels, 1920×1080 pixels When the aspect ratio setting is [1:1] 3456×3456 pixels, 2448×2448 pixels, 1744×1744 pixels</p>

Recording quality	
Motion pictures	<p>[AVCHD] When [System Frequency] is set to [59.94 Hz (NTSC)] 1920×1080/59.94p (28 Mbps), 1920×1080/59.94i (17 Mbps), 1920×1080/59.94i* (24 Mbps), 1920×1080/23.98p (24 Mbps) (*Sensor output is 29.97 frames/sec.) When [System Frequency] is set to [50.00 Hz (PAL)] 1920×1080/50.00p (28 Mbps), 1920×1080/50.00i (17 Mbps), 1920×1080/50.00i* (24 Mbps) (*Sensor output is 25.00 frames/sec.)</p> <p>[MP4] When [System Frequency] is set to [59.94 Hz (NTSC)] 3840×2160/29.97p (100 Mbps), 1920×1080/59.94p (28 Mbps), 1920×1080/29.97p (20 Mbps), 1280×720/29.97p (10 Mbps), 640×480/29.97p (4 Mbps) When [System Frequency] is set to [50.00 Hz (PAL)] 3840×2160/25.00p (100 Mbps), 1920×1080/50.00p (28 Mbps), 1920×1080/25.00p (20 Mbps), 1280×720/25.00p (10 Mbps), 640×480/25.00p (4 Mbps)</p> <p>[MP4] (LPCM), [MOV] When [System Frequency] is set to [59.94 Hz (NTSC)] 3840×2160/29.97p [100 Mbps (IPB)], 3840×2160/23.98p [100 Mbps (IPB)], 1920×1080/59.94p [200 Mbps (ALL-Intra)], 1920×1080/59.94p [100 Mbps (IPB)], 1920×1080/59.94p [50 Mbps (IPB)], 1920×1080/29.97p [200 Mbps (ALL-Intra)], 1920×1080/29.97p [100 Mbps (IPB)], 1920×1080/29.97p [50 Mbps (IPB)], 1920×1080/23.98p [200 Mbps (ALL-Intra)], 1920×1080/23.98p [100 Mbps (IPB)], 1920×1080/23.98p [50 Mbps (IPB)] When [System Frequency] is set to [50.00 Hz (PAL)] 3840×2160/25.00p [100 Mbps (IPB)], 1920×1080/50.00p [200 Mbps (ALL-Intra)], 1920×1080/50.00p [100 Mbps (IPB)], 1920×1080/50.00p [50 Mbps (IPB)], 1920×1080/25.00p [200 Mbps (ALL-Intra)], 1920×1080/25.00p [100 Mbps (IPB)], 1920×1080/25.00p [50 Mbps (IPB)] When [System Frequency] is set to [24.00 Hz (CINEMA)] 4096×2160/24.00p [100 Mbps (IPB)], 3840×2160/24.00p [100 Mbps (IPB)], 1920×1080/24.00p [200 Mbps (ALL-Intra)], 1920×1080/24.00p [100 Mbps (IPB)], 1920×1080/24.00p [50 Mbps (IPB)]</p>

Quality	RAW/RAW+Fine/RAW+Standard/Fine/Standard/MPO+Fine/MPO+Standard	
Recording file format		
Still Picture	RAW/JPEG (based on "Design rule for Camera File system", based on "Exif 2.3" standard, DPOF corresponding)/MPO	
Motion pictures	AVCHD Progressive/AVCHD/MP4/MOV	
Audio compression	AVCHD	Dolby® Digital (2 ch)
	MP4	AAC (2 ch)
	MP4 (LPCM), MOV	LPCM (2 ch)
Interface		
Digital	"USB 2.0" (High Speed)	
Analog video/audio	NTSC/PAL Composite (Switched by [System Frequency]) Audio line output (monaural)	
Terminal		
[REMOTE]	φ 2.5 mm jack	
[AV OUT/DIGITAL]	Dedicated jack (8 pin)	
[HDMI]	MicroHDMI Type D	
[MIC]	φ 3.5 mm jack	
Headphone	φ 3.5 mm jack	
Flash synchro	Available	

Dimensions	Approx. 132.9 mm (W)×93.4 mm (H)×83.9 mm (D) [5.23" (W)×3.68"(H)×3.30" (D)] (excluding the projecting parts)
Mass (weight)	Approx. 560 g/1.23 lb [with the card and battery] Approx. 480 g/1.06 lb (camera body) Approx. 865 g/1.91 lb [with the Interchangeable lens (H-HS12035), card and battery]
Operating temperature	0 °C to 40 °C (32 °F to 104 °F)
Operating humidity	10%RH to 80%RH
Dust-proof and splash-proof	Yes
Language select	[ENGLISH]/[ESPAÑOL] (DMC-GH4P) [ENGLISH]/[DEUTSCH]/[FRANÇAIS]/[ESPAÑOL]/ [PORTUGUÊS]/[ITALIANO]/[繁體中文]/[日本語] (DMC-GH4PC)

Wireless transmitter

Compliance standard	IEEE 802.11b/g/n (standard wireless LAN protocol)
Frequency range used (central frequency)	2412 MHz to 2462 MHz (1 to 11ch)
Encryption method	Wi-Fi compliant WPA™/WPA2™
Access method	Infrastructure mode

NFC

Compliance standard	ISO/IEC 18092 NFC-F (Passive Mode)
----------------------------	------------------------------------

Battery Charger (Panasonic DMW-BTC10PP):

Information for your safety

Input: \sim 110 V to 240 V, 50/60 Hz, 0.2 A

Output: \equiv 8.4 V, 0.65 A

Battery Pack (lithium-ion) (Panasonic DMW-BLF19PP):

Information for your safety

Voltage/capacity: 7.2 V/1860 mAh

Digital Camera Accessory System

Description	Accessory#
Battery Pack	DMW-BLF19
Battery Charger	DMW-BTC10
AC Adaptor* ¹	DMW-AC10
DC Coupler* ¹	DMW-DCC12
LED Video Light	VW-LED1
Flash	DMW-FL360L, DMW-FL580L, DMW-FL500
Stereo Shotgun Microphone	DMW-MS2
Stereo Microphone	VW-VMS10
Remote Shutter	DMW-RSL1
Battery Grip	DMW-BGGH3
Interface Unit	DMW-YAGH (U.S.A. only)
Body Cap	DMW-BDC1
Tripod Adaptor* ²	DMW-TA1
USB connection Cable	DMW-USBC1
AV Cable	DMW-AVC1
Mount Adaptor	DMW-MA1, DMW-MA2M, DMW-MA3R

*1 The AC Adaptor (optional) can only be used with the designated Panasonic DC Coupler (optional). The AC adaptor (optional) cannot be used by itself.

*2 Use if the attached lens is in contact with the tripod pedestal.

Product numbers correct as of March 2014. These may be subject to change.

- Some optional accessories may not be available in some countries.
- NOTE: Accessories and/or model numbers may vary between countries. Consult your local dealer.
- For lens-related optional accessories such as compatible lenses and filters, refer to catalogs/ Web pages, etc.

Reading the Owner's Manual (PDF format)

- Please also refer to the “Owner's Manual for advanced features (PDF format)”, which describes more detailed information.

More detailed instructions on the operation of this camera are contained in “Owner's Manual for advanced features (PDF format)” in the supplied DVD. Install it on your PC to read it.

■ For Windows

- 1 Turn the PC on and insert the DVD containing the Owner's Manual (supplied).**
- 2 Click the [Owner's Manual].**
- 3 Select the desired language and then click [Owner's Manual] to install.**
 - (A) To return to the install menu.
- 4 Double click the “Owner's Manual” shortcut icon on the desktop.**

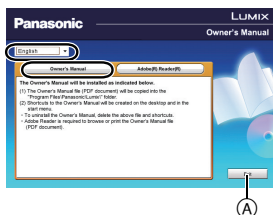

■ When the Owner's Manual (PDF format) will not open

You will need Adobe Acrobat Reader 5.0 or later or Adobe Reader 7.0 or later to browse or print the Owner's Manual (PDF format).

- You can download and install a version of Adobe Reader that you can use with your OS from the following Web Site.

<http://get.adobe.com/reader/otherversions>

■ To uninstall the Owner's Manual (PDF format)

Delete the PDF file from the “Program Files\Panasonic\Lumix\” folder.

■ For Mac

- 1 Turn the PC on and insert the DVD containing the Owner's Manual (supplied).**
- 2 Open the “Manual” folder in the DVD.**
 - “Manual” folder is displayed again.
- 3 Open the “Manual” folder in the DVD and then copy the PDF file with the desired language inside the folder.**
- 4 Double click the PDF file to open it.**

Digital Camera Accessory Order Form

(For USA Customers)

Please photocopy this form when placing an order.

1. Digital Camera Model # _____

2. Items Ordered

Accessory #	Description	Price Each	Quantity	Total Price
Shipping & Handling				\$6.95
Subtotal				
Your State & Local Sales Tax				
Total				

3. Method of payment (check one)

- American Express
 VISA Credit Card # _____
 MasterCard Expiration Date _____
 Discover Customer Signature _____

(Please do not send cash)

4. Shipping information (UPS delivery requires complete street address)

Ship To:

Mr.

Mrs.

Ms. _____

First Last

Phone#:

Day () _____

Street Address

Night () _____

City State Zip

TO OBTAIN ANY OF OUR DIGITAL CAMERA ACCESSORIES YOU CAN DO ANY OF THE FOLLOWING:

VISIT YOUR LOCAL PANASONIC DEALER

OR

YOU MAY CONTACT US DIRECTLY AT:

1-800-237-9080 (FAX ONLY)

OR

MAIL THIS ORDER TO: PANASONIC NATIONAL PARTS CENTER

20421 84th Avenue South, Kent, WA 98032

Limited Warranty (ONLY FOR U.S.A.)

Panasonic Products Limited Warranty

Limited Warranty Coverage (For USA Only)

If your product does not work properly because of a defect in materials or workmanship, Panasonic Corporation of North America (referred to as "the warrantor") will, for the length of the period indicated on the chart below, which starts with the date of original purchase ("warranty period"), at its option either (a) repair your product with new or refurbished parts, (b) replace it with a new or a refurbished equivalent value product, or (c) refund your purchase price. The decision to repair, replace or refund will be made by the warrantor.

Product or Part Name	Parts	Labor
Digital Camera (DMC-GH4)	1 Year	1 Year
All included Accessories (Except Non-Rechargeable Batteries)	90 Days	Not Applicable
Only Non-Rechargeable Batteries	10 Days	Not Applicable

During the "Labor" warranty period there will be no charge for labor. During the "Parts" warranty period, there will be no charge for parts. This Limited Warranty excludes both parts and labor for non-rechargeable batteries, antennas, and cosmetic parts (cabinet). This warranty only applies to products purchased and serviced in the United States. This warranty is extended only to the original purchaser of a new product which was not sold "as is".

Mail-In Service--Online Repair Request

Online Repair Request

To submit a new repair request and for quick repair status visit our Web Site at www.panasonic.com/repair.

When shipping the unit, carefully pack, include all supplied accessories listed in the Owner's Manual, and send it prepaid, adequately insured and packed well in a carton box. When shipping Lithium Ion batteries please visit our Web Site at www.panasonic.com/BatteryHandling as Panasonic is committed to providing the most up to date information. Include a letter detailing the complaint, a return address and provide a daytime phone number where you can be reached. A valid registered receipt is required under the Limited Warranty.

IF REPAIR IS NEEDED DURING THE WARRANTY PERIOD, THE PURCHASER WILL BE REQUIRED TO FURNISH A SALES RECEIPT/PROOF OF PURCHASE INDICATING DATE OF PURCHASE, AMOUNT PAID AND PLACE OF PURCHASE. CUSTOMER WILL BE CHARGED FOR THE REPAIR OF ANY UNIT RECEIVED WITHOUT SUCH PROOF OF PURCHASE.

Limited Warranty Limits And Exclusions

This warranty ONLY COVERS failures due to defects in materials or workmanship, and DOES NOT COVER normal wear and tear or cosmetic damage. The warranty ALSO DOES NOT COVER damages which occurred in shipment, or failures which are caused by products not supplied by the warrantor, or failures which result from accidents, misuse, abuse, neglect, mishandling, misapplication, alteration, faulty installation, set-up adjustments, misadjustment of consumer controls, improper maintenance, power line surge, lightning damage, modification, firmware modification, introduction of sand, humidity or liquids, or service by anyone other than a Factory Service Center or other Authorized Servicer, or damage that is attributable to acts of God.

ALL EXPRESS AND IMPLIED WARRANTIES, INCLUDING THE WARRANTY OF MERCHANTABILITY, ARE LIMITED TO THE PERIOD OF THE LIMITED WARRANTY. WARRANTOR'S LIABILITY UNDER THIS LIMITED WARRANTY SHALL BE LIMITED SOLELY TO THE COST OF ANY NECESSARY REPAIRS OR REPLACEMENTS OF THIS PRODUCT. PANASONIC ASSUMES NO RISK, AND SHALL NOT IN ANY CASE BE LIABLE FOR ANY SPECIAL, INCIDENTAL OR CONSEQUENTIAL DAMAGES, OR ANY OTHER INDIRECT DAMAGES, ARISING FROM BREACH OF WARRANTY OR CONTRACT, NEGLIGENCE, OR ANY OTHER LEGAL THEORY, INCLUDING, WITHOUT LIMITATION, LOSS OF GOOD WILL PROFITS OR REVENUE, COST OF CAPITAL, COST OF ANY SUBSTITUTE EQUIPMENT, FACILITIES OR SERVICES OR DOWNTIME COSTS, OR CLAIMS OF ANY PART DEALING WITH PURCHASER FOR SUCH DAMAGES.

Some states do not allow the exclusion or limitation of incidental or consequential damages, or limitations on how long an implied warranty lasts, so the exclusions may not apply to you. This warranty gives you specific legal rights and you may also have other rights which vary from state to state. If a problem with this product develops during or after the warranty period, you may contact your dealer or Service Center. If the problem is not handled to your satisfaction, then write to the warrantor's Consumer Affairs Department at the addresses listed for the warrantor.

PARTS AND SERVICE, WHICH ARE NOT COVERED BY THIS LIMITED WARRANTY, ARE YOUR RESPONSIBILITY.

Customer Services Directory (United States)

Obtain Product Information and Operating Assistance; locate your nearest Dealer or Service Center; purchase Parts and Accessories; or make Customer Service and Literature requests by visiting our Web Site at:

<http://www.panasonic.com/support>

or, contact us via the web at:

<http://www.panasonic.com/contactinfo>

For hearing or speech impaired TTY users, TTY: 1-877-833-8855

Accessory Purchases (United States)

Purchase Parts, Accessories and Owner's Manual online for all Panasonic Products by visiting our Web Site at:

<http://www.pstc.panasonic.com>

Or, send your request by E-mail to:

npcparts@us.panasonic.com

You may also contact us directly at:

1-800-237-9080 (Fax Only)

(Monday-Friday 9am-9pm EST)

Panasonic National Parts Center

20421 84th Avenue South, Kent, WA 98032

(We accept Visa, MasterCard, Discover Card, American Express)

For hearing or speech impaired TTY users, TTY: 1-866-605-1277

As of April 2014

Limited Warranty (ONLY FOR CANADA)

Panasonic Canada Inc.

5770 Ambler Drive, Mississauga, Ontario L4W 2T3

PANASONIC PRODUCT – LIMITED WARRANTY

Panasonic Canada Inc. warrants this product to be free from defects in material and workmanship under normal use and for a period as stated below from the date of original purchase agrees to, at its option either (a) repair your product with new or refurbished parts, (b) replace it with a new or a refurbished equivalent value product, or (c) refund your purchase price. The decision to repair, replace or refund will be made by Panasonic Canada Inc.

Digital Camera	One (1) year, parts and labour
Digital Camera Peripherals	One (1) year, parts and labour
Digital Camera Accessories	Ninety (90) days, parts and labour

This warranty is given only to the original purchaser, or the person for whom it was purchased as a gift, of a Panasonic brand product mentioned above sold by an authorized Panasonic dealer in Canada and purchased and used in Canada, which product was not sold "as is", and which product was delivered to you in new condition in the original packaging.

IN ORDER TO BE ELIGIBLE TO RECEIVE WARRANTY SERVICE HEREUNDER, A PURCHASE RECEIPT OR OTHER PROOF OF DATE OF ORIGINAL PURCHASE, SHOWING AMOUNT PAID AND PLACE OF PURCHASE IS REQUIRED

LIMITATIONS AND EXCLUSIONS

This warranty ONLY COVERS failures due to defects in materials or workmanship, and DOES NOT COVER normal wear and tear or cosmetic damage. The warranty ALSO DOES NOT COVER damages which occurred in shipment, or failures which are caused by products not supplied by Panasonic Canada Inc., or failures which result from accidents, misuse, abuse, neglect, mishandling, misapplication, alteration, faulty installation, set-up adjustments, misadjustment of consumer controls, improper maintenance, improper batteries, power line surge, lightning damage, modification, introduction of sand, humidity or liquids, commercial use such as hotel, office, restaurant, or other business or rental use of the product, or service by anyone other than a Authorized Servicer, or damage that is attributable to acts of God.

Dry cell batteries, printer ink cartridge and paper are also excluded from coverage under this warranty.

Rechargeable batteries are warranted for ninety (90) days from date of original purchase.

THIS EXPRESS, LIMITED WARRANTY IS IN LIEU OF ALL OTHER WARRANTIES, EXPRESS OR IMPLIED, INCLUDING ANY IMPLIED WARRANTIES OF MERCHANTABILITY AND FITNESS FOR A PARTICULAR PURPOSE. IN NO EVENT WILL PANASONIC CANADA INC. BE LIABLE FOR ANY SPECIAL, INDIRECT OR CONSEQUENTIAL DAMAGES RESULTING FROM THE USE OF THIS PRODUCT OR ARISING OUT OF ANY BREACH OF ANY EXPRESS OR IMPLIED WARRANTY. (As examples, this warranty excludes damages for lost time, travel to and from the Authorized Servicer, loss of or damage to media or images, data or other memory or recorded content. This list of items is not exhaustive, but for illustration only.)

In certain instances, some jurisdictions do not allow the exclusion or limitation of incidental or consequential damages, or the exclusion of implied warranties, so the above limitations and exclusions may not be applicable. This warranty gives you specific legal rights and you may have other rights which vary depending on your province or territory.

WARRANTY SERVICE

For product operation, repairs and information assistance, please visit our Support page:

www.panasonic.ca/english/support

This product incorporates the following software:

- (1) the software developed independently by or for Panasonic Corporation,
- (2) the software owned by third party and licensed to Panasonic Corporation, and/or
- (3) open source software

The software categorized as (3) is distributed in the hope that it will be useful, but WITHOUT ANY WARRANTY, without even the implied warranty of MERCHANTABILITY or FITNESS FOR A PARTICULAR PURPOSE.

Please refer to the detailed terms and conditions thereof displayed by selecting [MENU/SET] → [Setup] → [Version Disp.] → [Software info].

- G MICRO SYSTEM is a lens exchange type digital camera system of LUMIX based on a Micro Four Thirds System standard.
- Micro Four Thirds™ and Micro Four Thirds Logo marks are trademarks or registered trademarks of Olympus Imaging Corporation, in Japan, the United States, the European Union and other countries.
- Four Thirds™ and Four Thirds Logo marks are trademarks or registered trademarks of Olympus Imaging Corporation, in Japan, the United States, the European Union and other countries.
- SDXC Logo is a trademark of SD-3C, LLC.
- “AVCHD”, “AVCHD Progressive” and the “AVCHD Progressive” logo are trademarks of Panasonic Corporation and Sony Corporation.
- Manufactured under license from Dolby Laboratories. Dolby and the double-D symbol are trademarks of Dolby Laboratories.
- HDMI, the HDMI Logo, and High-Definition Multimedia Interface are trademarks or registered trademarks of HDMI Licensing LLC in the United States and other countries.
- HDAVI Control™ is a trademark of Panasonic Corporation.
- Adobe is a trademark or registered trademark of Adobe Systems Incorporated in the United States and/or other countries.
- iMovie, Mac and Mac OS are trademarks of Apple Inc., registered in the U.S. and other countries.
- iPad, iPhone, iPod, and iPod touch are trademarks of Apple Inc., registered in the U.S. and other countries.
- App Store is a service mark of Apple Inc.



- QuickTime and the QuickTime logo are trademarks or registered trademarks of Apple Inc., used under license therefrom.
- Windows and Windows Vista are either registered trademarks or trademarks of Microsoft Corporation in the United States and/or other countries.
- Android and Google Play are trademarks or registered trademarks of Google Inc.
- The Wi-Fi CERTIFIED Logo is a certification mark of the Wi-Fi Alliance.
- The Wi-Fi Protected Setup Mark is a mark of the Wi-Fi Alliance.
- “Wi-Fi”, “Wi-Fi Protected Setup”, “Wi-Fi Direct”, “WPA” and “WPA2” are marks or registered marks of the Wi-Fi Alliance.
- DLNA, the DLNA Logo and DLNA CERTIFIED are trademarks, service marks, or certification marks of the Digital Living Network Alliance.
- This product uses “DynaFont” from DynaComware Corporation. DynaFont is a registered trademark of DynaComware Taiwan Inc.
- QR Code is a registered trademark of DENSO WAVE INCORPORATED.
- Other names of systems and products mentioned in these instructions are usually the registered trademarks or trademarks of the manufacturers who developed the system or product concerned.



This product is licensed under the AVC patent portfolio license for the personal and non-commercial use of a consumer to (i) encode video in compliance with the AVC Standard (“AVC Video”) and/or (ii) decode AVC Video that was encoded by a consumer engaged in a personal and non-commercial activity and/or was obtained from a video provider licensed to provide AVC Video. No license is granted or shall be implied for any other use. Additional information may be obtained from MPEG LA, LLC. See <http://www.mpegla.com> .

Panasonic Corporation of North America
Two Riverfront Plaza, Newark, NJ 07102-5490

Panasonic Canada Inc.
5770 Ambler Drive, Mississauga, Ontario L4W 2T3

© Panasonic Corporation 2014

Printed in China